 <p>ENAC E N S A Y O S Nº 51/LE147</p>	<p>Test report No: NIE: 59509RAN.002A1</p>
<h2 style="background-color: #008000; color: white; padding: 5px;">Test report IEEE Std 1528™-2013</h2>	
<p>Identification of item tested</p>	<p>Telematic Control Unit for giving to the user information of the bike and control de bike</p>
<p>Trademark</p>	<p>Advanced Automotive Antennas, S.L.</p>
<p>Model and /or type reference</p>	<p>HD MY20 NA</p>
<p>Other identification of the product</p>	<p>FCC ID: NKRUMC-9628FHN IC: 4441A-UMC9628FHN</p>
<p>Features</p>	<p>Telephony (GSM, WCDMA, LTE), GNSS (GPS, GLONASS)</p>
<p>Manufacturer</p>	<p>Advanced Automotive Antennas, S.L. Gran Via De Carles III 98 Planta 5. 08028, Barcelona</p>
<p>Test method requested, standard</p>	<ol style="list-style-type: none"> <li>1. IEEE Std 1528™-2013: Recommended Practice for Determining the Peak Spatial-Average Specific Absorption Rate (SAR) in the Human Head from Wireless Communications Devices: Measurement Techniques.</li> <li>2. FCC 47 CFR Part 2.1093. (10-1-15 Edition) Radiofrequency radiation exposure evaluation: portable devices.</li> <li>3. ISED RSS-102 Issue 5 (2015-03) – Radio Frequency Exposure Compliance of Radiocommunication Apparatus (All Frequency Bands)</li> </ol>
<p>Summary</p>	<p>Considering the results of the performed test according to IEEE Std 1528™-2013, the item under test is IN COMPLIANCE with FCC 47CFR Part 2.1093 and IC RSS-102 Issue 5 exposure limits.</p> <p>The maximum 1-g SAR found during this test into the body exposure condition has been 1.441 W/kg, for GPRS 850 MHz, 4 slots mode.</p> <p>NOTE: The results presented in this Test Report apply only to the particular item under test established in page 6 of this document, as presented for test on the date(s) shown in section, “USAGE OF SAMPLES, TESTING PERIOD AND ENVIRONMENTAL CONDITIONS”.</p>

Approved by (name / position & signature)	Miguel Lacave Antennas Lab Manager
Date of issue	2019-05-09
Report template No	FDT08_21

## Index

Competences and guarantees .....	4
General conditions .....	4
Uncertainty .....	4
Data provided by the client.....	4
Instrumentation .....	5
Usage of samples .....	6
Test sample description .....	6
Identification of the client.....	6
Testing period and place.....	6
Document history .....	7
Environmental conditions .....	7
References .....	7
Remarks and comments .....	7
Testing verdicts.....	8
Appendix A: Test configuration .....	9
Appendix B: Test results .....	19
Appendix C: Measurement Reports .....	52
Appendix D: System Validation Reports.....	62
Appendix E: Calibration data.....	68
Appendix F: Photographs.....	145

## Competences and guarantees

---

DEKRA Testing and Certification is a testing laboratory accredited by the National Accreditation Body (ENAC - Entidad Nacional de Acreditación), to perform the tests indicated in the Certificate No. 51/LE 147.

In order to assure the traceability to other national and international laboratories, DEKRA Testing and Certification has a calibration and maintenance program for its measurement equipment.

DEKRA Testing and Certification guarantees the reliability of the data presented in this report, which is the result of the measurements and the tests performed to the item under test on the date and under the conditions stated on the report and, it is based on the knowledge and technical facilities available at DEKRA Testing and Certification at the time of performance of the test.

DEKRA Testing and Certification is liable to the client for the maintenance of the confidentiality of all information related to the item under test and the results of the test.

The results presented in this Test Report apply only to the particular item under test established in this document.

**IMPORTANT:** No parts of this report may be reproduced or quoted out of context, in any form or by any means, except in full, without the previous written permission of DEKRA Testing and Certification.

## General conditions

---

1. This report is only referred to the item that has undergone the test.
2. This report does not constitute or imply on its own an approval of the product by the Certification Bodies or competent Authorities.
3. This document is only valid if complete; no partial reproduction can be made without previous written permission of DEKRA Testing and Certification.
4. This test report cannot be used partially or in full for publicity and/or promotional purposes without previous written permission of DEKRA Testing and Certification and the Accreditation Bodies.

## Uncertainty

---

Uncertainty (factor  $k=2$ ) was calculated according to the following documents:

1. FCC OET KDB 865664 D01 - SAR Measurement Requirements for 100 MHz to 6 GHz v01r04 (August 2015).

## Data provided by the client

---

DEKRA declines any responsibility with respect to the information provided by the client and that may affect the validity of results.

## Instrumentation

The instrumentation utilized to perform the tests covered in this test report is listed in the following table.

Equipment	S/N
Dosimetric E-field probe SPEAG EX3DV4	7461
Data acquisition device SPEAG DAE4	669
Electro-optical converter SPEAG EOC3	391
Robot Stäubli RX60BL, Robot controller Stäubli CS7MB	F04/SOP5A1/A/01
Measurement server SPEAG DASY5 SE UMS 011 BS	1227
SAM head-body simulator TWIN SAM V4.0	-
SAR measurement software SPEAG DASY52 V52.8.8.1222	-
SAR postprocessing software SPEAG SEMCAD X	-
750 MHz dipole validation kit SPEAG D750V3	1036
900 MHz dipole validation kit SPEAG D900V2	1D007
1800 MHz dipole validation kit SPEAG D1800V2	2D099
2600 MHz dipole validation kit SPEAG D2600V2	1023
Head Tissue Equivalent Liquid for 750MHz, 850 MHz, 1700 MHz, 1900 MHz and 2600 MHz bands	-
Universal Radio Communication Tester R&S CMW 500	1201.0002K50-113616-jG
Vector network analyzer Agilent FieldFox N9923A	US49470126
Dielectric probe kit SPEAG DAK-3.5	1080
Power meter Agilent E4419B	MY45103349
RF Generator R&S SMU200	102234
DC Power supply Agilent U8002A	MY53500016
Dual directional coupler HP 778D	15821
Power amplifier MITEQ AMF-4D-00400600-50-30P	1456425
6 dB attenuator Weinschel 75 A-6-11	902
SPEAG Mounting Device for Hand-held devices.	-
Power sensor DC 50 MHz to 18 GHz R&S model NRP-Z81	100527
Digital thermometer LKM Electronics model DTM300-Spezial	2989
Temperature and humidity probe HUMIDIPROBE Pico Technology	UAL02/077

## Usage of samples

Samples undergoing test have been selected by: the client

Sample M/01 is composed of the following elements:

Control Nº	Description	Model	Serial Nº	Date of reception
59334/22	SMA conducted	HD MY20 NA	201904204962	25-03-2019

Sample M/02 is composed of the following elements:

Control Nº	Description	Model	Serial Nº	Date of reception
59334/16	Radiated	HD MY20 NA	201905200182	25-03-2019

1. Sample M/01 has undergone the test(s) specified in subclause "Test method requested": Conducted average output power.
2. Sample M/02 has undergone the test(s) specified in subclause "Test method requested": SAR evaluation for 2G, 3G and LTE.

## Test sample description

Description of product .....	Telematic Control Unit		
Software version.....	MY20.9		
Hardware version .....	41000644		
Mounting position .....	<input type="checkbox"/>	Table top equipment	
	<input type="checkbox"/>	Wall/Ceiling mounted equipment	
	<input type="checkbox"/>	Floor standing equipment	
	<input type="checkbox"/>	Hand-held equipment	
	<input checked="" type="checkbox"/>	Other: Fixed device	
Accessories (not part of the test item).....	Description	Type	Manufacturer
	Charging adapter	---	
	USB cable	---	

## Identification of the client

Advanced Automotive Antennas, S.L.  
 Gran Via De Carles III 98 Planta 5 08028, Barcelona

## Testing period and place

Test Location	DEKRA Testing and Certification S.A.U.
Date (start)	2019-03-27
Date (finish)	2019-04-24

## Document history

Report number	Date	Description
59334RAN.002	2019-05-07	First release.
59509RAN.002A1	2019-05-09	IC identification information has been included in the cover of the report. This modification test report cancels and replaces the test report 59334RAN.002.

## Environmental conditions

Date	Max. Temp. °C	Min. Temp. °C	Max. Hum. %	Min. Hum. %	Limit
From 2019-03-27 to 2019-04-24	24.32	20.88	58.25	34.39	18-25 °C, 30-70%

## References

The tests documented in this report were performed in accordance with FCC 47 CFR § 2.1093, IC RSS-102 Issue 5 (2015-03) – Radio Frequency Exposure Compliance of Radiocommunication Apparatus (All Frequency Bands) and the following FCC Published RF exposure KDB procedures:

1. FCC OET KDB 447498 D01 General RF Exposure Guidance v06 (October 2015)
2. FCC OET KDB 865664 D01 SAR Measurement Requirements for 100 MHz to 6 GHz v01r04 (August 2015).
3. FCC OET KDB 865664 D02 RF Exposure Reporting v01r02 (October 2015)
4. FCC OET KDB 941225 D01 3G SAR Procedures v03r01 (October 2015).
5. FCC OET KDB 941225 D05 SAR for LTE Devices v02r05 (October 2015).

## Remarks and comments

- 1: Zoom scan is not required according to FCC OET KDB 447498 D01 General RF Exposure Guidance v06, paragraph “4.4.2. Area scan based 1-g estimation”.
- 2: SAR for left position has not been measured due to SAR testing reduction because this position is the position with the largest distance between antenna and edge.
- 3: Only the plots of the highest reported SAR for each test position and mode/band are included in appendix C.

## Testing verdicts

---

Not applicable :	N/A
Pass :	P
Fail :	F
Not measured :	N/M

FCC 47CFR Part 2.1093 & ISED RSS-102 Issue 5	VERDICT			
	N/A	P	F	NM
GSM 850		P		
GSM 1900		P		
WCDMA II		P		
WCDMA V		P		
LTE 2		P		
LTE 4		P		
LTE 5		P		
LTE 7		P		
LTE 12		P		
LTE 17		P		



## Appendix A: Test configuration

## INDEX

1.	GENERAL INTRODUCTION .....	11
1.1.	Application Standard.....	11
1.2.	General requirements .....	11
1.3.	Measurement system requirements .....	11
1.4.	Phantom requirements.....	11
1.5.	Measurement Liquids requirements. ....	11
2.	MEASUREMENT SYSTEM .....	12
2.1.	Measurement System .....	12
2.2.	Test Positions of device relative to body .....	15
2.3.	Test to be performed.....	15
2.4.	Description of interpolation/extrapolation scheme .....	15
2.5.	Determination of the largest peak spatial-average SAR .....	15
2.6.	System Validation .....	15
3.	UNCERTAINTY .....	16
4.	SAR LIMIT .....	17
5.	DEVICE UNDER TEST.....	17
5.1.	Dimensions .....	17
5.2.	Wireless Technology.....	17
5.3.	Simultaneous Transmission .....	17
5.4.	Antenna Location .....	18

## 1. GENERAL INTRODUCTION

### 1.1. Application Standard

The Federal Communications Commission (FCC) sets the limits for General Population/Uncontrolled exposure to radio frequency electromagnetic fields for transmitting devices designed to be used within 20 centimetres of the body of the user under FCC 47 CFR Part 2.1093 - "Radiofrequency radiation exposure evaluation: portable devices", paragraph (d)(2).

Industry of Canada (ISED) sets the limits for General Population/Uncontrolled environment when the exposure occurs at a distance of 0.2 m or less into the RSS-102 Issue 5, paragraph 4 "Exposure Limits", Table 3.

### 1.2. General requirements

The SAR measurement has been performed continuing the following considerations and environment conditions:

- The ambient temperature shall be in the range of 18°C to 25°C and the variation shall not exceed +/- 2°C during the test.
- The ambient humidity shall be in the range of and 30% - 70%.
- The device battery shall be fully charged before each measurement.

### 1.3. Measurement system requirements

The measurement system used for SAR tests fulfils the procedural and technical requirements described at the reference standards used.

### 1.4. Phantom requirements

The phantom model for body measurements is an elliptical open-top container with a flat bottom, with the following shape and dimensions:

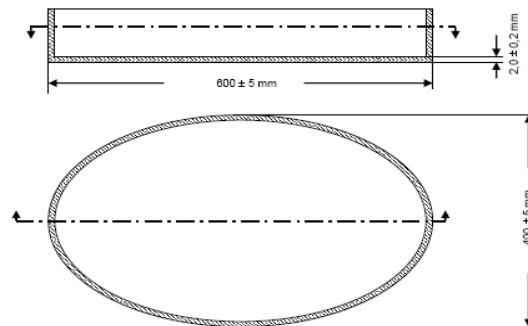

Figure 1: Proportions and shape of Phantom shell

### 1.5. Measurement Liquids requirements.

The liquids used to simulate the human tissues, must fulfils the requirements of the dielectric properties required. These target dielectric properties per FCC OET KDB 865664 D01 instructions come from the dipole and probe calibration data which are included in Appendix B, Section 3, of this document.

To minimize the effect of reflections on peak spatial-average SAR values, from the upper surface of the tissue-equivalent liquid, the depth of the liquid should be at least 15 cm.

## 2. MEASUREMENT SYSTEM

### 2.1. Measurement System

The DASY5 system for performing compliance tests consists of the following items:

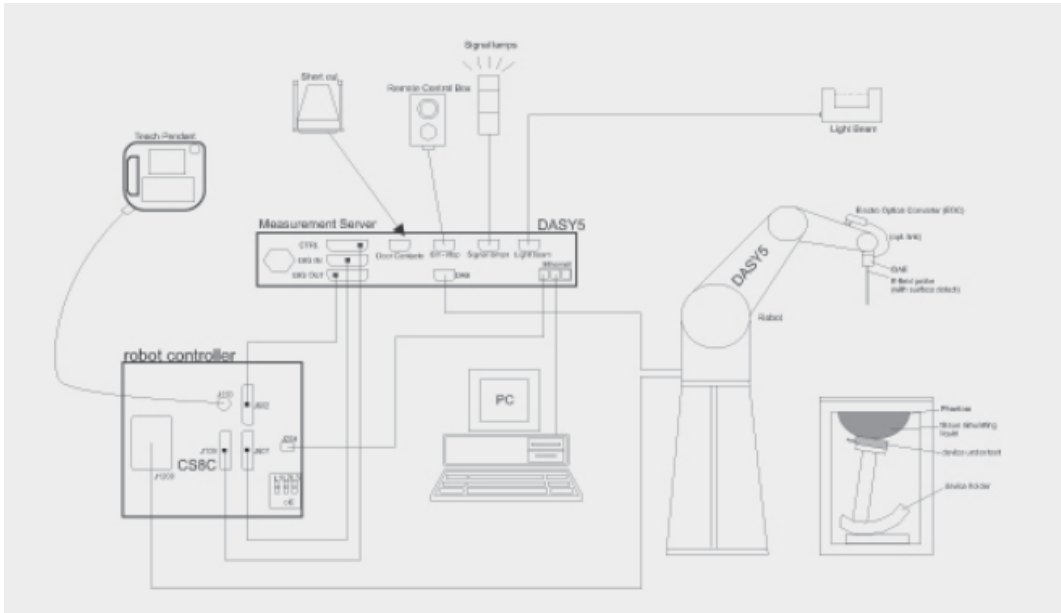

**Figure 2:** SAR Measurement system

A standard high precision 6-axis robot (Stäubli TX=RX family) with controller, teach pendant and software. An arm extension for accommodating the data acquisition electronics (DAE).

An isotropic field probe optimized and calibrated for the targeted measurement.

A data acquisition electronics (DAE) which performs the signal amplification, signal multiplexing, AD-conversion, offset measurements, mechanical surface detection, collision detection, etc. The unit is battery powered with standard or rechargeable batteries. The signal is optically transmitted to the EOC.

The Electro-optical converter (EOC) performs the conversion from optical to electrical signals for the digital communication to the DAE. To use optical surface detection, a special version of the EOC is required. The EOC signal is transmitted to the measurement server.

The function of the measurement server is to perform the time critical tasks such as signal filtering, control of the robot operation and fast movement interrupts.

The Light Beam used is for probe alignment. This improves the (absolute) accuracy of the probe positioning.

A computer running Win7 professional operating system and the DASY5 software.

Remote control and teach pendant as well as additional circuitry for robot safety such as warning lamps, etc.

The phantom, the device holder and other accessories according to the targeted measurement.

	<b>Model</b>	<b>EX3DV4</b>
	<b>Construction</b>	Symmetrical design with triangular core. Built-in shielding against static charges. PEEK enclosure material (resistant to organic solvents, e.g., DGBE).
	<b>Frequency</b>	10 MHz to > 6 GHz; Linearity: ± 0.2 dB (30 MHz to 6 GHz)
	<b>Directivity</b>	± 0.3 dB in TSL (rotation around probe axis) ± 0.5 dB in TSL (rotation normal to probe axis)
	<b>Dynamic Range</b>	10 µW/g to > 100 mW/g Linearity: ± 0.2 dB (noise: typically < 1 µW/g)
	<b>Dimensions</b>	Overall length: 337 mm (Tip: 20 mm) Tip diameter: 2.5 mm (Body: 12 mm) Typical distance from probe tip to dipole centers: 1.0 mm

	<b>Model</b>	<b>DAE4</b>
	<b>Construction</b>	Signal amplifier, multiplexer, A/D converter, and control logic. Serial optical link communication with DASY4/5 embedded system (fully remote controlled). Two-step probe touch detector for mechanical surface detection and emergency robot stop.
	<b>Measurement Range</b>	-100 to +300 mV (16 bit resolution and two range settings: 4mV, 400mV)
	<b>Input Offset Voltage</b>	< 5 µV (with auto zero)
	<b>Input Resistance</b>	200 MOhm
	<b>Input Bias Current</b>	< 50 fA

	<b>Model</b>	<b>ELI</b>
	<b>Construction</b>	Phantom for compliance testing of handheld and body-mounted wireless devices in the frequency range of 30 MHz to 6 GHz. ELI is fully compatible with the IEC 62209-2 standard and all known tissue simulating liquids. ELI has been optimized regarding its performance and can be integrated into our standard phantom tables. A cover prevents evaporation of the liquid. Reference markings on the phantom allow installation of the complete setup, including all predefined phantom positions and measurement grids, by teaching three points. The phantom is compatible with all SPEAG dosimetric probes and dipoles.
	<b>Material</b>	Vinylester, glass fiber reinforced (VE-GF)
	<b>Liquid Compatibility</b>	Compatible with all SPEAG tissue simulating liquids (incl. DGBE type)
	<b>Shell Thickness</b>	2 ± 0.2 mm (bottom plate)
	<b>Dimensions</b>	Major axis: 600 mm Minor axis: 400 mm
	<b>Filling Volume</b>	Approx. 30 liters
	<b>Wooden Support</b>	SPEAG standard phantom table

	<b>Model</b>	<b>Mounting Device for Hand-Held Transmitters</b>
	<b>Construction</b>	In combination with the Twin SAM V5.0/V5.0c or ELI Phantoms, the Mounting Device for Hand-Held Transmitters enables rotation of the mounted transmitter device to specified spherical coordinates. At the heads, the rotation axis is at the ear opening. Transmitter devices can be easily and accurately positioned according to IEC 62209-1, IEEE 1528, FCC, or other specifications. The device holder can be locked for positioning at different phantom sections (left head, right head, flat).
	<b>Material</b>	Polyoxymethylene (POM)

	<b>Model</b>	<b>System Validations Kits 450 MHz – 6 GHz</b>		
	<b>Construction</b>	Symmetrical dipole with 1/4 balun. Enables measurement of feedpoint impedance with NWA. Matched for use near flat phantoms filled with tissue simulating solutions.		
	<b>Frequency</b>	450 MHz to 5800 MHz		
	<b>Return Loss</b>	20 dB at specified validation position		
	<b>Dimensions (length and overall height in mm)</b>	<b>Product</b>	<b>Dipole length</b>	<b>Overall height</b>
		D450V3	290.0	330.0
	D750V3	179.0	330.0	
	D900V2	148.5	340.0	
	D1800V2	72.5	300.0	
	D2000V2	65.0	300.0	
	D2450V2	52.0	290.0	
	D2600V2	49.2	290.0	
	D5GHzV2	20.6	300.0	

## 2.2. Test Positions of device relative to body

The device under test consists of Telematic Control Unit, which will be installed on a motorbike. According to the manufacturer, once installed, the minimum installation distance for the hand and the torso of the user will be 95.52 mm and 191.41 mm respectively. According to the manufacturer request, SAR measurements have been performed at a conservative 35 mm test separation distance.

SAR testing have been performed for all faces and edges of the device except for left edge position, due to the highest antenna-edge distance for this position and the low SAR results found for the rest of the measured test positions.

## 2.3. Test to be performed

Test shall be performed at the device position previously described, using the centre frequency of each operating band.

Additionally, the configuration giving to the maximum mass averaged SAR shall be used to test the low-end and the high-end frequencies of each transmitting band. Thus, the tests to be performed are as follows:

- Measurements at Central Channel of application band: SAR measurement with back face of the DUT against the phantom.
- Measurements at Low Channel of application band: SAR measurement at the side and position where the maximum SAR level, measured at Central channel, was found.
- Measurements at High Channel of application band: SAR measurement at the side and position where the maximum SAR level, measured at Central channel, was found.

## 2.4. Description of interpolation/extrapolation scheme

The local SAR inside the Phantom is measured using small dipole sensing elements inside a probe element. The probe tip must not be in contact with the Phantoms surface in order to minimise measurement errors, but the highest local SAR is obtained from measurements at a certain distances from the shell trough extrapolation. The accurate assessment of the maximum SAR averaged over 1 gr and 10 gr. requires a very fine resolution in the three dimensional scanned data array. Since the measurements have to be performed over a limited time, the measured data have to be interpolated to provide an array of sufficient resolution.

The interpolation of 2D area scan is used after the initial area scan, at a fixed distance from the Phantom shell wall. The initial scan data is collected with approx. 15 mm spatial resolution and this interpolation is used to find the location of the local maximum for positioning the subsequent 3D scanning within a 1 mm resolution.

For the 3D scan, data is collected on a spatially regular 3D grid having 5 mm steps in both directions. After the data collection by the SAR probe, the data are extrapolated in the depth direction to assign values to points in the 3D array closer to the shell wall. A notional extrapolation value is also assigned to the first point outside the shell wall so that subsequent interpolation schemes will be applicable right up to the shell wall boundary.

## 2.5. Determination of the largest peak spatial-average SAR

To determine the maximum value of the peak spatial-average SAR of a DUT, all device positions, configurations and operational modes should be tested for each frequency band.

The averaging volume shall be chosen as 1gr. of contiguous tissue. The cubic volumes, over which the SAR measurements are averaged after extrapolation and interpolation, are chosen in order to include the highest values of local SAR.

The maximum SAR level for the DUT will be the maximum level obtained of the performed measurements, and indicated in the previous points.

## 2.6. System Validation

Prior to the SAR measurements, system verification is done to verify the system accuracy. A complete SAR evaluation is done using a half-wavelength dipole as source with the frequency of the mid-band channel of the operating band, or within 10% of this channel.

The measured 1 gr. and 10 gr. SAR should be within 10% of the expected target values specified in the calibration certificate of the dipole, for the specific tissue and frequency used.

### 3. UNCERTAINTY

According to FCC OET KDB 865664 D01 - SAR Measurement Requirements for 100 MHz to 6 GHz v01r04 (August 2015), as the highest measured 1-g SAR has been < 1.5 W/kg, SAR measurement uncertainty analysis described in IEEE Std 1528-2013 is not required in the actual SAR report, but it has been included for ISO 17025 accreditation.

#### Uncertainty for 300 MHz – 6 GHz

ERROR SOURCES	Uncertainty value (± %)	Probability distribution	Divisor	(c <sub>i</sub> ) 1g	(c <sub>i</sub> ) 10g	Standard uncertainty (1g) (± %)	Standard uncertainty (10g) (± %)
<b>Measurement Equipment</b>							
Probe Calibration	6.550	N	1	1	1	6.550	6.550
Axial Isotropy	4.700	R	√3	0.7	0.7	1.899	1.899
Hemisfericall Isotropy	9.600	R	√3	0.7	0.7	3.880	3.880
Boundary effect	2.000	R	√3	1	1	1.155	1.155
Linearity	4.700	R	√3	1	1	2.714	2.714
System Detection limits	1.000	R	√3	1	1	0.577	0.577
Probe modulation response	6.100	R	√3	1	1	3.522	3.522
Readout electronics	0.300	N	1	1	1	0.300	0.300
Response time	0.800	R	√3	1	1	0.462	0.462
Integration time	2.600	R	√3	1	1	1.501	1.501
RF Ambient noise	3.000	R	√3	1	1	1.732	1.732
RF Ambient reflections	3.000	R	√3	1	1	1.732	1.732
Probe positioner mech. restrictions	0.800	R	√3	1	1	0.462	0.462
Probe positioning with respect to phantom shell	6.700	R	√3	1	1	3.868	3.868
Max. SAR Eval.	4.000	R	√3	1	1	2.309	2.309
<b>Test Sample Related</b>							
Device holder uncertainty	2.900	N	1	1	1	2.900	2.900
Test sample positioning	3.600	N	1	1	1	3.600	3.600
Drift of output power	5.000	R	√3	1	1	2.887	2.887
<b>Phantom and Setup</b>							
Phantom uncertainty (shape and thickness tolerances)	6.600	R	√3	1	1	3.811	3.811
Algorithm for correcting SAR for deviations in permittivity and conductivity	1.900	R	√3	1	0.84	1.097	0.921
Liquid conductivity (meas.)	2.454	N	1	0.78	0.71	1.914	1.742
Liquid permittivity (meas.)	2.454	N	1	0.26	0.26	0.638	0.638
Liquid conductivity – temperature uncertainty	3.400	R	√3	0.78	0.71	1.531	1.394
Liquid permittivity – temperature uncertainty	0.400	R	√3	0.23	0.26	0.053	0.060
<b>Combined standard uncertainty</b>	$u_c = \sqrt{\sum_{i=1}^m c_i^2 \cdot u_i^2}$					<b>12.82</b>	<b>12.76</b>
<b>Expanded uncertainty (confidence interval of 95%)</b>	$u_e = 2.00 u_c$					<b>25.64</b>	<b>25.53</b>

Table 1: Uncertainty Assessment for 300 MHz - 6 GHz



## 4. SAR LIMIT

Having a worst case measurement, the SAR limit is valid for general population/uncontrolled exposure.

The SAR values have to be averaged over a mass of 1 gr. (SAR 1 gr.) with the shape of a cube and averaged over a mass of 10 gr (Extremity SAR 10 gr). These levels couldn't exceed the values indicated in the application Standard:

Standard	Exposure	SAR	SAR Limit (W/kg)
FCC 47 CFR Part 2.1093, Paragraph (d)(2) RSS-102 Issue 5 (2015-03), Paragraph 4	General population/Uncontrolled	SAR 1-g.	1.6

**Table 2:** SAR limit

## 5. DEVICE UNDER TEST

### 5.1. Dimensions

Dimensions	Millimetres
Height x Width x Depth	140.0 x 90.0 x 30.0
Overall Diagonal:	160.0

**Table 3:** Dimensions

### 5.2. Wireless Technology

Wireless Technology	SAR Testing	Frequency Bands	Modes
GSM	Required	850 / 1900	- GPRS (GMSK, Multi-slot class 12) - EGPRS (8PSK, Multi-slot class 12)
W-CDMA	Required	II/V	- UMTS Rel. 99 - HSDPA (Rel. 5) - HSPA (Rel. 6) - HSPA+ (Rel. 7) - DC-HSDPA (Rel. 8)
LTE	Required	2/4/5/7/12/17	- QPSK and 16-QAM (Rel. 9)

**Table 4:** Supported modes

### 5.3. Simultaneous Transmission

The DUT does not support simultaneous transmission.

## 5.4. Antenna Location

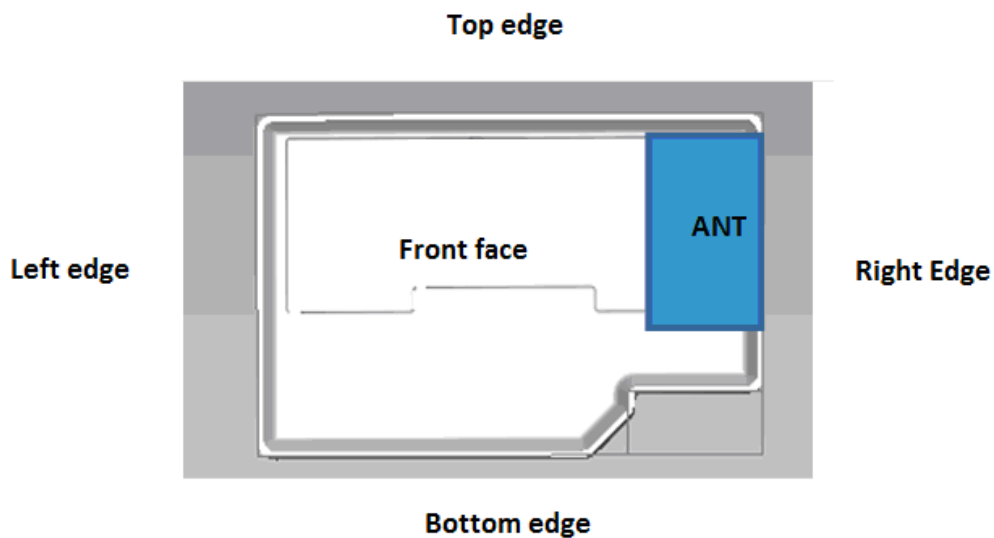

Figure 3: Antenna diagram location sketch

Position	Front	Back	Left	Right	Top	Bottom
Distance to antenna (mm)	7	25	100	7	7	35

## Appendix B: Test results

## INDEX

1. TEST CONDITIONS .....	21
1.1. Power supply (V):.....	21
1.2. Temperature (°C): .....	21
1.3. Test signal, Output Power and Frequencies.....	21
1.4. DUT and test-site configurations .....	21
2. CONDUCTED AVERAGE POWER MEASUREMENTS .....	22
2.1. GSM/GPRS/EGPRS Bands .....	22
2.2. WCDMA/HSDPA/HSPA/HSPA+ Bands .....	24
2.3. LTE Bands. ....	29
3. TISSUE PARAMETERS MEASUREMENTS.....	42
4. SYSTEM CHECK MEASUREMENTS .....	43
4.1. Validation results for Body TSL .....	43
5. MEASUREMENT RESULTS FOR SAR (SPECIFIC ABSORPTION RATE) .....	44
5.1. Summary maximum results for 1-g body SAR measurements. ....	44
5.2. Results for GPRS 850 MHz band – 4 slots.....	45
5.3. Results for GPRS 1900 MHz Band – 4 slots. ....	45
5.4. Results for WCDMA Band II.....	46
5.5. Results for WCDMA Band V .....	46
5.6. Results for LTE Band 2 (1 Rb, 20 MHz, QPSK) .....	47
5.7. Results for LTE Band 2 (50% Rb, 20 MHz, QPSK) .....	47
5.8. Results for LTE Band 4 (1 Rb, 20 MHz, QPSK) .....	48
5.9. Results for LTE Band 4 (50% Rb, 20 MHz, QPSK) .....	48
5.10. Results for LTE Band 5 (1 Rb, 10 MHz, QPSK) .....	49
5.11. Results for LTE Band 5 (50% Rb, 10 MHz, QPSK) .....	49
5.12. Results for LTE Band 7 (1 Rb, 20 MHz, QPSK) .....	50
5.13. Results for LTE Band 7 (50% Rb, 20 MHz, QPSK) .....	50
5.14. Results for LTE Band 12 (1 Rb, 10 MHz, QPSK) .....	51
5.15. Results for LTE Band 12 (50% Rb, 10 MHz, QPSK) .....	51
5.16. Results for LTE Band 17 (1 Rb, 10 MHz, QPSK) .....	51
5.17. Variability results.....	51

## 1. TEST CONDITIONS

### 1.1. Power supply (V):

Type of power supply = External power supply 12.8 V.

### 1.2. Temperature (°C):

$T_n = +20.00$  to  $+25.00$

The subscript n indicates normal test conditions.

### 1.3. Test signal, Output Power and Frequencies

The sample was put into operation by using an R&S CMW 500 as base station simulator for cellular technologies. The output power of the device was set to its maximum level for all tests.

For all operating bands and test positions, the measurements were performed on the middle channel. In each band, for those positions where the maximum averaged SAR was found, measurements were performed on the remaining required.

The actual SAR sample (M/02) does not have accessible antenna connector for Cellular technologies, so the conducted average output power for all technologies was measured using other identical sample (M/01) provided by the manufacturer with an auxiliary external connector. See 'usage of samples' paragraph of this report.

The maximum conducted time-averaged power of the device for each mode was measured with a power sensor R&S NRP-Z81.

The target power alignments including tune-up for RF components declared by the manufacturer for each supported technology are:

Band	Burst Averaged Output Power (dBm)				Frame Averaged Output Power (dBm)			
	1 Tx slot	2 Tx slots	3 Tx slots	4 Tx Slots	1 Tx slot	2 Tx slots	3 Tx slots	4 Tx slots
GPRS/E-GPRS 850	35.0	35.0	35.0	35.0	26.0	29.0	30.75	32.0
GPRS/E-GPRS 1900	32.0	32.0	32.0	32.0	23.0	26.0	27.75	29.0

Output Power (dBm)	Mode						
	WCDMA I	WCDMA VII	LTE B1	LTE B3	LTE B7	LTE B8	LTE B20
Maximum	25.7	25.7	25.7	25.7	25.7	25.7	25.7

### 1.4. DUT and test-site configurations

For all modes supported by the device, the DUT has been tested with each face and edge face facing the flat phantom surface using a test separation distance of 35 mm, except for the left edge due to testing reduction.

## 2. CONDUCTED AVERAGE POWER MEASUREMENTS

### 2.1. GSM/GPRS/EGPRS Bands

- GPRS 850: For data mode. PCL 5, CS1 coding scheme and Gamma 3 were set to allow DUT's max power transmission for each slot.

GPRS 850 - Frame Average Output Power							
Channel Number	Frequency (MHz)	Power (dBm) 1 Slot	Power (dBm) 2 Slots	Power (dBm) 3 Slots	Power (dBm) 4 Slots	PCL	Modulation
128	824.2	23.3	26.1	27.6	28.9	5	GMSK-CS1
190	836.6	23.4	26.3	27.8	29.0	5	GMSK-CS1
251	848.8	23.3	26.2	27.7	28.8	5	GMSK-CS1

GPRS 850 - Average Burst Output Power							
Channel Number	Frequency (MHz)	Power (dBm) 1 Slot	Power (dBm) 2 Slots	Power (dBm) 3 Slots	Power (dBm) 4 Slots	PCL	Modulation
128	824.2	32.3	32.1	31.9	31.9	5	GMSK-CS1
190	836.6	32.5	32.3	32.0	32.0	5	GMSK-CS1
251	848.8	32.3	32.2	31.9	31.8	5	GMSK-CS1

- EGPRS 850: For data mode. PCL 8, MCS5 coding scheme and Gamma 6 were set to allow DUT's max power transmission for each slot.

EDGE 850 - Frame Average Output Power							
Channel Number	Frequency (MHz)	Power (dBm) 1 Slot	Power (dBm) 2 Slots	Power (dBm) 3 Slots	Power (dBm) 4 Slots	PCL	Modulation
128	824.2	16.9	19.7	21.2	22.3	8	8PSK-MCS5
190	836.6	17.1	19.9	21.4	22.5	8	8PSK-MCS5
251	848.8	16.9	19.8	21.2	22.3	8	8PSK-MCS5

EDGE 850 - Average Burst Output Power							
Channel Number	Frequency (MHz)	Power (dBm) 1 Slot	Power (dBm) 2 Slots	Power (dBm) 3 Slots	Power (dBm) 4 Slots	PCL	Modulation
128	824.2	25.9	25.7	25.5	25.3	8	8PSK-MCS5
190	836.6	26.1	26.0	25.7	25.5	8	8PSK-MCS5
251	848.8	25.9	25.8	25.5	25.3	8	8PSK-MCS5

- GPRS1900: For data mode. PCL 0, CS1 coding scheme and Gamma 3 were set to allow max power transmission for each slot.

GPRS 1900 - Frame Average Output Power							
Channel Number	Frequency (MHz)	Power (dBm) 1 Slot	Power (dBm) 2 Slots	Power (dBm) 3 Slots	Power (dBm) 4 Slots	PCL	Modulation
512	1850.2	21.1	23.9	25.5	26.7	0	GMSK-CS1
661	1880.0	21.3	24.3	25.9	27.1	0	GMSK-CS1
810	1909.8	21.2	24.0	25.7	26.9	0	GMSK-CS1

GPRS 1900 - Average Burst Output Power							
Channel Number	Frequency (MHz)	Power (dBm) 1 Slot	Power (dBm) 2 Slots	Power (dBm) 3 Slots	Power (dBm) 4 Slots	PCL	Modulation
512	1850.2	30.1	30.0	29.8	29.7	0	GMSK-CS1
661	1880.0	30.3	30.3	30.1	30.1	0	GMSK-CS1
810	1909.8	30.2	30.1	29.9	29.9	0	GMSK-CS1

- EGPRS 1900: For data mode, PCL 2, MCS5 coding scheme and Gamma 5 were set to allow max power transmission for each slot.

EDGE 1900 - Frame Average Output Power							
Channel Number	Frequency (MHz)	Power (dBm) 1 Slot	Power (dBm) 2 Slots	Power (dBm) 3 Slots	Power (dBm) 4 Slots	PCL	Modulation
512	1850.2	17.2	20.0	21.6	22.6	2	8PSK-MCS5
661	1880.0	17.5	20.3	22.0	23.0	2	8PSK-MCS5
810	1909.8	17.5	20.3	21.9	23.0	2	8PSK-MCS5

EDGE 1900 - Average Burst Output Power							
Channel Number	Frequency (MHz)	Power (dBm) 1 Slot	Power (dBm) 2 Slots	Power (dBm) 3 Slots	Power (dBm) 4 Slots	PCL	Modulation
512	1850.2	26.2	26.0	25.8	25.6	2	8PSK-MCS5
661	1880.0	26.5	26.4	26.2	26.1	2	8PSK-MCS5
810	1909.8	26.6	26.3	26.2	26.0	2	8PSK-MCS5

## 2.2. WCDMA/HSDPA/HSPA/HSPA+ Bands

- **WCDMA:** The DUT supports power Class 3, with a nominal maximum output power of 24 dBm. Tests were completed according to 3GPP TS34.121, section 5.

Mode	Subtest	Rel99
WCDMA	Loopback Mode	Test Mode 1
	Rel99 RMC	12.2Kbps RMC
	Power Control Algorithm	Algorithm2
	$\beta_c/\beta_d$	8/15

Band	Mode	Channel Number	Frequency (MHz)	Average Output Power (dBm)
FDD II 1900	WCDMA	9262	1852.4	23.46
FDD II 1900	WCDMA	9400	1880.0	23.55
FDD II 1900	WCDMA	9538	1907.6	23.70

Band	Mode	Channel Number	Frequency (MHz)	Average Output Power (dBm)
FDD V 850	WCDMA	4132	826.4	23.34
FDD V 850	WCDMA	4182	836.4	23.49
FDD V 850	WCDMA	4233	846.6	23.53



- **HSDPA:**

Mode	Subtest	1	2	3	4
HSDPA	Loopback Mode	Test Mode 1			
	Rel99 RMC	12.2Kbps RMC			
	HSDPA FRC	H-Set1			
	HSUPA Test	HSUPA Loopback			
	Power Control Algorithm	Algorithm 2			
	$\beta_c$	2/15	12/15	15/15	15/15
	$\beta_d$	15/15	15/15	8/15	4/15
	Bd (SF)	64	64	64	64
	$\beta_c/\beta_d$	2/15	12/15	15/8	15/4
	$\beta_{hs}$	4/15	24/15	30/15	30/15
	MPR	0	0	0.5	0.5
	Dack	8			
	Dnak	8			
	Ack-Nack repetition factor	3			
	DCQI	8			
	CQI Feedback	4ms			
	CQI Repetition Factor	2			
$A_{hs} = \beta_{hs}/\beta_c$	30/15				

Band	Mode	Channel Number	Frequency (MHz)	Average Output Power (dBm)			
				Subtest 1	Subtest 2	Subtest 3	Subtest 4
FDD II 1900	HSDPA	9262	1852.4	22.99	21.89	22.58	23.05
FDD II 1900	HSDPA	9400	1880.0	23.56	22.41	23.52	23.50
FDD II 1900	HSDPA	9538	1907.6	23.61	22.38	23.13	23.41

Band	Mode	Channel Number	Frequency (MHz)	Average Output Power (dBm)			
				Subtest 1	Subtest 2	Subtest 3	Subtest 4
FDD V 850	HSDPA	4132	826.4	23.24	22.32	22.59	22.66
FDD V 850	HSDPA	4182	836.4	23.45	21.96	22.75	22.77
FDD V 850	HSDPA	4233	846.6	23.49	21.88	22.71	22.73

**- HSPA:**

Mode	Subtest	1	2	3	4	5
<b>HSPA</b>	Loopback Mode	Test Mode 1				
	Rel99 RMC	12.2Kbps RMC				
	HSDPA FRC	H-Set1				
	HSUPA Test	HSUPA Loopback				
	Power Control Algorithm	Algorithm 2				
	$\beta_c$	11/15	6/15	15/15	2/15	15/15
	$\beta_d$	15/15	15/15	9/15	15/15	15/15
	$\beta_{ec}$	209/225	12/15	30/15	2/15	24/15
	$\beta_c/\beta_d$	11/15	6/15	15/9	2/15	15/15
	$\beta_{hs}$	22/15	12/15	30/15	4/15	30/15
	$\beta_{ed}$	1309/225	94/75	47/15	56/75	134/15
	MPR (dB)	0	2	1	2	0
	Dack	8				
	Dnak	8				
	Ack-Nack repetition factor	3				
	DCQI	8				
	CQI Feedback	4ms				
	CQI Repetition Factor	2				
	Ahs = $\beta_{hs}/\beta_c$	30/15				
	AG Index	20	12	15	17	21
ETFCI	75	67	92	71	81	
Associated Max UL DataRate Kbps	242.1	174.9	482.8	205.8	308.9	

Band	Mode	CH	Frequency (MHz)	Average Output Power (dBm)				
				Subtest 1	Subtest 2	Subtest 3	Subtest 4	Subtest 5
FDD II 1900	HSPA	9262	1852.4	21.47	21.28	21.75	21.74	21.75
FDD II 1900	HSPA	9400	1880.0	22.16	21.78	22.28	22.25	22.31
FDD II 1900	HSPA	9538	1907.6	22.10	21.62	22.19	22.04	22.42

Band	Mode	CH	Frequency (MHz)	Average Output Power (dBm)				
				Subtest 1	Subtest 2	Subtest 3	Subtest 4	Subtest 5
FDD V 850	HSPA	4132	826.4	21.50	21.61	21.70	21.47	21.70
FDD V 850	HSPA	4182	836.4	21.73	21.18	21.78	21.64	21.87
FDD V 850	HSPA	4233	846.6	21.71	21.15	21.79	21.62	21.87

**- HSPA+**

Mode	Subtest	1
HSPA+	Loopback Mode	Test Mode 1
	Rel99 RMC	12.2Kbps RMC
	HSDPA FRC	H-Set1
	HSUPA Test	HSUPA Loopback
	Power Control Algorithm	Algorithm 2
	$\beta_c$	1
	$\beta_d$	0
	$\beta_{ec}$	30/15
	$\beta_{hs}$	30/15
	$\beta_{ed}$ (2xSF2)	$\beta_{ed1}$ : 30/15 $\beta_{ed2}$ : 30/15
	$\beta_{ed}$ (2xSF4)	$\beta_{ed3}$ : 24/15 $\beta_{ed4}$ : 24/15
	CM (dB)	3.5
	MPR (dB)	2.5
	D E-DPCCH	7
	AG Index	14
	ETFCI	105

Band	Mode	CH	Frequency (MHz)	Average Output Power (dBm)
FDD II 1900	HSPA+	9262	1852.4	22.81
FDD II 1900	HSPA+	9400	1880.0	23.40
FDD II 1900	HSPA+	9538	1907.6	23.35

Band	Mode	CH	Frequency (MHz)	Average Output Power (dBm)
FDD V 850	HSPA+	4132	826.4	22.65
FDD V 850	HSPA+	4182	836.4	22.80
FDD V 850	HSPA+	4233	846.6	22.80

**- DC-HSDPA**

	Mode	HSDPA	HSDPA	HSDPA	HSDPA
	Subtest	1	2	3	4
W-CDMA General Settings	Loopback Mode	Test Mode 1			
	Rel99 RMC	12.2 Kbps RMC			
	HSDPA FRC	H-Set 12			
	Power Control Algorithm	Algorithm 2			
	$\beta_c$	2/15	12/15	15/15	15/15
	$\beta_d$	15/15	15/15	8/15	4/15
	Bd (SF)	64			
	$\beta_c/\beta_d$	2/15	12/15	15/8	15/4
	$\beta_{hs}$	4/15	24/15	30/15	30/15
	CM (dB)	0	1	1.5	1.5
MPR	0.0	0.0	0.5	0.5	
HSDPA Specific Settings	Dack	8			
	Dnak	8			
	DCQI	8			
	Ack-Nack repetition factor	3			
	CQI Feedback	4ms			
	CQI Repetition Factor	2			
	Ahs = $\beta_{hs}/\beta_c$	30/15			

Band	Mode	CH	Frequency (MHz)	Average Output Power (dBm)			
				Subtest 1	Subtest 2	Subtest 3	Subtest 4
FDD II 1900	DC-HSDPA	9262	1852.4	22.99	23.23	23.30	23.18
FDD II 1900	DC-HSDPA	9400	1880.0	23.64	23.69	23.64	23.53
FDD II 1900	DC-HSDPA	9538	1907.6	23.55	23.48	23.56	23.39

Band	Mode	CH	Frequency (MHz)	Average Output Power (dBm)			
				Subtest 1	Subtest 2	Subtest 3	Subtest 4
FDD V 850	DC-HSDPA	4132	826.4	23.23	23.28	23.26	23.24
FDD V 850	DC-HSDPA	4182	836.4	23.46	23.43	23.44	23.46
FDD V 850	DC-HSDPA	4233	846.6	23.42	23.41	23.56	23.41

### 2.3. LTE Bands.

LTE MPR is permanently implemented for the device. The specific target MPR is indicated into the following tables. A-MPR was disabled for all SAR tests.

Band	BW	Modulation	Mode	MPR	Average Output Power (dBm)		
					Low CH	Mid CH	High CH
					1860.0 MHz	1880.0 MHz	1900.0 MHz
LTE B2	20 MHz	QPSK	1RB Low	0	23.17	23.27	23.22
			1RB Mid	0	23.41	23.20	23.30
			1RB High	0	23.34	23.29	23.31
			50% Low	1	22.10	21.64	22.14
			50% Mid	1	22.02	21.84	22.07
			50% High	1	22.27	21.81	22.04
			100%	1	21.96	21.91	22.15
		16-QAM	1RB Low	1	21.86	21.60	22.03
			1RB Mid	1	21.88	21.84	22.11
			1RB High	1	21.91	21.79	22.21
			50% Low	2	20.87	20.64	20.95
			50% Mid	2	21.00	20.83	20.95
			50% High	2	20.89	20.95	20.92
			100%	2	20.71	20.92	20.94
Band	BW	Modulation	Mode	MPR	Low CH	Mid CH	High CH
					1857.5 MHz	1880.0 MHz	1902.5 MHz
LTE B2	15 MHz	QPSK	1RB Low	0	22.92	23.19	23.02
			1RB Mid	0	23.02	22.88	23.09
			1RB High	0	22.91	23.05	23.15
			50% Low	1	21.64	21.92	21.87
			50% Mid	1	21.80	21.96	21.95
			50% High	1	21.76	22.09	22.02
			100%	1	21.69	21.89	22.05
		16-QAM	1RB Low	1	21.57	21.86	21.98
			1RB Mid	1	21.56	21.87	21.98
			1RB High	1	21.54	21.92	22.12
			50% Low	2	20.64	20.70	20.86
			50% Mid	2	20.57	20.89	20.91
			50% High	2	20.67	20.92	20.99
			100%	2	20.58	20.99	21.00

Band	BW	Modulation	Mode	MPR	Average Output Power (dBm)			
					Low CH	Mid CH	High CH	
					1855.0 MHz	1880.0 MHz	1905.0 MHz	
LTE B2	10 MHz	QPSK	1RB Low	0	22.76	22.98	23.05	
			1RB Mid	0	22.79	23.06	23.22	
			1RB High	0	22.78	23.16	23.20	
			50% Low	1	21.48	21.94	22.18	
			50% Mid	1	21.79	21.89	22.05	
			50% High	1	21.75	21.93	22.10	
		16-QAM	100%	1	21.65	21.87	22.05	
			1RB Low	1	21.73	21.79	21.96	
			1RB Mid	1	21.75	21.91	22.09	
			1RB High	1	21.65	21.95	22.04	
			50% Low	2	20.49	20.74	21.07	
			50% Mid	2	20.56	20.87	20.98	
LTE B2	5 MHz	QPSK	50% High	2	20.72	21.03	21.02	
			100%	2	20.68	20.98	21.00	
			16-QAM	1RB Low	1	21.44	22.03	21.97
				1RB Mid	1	21.39	21.89	22.02
				1RB High	1	21.54	21.85	21.95
				50% Low	2	20.66	20.91	20.91
		50% Mid		2	20.73	21.08	21.11	
		50% High		2	20.50	20.96	20.92	
		100%	2	20.46	20.85	20.90		

Band	BW	Modulation	Mode	MPR	Average Output Power (dBm)			
					Low CH	Mid CH	High CH	
					1851.5 MHz	1880.0 MHz	1908.5 MHz	
LTE B2	3 MHz	QPSK	1RB Low	0	22.31	22.99	22.98	
			1RB Mid	0	22.32	22.72	22.97	
			1RB High	0	22.31	22.89	22.88	
			50% Low	1	21.34	21.71	21.92	
			50% Mid	1	21.33	21.85	21.92	
			50% High	1	21.33	21.70	21.77	
		16-QAM	100%	1	21.30	21.75	21.95	
			1RB Low	1	21.10	21.97	21.59	
			1RB Mid	1	21.09	21.79	21.58	
			1RB High	1	21.15	21.77	21.65	
			50% Low	2	20.31	20.68	20.69	
			50% Mid	2	20.30	20.88	20.96	
LTE B2	1.4 MHz	QPSK	50% High	2	20.29	20.69	20.79	
			100%	2	20.27	20.68	20.72	
			16-QAM	Low CH	Mid CH	High CH		
				1850.7 MHz	1880.0 MHz	1909.3 MHz		
				1RB Low	0	22.31	22.70	23.06
				1RB Mid	0	22.32	22.82	23.11
		1RB High		0	22.28	22.75	22.91	
		50% Low		0	22.23	22.73	22.97	
		50% Mid	0	22.22	22.91	23.09		
		50% High	0	22.25	22.74	22.92		
		100%	1	21.38	21.70	22.27		
		16-QAM	1RB Low	1	21.03	21.72	21.69	
1RB Mid	1		21.17	21.89	21.85			
1RB High	1		20.92	21.76	21.75			
50% Low	1		21.07	20.75	20.77			
50% Mid	1		21.23	20.90	20.86			
50% High	1		21.11	20.77	20.78			
100%	2	20.01	20.70	20.77				

Band	BW	Modulation	Mode	MPR	Average Output Power (dBm)		
					Low CH	Mid CH	High CH
					1720.0 MHz	1732.5 MHz	1745.0 MHz
LTE B4	20 MHz	QPSK	1RB Low	0	23.57	23.28	23.39
			1RB Mid	0	23.65	23.37	23.06
			1RB High	0	23.53	23.50	23.01
			50% Low	1	22.30	22.15	22.19
			50% Mid	1	22.54	22.38	22.17
			50% High	1	22.28	22.22	21.80
			100%	1	22.26	22.14	22.01
		16-QAM	1RB Low	1	22.04	22.28	22.43
			1RB Mid	1	22.22	22.41	22.16
			1RB High	1	22.02	22.15	22.05
			50% Low	2	21.30	21.21	21.30
			50% Mid	2	21.69	21.45	21.25
			50% High	2	21.31	21.21	20.77
			100%	2	21.28	21.19	21.04
Band	BW	Modulation	Mode	MPR	Low CH	Mid CH	High CH
					1717.5 MHz	1732.5 MHz	1747.5 MHz
LTE B4	15 MHz	QPSK	1RB Low	0	23.43	23.11	23.54
			1RB Mid	0	23.48	23.21	23.08
			1RB High	0	23.41	23.12	23.30
			50% Low	1	22.11	22.09	22.14
			50% Mid	1	22.37	22.37	22.06
			50% High	1	22.22	22.14	21.89
			100%	1	22.26	22.13	22.02
		16-QAM	1RB Low	1	22.13	22.07	22.04
			1RB Mid	1	22.10	22.22	21.75
			1RB High	1	22.11	22.06	21.91
			50% Low	2	21.21	21.23	20.99
			50% Mid	2	21.44	21.40	21.06
			50% High	2	21.24	21.21	20.79
			100%	2	21.21	21.21	20.96



Band	BW	Modulation	Mode	MPR	Average Output Power (dBm)		
					Low CH	Mid CH	High CH
					1715.0 MHz	1732.5 MHz	1750.0 MHz
LTE B4	10 MHz	QPSK	1RB Low	0	23.48	23.45	23.26
			1RB Mid	0	23.59	23.62	23.13
			1RB High	0	23.50	23.36	23.27
			50% Low	1	22.54	22.32	21.97
			50% Mid	1	22.41	22.33	22.05
			50% High	1	22.51	22.32	22.01
			100%	1	22.52	22.31	21.97
		16-QAM	1RB Low	1	22.35	22.37	22.01
			1RB Mid	1	22.45	22.55	21.91
			1RB High	1	22.35	22.36	22.05
			50% Low	2	21.42	21.31	20.93
			50% Mid	2	21.44	21.36	21.03
			50% High	2	21.41	21.31	21.05
			100%	2	21.43	21.32	21.12
Band	BW	Modulation	Mode	MPR	Low CH	Mid CH	High CH
					1712.5 MHz	1732.5 MHz	1752.5 MHz
LTE B4	5 MHz	QPSK	1RB Low	0	23.15	23.20	22.80
			1RB Mid	0	23.33	23.35	22.87
			1RB High	0	23.20	23.28	22.89
			50% Low	1	22.17	22.10	21.85
			50% Mid	1	22.76	22.58	22.31
			50% High	1	22.30	22.23	21.83
			100%	1	22.24	22.09	21.84
		16-QAM	1RB Low	1	22.15	22.15	22.00
			1RB Mid	1	22.33	22.27	22.15
			1RB High	1	22.19	22.25	22.22
			50% Low	2	21.18	21.09	21.05
			50% Mid	2	21.64	21.55	21.36
			50% High	2	21.30	21.21	21.10
			100%	2	21.24	21.13	21.11

Band	BW	Modulation	Mode	MPR	Average Output Power (dBm)			
					Low CH	Mid CH	High CH	
					1711.5 MHz	1732.5 MHz	1753.5 MHz	
LTE B4	3 MHz	QPSK	1RB Low	0	23.34	23.24	23.20	
			1RB Mid	0	23.39	23.32	23.26	
			1RB High	0	23.35	23.32	23.24	
			50% Low	1	22.24	22.20	22.03	
			50% Mid	1	22.60	22.56	22.06	
			50% High	1	22.28	22.21	22.15	
		16-QAM	100%	1	22.21	22.15	22.02	
			1RB Low	1	22.13	22.01	21.91	
			1RB Mid	1	22.20	22.08	21.98	
			1RB High	1	22.24	22.09	22.02	
			50% Low	2	21.26	21.18	21.08	
			50% Mid	2	21.58	21.57	21.13	
LTE B4	1.4 MHz	QPSK	50% High	2	21.38	21.27	21.20	
			100%	2	21.29	21.18	21.08	
			16-QAM	1RB Low	1	21.97	22.60	22.04
				1RB Mid	1	22.20	22.81	22.20
				1RB High	1	22.10	22.57	22.06
				50% Low	1	21.99	22.46	22.18
		50% Mid		1	22.06	22.35	22.18	
		50% High		1	22.08	22.57	22.17	
		100%	2	21.01	21.45	21.22		

Band	BW	Modulation	Mode	MPR	Average Output Power (dBm)		
					Low CH	Mid CH	High CH
					829.0 MHz	836.5 MHz	844.0 MHz
LTE B5	10 MHz	QPSK	1RB Low	0	22.32	22.64	22.74
			1RB Mid	0	22.53	22.83	22.72
			1RB High	0	22.53	22.61	22.57
			50% Low	1	21.41	21.72	21.72
			50% Mid	1	21.68	21.99	21.82
			50% High	1	21.50	21.64	21.55
			100%	1	21.52	21.65	21.49
		16-QAM	1RB Low	1	21.21	21.67	21.57
			1RB Mid	1	21.38	21.99	21.58
			1RB High	1	21.42	21.61	21.36
			50% Low	2	20.47	20.71	20.70
			50% Mid	2	20.70	20.94	20.79
			50% High	2	20.54	20.73	20.59
			100%	2	20.52	20.70	20.60
Band	BW	Modulation	Mode	MPR	Low CH	Mid CH	High CH
					826.5 MHz	836.5 MHz	846.5 MHz
LTE B5	5 MHz	QPSK	1RB Low	0	22.20	22.45	22.45
			1RB Mid	0	22.45	22.70	22.47
			1RB High	0	22.36	22.71	22.36
			50% Low	1	21.38	21.68	21.50
			50% Mid	1	21.52	21.79	21.74
			50% High	1	21.38	21.81	21.43
			100%	1	21.41	21.55	21.51
		16-QAM	1RB Low	1	21.26	21.55	21.51
			1RB Mid	1	21.49	21.74	21.52
			1RB High	1	21.31	21.70	21.37
			50% Low	2	20.43	20.67	20.53
			50% Mid	2	20.53	20.81	20.69
			50% High	2	20.41	20.68	20.45
			100%	2	20.44	20.63	20.55

Band	BW	Modulation	Mode	MPR	Average Output Power (dBm)			
					Low CH	Mid CH	High CH	
					825.5 MHz	836.5 MHz	847.5 MHz	
LTE B5	3 MHz	QPSK	1RB Low	0	22.30	22.65	22.58	
			1RB Mid	0	22.37	22.75	22.46	
			1RB High	0	22.45	22.76	22.50	
			50% Low	1	21.30	21.74	21.53	
			50% Mid	1	21.57	21.85	21.63	
			50% High	1	21.37	21.75	21.44	
		16-QAM	100%	1	21.38	21.70	21.47	
			1RB Low	1	21.18	21.72	21.44	
			1RB Mid	1	21.25	21.79	21.31	
			1RB High	1	21.33	21.81	21.35	
			50% Low	2	20.36	20.71	20.63	
			50% Mid	2	20.56	20.90	20.65	
LTE B5	1.4 MHz	QPSK	50% High	2	20.42	20.81	20.52	
			100%	2	20.47	20.72	20.50	
			16-QAM	1RB Low	1	21.60	21.62	21.47
				1RB Mid	1	21.61	21.75	21.56
				1RB High	1	21.50	21.61	21.48
				50% Low	1	21.48	21.74	21.40
		50% Mid		1	21.48	21.92	21.58	
		50% High		1	21.45	21.73	21.42	
		100%	2	20.52	20.74	20.43		

Band	BW	Modulation	Mode	MPR	Average Output Power (dBm)		
					Low CH	Mid CH	High CH
					2510 MHz	2535 MHz	2560 MHz
LTE B7	20 MHz	QPSK	1RB Low	0	21.93	21.88	21.93
			1RB Mid	0	21.75	21.80	22.10
			1RB High	0	21.72	21.73	21.84
			50% Low	1	20.66	20.73	20.81
			50% Mid	1	20.63	20.69	20.93
			50% High	1	20.66	20.55	20.87
			100%	1	20.61	20.64	20.79
		16-QAM	1RB Low	1	20.94	20.90	20.62
			1RB Mid	1	20.74	20.76	20.88
			1RB High	1	20.67	20.77	20.61
			50% Low	2	19.71	19.76	19.87
			50% Mid	2	19.69	19.71	19.97
			50% High	2	19.70	19.65	19.84
			100%	2	19.69	19.67	19.92
Band	BW	Modulation	Mode	MPR	Low CH	Mid CH	High CH
					2507.5 MHz	2535 MHz	2562.5 MHz
LTE B7	15 MHz	QPSK	1RB Low	0	21.92	21.86	21.92
			1RB Mid	0	21.72	21.67	22.01
			1RB High	0	21.83	21.65	21.87
			50% Low	1	20.82	20.74	20.99
			50% Mid	1	21.01	20.67	20.98
			50% High	1	20.64	20.66	20.86
			100%	1	20.72	20.63	20.87
		16-QAM	1RB Low	1	20.98	20.73	20.76
			1RB Mid	1	20.61	20.51	20.87
			1RB High	1	20.56	20.50	20.73
			50% Low	2	19.86	19.85	19.94
			50% Mid	2	19.67	19.81	19.98
			50% High	2	19.73	19.66	19.83
			100%	2	19.75	19.69	19.85

Band	BW	Modulation	Mode	MPR	Average Output Power (dBm)		
					Low CH	Mid CH	High CH
					2505 MHz	2535 MHz	2565 MHz
LTE B7	10 MHz	QPSK	1RB Low	0	21.75	21.82	22.16
			1RB Mid	0	21.83	21.77	22.07
			1RB High	0	21.66	21.74	21.94
			50% Low	1	20.66	20.62	21.07
			50% Mid	1	20.65	20.69	20.95
			50% High	1	20.54	20.63	20.90
			100%	1	20.49	20.61	20.94
		16-QAM	1RB Low	1	20.70	20.58	21.17
			1RB Mid	1	20.63	20.56	21.05
			1RB High	1	20.45	20.47	20.97
			50% Low	2	19.71	19.78	20.05
			50% Mid	2	19.70	19.69	19.93
			50% High	2	19.62	19.63	19.89
			100%	2	19.71	19.78	19.92
Band	BW	Modulation	Mode	MPR	Low CH	Mid CH	High CH
					2502.5 MHz	2535 MHz	2567.5 MHz
LTE B7	5 MHz	QPSK	1RB Low	0	21.79	21.59	21.73
			1RB Mid	0	21.57	21.56	21.75
			1RB High	0	21.53	21.50	21.69
			50% Low	1	20.52	20.59	20.74
			50% Mid	1	20.52	20.56	20.78
			50% High	1	20.44	20.50	20.77
			100%	1	20.77	20.52	20.80
		16-QAM	1RB Low	1	20.62	20.54	20.73
			1RB Mid	1	20.51	20.52	20.77
			1RB High	1	20.43	20.49	20.72
			50% Low	2	19.62	19.71	19.75
			50% Mid	2	19.60	19.58	19.79
			50% High	2	19.55	19.55	19.74
			100%	2	19.59	19.61	19.77

Band	BW	Modulation	Mode	MPR	Average Output Power (dBm)		
					Low CH	Mid CH	High CH
LTE B12	10 MHz	QPSK	1RB Low	0	-	707.5 MHz	-
			1RB Mid	0		22.37	
			1RB High	0		22.74	
			50% Low	1		22.39	
			50% Mid	1		21.45	
			50% High	1		21.49	
			100%	1		21.51	
		16-QAM	1RB Low	1		21.37	
			1RB Mid	1		21.08	
			1RB High	1		21.44	
			50% Low	2		21.04	
			50% Mid	2		20.31	
			50% High	2		20.38	
			100%	2		20.35	
					20.34		
Band	BW	Modulation	Mode	MPR	Low CH	Mid CH	High CH
					701.5 MHz	707.5 MHz	713.5 MHz
LTE B12	5 MHz	QPSK	1RB Low	0	22.23	22.05	22.05
			1RB Mid	0	22.25	22.22	22.10
			1RB High	0	22.05	22.02	21.94
			50% Low	1	21.24	21.16	21.09
			50% Mid	1	21.28	21.20	21.09
			50% High	1	21.08	21.24	21.08
			100%	1	21.12	21.25	21.15
		16-QAM	1RB Low	1	21.24	21.19	21.02
			1RB Mid	1	21.22	21.39	21.15
			1RB High	1	21.03	21.09	20.95
			50% Low	2	20.21	20.19	20.22
			50% Mid	2	20.27	20.32	20.23
			50% High	2	20.16	20.31	20.16
			100%	2	20.22	20.30	20.19

\*Note: According to KDB941225 D05 SAR for LTE Devices, for LTE bands that do not support at least three non-overlapping channels in certain channel bandwidths, test the available non-overlapping channels instead. When a device supports overlapping channel assignment in a channel bandwidth configuration, the middle channel of the group of overlapping channels should be selected for testing.

Band	BW	Modulation	Mode	MPR	Average Output Power (dBm)		
					Low CH	Mid CH	High CH
					700.5 MHz	707.5 MHz	714.5 MHz
LTE B12	3 MHz	QPSK	1RB Low	0	22.20	22.20	22.19
			1RB Mid	0	22.02	22.40	22.22
			1RB High	0	22.13	22.34	22.19
			50% Low	1	21.13	21.16	21.17
			50% Mid	1	21.02	21.20	21.17
			50% High	1	21.11	21.19	21.02
			100%	1	21.10	21.21	21.11
		16-QAM	1RB Low	1	21.15	21.32	21.05
			1RB Mid	1	20.99	21.35	20.92
			1RB High	1	21.04	21.27	20.89
			50% Low	2	20.17	20.25	20.24
			50% Mid	2	20.15	21.23	20.19
			50% High	2	20.25	20.29	20.09
			100%	2	20.25	20.28	20.19
Band	BW	Modulation	Mode	MPR	Low CH	Mid CH	High CH
LTE B12	1.4 MHz	QPSK	1RB Low	0	22.12	22.26	22.29
			1RB Mid	0	22.11	22.39	22.36
			1RB High	0	22.02	22.34	22.24
			50% Low	0	22.16	22.19	22.15
			50% Mid	0	22.11	21.35	22.09
			50% High	0	22.06	22.27	22.07
			100%	1	21.10	21.23	21.02
		16-QAM	1RB Low	1	21.14	21.35	21.05
			1RB Mid	1	21.16	21.52	21.21
			1RB High	1	21.06	21.30	20.99
			50% Low	1	21.23	21.32	21.01
			50% Mid	1	21.17	21.37	21.03
			50% High	1	21.10	21.24	21.00
			100%	2	20.18	20.25	20.05
Band	BW	Modulation	Mode	MPR	Low CH	Mid CH	High CH
LTE B12	1.4 MHz	QPSK	1RB Low	0	22.12	22.26	22.29
			1RB Mid	0	22.11	22.39	22.36
			1RB High	0	22.02	22.34	22.24
			50% Low	0	22.16	22.19	22.15
			50% Mid	0	22.11	21.35	22.09
			50% High	0	22.06	22.27	22.07
			100%	1	21.10	21.23	21.02
		16-QAM	1RB Low	1	21.14	21.35	21.05
			1RB Mid	1	21.16	21.52	21.21
			1RB High	1	21.06	21.30	20.99
			50% Low	1	21.23	21.32	21.01
			50% Mid	1	21.17	21.37	21.03
			50% High	1	21.10	21.24	21.00
			100%	2	20.18	20.25	20.05



Band	BW	Modulation	Mode	MPR	Average Output Power (dBm)		
					Low CH	Mid CH	High CH
LTE B17	10 MHz	QPSK	1RB Low	0	-	21.93	-
			1RB Mid	0	-	22.12	-
			1RB High	0	-	21.83	-
			50% Low	1	-	20.96	-
			50% Mid	1	-	20.90	-
			50% High	1	-	20.94	-
			100%	1	-	20.91	-
		16-QAM	1RB Low	1	-	20.68	-
			1RB Mid	1	-	21.02	-
			1RB High	1	-	20.75	-
			50% Low	2	-	19.94	-
			50% Mid	2	-	19.93	-
			50% High	2	-	20.01	-
			100%	2	-	19.94	-
<b>Band</b>	<b>BW</b>	<b>Modulation</b>	<b>Mode</b>	<b>MPR</b>	<b>Low CH</b>	<b>Mid CH</b>	<b>High CH</b>
					-	710 MHz	-
LTE B17	5 MHz	QPSK	1RB Low	0	-	21.96	-
			1RB Mid	0	-	21.96	-
			1RB High	0	-	21.88	-
			50% Low	1	-	20.90	-
			50% Mid	1	-	20.89	-
			50% High	1	-	20.87	-
			100%	1	-	20.86	-
		16-QAM	1RB Low	1	-	20.94	-
			1RB Mid	1	-	20.95	-
			1RB High	1	-	20.91	-
			50% Low	2	-	19.89	-
			50% Mid	2	-	19.90	-
			50% High	2	-	19.87	-
			100%	2	-	19.86	-

\*Note: According to KDB941225 D05 SAR for LTE Devices, for LTE bands that do not support at least three non-overlapping channels in certain channel bandwidths, test the available non-overlapping channels instead. When a device supports overlapping channel assignment in a channel bandwidth configuration, the middle channel of the group of overlapping channels should be selected for testing.

### 3. TISSUE PARAMETERS MEASUREMENTS

Frequency (MHz)	Target Body Tissue		Measured Body Tissue		Deviation %		Measured Date
	Permittivity $\epsilon$	Conductivity $\sigma$ [S/m]	Permittivity $\epsilon$	Conductivity $\sigma$ [S/m]	Permittivity $\epsilon$	Conductivity $\sigma$ [S/m]	
750	55.5	0.96	54.97	0.98	-1.02	1.97	2019-04-22
835	55.2	0.97	55.03	0.96	-0.31	-0.67	2019-04-15
900	55.0	1.05	54.48	1.03	-0.95	-1.64	2019-04-15
1750	53.4	1.49	52.84	1.52	-1.10	2.22	2019-04-23
1800	53.3	1.52	52.80	1.57	-0.93	3.44	2019-04-23
1800	53.3	1.52	52.53	1.47	-1.45	-3.32	2019-04-23
2450	52.7	1.95	52.87	2.00	0.33	2.55	2019-04-22
2600	52.5	2.16	52.46	2.18	-0.09	0.64	2019-04-22

Note: The dielectric properties have been measured by the contact probe method at 22°C.

#### - Composition / Information on ingredients

##### **Head and Muscle Tissue Simulation Liquids HSL750V2/MSL750V2**

Water	Water, 35 – 58%
Sucrose	Sugar, white, refined, 40 – 60%
NaCl	Sodium Chloride, 0 – 6%
Hydroxyethyl-cellulose Medium	Viscosity (CAS# 9004-62-0), <0.3%
Preventol-D7	Preservative: aqueous preparation, (CAS# 55965-84-9), containing 5-chloro-2-methyl-3(2H)-isothiazolone and 2-methyl-3(2H)-isothiazolone, 0.1 – 0.7%

##### **Head and Muscle Tissue Simulation Liquids HSL900/MSL900**

Water	Water, 35 – 58%
Sucrose	Sugar, white, refined, 40 – 60%
NaCl	Sodium Chloride, 0 – 6%
Hydroxyethyl-cellulose Medium	Viscosity (CAS# 9004-62-0), <0.3%
Preventol-D7	Preservative: aqueous preparation, (CAS# 55965-84-9), containing 5-chloro-2-methyl-3(2H)-isothiazolone and 2-methyl-3(2H)-isothiazolone, 0.1 – 0.7%

##### **Head and Muscle Tissue Simulation Liquids HBBL1350-1850V3/M HBBL1350-1850V3**

Water	50 – 73 %
Non-ionic detergents	27 – 50 % polyoxyethylenesorbitan monolaurate
NaCl	0 – 2 %
Preservative	0.05 – 0.1% Preventol-D7
Safety relevant ingredients:	
CAS-No. 55965-84-9	< 0.1 % aqueous preparation, containing 5-chloro-2-methyl-3(2H)-isothiazolone and 2-methyl-3(2H)-isothiazolone
CAS-No. 9005-64-5	<50 % polyoxyethylenesorbitan monolaurate

##### **Head and Muscle Tissue Simulation Liquids HSL1800/MSL1800**

Water	Water, 52 – 75%
C8H18O3	Diethylene glycol monobutyl ether (DGBE), 25 – 48% (CAS-No. 112-34-5, EC-No. 203-961-6, EC-index-No. 603-096-00-8)
NaCl	Sodium Chloride, <1.0%

### **Head and Muscle Tissue Simulation Liquids HBBL1900-3800V3/M HBBL1900-3800V3**

Water	50 – 73 %
Non-ionic detergents	27 – 50 % polyoxyethylenesorbitan monolaurate
NaCl	0 – 2 %
Preservative	0.05 – 0.1% Preventol-D7
Safety relevant ingredients:	
CAS-No. 55965-84-9	< 0.1 % aqueous preparation, containing 5-chloro-2-methyl-3(2H)-isothiazolone and 2-methyl-3(2H)-isothiazolone
CAS-No. 9005-64-5	<50 % polyoxyethylenesorbitan monolaurate

## **4. SYSTEM CHECK MEASUREMENTS**

### **4.1. Validation results for Body TSL**

Date	Frequency (MHz)	SAR over	Fast SAR (W/kg)	SAR (W/kg)	1 W Target SAR (W/kg)	1 W Norm. SAR (W/kg)	Drift (%)
2019/04/22	750	1 gr.	2.20	2.14	8.68	8.54	-1.57
		10 gr.	1.50	1.44	5.72	5.75	0.50
2019/04/15	900	1 gr.	2.69	2.63	11.1	10.66	-3.98
		10 gr.	1.79	1.71	7.25	6.93	-4.41
2019/04/23	1800	1 gr.	10.10	9.88	38.7	39.40	1.80
		10 gr.	5.23	5.15	20.5	20.54	0.18
2019/04/23	1800	1 gr.	9.70	9.46	38.7	37.98	-1.85
		10 gr.	4.99	4.89	20.5	19.63	-4.22
2019/04/22	2450	1 gr.	14.50	14.30	54.7	56.35	3.02
		10 gr.	6.38	6.30	24.4	24.83	1.74

## 5. MEASUREMENT RESULTS FOR SAR (SPECIFIC ABSORPTION RATE)

### 5.1. Summary maximum results for 1-g body SAR measurements.

Mode	Position/ Distance	Channel (Frequency)	Reported SAR 1-g (W/kg)	Limit SAR 1-g (W/kg)
GPRS 4 slots 850 MHz	Front face 35 mm	CH 128 (824.2 MHz)	1.441	1.6
GPRS 4 slots 1900 MHz	Front face 35 mm	CH 810 (1909.8 MHz)	0.670	1.6
WCDMA Band II	Front face 35 mm	CH 9262 (1852.4 MHz)	0.273	1.6
WCDMA Band V	Front face 35 mm	CH 4183 (836.6 MHz)	0.343	1.6
LTE Band 2 1RB	Front face 35 mm	CH 19100 (1900 MHz)	0.222	1.6
LTE Band 4 1RB	Front face 35 mm	CH 20300 (1745 MHz)	0.209	1.6
LTE Band 5 1RB	Front face 35 mm	CH 20450 (829 MHz)	0.237	1.6
LTE Band 7 1RB	Front face 35 mm	CH 21350 (2560 MHz)	0.287	1.6
LTE Band 12 1RB	Front face 35 mm	CH 23095 (707.5 MHz)	0.472	1.6

## 5.2. Results for GPRS 850 MHz band – 4 slots.

Position	Dist (mm)	Channel (Frequency)	Estimated SAR 1-g (W/kg)	SAR 1-g (W/kg)	Power Drift (%)	Scale factor	Reported SAR 1-g (W/kg)	Plot No.
Front face	35	CH 189 (836.6 MHz)	0.638	0.682	1.51	1.995	1.361	
Back face	35	CH 189 (836.6 MHz)	0.53	N/M <sup>1</sup>	2.09	1.995	1.057	
Left edge	35	CH 189 (836.6 MHz)	N/M <sup>2</sup>					
Right edge	35	CH 189 (836.6 MHz)	0.0464	N/M <sup>1</sup>	3.40	1.995	0.093	
Top edge	35	CH 189 (836.6 MHz)	0.324	N/M <sup>1</sup>	2.45	1.995	0.646	
Bottom edge	35	CH 189 (836.6 MHz)	0.145	N/M <sup>1</sup>	-3.17	1.995	0.309	
Front face	35	CH 128 (824.2 MHz)	0.71	0.706	0.12	2.042	1.441	1
Front face	35	CH 251 (848.8 MHz)	0.67	0.624	-4.72	2.089	1.436	

1 and 2: See Remarks and Comments

Testing of GPRS EDGE mode is not required according to test reductions mentioned in FCC OET KDB 941225 D01 3G SAR Procedures, paragraph “5. GSM, GPRS and EDGE”

## 5.3. Results for GPRS 1900 MHz Band – 4 slots.

Position	Dist (mm)	Channel (Frequency)	Estimated SAR 1-g (W/kg)	SAR 1-g (W/kg)	Power Drift (%)	Scale factor	Reported SAR 1-g (W/kg)	Plot No.
Front face	35	CH 661 (1880 MHz)	0.32	0.31	1.27	1.95	0.604	
Back face	35	CH 661 (1880 MHz)	0.252	N/M <sup>1</sup>	0.46	1.95	0.491	
Left edge	35	CH 661 (1880 MHz)	N/M <sup>2</sup>					
Right edge	35	CH 661 (1880 MHz)	0.162	N/M <sup>1</sup>	0.46	1.95	0.316	
Top edge	35	CH 661 (1880 MHz)	0.25	N/M <sup>1</sup>	-1.14	1.95	0.499	
Bottom edge	35	CH 661 (1880 MHz)	0.0241	N/M <sup>1</sup>	1.51	1.95	0.047	
Front face	35	CH 512 (1850.2 MHz)	0.311	0.311	0.69	2.138	0.665	
Front face	35	CH 810 (1909.8 MHz)	0.337	0.328	1.04	2.042	0.670	2

1 and 2: See Remarks and Comments

Testing of GPRS EDGE mode is not required according to test reductions mentioned in FCC OET KDB 941225 D01 3G SAR Procedures, paragraph “5. GSM, GPRS and EDGE”

#### 5.4. Results for WCDMA Band II

Position	Dist (mm)	Channel (Frequency)	Estimated SAR 1-g (W/kg)	SAR 1-g (W/kg)	Power Drift (%)	Scale factor	Reported SAR 1-g (W/kg)	Plot No.	
Front face	35	CH 9400 (1880 MHz)	0.133	0.137	0.69	1.641	0.225		
Back face	35	CH 9400 (1880 MHz)	0.111	N/M <sup>1</sup>	-2.73	1.641	0.192		
Left edge	35	CH 9400 (1880 MHz)	N/M <sup>2</sup>						
Right edge	35	CH 9400 (1880 MHz)	0.0515	N/M <sup>1</sup>	-0.92	1.641	0.086		
Top edge	35	CH 9400 (1880 MHz)	0.100	N/M <sup>1</sup>	1.86	1.641	0.164		
Bottom edge	35	CH 9400 (1880 MHz)	0.011	N/M <sup>1</sup>	3.75	1.641	0.018		
Front face	35	CH 9262 (1852.4 MHz)	0.16	0.162	-0.34	1.675	0.273	3	
Front face	35	CH 9538 (1907.6 MHz)	0.122	0.122	2.21	1.585	0.193		

1 and 2: See Remarks and Comments

Testing of HSDPA/HSPA/HSPA+/DC-HSPA modes are not required according to paragraph "2.1 3G SAR test reduction procedure" mentioned in FCC OET KDB 941225 D01 3G SAR Procedures.

#### 5.5. Results for WCDMA Band V

Position	Dist (mm)	Channel (Frequency)	Estimated SAR 1-g (W/kg)	SAR 1-g (W/kg)	Power Drift (%)	Scale factor	Reported SAR 1-g (W/kg)	Plot No.	
Front face	35	CH 4183 (836.6 MHz)	0.200	0.206	-0.12	1.663	0.343	4	
Back face	35	CH 4183 (836.6 MHz)	0.144	N/M <sup>1</sup>	-0.12	1.663	0.24		
Left edge	35	CH 4183 (836.6 MHz)	N/M <sup>2</sup>						
Right edge	35	CH 4183 (836.6 MHz)	0.0129	N/M <sup>1</sup>	2.68	1.663	0.021		
Top edge	35	CH 4183 (836.6 MHz)	0.129	N/M <sup>1</sup>	-1.60	1.663	0.222		
Bottom edge	35	CH 4183 (836.6 MHz)	0.0426	N/M <sup>1</sup>	1.51	1.663	0.071		
Front face	35	CH 4132 (826.4 MHz)	0.190	0.19	-2.05	1.722	0.341		
Front face	35	CH 4233 (846.6 MHz)	0.174	0.157	-0.69	1.648	0.262		

1 and 2: See Remarks and Comments

Testing of HSDPA/HSPA/HSPA+/DC-HSPA modes are not required according to paragraph "2.1 3G SAR test reduction procedure" mentioned in FCC OET KDB 941225 D01 3G SAR Procedures.

### 5.6. Results for LTE Band 2 (1 Rb, 20 MHz, QPSK)

Position	Dist (mm)	Channel (Frequency)	Estimated SAR 1-g (W/kg)	SAR 1-g (W/kg)	Power Drift (%)	Scale factor	Reported SAR 1-g (W/kg)	Plot No.
Front face	35	CH 18700 (1860 MHz)	0.112	0.113	4.11	1.694	0.191	
Back face	35	CH 18700 (1860 MHz)	0.0897	N/M <sup>1</sup>	-2.95	1.694	0.161	
Left edge	35	CH 18700 (1860 MHz)	N/M <sup>2</sup>					
Right edge	35	CH 18700 (1860 MHz)	0.0519	N/M <sup>1</sup>	-0.34	1.694	0.089	
Top edge	35	CH 18700 (1860 MHz)	0.0857	N/M <sup>1</sup>	1.39	1.694	0.145	
Bottom edge	35	CH 18700 (1860 MHz)	0.00734	N/M <sup>1</sup>	2.57	1.694	0.012	
Front face	35	CH 18900 (1880 MHz)	0.124	0.125	1.39	1.702	0.213	
Front face	35	CH 19100 (1900 MHz)	0.128	0.128	0.93	1.734	0.222	5

1 and 2: See Remarks and Comments

### 5.7. Results for LTE Band 2 (50% Rb, 20 MHz, QPSK)

Position	Dist (mm)	Channel (Frequency)	Estimated SAR 1-g (W/kg)	SAR 1-g (W/kg)	Power Drift (%)	Scale factor	Reported SAR 1-g (W/kg)	Plot No.
Front face	35	CH 18700 (1860 MHz)	0.097	0.1	2.21	1.995	0.2	

Testing of additional LTE channels for 50% RB and 100% RB modes is not required due to the SAR test procedures mentioned in FCC OET KDB 941225 D05 – SAR for LTE Devices v02r05.

### 5.8. Results for LTE Band 4 (1 Rb, 20 MHz, QPSK)

Position	Dist (mm)	Channel (Frequency)	Estimated SAR 1-g (W/kg)	SAR 1-g (W/kg)	Power Drift (%)	Scale factor	Reported SAR 1-g (W/kg)	Plot No.
Front face	35	CH 20050 (1720 MHz)	0.115	0.112	-0.23	1.603	0.18	
Back face	35	CH 20050 (1720 MHz)	0.0857	N/M <sup>1</sup>	1.62	1.603	0.137	
Left edge	35	CH 20050 (1720 MHz)	N/M <sup>2</sup>					
Right edge	35	CH 20050 (1720 MHz)	0.0369	N/M <sup>1</sup>	1.04	1.603	0.059	
Top edge	35	CH 20050 (1720 MHz)	0.063	N/M <sup>1</sup>	0.69	1.603	0.101	
Bottom edge	35	CH 20050 (1720 MHz)	0.0116	N/M <sup>1</sup>	2.57	1.603	0.019	
Front face	35	CH 20175 (1732.5 MHz)	0.118	0.119	2.80	1.66	0.197	
Front face	35	CH 20300 (1745 MHz)	0.122	0.123	1.27	1.702	0.209	6

1 and 2: See Remarks and Comments

### 5.9. Results for LTE Band 4 (50% Rb, 20 MHz, QPSK)

Position	Dist (mm)	Channel (Frequency)	Estimated SAR 1-g (W/kg)	SAR 1-g (W/kg)	Power Drift (%)	Scale factor	Reported SAR 1-g (W/kg)	Plot No.
Back face	35	CH 20050 (1720 MHz)	0.0811	0.0829	0.93	1.644	0.136	

Testing of additional LTE channels for 50% RB and 100% RB modes is not required due to the SAR test procedures mentioned in FCC OET KDB 941225 D05 – SAR for LTE Devices v02r05.



### 5.10. Results for LTE Band 5 (1 Rb, 10 MHz, QPSK)

Position	Dist (mm)	Channel (Frequency)	Estimated SAR 1-g (W/kg)	SAR 1-g (W/kg)	Power Drift (%)	Scale factor	Reported SAR 1-g (W/kg)	Plot No.
Front face	35	CH 20525 (836.5 MHz)	0.116	0.119	0.46	1.936	0.23	
Back face	35	CH 20525 (836.5 MHz)	0.0673	N/M <sup>1</sup>	0.35	1.936	0.13	
Left edge	35	CH 20525 (836.5 MHz)	N/M <sup>2</sup>					
Right edge	35	CH 20525 (836.5 MHz)	0.0106	N/M <sup>1</sup>	-0.46	1.936	0.021	
Top edge	35	CH 20525 (836.5 MHz)	0.0824	N/M <sup>1</sup>	-0.46	1.936	0.161	
Bottom edge	35	CH 20525 (836.5 MHz)	0.0216	N/M <sup>1</sup>	0.81	1.936	0.042	
Front face	35	CH 20450 (829 MHz)	0.112	0.114	0.23	2.075	0.237	7
Front face	35	CH 20600 (844 MHz)	0.113	0.116	1.04	1.977	0.229	

1 and 2: See Remarks and Comments

### 5.11. Results for LTE Band 5 (50% Rb, 10 MHz, QPSK)

Position	Dist (mm)	Channel (Frequency)	Estimated SAR 1-g (W/kg)	SAR 1-g (W/kg)	Power Drift (%)	Scale factor	Reported SAR 1-g (W/kg)	Plot No.
Back face	35	CH 20525 (836.5 MHz)	0.0922	0.093	-1.14	1.866	0.178	

Testing of additional LTE channels for 50% RB and 100% RB modes is not required due to the SAR test procedures mentioned in FCC OET KDB 941225 D05 – SAR for LTE Devices v02r05.

### 5.12. Results for LTE Band 7 (1 Rb, 20 MHz, QPSK)

Position	Dist (mm)	Channel (Frequency)	Estimated SAR 1-g (W/kg)	SAR 1-g (W/kg)	Power Drift (%)	Scale factor	Reported SAR 1-g (W/kg)	Plot No.	
Front face	35	CH 21350 (2560 MHz)	0.121	0.118	-2.95	2.291	0.287	8	
Back face	35	CH 21350 (2560 MHz)	0.095	N/M <sup>1</sup>	2.33	2.291	0.218		
Left edge	35	CH 21350 (2560 MHz)	N/M <sup>2</sup>						
Right edge	35	CH 21350 (2560 MHz)	0.079	N/M <sup>1</sup>	-0.34	2.291	0.182		
Top edge	35	CH 21350 (2560 MHz)	0.086	N/M <sup>1</sup>	-1.83	2.291	0.204		
Bottom edge	35	CH 21350 (2560 MHz)	0.042	N/M <sup>1</sup>	-1.71	2.291	0.1		
Front face	35	CH 20850 (2510 MHz)	0.0807	0.0779	0.69	2.382	0.186		
Front face	35	CH 21100 (2535 MHz)	0.0786	0.0789	2.33	2.41	0.19		

1 and 2: See Remarks and Comments

### 5.13. Results for LTE Band 7 (50% Rb, 20 MHz, QPSK)

Position	Dist (mm)	Channel (Frequency)	Estimated SAR 1-g (W/kg)	SAR 1-g (W/kg)	Power Drift (%)	Scale factor	Reported SAR 1-g (W/kg)	Plot No.
Front face	35	CH 21350 (2560 MHz)	0.0789	0.0757	1.86	2.382	0.18	

Testing of additional LTE channels for 50% RB and 100% RB modes is not required due to the SAR test procedures mentioned in FCC OET KDB 941225 D05 – SAR for LTE Devices v02r05.

#### 5.14. Results for LTE Band 12 (1 Rb, 10 MHz, QPSK)

Position	Dist (mm)	Channel (Frequency)	Estimated SAR 1-g (W/kg)	SAR 1-g (W/kg)	Power Drift (%)	Scale factor	Reported SAR 1-g (W/kg)	Plot No.
Front face	35	CH 23095 (707.5 MHz)	0.233	0.239	0.58	1.977	0.472	9
Back face	35	CH 23095 (707.5 MHz)	0.099	N/M <sup>1</sup>	0.58	1.977	0.196	
Left edge	35	CH 23095 (707.5 MHz)	N/M <sup>2</sup>					
Right edge	35	CH 23095 (707.5 MHz)	0.0236	N/M <sup>1</sup>	-0.57	1.977	0.047	
Top edge	35	CH 23095 (707.5 MHz)	0.0962	N/M <sup>1</sup>	-1.03	1.977	0.194	
Bottom edge	35	CH 23095 (707.5 MHz)	0.0378	N/M <sup>1</sup>	-1.60	1.977	0.077	

1 and 2: See Remarks and Comments

#### 5.15. Results for LTE Band 12 (50% Rb, 10 MHz, QPSK)

Position	Dist (mm)	Channel (Frequency)	Estimated SAR 1-g (W/kg)	SAR 1-g (W/kg)	Power Drift (%)	Scale factor	Reported SAR 1-g (W/kg)	Plot No.
Back face	35	CH 23095 (707.5 MHz)	0.168	0.171	0.81	2.084	0.356	

Testing of additional LTE channels for 50% RB and 100% RB modes is not required due to the SAR test procedures mentioned in FCC OET KDB 941225 D05 – SAR for LTE Devices v02r05.

#### 5.16. Results for LTE Band 17 (1 Rb, 10 MHz, QPSK)

SAR for LTE Band 17 has not been measured because it is covered by LTE Band 12 due to overlapping frequency range ((LTE Band 17 frequency range: 704 – 716 MHz, LTE Band 12 frequency range: 699 – 716 MHz) and same maximum tune-up and channel bandwidth.

#### 5.17. Variability results.

According to KDB 865664 D01 SAR Measurement 100 MHz to 6 GHz, paragraph “2.8.1. SAR measurement variability”, repeated measurements are required only when the measured SAR is  $\geq 0.80$  W/kg, using the highest measured SAR configuration for that tissue-equivalent medium.

## Appendix C: Measurement Reports

**GPRS 850 MHz 4 slots – Front Face, d=35 mm – Lowest Channel – Plot N°1**

**Test Laboratory: DEKRA Testing and Certification, S.A.U; Date: 2019-04-16**

**DUT: HD MY20 NA; Type: TCU; Serial: IMEI:353042100013858**

Communication System: UID 10028 - DAC, GPRS-FDD (TDMA, GMSK, TN 0-1-2-3); Frequency: 824.2 MHz; Duty Cycle: 1:2.26464

Medium parameters used:  $f = 825 \text{ MHz}$ ;  $\sigma = 0.95 \text{ S/m}$ ;  $\epsilon_r = 55.16$ ;  $\rho = 1000 \text{ kg/m}^3$

Phantom section: Flat Section

DASY5 Configuration:

- Probe: EX3DV4 - SN7461; ConvF(9.78, 9.78, 9.78); Calibrated: 2018-06-25;
- Sensor-Surface: 3mm (Mechanical Surface Detection (Locations From Previous Scan Used)), Sensor-Surface: 4mm (Mechanical Surface Detection)
- Electronics: DAE4 Sn669; Calibrated: 2018-06-18
- Phantom: Flat Phantom ELI4.0; Type: QDOVA001BA; Serial: SN:1060
- Measurement SW: DASY52, Version 52.8 (8); SEMCAD X Version 14.6.10 (7331)

**Flat Phantom, Faces, d=35mm/GPRS 850, 4 slots, Low CH, Front face/Area Scan (91x131x1):**

Interpolated grid:  $dx=1.500 \text{ mm}$ ,  $dy=1.500 \text{ mm}$

Maximum value of SAR (interpolated) = 0.791 W/kg

**Flat Phantom, Faces, d=35mm/GPRS 850, 4 slots, Low CH, Front face/Zoom Scan (5x5x7)/Cube 0:**

Measurement grid:  $dx=8\text{mm}$ ,  $dy=8\text{mm}$ ,  $dz=5\text{mm}$

Reference Value = 25.75 V/m; Power Drift = 0.01 dB

Peak SAR (extrapolated) = 0.869 W/kg

**SAR(1 g) = 0.706 W/kg; SAR(10 g) = 0.546 W/kg** (SAR corrected for target medium)

Maximum value of SAR (measured) = 0.724 W/kg

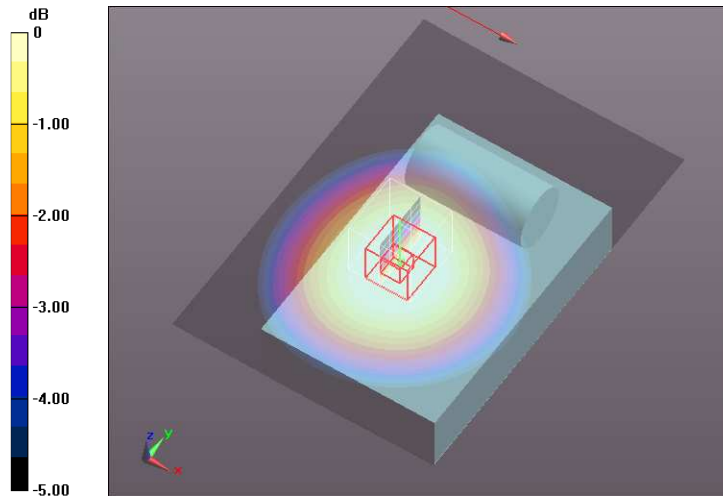

0 dB = 0.724 W/kg = -1.40 dBW/kg

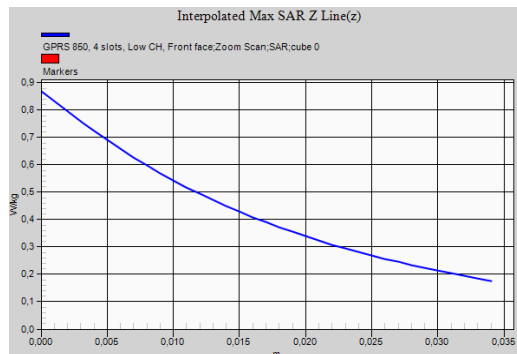

**GPRS 1900 MHz 4 slots – Front Face, d=35 mm – Highest Channel – Plot Nº2**

**Test Laboratory: DEKRA Testing and Certification, S.A.U; Date: 2019-04-24**

**DUT: HD MY20 NA; Type: TCU; Serial: IMEI:353042100013858**

Communication System: UID 10028 - DAC, GPRS-FDD (TDMA, GMSK, TN 0-1-2-3); Frequency: 1909.8 MHz;  
 Duty Cycle: 1:2.26464

Medium parameters used:  $f = 1910$  MHz;  $\sigma = 1.55$  S/m;  $\epsilon_r = 52.19$ ;  $\rho = 1000$  kg/m<sup>3</sup>

Phantom section: Flat Section

DASY5 Configuration:

- Probe: EX3DV4 - SN7461; ConvF(8.24, 8.24, 8.24); Calibrated: 2018-06-25;
- Sensor-Surface: 3mm (Mechanical Surface Detection (Locations From Previous Scan Used)), Sensor-Surface: 4mm (Mechanical Surface Detection)
- Electronics: DAE4 Sn669; Calibrated: 2018-06-18
- Phantom: Flat Phantom ELI4.0; Type: QDOVA001BA; Serial: SN:1060
- Measurement SW: DASY52, Version 52.8 (8); SEMCAD X Version 14.6.10 (7331)

**Flat Phantom, Faces, d=35mm/GPRS 1900 4 slots, High CH, Front face/Area Scan (91x131x1):**

Interpolated grid: dx=1.500 mm, dy=1.500 mm

Maximum value of SAR (interpolated) = 0.402 W/kg

**Flat Phantom, Faces, d=35mm/GPRS 1900 4 slots, High CH, Front face/Zoom Scan (5x5x7)/Cube 0:**

Measurement grid: dx=8mm, dy=8mm, dz=5mm

Reference Value = 8.700 V/m; Power Drift = 0.09 dB

Peak SAR (extrapolated) = 0.520 W/kg

**SAR(1 g) = 0.328 W/kg; SAR(10 g) = 0.206 W/kg** (SAR corrected for target medium)

Maximum value of SAR (measured) = 0.353 W/kg

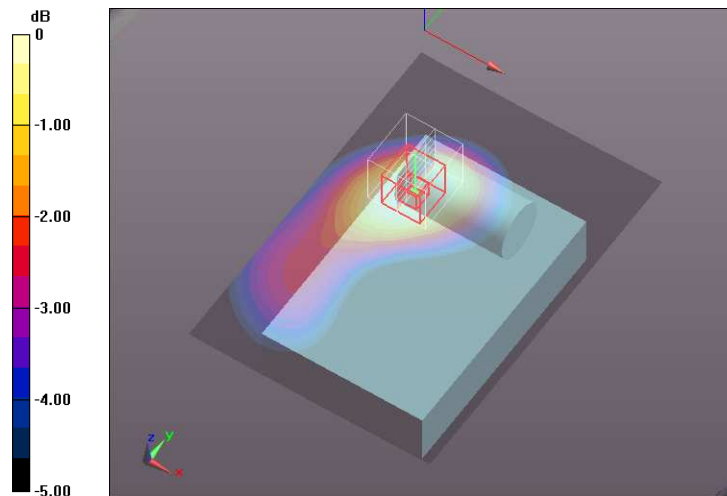

0 dB = 0.353 W/kg = -4.52 dBW/kg

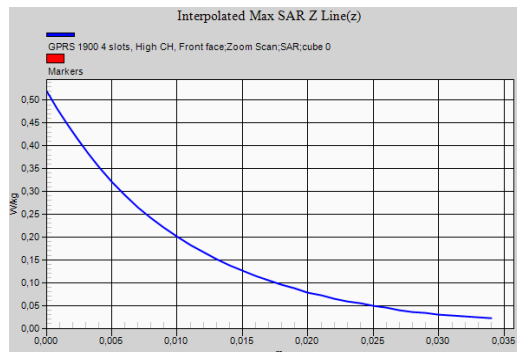

**WCDMA Band II – Front Face, d=35 mm – Lowest Channel – Plot N°3**

**Test Laboratory: DEKRA Testing and Certification, S.A.U; Date: 2019-04-24**

**DUT: HD MY20 NA; Type: TCU; Serial: IMEI:353042100013858**

Communication System: UID 10011 - CAB, UMTS-FDD (WCDMA); Frequency: 1852.4 MHz; Duty Cycle: 1:1.95434

Medium parameters used (interpolated):  $f = 1852.4$  MHz;  $\sigma = 1.5$  S/m;  $\epsilon_r = 52.158$ ;  $\rho = 1000$  kg/m<sup>3</sup>

Phantom section: Flat Section

DASY5 Configuration:

- Probe: EX3DV4 - SN7461; ConvF(8.24, 8.24, 8.24); Calibrated: 2018-06-25;
- Sensor-Surface: 3mm (Mechanical Surface Detection), Sensor-Surface: 4mm (Mechanical Surface Detection)
- Electronics: DAE4 Sn669; Calibrated: 2018-06-18
- Phantom: Flat Phantom ELI4.0; Type: QDOVA001BA; Serial: SN:1060
- Measurement SW: DASY52, Version 52.8 (8); SEMCAD X Version 14.6.10 (7331)

**Flat Phantom, Faces, d=35mm/WCDMA II, Low CH, Front face/Area Scan (91x131x1):**

Interpolated grid: dx=1.500 mm, dy=1.500 mm

[Info: Interpolated medium parameters used for SAR evaluation.](#)

Maximum value of SAR (interpolated) = 0.190 W/kg

**Flat Phantom, Faces, d=35mm/WCDMA II, Low CH, Front face/Zoom Scan (5x5x7)/Cube 0:**

Measurement grid: dx=8mm, dy=8mm, dz=5mm

Reference Value = 7.094 V/m; Power Drift = -0.03 dB

Peak SAR (extrapolated) = 0.247 W/kg

**SAR(1 g) = 0.162 W/kg; SAR(10 g) = 0.102 W/kg** (SAR corrected for target medium)

[Info: Interpolated medium parameters used for SAR evaluation.](#)

Maximum value of SAR (measured) = 0.174 W/kg

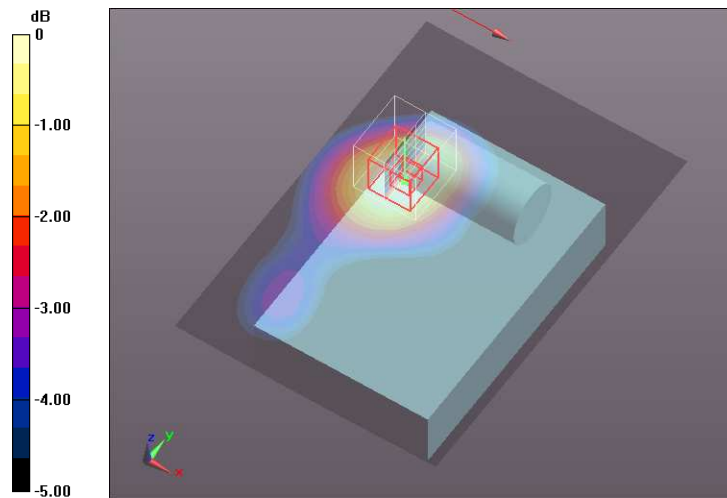

0 dB = 0.174 W/kg = -7.59 dBW/kg

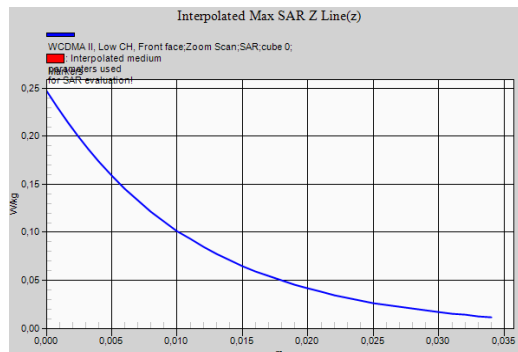

**WCDMA Band V – Front Face, d=35 mm – Middle Channel – Plot N°4**

**Test Laboratory: DEKRA Testing and Certification, S.A.U; Date: 2019-04-15**

**DUT: HD MY20 NA; Type: TCU; Serial: IMEI:353042100013858**

Communication System: UID 10011 - CAB, UMTS-FDD (WCDMA); Frequency: 836.6 MHz; Duty Cycle: 1:1.95434

Medium parameters used (interpolated):  $f = 836.6$  MHz;  $\sigma = 0.963$  S/m;  $\epsilon_r = 55.008$ ;  $\rho = 1000$  kg/m<sup>3</sup>

Phantom section: Flat Section

DASY5 Configuration:

- Probe: EX3DV4 - SN7461; ConvF(9.78, 9.78, 9.78); Calibrated: 2018-06-25;
- Sensor-Surface: 3mm (Mechanical Surface Detection), Sensor-Surface: 4mm (Mechanical Surface Detection)
- Electronics: DAE4 Sn669; Calibrated: 2018-06-18
- Phantom: Flat Phantom ELI4.0; Type: QDOVA001BA; Serial: SN:1060
- Measurement SW: DASY52, Version 52.8 (8); SEMCAD X Version 14.6.10 (7331)

**Flat Phantom, Faces, d=35mm/WCDMA V, Mid CH, Front face/Area Scan (91x131x1):**

Interpolated grid: dx=1.500 mm, dy=1.500 mm

[Info: Interpolated medium parameters used for SAR evaluation.](#)

Maximum value of SAR (interpolated) = 0.225 W/kg

**Flat Phantom, Faces, d=35mm/WCDMA V, Mid CH, Front face/Zoom Scan (5x5x7)/Cube 0:**

Measurement grid: dx=8mm, dy=8mm, dz=5mm

Reference Value = 15.05 V/m; Power Drift = -0.01 dB

Peak SAR (extrapolated) = 0.256 W/kg

**SAR(1 g) = 0.206 W/kg; SAR(10 g) = 0.158 W/kg** (SAR corrected for target medium)

[Info: Interpolated medium parameters used for SAR evaluation.](#)

Maximum value of SAR (measured) = 0.214 W/kg

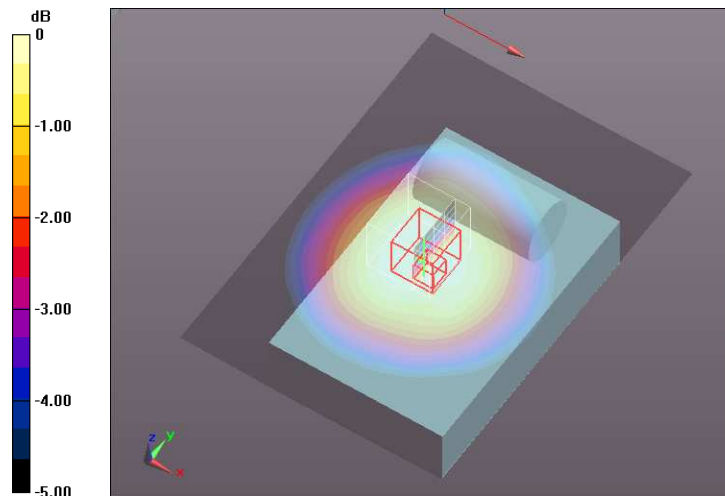

0 dB = 0.214 W/kg = -6.70 dBW/kg

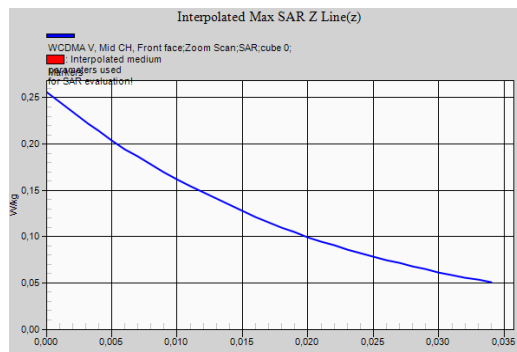



**LTE Band 2 – Front Face, d=35 mm – Highest Channel – Plot N°5**

**Test Laboratory: DEKRA Testing and Certification, S.A.U; Date: 2019-04-24**

**DUT: HD MY20 NA; Type: TCU; Serial: IMEI:353042100013858**

Communication System: UID 10169 - CAD, LTE-FDD (SC-FDMA, 1 RB, 20 MHz, QPSK); Frequency: 1899.9 MHz; Duty Cycle: 1:3.74111

Medium parameters used:  $f = 1900$  MHz;  $\sigma = 1.55$  S/m;  $\epsilon_r = 52.25$ ;  $\rho = 1000$  kg/m<sup>3</sup>

Phantom section: Flat Section

DASY5 Configuration:

- Probe: EX3DV4 - SN7461; ConvF(8.24, 8.24, 8.24); Calibrated: 2018-06-25;
- Sensor-Surface: 3mm (Mechanical Surface Detection (Locations From Previous Scan Used)), Sensor-Surface: 4mm (Mechanical Surface Detection)
- Electronics: DAE4 Sn669; Calibrated: 2018-06-18
- Phantom: Flat Phantom ELI4.0; Type: QDOVA001BA; Serial: SN:1060
- Measurement SW: DASY52, Version 52.8 (8); SEMCAD X Version 14.6.10 (7331)

**Flat Phantom, Faces, d=35mm/LTE 2, 1 RB High, High CH, Front face/Area Scan (91x131x1):**

Interpolated grid: dx=1.500 mm, dy=1.500 mm

Maximum value of SAR (interpolated) = 0.152 W/kg

**Flat Phantom, Faces, d=35mm/LTE 2, 1 RB High, High CH, Front face/Zoom Scan (5x5x7)/Cube 0:**

Measurement grid: dx=8mm, dy=8mm, dz=5mm

Reference Value = 5.673 V/m; Power Drift = 0.08 dB

Peak SAR (extrapolated) = 0.202 W/kg

**SAR(1 g) = 0.128 W/kg; SAR(10 g) = 0.080 W/kg** (SAR corrected for target medium)

Maximum value of SAR (measured) = 0.138 W/kg

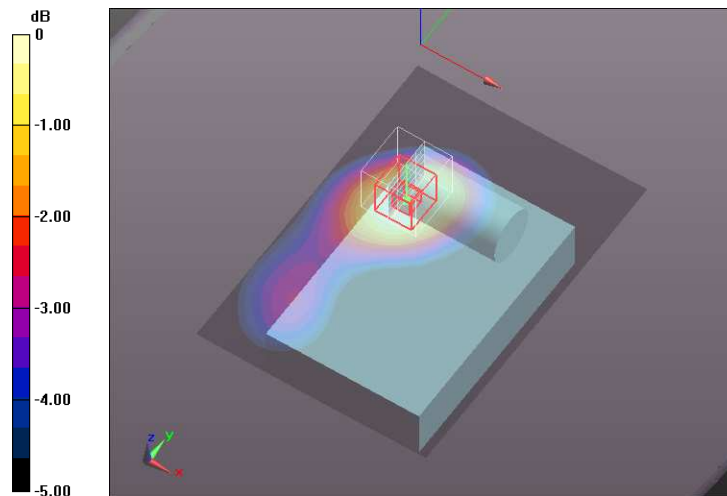

0 dB = 0.138 W/kg = -8.60 dBW/kg

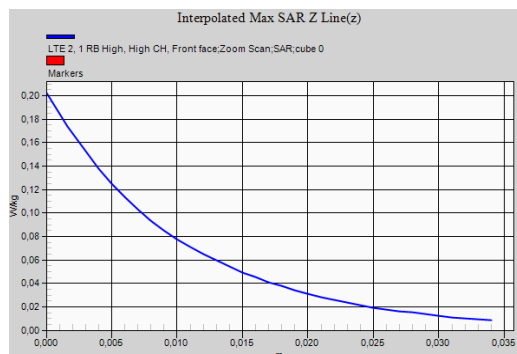

**LTE Band 4 – Front Face, d=35 mm – Middle Channel – Plot N°6**

**Test Laboratory: DEKRA Testing and Certification, S.A.U; Date: 2019-04-23**

**DUT: HD MY20 NA; Type: TCU; Serial: IMEI:353042100013858**

Communication System: UID 10169 - CAD, LTE-FDD (SC-FDMA, 1 RB, 20 MHz, QPSK); Frequency: 1732.5 MHz; Duty Cycle: 1:3.74111

Medium parameters used (interpolated):  $f = 1732.5$  MHz;  $\sigma = 1.502$  S/m;  $\epsilon_r = 52.953$ ;  $\rho = 1000$  kg/m<sup>3</sup>

Phantom section: Flat Section

DASY5 Configuration:

- Probe: EX3DV4 - SN7461; ConvF(8.24, 8.24, 8.24); Calibrated: 2018-06-25;
- Sensor-Surface: 3mm (Mechanical Surface Detection (Locations From Previous Scan Used)), Sensor-Surface: 4mm (Mechanical Surface Detection)
- Electronics: DAE4 Sn669; Calibrated: 2018-06-18
- Phantom: Flat Phantom ELI4.0; Type: QDOVA001BA; Serial: SN:1060
- Measurement SW: DASY52, Version 52.8 (8); SEMCAD X Version 14.6.10 (7331)

**Flat Phantom, Faces, d=35mm/LTE 4, 1 RB High, Mid CH, Front face/Area Scan (91x131x1):**

Interpolated grid: dx=1.500 mm, dy=1.500 mm

[Info: Interpolated medium parameters used for SAR evaluation.](#)

Maximum value of SAR (interpolated) = 0.139 W/kg

**Flat Phantom, Faces, d=35mm/LTE 4, 1 RB High, Mid CH, Front face/Zoom Scan (5x5x7)/Cube 0:**

Measurement grid: dx=8mm, dy=8mm, dz=5mm

Reference Value = 4.619 V/m; Power Drift = 0.24 dB

Peak SAR (extrapolated) = 0.178 W/kg

**SAR(1 g) = 0.119 W/kg; SAR(10 g) = 0.077 W/kg** (SAR corrected for target medium)

[Info: Interpolated medium parameters used for SAR evaluation.](#)

Maximum value of SAR (measured) = 0.127 W/kg

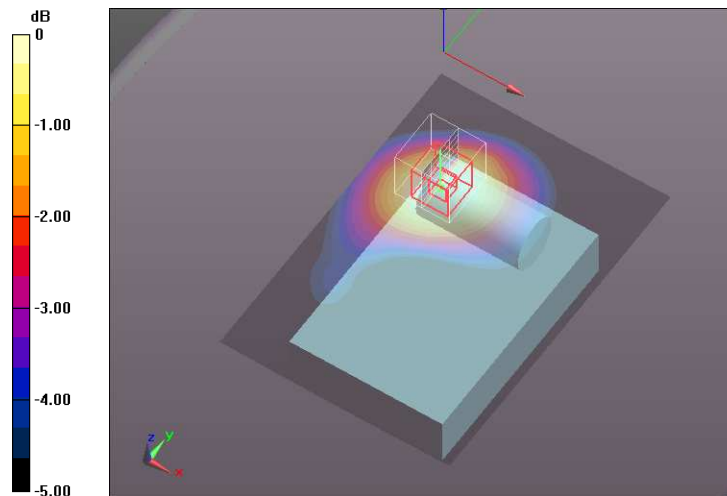

0 dB = 0.127 W/kg = -8.96 dBW/kg

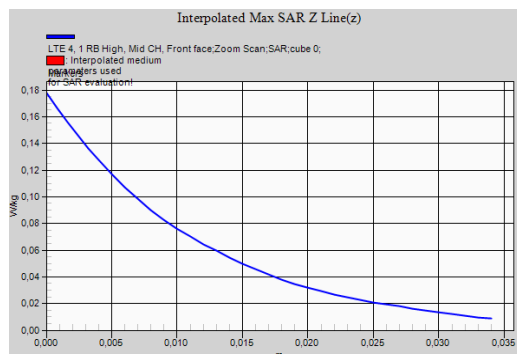

**LTE Band 5 – Front Face, d=35 mm – Lowest Channel – Plot N°7**

**Test Laboratory: DEKRA Testing and Certification, S.A.U; Date: 2019-04-16**

**DUT: HD MY20 NA; Type: TCU; Serial: IMEI:353042100013858**

Communication System: UID 10175 - CAE, LTE-FDD (SC-FDMA, 1 RB, 10 MHz, QPSK); Frequency: 829 MHz; Duty Cycle: 1:3.7325

Medium parameters used (interpolated):  $f = 829$  MHz;  $\sigma = 0.958$  S/m;  $\epsilon_r = 55.08$ ;  $\rho = 1000$  kg/m<sup>3</sup>

Phantom section: Flat Section

DASY5 Configuration:

- Probe: EX3DV4 - SN7461; ConvF(9.78, 9.78, 9.78); Calibrated: 2018-06-25;
- Sensor-Surface: 3mm (Mechanical Surface Detection (Locations From Previous Scan Used)), Sensor-Surface: 4mm (Mechanical Surface Detection)
- Electronics: DAE4 Sn669; Calibrated: 2018-06-18
- Phantom: Flat Phantom ELI4.0; Type: QDOVA001BA; Serial: SN:1060
- Measurement SW: DASY52, Version 52.8 (8); SEMCAD X Version 14.6.10 (7331)

**Flat Phantom, Faces, d=35mm/LTE 5, 1 RB Mid, Low CH, Front face/Area Scan (91x131x1):**

Interpolated grid: dx=1.500 mm, dy=1.500 mm

[Info: Interpolated medium parameters used for SAR evaluation.](#)

Maximum value of SAR (interpolated) = 0.125 W/kg

**Flat Phantom, Faces, d=35mm/LTE 5, 1 RB Mid, Low CH, Front face/Zoom Scan (5x5x7)/Cube 0:**

Measurement grid: dx=8mm, dy=8mm, dz=5mm

Reference Value = 11.03 V/m; Power Drift = 0.02 dB

Peak SAR (extrapolated) = 0.143 W/kg

**SAR(1 g) = 0.114 W/kg; SAR(10 g) = 0.088 W/kg** (SAR corrected for target medium)

[Info: Interpolated medium parameters used for SAR evaluation.](#)

Maximum value of SAR (measured) = 0.118 W/kg

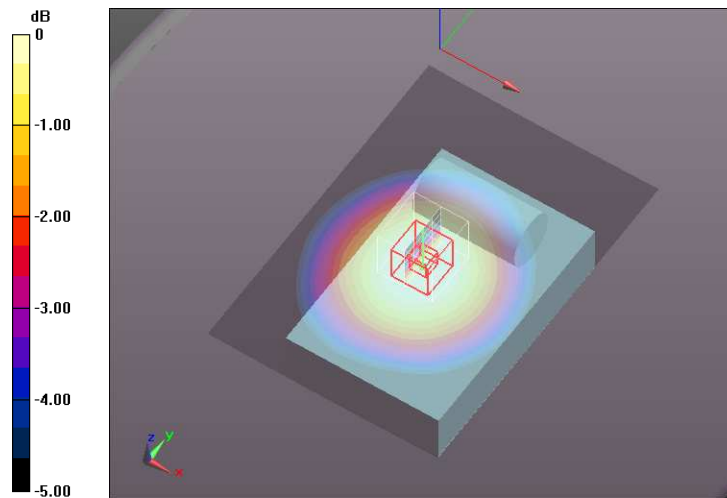

0 dB = 0.118 W/kg = -9.28 dBW/kg

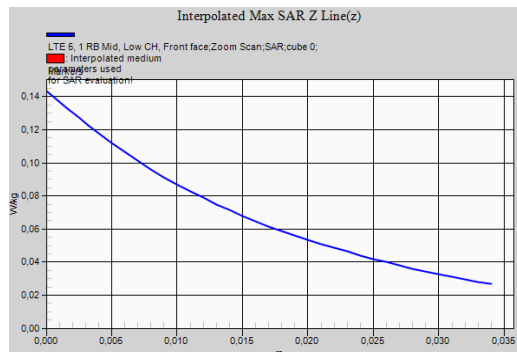

**LTE Band 7 – Front Face, d=35 mm – Highest Channel – Plot N°8**

**Test Laboratory: DEKRA Testing and Certification, S.A.U; Date: 2019-04-23**

**DUT: HD MY20 NA; Type: TCU; Serial: IMEI:353042100013858**

Communication System: UID 10169 - CAD, LTE-FDD (SC-FDMA, 1 RB, 20 MHz, QPSK); Frequency: 2559.9 MHz;  
 Duty Cycle: 1:3.74111

Medium parameters used:  $f = 2560$  MHz;  $\sigma = 2.12$  S/m;  $\epsilon_r = 52.54$ ;  $\rho = 1000$  kg/m<sup>3</sup>

Phantom section: Flat Section

DASY5 Configuration:

- Probe: EX3DV4 - SN7461; ConvF(7.52, 7.52, 7.52); Calibrated: 2018-06-25;
- Sensor-Surface: 3mm (Mechanical Surface Detection (Locations From Previous Scan Used)), Sensor-Surface: 4mm (Mechanical Surface Detection)
- Electronics: DAE4 Sn669; Calibrated: 2018-06-18
- Phantom: Flat Phantom ELI4.0; Type: QDOVA001BA; Serial: SN:1060
- Measurement SW: DASY52, Version 52.8 (8); SEMCAD X Version 14.6.10 (7331)

**Flat Phantom, Faces, d=35mm/LTE 7, 1 RB Mid, High CH, Front face/Area Scan (111x161x1):**

Interpolated grid: dx=1.200 mm, dy=1.200 mm

Maximum value of SAR (interpolated) = 0.148 W/kg

**Flat Phantom, Faces, d=35mm/LTE 7, 1 RB Mid, High CH, Front face/Zoom Scan (8x7x7)/Cube 0:**

Measurement grid: dx=5mm, dy=5mm, dz=5mm

Reference Value = 4.597 V/m; Power Drift = -0.26 dB

Peak SAR (extrapolated) = 0.212 W/kg

**SAR(1 g) = 0.118 W/kg; SAR(10 g) = 0.066 W/kg** (SAR corrected for target medium)

Maximum value of SAR (measured) = 0.127 W/kg

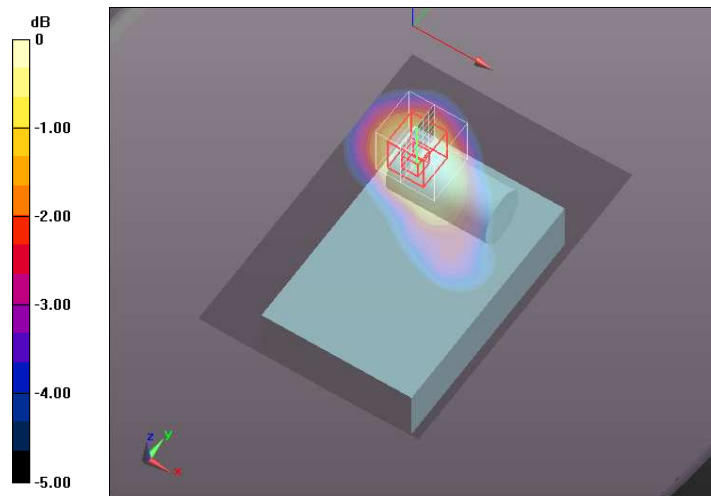

0 dB = 0.127 W/kg = -8.96 dBW/kg

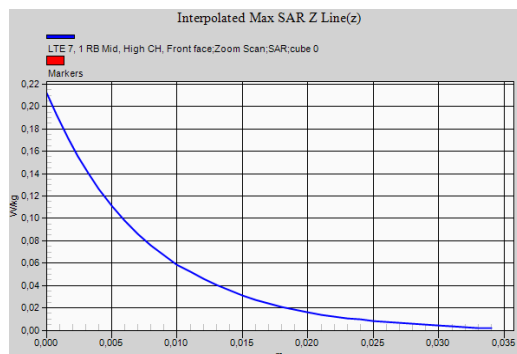

**LTE Band 12 – Front Face, d=35 mm – Middle Channel – Plot N°9**

**Test Laboratory: DEKRA Testing and Certification, S.A.U; Date: 2019-04-22**

**DUT: HD MY20 NA; Type: TCU; Serial: IMEI:353042100013858**

Communication System: UID 10175 - CAE, LTE-FDD (SC-FDMA, 1 RB, 10 MHz, QPSK); Frequency: 707.5 MHz; Duty Cycle: 1:3.7325

Medium parameters used (interpolated):  $f = 707.5$  MHz;  $\sigma = 0.92$  S/m;  $\epsilon_r = 55.54$ ;  $\rho = 1000$  kg/m<sup>3</sup>

Phantom section: Flat Section

DASY5 Configuration:

- Probe: EX3DV4 - SN7461; ConvF(10.11, 10.11, 10.11); Calibrated: 2018-06-25;
- Sensor-Surface: 3mm (Mechanical Surface Detection (Locations From Previous Scan Used)), Sensor-Surface: 4mm (Mechanical Surface Detection)
- Electronics: DAE4 Sn669; Calibrated: 2018-06-18
- Phantom: Flat Phantom ELI4.0; Type: QDOVA001BA; Serial: SN:1060
- Measurement SW: DASY52, Version 52.8 (8); SEMCAD X Version 14.6.10 (7331)

**Flat Phantom, Faces, d=35mm/LTE 12, 1 RB Mid, Mid CH, Front face/Area Scan (91x131x1):**

Interpolated grid: dx=1.500 mm, dy=1.500 mm

[Info: Interpolated medium parameters used for SAR evaluation.](#)

Maximum value of SAR (interpolated) = 0.254 W/kg

**Flat Phantom, Faces, d=35mm/LTE 12, 1 RB Mid, Mid CH, Front face/Zoom Scan (5x5x7)/Cube 0:**

Measurement grid: dx=8mm, dy=8mm, dz=5mm

Reference Value = 15.47 V/m; Power Drift = 0.05 dB

Peak SAR (extrapolated) = 0.291 W/kg

**SAR(1 g) = 0.239 W/kg; SAR(10 g) = 0.184 W/kg** (SAR corrected for target medium)

[Info: Interpolated medium parameters used for SAR evaluation.](#)

Maximum value of SAR (measured) = 0.242 W/kg

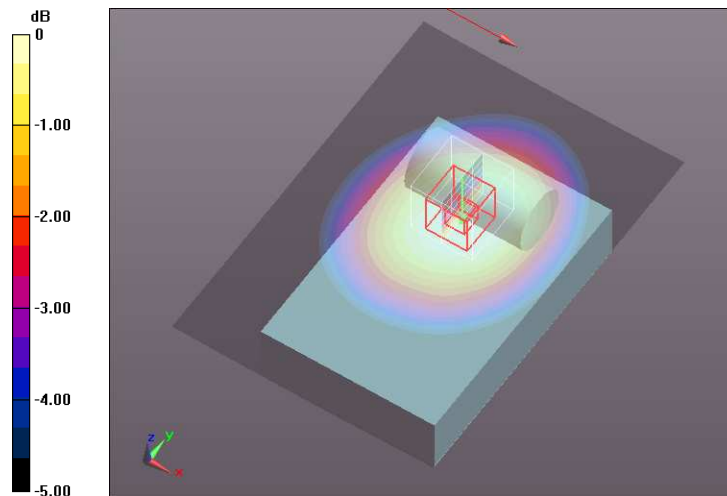

0 dB = 0.242 W/kg = -6.16 dBW/kg

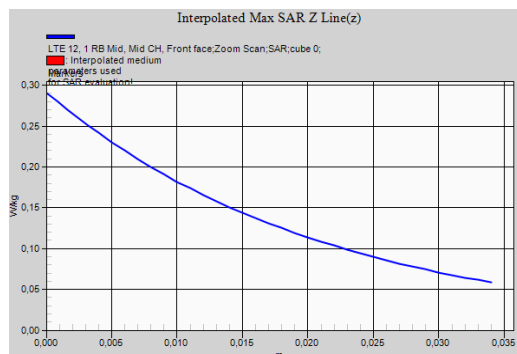

## Appendix D: System Validation Reports

**Validation results in 750 MHz Band for Body TSL**

**Test Laboratory: DEKRA Testing and Certification, S.A.U; Date: 2019-04-22**

**DUT: Dipole 750 MHz D750V3; Type: D750V3; Serial: D750V3 - SN:1036**

Communication System: UID 0, CW (0); Frequency: 750 MHz; Duty Cycle: 1:1

Medium parameters used:  $f = 750 \text{ MHz}$ ;  $\sigma = 0.98 \text{ S/m}$ ;  $\epsilon_r = 54.97$ ;  $\rho = 1000 \text{ kg/m}^3$

Phantom section: Flat Section

DASY5 Configuration:

- Probe: EX3DV4 - SN7461; ConvF(10.11, 10.11, 10.11); Calibrated: 2018-06-25;
- Sensor-Surface: 3mm (Mechanical Surface Detection)
- Electronics: DAE4 Sn669; Calibrated: 2018-06-18
- Phantom: Flat Phantom ELI4.0; Type: QDOVA001BA; Serial: SN:1060
- Measurement SW: DASY52, Version 52.8 (8); SEMCAD X Version 14.6.10 (7331)

**Configuration 750MHz, 2019-04-22/d=15mm, Pin=250 mW/Area Scan (61x91x1):**

Interpolated grid:  $dx=1.500 \text{ mm}$ ,  $dy=1.500 \text{ mm}$

Maximum value of SAR (interpolated) =  $2.53 \text{ W/kg}$

**Configuration 750MHz, 2019-04-22/d=15mm, Pin=250 mW/Zoom Scan (7x7x7)/Cube 0:**

Measurement grid:  $dx=5\text{mm}$ ,  $dy=5\text{mm}$ ,  $dz=5\text{mm}$

Reference Value =  $50.69 \text{ V/m}$ ; Power Drift =  $0.03 \text{ dB}$

Peak SAR (extrapolated) =  $3.16 \text{ W/kg}$

**SAR(1 g) =  $2.14 \text{ W/kg}$ ; SAR(10 g) =  $1.44 \text{ W/kg}$**  (SAR corrected for target medium)

Maximum value of SAR (measured) =  $2.51 \text{ W/kg}$

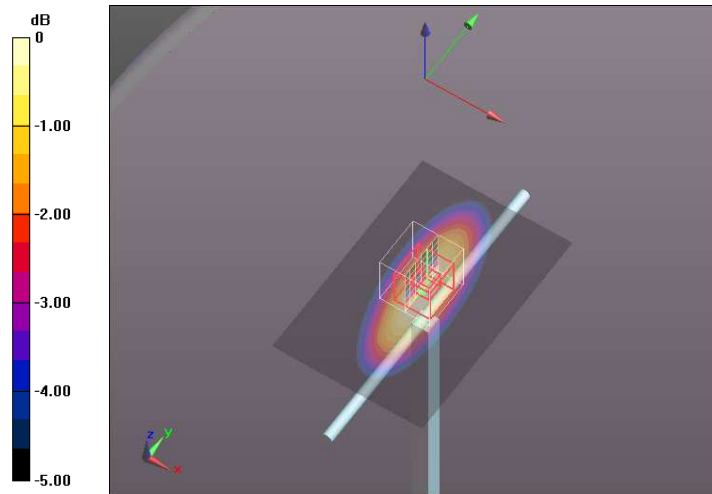

0 dB =  $2.51 \text{ W/kg}$  =  $4.00 \text{ dBW/kg}$

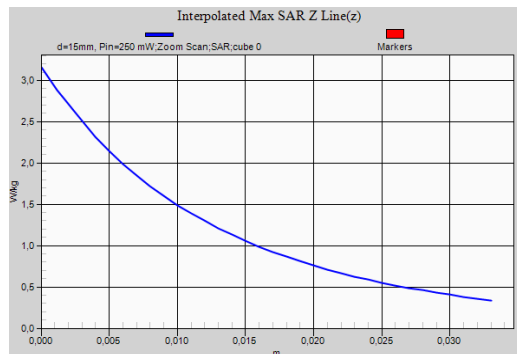

**Validation results in 900 MHz Band for Body TSL**

**Test Laboratory: DEKRA Testing and Certification, S.A.U; Date: 2019-04-15**

**DUT: Dipole 900 MHz D900V2; Type: D900V2; Serial: D900V2 - SN:1d007**

Communication System: UID 0, CW; Frequency: 900 MHz; Duty Cycle: 1:1

Medium parameters used:  $f = 900 \text{ MHz}$ ;  $\sigma = 1.03 \text{ S/m}$ ;  $\epsilon_r = 54.48$ ;  $\rho = 1000 \text{ kg/m}^3$

Phantom section: Flat Section

DASY5 Configuration:

- Probe: EX3DV4 - SN7461; ConvF(9.78, 9.78, 9.78); Calibrated: 2018-06-25;
- Sensor-Surface: 3mm (Mechanical Surface Detection)
- Electronics: DAE4 Sn669; Calibrated: 2018-06-18
- Phantom: Flat Phantom ELI4.0; Type: QDOVA001BA; Serial: SN:1060
- Measurement SW: DASY52, Version 52.8 (8); SEMCAD X Version 14.6.10 (7331)

**Configuration 900MHz, 2019-04-15/d=15mm, Pin=250 mW/Area Scan (61x91x1):**

Interpolated grid:  $dx=1.500 \text{ mm}$ ,  $dy=1.500 \text{ mm}$

Maximum value of SAR (interpolated) =  $3.08 \text{ W/kg}$

**Configuration 900MHz, 2019-04-15/d=15mm, Pin=250 mW/Zoom Scan (7x7x7)/Cube 0:**

Measurement grid:  $dx=5\text{mm}$ ,  $dy=5\text{mm}$ ,  $dz=5\text{mm}$

Reference Value =  $55.13 \text{ V/m}$ ; Power Drift =  $-0.06 \text{ dB}$

Peak SAR (extrapolated) =  $3.89 \text{ W/kg}$

**SAR(1 g) = 2.63 W/kg; SAR(10 g) = 1.71 W/kg** (SAR corrected for target medium)

Maximum value of SAR (measured) =  $3.06 \text{ W/kg}$

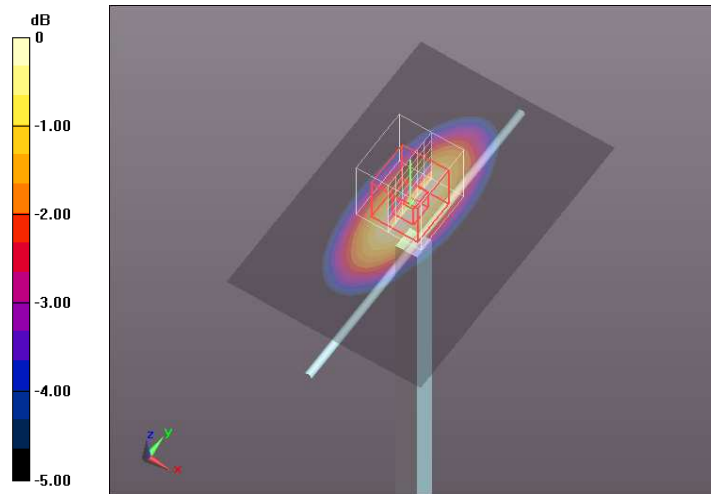

0 dB =  $3.06 \text{ W/kg} = 4.86 \text{ dBW/kg}$

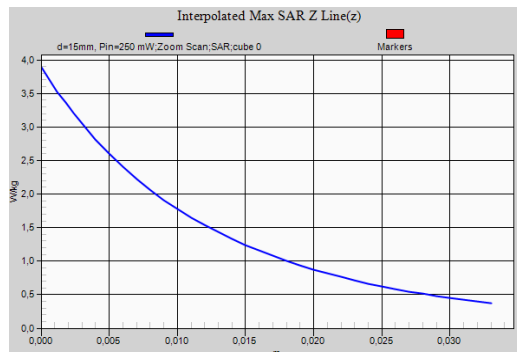



**Validation results in 1800 MHz Band for Body TSL**

**Test Laboratory: DEKRA Testing and Certification, S.A.U; Date: 2019-04-23**

**DUT: Dipole 1800 MHz D1800V2; Type: D1800V2; Serial: D1800V2 - SN:2d099**

Communication System: UID 0, CW (0); Frequency: 1800 MHz; Duty Cycle: 1:1

Medium parameters used:  $f = 1800 \text{ MHz}$ ;  $\sigma = 1.57 \text{ S/m}$ ;  $\epsilon_r = 52.8$ ;  $\rho = 1000 \text{ kg/m}^3$

Phantom section: Flat Section

DASY5 Configuration:

- Probe: EX3DV4 - SN7461; ConvF(8.24, 8.24, 8.24); Calibrated: 2018-06-25;
- Sensor-Surface: 3mm (Mechanical Surface Detection)
- Electronics: DAE4 Sn669; Calibrated: 2018-06-18
- Phantom: Flat Phantom ELI4.0; Type: QDOVA001BA; Serial: SN:1060
- Measurement SW: DASY52, Version 52.8 (8); SEMCAD X Version 14.6.10 (7331)

**Configuration 1800MHz, 2019-04-23/d=10mm, Pin=250 mW/Area Scan (91x91x1):**

Interpolated grid:  $dx=1.000 \text{ mm}$ ,  $dy=1.000 \text{ mm}$

Maximum value of SAR (interpolated) =  $12.6 \text{ W/kg}$

**Configuration 1800MHz, 2019-04-23/d=10mm, Pin=250 mW/Zoom Scan (7x7x7)/Cube 0:**

Measurement grid:  $dx=5\text{mm}$ ,  $dy=5\text{mm}$ ,  $dz=5\text{mm}$

Reference Value =  $89.25 \text{ V/m}$ ; Power Drift =  $0.10 \text{ dB}$

Peak SAR (extrapolated) =  $17.9 \text{ W/kg}$

**SAR(1 g) =  $9.88 \text{ W/kg}$ ; SAR(10 g) =  $5.15 \text{ W/kg}$**  (SAR corrected for target medium)

Maximum value of SAR (measured) =  $12.7 \text{ W/kg}$

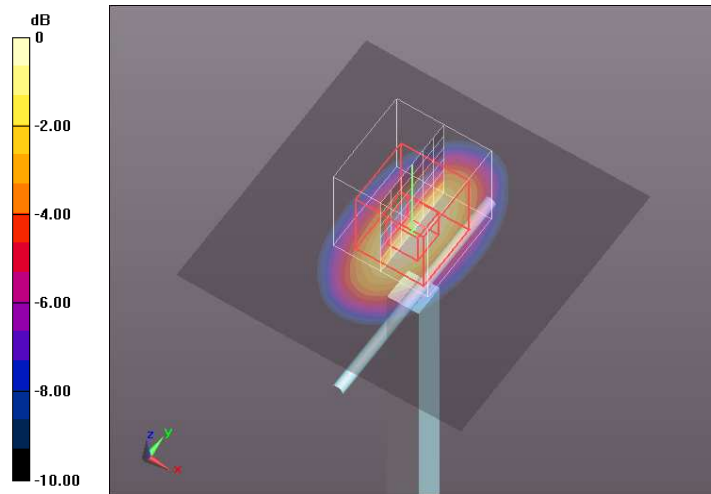

0 dB =  $12.7 \text{ W/kg} = 11.04 \text{ dBW/kg}$

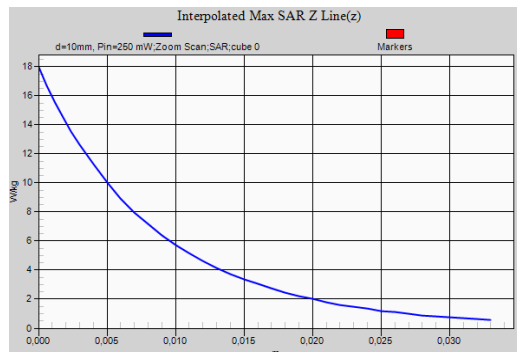

**Validation results in 1800 MHz Band for Body TSL**

**Test Laboratory: DEKRA Testing and Certification, S.A.U; Date: 2019-04-23**

**DUT: Dipole 1800 MHz D1800V2; Type: D1800V2; Serial: D1800V2 - SN:2d099**

Communication System: UID 0, CW (0); Frequency: 1800 MHz; Duty Cycle: 1:1

Medium parameters used:  $f = 1800$  MHz;  $\sigma = 1.47$  S/m;  $\epsilon_r = 52.53$ ;  $\rho = 1000$  kg/m<sup>3</sup>

Phantom section: Flat Section

DASY5 Configuration:

- Probe: EX3DV4 - SN7461; ConvF(8.24, 8.24, 8.24); Calibrated: 2018-06-25;
- Sensor-Surface: 3mm (Mechanical Surface Detection)
- Electronics: DAE4 Sn669; Calibrated: 2018-06-18
- Phantom: Flat Phantom ELI4.0; Type: QDOVA001BA; Serial: SN:1060
- Measurement SW: DASY52, Version 52.8 (8); SEMCAD X Version 14.6.10 (7331)

**Configuration 1800MHz, 2019-04 23/d=10mm, Pin=250 mW/Area Scan (91x91x1):**

Interpolated grid: dx=1.000 mm, dy=1.000 mm

Maximum value of SAR (interpolated) = 12.0 W/kg

**Configuration 1800MHz, 2019-04 23/d=10mm, Pin=250 mW/Zoom Scan (7x7x7)/Cube 0:**

Measurement grid: dx=5mm, dy=5mm, dz=5mm

Reference Value = 89.04 V/m; Power Drift = 0.11 dB

Peak SAR (extrapolated) = 16.9 W/kg

**SAR(1 g) = 9.46 W/kg; SAR(10 g) = 4.89 W/kg** (SAR corrected for target medium)

Maximum value of SAR (measured) = 11.9 W/kg

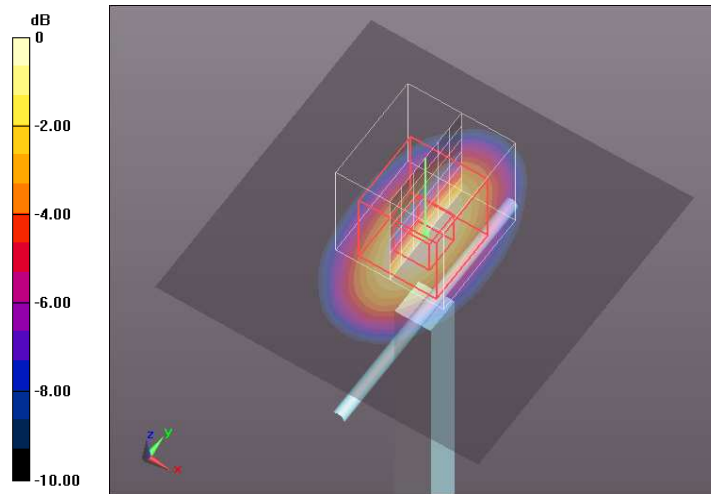

0 dB = 11.9 W/kg = 10.76 dBW/kg

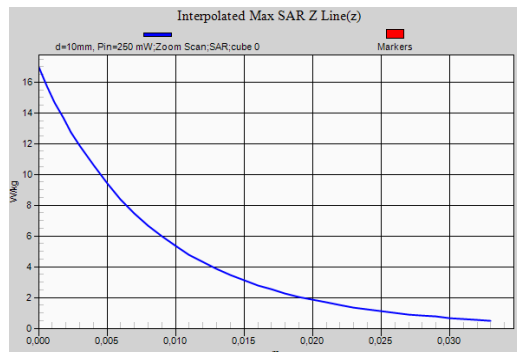

**Validation results in 2450 MHz Band for Body TSL**

**Test Laboratory: DEKRA Testing and Certification, S.A.U; Date: 2019-04-22**

**DUT: Dipole 2600 MHz D2600V2; Type: D2600V2; Serial: D2600V2 - SN:1023**

Communication System: UID 0, CW (0); Frequency: 2600 MHz; Duty Cycle: 1:1  
 Medium parameters used:  $f = 2600$  MHz;  $\sigma = 2.18$  S/m;  $\epsilon_r = 52.46$ ;  $\rho = 1000$  kg/m<sup>3</sup>

Phantom section: Flat Section

DASY5 Configuration:

- Probe: EX3DV4 - SN7461; ConvF(7.52, 7.52, 7.52); Calibrated: 2018-06-25;
- Sensor-Surface: 3mm (Mechanical Surface Detection (Locations From Previous Scan Used)), Sensor-Surface: 3mm (Mechanical Surface Detection)
- Electronics: DAE4 Sn669; Calibrated: 2018-06-18
- Phantom: Flat Phantom ELI4.0; Type: QDOVA001BA; Serial: SN:1060
- Measurement SW: DASY52, Version 52.8 (8); SEMCAD X Version 14.6.10 (7331)

**Configuration 2600MHz, 2019-04-22/d=10mm, Pin=250 mW/Area Scan (91x91x1):**

nterpolated grid:  $dx=1.000$  mm,  $dy=1.000$  mm

Maximum value of SAR (interpolated) = 19.5 W/kg

**Configuration 2600MHz, 2019-04-22/d=10mm, Pin=250 mW/Zoom Scan (7x7x7)/Cube 0:**

Measurement grid:  $dx=5$ mm,  $dy=5$ mm,  $dz=5$ mm

Reference Value = 93.48 V/m; Power Drift = 0.06 dB

Peak SAR (extrapolated) = 31.2 W/kg

**SAR(1 g) = 14.3 W/kg; SAR(10 g) = 6.3 W/kg** (SAR corrected for target medium)

Maximum value of SAR (measured) = 19.3 W/kg

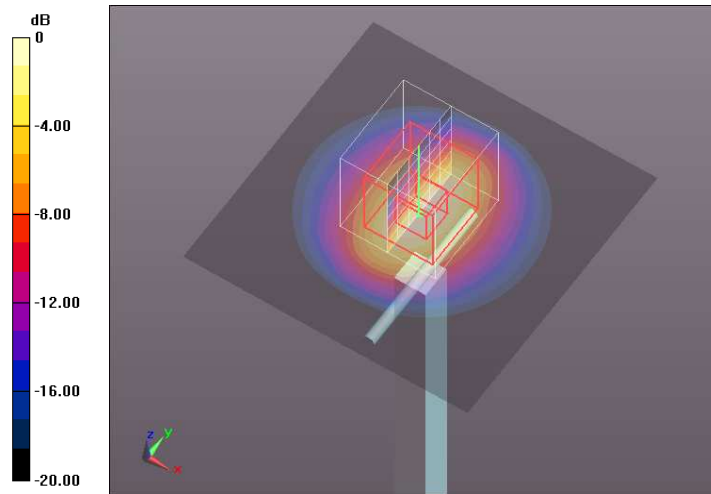

0 dB = 19.3 W/kg = 12.86 dBW/kg

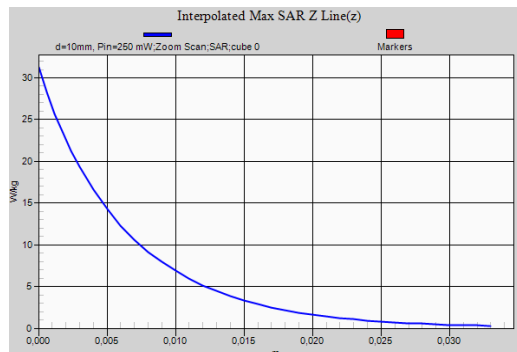

## Appendix E: Calibration data

**Calibration Laboratory of  
 Schmid & Partner  
 Engineering AG**  
 Zeughausstrasse 43, 8004 Zurich, Switzerland



**S** Schweizerischer Kalibrierdienst  
**C** Service suisse d'étalonnage  
**S** Servizio svizzero di taratura  
**S** Swiss Calibration Service

Accredited by the Swiss Accreditation Service (SAS)  
 The Swiss Accreditation Service is one of the signatories to the EA  
 Multilateral Agreement for the recognition of calibration certificates

Accreditation No.: **SCS 0108**

Client **Dekra Spain**

Certificate No: **DAE4-669\_Jun18**

**CALIBRATION CERTIFICATE**

Object: **DAE4 - SD 000 D04 BM - SN: 669**

Calibration procedure(s): **QA CAL-06.v29  
 Calibration procedure for the data acquisition electronics (DAE)**

Calibration date: **June 18, 2018**

This calibration certificate documents the traceability to national standards, which realize the physical units of measurements (SI).  
 The measurements and the uncertainties with confidence probability are given on the following pages and are part of the certificate.

All calibrations have been conducted in the closed laboratory facility: environment temperature (22 ± 3)°C and humidity < 70%.

Calibration Equipment used (M&TE critical for calibration)

Primary Standards	ID #	Cal Date (Certificate No.)	Scheduled Calibration
Keithley Multimeter Type 2001	SN: 0810278	31-Aug-17 (No.21092)	Aug-18
Secondary Standards	ID #	Check Date (in house)	Scheduled Check
Auto DAE Calibration Unit	SE UWS 053 AA 1001	04-Jan-18 (in house check)	In house check: Jan-19
Calibrator Box V2.1	SE UMS 006 AA 1002	04-Jan-18 (in house check)	In house check: Jan-19

Calibrated by:	Name Eric Hainfeld	Function Laboratory Technician	Signature 
Approved by:	Name Sven Kühn	Function Deputy Manager	Signature 

Issued: June 18, 2018

This calibration certificate shall not be reproduced except in full without written approval of the laboratory.

**Calibration Laboratory of  
Schmid & Partner  
Engineering AG**  
Zeughausstrasse 43, 8004 Zurich, Switzerland



**S** Schweizerischer Kalibrierdienst  
**S** Service suisse d'étalonnage  
**C** Servizio svizzero di taratura  
**S** Swiss Calibration Service

Accredited by the Swiss Accreditation Service (SAS)  
The Swiss Accreditation Service is one of the signatories to the EA  
Multilateral Agreement for the recognition of calibration certificates

Accreditation No.: **SCS 0108**

### Glossary

**DAE** data acquisition electronics  
**Connector angle** information used in DASY system to align probe sensor X to the robot coordinate system.

### Methods Applied and Interpretation of Parameters

- **DC Voltage Measurement:** Calibration Factor assessed for use in DASY system by comparison with a calibrated instrument traceable to national standards. The figure given corresponds to the full scale range of the voltmeter in the respective range.
- **Connector angle:** The angle of the connector is assessed measuring the angle mechanically by a tool inserted. Uncertainty is not required.
- The following parameters as documented in the Appendix contain technical information as a result from the performance test and require no uncertainty.
  - **DC Voltage Measurement Linearity:** Verification of the Linearity at +10% and -10% of the nominal calibration voltage. Influence of offset voltage is included in this measurement.
  - **Common mode sensitivity:** Influence of a positive or negative common mode voltage on the differential measurement.
  - **Channel separation:** Influence of a voltage on the neighbor channels not subject to an input voltage.
  - **AD Converter Values with inputs shorted:** Values on the internal AD converter corresponding to zero input voltage
  - **Input Offset Measurement:** Output voltage and statistical results over a large number of zero voltage measurements.
  - **Input Offset Current:** Typical value for information; Maximum channel input offset current, not considering the input resistance.
  - **Input resistance:** Typical value for information; DAE input resistance at the connector, during internal auto-zeroing and during measurement.
  - **Low Battery Alarm Voltage:** Typical value for information. Below this voltage, a battery alarm signal is generated.
  - **Power consumption:** Typical value for information. Supply currents in various operating modes.

### DC Voltage Measurement

A/D - Converter Resolution nominal

High Range: 1LSB = 6.1µV, full range = -100...+300 mV

Low Range: 1LSB = 61nV, full range = -1.....+3mV

DASY measurement parameters: Auto Zero Time: 3 sec; Measuring time: 3 sec

Calibration Factors	X	Y	Z
High Range	403.333 ± 0.02% (k=2)	403.886 ± 0.02% (k=2)	404.237 ± 0.02% (k=2)
Low Range	3.95551 ± 1.50% (k=2)	3.97491 ± 1.50% (k=2)	3.97424 ± 1.50% (k=2)

### Connector Angle

Connector Angle to be used in DASY system	192.0 ° ± 1 °
---	---------------

**Appendix (Additional assessments outside the scope of SCS0108)**

**1. DC Voltage Linearity**

High Range	Reading ( $\mu\text{V}$ )	Difference ( $\mu\text{V}$ )	Error (%)
Channel X + Input	200031.33	-2.81	-0.00
Channel X + Input	20010.62	5.02	0.03
Channel X - Input	-20000.39	4.48	-0.02
Channel Y + Input	200031.41	-2.80	-0.00
Channel Y + Input	20009.03	3.54	0.02
Channel Y - Input	-20002.37	2.62	-0.01
Channel Z + Input	200031.37	-2.53	-0.00
Channel Z + Input	20009.85	4.43	0.02
Channel Z - Input	-20002.39	2.63	-0.01

Low Range	Reading ( $\mu\text{V}$ )	Difference ( $\mu\text{V}$ )	Error (%)
Channel X + Input	2001.30	-0.38	-0.02
Channel X + Input	201.70	-0.05	-0.03
Channel X - Input	-197.61	0.72	-0.37
Channel Y + Input	2001.32	-0.14	-0.01
Channel Y + Input	200.88	-0.70	-0.35
Channel Y - Input	-198.96	-0.46	0.23
Channel Z + Input	2001.85	0.33	0.02
Channel Z + Input	200.96	-0.54	-0.27
Channel Z - Input	-199.79	-1.28	0.64

**2. Common mode sensitivity**

DASY measurement parameters: Auto Zero Time: 3 sec; Measuring time: 3 sec

	Common mode Input Voltage (mV)	High Range Average Reading ( $\mu\text{V}$ )	Low Range Average Reading ( $\mu\text{V}$ )
Channel X	200	1.94	0.66
	-200	0.73	-1.04
Channel Y	200	10.37	10.32
	-200	-12.28	-12.40
Channel Z	200	-9.48	-9.85
	-200	7.28	7.28

**3. Channel separation**

DASY measurement parameters: Auto Zero Time: 3 sec; Measuring time: 3 sec

	Input Voltage (mV)	Channel X ( $\mu\text{V}$ )	Channel Y ( $\mu\text{V}$ )	Channel Z ( $\mu\text{V}$ )
Channel X	200	-	-2.12	-3.46
Channel Y	200	9.13	-	-1.62
Channel Z	200	3.64	6.89	-



#### 4. AD-Converter Values with inputs shorted

DASY measurement parameters: Auto Zero Time: 3 sec; Measuring time: 3 sec

	High Range (LSB)	Low Range (LSB)
Channel X	16078	16039
Channel Y	15798	15557
Channel Z	15995	15010

#### 5. Input Offset Measurement

DASY measurement parameters: Auto Zero Time: 3 sec; Measuring time: 3 sec  
 Input 10M $\Omega$

	Average ( $\mu$ V)	min. Offset ( $\mu$ V)	max. Offset ( $\mu$ V)	Std. Deviation ( $\mu$ V)
Channel X	0.17	-0.81	1.00	0.40
Channel Y	0.68	-0.15	2.34	0.42
Channel Z	0.09	-1.07	1.38	0.44

#### 6. Input Offset Current

Nominal input circuitry offset current on all channels: <25fA

#### 7. Input Resistance (Typical values for information)

	Zeroing (kOhm)	Measuring (MOhm)
Channel X	200	200
Channel Y	200	200
Channel Z	200	200

#### 8. Low Battery Alarm Voltage (Typical values for information)

Typical values	Alarm Level (VDC)
Supply (+ Vcc)	+7.9
Supply (- Vcc)	-7.6

#### 9. Power Consumption (Typical values for information)

Typical values	Switched off (mA)	Stand by (mA)	Transmitting (mA)
Supply (+ Vcc)	+0.01	+6	+14
Supply (- Vcc)	-0.01	-8	-9

**Calibration Laboratory of  
 Schmid & Partner  
 Engineering AG**  
 Zeughausstrasse 43, 8004 Zurich, Switzerland



S Schweizerischer Kalibrierdienst  
 S Service suisse d'étalonnage  
 S Servizio svizzero di taratura  
 S Swiss Calibration Service

Accredited by the Swiss Accreditation Service (SAS)  
 The Swiss Accreditation Service is one of the signatories to the EA  
 Multilateral Agreement for the recognition of calibration certificates

Accreditation No.: **SCS 0108**

Client **Dekra Spain**

Certificate No: **EX3-7461\_Jun18**

### CALIBRATION CERTIFICATE

Object: **EX3DV4 - SN:7461**

Calibration procedure(s): **QA CAL-01.v9, QA CAL-12.v9, QA CAL-14.v4, QA CAL-23.v5,  
 QA CAL-25.v6  
 Calibration procedure for dosimetric E-field probes**

Calibration date: **June 25, 2018**

This calibration certificate documents the traceability to national standards, which realize the physical units of measurements (SI).  
 The measurements and the uncertainties with confidence probability are given on the following pages and are part of the certificate.

All calibrations have been conducted in the closed laboratory facility: environment temperature (22 ± 3)°C and humidity < 70%.

Calibration Equipment used (M&TE critical for calibration)

Primary Standards	ID	Cal Date (Certificate No.)	Scheduled Calibration
Power meter NRP	SN: 104778	04-Apr-18 (No. 217-02672/02673)	Apr-19
Power sensor NRP-Z91	SN: 103244	04-Apr-18 (No. 217-02672)	Apr-19
Power sensor NRP-Z91	SN: 103245	04-Apr-18 (No. 217-02673)	Apr-19
Reference 20 dB Attenuator	SN: S5277 (20x)	04-Apr-18 (No. 217-02682)	Apr-19
Reference Probe ES3DV2	SN: 3013	30-Dec-17 (No. ES3-3013_Dec17)	Dec-18
DAE4	SN: 660	21-Dec-17 (No. DAE4-660_Dec17)	Dec-18
Secondary Standards	ID	Check Date (in house)	Scheduled Check
Power meter E4419B	SN: GB41293874	06-Apr-16 (in house check Jun-18)	in house check: Jun-20
Power sensor E4412A	SN: MY41498087	06-Apr-16 (in house check Jun-18)	in house check: Jun-20
Power sensor E4412A	SN: 000110210	06-Apr-16 (in house check Jun-18)	in house check: Jun-20
RF generator HP 8648C	SN: US3642U01700	04-Aug-98 (in house check Jun-18)	in house check: Jun-20
Network Analyzer HP 8753E	SN: US37390585	18-Oct-01 (in house check Oct-17)	in house check: Oct-18

Calibrated by: **Claudio Leubler** (Name), **Laboratory Technician** (Function), *[Signature]* (Signature)

Approved by: **Katja Pokovic** (Name), **Technical Manager** (Function), *[Signature]* (Signature)

Issued: June 26, 2018

This calibration certificate shall not be reproduced except in full without written approval of the laboratory.

**Calibration Laboratory of  
 Schmid & Partner  
 Engineering AG**  
 Zeughausstrasse 43, 8004 Zurich, Switzerland



**S** Schweizerischer Kalibrierdienst  
**C** Service suisse d'étalonnage  
**S** Servizio svizzero di taratura  
**S** Swiss Calibration Service

Accredited by the Swiss Accreditation Service (SAS)  
 The Swiss Accreditation Service is one of the signatories to the EA  
 Multilateral Agreement for the recognition of calibration certificates

Accreditation No.: **SCS 0108**

**Glossary:**

TSL	tissue simulating liquid
NORM <sub>x,y,z</sub>	sensitivity in free space
ConvF	sensitivity in TSL / NORM <sub>x,y,z</sub>
DCP	diode compression point
CF	crest factor (1/duty_cycle) of the RF signal
A, B, C, D	modulation dependent linearization parameters
Polarization $\varphi$	$\varphi$ rotation around probe axis
Polarization $\beta$	$\beta$ rotation around an axis that is in the plane normal to probe axis (at measurement center), i.e., $\beta = 0$ is normal to probe axis
Connector Angle	information used in DASY system to align probe sensor X to the robot coordinate system

**Calibration is Performed According to the Following Standards:**

- a) IEEE Std 1528-2013, "IEEE Recommended Practice for Determining the Peak Spatial-Averaged Specific Absorption Rate (SAR) in the Human Head from Wireless Communications Devices: Measurement Techniques", June 2013
- b) IEC 62209-1, "Measurement procedure for the assessment of Specific Absorption Rate (SAR) from hand-held and body-mounted devices used next to the ear (frequency range of 300 MHz to 6 GHz)", July 2016
- c) IEC 62209-2, "Procedure to determine the Specific Absorption Rate (SAR) for wireless communication devices used in close proximity to the human body (frequency range of 30 MHz to 6 GHz)", March 2010
- d) KDB 865664, "SAR Measurement Requirements for 100 MHz to 6 GHz"

**Methods Applied and Interpretation of Parameters:**

- **NORM<sub>x,y,z</sub>**: Assessed for E-field polarization  $\beta = 0$  ( $f \leq 900$  MHz in TEM-cell;  $f > 1800$  MHz: R22 waveguide). NORM<sub>x,y,z</sub> are only intermediate values, i.e., the uncertainties of NORM<sub>x,y,z</sub> does not affect the E<sup>2</sup>-field uncertainty inside TSL (see below ConvF).
- **NORM(f)<sub>x,y,z</sub> = NORM<sub>x,y,z</sub> \* frequency\_response** (see Frequency Response Chart). This linearization is implemented in DASY4 software versions later than 4.2. The uncertainty of the frequency response is included in the stated uncertainty of ConvF.
- **DCP<sub>x,y,z</sub>**: DCP are numerical linearization parameters assessed based on the data of power sweep with CW signal (no uncertainty required). DCP does not depend on frequency nor media.
- **PAR**: PAR is the Peak to Average Ratio that is not calibrated but determined based on the signal characteristics
- **A<sub>x,y,z</sub>; B<sub>x,y,z</sub>; C<sub>x,y,z</sub>; D<sub>x,y,z</sub>; VR<sub>x,y,z</sub>**: A, B, C, D are numerical linearization parameters assessed based on the data of power sweep for specific modulation signal. The parameters do not depend on frequency nor media. VR is the maximum calibration range expressed in RMS voltage across the diode.
- **ConvF and Boundary Effect Parameters**: Assessed in flat phantom using E-field (or Temperature Transfer Standard for  $f \leq 800$  MHz) and inside waveguide using analytical field distributions based on power measurements for  $f > 800$  MHz. The same setups are used for assessment of the parameters applied for boundary compensation (alpha, depth) of which typical uncertainty values are given. These parameters are used in DASY4 software to improve probe accuracy close to the boundary. The sensitivity in TSL corresponds to NORM<sub>x,y,z</sub> \* ConvF whereby the uncertainty corresponds to that given for ConvF. A frequency dependent ConvF is used in DASY version 4.4 and higher which allows extending the validity from  $\pm 50$  MHz to  $\pm 100$  MHz.
- **Spherical isotropy (3D deviation from isotropy)**: in a field of low gradients realized using a flat phantom exposed by a patch antenna.
- **Sensor Offset**: The sensor offset corresponds to the offset of virtual measurement center from the probe tip (on probe axis). No tolerance required.
- **Connector Angle**: The angle is assessed using the information gained by determining the NORM<sub>x</sub> (no uncertainty required).

EX3DV4 – SN:7461

June 25, 2018

# Probe EX3DV4

## SN:7461

Manufactured: September 6, 2016  
Calibrated: June 25, 2018

Calibrated for DASY/EASY Systems  
(Note: non-compatible with DASY2 system!)

---

Certificate No: EX3-7461\_Jun18

Page 3 of 39

EX3DV4- SN:7461

June 25, 2018

## DASY/EASY - Parameters of Probe: EX3DV4 - SN:7461

### Basic Calibration Parameters

	Sensor X	Sensor Y	Sensor Z	Unc (k=2)
Norm ( $\mu\text{V}/(\text{V}/\text{m})^2$ ) <sup>A</sup>	0.45	0.40	0.46	$\pm 10.1 \%$
DCP (mV) <sup>B</sup>	94.5	96.8	95.3	

### Modulation Calibration Parameters

UID	Communication System Name		A dB	B dB $\sqrt{\mu\text{V}}$	C	D dB	VR mV	Unc <sup>E</sup> (k=2)
0	CW	X	0.0	0.0	1.0	0.00	152.3	$\pm 3.5 \%$
		Y	0.0	0.0	1.0		140.0	
		Z	0.0	0.0	1.0		151.1	

Note: For details on UID parameters see Appendix.

### Sensor Model Parameters

	C1 fF	C2 fF	$\alpha$ $\text{V}^{-1}$	T1 $\text{ms}\cdot\text{V}^{-2}$	T2 $\text{ms}\cdot\text{V}^{-1}$	T3 ms	T4 $\text{V}^{-2}$	T5 $\text{V}^{-1}$	T6
X	48.65	372.9	37.29	6.648	0.600	5.004	0.252	0.527	1.005
Y	44.98	335.3	35.55	7.918	0.404	5.000	0.691	0.326	1.002
Z	39.63	302.2	36.93	5.734	0.546	5.009	0.855	0.350	1.007

The reported uncertainty of measurement is stated as the standard uncertainty of measurement multiplied by the coverage factor  $k=2$ , which for a normal distribution corresponds to a coverage probability of approximately 95%.

<sup>A</sup> The uncertainties of Norm X,Y,Z do not affect the  $E^2$ -field uncertainty inside TSL (see Pages 5 and 6).

<sup>B</sup> Numerical linearization parameter: uncertainty not required.

<sup>E</sup> Uncertainty is determined using the max. deviation from linear response applying rectangular distribution and is expressed for the square of the field value.

EX3DV4– SN:7461

June 25, 2018

## DASY/EASY - Parameters of Probe: EX3DV4 - SN:7461

### Calibration Parameter Determined in Head Tissue Simulating Media

f (MHz) <sup>c</sup>	Relative Permittivity <sup>e</sup>	Conductivity (S/m) <sup>f</sup>	ConvF X	ConvF Y	ConvF Z	Alpha <sup>g</sup>	Depth <sup>g</sup> (mm)	Unc (k=2)
450	43.5	0.87	11.05	11.05	11.05	0.14	1.30	± 13.3 %
750	41.9	0.89	10.33	10.33	10.33	0.50	0.80	± 12.0 %
900	41.5	0.97	9.67	9.67	9.67	0.46	0.86	± 12.0 %
1810	40.0	1.40	8.31	8.31	8.31	0.29	0.84	± 12.0 %
2000	40.0	1.40	8.18	8.18	8.18	0.26	0.97	± 12.0 %
2450	39.2	1.80	7.80	7.80	7.80	0.32	0.90	± 12.0 %
2600	39.0	1.96	7.31	7.31	7.31	0.40	0.86	± 12.0 %
5200	36.0	4.66	5.83	5.83	5.83	0.40	1.80	± 13.1 %
5300	35.9	4.76	5.60	5.60	5.60	0.40	1.80	± 13.1 %
5600	35.5	5.07	5.05	5.05	5.05	0.40	1.80	± 13.1 %
5800	35.3	5.27	5.23	5.23	5.23	0.40	1.80	± 13.1 %

<sup>c</sup> Frequency validity above 300 MHz of ± 100 MHz only applies for DASY v4.4 and higher (see Page 2), else it is restricted to ± 50 MHz. The uncertainty is the RSS of the ConvF uncertainty at calibration frequency and the uncertainty for the indicated frequency band. Frequency validity below 300 MHz is ± 10, 25, 40, 50 and 70 MHz for ConvF assessments at 30, 64, 128, 150 and 220 MHz respectively. Above 5 GHz frequency validity can be extended to ± 110 MHz.

<sup>e</sup> At frequencies below 3 GHz, the validity of tissue parameters ( $\epsilon$  and  $\sigma$ ) can be relaxed to ± 10% if liquid compensation formula is applied to measured SAR values. At frequencies above 3 GHz, the validity of tissue parameters ( $\epsilon$  and  $\sigma$ ) is restricted to ± 5%. The uncertainty is the RSS of the ConvF uncertainty for indicated target tissue parameters.

<sup>g</sup> Alpha/Depth are determined during calibration. SPEAG warrants that the remaining deviation due to the boundary effect after compensation is always less than ± 1% for frequencies below 3 GHz and below ± 2% for frequencies between 3-6 GHz at any distance larger than half the probe tip diameter from the boundary.

EX3DV4- SN:7461

June 25, 2018

## DASY/EASY - Parameters of Probe: EX3DV4 - SN:7461

### Calibration Parameter Determined in Body Tissue Simulating Media

f (MHz) <sup>C</sup>	Relative Permittivity <sup>E</sup>	Conductivity (S/m) <sup>F</sup>	ConvF X	ConvF Y	ConvF Z	Alpha <sup>G</sup>	Depth <sup>G</sup> (mm)	Unc (k=2)
450	56.7	0.94	11.15	11.15	11.15	0.09	1.25	± 13.3 %
750	55.5	0.96	10.11	10.11	10.11	0.44	0.80	± 12.0 %
900	55.0	1.05	9.78	9.78	9.78	0.41	0.92	± 12.0 %
1810	53.3	1.52	8.24	8.24	8.24	0.33	0.97	± 12.0 %
2000	53.3	1.52	7.99	7.99	7.99	0.40	0.85	± 12.0 %
2450	52.7	1.95	7.88	7.88	7.88	0.31	0.95	± 12.0 %
2600	52.5	2.16	7.52	7.52	7.52	0.25	0.99	± 12.0 %
5200	49.0	5.30	4.96	4.96	4.96	0.50	1.90	± 13.1 %
5300	48.9	5.42	4.77	4.77	4.77	0.50	1.90	± 13.1 %
5600	48.5	5.77	4.18	4.18	4.18	0.50	1.90	± 13.1 %
5800	48.2	6.00	4.41	4.41	4.41	0.50	1.90	± 13.1 %

<sup>C</sup> Frequency validity above 300 MHz of ± 100 MHz only applies for DASY v4.4 and higher (see Page 2), else it is restricted to ± 50 MHz. The uncertainty is the RSS of the ConvF uncertainty at calibration frequency and the uncertainty for the indicated frequency band. Frequency validity below 300 MHz is ± 10, 25, 40, 50 and 70 MHz for ConvF assessments at 30, 64, 128, 150 and 220 MHz respectively. Above 5 GHz frequency validity can be extended to ± 110 MHz.

<sup>F</sup> At frequencies below 3 GHz, the validity of tissue parameters ( $\epsilon$  and  $\sigma$ ) can be relaxed to ± 10% if liquid compensation formula is applied to measured SAR values. At frequencies above 3 GHz, the validity of tissue parameters ( $\epsilon$  and  $\sigma$ ) is restricted to ± 5%. The uncertainty is the RSS of the ConvF uncertainty for indicated target tissue parameters.

<sup>G</sup> Alpha/Depth are determined during calibration. SPEAG warrants that the remaining deviation due to the boundary effect after compensation is always less than ± 1% for frequencies below 3 GHz and below ± 2% for frequencies between 3-6 GHz at any distance larger than half the probe tip diameter from the boundary.

Certificate No: EX3-7461\_Jun18

Page 6 of 39

EX3DV4- SN:7461

June 25, 2018

### Frequency Response of E-Field (TEM-Cell: ifi110 EXX, Waveguide: R22)

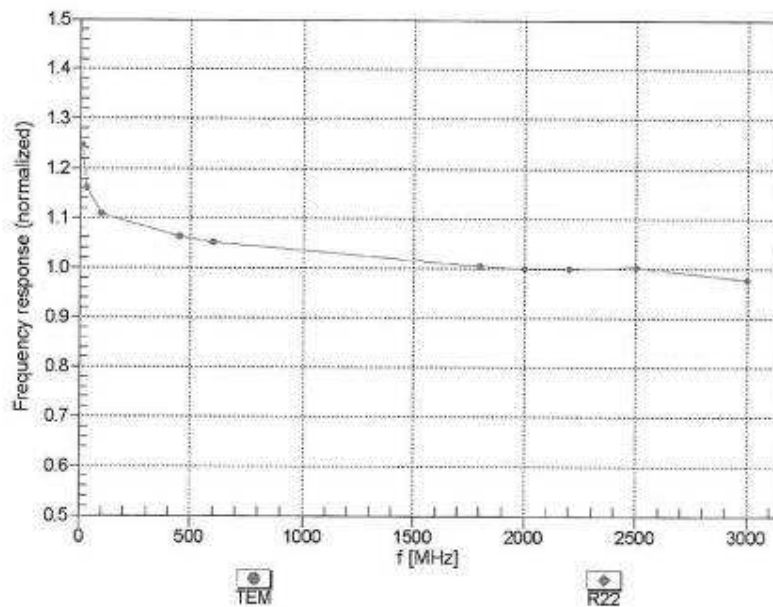

Uncertainty of Frequency Response of E-field:  $\pm 6.3\%$  ( $k=2$ )



EX3DV4- SN:7461

June 25, 2018

### Receiving Pattern ( $\phi$ ), $\theta = 0^\circ$

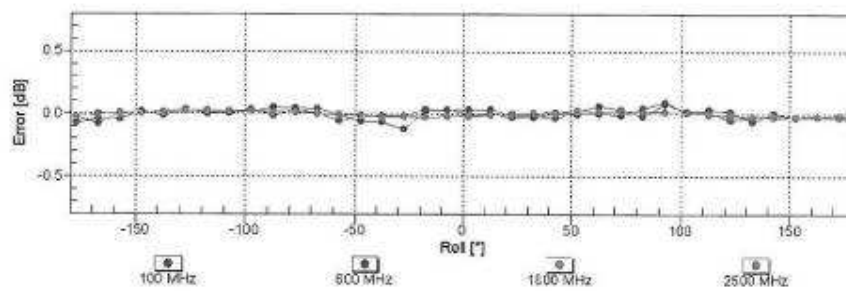
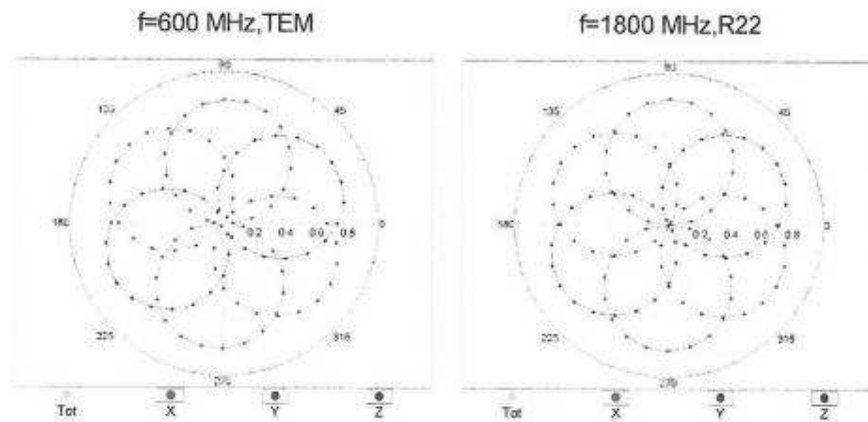

Uncertainty of Axial Isotropy Assessment:  $\pm 0.5\%$  ( $k=2$ )

EX3DV4-- SN:7461

June 25, 2018

### Dynamic Range f(SAR<sub>head</sub>) (TEM cell , f<sub>eval</sub>= 1900 MHz)

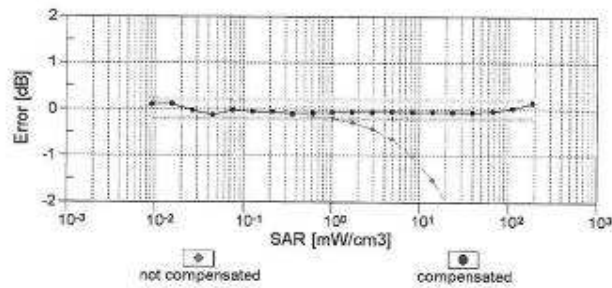
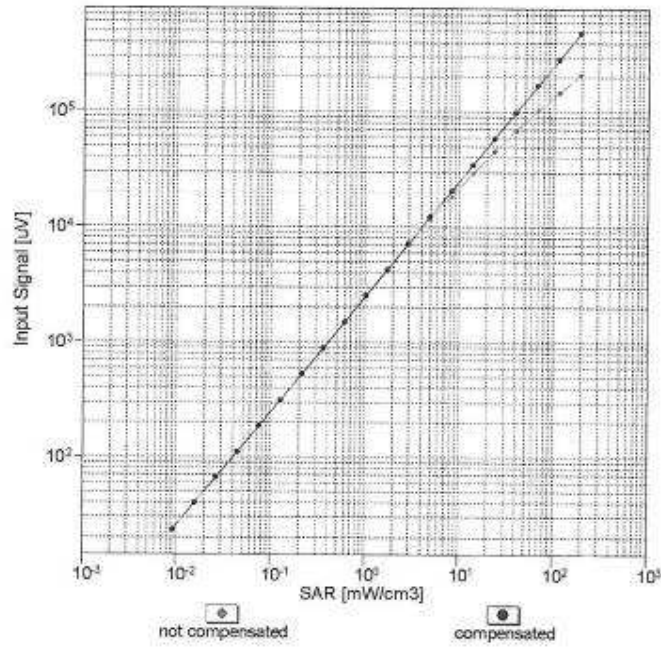

Uncertainty of Linearity Assessment:  $\pm 0.6\%$  (k=2)

EX3DV4- SN:7461

June 25, 2018

### Conversion Factor Assessment

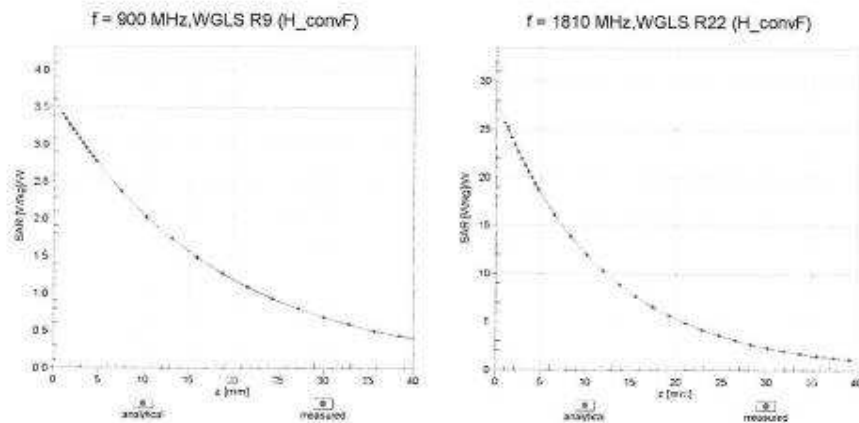

### Deviation from Isotropy in Liquid Error ( $\phi, \theta$ ), f = 900 MHz

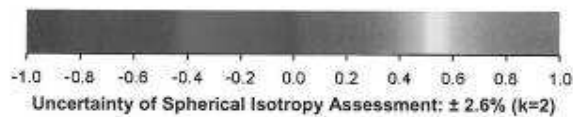
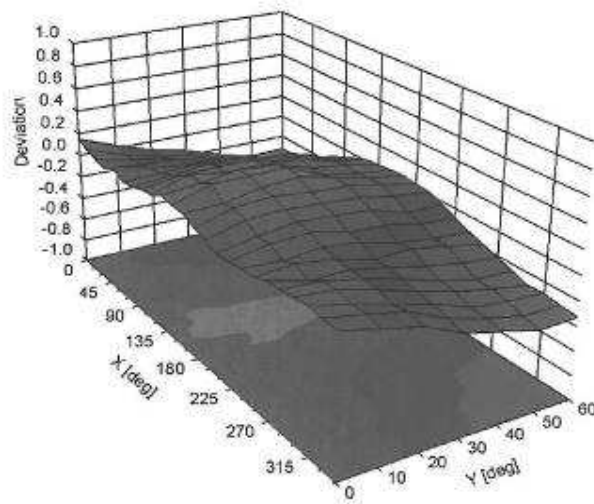

EX3DV4- SN:7461

June 25, 2018

## DASY/EASY - Parameters of Probe: EX3DV4 - SN:7461

### Other Probe Parameters

Sensor Arrangement	Triangular
Connector Angle (°)	102.6
Mechanical Surface Detection Mode	enabled
Optical Surface Detection Mode	disabled
Probe Overall Length	337 mm
Probe Body Diameter	10 mm
Tip Length	9 mm
Tip Diameter	2.5 mm
Probe Tip to Sensor X Calibration Point	1 mm
Probe Tip to Sensor Y Calibration Point	1 mm
Probe Tip to Sensor Z Calibration Point	1 mm
Recommended Measurement Distance from Surface	1.4 mm

EX3DV4- SN:7461

June 25, 2018

**Appendix: Modulation Calibration Parameters**

UID	Communication System Name		A dB	B dB-µV	C	D dB	VR mV	Max Unc <sup>F</sup> (k=2)
0	CW	X	0.00	0.00	1.00	0.00	152.3	± 3.5 %
		Y	0.00	0.00	1.00		140.0	
		Z	0.00	0.00	1.00		151.1	
10010- CAA	SAR Validation (Square, 100ms, 10ms)	X	1.61	61.85	7.44	10.00	20.0	± 9.6 %
		Y	1.74	63.22	8.41		20.0	
		Z	1.64	62.08	7.60		20.0	
10011- CAB	UMTS-FDD (WCDMA)	X	0.92	66.82	14.55	0.00	150.0	± 9.6 %
		Y	1.03	67.87	15.54		150.0	
		Z	0.89	66.53	14.27		150.0	
10012- CAB	IEEE 802.11b WiFi 2.4 GHz (DSSS, 1 Mbps)	X	1.04	63.02	14.66	0.41	150.0	± 9.6 %
		Y	1.13	63.58	15.10		150.0	
		Z	1.04	63.04	14.58		150.0	
10013- CAB	IEEE 802.11g WiFi 2.4 GHz (DSSS-OFDM, 6 Mbps)	X	4.74	66.26	16.81	1.46	150.0	± 9.6 %
		Y	4.77	66.48	16.89		150.0	
		Z	4.64	66.40	16.81		150.0	
10021- DAC	GSM-FDD (TDMA, GMSK)	X	4.00	71.17	12.92	9.39	50.0	± 9.6 %
		Y	26.93	92.76	20.11		50.0	
		Z	5.13	74.06	14.09		50.0	
10023- DAC	GPRS-FDD (TDMA, GMSK, TN 0)	X	3.80	70.37	12.62	9.57	50.0	± 9.6 %
		Y	13.45	85.06	17.98		50.0	
		Z	4.45	72.29	13.44		50.0	
10024- DAC	GPRS-FDD (TDMA, GMSK, TN 0-1)	X	2.14	67.85	10.44	6.56	60.0	± 9.6 %
		Y	100.00	105.14	21.70		60.0	
		Z	3.16	71.69	12.00		60.0	
10025- DAC	EDGE-FDD (TDMA, 8PSK, TN 0)	X	3.74	67.51	24.02	12.57	50.0	± 9.6 %
		Y	4.68	74.96	28.57		50.0	
		Z	3.67	67.03	23.83		50.0	
10026- DAC	EDGE-FDD (TDMA, 8PSK, TN 0-1)	X	7.03	86.01	29.91	9.56	60.0	± 9.6 %
		Y	7.18	87.36	30.89		60.0	
		Z	6.26	83.96	29.31		60.0	
10027- DAC	GPRS-FDD (TDMA, GMSK, TN 0-1-2)	X	1.22	65.23	8.57	4.80	80.0	± 9.6 %
		Y	100.00	105.13	20.96		80.0	
		Z	2.17	70.17	10.60		80.0	
10028- DAC	GPRS-FDD (TDMA, GMSK, TN 0-1-2-3)	X	0.61	62.10	6.49	3.55	100.0	± 9.6 %
		Y	100.00	106.15	20.78		100.0	
		Z	0.93	65.47	8.09		100.0	
10029- DAC	EDGE-FDD (TDMA, 8PSK, TN 0-1-2)	X	4.52	76.71	25.07	7.80	80.0	± 9.6 %
		Y	4.57	77.18	25.55		80.0	
		Z	4.11	75.11	24.54		80.0	
10030- CAA	IEEE 802.15.1 Bluetooth (GFSK, DH1)	X	1.32	64.81	8.58	5.30	70.0	± 9.6 %
		Y	100.00	103.31	20.46		70.0	
		Z	1.53	66.39	9.30		70.0	
10031- CAA	IEEE 802.15.1 Bluetooth (GFSK, DH3)	X	0.24	60.00	3.68	1.88	100.0	± 9.6 %
		Y	100.00	100.94	17.53		100.0	
		Z	0.23	60.00	3.71		100.0	

EX3DV4- SN:7461

June 25, 2018

10032-CAA	IEEE 802.15.1 Bluetooth (GFSK, DH5)	X	8.29	60.14	1.37	1.17	100.0	± 9.6 %
		Y	100.00	104.39	18.16		100.0	
		Z	22.95	60.63	1.44		100.0	
10033-CAA	IEEE 802.15.1 Bluetooth (PI/4-DQPSK, DH1)	X	4.33	79.41	19.42	5.30	70.0	± 9.6 %
		Y	5.70	84.09	21.45		70.0	
		Z	3.94	77.65	18.24		70.0	
10034-CAA	IEEE 802.15.1 Bluetooth (PI/4-DQPSK, DH3)	X	1.65	69.96	14.63	1.88	100.0	± 9.6 %
		Y	2.08	73.07	16.27		100.0	
		Z	1.45	68.31	13.09		100.0	
10035-CAA	IEEE 802.15.1 Bluetooth (PI/4-DQPSK, DH5)	X	1.29	67.96	13.56	1.17	100.0	± 9.6 %
		Y	1.60	70.85	15.10		100.0	
		Z	1.14	66.53	12.04		100.0	
10036-CAA	IEEE 802.15.1 Bluetooth (8-DPSK, DH1)	X	5.32	82.58	20.62	5.30	70.0	± 9.6 %
		Y	7.37	88.14	22.87		70.0	
		Z	4.78	80.55	19.35		70.0	
10037-CAA	IEEE 802.15.1 Bluetooth (8-DPSK, DH3)	X	1.56	69.43	14.37	1.88	100.0	± 9.6 %
		Y	1.94	72.27	15.91		100.0	
		Z	1.36	67.70	12.80		100.0	
10038-CAA	IEEE 802.15.1 Bluetooth (8-DPSK, DH5)	X	1.31	68.29	13.82	1.17	100.0	± 9.6 %
		Y	1.61	70.96	15.35		100.0	
		Z	1.15	66.81	12.29		100.0	
10039-CAB	CDMA2000 (1xRTT, RC1)	X	1.56	70.05	14.26	0.00	150.0	± 9.6 %
		Y	1.94	73.21	15.95		150.0	
		Z	1.16	67.16	12.03		150.0	
10042-CAB	IS-54 / IS-136 FDD (TDMA/FDM, PI/4-DQPSK, Halfrate)	X	1.85	65.01	9.27	7.78	50.0	± 9.6 %
		Y	6.75	78.14	14.71		50.0	
		Z	2.03	66.09	9.82		50.0	
10044-CAA	IS-91/EIA/TIA-553 FDD (FDMA, FM)	X	0.15	126.47	1.91	0.00	150.0	± 9.6 %
		Y	0.00	105.63	5.69		150.0	
		Z	0.13	124.81	4.76		150.0	
10048-CAA	DECT (TDD, TDMA/FDM, GFSK, Full Slot, 24)	X	4.10	66.89	12.67	13.80	25.0	± 9.6 %
		Y	5.71	71.82	14.78		25.0	
		Z	4.39	67.64	13.00		25.0	
10049-CAA	DECT (TDD, TDMA/FDM, GFSK, Double Slot, 12)	X	3.81	68.97	12.29	10.79	40.0	± 9.6 %
		Y	5.99	75.01	14.87		40.0	
		Z	4.10	69.67	12.69		40.0	
10056-CAA	UMTS-TDD (TD-SCDMA, 1.28 Mcps)	X	8.62	82.79	20.39	9.03	50.0	± 9.6 %
		Y	14.59	91.74	23.66		50.0	
		Z	8.69	82.65	20.02		50.0	
10058-DAC	EDGE-FDD (TDMA, 8PSK, TN 0-1-2-3)	X	3.58	72.55	22.54	6.55	100.0	± 9.6 %
		Y	3.64	72.87	22.88		100.0	
		Z	3.32	71.36	22.13		100.0	
10059-CAB	IEEE 802.11b WiFi 2.4 GHz (DSSS, 2 Mbps)	X	1.04	63.75	15.04	0.61	110.0	± 9.6 %
		Y	1.13	64.33	15.50		110.0	
		Z	1.04	63.73	14.95		110.0	
10060-CAB	IEEE 802.11b WiFi 2.4 GHz (DSSS, 5.5 Mbps)	X	3.78	89.45	22.29	1.30	110.0	± 9.6 %
		Y	4.61	93.85	24.83		110.0	
		Z	3.20	87.87	22.02		110.0	

Certificate No: EX3-7461\_Jun18

Page 13 of 39

EX3DV4- SN:7461

June 25, 2018

10061-CAB	IEEE 802.11b WiFi 2.4 GHz (DSSS, 11 Mbps)	X	1.75	73.76	19.11	2.04	110.0	± 9.6 %
		Y	1.90	74.67	19.89		110.0	
		Z	1.66	73.23	18.95		110.0	
10062-CAC	IEEE 802.11a/h WiFi 5 GHz (OFDM, 6 Mbps)	X	4.57	66.36	16.34	0.49	100.0	± 9.6 %
		Y	4.60	66.59	16.42		100.0	
		Z	4.46	66.45	16.31		100.0	
10063-CAC	IEEE 802.11a/h WiFi 5 GHz (OFDM, 9 Mbps)	X	4.58	66.41	16.40	0.72	100.0	± 9.6 %
		Y	4.61	66.64	16.49		100.0	
		Z	4.47	66.51	16.38		100.0	
10064-CAC	IEEE 802.11a/h WiFi 5 GHz (OFDM, 12 Mbps)	X	4.87	66.69	16.64	0.66	100.0	± 9.6 %
		Y	4.88	66.88	16.70		100.0	
		Z	4.72	66.74	16.59		100.0	
10065-CAC	IEEE 802.11a/h WiFi 5 GHz (OFDM, 18 Mbps)	X	4.72	66.53	16.68	1.21	100.0	± 9.6 %
		Y	4.73	66.72	16.75		100.0	
		Z	4.59	66.57	16.64		100.0	
10066-CAC	IEEE 802.11a/h WiFi 5 GHz (OFDM, 24 Mbps)	X	4.72	66.51	16.81	1.46	100.0	± 9.6 %
		Y	4.74	66.69	16.88		100.0	
		Z	4.59	66.54	16.77		100.0	
10067-CAC	IEEE 802.11a/h WiFi 5 GHz (OFDM, 36 Mbps)	X	5.00	66.63	17.22	2.04	100.0	± 9.6 %
		Y	5.02	66.84	17.29		100.0	
		Z	4.88	66.77	17.22		100.0	
10068-CAC	IEEE 802.11a/h WiFi 5 GHz (OFDM, 48 Mbps)	X	5.04	66.64	17.40	2.55	100.0	± 9.6 %
		Y	5.04	66.80	17.45		100.0	
		Z	4.90	66.68	17.37		100.0	
10069-CAC	IEEE 802.11a/h WiFi 5 GHz (OFDM, 54 Mbps)	X	5.12	66.64	17.59	2.67	100.0	± 9.6 %
		Y	5.12	66.81	17.64		100.0	
		Z	4.97	66.72	17.56		100.0	
10071-CAB	IEEE 802.11g WiFi 2.4 GHz (DSSS/OFDM, 9 Mbps)	X	4.82	68.29	17.07	1.99	100.0	± 9.6 %
		Y	4.84	66.51	17.14		100.0	
		Z	4.72	66.44	17.08		100.0	
10072-CAB	IEEE 802.11g WiFi 2.4 GHz (DSSS/OFDM, 12 Mbps)	X	4.78	66.55	17.23	2.30	100.0	± 9.6 %
		Y	4.80	66.75	17.31		100.0	
		Z	4.67	66.66	17.23		100.0	
10073-CAB	IEEE 802.11g WiFi 2.4 GHz (DSSS/OFDM, 18 Mbps)	X	4.82	66.63	17.49	2.83	100.0	± 9.6 %
		Y	4.84	66.84	17.57		100.0	
		Z	4.72	66.78	17.52		100.0	
10074-CAB	IEEE 802.11g WiFi 2.4 GHz (DSSS/OFDM, 24 Mbps)	X	4.78	66.47	17.60	3.30	100.0	± 9.6 %
		Y	4.81	66.69	17.69		100.0	
		Z	4.71	66.67	17.64		100.0	
10075-CAB	IEEE 802.11g WiFi 2.4 GHz (DSSS/OFDM, 36 Mbps)	X	4.81	66.56	17.87	3.82	90.0	± 9.6 %
		Y	4.83	66.74	17.95		90.0	
		Z	4.73	66.68	17.88		90.0	
10076-CAB	IEEE 802.11g WiFi 2.4 GHz (DSSS/OFDM, 48 Mbps)	X	4.81	66.31	17.96	4.15	90.0	± 9.6 %
		Y	4.84	66.52	18.06		90.0	
		Z	4.75	66.53	18.02		90.0	
10077-CAB	IEEE 802.11g WiFi 2.4 GHz (DSSS/OFDM, 54 Mbps)	X	4.83	66.35	18.04	4.30	90.0	± 9.6 %
		Y	4.86	66.57	18.14		90.0	
		Z	4.78	66.59	18.12		90.0	

EX3DV4-SN:7461

June 25, 2018

10081-CAB	CDMA2000 (1xRTT, RC3)	X	0.68	64.22	10.87	0.00	150.0	± 9.6 %
		Y	0.83	66.33	12.50		150.0	
		Z	0.55	62.52	9.03		150.0	
10082-CAB	IS-54 / IS-136 FDD (TDMA/FDM, PI/4-DQPSK, Fullrate)	X	0.67	60.00	3.06	4.77	80.0	± 9.6 %
		Y	1.50	62.96	4.69		80.0	
		Z	0.68	60.00	2.94		80.0	
10090-DAC	GPRS-FDD (TDMA, GMSK, TN 0-4)	X	2.18	67.99	10.51	6.56	60.0	± 9.6 %
		Y	100.00	105.15	21.72		60.0	
		Z	3.25	71.92	12.10		60.0	
10097-CAB	UMTS-FDD (HSDPA)	X	1.72	67.29	15.30	0.00	150.0	± 9.6 %
		Y	1.84	68.14	15.87		150.0	
		Z	1.69	67.49	15.11		150.0	
10098-CAB	UMTS-FDD (HSUPA, Subtest 2)	X	1.69	67.23	15.26	0.00	150.0	± 9.6 %
		Y	1.80	68.10	15.84		150.0	
		Z	1.66	67.42	15.07		150.0	
10099-DAC	EDGE-FDD (TDMA, 8PSK, TN 0-4)	X	7.07	86.12	29.94	9.56	60.0	± 9.6 %
		Y	7.23	87.49	30.93		60.0	
		Z	6.30	84.07	29.35		60.0	
10100-CAD	LTE-FDD (SC-FDMA, 100% RB, 20 MHz, QPSK)	X	3.02	69.96	16.40	0.00	150.0	± 9.6 %
		Y	3.13	70.56	16.84		150.0	
		Z	2.90	69.68	16.32		150.0	
10101-CAD	LTE-FDD (SC-FDMA, 100% RB, 20 MHz, 16-QAM)	X	3.15	67.25	15.75	0.00	150.0	± 9.6 %
		Y	3.22	67.60	15.99		150.0	
		Z	3.05	67.10	15.66		150.0	
10102-CAD	LTE-FDD (SC-FDMA, 100% RB, 20 MHz, 64-QAM)	X	3.26	67.24	15.87	0.00	150.0	± 9.6 %
		Y	3.32	67.57	16.08		150.0	
		Z	3.16	67.13	15.78		150.0	
10103-CAD	LTE-TDD (SC-FDMA, 100% RB, 20 MHz, QPSK)	X	5.00	72.30	18.82	3.98	65.0	± 9.6 %
		Y	5.46	73.97	19.64		65.0	
		Z	4.83	72.31	18.93		65.0	
10104-CAD	LTE-TDD (SC-FDMA, 100% RB, 20 MHz, 16-QAM)	X	5.29	71.17	19.16	3.98	65.0	± 9.6 %
		Y	5.44	71.78	19.48		65.0	
		Z	5.08	70.92	19.07		65.0	
10105-CAD	LTE-TDD (SC-FDMA, 100% RB, 20 MHz, 64-QAM)	X	4.94	69.63	18.77	3.98	65.0	± 9.6 %
		Y	5.32	71.20	19.54		65.0	
		Z	5.08	70.73	19.31		65.0	
10108-CAE	LTE-FDD (SC-FDMA, 100% RB, 10 MHz, QPSK)	X	2.64	69.24	16.24	0.00	150.0	± 9.6 %
		Y	2.72	69.80	16.67		150.0	
		Z	2.50	69.01	16.15		150.0	
10109-CAE	LTE-FDD (SC-FDMA, 100% RB, 10 MHz, 16-QAM)	X	2.81	67.11	15.64	0.00	150.0	± 9.6 %
		Y	2.87	67.50	15.90		150.0	
		Z	2.70	67.01	15.51		150.0	
10110-CAE	LTE-FDD (SC-FDMA, 100% RB, 5 MHz, QPSK)	X	2.12	68.33	15.81	0.00	150.0	± 9.6 %
		Y	2.20	68.95	16.28		150.0	
		Z	1.99	68.14	15.61		150.0	
10111-CAE	LTE-FDD (SC-FDMA, 100% RB, 5 MHz, 16-QAM)	X	2.52	67.96	15.91	0.00	150.0	± 9.6 %
		Y	2.61	68.53	16.26		150.0	
		Z	2.42	68.04	15.70		150.0	



EX3DV4- SN:7461

June 25, 2018

10112-CAE	LTE-FDD (SC-FDMA, 100% RB, 10 MHz, 64-QAM)	X	2.93	67.12	15.72	0.00	150.0	± 9.6 %
		Y	3.00	67.50	15.96		150.0	
		Z	2.83	67.07	15.60		150.0	
10113-CAE	LTE-FDD (SC-FDMA, 100% RB, 5 MHz, 64-QAM)	X	2.68	68.13	16.07	0.00	150.0	± 9.6 %
		Y	2.76	68.68	16.39		150.0	
		Z	2.57	68.25	15.88		150.0	
10114-CAC	IEEE 802.11n (HT Greenfield, 13.5 Mbps, BPSK)	X	5.07	67.05	16.39	0.00	150.0	± 9.6 %
		Y	5.09	67.23	16.46		150.0	
		Z	4.95	66.99	16.35		150.0	
10115-CAC	IEEE 802.11n (HT Greenfield, 81 Mbps, 16-QAM)	X	5.36	67.20	16.48	0.00	150.0	± 9.6 %
		Y	5.36	67.31	16.51		150.0	
		Z	5.20	67.07	16.39		150.0	
10116-CAC	IEEE 802.11n (HT Greenfield, 135 Mbps, 64-QAM)	X	5.16	67.25	16.42	0.00	150.0	± 9.6 %
		Y	5.18	67.41	16.48		150.0	
		Z	5.03	67.19	16.37		150.0	
10117-CAC	IEEE 802.11n (HT Mixed, 13.5 Mbps, BPSK)	X	5.02	66.89	16.33	0.00	150.0	± 9.6 %
		Y	5.05	67.09	16.41		150.0	
		Z	4.93	66.92	16.33		150.0	
10118-CAC	IEEE 802.11n (HT Mixed, 81 Mbps, 16-QAM)	X	5.45	67.44	16.80	0.00	150.0	± 9.6 %
		Y	5.44	67.50	16.61		150.0	
		Z	5.28	67.28	16.51		150.0	
10119-CAC	IEEE 802.11n (HT Mixed, 135 Mbps, 64-QAM)	X	5.14	67.20	16.40	0.00	150.0	± 9.6 %
		Y	5.16	67.36	16.47		150.0	
		Z	5.03	67.17	16.37		150.0	
10140-CAD	LTE-FDD (SC-FDMA, 100% RB, 15 MHz, 16-QAM)	X	3.29	67.24	15.78	0.00	150.0	± 9.6 %
		Y	3.35	67.58	16.00		150.0	
		Z	3.18	67.13	15.69		150.0	
10141-CAD	LTE-FDD (SC-FDMA, 100% RB, 15 MHz, 64-QAM)	X	3.42	67.36	15.97	0.00	150.0	± 9.6 %
		Y	3.48	67.69	16.17		150.0	
		Z	3.31	67.29	15.90		150.0	
10142-CAD	LTE-FDD (SC-FDMA, 100% RB, 3 MHz, QPSK)	X	1.89	68.23	15.37	0.00	150.0	± 9.6 %
		Y	1.99	69.05	15.94		150.0	
		Z	1.74	67.93	14.91		150.0	
10143-CAD	LTE-FDD (SC-FDMA, 100% RB, 3 MHz, 16-QAM)	X	2.37	68.55	15.48	0.00	150.0	± 9.6 %
		Y	2.49	69.43	15.97		150.0	
		Z	2.21	68.33	14.87		150.0	
10144-CAD	LTE-FDD (SC-FDMA, 100% RB, 3 MHz, 64-QAM)	X	2.13	66.11	13.78	0.00	150.0	± 9.6 %
		Y	2.20	66.75	14.15		150.0	
		Z	1.93	65.58	12.97		150.0	
10145-CAE	LTE-FDD (SC-FDMA, 100% RB, 1.4 MHz, QPSK)	X	1.05	63.68	10.58	0.00	150.0	± 9.6 %
		Y	1.15	64.84	11.37		150.0	
		Z	0.79	61.37	8.19		150.0	
10146-CAE	LTE-FDD (SC-FDMA, 100% RB, 1.4 MHz, 16-QAM)	X	1.60	64.02	10.19	0.00	150.0	± 9.6 %
		Y	1.47	63.40	9.57		150.0	
		Z	1.18	61.57	7.76		150.0	
10147-CAE	LTE-FDD (SC-FDMA, 100% RB, 1.4 MHz, 64-QAM)	X	1.78	65.21	10.93	0.00	150.0	± 9.6 %
		Y	1.61	64.40	10.21		150.0	
		Z	1.25	62.10	8.16		150.0	

EX3DV4- SN:7461

June 25, 2018

10149-CAD	LTE-FDD (SC-FDMA, 50% RB, 20 MHz, 16-QAM)	X	2.82	67.17	15.69	0.00	150.0	± 9.6 %
		Y	2.88	67.56	15.95		150.0	
		Z	2.71	67.08	15.56		150.0	
10150-CAD	LTE-FDD (SC-FDMA, 50% RB, 20 MHz, 64-QAM)	X	2.94	67.18	15.76	0.00	150.0	± 9.6 %
		Y	3.01	67.56	16.01		150.0	
		Z	2.83	67.14	15.65		150.0	
10151-CAD	LTE-TDD (SC-FDMA, 50% RB, 20 MHz, QPSK)	X	5.18	74.53	19.83	3.98	65.0	± 9.6 %
		Y	5.47	75.66	20.42		65.0	
		Z	5.02	74.74	19.98		65.0	
10152-CAD	LTE-TDD (SC-FDMA, 50% RB, 20 MHz, 16-QAM)	X	4.80	70.91	18.74	3.98	65.0	± 9.6 %
		Y	4.95	71.58	19.08		65.0	
		Z	4.58	70.68	18.56		65.0	
10153-CAD	LTE-TDD (SC-FDMA, 50% RB, 20 MHz, 64-QAM)	X	5.13	71.86	19.56	3.98	65.0	± 9.6 %
		Y	5.29	72.53	19.88		65.0	
		Z	4.93	71.76	19.45		65.0	
10154-CAE	LTE-FDD (SC-FDMA, 50% RB, 10 MHz, QPSK)	X	2.17	68.80	16.10	0.00	150.0	± 9.6 %
		Y	2.26	69.40	16.55		150.0	
		Z	2.04	68.57	15.87		150.0	
10155-CAE	LTE-FDD (SC-FDMA, 50% RB, 10 MHz, 16-QAM)	X	2.53	67.97	15.93	0.00	150.0	± 9.6 %
		Y	2.61	68.55	16.28		150.0	
		Z	2.42	68.07	15.73		150.0	
10156-CAE	LTE-FDD (SC-FDMA, 50% RB, 5 MHz, QPSK)	X	1.73	68.23	15.07	0.00	150.0	± 9.6 %
		Y	1.84	69.19	15.72		150.0	
		Z	1.55	67.61	14.31		150.0	
10157-CAE	LTE-FDD (SC-FDMA, 50% RB, 5 MHz, 16-QAM)	X	1.95	68.55	13.70	0.00	150.0	± 9.6 %
		Y	2.05	67.39	14.19		150.0	
		Z	1.73	65.70	12.61		150.0	
10158-CAE	LTE-FDD (SC-FDMA, 50% RB, 10 MHz, 64-QAM)	X	2.89	68.20	16.12	0.00	150.0	± 9.6 %
		Y	2.77	68.76	16.44		150.0	
		Z	2.58	68.34	15.93		150.0	
10159-CAE	LTE-FDD (SC-FDMA, 50% RB, 5 MHz, 64-QAM)	X	2.08	67.02	14.00	0.00	150.0	± 9.6 %
		Y	2.17	67.89	14.49		150.0	
		Z	1.81	66.06	12.85		150.0	
10160-CAD	LTE-FDD (SC-FDMA, 50% RB, 15 MHz, QPSK)	X	2.66	68.45	16.11	0.00	150.0	± 9.6 %
		Y	2.73	68.86	16.43		150.0	
		Z	2.56	68.43	16.04		150.0	
10161-CAD	LTE-FDD (SC-FDMA, 50% RB, 15 MHz, 16-QAM)	X	2.84	67.11	15.68	0.00	150.0	± 9.6 %
		Y	2.90	67.53	15.94		150.0	
		Z	2.72	67.09	15.53		150.0	
10162-CAD	LTE-FDD (SC-FDMA, 50% RB, 15 MHz, 64-QAM)	X	2.95	67.27	15.80	0.00	150.0	± 9.6 %
		Y	3.01	67.69	16.05		150.0	
		Z	2.84	67.31	15.88		150.0	
10166-CAE	LTE-FDD (SC-FDMA, 50% RB, 1.4 MHz, QPSK)	X	3.46	69.12	18.78	3.01	150.0	± 9.6 %
		Y	3.36	68.86	18.60		150.0	
		Z	3.34	69.58	19.12		150.0	
10167-CAE	LTE-FDD (SC-FDMA, 50% RB, 1.4 MHz, 16-QAM)	X	4.22	71.74	19.08	3.01	150.0	± 9.6 %
		Y	4.05	71.59	18.99		150.0	
		Z	4.12	72.74	19.60		150.0	

EX3DV4- SN:7461

June 25, 2018

10165-CAE	LTE-FDD (SC-FDMA, 50% RB, 1.4 MHz, 64-QAM)	X	4.75	74.26	20.56	3.01	150.0	± 9.6 %
		Y	4.54	74.02	20.42		150.0	
		Z	4.78	75.96	21.39		150.0	
10169-CAD	LTE-FDD (SC-FDMA, 1 RB, 20 MHz, QPSK)	X	2.86	68.50	18.49	3.01	150.0	± 9.6 %
		Y	2.72	67.93	18.19		150.0	
		Z	2.74	68.51	18.64		150.0	
10170-CAD	LTE-FDD (SC-FDMA, 1 RB, 20 MHz, 16-QAM)	X	3.94	74.37	20.80	3.01	150.0	± 9.6 %
		Y	3.65	73.71	20.53		150.0	
		Z	3.90	75.44	21.43		150.0	
10171-AAD	LTE-FDD (SC-FDMA, 1 RB, 20 MHz, 64-QAM)	X	3.17	69.83	17.78	3.01	150.0	± 9.6 %
		Y	2.97	69.51	17.65		150.0	
		Z	3.05	70.27	18.09		150.0	
10172-CAD	LTE-TDD (SC-FDMA, 1 RB, 20 MHz, QPSK)	X	4.74	80.34	23.92	6.02	65.0	± 9.6 %
		Y	5.07	82.59	24.94		65.0	
		Z	3.97	78.92	23.83		65.0	
10173-CAD	LTE-TDD (SC-FDMA, 1 RB, 20 MHz, 16-QAM)	X	7.76	85.72	23.90	6.02	65.0	± 9.6 %
		Y	7.53	86.52	24.29		65.0	
		Z	7.71	87.93	25.01		65.0	
10174-CAD	LTE-TDD (SC-FDMA, 1 RB, 20 MHz, 64-QAM)	X	5.65	79.67	21.24	6.02	65.0	± 9.6 %
		Y	6.33	82.71	22.40		65.0	
		Z	5.27	80.76	21.95		65.0	
10175-CAE	LTE-FDD (SC-FDMA, 1 RB, 10 MHz, QPSK)	X	2.82	68.16	18.21	3.01	150.0	± 9.6 %
		Y	2.69	67.64	17.95		150.0	
		Z	2.70	68.16	18.36		150.0	
10176-CAE	LTE-FDD (SC-FDMA, 1 RB, 10 MHz, 16-QAM)	X	3.95	74.39	20.81	3.01	150.0	± 9.6 %
		Y	3.65	73.74	20.54		150.0	
		Z	3.91	75.47	21.44		150.0	
10177-CAG	LTE-FDD (SC-FDMA, 1 RB, 5 MHz, QPSK)	X	2.84	68.32	18.32	3.01	150.0	± 9.6 %
		Y	2.71	67.78	18.04		150.0	
		Z	2.73	68.32	18.46		150.0	
10178-CAE	LTE-FDD (SC-FDMA, 1 RB, 5 MHz, 16-QAM)	X	3.90	74.14	20.67	3.01	150.0	± 9.6 %
		Y	3.62	73.53	20.43		150.0	
		Z	3.87	75.23	21.32		150.0	
10179-CAE	LTE-FDD (SC-FDMA, 1 RB, 10 MHz, 64-QAM)	X	3.50	71.88	19.11	3.01	150.0	± 9.6 %
		Y	3.27	71.46	18.94		150.0	
		Z	3.42	72.62	19.57		150.0	
10180-CAE	LTE-FDD (SC-FDMA, 1 RB, 5 MHz, 64-QAM)	X	3.16	69.76	17.73	3.01	150.0	± 9.6 %
		Y	2.96	69.45	17.61		150.0	
		Z	3.04	70.21	18.04		150.0	
10181-CAD	LTE-FDD (SC-FDMA, 1 RB, 15 MHz, QPSK)	X	2.84	68.30	18.31	3.01	150.0	± 9.6 %
		Y	2.70	67.76	18.03		150.0	
		Z	2.72	68.30	18.45		150.0	
10182-CAD	LTE-FDD (SC-FDMA, 1 RB, 15 MHz, 16-QAM)	X	3.90	74.11	20.66	3.01	150.0	± 9.6 %
		Y	3.61	73.50	20.42		150.0	
		Z	3.86	75.20	21.30		150.0	
10183-AAC	LTE-FDD (SC-FDMA, 1 RB, 15 MHz, 64-QAM)	X	3.16	69.73	17.72	3.01	150.0	± 9.6 %
		Y	2.96	69.43	17.60		150.0	
		Z	3.04	70.18	18.03		150.0	

Certificate No: EX3-7461\_Jun18

Page 18 of 39

EX3DV4- SN:7461

June 25, 2018

10184-CAD	LTE-FDD (SC-FDMA, 1 RB, 3 MHz, QPSK)	X	2.85	68.35	18.33	3.01	150.0	± 9.6 %
		Y	2.71	67.81	18.05		150.0	
		Z	2.73	68.34	18.47		150.0	
10185-CAD	LTE-FDD (SC-FDMA, 1 RB, 3 MHz, 16-QAM)	X	3.92	74.19	20.70	3.01	150.0	± 9.6 %
		Y	3.63	73.58	20.46		150.0	
		Z	3.88	75.29	21.35		150.0	
10186-AAD	LTE-FDD (SC-FDMA, 1 RB, 3 MHz, 64-QAM)	X	3.17	69.80	17.75	3.01	150.0	± 9.6 %
		Y	2.97	69.49	17.63		150.0	
		Z	3.05	70.25	18.07		150.0	
10187-CAE	LTE-FDD (SC-FDMA, 1 RB, 1.4 MHz, QPSK)	X	2.86	68.40	18.40	3.01	150.0	± 9.6 %
		Y	2.72	67.86	18.12		150.0	
		Z	2.74	68.42	18.56		150.0	
10188-CAE	LTE-FDD (SC-FDMA, 1 RB, 1.4 MHz, 16-QAM)	X	4.06	74.94	21.13	3.01	150.0	± 9.6 %
		Y	3.75	74.25	20.85		150.0	
		Z	4.03	76.11	21.80		150.0	
10189-AAE	LTE-FDD (SC-FDMA, 1 RB, 1.4 MHz, 64-QAM)	X	3.24	70.24	18.04	3.01	150.0	± 9.6 %
		Y	3.04	69.91	17.91		150.0	
		Z	3.13	70.72	18.37		150.0	
10193-CAC	IEEE 802.11n (HT Greenfield, 6.5 Mbps, BPSK)	X	4.45	66.42	16.06	0.00	150.0	± 9.6 %
		Y	4.48	66.68	16.16		150.0	
		Z	4.34	66.52	16.02		150.0	
10194-CAC	IEEE 802.11n (HT Greenfield, 39 Mbps, 16-QAM)	X	4.62	66.74	16.19	0.00	150.0	± 9.6 %
		Y	4.65	66.98	16.29		150.0	
		Z	4.49	66.79	16.15		150.0	
10195-CAC	IEEE 802.11n (HT Greenfield, 65 Mbps, 64-QAM)	X	4.66	66.77	16.21	0.00	150.0	± 9.6 %
		Y	4.69	67.01	16.31		150.0	
		Z	4.53	66.82	16.17		150.0	
10196-CAC	IEEE 802.11n (HT Mixed, 6.5 Mbps, BPSK)	X	4.45	66.49	16.08	0.00	150.0	± 9.6 %
		Y	4.48	66.73	16.18		150.0	
		Z	4.33	66.54	16.02		150.0	
10197-CAC	IEEE 802.11n (HT Mixed, 39 Mbps, 16-QAM)	X	4.63	66.76	16.20	0.00	150.0	± 9.6 %
		Y	4.66	67.00	16.30		150.0	
		Z	4.50	66.80	16.16		150.0	
10198-CAC	IEEE 802.11n (HT Mixed, 65 Mbps, 64-QAM)	X	4.66	66.79	16.22	0.00	150.0	± 9.6 %
		Y	4.69	67.03	16.32		150.0	
		Z	4.52	66.83	16.18		150.0	
10219-CAC	IEEE 802.11n (HT Mixed, 7.2 Mbps, BPSK)	X	4.40	66.50	16.04	0.00	150.0	± 9.6 %
		Y	4.43	66.75	16.14		150.0	
		Z	4.28	66.57	15.98		150.0	
10220-CAC	IEEE 802.11n (HT Mixed, 43.3 Mbps, 16-QAM)	X	4.63	66.73	16.19	0.00	150.0	± 9.6 %
		Y	4.65	66.97	16.29		150.0	
		Z	4.49	66.77	16.15		150.0	
10221-CAC	IEEE 802.11n (HT Mixed, 72.2 Mbps, 64-QAM)	X	4.67	66.72	16.21	0.00	150.0	± 9.6 %
		Y	4.70	66.95	16.30		150.0	
		Z	4.54	66.76	16.17		150.0	
10222-CAC	IEEE 802.11n (HT Mixed, 15 Mbps, BPSK)	X	5.00	66.90	16.32	0.00	150.0	± 9.6 %
		Y	5.03	67.10	16.40		150.0	
		Z	4.90	66.90	16.31		150.0	

Certificate No: EX3-7461\_Jun18

Page 19 of 39

EX3DV4- SN:7461

June 25, 2018

10223-CAC	IEEE 802.11n (HT Mixed, 90 Mbps, 16-QAM)	X	5.31	67.13	16.46	0.00	150.0	± 9.6 %
		Y	5.33	67.32	16.53		150.0	
		Z	5.19	67.13	16.44		150.0	
10224-CAC	IEEE 802.11n (HT Mixed, 150 Mbps, 64-QAM)	X	5.05	67.01	16.31	0.00	150.0	± 9.6 %
		Y	5.07	67.21	16.39		150.0	
		Z	4.94	67.00	16.29		150.0	
10225-CAB	UMTS-FDD (HSPA+)	X	2.71	65.87	15.13	0.00	150.0	± 9.6 %
		Y	2.77	66.28	15.33		150.0	
		Z	2.60	65.89	14.82		150.0	
10226-CAA	LTE-TDD (SC-FDMA, 1 RB, 1.4 MHz, 16-QAM)	X	8.25	86.87	24.39	6.02	65.0	± 9.6 %
		Y	8.01	87.68	24.79		65.0	
		Z	8.32	89.35	25.59		65.0	
10227-CAA	LTE-TDD (SC-FDMA, 1 RB, 1.4 MHz, 64-QAM)	X	7.68	84.43	22.93	6.02	65.0	± 9.6 %
		Y	7.60	85.50	23.37		65.0	
		Z	7.98	87.32	24.21		65.0	
10228-CAA	LTE-TDD (SC-FDMA, 1 RB, 1.4 MHz, QPSK)	X	5.95	84.98	25.72	6.02	65.0	± 9.6 %
		Y	5.37	83.88	25.47		65.0	
		Z	5.05	83.83	25.77		65.0	
10229-CAB	LTE-TDD (SC-FDMA, 1 RB, 3 MHz, 16-QAM)	X	7.82	85.83	23.95	6.02	65.0	± 9.6 %
		Y	7.59	86.83	24.34		65.0	
		Z	7.78	88.05	25.06		65.0	
10230-CAB	LTE-TDD (SC-FDMA, 1 RB, 3 MHz, 64-QAM)	X	7.27	83.47	22.52	6.02	65.0	± 9.6 %
		Y	7.17	84.49	22.95		65.0	
		Z	7.42	86.04	23.70		65.0	
10231-CAB	LTE-TDD (SC-FDMA, 1 RB, 3 MHz, QPSK)	X	5.71	84.11	25.32	6.02	65.0	± 9.6 %
		Y	5.18	83.11	25.10		65.0	
		Z	4.84	82.94	25.35		65.0	
10232-CAD	LTE-TDD (SC-FDMA, 1 RB, 5 MHz, 16-QAM)	X	7.80	85.81	23.94	6.02	65.0	± 9.6 %
		Y	7.57	86.81	24.33		65.0	
		Z	7.78	88.02	25.05		65.0	
10233-CAD	LTE-TDD (SC-FDMA, 1 RB, 5 MHz, 64-QAM)	X	7.26	83.45	22.51	6.02	65.0	± 9.6 %
		Y	7.16	84.46	22.94		65.0	
		Z	7.40	86.01	23.69		65.0	
10234-CAD	LTE-TDD (SC-FDMA, 1 RB, 5 MHz, QPSK)	X	5.51	83.32	24.90	6.02	65.0	± 9.6 %
		Y	5.01	82.40	24.72		65.0	
		Z	4.68	82.18	24.94		65.0	
10235-CAD	LTE-TDD (SC-FDMA, 1 RB, 10 MHz, 16-QAM)	X	7.81	85.83	23.95	6.02	65.0	± 9.6 %
		Y	7.58	86.63	24.34		65.0	
		Z	7.77	88.06	25.06		65.0	
10236-CAD	LTE-TDD (SC-FDMA, 1 RB, 10 MHz, 64-QAM)	X	7.32	83.57	22.55	6.02	65.0	± 9.6 %
		Y	7.23	84.80	22.98		65.0	
		Z	7.48	86.16	23.73		65.0	
10237-CAD	LTE-TDD (SC-FDMA, 1 RB, 10 MHz, QPSK)	X	5.71	84.16	25.33	6.02	65.0	± 9.6 %
		Y	5.17	83.14	25.11		65.0	
		Z	4.84	82.97	25.37		65.0	
10238-CAD	LTE-TDD (SC-FDMA, 1 RB, 15 MHz, 16-QAM)	X	7.78	85.78	23.93	6.02	65.0	± 9.6 %
		Y	7.55	86.58	24.32		65.0	
		Z	7.74	87.99	25.04		65.0	

Certificate No: EX3-7461\_Jun18

Page 20 of 39

EX3DV4- SN:7461

June 25, 2018

10239-CAD	LTE-TDD (SC-FDMA, 1 RB, 15 MHz, 64-QAM)	X	7.23	83.42	22.50	6.02	65.0	± 9.6 %
		Y	7.13	84.43	22.93		65.0	
		Z	7.37	85.97	23.68		65.0	
10240-CAD	LTE-TDD (SC-FDMA, 1 RB, 15 MHz, QPSK)	X	5.69	84.11	25.32	6.02	65.0	± 9.6 %
		Y	5.16	83.10	25.10		65.0	
		Z	4.83	82.94	25.35		65.0	
10241-CAA	LTE-TDD (SC-FDMA, 50% RB, 1.4 MHz, 16-QAM)	X	6.67	77.25	23.41	6.98	65.0	± 9.6 %
		Y	6.58	77.78	23.67		65.0	
		Z	6.62	78.73	24.14		65.0	
10242-CAA	LTE-TDD (SC-FDMA, 50% RB, 1.4 MHz, 64-QAM)	X	5.99	75.04	22.38	6.98	65.0	± 9.6 %
		Y	6.29	76.90	23.23		65.0	
		Z	5.82	76.15	22.98		65.0	
10243-CAA	LTE-TDD (SC-FDMA, 50% RB, 1.4 MHz, QPSK)	X	5.00	72.32	22.05	6.98	65.0	± 9.6 %
		Y	5.24	73.96	22.86		65.0	
		Z	4.83	72.93	22.47		65.0	
10244-CAB	LTE-TDD (SC-FDMA, 50% RB, 3 MHz, 16-QAM)	X	4.08	70.55	15.80	3.98	65.0	± 9.6 %
		Y	3.95	70.22	15.38		65.0	
		Z	3.53	68.93	14.31		65.0	
10245-CAB	LTE-TDD (SC-FDMA, 50% RB, 3 MHz, 64-QAM)	X	4.03	70.13	15.56	3.98	65.0	± 9.6 %
		Y	3.90	69.77	15.12		65.0	
		Z	3.47	68.42	14.02		65.0	
10246-CAB	LTE-TDD (SC-FDMA, 50% RB, 3 MHz, QPSK)	X	3.58	72.46	16.90	3.98	65.0	± 9.6 %
		Y	3.89	73.84	17.55		65.0	
		Z	3.02	70.40	15.36		65.0	
10247-CAD	LTE-TDD (SC-FDMA, 50% RB, 5 MHz, 16-QAM)	X	3.83	70.23	16.70	3.98	65.0	± 9.6 %
		Y	4.00	71.00	17.02		65.0	
		Z	3.46	69.13	15.59		65.0	
10248-CAD	LTE-TDD (SC-FDMA, 50% RB, 5 MHz, 64-QAM)	X	3.88	69.89	16.53	3.98	65.0	± 9.6 %
		Y	4.02	70.55	16.80		65.0	
		Z	3.48	68.72	15.39		65.0	
10249-CAD	LTE-TDD (SC-FDMA, 50% RB, 5 MHz, QPSK)	X	4.50	75.86	19.32	3.98	65.0	± 9.6 %
		Y	4.90	77.45	20.05		65.0	
		Z	4.15	75.16	18.65		65.0	
10250-CAD	LTE-TDD (SC-FDMA, 50% RB, 10 MHz, 16-QAM)	X	4.68	72.80	19.57	3.98	65.0	± 9.6 %
		Y	4.86	73.57	19.92		65.0	
		Z	4.47	72.66	19.29		65.0	
10251-CAD	LTE-TDD (SC-FDMA, 50% RB, 10 MHz, 64-QAM)	X	4.56	71.05	18.41	3.98	65.0	± 9.6 %
		Y	4.71	71.76	18.74		65.0	
		Z	4.30	70.71	18.00		65.0	
10252-CAD	LTE-TDD (SC-FDMA, 50% RB, 10 MHz, QPSK)	X	5.00	76.36	20.55	3.98	65.0	± 9.6 %
		Y	5.34	77.71	21.21		65.0	
		Z	4.82	76.59	20.57		65.0	
10253-CAD	LTE-TDD (SC-FDMA, 50% RB, 15 MHz, 16-QAM)	X	4.72	70.44	18.51	3.98	65.0	± 9.6 %
		Y	4.87	71.13	18.85		65.0	
		Z	4.52	70.31	18.32		65.0	
10254-CAD	LTE-TDD (SC-FDMA, 50% RB, 15 MHz, 64-QAM)	X	5.02	71.32	19.24	3.98	65.0	± 9.6 %
		Y	5.18	72.00	19.56		65.0	
		Z	4.83	71.26	19.09		65.0	

Certificate No: EX3-7461\_Jun18

Page 21 of 39

EX3DV4- SN:7461

June 25, 2018

10255-CAD	LTE-TDD (SC-FDMA, 50% RB, 15 MHz, QPSK)	X	4.96	73.91	19.80	3.98	65.0	± 9.6 %
		Y	5.22	74.98	20.35		65.0	
		Z	4.81	74.15	19.91		65.0	
10256-CAA	LTE-TDD (SC-FDMA, 100% RB, 1.4 MHz, 16-QAM)	X	3.11	66.86	12.96	3.98	65.0	± 9.6 %
		Y	2.96	66.40	12.44		65.0	
		Z	2.54	64.72	11.01		65.0	
10257-CAA	LTE-TDD (SC-FDMA, 100% RB, 1.4 MHz, 64-QAM)	X	3.09	66.44	12.66	3.98	65.0	± 9.6 %
		Y	2.93	65.96	12.13		65.0	
		Z	2.51	64.30	10.89		65.0	
10258-CAA	LTE-TDD (SC-FDMA, 100% RB, 1.4 MHz, QPSK)	X	2.68	66.22	14.08	3.98	65.0	± 9.6 %
		Y	2.84	69.09	14.50		65.0	
		Z	2.14	65.56	11.95		65.0	
10259-CAB	LTE-TDD (SC-FDMA, 100% RB, 3 MHz, 16-QAM)	X	4.17	71.24	17.77	3.98	65.0	± 9.6 %
		Y	4.35	72.04	18.11		65.0	
		Z	3.87	70.57	17.00		65.0	
10260-CAB	LTE-TDD (SC-FDMA, 100% RB, 3 MHz, 64-QAM)	X	4.23	71.08	17.70	3.98	65.0	± 9.6 %
		Y	4.39	71.82	18.01		65.0	
		Z	3.91	70.37	16.90		65.0	
10261-CAB	LTE-TDD (SC-FDMA, 100% RB, 3 MHz, QPSK)	X	4.51	75.38	19.57	3.98	65.0	± 9.6 %
		Y	4.85	76.79	20.24		65.0	
		Z	4.26	75.13	19.19		65.0	
10262-CAD	LTE-TDD (SC-FDMA, 100% RB, 5 MHz, 16-QAM)	X	4.67	72.75	19.53	3.98	65.0	± 9.6 %
		Y	4.85	73.52	19.88		65.0	
		Z	4.46	72.59	19.24		65.0	
10263-CAD	LTE-TDD (SC-FDMA, 100% RB, 5 MHz, 64-QAM)	X	4.55	71.03	18.41	3.98	65.0	± 9.6 %
		Y	4.70	71.74	18.73		65.0	
		Z	4.29	70.69	18.00		65.0	
10264-CAD	LTE-TDD (SC-FDMA, 100% RB, 5 MHz, QPSK)	X	4.95	76.19	20.45	3.98	65.0	± 9.6 %
		Y	5.29	77.52	21.11		65.0	
		Z	4.78	76.39	20.47		65.0	
10265-CAD	LTE-TDD (SC-FDMA, 100% RB, 10 MHz, 16-QAM)	X	4.80	70.92	18.74	3.98	65.0	± 9.6 %
		Y	4.95	71.58	19.08		65.0	
		Z	4.58	70.68	18.57		65.0	
10266-CAD	LTE-TDD (SC-FDMA, 100% RB, 10 MHz, 64-QAM)	X	5.13	71.85	19.55	3.98	65.0	± 9.6 %
		Y	5.28	72.52	19.87		65.0	
		Z	4.93	71.75	19.44		65.0	
10267-CAD	LTE-TDD (SC-FDMA, 100% RB, 10 MHz, QPSK)	X	5.18	74.49	19.81	3.98	65.0	± 9.6 %
		Y	5.48	75.62	20.40		65.0	
		Z	5.01	74.70	19.96		65.0	
10268-CAD	LTE-TDD (SC-FDMA, 100% RB, 15 MHz, 16-QAM)	X	5.46	71.10	19.25	3.98	65.0	± 9.6 %
		Y	5.60	71.70	19.56		65.0	
		Z	5.26	70.93	19.18		65.0	
10269-CAD	LTE-TDD (SC-FDMA, 100% RB, 15 MHz, 64-QAM)	X	5.48	70.75	19.15	3.98	65.0	± 9.6 %
		Y	5.60	71.35	19.45		65.0	
		Z	5.27	70.61	19.08		65.0	
10270-CAD	LTE-TDD (SC-FDMA, 100% RB, 15 MHz, QPSK)	X	5.33	72.60	19.18	3.98	65.0	± 9.6 %
		Y	5.55	73.49	19.65		65.0	
		Z	5.17	72.73	19.31		65.0	

Certificate No: EX3-7461\_Jun18

Page 22 of 39

EX3DV4- SN:7461

June 25, 2018

10274-CAB	UMTS-FDD (HSUPA, Subtest 5, 3GPP Rel8.10)	X	2.49	66.16	14.99	0.00	150.0	± 9.6 %
		Y	2.57	66.72	15.29		150.0	
		Z	2.42	66.34	14.77		150.0	
10275-CAB	UMTS-FDD (HSUPA, Subtest 5, 3GPP Rel8.4)	X	1.50	67.42	15.05	0.00	150.0	± 9.6 %
		Y	1.61	68.31	15.74		150.0	
		Z	1.44	67.29	14.81		150.0	
10277-CAA	PHS (QPSK)	X	1.84	60.33	5.94	9.03	50.0	± 9.6 %
		Y	1.76	60.34	5.87		50.0	
		Z	1.69	59.77	5.26		50.0	
10278-CAA	PHS (QPSK, BW 884MHz, Rolloff 0.5)	X	3.26	67.16	12.28	9.03	50.0	± 9.6 %
		Y	3.35	68.03	12.75		50.0	
		Z	2.82	65.15	10.73		50.0	
10279-CAA	PHS (QPSK, BW 884MHz, Rolloff 0.38)	X	3.37	67.46	12.48	9.03	50.0	± 9.6 %
		Y	3.46	68.35	12.96		50.0	
		Z	2.90	65.39	10.91		50.0	
10290-AAB	CDMA2000, RC1, SO55, Full Rate	X	1.23	66.91	12.54	0.00	150.0	± 9.6 %
		Y	1.43	69.01	13.86		150.0	
		Z	0.93	64.56	10.47		150.0	
10291-AAB	CDMA2000, RC3, SO55, Full Rate	X	0.67	64.03	10.74	0.00	150.0	± 9.6 %
		Y	0.81	66.08	12.35		150.0	
		Z	0.54	62.38	8.93		150.0	
10292-AAB	CDMA2000, RC3, SO32, Full Rate	X	0.85	67.73	12.94	0.00	150.0	± 9.6 %
		Y	1.18	71.88	15.44		150.0	
		Z	0.67	65.35	10.81		150.0	
10293-AAB	CDMA2000, RC3, SO3, Full Rate	X	1.49	75.06	18.58	0.00	150.0	± 9.6 %
		Y	2.57	82.89	20.13		150.0	
		Z	1.19	72.07	14.29		150.0	
10295-AAB	CDMA2000, RC1, SO3, 1/8th Rate 25 fr.	X	6.97	79.32	20.73	9.03	50.0	± 9.6 %
		Y	7.68	81.69	21.81		50.0	
		Z	6.76	82.04	20.97		50.0	
10297-AAC	LTE-FDD (SC-FDMA, 50% RB, 20 MHz, QPSK)	X	2.65	69.35	16.32	0.00	150.0	± 9.6 %
		Y	2.74	69.92	16.75		150.0	
		Z	2.52	69.13	16.23		150.0	
10298-AAC	LTE-FDD (SC-FDMA, 50% RB, 3 MHz, QPSK)	X	1.40	66.59	13.17	0.00	150.0	± 9.6 %
		Y	1.53	67.82	13.97		150.0	
		Z	1.14	64.79	11.45		150.0	
10299-AAC	LTE-FDD (SC-FDMA, 50% RB, 3 MHz, 16-QAM)	X	2.21	67.38	12.90	0.00	150.0	± 9.6 %
		Y	2.06	66.69	12.32		150.0	
		Z	1.80	65.47	11.07		150.0	
10300-AAC	LTE-FDD (SC-FDMA, 50% RB, 3 MHz, 64-QAM)	X	1.74	63.79	10.41	0.00	150.0	± 9.6 %
		Y	1.63	63.36	9.93		150.0	
		Z	1.41	62.29	8.71		150.0	
10301-AAA	IEEE 802.16e WiMAX (29:18, 5ms, 10MHz, QPSK, PUSC)	X	4.52	64.78	17.13	4.17	50.0	± 9.6 %
		Y	4.46	64.68	17.05		50.0	
		Z	4.38	64.98	17.04		50.0	
10302-AAA	IEEE 802.16e WiMAX (29:18, 5ms, 10MHz, QPSK, PUSC, 3 CTRL symbols)	X	4.98	65.33	17.79	4.96	50.0	± 9.6 %
		Y	4.97	65.49	17.86		50.0	
		Z	4.84	65.49	17.68		50.0	

Certificate No: EX3-7461\_Jun18

Page 23 of 39



EX3DV4- SN:7461

June 25, 2018

10303-AAA	IEEE 802.16e WiMAX (31:15, 5ms, 10MHz, 64QAM, PUSC)	X	4.72	64.91	17.60	4.96	50.0	± 9.6 %
		Y	4.71	65.06	17.65		50.0	
		Z	4.59	65.09	17.46		50.0	
10304-AAA	IEEE 802.16e WiMAX (29:18, 5ms, 10MHz, 64QAM, PUSC)	X	4.54	64.83	17.12	4.17	50.0	± 9.6 %
		Y	4.54	65.02	17.20		50.0	
		Z	4.42	65.04	17.02		50.0	
10305-AAA	IEEE 802.16e WiMAX (31:15, 10ms, 10MHz, 64QAM, PUSC, 15 symbols)	X	4.07	66.07	18.79	6.02	35.0	± 9.6 %
		Y	4.00	65.87	18.65		35.0	
		Z	4.01	66.61	18.58		35.0	
10306-AAA	IEEE 802.16e WiMAX (29:18, 10ms, 10MHz, 64QAM, PUSC, 18 symbols)	X	4.44	65.39	18.52	6.02	35.0	± 9.6 %
		Y	4.40	65.34	18.46		35.0	
		Z	4.35	65.82	18.40		35.0	
10307-AAA	IEEE 802.16e WiMAX (29:18, 10ms, 10MHz, QPSK, PUSC, 18 symbols)	X	4.33	65.51	18.47	6.02	35.0	± 9.6 %
		Y	4.28	65.40	18.38		35.0	
		Z	4.23	65.87	18.31		35.0	
10308-AAA	IEEE 802.16e WiMAX (29:18, 10ms, 10MHz, 16QAM, PUSC)	X	4.30	65.66	18.59	6.02	35.0	± 9.6 %
		Y	4.25	65.55	18.50		35.0	
		Z	4.21	66.06	18.44		35.0	
10309-AAA	IEEE 802.16e WiMAX (29:18, 10ms, 10MHz, 16QAM, AMC 2x3, 18 symbols)	X	4.49	65.60	18.67	6.02	35.0	± 9.6 %
		Y	4.44	65.52	18.59		35.0	
		Z	4.38	65.95	18.51		35.0	
10310-AAA	IEEE 802.16e WiMAX (29:18, 10ms, 10MHz, QPSK, AMC 2x3, 18 symbols)	X	4.38	65.43	18.49	6.02	35.0	± 9.6 %
		Y	4.34	65.36	18.42		35.0	
		Z	4.30	65.87	18.36		35.0	
10311-AAC	LTE-FDD (SC-FDMA, 100% RB, 15 MHz, QPSK)	X	3.00	68.61	15.99	0.00	150.0	± 9.6 %
		Y	3.10	69.18	16.39		150.0	
		Z	2.87	68.36	15.91		150.0	
10313-AAA	IDEN 1:3	X	1.88	66.20	12.36	6.99	70.0	± 9.6 %
		Y	2.32	69.19	14.25		70.0	
		Z	1.90	66.73	12.77		70.0	
10314-AAA	IDEN 1:6	X	2.68	70.80	17.06	10.00	30.0	± 9.6 %
		Y	3.48	75.84	19.82		30.0	
		Z	2.99	72.88	18.10		30.0	
10315-AAB	IEEE 802.11b WiFi 2.4 GHz (DSSS, 1 Mbps, 96pc duty cycle)	X	0.96	63.06	14.66	0.17	150.0	± 9.6 %
		Y	1.05	63.65	15.13		150.0	
		Z	0.96	63.09	14.58		150.0	
10316-AAB	IEEE 802.11g WiFi 2.4 GHz (ERP-OFDM, 6 Mbps, 96pc duty cycle)	X	4.48	66.38	16.13	0.17	150.0	± 9.6 %
		Y	4.51	66.62	16.22		150.0	
		Z	4.36	66.45	16.09		150.0	
10317-AAC	IEEE 802.11a WiFi 5 GHz (OFDM, 6 Mbps, 96pc duty cycle)	X	4.48	66.36	16.13	0.17	150.0	± 9.6 %
		Y	4.51	66.62	16.22		150.0	
		Z	4.36	66.45	16.09		150.0	
10400-AAD	IEEE 802.11ac WiFi (20MHz, 64-QAM, 99pc duty cycle)	X	4.61	66.79	16.18	0.00	150.0	± 9.6 %
		Y	4.63	67.02	16.28		150.0	
		Z	4.46	66.81	16.13		150.0	
10401-AAD	IEEE 802.11ac WiFi (40MHz, 64-QAM, 99pc duty cycle)	X	5.34	67.06	16.40	0.00	150.0	± 9.6 %
		Y	5.34	67.17	16.43		150.0	
		Z	5.18	66.92	16.30		150.0	

Certificate No: EX3-7461\_Jun18

Page 24 of 39

EX3DV4-SN:7461

June 25, 2018

10402-AAD	IEEE 802.11ac WiFi (80MHz, 64-QAM, 99pc duty cycle)	X	5.57	67.29	16.37	0.00	150.0	± 9.6 %
		Y	5.59	67.47	16.44		150.0	
		Z	5.46	67.23	16.34		150.0	
10403-AAB	CDMA2000 (1xEV-DO, Rev. 0)	X	1.23	66.91	12.54	0.00	115.0	± 9.6 %
		Y	1.43	69.01	13.86		115.0	
		Z	0.93	64.56	10.47		115.0	
10404-AAB	CDMA2000 (1xEV-DO, Rev. A)	X	1.23	66.91	12.54	0.00	115.0	± 9.6 %
		Y	1.43	69.01	13.86		115.0	
		Z	0.93	64.56	10.47		115.0	
10406-AAB	CDMA2000, RC3, SC32, SCH0, Full Rate	X	24.39	101.98	25.27	0.00	100.0	± 9.6 %
		Y	40.20	107.45	28.03		100.0	
		Z	100.00	-116.61	27.49		100.0	
10410-AAD	LTE-TDD (SC-FDMA, 1 RB, 10 MHz, QPSK, UL Subframe=2,3,4,7,8,9, Subframe Conf=4)	X	5.46	82.47	18.70	3.23	80.0	± 9.6 %
		Y	5.02	82.19	18.66		80.0	
		Z	9.40	90.96	21.38		80.0	
10415-AAA	IEEE 802.11b WiFi 2.4 GHz (DSSS, 1 Mbps, 99pc duty cycle)	X	0.92	62.55	14.28	0.00	150.0	± 9.6 %
		Y	1.00	63.16	14.76		150.0	
		Z	0.92	62.60	14.20		150.0	
10416-AAA	IEEE 802.11g WiFi 2.4 GHz (ERP-OFDM, 6 Mbps, 99pc duty cycle)	X	4.45	66.46	16.13	0.00	150.0	± 9.6 %
		Y	4.49	66.72	16.23		150.0	
		Z	4.34	66.54	16.09		150.0	
10417-AAB	IEEE 802.11a/h WiFi 5 GHz (OFDM, 6 Mbps, 99pc duty cycle)	X	4.45	66.46	16.13	0.00	150.0	± 9.6 %
		Y	4.49	66.72	16.23		150.0	
		Z	4.34	66.54	16.09		150.0	
10418-AAA	IEEE 802.11g WiFi 2.4 GHz (DSSS-OFDM, 6 Mbps, 99pc duty cycle, Long preamble)	X	4.44	66.62	16.15	0.00	150.0	± 9.6 %
		Y	4.48	66.89	16.27		150.0	
		Z	4.33	66.73	16.13		150.0	
10419-AAA	IEEE 802.11g WiFi 2.4 GHz (DSSS-OFDM, 6 Mbps, 99pc duty cycle, Short preamble)	X	4.46	66.57	16.15	0.00	150.0	± 9.6 %
		Y	4.50	66.83	16.26		150.0	
		Z	4.35	66.67	16.13		150.0	
10422-AAB	IEEE 802.11n (HT Greenfield, 7.2 Mbps, BPSK)	X	4.58	66.57	16.17	0.00	150.0	± 9.6 %
		Y	4.61	66.82	16.27		150.0	
		Z	4.46	66.65	16.14		150.0	
10423-AAB	IEEE 802.11n (HT Greenfield, 43.3 Mbps, 16-QAM)	X	4.74	66.89	16.29	0.00	150.0	± 9.6 %
		Y	4.77	67.12	16.38		150.0	
		Z	4.60	66.92	16.24		150.0	
10424-AAB	IEEE 802.11n (HT Greenfield, 72.2 Mbps, 64-QAM)	X	4.66	66.84	16.26	0.00	150.0	± 9.6 %
		Y	4.69	67.08	16.35		150.0	
		Z	4.52	66.68	16.21		150.0	
10425-AAB	IEEE 802.11n (HT Greenfield, 15 Mbps, BPSK)	X	5.28	67.20	16.47	0.00	150.0	± 9.6 %
		Y	5.29	67.32	16.51		150.0	
		Z	5.15	67.15	16.43		150.0	
10426-AAB	IEEE 802.11n (HT Greenfield, 90 Mbps, 16-QAM)	X	5.30	67.25	16.49	0.00	150.0	± 9.6 %
		Y	5.30	67.38	16.54		150.0	
		Z	5.17	67.24	16.47		150.0	

Certificate No: EX3-7461\_Jun18

Page 25 of 39

EX3DV4- SN:7461

June 25, 2018

10427-AAB	IEEE 802.11n (HT Greenfield, 150 Mbps, 64-QAM)	X	5.30	67.20	16.46	0.00	150.0	± 9.6 %
		Y	5.31	67.33	16.51		150.0	
		Z	5.15	67.08	16.39		150.0	
10430-AAB	LTE-FDD (OFDMA, 5 MHz, E-TM 3.1)	X	4.25	71.12	18.31	0.00	150.0	± 9.6 %
		Y	4.30	71.50	18.43		150.0	
		Z	4.20	71.89	18.32		150.0	
10431-AAB	LTE-FDD (OFDMA, 10 MHz, E-TM 3.1)	X	4.13	67.01	16.10	0.00	150.0	± 9.6 %
		Y	4.15	67.30	16.22		150.0	
		Z	3.97	67.09	15.98		150.0	
10432-AAB	LTE-FDD (OFDMA, 15 MHz, E-TM 3.1)	X	4.43	66.89	16.19	0.00	150.0	± 9.6 %
		Y	4.46	67.14	16.30		150.0	
		Z	4.28	66.95	16.13		150.0	
10433-AAB	LTE-FDD (OFDMA, 20 MHz, E-TM 3.1)	X	4.68	66.87	16.28	0.00	150.0	± 9.6 %
		Y	4.70	67.11	16.37		150.0	
		Z	4.54	66.91	16.23		150.0	
10434-AAA	W-CDMA (BS Test Model 1, 64 DPCH)	X	4.37	72.02	18.26	0.00	150.0	± 9.6 %
		Y	4.44	72.52	18.42		150.0	
		Z	4.32	72.76	18.14		150.0	
10435-AAC	LTE-TDD (SC-FDMA, 1 RB, 20 MHz, QPSK, UL Subframe=2,3,4,7,8,9)	X	5.16	81.89	18.39	3.23	80.0	± 9.6 %
		Y	4.77	81.47	18.37		80.0	
		Z	6.44	89.50	20.90		80.0	
10447-AAB	LTE-FDD (OFDMA, 5 MHz, E-TM 3.1, Clipping 44%)	X	3.40	66.95	15.32	0.00	150.0	± 9.6 %
		Y	3.44	67.33	15.48		150.0	
		Z	3.21	66.87	14.89		150.0	
10448-AAB	LTE-FDD (OFDMA, 10 MHz, E-TM 3.1, Clipping 44%)	X	3.97	66.79	15.96	0.00	150.0	± 9.6 %
		Y	4.00	67.09	16.09		150.0	
		Z	3.82	66.88	15.84		150.0	
10449-AAB	LTE-FDD (OFDMA, 15 MHz, E-TM 3.1, Clipping 44%)	X	4.24	66.71	16.09	0.00	150.0	± 9.6 %
		Y	4.28	66.98	16.20		150.0	
		Z	4.12	66.78	16.03		150.0	
10450-AAB	LTE-FDD (OFDMA, 20 MHz, E-TM 3.1, Clipping 44%)	X	4.44	66.63	16.13	0.00	150.0	± 9.6 %
		Y	4.48	66.89	16.23		150.0	
		Z	4.33	66.68	16.08		150.0	
10451-AAA	W-CDMA (BS Test Model 1, 64 DPCH, Clipping 44%)	X	3.28	67.04	14.86	0.00	150.0	± 9.6 %
		Y	3.32	67.44	15.03		150.0	
		Z	3.03	66.70	14.20		150.0	
10456-AAB	IEEE 802.11ac WiFi (160MHz, 64-QAM, 99pc duty cycle)	X	6.15	67.73	16.62	0.00	150.0	± 9.6 %
		Y	6.17	67.88	16.67		150.0	
		Z	6.10	67.84	16.67		150.0	
10457-AAA	UMTS-FDD (DC-HSDPA)	X	3.71	65.09	15.84	0.00	150.0	± 9.6 %
		Y	3.76	66.37	15.94		150.0	
		Z	3.66	65.23	15.81		150.0	
10458-AAA	CDMA2000 (1xEV-DO, Rev. B, 2 carriers)	X	3.96	71.04	17.50	0.00	150.0	± 9.6 %
		Y	4.05	71.63	17.69		150.0	
		Z	3.78	71.18	16.92		150.0	
10459-AAA	CDMA2000 (1xEV-DO, Rev. B, 3 carriers)	X	5.11	68.75	18.36	0.00	150.0	± 9.6 %
		Y	5.09	68.88	18.28		150.0	
		Z	4.96	69.24	18.19		150.0	

EX3DV4- SN:7461

June 25, 2018

10460-AAA	UMTS-FDD (WCDMA, AMR)	X	0.80	67.71	15.39	0.00	150.0	± 9.6 %
		Y	0.91	68.88	16.50		150.0	
		Z	0.77	67.50	15.14		150.0	
10461-AAA	LTE-TDD (SC-FDMA, 1 RB, 1.4 MHz, QPSK, UL Subframe=2,3,4,7,8,9)	X	3.50	78.77	18.38	3.29	80.0	± 9.6 %
		Y	2.29	74.36	16.96		80.0	
		Z	6.11	88.07	21.59		80.0	
10462-AAA	LTE-TDD (SC-FDMA, 1 RB, 1.4 MHz, 16-QAM, UL Subframe=2,3,4,7,8,9)	X	0.89	60.00	7.67	3.23	80.0	± 9.6 %
		Y	0.81	60.00	7.46		80.0	
		Z	0.77	60.00	7.28		80.0	
10463-AAA	LTE-TDD (SC-FDMA, 1 RB, 1.4 MHz, 64-QAM, UL Subframe=2,3,4,7,8,9)	X	0.91	60.00	7.17	3.23	80.0	± 9.6 %
		Y	0.83	60.00	6.91		80.0	
		Z	0.79	60.00	6.69		80.0	
10464-AAA	LTE-TDD (SC-FDMA, 1 RB, 3 MHz, QPSK, UL Subframe=2,3,4,7,8,9)	X	2.35	73.37	15.83	3.23	80.0	± 9.6 %
		Y	1.74	70.84	14.94		80.0	
		Z	3.31	79.36	18.09		80.0	
10465-AAA	LTE-TDD (SC-FDMA, 1 RB, 3 MHz, 16-QAM, UL Subframe=2,3,4,7,8,9)	X	0.89	60.00	7.60	3.23	80.0	± 9.6 %
		Y	0.81	60.00	7.39		80.0	
		Z	0.77	60.00	7.21		80.0	
10466-AAA	LTE-TDD (SC-FDMA, 1 RB, 3 MHz, 64-QAM, UL Subframe=2,3,4,7,8,9)	X	0.92	60.00	7.13	3.23	80.0	± 9.6 %
		Y	0.84	60.00	6.86		80.0	
		Z	0.80	60.00	6.65		80.0	
10467-AAC	LTE-TDD (SC-FDMA, 1 RB, 5 MHz, QPSK, UL Subframe=2,3,4,7,8,9)	X	2.51	74.20	16.16	3.23	80.0	± 9.6 %
		Y	1.82	71.25	15.21		80.0	
		Z	3.76	81.01	18.67		80.0	
10468-AAC	LTE-TDD (SC-FDMA, 1 RB, 5 MHz, 16-QAM, UL Subframe=2,3,4,7,8,9)	X	0.89	60.00	7.62	3.23	80.0	± 9.6 %
		Y	0.81	60.00	7.40		80.0	
		Z	0.77	60.00	7.23		80.0	
10469-AAC	LTE-TDD (SC-FDMA, 1 RB, 5 MHz, 64-QAM, UL Subframe=2,3,4,7,8,9)	X	0.91	60.00	7.12	3.23	80.0	± 9.6 %
		Y	0.84	60.00	6.86		80.0	
		Z	0.80	60.00	6.65		80.0	
10470-AAC	LTE-TDD (SC-FDMA, 1 RB, 10 MHz, QPSK, UL Subframe=2,3,4,7,8,9)	X	2.49	74.17	16.14	3.23	80.0	± 9.6 %
		Y	1.81	71.22	15.19		80.0	
		Z	3.76	81.03	18.66		80.0	
10471-AAC	LTE-TDD (SC-FDMA, 1 RB, 10 MHz, 16-QAM, UL Subframe=2,3,4,7,8,9)	X	0.89	60.00	7.61	3.23	80.0	± 9.6 %
		Y	0.81	60.00	7.39		80.0	
		Z	0.77	60.00	7.21		80.0	
10472-AAC	LTE-TDD (SC-FDMA, 1 RB, 10 MHz, 64-QAM, UL Subframe=2,3,4,7,8,9)	X	0.91	60.00	7.11	3.23	80.0	± 9.6 %
		Y	0.83	60.00	6.84		80.0	
		Z	0.79	60.00	6.63		80.0	
10473-AAC	LTE-TDD (SC-FDMA, 1 RB, 15 MHz, QPSK, UL Subframe=2,3,4,7,8,9)	X	2.49	74.12	16.12	3.23	80.0	± 9.6 %
		Y	1.80	71.19	15.17		80.0	
		Z	3.73	80.93	18.62		80.0	
10474-AAC	LTE-TDD (SC-FDMA, 1 RB, 15 MHz, 16-QAM, UL Subframe=2,3,4,7,8,9)	X	0.89	60.00	7.60	3.23	80.0	± 9.6 %
		Y	0.81	60.00	7.39		80.0	
		Z	0.77	60.00	7.21		80.0	
10475-AAC	LTE-TDD (SC-FDMA, 1 RB, 15 MHz, 64-QAM, UL Subframe=2,3,4,7,8,9)	X	0.91	60.00	7.11	3.23	80.0	± 9.6 %
		Y	0.83	60.00	6.84		80.0	
		Z	0.79	60.00	6.63		80.0	

Certificate No: EX3-7461\_Jun18

Page 27 of 39

EX3DV4- SN:7461

June 25, 2018

10477-AAC	LTE-TDD (SC-FDMA, 1 RB, 20 MHz, 16-QAM, UL Subframe=2,3,4,7,8,9)	X	0.89	60.00	7.58	3.23	80.0	± 9.6 %
		Y	0.81	60.00	7.36		80.0	
		Z	0.77	60.00	7.19		80.0	
10478-AAC	LTE-TDD (SC-FDMA, 1 RB, 20 MHz, 64-QAM, UL Subframe=2,3,4,7,8,9)	X	0.91	60.00	7.10	3.23	80.0	± 9.6 %
		Y	0.83	60.00	6.83		80.0	
		Z	0.79	60.00	6.62		80.0	
10479-AAA	LTE-TDD (SC-FDMA, 50% RB, 1.4 MHz, QPSK, UL Subframe=2,3,4,7,8,9)	X	3.64	75.28	18.56	3.23	80.0	± 9.6 %
		Y	3.23	73.92	17.94		80.0	
		Z	5.55	82.54	20.87		80.0	
10480-AAA	LTE-TDD (SC-FDMA, 50% RB, 1.4 MHz, 16-QAM, UL Subframe=2,3,4,7,8,9)	X	3.01	69.07	14.38	3.23	80.0	± 9.6 %
		Y	2.69	68.28	13.86		80.0	
		Z	2.91	69.69	14.04		80.0	
10481-AAA	LTE-TDD (SC-FDMA, 50% RB, 1.4 MHz, 64-QAM, UL Subframe=2,3,4,7,8,9)	X	2.55	66.71	13.02	3.23	80.0	± 9.6 %
		Y	2.28	65.96	12.50		80.0	
		Z	2.20	66.08	12.13		80.0	
10482-AAA	LTE-TDD (SC-FDMA, 50% RB, 3 MHz, QPSK, UL Subframe=2,3,4,7,8,9)	X	1.82	66.03	13.69	2.23	80.0	± 9.6 %
		Y	2.01	67.44	14.45		80.0	
		Z	1.47	64.05	12.06		80.0	
10483-AAA	LTE-TDD (SC-FDMA, 50% RB, 3 MHz, 16-QAM, UL Subframe=2,3,4,7,8,9)	X	2.45	66.11	13.23	2.23	80.0	± 9.6 %
		Y	2.21	65.04	12.48		80.0	
		Z	1.92	63.84	11.37		80.0	
10484-AAA	LTE-TDD (SC-FDMA, 50% RB, 3 MHz, 64-QAM, UL Subframe=2,3,4,7,8,9)	X	2.41	65.64	13.02	2.23	80.0	± 9.6 %
		Y	2.18	64.61	12.28		80.0	
		Z	1.88	63.35	11.13		80.0	
10485-AAC	LTE-TDD (SC-FDMA, 50% RB, 5 MHz, QPSK, UL Subframe=2,3,4,7,8,9)	X	2.24	68.35	15.79	2.23	80.0	± 9.6 %
		Y	2.43	69.62	16.49		80.0	
		Z	2.04	67.80	15.16		80.0	
10486-AAC	LTE-TDD (SC-FDMA, 50% RB, 5 MHz, 16-QAM, UL Subframe=2,3,4,7,8,9)	X	2.37	65.77	14.14	2.23	80.0	± 9.6 %
		Y	2.51	66.70	14.60		80.0	
		Z	2.08	64.71	13.04		80.0	
10487-AAC	LTE-TDD (SC-FDMA, 50% RB, 5 MHz, 64-QAM, UL Subframe=2,3,4,7,8,9)	X	2.40	65.54	14.03	2.23	80.0	± 9.6 %
		Y	2.53	66.41	14.45		80.0	
		Z	2.10	64.45	12.89		80.0	
10488-AAC	LTE-TDD (SC-FDMA, 50% RB, 10 MHz, QPSK, UL Subframe=2,3,4,7,8,9)	X	2.71	68.87	16.83	2.23	80.0	± 9.6 %
		Y	2.85	69.71	17.34		80.0	
		Z	2.56	68.76	16.72		80.0	
10489-AAC	LTE-TDD (SC-FDMA, 50% RB, 10 MHz, 16-QAM, UL Subframe=2,3,4,7,8,9)	X	2.66	68.53	15.87	2.23	80.0	± 9.6 %
		Y	2.97	67.20	16.22		80.0	
		Z	2.72	66.52	15.65		80.0	
10490-AAC	LTE-TDD (SC-FDMA, 50% RB, 10 MHz, 64-QAM, UL Subframe=2,3,4,7,8,9)	X	2.96	66.49	15.87	2.23	80.0	± 9.6 %
		Y	3.06	67.12	16.20		80.0	
		Z	2.82	66.47	15.64		80.0	
10491-AAC	LTE-TDD (SC-FDMA, 50% RB, 15 MHz, QPSK, UL Subframe=2,3,4,7,8,9)	X	3.07	68.18	16.72	2.23	80.0	± 9.6 %
		Y	3.19	68.86	17.13		80.0	
		Z	2.92	68.09	16.69		80.0	
10492-AAC	LTE-TDD (SC-FDMA, 50% RB, 15 MHz, 16-QAM, UL Subframe=2,3,4,7,8,9)	X	3.27	66.29	16.13	2.23	80.0	± 9.6 %
		Y	3.36	66.81	16.40		80.0	
		Z	3.14	66.29	16.02		80.0	

Certificate No: EX3-7461\_Jun18

Page 26 of 39

EX3DV4- SN:7461

June 25, 2018

10493-AAC	LTE-TDD (SC-FDMA, 50% RB, 15 MHz, 64-QAM, UL Subframe=2,3,4,7,8,9)	X	3.35	66.23	16.12	2.23	80.0	± 9.6 %
		Y	3.43	66.74	16.38		80.0	
		Z	3.21	66.22	16.00		80.0	
10494-AAC	LTE-TDD (SC-FDMA, 50% RB, 20 MHz, QPSK, UL Subframe=2,3,4,7,8,9)	X	3.25	69.33	17.04	2.23	80.0	± 9.6 %
		Y	3.39	70.08	17.51		80.0	
		Z	3.08	69.16	17.03		80.0	
10495-AAC	LTE-TDD (SC-FDMA, 50% RB, 20 MHz, 16-QAM, UL Subframe=2,3,4,7,8,9)	X	3.29	66.60	16.30	2.23	80.0	± 9.6 %
		Y	3.38	67.11	16.58		80.0	
		Z	3.16	66.54	16.22		80.0	
10496-AAC	LTE-TDD (SC-FDMA, 50% RB, 20 MHz, 64-QAM, UL Subframe=2,3,4,7,8,9)	X	3.38	66.45	16.27	2.23	80.0	± 9.6 %
		Y	3.47	66.94	16.54		80.0	
		Z	3.25	66.41	16.20		80.0	
10497-AAA	LTE-TDD (SC-FDMA, 100% RB, 1.4 MHz, QPSK, UL Subframe=2,3,4,7,8,9)	X	1.28	62.06	10.68	2.23	80.0	± 9.6 %
		Y	1.39	63.13	11.30		80.0	
		Z	0.98	60.00	8.62		80.0	
10498-AAA	LTE-TDD (SC-FDMA, 100% RB, 1.4 MHz, 16-QAM, UL Subframe=2,3,4,7,8,9)	X	1.28	60.00	8.58	2.23	80.0	± 9.6 %
		Y	1.27	60.00	8.56		80.0	
		Z	1.17	60.00	7.51		80.0	
10499-AAA	LTE-TDD (SC-FDMA, 100% RB, 1.4 MHz, 64-QAM, UL Subframe=2,3,4,7,8,9)	X	1.30	60.00	8.44	2.23	80.0	± 9.6 %
		Y	1.28	60.00	8.41		80.0	
		Z	1.19	60.00	7.36		80.0	
10500-AAA	LTE-TDD (SC-FDMA, 100% RB, 3 MHz, QPSK, UL Subframe=2,3,4,7,8,9)	X	2.42	68.43	16.18	2.23	80.0	± 9.6 %
		Y	2.58	69.51	16.78		80.0	
		Z	2.25	68.20	15.81		80.0	
10501-AAA	LTE-TDD (SC-FDMA, 100% RB, 3 MHz, 16-QAM, UL Subframe=2,3,4,7,8,9)	X	2.60	66.22	14.88	2.23	80.0	± 9.6 %
		Y	2.73	67.06	15.30		80.0	
		Z	2.38	65.74	14.19		80.0	
10502-AAA	LTE-TDD (SC-FDMA, 100% RB, 3 MHz, 64-QAM, UL Subframe=2,3,4,7,8,9)	X	2.66	66.15	14.80	2.23	80.0	± 9.6 %
		Y	2.79	66.97	15.20		80.0	
		Z	2.43	65.62	14.07		80.0	
10503-AAC	LTE-TDD (SC-FDMA, 100% RB, 5 MHz, QPSK, UL Subframe=2,3,4,7,8,9)	X	2.68	68.69	16.73	2.23	80.0	± 9.6 %
		Y	2.82	69.54	17.24		80.0	
		Z	2.53	68.58	16.62		80.0	
10504-AAC	LTE-TDD (SC-FDMA, 100% RB, 5 MHz, 16-QAM, UL Subframe=2,3,4,7,8,9)	X	2.84	66.45	15.81	2.23	80.0	± 9.6 %
		Y	2.95	67.11	16.16		80.0	
		Z	2.71	66.43	15.59		80.0	
10505-AAC	LTE-TDD (SC-FDMA, 100% RB, 5 MHz, 64-QAM, UL Subframe=2,3,4,7,8,9)	X	2.95	66.40	15.82	2.23	80.0	± 9.6 %
		Y	3.05	67.04	16.14		80.0	
		Z	2.80	66.38	15.58		80.0	
10506-AAC	LTE-TDD (SC-FDMA, 100% RB, 10 MHz, QPSK, UL Subframe=2,3,4,7,8,9)	X	3.23	69.20	16.97	2.23	80.0	± 9.6 %
		Y	3.37	69.96	17.44		80.0	
		Z	3.06	69.03	16.96		80.0	
10507-AAC	LTE-TDD (SC-FDMA, 100% RB, 10 MHz, 16-QAM, UL Subframe=2,3,4,7,8,9)	X	3.27	66.54	16.26	2.23	80.0	± 9.6 %
		Y	3.36	67.05	16.54		80.0	
		Z	3.14	66.48	16.18		80.0	

EX3DV4- SN:7461

June 25, 2018

10508-AAC	LTE-TDD (SC-FDMA, 100% RB, 10 MHz, 64-QAM, UL Subframe=2,3,4,7,8,9)	X	3.37	66.39	16.23	2.23	80.0	± 9.6 %
		Y	3.46	66.88	16.49		80.0	
		Z	3.24	66.34	16.15		80.0	
10509-AAC	LTE-TDD (SC-FDMA, 100% RB, 15 MHz, QPSK, UL Subframe=2,3,4,7,8,9)	X	3.66	68.59	16.76	2.23	80.0	± 9.6 %
		Y	3.80	69.26	17.16		80.0	
		Z	3.51	68.47	16.78		80.0	
10510-AAC	LTE-TDD (SC-FDMA, 100% RB, 15 MHz, 16-QAM, UL Subframe=2,3,4,7,8,9)	X	3.78	66.58	16.41	2.23	80.0	± 9.6 %
		Y	3.87	67.02	16.65		80.0	
		Z	3.64	66.47	16.36		80.0	
10511-AAC	LTE-TDD (SC-FDMA, 100% RB, 15 MHz, 64-QAM, UL Subframe=2,3,4,7,8,9)	X	3.85	66.41	16.38	2.23	80.0	± 9.6 %
		Y	3.93	66.84	16.61		80.0	
		Z	3.72	66.33	16.34		80.0	
10512-AAC	LTE-TDD (SC-FDMA, 100% RB, 20 MHz, QPSK, UL Subframe=2,3,4,7,8,9)	X	3.71	69.69	17.06	2.23	80.0	± 9.6 %
		Y	3.87	70.45	17.51		80.0	
		Z	3.54	69.45	17.04		80.0	
10513-AAC	LTE-TDD (SC-FDMA, 100% RB, 20 MHz, 16-QAM, UL Subframe=2,3,4,7,8,9)	X	3.65	66.74	16.46	2.23	80.0	± 9.6 %
		Y	3.74	67.18	16.71		80.0	
		Z	3.52	66.57	16.40		80.0	
10514-AAC	LTE-TDD (SC-FDMA, 100% RB, 20 MHz, 64-QAM, UL Subframe=2,3,4,7,8,9)	X	3.70	66.43	16.39	2.23	80.0	± 9.6 %
		Y	3.79	66.85	16.63		80.0	
		Z	3.58	66.30	16.34		80.0	
10515-AAA	IEEE 802.11b WiFi 2.4 GHz (DSSS, 2 Mbps, 99pc duty cycle)	X	0.88	62.72	14.31	0.00	150.0	± 9.6 %
		Y	0.96	63.35	14.63		150.0	
		Z	0.88	62.76	14.23		150.0	
10516-AAA	IEEE 802.11b WiFi 2.4 GHz (DSSS, 5.5 Mbps, 99pc duty cycle)	X	0.53	70.79	16.38	0.00	150.0	± 9.6 %
		Y	0.62	71.66	17.97		150.0	
		Z	0.51	70.09	16.07		150.0	
10517-AAA	IEEE 802.11b WiFi 2.4 GHz (DSSS, 11 Mbps, 99pc duty cycle)	X	0.72	64.61	14.78	0.00	150.0	± 9.6 %
		Y	0.82	65.38	15.54		150.0	
		Z	0.71	64.49	14.63		150.0	
10518-AAB	IEEE 802.11a/h WiFi 5 GHz (OFDM, 9 Mbps, 99pc duty cycle)	X	4.44	66.54	16.11	0.00	150.0	± 9.6 %
		Y	4.48	66.80	16.22		150.0	
		Z	4.33	66.63	16.08		150.0	
10519-AAB	IEEE 802.11a/h WiFi 5 GHz (OFDM, 12 Mbps, 99pc duty cycle)	X	4.63	68.78	16.23	0.00	150.0	± 9.6 %
		Y	4.65	67.01	16.32		150.0	
		Z	4.48	66.82	16.18		150.0	
10520-AAB	IEEE 802.11a/h WiFi 5 GHz (OFDM, 18 Mbps, 99pc duty cycle)	X	4.48	66.73	16.15	0.00	150.0	± 9.6 %
		Y	4.50	66.97	16.25		150.0	
		Z	4.34	66.75	16.09		150.0	
10521-AAB	IEEE 802.11a/h WiFi 5 GHz (OFDM, 24 Mbps, 99pc duty cycle)	X	4.41	66.72	16.13	0.00	150.0	± 9.6 %
		Y	4.44	66.96	16.23		150.0	
		Z	4.27	66.73	16.07		150.0	
10522-AAB	IEEE 802.11a/h WiFi 5 GHz (OFDM, 36 Mbps, 99pc duty cycle)	X	4.47	66.82	16.22	0.00	150.0	± 9.6 %
		Y	4.50	67.07	16.33		150.0	
		Z	4.33	66.87	16.17		150.0	

Certificate No: EX3-7461\_Jun18

Page 30 of 39

EX3DV4- SN:7461

June 25, 2018

10523-AAB	IEEE 802.11a/h WiFi 5 GHz (OFDM, 48 Mbps, 99pc duty cycle)	X	4.35	66.68	16.06	0.00	150.0	± 9.6 %
		Y	4.39	66.96	16.19		150.0	
		Z	4.24	66.80	16.06		150.0	
10524-AAB	IEEE 802.11a/h WiFi 5 GHz (OFDM, 54 Mbps, 99pc duty cycle)	X	4.41	66.74	16.19	0.00	150.0	± 9.6 %
		Y	4.44	66.99	16.29		150.0	
		Z	4.28	66.80	16.15		150.0	
10525-AAB	IEEE 802.11ac WiFi (20MHz, MCS0, 99pc duty cycle)	X	4.40	65.78	15.79	0.00	150.0	± 9.6 %
		Y	4.44	66.06	15.90		150.0	
		Z	4.30	65.88	15.77		150.0	
10526-AAB	IEEE 802.11ac WiFi (20MHz, MCS1, 99pc duty cycle)	X	4.57	66.14	15.93	0.00	150.0	± 9.6 %
		Y	4.60	66.40	16.03		150.0	
		Z	4.43	66.18	15.89		150.0	
10527-AAB	IEEE 802.11ac WiFi (20MHz, MCS2, 99pc duty cycle)	X	4.49	66.10	15.87	0.00	150.0	± 9.6 %
		Y	4.52	66.36	15.98		150.0	
		Z	4.36	66.15	15.83		150.0	
10528-AAB	IEEE 802.11ac WiFi (20MHz, MCS3, 99pc duty cycle)	X	4.51	66.12	15.90	0.00	150.0	± 9.6 %
		Y	4.54	66.38	16.01		150.0	
		Z	4.37	66.16	15.86		150.0	
10529-AAB	IEEE 802.11ac WiFi (20MHz, MCS4, 99pc duty cycle)	X	4.51	66.12	15.90	0.00	150.0	± 9.6 %
		Y	4.54	66.38	16.01		150.0	
		Z	4.37	66.16	15.86		150.0	
10531-AAB	IEEE 802.11ac WiFi (20MHz, MCS6, 99pc duty cycle)	X	4.50	66.22	15.91	0.00	150.0	± 9.6 %
		Y	4.52	66.46	16.01		150.0	
		Z	4.34	66.21	15.84		150.0	
10532-AAB	IEEE 802.11ac WiFi (20MHz, MCS7, 99pc duty cycle)	X	4.36	66.07	15.84	0.00	150.0	± 9.6 %
		Y	4.39	66.32	15.95		150.0	
		Z	4.22	66.06	15.77		150.0	
10533-AAB	IEEE 802.11ac WiFi (20MHz, MCS8, 99pc duty cycle)	X	4.52	66.17	15.89	0.00	150.0	± 9.6 %
		Y	4.55	66.44	16.00		150.0	
		Z	4.38	66.24	15.86		150.0	
10534-AAB	IEEE 802.11ac WiFi (40MHz, MCS0, 99pc duty cycle)	X	5.05	66.23	15.97	0.00	150.0	± 9.6 %
		Y	5.08	66.44	16.06		150.0	
		Z	4.93	66.22	15.95		150.0	
10535-AAB	IEEE 802.11ac WiFi (40MHz, MCS1, 99pc duty cycle)	X	5.12	66.42	16.06	0.00	150.0	± 9.6 %
		Y	5.14	66.62	16.14		150.0	
		Z	4.99	66.38	16.02		150.0	
10536-AAB	IEEE 802.11ac WiFi (40MHz, MCS2, 99pc duty cycle)	X	4.99	66.36	16.01	0.00	150.0	± 9.6 %
		Y	5.01	66.58	16.10		150.0	
		Z	4.87	66.36	15.99		150.0	
10537-AAB	IEEE 802.11ac WiFi (40MHz, MCS3, 99pc duty cycle)	X	5.04	66.33	16.00	0.00	150.0	± 9.6 %
		Y	5.07	66.54	16.08		150.0	
		Z	4.93	66.32	15.98		150.0	
10538-AAB	IEEE 802.11ac WiFi (40MHz, MCS4, 99pc duty cycle)	X	5.13	66.35	16.05	0.00	150.0	± 9.6 %
		Y	5.15	66.54	16.12		150.0	
		Z	5.00	66.31	16.01		150.0	
10540-AAB	IEEE 802.11ac WiFi (40MHz, MCS6, 99pc duty cycle)	X	5.07	66.39	16.08	0.00	150.0	± 9.6 %
		Y	5.08	66.54	16.14		150.0	
		Z	4.93	66.29	16.02		150.0	



EX3DV4- SN:7461

June 25, 2018

10541-AAB	IEEE 802.11ac WiFi (40MHz, MCS7, 99pc duty cycle)	X	5.04	66.23	15.99	0.00	150.0	± 9.6 %
		Y	5.06	66.43	16.07		150.0	
		Z	4.91	66.17	15.94		150.0	
10542-AAB	IEEE 802.11ac WiFi (40MHz, MCS8, 99pc duty cycle)	X	5.19	66.31	16.05	0.00	150.0	± 9.6 %
		Y	5.21	66.51	16.12		150.0	
		Z	5.07	66.28	16.02		150.0	
10543-AAB	IEEE 802.11ac WiFi (40MHz, MCS9, 99pc duty cycle)	X	5.27	66.35	16.09	0.00	150.0	± 9.6 %
		Y	5.28	66.52	16.16		150.0	
		Z	5.13	66.32	16.06		150.0	
10544-AAB	IEEE 802.11ac WiFi (80MHz, MCS0, 99pc duty cycle)	X	5.36	66.34	15.97	0.00	150.0	± 9.6 %
		Y	5.40	66.55	16.05		150.0	
		Z	5.27	66.30	15.94		150.0	
10545-AAB	IEEE 802.11ac WiFi (80MHz, MCS1, 99pc duty cycle)	X	5.55	66.79	16.14	0.00	150.0	± 9.6 %
		Y	5.58	66.95	16.20		150.0	
		Z	5.46	66.77	16.13		150.0	
10546-AAB	IEEE 802.11ac WiFi (80MHz, MCS2, 99pc duty cycle)	X	5.43	66.55	16.04	0.00	150.0	± 9.6 %
		Y	5.45	66.72	16.10		150.0	
		Z	5.31	66.44	15.98		150.0	
10547-AAB	IEEE 802.11ac WiFi (80MHz, MCS3, 99pc duty cycle)	X	5.50	66.59	16.05	0.00	150.0	± 9.6 %
		Y	5.52	66.77	16.12		150.0	
		Z	5.39	66.54	16.02		150.0	
10548-AAB	IEEE 802.11ac WiFi (80MHz, MCS4, 99pc duty cycle)	X	5.77	67.61	16.53	0.00	150.0	± 9.6 %
		Y	5.72	67.56	16.49		150.0	
		Z	5.58	67.31	16.38		150.0	
10550-AAB	IEEE 802.11ac WiFi (80MHz, MCS6, 99pc duty cycle)	X	5.46	66.58	16.07	0.00	150.0	± 9.6 %
		Y	5.48	66.77	16.14		150.0	
		Z	5.37	66.61	16.07		150.0	
10551-AAB	IEEE 802.11ac WiFi (80MHz, MCS7, 99pc duty cycle)	X	5.46	66.61	16.04	0.00	150.0	± 9.6 %
		Y	5.48	66.79	16.11		150.0	
		Z	5.32	66.45	15.96		150.0	
10552-AAB	IEEE 802.11ac WiFi (80MHz, MCS8, 99pc duty cycle)	X	5.37	66.40	15.94	0.00	150.0	± 9.6 %
		Y	5.41	66.63	16.04		150.0	
		Z	5.28	66.39	15.93		150.0	
10553-AAB	IEEE 802.11ac WiFi (80MHz, MCS9, 99pc duty cycle)	X	5.45	66.43	15.99	0.00	150.0	± 9.6 %
		Y	5.48	66.64	16.07		150.0	
		Z	5.34	66.37	15.95		150.0	
10554-AAC	IEEE 802.11ac WiFi (160MHz, MCS0, 99pc duty cycle)	X	5.77	66.70	16.06	0.00	150.0	± 9.6 %
		Y	5.81	66.90	16.13		150.0	
		Z	5.69	66.65	16.03		150.0	
10555-AAC	IEEE 802.11ac WiFi (160MHz, MCS1, 99pc duty cycle)	X	5.91	67.02	16.19	0.00	150.0	± 9.6 %
		Y	5.92	67.17	16.25		150.0	
		Z	5.80	66.92	16.14		150.0	
10556-AAC	IEEE 802.11ac WiFi (160MHz, MCS2, 99pc duty cycle)	X	5.93	67.07	16.21	0.00	150.0	± 9.6 %
		Y	5.95	67.23	16.27		150.0	
		Z	5.83	67.01	16.18		150.0	
10557-AAC	IEEE 802.11ac WiFi (160MHz, MCS3, 99pc duty cycle)	X	5.89	66.95	16.17	0.00	150.0	± 9.6 %
		Y	5.91	67.13	16.24		150.0	
		Z	5.78	66.87	16.13		150.0	

Certificate No: EX3-7461\_Jun18

Page 32 of 39

EX3DV4--SN:7461

June 25, 2018

10558-AAC	IEEE 802.11ac WiFi (160MHz, MCS4, 99pc duty cycle)	X	5.94	67.12	16.27	0.00	150.0	± 9.6 %
		Y	5.95	67.28	16.33		150.0	
		Z	5.81	66.98	16.20		150.0	
10560-AAC	IEEE 802.11ac WiFi (160MHz, MCS6, 99pc duty cycle)	X	5.93	66.96	16.23	0.00	150.0	± 9.6 %
		Y	5.95	67.14	16.30		150.0	
		Z	5.82	66.86	16.18		150.0	
10561-AAC	IEEE 802.11ac WiFi (160MHz, MCS7, 99pc duty cycle)	X	5.86	66.94	16.26	0.00	150.0	± 9.6 %
		Y	5.87	67.11	16.32		150.0	
		Z	5.75	66.86	16.21		150.0	
10562-AAC	IEEE 802.11ac WiFi (160MHz, MCS8, 99pc duty cycle)	X	5.98	67.32	16.45	0.00	150.0	± 9.6 %
		Y	5.97	67.42	16.47		150.0	
		Z	5.82	67.07	16.32		150.0	
10563-AAC	IEEE 802.11ac WiFi (160MHz, MCS9, 99pc duty cycle)	X	6.17	67.53	16.51	0.00	150.0	± 9.6 %
		Y	6.08	67.38	16.41		150.0	
		Z	5.91	67.01	16.25		150.0	
10564-AAA	IEEE 802.11g WiFi 2.4 GHz (DSSS-OFDM, 9 Mbps, 99pc duty cycle)	X	4.76	66.58	16.24	0.46	150.0	± 9.6 %
		Y	4.79	66.82	16.34		150.0	
		Z	4.64	66.65	16.20		150.0	
10565-AAA	IEEE 802.11g WiFi 2.4 GHz (DSSS-OFDM, 12 Mbps, 99pc duty cycle)	X	4.99	67.05	16.58	0.46	150.0	± 9.6 %
		Y	5.01	67.26	16.66		150.0	
		Z	4.85	67.09	16.53		150.0	
10566-AAA	IEEE 802.11g WiFi 2.4 GHz (DSSS-OFDM, 18 Mbps, 99pc duty cycle)	X	4.82	66.88	16.38	0.46	150.0	± 9.6 %
		Y	4.85	67.10	16.47		150.0	
		Z	4.68	66.89	16.32		150.0	
10567-AAA	IEEE 802.11g WiFi 2.4 GHz (DSSS-OFDM, 24 Mbps, 99pc duty cycle)	X	4.85	67.29	16.76	0.46	150.0	± 9.6 %
		Y	4.88	67.50	16.84		150.0	
		Z	4.72	67.32	16.72		150.0	
10568-AAA	IEEE 802.11g WiFi 2.4 GHz (DSSS-OFDM, 36 Mbps, 99pc duty cycle)	X	4.73	66.62	16.12	0.46	150.0	± 9.6 %
		Y	4.75	66.85	16.22		150.0	
		Z	4.58	66.62	16.05		150.0	
10569-AAA	IEEE 802.11g WiFi 2.4 GHz (DSSS-OFDM, 48 Mbps, 99pc duty cycle)	X	4.81	67.38	16.81	0.46	150.0	± 9.6 %
		Y	4.84	67.62	16.91		150.0	
		Z	4.70	67.51	16.84		150.0	
10570-AAA	IEEE 802.11g WiFi 2.4 GHz (DSSS-OFDM, 54 Mbps, 99pc duty cycle)	X	4.85	67.25	16.76	0.46	150.0	± 9.6 %
		Y	4.87	67.47	16.85		150.0	
		Z	4.71	67.32	16.74		150.0	
10571-AAA	IEEE 802.11b WiFi 2.4 GHz (DSSS, 1 Mbps, 90pc duty cycle)	X	1.01	63.24	14.74	0.46	130.0	± 9.6 %
		Y	1.10	63.82	15.20		130.0	
		Z	1.00	63.24	14.65		130.0	
10572-AAA	IEEE 802.11b WiFi 2.4 GHz (DSSS, 2 Mbps, 90pc duty cycle)	X	1.01	63.76	15.07	0.46	130.0	± 9.6 %
		Y	1.10	64.34	15.54		130.0	
		Z	1.01	63.75	14.99		130.0	
10573-AAA	IEEE 802.11b WiFi 2.4 GHz (DSSS, 5.5 Mbps, 90pc duty cycle)	X	1.24	79.48	20.03	0.46	130.0	± 9.6 %
		Y	1.34	80.41	21.49		130.0	
		Z	1.11	78.06	19.60		130.0	
10574-AAA	IEEE 802.11b WiFi 2.4 GHz (DSSS, 11 Mbps, 90pc duty cycle)	X	1.06	69.06	17.80	0.46	130.0	± 9.6 %
		Y	1.16	69.57	18.32		130.0	
		Z	1.04	68.85	17.67		130.0	

Certificate No: EX3-7461\_Jun18

Page 33 of 39

EX3DV4- SN:7461

June 25, 2018

10575-AAA	IEEE 802.11g WiFi 2.4 GHz (DSSS-OFDM, 6 Mbps, 90pc duty cycle)	X	4.53	66.29	16.22	0.46	130.0	± 9.6 %
		Y	4.56	66.53	16.31		130.0	
		Z	4.41	66.36	16.18		130.0	
10576-AAA	IEEE 802.11g WiFi 2.4 GHz (DSSS-OFDM, 9 Mbps, 90pc duty cycle)	X	4.55	66.46	16.29	0.46	130.0	± 9.6 %
		Y	4.58	66.70	16.39		130.0	
		Z	4.44	66.56	16.26		130.0	
10577-AAA	IEEE 802.11g WiFi 2.4 GHz (DSSS-OFDM, 12 Mbps, 90pc duty cycle)	X	4.75	66.77	16.47	0.46	130.0	± 9.6 %
		Y	4.77	66.98	16.55		130.0	
		Z	4.61	66.82	16.42		130.0	
10578-AAA	IEEE 802.11g WiFi 2.4 GHz (DSSS-OFDM, 18 Mbps, 90pc duty cycle)	X	4.65	66.93	16.58	0.46	130.0	± 9.6 %
		Y	4.67	67.14	16.66		130.0	
		Z	4.52	66.97	16.54		130.0	
10579-AAA	IEEE 802.11g WiFi 2.4 GHz (DSSS-OFDM, 24 Mbps, 90pc duty cycle)	X	4.41	66.14	15.83	0.46	130.0	± 9.6 %
		Y	4.43	66.36	15.92		130.0	
		Z	4.26	66.12	15.75		130.0	
10580-AAA	IEEE 802.11g WiFi 2.4 GHz (DSSS-OFDM, 36 Mbps, 90pc duty cycle)	X	4.45	66.19	15.86	0.46	130.0	± 9.6 %
		Y	4.47	66.41	15.95		130.0	
		Z	4.30	66.19	15.78		130.0	
10581-AAA	IEEE 802.11g WiFi 2.4 GHz (DSSS-OFDM, 48 Mbps, 90pc duty cycle)	X	4.54	66.94	16.50	0.46	130.0	± 9.6 %
		Y	4.57	67.17	16.60		130.0	
		Z	4.42	67.02	16.48		130.0	
10582-AAA	IEEE 802.11g WiFi 2.4 GHz (DSSS-OFDM, 54 Mbps, 90pc duty cycle)	X	4.35	65.90	15.61	0.46	130.0	± 9.6 %
		Y	4.37	66.12	15.71		130.0	
		Z	4.20	65.88	15.52		130.0	
10583-AAB	IEEE 802.11a/h WiFi 5 GHz (OFDM, 6 Mbps, 90pc duty cycle)	X	4.53	66.29	16.22	0.46	130.0	± 9.6 %
		Y	4.56	66.53	16.31		130.0	
		Z	4.41	66.36	16.18		130.0	
10584-AAB	IEEE 802.11a/h WiFi 5 GHz (OFDM, 9 Mbps, 90pc duty cycle)	X	4.55	66.46	16.29	0.46	130.0	± 9.6 %
		Y	4.58	66.70	16.39		130.0	
		Z	4.44	66.56	16.26		130.0	
10585-AAB	IEEE 802.11a/h WiFi 5 GHz (OFDM, 12 Mbps, 90pc duty cycle)	X	4.75	66.77	16.47	0.46	130.0	± 9.6 %
		Y	4.77	66.98	16.55		130.0	
		Z	4.61	66.82	16.42		130.0	
10586-AAB	IEEE 802.11a/h WiFi 5 GHz (OFDM, 18 Mbps, 90pc duty cycle)	X	4.65	66.93	16.58	0.46	130.0	± 9.6 %
		Y	4.67	67.14	16.66		130.0	
		Z	4.52	66.97	16.54		130.0	
10587-AAB	IEEE 802.11a/h WiFi 5 GHz (OFDM, 24 Mbps, 90pc duty cycle)	X	4.41	66.14	15.83	0.46	130.0	± 9.6 %
		Y	4.43	66.36	15.92		130.0	
		Z	4.26	66.12	15.75		130.0	
10588-AAB	IEEE 802.11a/h WiFi 5 GHz (OFDM, 36 Mbps, 90pc duty cycle)	X	4.45	66.19	15.86	0.46	130.0	± 9.6 %
		Y	4.47	66.41	15.95		130.0	
		Z	4.30	66.19	15.78		130.0	
10589-AAB	IEEE 802.11a/h WiFi 5 GHz (OFDM, 48 Mbps, 90pc duty cycle)	X	4.54	66.94	16.50	0.46	130.0	± 9.6 %
		Y	4.57	67.17	16.60		130.0	
		Z	4.42	67.02	16.48		130.0	
10590-AAB	IEEE 802.11a/h WiFi 5 GHz (OFDM, 54 Mbps, 90pc duty cycle)	X	4.35	65.90	15.61	0.46	130.0	± 9.6 %
		Y	4.37	66.12	15.71		130.0	
		Z	4.20	65.88	15.52		130.0	

EX3DV4- SN:7461

June 25, 2018

10591-AAB	IEEE 802.11n (HT Mixed, 20MHz, MCS0, 90pc duty cycle)	X	4.68	66.37	16.34	0.46	130.0	± 9.6 %
		Y	4.71	66.60	16.42		130.0	
		Z	4.57	66.46	16.31		130.0	
10592-AAB	IEEE 802.11n (HT Mixed, 20MHz, MCS1, 90pc duty cycle)	X	4.83	66.71	16.47	0.46	130.0	± 9.6 %
		Y	4.85	66.93	16.55		130.0	
		Z	4.70	66.77	16.44		130.0	
10593-AAB	IEEE 802.11n (HT Mixed, 20MHz, MCS2, 90pc duty cycle)	X	4.75	66.60	16.34	0.46	130.0	± 9.6 %
		Y	4.77	66.82	16.42		130.0	
		Z	4.61	66.63	16.29		130.0	
10594-AAB	IEEE 802.11n (HT Mixed, 20MHz, MCS3, 90pc duty cycle)	X	4.81	66.78	16.50	0.46	130.0	± 9.6 %
		Y	4.83	66.99	16.58		130.0	
		Z	4.67	66.82	16.46		130.0	
10595-AAB	IEEE 802.11n (HT Mixed, 20MHz, MCS4, 90pc duty cycle)	X	4.77	66.72	16.39	0.46	130.0	± 9.6 %
		Y	4.79	66.94	16.48		130.0	
		Z	4.63	66.78	16.36		130.0	
10596-AAB	IEEE 802.11n (HT Mixed, 20MHz, MCS5, 90pc duty cycle)	X	4.71	66.71	16.39	0.46	130.0	± 9.6 %
		Y	4.73	66.93	16.47		130.0	
		Z	4.56	66.75	16.35		130.0	
10597-AAB	IEEE 802.11n (HT Mixed, 20MHz, MCS6, 90pc duty cycle)	X	4.65	66.60	16.26	0.46	130.0	± 9.6 %
		Y	4.66	66.82	16.35		130.0	
		Z	4.51	66.62	16.20		130.0	
10598-AAB	IEEE 802.11n (HT Mixed, 20MHz, MCS7, 90pc duty cycle)	X	4.64	66.85	16.54	0.46	130.0	± 9.6 %
		Y	4.66	67.06	16.62		130.0	
		Z	4.50	66.87	16.49		130.0	
10599-AAB	IEEE 802.11n (HT Mixed, 40MHz, MCS0, 90pc duty cycle)	X	5.37	66.97	16.59	0.46	130.0	± 9.6 %
		Y	5.37	67.08	16.62		130.0	
		Z	5.26	66.98	16.58		130.0	
10600-AAB	IEEE 802.11n (HT Mixed, 40MHz, MCS1, 90pc duty cycle)	X	5.51	67.43	16.79	0.46	130.0	± 9.6 %
		Y	5.49	67.46	16.78		130.0	
		Z	5.38	67.40	16.75		130.0	
10601-AAB	IEEE 802.11n (HT Mixed, 40MHz, MCS2, 90pc duty cycle)	X	5.39	67.14	16.68	0.46	130.0	± 9.6 %
		Y	5.39	67.25	16.69		130.0	
		Z	5.27	67.14	16.64		130.0	
10602-AAB	IEEE 802.11n (HT Mixed, 40MHz, MCS3, 90pc duty cycle)	X	5.49	67.19	16.60	0.46	130.0	± 9.6 %
		Y	5.51	67.36	16.66		130.0	
		Z	5.40	67.31	16.64		130.0	
10603-AAB	IEEE 802.11n (HT Mixed, 40MHz, MCS4, 90pc duty cycle)	X	5.57	67.48	16.89	0.46	130.0	± 9.6 %
		Y	5.57	67.61	16.92		130.0	
		Z	5.48	67.65	16.96		130.0	
10604-AAB	IEEE 802.11n (HT Mixed, 40MHz, MCS5, 90pc duty cycle)	X	5.38	66.96	16.61	0.46	130.0	± 9.6 %
		Y	5.43	67.23	16.72		130.0	
		Z	5.36	67.28	16.75		130.0	
10605-AAB	IEEE 802.11n (HT Mixed, 40MHz, MCS6, 90pc duty cycle)	X	5.49	67.30	16.78	0.46	130.0	± 9.6 %
		Y	5.49	67.40	16.80		130.0	
		Z	5.37	67.29	16.75		130.0	
10606-AAB	IEEE 802.11n (HT Mixed, 40MHz, MCS7, 90pc duty cycle)	X	5.22	66.56	16.28	0.46	130.0	± 9.6 %
		Y	5.23	66.70	16.31		130.0	
		Z	5.12	66.61	16.26		130.0	

Certificate No: EX3-7461\_Jun18

Page 35 of 39

EX3DV4- SN:7461

June 25, 2018

10607-AAB	IEEE 802.11ac WiFi (20MHz, MCS0, 90pc duty cycle)	X	4.52	65.68	15.96	0.46	130.0	± 9.6 %
		Y	4.55	65.93	16.06		130.0	
		Z	4.41	65.79	15.94		130.0	
10608-AAB	IEEE 802.11ac WiFi (20MHz, MCS1, 90pc duty cycle)	X	4.70	66.08	16.12	0.46	130.0	± 9.6 %
		Y	4.72	66.32	16.22		130.0	
		Z	4.56	66.14	16.10		130.0	
10609-AAB	IEEE 802.11ac WiFi (20MHz, MCS2, 90pc duty cycle)	X	4.59	65.91	15.95	0.46	130.0	± 9.6 %
		Y	4.81	66.15	16.05		130.0	
		Z	4.45	65.96	15.91		130.0	
10610-AAB	IEEE 802.11ac WiFi (20MHz, MCS3, 90pc duty cycle)	X	4.64	66.06	16.12	0.46	130.0	± 9.6 %
		Y	4.66	66.32	16.21		130.0	
		Z	4.51	66.13	16.09		130.0	
10611-AAB	IEEE 802.11ac WiFi (20MHz, MCS4, 90pc duty cycle)	X	4.55	65.87	15.96	0.46	130.0	± 9.6 %
		Y	4.58	66.11	16.05		130.0	
		Z	4.42	65.92	15.92		130.0	
10612-AAB	IEEE 802.11ac WiFi (20MHz, MCS5, 90pc duty cycle)	X	4.56	66.02	15.99	0.46	130.0	± 9.6 %
		Y	4.58	66.26	16.09		130.0	
		Z	4.41	66.05	15.95		130.0	
10613-AAB	IEEE 802.11ac WiFi (20MHz, MCS6, 90pc duty cycle)	X	4.56	65.90	15.87	0.46	130.0	± 9.6 %
		Y	4.58	66.12	15.96		130.0	
		Z	4.41	65.88	15.80		130.0	
10614-AAB	IEEE 802.11ac WiFi (20MHz, MCS7, 90pc duty cycle)	X	4.51	66.10	16.12	0.46	130.0	± 9.6 %
		Y	4.53	66.33	16.21		130.0	
		Z	4.38	66.12	16.07		130.0	
10615-AAB	IEEE 802.11ac WiFi (20MHz, MCS8, 90pc duty cycle)	X	4.55	65.69	15.72	0.46	130.0	± 9.6 %
		Y	4.57	65.94	15.82		130.0	
		Z	4.41	65.73	15.67		130.0	
10616-AAB	IEEE 802.11ac WiFi (40MHz, MCS0, 90pc duty cycle)	X	5.18	66.19	16.18	0.46	130.0	± 9.6 %
		Y	5.20	66.37	16.25		130.0	
		Z	5.06	66.17	16.16		130.0	
10617-AAB	IEEE 802.11ac WiFi (40MHz, MCS1, 90pc duty cycle)	X	5.25	66.39	16.25	0.46	130.0	± 9.6 %
		Y	5.26	66.55	16.31		130.0	
		Z	5.13	66.36	16.23		130.0	
10618-AAB	IEEE 802.11ac WiFi (40MHz, MCS2, 90pc duty cycle)	X	5.13	66.37	16.26	0.46	130.0	± 9.6 %
		Y	5.15	66.57	16.34		130.0	
		Z	5.03	66.40	16.26		130.0	
10619-AAB	IEEE 802.11ac WiFi (40MHz, MCS3, 90pc duty cycle)	X	5.15	66.18	16.10	0.46	130.0	± 9.6 %
		Y	5.16	66.35	16.16		130.0	
		Z	5.03	66.18	16.08		130.0	
10620-AAB	IEEE 802.11ac WiFi (40MHz, MCS4, 90pc duty cycle)	X	5.24	66.22	16.17	0.46	130.0	± 9.6 %
		Y	5.25	66.38	16.23		130.0	
		Z	5.11	66.20	16.14		130.0	
10621-AAB	IEEE 802.11ac WiFi (40MHz, MCS5, 90pc duty cycle)	X	5.24	66.37	16.37	0.46	130.0	± 9.6 %
		Y	5.26	66.54	16.43		130.0	
		Z	5.12	66.35	16.34		130.0	
10622-AAB	IEEE 802.11ac WiFi (40MHz, MCS6, 90pc duty cycle)	X	5.26	66.55	16.45	0.46	130.0	± 9.6 %
		Y	5.27	66.71	16.50		130.0	
		Z	5.12	66.45	16.39		130.0	

EX3DV4- SN:7461

June 25, 2016

10623-AAB	IEEE 802.11ac WiFi (40MHz, MCS7, 90pc duty cycle)	X	5.13	66.03	16.06	0.46	130.0	± 9.6 %
		Y	5.15	66.21	16.13		130.0	
		Z	4.99	65.95	16.00		130.0	
10624-AAB	IEEE 802.11ac WiFi (40MHz, MCS8, 90pc duty cycle)	X	5.32	66.25	16.24	0.46	130.0	± 9.6 %
		Y	5.34	66.42	16.29		130.0	
		Z	5.20	66.22	16.20		130.0	
10625-AAB	IEEE 802.11ac WiFi (40MHz, MCS9, 90pc duty cycle)	X	5.69	67.25	16.79	0.46	130.0	± 9.6 %
		Y	5.62	67.17	16.72		130.0	
		Z	5.36	66.59	16.45		130.0	
10626-AAB	IEEE 802.11ac WiFi (80MHz, MCS0, 90pc duty cycle)	X	5.48	66.25	16.14	0.46	130.0	± 9.6 %
		Y	5.51	66.44	16.21		130.0	
		Z	5.39	66.22	16.12		130.0	
10627-AAB	IEEE 802.11ac WiFi (80MHz, MCS1, 90pc duty cycle)	X	5.73	66.87	16.42	0.46	130.0	± 9.6 %
		Y	5.73	66.98	16.45		130.0	
		Z	5.64	66.87	16.42		130.0	
10628-AAB	IEEE 802.11ac WiFi (80MHz, MCS2, 90pc duty cycle)	X	5.51	66.33	16.08	0.46	130.0	± 9.6 %
		Y	5.52	66.48	16.13		130.0	
		Z	5.39	66.21	16.01		130.0	
10629-AAB	IEEE 802.11ac WiFi (80MHz, MCS3, 90pc duty cycle)	X	5.59	66.39	16.10	0.46	130.0	± 9.6 %
		Y	5.60	66.54	16.15		130.0	
		Z	5.48	66.37	16.09		130.0	
10630-AAB	IEEE 802.11ac WiFi (80MHz, MCS4, 90pc duty cycle)	X	6.07	68.03	16.92	0.46	130.0	± 9.6 %
		Y	5.94	67.78	16.78		130.0	
		Z	5.80	67.54	16.67		130.0	
10631-AAB	IEEE 802.11ac WiFi (80MHz, MCS5, 90pc duty cycle)	X	5.93	67.74	16.98	0.46	130.0	± 9.6 %
		Y	5.89	67.74	16.95		130.0	
		Z	5.74	67.47	16.84		130.0	
10632-AAB	IEEE 802.11ac WiFi (80MHz, MCS6, 90pc duty cycle)	X	5.70	66.93	16.59	0.46	130.0	± 9.6 %
		Y	5.71	67.07	16.64		130.0	
		Z	5.62	67.01	16.63		130.0	
10633-AAB	IEEE 802.11ac WiFi (80MHz, MCS7, 90pc duty cycle)	X	5.57	66.49	16.19	0.46	130.0	± 9.6 %
		Y	5.59	66.68	16.26		130.0	
		Z	5.45	66.42	16.16		130.0	
10634-AAB	IEEE 802.11ac WiFi (80MHz, MCS8, 90pc duty cycle)	X	5.55	66.53	16.27	0.46	130.0	± 9.6 %
		Y	5.58	66.71	16.33		130.0	
		Z	5.44	66.47	16.24		130.0	
10635-AAB	IEEE 802.11ac WiFi (80MHz, MCS9, 90pc duty cycle)	X	5.43	65.83	15.84	0.46	130.0	± 9.6 %
		Y	5.45	66.00	15.71		130.0	
		Z	5.30	65.71	15.57		130.0	
10636-AAC	IEEE 802.11ac WiFi (160MHz, MCS0, 90pc duty cycle)	X	5.90	66.63	16.24	0.46	130.0	± 9.6 %
		Y	5.92	66.80	16.30		130.0	
		Z	5.82	66.60	16.22		130.0	
10637-AAC	IEEE 802.11ac WiFi (160MHz, MCS1, 90pc duty cycle)	X	6.06	67.04	16.43	0.46	130.0	± 9.6 %
		Y	6.07	67.16	16.46		130.0	
		Z	5.96	66.95	16.39		130.0	
10638-AAC	IEEE 802.11ac WiFi (160MHz, MCS2, 90pc duty cycle)	X	6.06	67.00	16.38	0.46	130.0	± 9.6 %
		Y	6.07	67.14	16.43		130.0	
		Z	5.97	66.95	16.36		130.0	

Certificate No: EX3-7461\_Jun16

Page 37 of 39

EX3DV4– SN:7461

June 25, 2018

10639-AAC	IEEE 802.11ac WiFi (160MHz, MCS3, 90pc duty cycle)	X	6.03	66.94	16.40	0.46	130.0	± 9.6 %
		Y	6.04	67.08	16.44		130.0	
		Z	5.93	66.85	16.36		130.0	
10640-AAC	IEEE 802.11ac WiFi (160MHz, MCS4, 90pc duty cycle)	X	6.03	66.94	16.34	0.46	130.0	± 9.6 %
		Y	6.04	67.07	16.38		130.0	
		Z	5.91	66.81	16.27		130.0	
10641-AAC	IEEE 802.11ac WiFi (160MHz, MCS5, 90pc duty cycle)	X	6.09	66.87	16.32	0.46	130.0	± 9.6 %
		Y	6.10	67.01	16.37		130.0	
		Z	6.00	66.84	16.31		130.0	
10642-AAC	IEEE 802.11ac WiFi (160MHz, MCS6, 90pc duty cycle)	X	6.12	67.11	16.62	0.46	130.0	± 9.6 %
		Y	6.14	67.26	16.67		130.0	
		Z	6.02	67.05	16.59		130.0	
10643-AAC	IEEE 802.11ac WiFi (160MHz, MCS7, 90pc duty cycle)	X	5.96	66.80	16.35	0.46	130.0	± 9.6 %
		Y	5.97	66.94	16.40		130.0	
		Z	5.87	66.74	16.32		130.0	
10644-AAC	IEEE 802.11ac WiFi (160MHz, MCS8, 90pc duty cycle)	X	6.12	67.28	16.61	0.46	130.0	± 9.6 %
		Y	6.10	67.33	16.62		130.0	
		Z	5.94	66.98	16.46		130.0	
10645-AAC	IEEE 802.11ac WiFi (160MHz, MCS9, 90pc duty cycle)	X	6.42	67.81	16.84	0.46	130.0	± 9.6 %
		Y	6.26	67.44	16.63		130.0	
		Z	6.11	67.14	16.50		130.0	
10646-AAD	LTE-TDD (SC-FDMA, 1 RB, 5 MHz, QPSK, UL Subframe=2,7)	X	10.17	95.29	31.69	9.30	60.0	± 9.6 %
		Y	9.96	96.24	32.39		60.0	
		Z	8.37	93.35	31.62		60.0	
10647-AAC	LTE-TDD (SC-FDMA, 1 RB, 20 MHz, QPSK, UL Subframe=2,7)	X	9.10	93.49	31.21	9.30	60.0	± 9.6 %
		Y	8.77	93.96	31.74		60.0	
		Z	7.35	91.07	30.95		60.0	
10648-AAA	CDMA2000 (1x Advanced)	X	0.55	62.02	9.07	0.00	150.0	± 9.6 %
		Y	0.65	63.40	10.39		150.0	
		Z	0.44	60.63	7.36		150.0	
10652-AAB	LTE-TDD (OFDMA, 5 MHz, E-TM 3.1, Clipping 44%)	X	3.21	65.35	15.67	2.23	80.0	± 9.6 %
		Y	3.30	65.89	15.92		80.0	
		Z	3.11	65.50	15.52		80.0	
10653-AAB	LTE-TDD (OFDMA, 10 MHz, E-TM 3.1, Clipping 44%)	X	3.78	65.03	16.02	2.23	80.0	± 9.6 %
		Y	3.86	65.43	16.20		80.0	
		Z	3.69	65.12	15.95		80.0	
10654-AAB	LTE-TDD (OFDMA, 15 MHz, E-TM 3.1, Clipping 44%)	X	3.78	64.73	16.05	2.23	80.0	± 9.6 %
		Y	3.85	65.11	16.22		80.0	
		Z	3.71	64.79	16.01		80.0	
10655-AAB	LTE-TDD (OFDMA, 20 MHz, E-TM 3.1, Clipping 44%)	X	3.84	64.73	16.10	2.23	80.0	± 9.6 %
		Y	3.92	65.09	16.27		80.0	
		Z	3.78	64.75	16.06		80.0	
10658-AAA	Pulse Waveform (200Hz, 10%)	X	3.16	67.12	11.24	10.00	50.0	± 9.6 %
		Y	4.32	71.37	13.25		50.0	
		Z	3.29	67.65	11.48		50.0	
10659-AAA	Pulse Waveform (200Hz, 20%)	X	1.74	64.60	8.94	6.99	60.0	± 9.6 %
		Y	4.54	74.18	13.18		60.0	
		Z	1.83	65.35	9.32		60.0	

Certificate No: EX3-7461\_Jun18

Page 38 of 39

EX3DV4- SN:7461

June 25, 2018

10660- AAA	Pulse Waveform (200Hz, 40%)	X	0.62	60.70	5.71	3.98	80.0	± 9.6 %
		Y	100.00	99.68	18.32		80.0	
		Z	0.63	61.21	6.03		80.0	
10661- AAA	Pulse Waveform (200Hz, 60%)	X	0.31	60.00	4.10	2.22	100.0	± 9.6 %
		Y	100.00	98.48	16.86		100.0	
		Z	0.29	60.00	4.14		100.0	
10662- AAA	Pulse Waveform (200Hz, 80%)	X	19.45	279.93	4.21	0.97	120.0	± 9.6 %
		Y	100.00	92.62	13.48		120.0	
		Z	11.16	249.98	1.89		120.0	

<sup>⊗</sup> Uncertainty is determined using the max. deviation from linear response applying rectangular distribution and is expressed for the square of the field value.



**Calibration Laboratory of  
 Schmid & Partner  
 Engineering AG**  
 Zeughausstrasse 43, 8004 Zurich, Switzerland



**S** Schweizerischer Kalibrierdienst  
**C** Service suisse d'étalonnage  
**S** Servizio svizzero di taratura  
**S** Swiss Calibration Service

Accredited by the Swiss Accreditation Service (SAS)  
 The Swiss Accreditation Service is one of the signatories to the EA  
 Multilateral Agreement for the recognition of calibration certificates

Accreditation No.: **SCS 0108**

Client **DEKRA**

Certificate No: **D750V3-1036\_Aug17**

CALIBRATION CERTIFICATE			
Object	D750V3 - SN:1036		
Calibration procedure(s)	QA CAL-05.v9 Calibration procedure for dipole validation kits above 700 MHz		
Calibration date:	August 21, 2017		
<p>This calibration certificate documents the traceability to national standards, which realize the physical units of measurements (SI).                      The measurements and the uncertainties with confidence probability are given on the following pages and are part of the certificate.</p> <p>All calibrations have been conducted in the closed laboratory facility: environment temperature (22 ± 3)°C and humidity &lt; 70%.</p> <p>Calibration Equipment used (M&amp;E critical for calibration)</p>			
<b>Primary Standards</b>	<b>ID #</b>	<b>Cal Date (Certificate No.)</b>	<b>Scheduled Calibration</b>
Power meter NRP	SN: 104778	04-Apr-17 (No. 217-02521/02522)	Apr-18
Power sensor NRP-Z91	SN: 103244	04-Apr-17 (No. 217-02521)	Apr-18
Power sensor NRP-Z91	SN: 103245	04-Apr-17 (No. 217-02522)	Apr-18
Reference 20 dB Attenuator	SN: 5058 (20k)	07-Apr-17 (No. 217-02528)	Apr-18
Type-N mismatch combination	SN: 5047.2 / 06327	07-Apr-17 (No. 217-02529)	Apr-18
Reference Probe EX3DV4	SN: 7349	31-May-17 (No. EX3-7349_May17)	May-18
DAE4	SN: 601	28-Mar-17 (No. DAE4-601_Mar17)	Mar-18
<b>Secondary Standards</b>	<b>ID #</b>	<b>Check Date (in house)</b>	<b>Scheduled Check</b>
Power meter EPM-442A	SN: GBS7480704	07-Oct-15 (in house check Oct-16)	In house check: Oct-18
Power sensor HP 8481A	SN: US37292793	07-Oct-15 (in house check Oct-16)	In house check: Oct-18
Power sensor HP 8481A	SN: MY41092317	07-Oct-15 (in house check Oct-16)	In house check: Oct-18
RF generator R&S SMT-06	SN: 100872	15-Jun-15 (in house check Oct-16)	In house check: Oct-18
Network Analyzer HP 8753E	SN: US37390585	18-Oct-01 (in house check Oct-16)	In house check: Oct-17
Calibrated by:	Name Claudio Leubler	Function Laboratory Technician	Signature 
Approved by:	Name Katja Pokovic	Function Technical Manager	Signature 
			Issued: August 21, 2017
This calibration certificate shall not be reproduced except in full without written approval of the laboratory.			

**Calibration Laboratory of**  
**Schmid & Partner**  
**Engineering AG**  
Zeughausstrasse 43, 8004 Zurich, Switzerland



**S** Schweizerischer Kalibrierdienst  
**C** Service suisse d'étalonnage  
**S** Servizio svizzero di taratura  
**S** Swiss Calibration Service

Accredited by the Swiss Accreditation Service (SAS)  
The Swiss Accreditation Service is one of the signatories to the EA  
Multilateral Agreement for the recognition of calibration certificates

Accreditation No.: SCS 0108

**Glossary:**

TSL tissue simulating liquid  
ConvF sensitivity in TSL / NORM x,y,z  
N/A not applicable or not measured

**Calibration is Performed According to the Following Standards:**

- a) IEEE Std 1528-2013, "IEEE Recommended Practice for Determining the Peak Spatial-Averaged Specific Absorption Rate (SAR) in the Human Head from Wireless Communications Devices: Measurement Techniques", June 2013
- b) IEC 62209-1, "Measurement procedure for the assessment of Specific Absorption Rate (SAR) from hand-held and body-mounted devices used next to the ear (frequency range of 300 MHz to 6 GHz)", July 2016
- c) IEC 62209-2, "Procedure to determine the Specific Absorption Rate (SAR) for wireless communication devices used in close proximity to the human body (frequency range of 30 MHz to 6 GHz)", March 2010
- d) KDB 865664, "SAR Measurement Requirements for 100 MHz to 6 GHz"

**Additional Documentation:**

- e) DASY4/5 System Handbook

**Methods Applied and Interpretation of Parameters:**

- *Measurement Conditions:* Further details are available from the Validation Report at the end of the certificate. All figures stated in the certificate are valid at the frequency indicated.
- *Antenna Parameters with TSL:* The dipole is mounted with the spacer to position its feed point exactly below the center marking of the flat phantom section, with the arms oriented parallel to the body axis.
- *Feed Point Impedance and Return Loss:* These parameters are measured with the dipole positioned under the liquid filled phantom. The impedance stated is transformed from the measurement at the SMA connector to the feed point. The Return Loss ensures low reflected power. No uncertainty required.
- *Electrical Delay:* One-way delay between the SMA connector and the antenna feed point. No uncertainty required.
- *SAR measured:* SAR measured at the stated antenna input power.
- *SAR normalized:* SAR as measured, normalized to an input power of 1 W at the antenna connector.
- *SAR for nominal TSL parameters:* The measured TSL parameters are used to calculate the nominal SAR result.

The reported uncertainty of measurement is stated as the standard uncertainty of measurement multiplied by the coverage factor  $k=2$ , which for a normal distribution corresponds to a coverage probability of approximately 95%.

### Measurement Conditions

DASY system configuration, as far as not given on page 1.

DASY Version	DASY5	V52.10.0
Extrapolation	Advanced Extrapolation	
Phantom	Modular Flat Phantom	
Distance Dipole Center - TSL	15 mm	with Spacer
Zoom Scan Resolution	dx, dy, dz = 5 mm	
Frequency	750 MHz ± 1 MHz	

### Head TSL parameters

The following parameters and calculations were applied.

	Temperature	Permittivity	Conductivity
Nominal Head TSL parameters	22.0 °C	41.9	0.89 mho/m
Measured Head TSL parameters	(22.0 ± 0.2) °C	41.1 ± 6 %	0.90 mho/m ± 6 %
Head TSL temperature change during test	< 0.5 °C	---	---

### SAR result with Head TSL

SAR averaged over 1 cm <sup>3</sup> (1 g) of Head TSL	Condition	
SAR measured	250 mW input power	2.11 W/kg
SAR for nominal Head TSL parameters	normalized to 1W	8.33 W/kg ± 17.0 % (k=2)

SAR averaged over 10 cm <sup>3</sup> (10 g) of Head TSL	condition	
SAR measured	250 mW input power	1.36 W/kg
SAR for nominal Head TSL parameters	normalized to 1W	5.39 W/kg ± 16.5 % (k=2)

### Body TSL parameters

The following parameters and calculations were applied.

	Temperature	Permittivity	Conductivity
Nominal Body TSL parameters	22.0 °C	55.5	0.96 mho/m
Measured Body TSL parameters	(22.0 ± 0.2) °C	55.5 ± 6 %	0.96 mho/m ± 6 %
Body TSL temperature change during test	< 0.5 °C	---	---

### SAR result with Body TSL

SAR averaged over 1 cm <sup>3</sup> (1 g) of Body TSL	Condition	
SAR measured	250 mW input power	2.17 W/kg
SAR for nominal Body TSL parameters	normalized to 1W	8.68 W/kg ± 17.0 % (k=2)

SAR averaged over 10 cm <sup>3</sup> (10 g) of Body TSL	condition	
SAR measured	250 mW input power	1.43 W/kg
SAR for nominal Body TSL parameters	normalized to 1W	5.72 W/kg ± 16.5 % (k=2)

## Appendix (Additional assessments outside the scope of SCS 0108)

### Antenna Parameters with Head TSL

Impedance, transformed to feed point	$56,5 \Omega + 1,6 j\Omega$
Return Loss	- 24,1 dB

### Antenna Parameters with Body TSL

Impedance, transformed to feed point	$50,5 \Omega - 2,3 j\Omega$
Return Loss	- 32,8 dB

### General Antenna Parameters and Design

Electrical Delay (one direction)	1,036 ns
----------------------------------	----------

After long term use with 100W radiated power, only a slight warming of the dipole near the feedpoint can be measured.

The dipole is made of standard semirigid coaxial cable. The center conductor of the feeding line is directly connected to the second arm of the dipole. The antenna is therefore short-circuited for DC-signals. On some of the dipoles, small end caps are added to the dipole arms in order to improve matching when loaded according to the position as explained in the "Measurement Conditions" paragraph. The SAR data are not affected by this change. The overall dipole length is still according to the Standard.

No excessive force must be applied to the dipole arms, because they might bend or the soldered connections near the feedpoint may be damaged.

### Additional EUT Data

Manufactured by	SPEAG
Manufactured on	July 06, 2011

## DASY5 Validation Report for Head TSL

Date: 18.08.2017

Test Laboratory: SPEAG, Zurich, Switzerland

**DUT: Dipole 750 MHz; Type: D750V3; Serial: D750V3 - SN:1036**

Communication System: UID 0 - CW; Frequency: 750 MHz

Medium parameters used:  $f = 750$  MHz;  $\sigma = 0.9$  S/m;  $\epsilon_r = 41.1$ ;  $\rho = 1000$  kg/m<sup>3</sup>

Phantom section: Flat Section

Measurement Standard: DASY5 (IEEE/IEC/ANSI C63.19-2011)

DASY52 Configuration:

- Probe: EX3DV4 - SN7349; ConvF(10.49, 10.49, 10.49); Calibrated: 31.05.2017;
- Sensor-Surface: 1.4mm (Mechanical Surface Detection)
- Electronics: DAE4 Sn601; Calibrated: 28.03.2017
- Phantom: Flat Phantom 4.9 (front); Type: QD 00L P49 AA; Serial: 1001
- DASY52 52.10.0(1446); SEMCAD X 14.6.10(7417)

### Dipole Calibration for Head Tissue/Pin=250 mW, d=15mm/Zoom Scan (7x7x7)/Cube 0:

Measurement grid: dx=5mm, dy=5mm, dz=5mm

Reference Value = 58.65 V/m; Power Drift = -0.01 dB

Peak SAR (extrapolated) = 3.26 W/kg

SAR(1 g) = 2.11 W/kg; SAR(10 g) = 1.36 W/kg

Maximum value of SAR (measured) = 2.86 W/kg

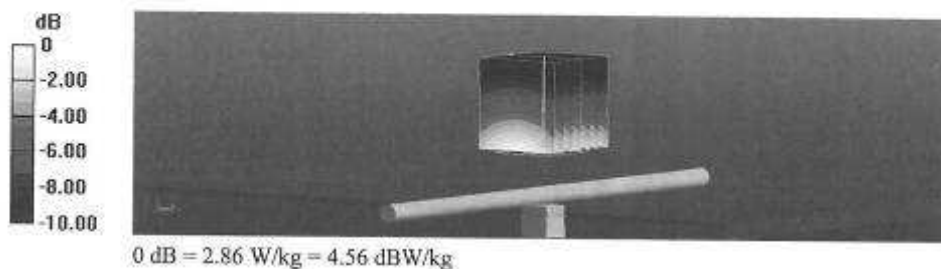

### Impedance Measurement Plot for Head TSL

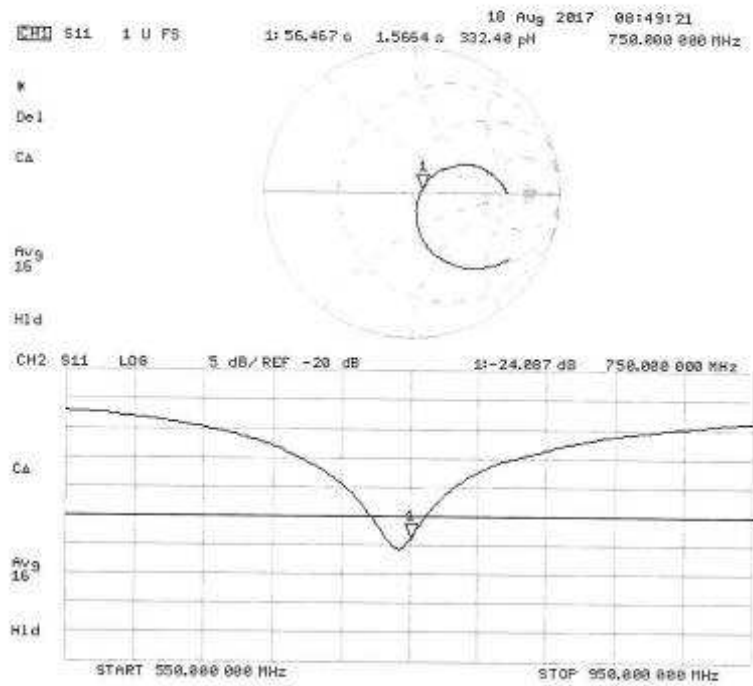

## DASY5 Validation Report for Body TSL

Date: 21.08.2017

Test Laboratory: SPEAG, Zurich, Switzerland

**DUT: Dipole 750 MHz; Type: D750V3; Serial: D750V3 - SN:1036**

Communication System: UID 0 - CW; Frequency: 750 MHz  
Medium parameters used:  $f = 750$  MHz;  $\sigma = 0.96$  S/m;  $\epsilon_r = 55.5$ ;  $\rho = 1000$  kg/m<sup>3</sup>  
Phantom section: Flat Section  
Measurement Standard: DASY5 (IEEE/IEC/ANSI C63.19-2011)

DASY52 Configuration:

- Probe: EX3DV4 - SN7349; ConvF(10.35, 10.35, 10.35); Calibrated: 31.05.2017;
- Sensor-Surface: 1.4mm (Mechanical Surface Detection)
- Electronics: DAE4 Sn601; Calibrated: 28.03.2017
- Phantom: Flat Phantom 4.9 (Back); Type: QD 00R P49 AA; Serial: 1005
- DASY52 52.10.0(1446); SEMCAD X 14.6.10(7417)

### Dipole Calibration for Body Tissue/Pin=250 mW, d=15mm/Zoom Scan (7x7x7)/Cube 0:

Measurement grid: dx=5mm, dy=5mm, dz=5mm  
Reference Value = 57.69 V/m; Power Drift = -0.01 dB  
Peak SAR (extrapolated) = 3.26 W/kg  
SAR(1 g) = 2.17 W/kg; SAR(10 g) = 1.43 W/kg  
Maximum value of SAR (measured) = 2.88 W/kg

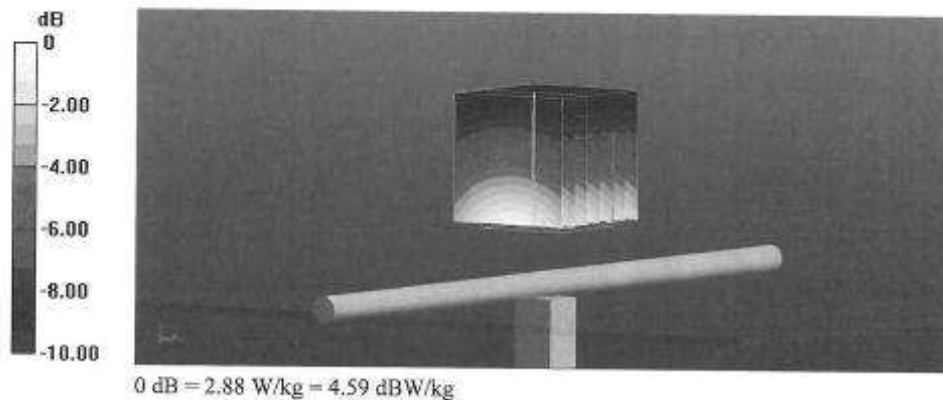

### Impedance Measurement Plot for Body TSL

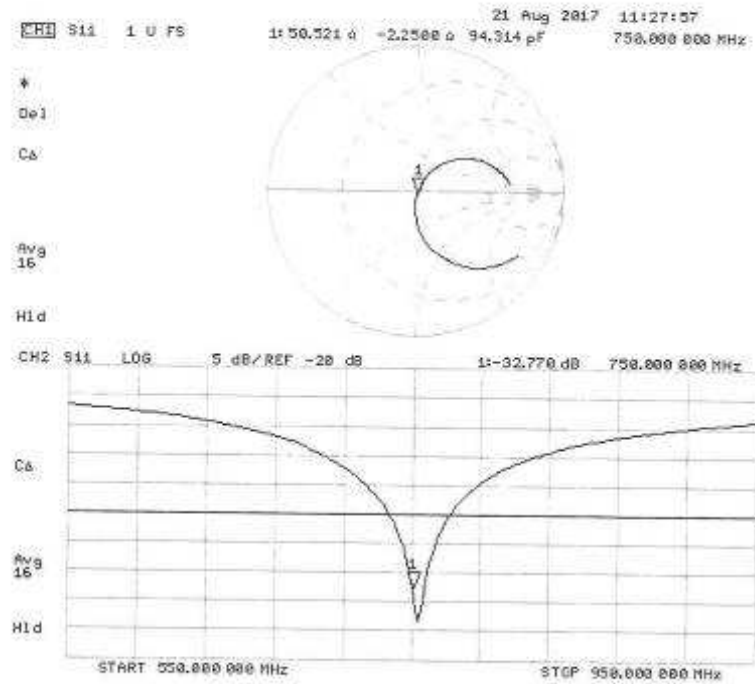



**Calibration Laboratory of  
 Schmid & Partner  
 Engineering AG**  
 Zeughausstrasse 43, 8004 Zurich, Switzerland



**S** Schweizerischer Kalibrierdienst  
**C** Service suisse d'étalonnage  
**S** Servizio svizzero di taratura  
**S** Swiss Calibration Service

Accredited by the Swiss Accreditation Service (SAS)  
 The Swiss Accreditation Service is one of the signatories to the EA  
 Multilateral Agreement for the recognition of calibration certificates

Accreditation No.: **SCS 0108**

Client **DEKRA**

Certificate No: **D900V2-1d007\_Aug17**

CALIBRATION CERTIFICATE			
Object	D900V2 - SN:1d007		
Calibration procedure(s)	QA CAL-05.v9 Calibration procedure for dipole validation kits above 700 MHz		
Calibration date:	August 21, 2017		
<p>This calibration certificate documents the traceability to national standards, which realize the physical units of measurements (SI).                      The measurements and the uncertainties with confidence probability are given on the following pages and are part of the certificate.</p> <p>All calibrations have been conducted in the closed laboratory facility; environment temperature (22 ± 3)°C and humidity &lt; 70%.</p> <p>Calibration Equipment used (M&amp;TE critical for calibration)</p>			
Primary Standards	ID #	Cal Date (Certificate No.)	Scheduled Calibration
Power meter NRP	SN: 104778	04-Apr-17 (No. 217-02521/02522)	Apr-18
Power sensor NRP-Z91	SN: 103244	04-Apr-17 (No. 217-02521)	Apr-18
Power sensor NRP-Z91	SN: 103245	04-Apr-17 (No. 217-02522)	Apr-18
Reference 20 dB Attenuator	SN: 5058 (20k)	07-Apr-17 (No. 217-02528)	Apr-18
Type-N mismatch combination	SN: 5047.2 / 06327	07-Apr-17 (No. 217-02529)	Apr-18
Reference Probe EX3DV4	SN: 7349	31-May-17 (No. EX3-7349_May17)	May-18
DAE4	SN: 601	28-Mar-17 (No. DAE4-601_Mar17)	Mar-18
Secondary Standards	ID #	Check Date (in house)	Scheduled Check
Power meter EPM-442A	SN: GB37480704	07-Oct-15 (in house check Oct-16)	in house check: Oct-18
Power sensor HP 8481A	SN: US37292793	07-Oct-15 (in house check Oct-16)	in house check: Oct-18
Power sensor HP 8481A	SN: MY41092317	07-Oct-15 (in house check Oct-16)	in house check: Oct-18
RF generator R&S SMT-06	SN: 100972	15-Jun-15 (in house check Oct-16)	in house check: Oct-18
Network Analyzer HP 8753E	SN: US37390585	18-Oct-01 (in house check Oct-16)	in house check: Oct-17
Calibrated by:	Name Claudio Leubler	Function Laboratory Technician	Signature 
Approved by:	Name Katja Pokovic	Function Technical Manager	Signature 
			Issued: August 21, 2017
This calibration certificate shall not be reproduced except in full without written approval of the laboratory.			

**Calibration Laboratory of  
Schmid & Partner  
Engineering AG**  
Zeughausstrasse 43, 8004 Zurich, Switzerland



**S** Schweizerischer Kalibrierdienst  
**C** Service suisse d'étalonnage  
**S** Servizio svizzero di taratura  
**S** Swiss Calibration Service

Accredited by the Swiss Accreditation Service (SAS)  
The Swiss Accreditation Service is one of the signatories to the EA  
Multilateral Agreement for the recognition of calibration certificates

Accreditation No.: **SCS 0108**

**Glossary:**

TSL	tissue simulating liquid
ConvF	sensitivity in TSL / NORM x,y,z
N/A	not applicable or not measured

**Calibration is Performed According to the Following Standards:**

- IEEE Std 1528-2013, "IEEE Recommended Practice for Determining the Peak Spatial-Averaged Specific Absorption Rate (SAR) in the Human Head from Wireless Communications Devices: Measurement Techniques", June 2013
- IEC 62209-1, "Measurement procedure for the assessment of Specific Absorption Rate (SAR) from hand-held and body-mounted devices used next to the ear (frequency range of 300 MHz to 6 GHz)", July 2016
- IEC 62209-2, "Procedure to determine the Specific Absorption Rate (SAR) for wireless communication devices used in close proximity to the human body (frequency range of 30 MHz to 6 GHz)", March 2010
- KDB 865664, "SAR Measurement Requirements for 100 MHz to 6 GHz"

**Additional Documentation:**

- DASY4/5 System Handbook

**Methods Applied and Interpretation of Parameters:**

- Measurement Conditions:** Further details are available from the Validation Report at the end of the certificate. All figures stated in the certificate are valid at the frequency indicated.
- Antenna Parameters with TSL:** The dipole is mounted with the spacer to position its feed point exactly below the center marking of the flat phantom section, with the arms oriented parallel to the body axis.
- Feed Point Impedance and Return Loss:** These parameters are measured with the dipole positioned under the liquid filled phantom. The impedance stated is transformed from the measurement at the SMA connector to the feed point. The Return Loss ensures low reflected power. No uncertainty required.
- Electrical Delay:** One-way delay between the SMA connector and the antenna feed point. No uncertainty required.
- SAR measured:** SAR measured at the stated antenna input power.
- SAR normalized:** SAR as measured, normalized to an input power of 1 W at the antenna connector.
- SAR for nominal TSL parameters:** The measured TSL parameters are used to calculate the nominal SAR result.

The reported uncertainty of measurement is stated as the standard uncertainty of measurement multiplied by the coverage factor  $k=2$ , which for a normal distribution corresponds to a coverage probability of approximately 95%.

### Measurement Conditions

DASY system configuration, as far as not given on page 1.

DASY Version	DASY5	V52.10.0
Extrapolation	Advanced Extrapolation	
Phantom	Modular Flat Phantom	
Distance Dipole Center - TSL	15 mm	with Spacer
Zoom Scan Resolution	dx, dy, dz = 5 mm	
Frequency	900 MHz ± 1 MHz	

### Head TSL parameters

The following parameters and calculations were applied.

	Temperature	Permittivity	Conductivity
Nominal Head TSL parameters	22.0 °C	41.5	0.97 mho/m
Measured Head TSL parameters	(22.0 ± 0.2) °C	40.7 ± 6 %	0.96 mho/m ± 6 %
Head TSL temperature change during test	< 0.5 °C	---	---

### SAR result with Head TSL

SAR averaged over 1 cm <sup>3</sup> (1 g) of Head TSL	Condition	
SAR measured	250 mW input power	2.72 W/kg
SAR for nominal Head TSL parameters	normalized to 1W	10.9 W/kg ± 17.0 % (k=2)

SAR averaged over 10 cm <sup>3</sup> (10 g) of Head TSL	condition	
SAR measured	250 mW input power	1.74 W/kg
SAR for nominal Head TSL parameters	normalized to 1W	6.98 W/kg ± 16.5 % (k=2)

### Body TSL parameters

The following parameters and calculations were applied.

	Temperature	Permittivity	Conductivity
Nominal Body TSL parameters	22.0 °C	55.0	1.05 mho/m
Measured Body TSL parameters	(22.0 ± 0.2) °C	55.2 ± 6 %	1.01 mho/m ± 6 %
Body TSL temperature change during test	< 0.5 °C	---	---

### SAR result with Body TSL

SAR averaged over 1 cm <sup>3</sup> (1 g) of Body TSL	Condition	
SAR measured	250 mW input power	2.70 W/kg
SAR for nominal Body TSL parameters	normalized to 1W	11.1 W/kg ± 17.0 % (k=2)

SAR averaged over 10 cm <sup>3</sup> (10 g) of Body TSL	condition	
SAR measured	250 mW input power	1.77 W/kg
SAR for nominal Body TSL parameters	normalized to 1W	7.25 W/kg ± 16.5 % (k=2)

## Appendix (Additional assessments outside the scope of SCS 0108)

### Antenna Parameters with Head TSL

Impedance, transformed to feed point	49.4 $\Omega$ - 2.6 $\mu\Omega$
Return Loss	- 31.3 dB

### Antenna Parameters with Body TSL

Impedance, transformed to feed point	45.8 $\Omega$ - 4.5 $\mu\Omega$
Return Loss	- 23.9 dB

### General Antenna Parameters and Design

Electrical Delay (one direction)	1.409 ns
----------------------------------	----------

After long term use with 100W radiated power, only a slight warming of the dipole near the feedpoint can be measured.

The dipole is made of standard semirigid coaxial cable. The center conductor of the feeding line is directly connected to the second arm of the dipole. The antenna is therefore short-circuited for DC-signals. On some of the dipoles, small end caps are added to the dipole arms in order to improve matching when loaded according to the position as explained in the "Measurement Conditions" paragraph. The SAR data are not affected by this change. The overall dipole length is still according to the Standard.

No excessive force must be applied to the dipole arms, because they might bend or the soldered connections near the feedpoint may be damaged.

### Additional EUT Data

Manufactured by	SPEAG
Manufactured on	February 13, 2004

## DASY5 Validation Report for Head TSL

Date: 18.08.2017

Test Laboratory: SPEAG, Zurich, Switzerland

**DUT: Dipole 900 MHz; Type: D900V2; Serial: D900V2 - SN:1d007**

Communication System: UID 0 - CW; Frequency: 900 MHz

Medium parameters used:  $f = 900$  MHz;  $\sigma = 0.96$  S/m;  $\epsilon_r = 40.7$ ;  $\rho = 1000$  kg/m<sup>3</sup>

Phantom section: Flat Section

Measurement Standard: DASY5 (IEEE/IEC/ANSI C63.19-2011)

DASY52 Configuration:

- Probe: EX3DV4 - SN7349; ConvF(9.86, 9.86, 9.86); Calibrated: 31.05.2017;
- Sensor-Surface: 1.4mm (Mechanical Surface Detection)
- Electronics: DAE4 Sn601; Calibrated: 28.03.2017
- Phantom: Flat Phantom 4.9 (front); Type: QD 00L P49 AA; Serial: I001
- DASY52 52.10.0(1446); SEMCAD X 14.6.10(7417)

### Dipole Calibration for Head Tissue/Pin=250 mW, d=15mm/Zoom Scan (7x7x7)/Cube 0:

Measurement grid: dx=5mm, dy=5mm, dz=5mm

Reference Value = 64.32 V/m; Power Drift = 0.05 dB

Peak SAR (extrapolated) = 4.22 W/kg

SAR(1 g) = 2.72 W/kg; SAR(10 g) = 1.74 W/kg

Maximum value of SAR (measured) = 3.70 W/kg

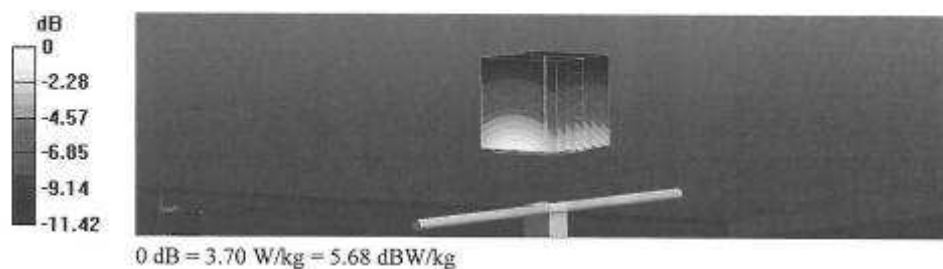

### Impedance Measurement Plot for Head TSL

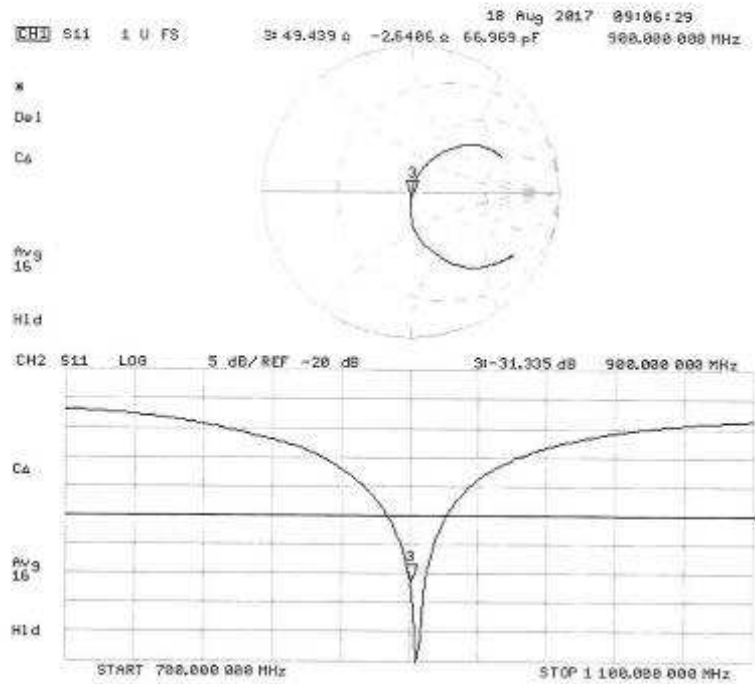

## DASY5 Validation Report for Body TSL

Date: 21.08.2017

Test Laboratory: SPEAG, Zurich, Switzerland

**DUT: Dipole 900 MHz; Type: D900V2; Serial: D900V2 - SN:1d007**

Communication System: UID 0 - CW; Frequency: 900 MHz

Medium parameters used:  $f = 900$  MHz;  $\sigma = 1.01$  S/m;  $\epsilon_r = 55.2$ ;  $\rho = 1000$  kg/m<sup>3</sup>

Phantom section: Flat Section

Measurement Standard: DASY5 (IEEE/IEC/ANSI C63.19-2011)

DASY52 Configuration:

- Probe: EX3DV4 - SN7349; ConvF(9.94, 9.94, 9.94); Calibrated: 31.05.2017;
- Sensor-Surface: 1.4mm (Mechanical Surface Detection)
- Electronics: DAE4 Sn601; Calibrated: 28.03.2017
- Phantom: Flat Phantom 4.9 (Back); Type: QD 00R P49 AA; Serial: 1005
- DASY52 52.10.0(1446); SEMCAD X 14.6.10(7417)

### Dipole Calibration for Body Tissue/Pin=250 mW, d=15mm/Zoom Scan (7x7x7)/Cube 0:

Measurement grid: dx=5mm, dy=5mm, dz=5mm

Reference Value = 62.21 V/m; Power Drift = 0.01 dB

Peak SAR (extrapolated) = 3.95 W/kg

SAR(1 g) = 2.7 W/kg; SAR(10 g) = 1.77 W/kg

Maximum value of SAR (measured) = 3.49 W/kg

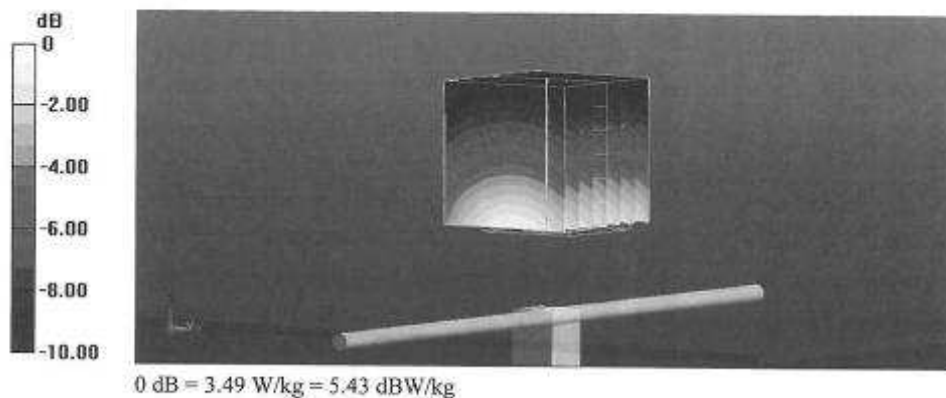

### Impedance Measurement Plot for Body TSL

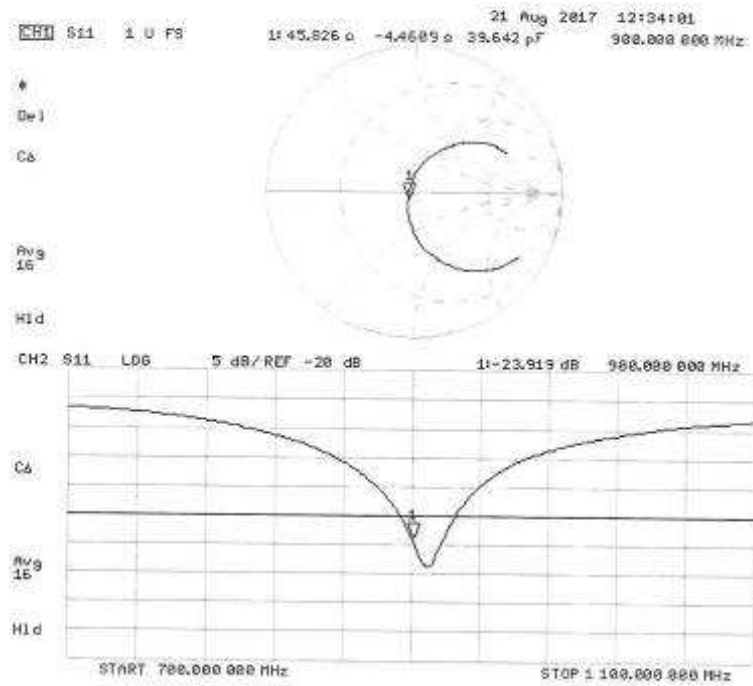



**Calibration Laboratory of  
 Schmid & Partner  
 Engineering AG**  
 Zeughausstrasse 43, 8004 Zurich, Switzerland



**S** Schweizerischer Kalibrierdienst  
**S** Service suisse d'étalonnage  
**S** Servizio svizzero di taratura  
**S** Swiss Calibration Service

Accredited by the Swiss Accreditation Service (SAS)  
 The Swiss Accreditation Service is one of the signatories to the EA  
 Multilateral Agreement for the recognition of calibration certificates

Accreditation No.: **SCS 0108**

Client **DEKRA**

Certificate No: **D1800V2-2d099\_Aug17**

**CALIBRATION CERTIFICATE**

Object: **D1800V2 - SN:2d099**

Calibration procedure(s): **QA CAL-05.v9  
 Calibration procedure for dipole validation kits above 700 MHz**

Calibration date: **August 21, 2017**

This calibration certificate documents the traceability to national standards, which realize the physical units of measurements (SI).  
 The measurements and the uncertainties with confidence probability are given on the following pages and are part of the certificate.

All calibrations have been conducted in the closed laboratory facility: environment temperature (22 ± 3)°C and humidity < 70%.

Calibration Equipment used (M&E critical for calibration)

Primary Standards	ID #	Cal Date (Certificate No.)	Scheduled Calibration
Power meter NRP	SN: 104778	04-Apr-17 (No. 217-02521/02522)	Apr-18
Power sensor NRP-Z91	SN: 103244	04-Apr-17 (No. 217-02521)	Apr-18
Power sensor NRP-Z91	SN: 103245	04-Apr-17 (No. 217-02522)	Apr-18
Reference 20 dB Attenuator	SN: 5058 (20k)	07-Apr-17 (No. 217-02528)	Apr-18
Type-N mismatch combination	SN: 5047.2 / 06327	07-Apr-17 (No. 217-02529)	Apr-18
Reference Probe EX3DV4	SN: 7349	31-May-17 (No. EX3-7349_May17)	May-18
DAE4	SN: 601	28-Mar-17 (No. DAE4-601_Mar17)	Mar-18
Secondary Standards	ID #	Check Date (in house)	Scheduled Check
Power meter EPM-442A	SN: GB37480704	07-Oct-15 (in house check Oct-16)	In house check: Oct-18
Power sensor HP 8481A	SN: US37292783	07-Oct-15 (in house check Oct-16)	In house check: Oct-18
Power sensor HP 8481A	SN: MY41092317	07-Oct-15 (in house check Oct-16)	In house check: Oct-18
RF generator R&S SMT-06	SN: 100972	15-Jun-15 (in house check Oct-16)	In house check: Oct-18
Network Analyzer HP 8753E	SN: US37390585	18-Oct-01 (in house check Oct-16)	In house check: Oct-17

Calibrated by: **Claudio Leubler** (Name), **Laboratory Technician** (Function), *[Signature]* (Signature)

Approved by: **Katja Pokovic** (Name), **Technical Manager** (Function), *[Signature]* (Signature)

Issued: August 21, 2017

This calibration certificate shall not be reproduced except in full without written approval of the laboratory.

**Calibration Laboratory of**  
Schmid & Partner  
Engineering AG  
Zaughausstrasse 43, 8004 Zurich, Switzerland



**S** Schweizerischer Kalibrierdienst  
**C** Service suisse d'étalonnage  
**S** Servizio svizzero di taratura  
**S** Swiss Calibration Service

Accredited by the Swiss Accreditation Service (SAS)  
The Swiss Accreditation Service is one of the signatories to the EA  
Multilateral Agreement for the recognition of calibration certificates

Accreditation No.: **SCS 0108**

**Glossary:**

TSL	tissue simulating liquid
ConvF	sensitivity in TSL / NORM x,y,z
N/A	not applicable or not measured

**Calibration is Performed According to the Following Standards:**

- IEEE Std 1528-2013, "IEEE Recommended Practice for Determining the Peak Spatial-Averaged Specific Absorption Rate (SAR) in the Human Head from Wireless Communications Devices: Measurement Techniques", June 2013
- IEC 62209-1, "Measurement procedure for the assessment of Specific Absorption Rate (SAR) from hand-held and body-mounted devices used next to the ear (frequency range of 300 MHz to 6 GHz)", July 2016
- IEC 62209-2, "Procedure to determine the Specific Absorption Rate (SAR) for wireless communication devices used in close proximity to the human body (frequency range of 30 MHz to 6 GHz)", March 2010
- KDB 865664, "SAR Measurement Requirements for 100 MHz to 6 GHz"

**Additional Documentation:**

- DASY4/5 System Handbook

**Methods Applied and Interpretation of Parameters:**

- Measurement Conditions:** Further details are available from the Validation Report at the end of the certificate. All figures stated in the certificate are valid at the frequency indicated.
- Antenna Parameters with TSL:** The dipole is mounted with the spacer to position its feed point exactly below the center marking of the flat phantom section, with the arms oriented parallel to the body axis.
- Feed Point Impedance and Return Loss:** These parameters are measured with the dipole positioned under the liquid filled phantom. The impedance stated is transformed from the measurement at the SMA connector to the feed point. The Return Loss ensures low reflected power. No uncertainty required.
- Electrical Delay:** One-way delay between the SMA connector and the antenna feed point. No uncertainty required.
- SAR measured:** SAR measured at the stated antenna input power.
- SAR normalized:** SAR as measured, normalized to an input power of 1 W at the antenna connector.
- SAR for nominal TSL parameters:** The measured TSL parameters are used to calculate the nominal SAR result.

The reported uncertainty of measurement is stated as the standard uncertainty of measurement multiplied by the coverage factor  $k=2$ , which for a normal distribution corresponds to a coverage probability of approximately 95%.

### Measurement Conditions

DASY system configuration, as far as not given on page 1.

DASY Version	DASY5	V52.10.0
Extrapolation	Advanced Extrapolation	
Phantom	Modular Flat Phantom	
Distance Dipole Center - TSL	10 mm	with Spacer
Zoom Scan Resolution	dx, dy, dz = 5 mm	
Frequency	1800 MHz ± 1 MHz	

### Head TSL parameters

The following parameters and calculations were applied.

	Temperature	Permittivity	Conductivity
Nominal Head TSL parameters	22.0 °C	40.0	1.40 mho/m
Measured Head TSL parameters	(22.0 ± 0.2) °C	39.0 ± 6 %	1.38 mho/m ± 6 %
Head TSL temperature change during test	< 0.5 °C	---	---

### SAR result with Head TSL

SAR averaged over 1 cm <sup>3</sup> (1 g) of Head TSL	Condition	
SAR measured	250 mW input power	9.72 W/kg
SAR for nominal Head TSL parameters	normalized to 1W	39.0 W/kg ± 17.0 % (k=2)

SAR averaged over 10 cm <sup>3</sup> (10 g) of Head TSL	condition	
SAR measured	250 mW input power	5.07 W/kg
SAR for nominal Head TSL parameters	normalized to 1W	20.3 W/kg ± 16.5 % (k=2)

### Body TSL parameters

The following parameters and calculations were applied.

	Temperature	Permittivity	Conductivity
Nominal Body TSL parameters	22.0 °C	53.3	1.52 mho/m
Measured Body TSL parameters	(22.0 ± 0.2) °C	53.8 ± 6 %	1.50 mho/m ± 6 %
Body TSL temperature change during test	< 0.5 °C	---	---

### SAR result with Body TSL

SAR averaged over 1 cm <sup>3</sup> (1 g) of Body TSL	Condition	
SAR measured	250 mW input power	9.57 W/kg
SAR for nominal Body TSL parameters	normalized to 1W	38.7 W/kg ± 17.0 % (k=2)

SAR averaged over 10 cm <sup>3</sup> (10 g) of Body TSL	condition	
SAR measured	250 mW input power	5.08 W/kg
SAR for nominal Body TSL parameters	normalized to 1W	20.5 W/kg ± 16.5 % (k=2)

**Appendix (Additional assessments outside the scope of SCS 0108)**

**Antenna Parameters with Head TSL**

Impedance, transformed to feed point	49.5 $\Omega$ - 2.8 j $\Omega$
Return Loss	- 30.9 dB

**Antenna Parameters with Body TSL**

Impedance, transformed to feed point	44.5 $\Omega$ - 4.7 j $\Omega$
Return Loss	- 22.3 dB

**General Antenna Parameters and Design**

Electrical Delay (one direction)	1.208 ns
----------------------------------	----------

After long term use with 100W radiated power, only a slight warming of the dipole near the feedpoint can be measured.

The dipole is made of standard semirigid coaxial cable. The center conductor of the feeding line is directly connected to the second arm of the dipole. The antenna is therefore short-circuited for DC-signals. On some of the dipoles, small end caps are added to the dipole arms in order to improve matching when loaded according to the position as explained in the "Measurement Conditions" paragraph. The SAR data are not affected by this change. The overall dipole length is still according to the Standard.

No excessive force must be applied to the dipole arms, because they might bend or the soldered connections near the feedpoint may be damaged.

**Additional EUT Data**

Manufactured by	SPEAG
Manufactured on	January 30, 2004

## DASY5 Validation Report for Head TSL

Date: 21.08.2017

Test Laboratory: SPEAG, Zurich, Switzerland

**DUT: Dipole 1800 MHz; Type: D1800V2; Serial: D1800V2 - SN:2d099**

Communication System: UID 0 - CW; Frequency: 1800 MHz

Medium parameters used:  $f = 1800$  MHz;  $\sigma = 1.38$  S/m;  $\epsilon_r = 39$ ;  $\rho = 1000$  kg/m<sup>3</sup>

Phantom section: Flat Section

Measurement Standard: DASY5 (IEEE/IEC/ANSI C63.19-2011)

DASY52 Configuration:

- Probe: EX3DV4 - SN7349; ConvF(8.56, 8.56, 8.56); Calibrated: 31.05.2017;
- Sensor-Surface: 1.4mm (Mechanical Surface Detection)
- Electronics: DAE4 Sn601; Calibrated: 28.03.2017
- Phantom: Flat Phantom 5.0 (front); Type: QD 000 P50 AA; Serial: 1001
- DASY52 52.10.0(1446); SEMCAD X 14.6.10(7417)

### Dipole Calibration for Head Tissue/Pin=250 mW, d=10mm/Zoom Scan (7x7x7)/Cube 0:

Measurement grid:  $\Delta x=5$ mm,  $\Delta y=5$ mm,  $\Delta z=5$ mm

Reference Value = 106.3 V/m; Power Drift = -0.09 dB

Peak SAR (extrapolated) = 18.2 W/kg

SAR(1 g) = 9.72 W/kg; SAR(10 g) = 5.07 W/kg

Maximum value of SAR (measured) = 14.6 W/kg

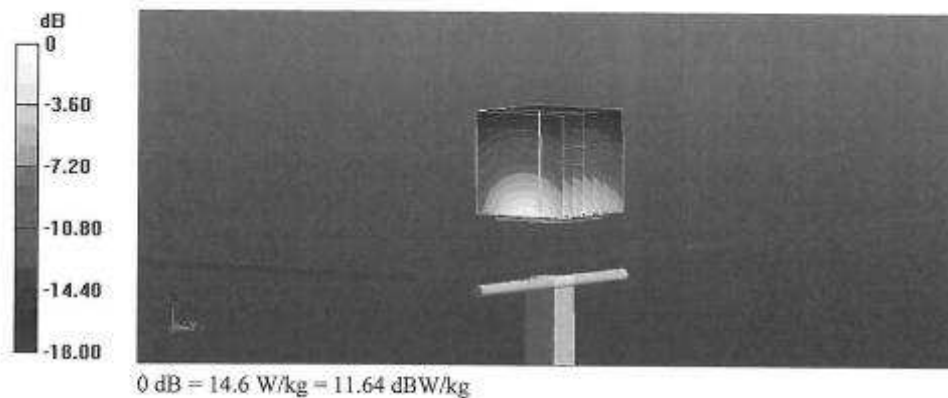

### Impedance Measurement Plot for Head TSL

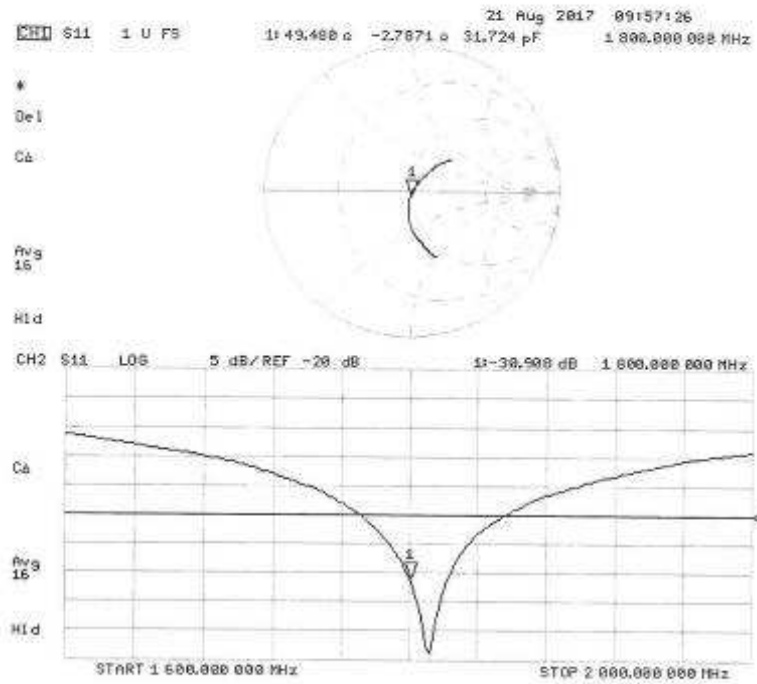

## DASY5 Validation Report for Body TSL

Date: 18.08.2017

Test Laboratory: SPEAG, Zurich, Switzerland

**DUT: Dipole 1800 MHz; Type: D1800V2; Serial: D1800V2 - SN:2d099**

Communication System: UID 0 - CW; Frequency: 1800 MHz

Medium parameters used:  $f = 1800$  MHz;  $\sigma = 1.5$  S/m;  $\epsilon_r = 53.8$ ;  $\rho = 1000$  kg/m<sup>3</sup>

Phantom section: Flat Section

Measurement Standard: DASY5 (IEEE/IEC/ANSI C63.19-2011)

DASY52 Configuration:

- Probe: EX3DV4 - SN7349; ConvF(8.38, 8.38, 8.38); Calibrated: 31.05.2017;
- Sensor-Surface: 1.4mm (Mechanical Surface Detection)
- Electronics: DAE4 Sn601; Calibrated: 28.03.2017
- Phantom: Flat Phantom 5.0 (back); Type: QD 000 P50 AA; Serial: 1002
- DASY52 52.10.0(1446); SEMCAD X 14.6.10(7417)

### Dipole Calibration for Body Tissue/Pin=250 mW, d=10mm/Zoom Scan (7x7x7)/Cube 0:

Measurement grid: dx=5mm, dy=5mm, dz=5mm

Reference Value = 102.2 V/m; Power Drift = -0.07 dB

Peak SAR (extrapolated) = 16.6 W/kg

SAR(1 g) = 9.57 W/kg; SAR(10 g) = 5.08 W/kg

Maximum value of SAR (measured) = 14.0 W/kg

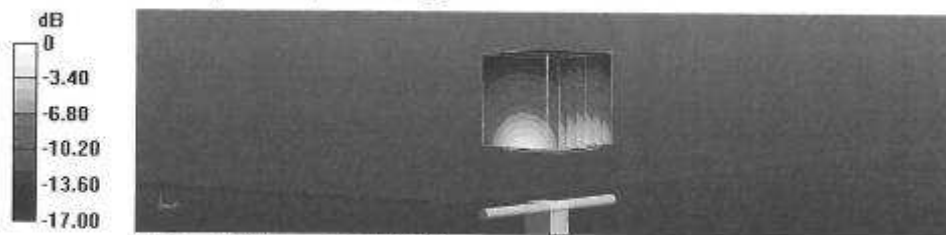

0 dB = 14.0 W/kg = 11.46 dBW/kg

### Impedance Measurement Plot for Body TSL

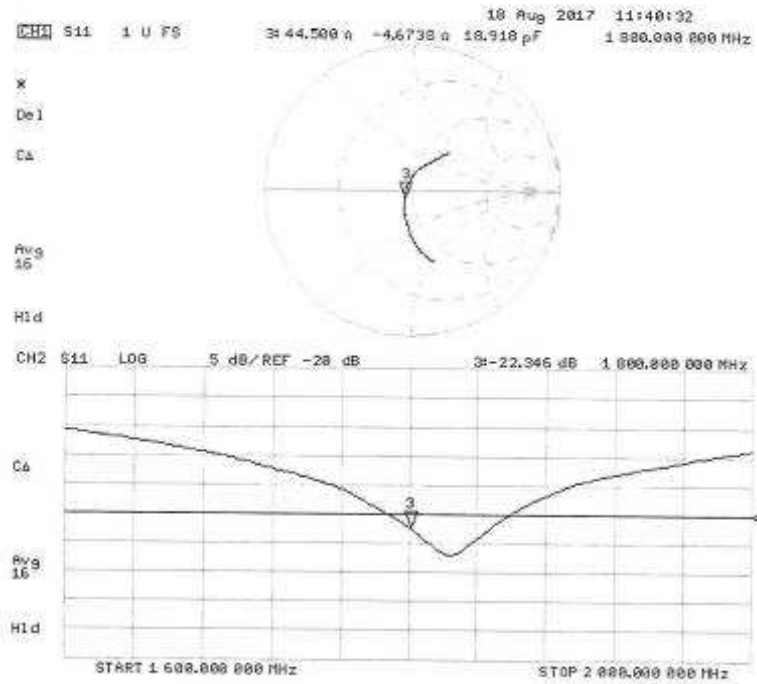



**Calibration Laboratory of  
 Schmid & Partner  
 Engineering AG**  
 Zeughausstrasse 43, 8004 Zurich, Switzerland



**S** Schweizerischer Kalibrierdienst  
**C** Service suisse d'étalonnage  
**S** Servizio svizzero di taratura  
**S** Swiss Calibration Service

Accredited by the Swiss Accreditation Service (SAS)  
 The Swiss Accreditation Service is one of the signatories to the EA  
 Multilateral Agreement for the recognition of calibration certificates

Accreditation No.: **SCS 0108**

Client: **DEKRA**

Certificate No: **D2600V2-1023\_Aug17**

**CALIBRATION CERTIFICATE**

Object: **D2600V2 - SN:1023**

Calibration procedure(s): **QA CAL-05.v9  
 Calibration procedure for dipole validation kits above 700 MHz**

Calibration date: **August 17, 2017**

This calibration certificate documents the traceability to national standards, which realize the physical units of measurements (SI).  
 The measurements and the uncertainties with confidence probability are given on the following pages and are part of the certificate.

All calibrations have been conducted in the closed laboratory facility: environment temperature (22 ± 3)°C and humidity < 70%.

Calibration Equipment used (M&TE critical for calibration)

Primary Standards	ID #	Cal Date (Certificate No.)	Scheduled Calibration
Power meter NRP	SN: 104778	04-Apr-17 (No. 217-02521/02522)	Apr-18
Power sensor NRP-Z91	SN: 103244	04-Apr-17 (No. 217-02521)	Apr-18
Power sensor NRP-Z91	SN: 103245	04-Apr-17 (No. 217-02522)	Apr-18
Reference 20 dB Attenuator	SN: 5068 (20k)	07-Apr-17 (No. 217-02528)	Apr-18
Type-N mismatch combination	SN: 5047.2 / 06327	07-Apr-17 (No. 217-02529)	Apr-18
Reference Probe EX3DV4	SN: 7349	31-May-17 (No. EX3-7349_May17)	May-18
DAE4	SN: 601	28-Mar-17 (No. DAE4-601_Mar17)	Mar-18
Secondary Standards	ID #	Check Date (in house)	Scheduled Check
Power meter EPM-442A	SN: GB37460704	07-Oct-15 (in house check Oct-16)	In house check: Oct-18
Power sensor HP 8481A	SN: US37292783	07-Oct-15 (in house check Oct-16)	In house check: Oct-18
Power sensor HP 8481A	SN: MY41092317	07-Oct-15 (in house check Oct-16)	In house check: Oct-18
RF generator R&S SMT-06	SN: 100972	15-Jun-15 (in house check Oct-16)	In house check: Oct-18
Network Analyzer HP 8753E	SN: US37390585	18-Oct-01 (in house check Oct-16)	In house check: Oct-17

Calibrated by: **Name: Michael Weber, Function: Laboratory Technician, Signature: [Handwritten Signature]**

Approved by: **Name: Katja Pokovic, Function: Technical Manager, Signature: [Handwritten Signature]**

Issued: August 17, 2017

This calibration certificate shall not be reproduced except in full without written approval of the laboratory.

**Calibration Laboratory of  
Schmid & Partner  
Engineering AG**  
Zeughausstrasse 43, 8004 Zurich, Switzerland



**S** Schweizerischer Kalibrierdienst  
**C** Service suisse d'étalonnage  
**S** Servizio svizzero di taratura  
**S** Swiss Calibration Service

Accredited by the Swiss Accreditation Service (SAS)  
The Swiss Accreditation Service is one of the signatories to the EA  
Multilateral Agreement for the recognition of calibration certificates

Accreditation No.: **SCS 0108**

**Glossary:**

TSL	tissue simulating liquid
ConvF	sensitivity in TSL / NORM x,y,z
N/A	not applicable or not measured

**Calibration is Performed According to the Following Standards:**

- IEEE Std 1528-2013, "IEEE Recommended Practice for Determining the Peak Spatial-Averaged Specific Absorption Rate (SAR) in the Human Head from Wireless Communications Devices: Measurement Techniques", June 2013
- IEC 62209-1, "Measurement procedure for the assessment of Specific Absorption Rate (SAR) from hand-held and body-mounted devices used next to the ear (frequency range of 300 MHz to 6 GHz)", July 2016
- IEC 62209-2, "Procedure to determine the Specific Absorption Rate (SAR) for wireless communication devices used in close proximity to the human body (frequency range of 30 MHz to 6 GHz)", March 2010
- KDB 865664, "SAR Measurement Requirements for 100 MHz to 6 GHz"

**Additional Documentation:**

- DASY4/5 System Handbook

**Methods Applied and Interpretation of Parameters:**

- Measurement Conditions:** Further details are available from the Validation Report at the end of the certificate. All figures stated in the certificate are valid at the frequency indicated.
- Antenna Parameters with TSL:** The dipole is mounted with the spacer to position its feed point exactly below the center marking of the flat phantom section, with the arms oriented parallel to the body axis.
- Feed Point Impedance and Return Loss:** These parameters are measured with the dipole positioned under the liquid filled phantom. The impedance stated is transformed from the measurement at the SMA connector to the feed point. The Return Loss ensures low reflected power. No uncertainty required.
- Electrical Delay:** One-way delay between the SMA connector and the antenna feed point. No uncertainty required.
- SAR measured:** SAR measured at the stated antenna input power.
- SAR normalized:** SAR as measured, normalized to an input power of 1 W at the antenna connector.
- SAR for nominal TSL parameters:** The measured TSL parameters are used to calculate the nominal SAR result.

The reported uncertainty of measurement is stated as the standard uncertainty of measurement multiplied by the coverage factor  $k=2$ , which for a normal distribution corresponds to a coverage probability of approximately 95%.

### Measurement Conditions

DASY system configuration, as far as not given on page 1.

DASY Version	DASY5	V52.10.0
Extrapolation	Advanced Extrapolation	
Phantom	Modular Flat Phantom	
Distance Dipole Center - TSL	10 mm	with Spacer
Zoom Scan Resolution	dx, dy, dz = 5 mm	
Frequency	2800 MHz ± 1 MHz	

### Head TSL parameters

The following parameters and calculations were applied.

	Temperature	Permittivity	Conductivity
Nominal Head TSL parameters	22.0 °C	39.0	1.96 mho/m
Measured Head TSL parameters	(22.0 ± 0.2) °C	37.2 ± 6 %	2.03 mho/m ± 6 %
Head TSL temperature change during test	< 0.5 °C	----	----

### SAR result with Head TSL

SAR averaged over 1 cm <sup>3</sup> (1 g) of Head TSL	Condition	
SAR measured	250 mW input power	14.7 W/kg
SAR for nominal Head TSL parameters	normalized to 1W	57.3 W/kg ± 17.0 % (k=2)

SAR averaged over 10 cm <sup>3</sup> (10 g) of Head TSL	condition	
SAR measured	250 mW input power	6.48 W/kg
SAR for nominal Head TSL parameters	normalized to 1W	25.5 W/kg ± 16.5 % (k=2)

### Body TSL parameters

The following parameters and calculations were applied.

	Temperature	Permittivity	Conductivity
Nominal Body TSL parameters	22.0 °C	52.5	2.16 mho/m
Measured Body TSL parameters	(22.0 ± 0.2) °C	51.4 ± 6 %	2.22 mho/m ± 6 %
Body TSL temperature change during test	< 0.5 °C	----	----

### SAR result with Body TSL

SAR averaged over 1 cm <sup>3</sup> (1 g) of Body TSL	Condition	
SAR measured	250 mW input power	13.9 W/kg
SAR for nominal Body TSL parameters	normalized to 1W	54.7 W/kg ± 17.0 % (k=2)

SAR averaged over 10 cm <sup>3</sup> (10 g) of Body TSL	condition	
SAR measured	250 mW input power	6.15 W/kg
SAR for nominal Body TSL parameters	normalized to 1W	24.4 W/kg ± 16.5 % (k=2)

**Appendix (Additional assessments outside the scope of SCS 0108)**

**Antenna Parameters with Head TSL**

Impedance, transformed to feed point	46.9 $\Omega$ - 5.5 j $\Omega$
Return Loss	- 23.6 dB

**Antenna Parameters with Body TSL**

Impedance, transformed to feed point	44.1 $\Omega$ - 4.4 j $\Omega$
Return Loss	- 22.1 dB

**General Antenna Parameters and Design**

Electrical Delay (one direction)	1.148 ns
----------------------------------	----------

After long term use with 100W radiated power, only a slight warming of the dipole near the feedpoint can be measured.

The dipole is made of standard semirigid coaxial cable. The center conductor of the feeding line is directly connected to the second arm of the dipole. The antenna is therefore short-circuited for DC-signals. On some of the dipoles, small end caps are added to the dipole arms in order to improve matching when loaded according to the position as explained in the "Measurement Conditions" paragraph. The SAR data are not affected by this change. The overall dipole length is still according to the Standard.

No excessive force must be applied to the dipole arms, because they might bend or the soldered connections near the feedpoint may be damaged.

**Additional EUT Data**

Manufactured by	SPEAG
Manufactured on	May 13, 2008

## DASY5 Validation Report for Head TSL

Date: 17.08.2017

Test Laboratory: SPEAG, Zurich, Switzerland

**DUT: Dipole 2600 MHz; Type: D2600V2; Serial: D2600V2 - SN: 1023**

Communication System: UID 0 - CW; Frequency: 2600 MHz

Medium parameters used:  $f = 2600$  MHz;  $\sigma = 2.03$  S/m;  $\epsilon_r = 37.2$ ;  $\rho = 1000$  kg/m<sup>3</sup>

Phantom section: Flat Section

Measurement Standard: DASY5 (IEEE/IEC/ANSI C63.19-2011)

DASY52 Configuration:

- Probe: EX3DV4 - SN7349; ConvF(7.96, 7.96, 7.96); Calibrated: 31.05.2017;
- Sensor-Surface: 1.4mm (Mechanical Surface Detection)
- Electronics: DAE4 Sn601; Calibrated: 28.03.2017
- Phantom: Flat Phantom 5.0 (front); Type: QD 000 P50 AA; Serial: 1001
- DASY52 52.10.0(1446); SEMCAD X 14.6.10(7417)

### Dipole Calibration for Head Tissue/Pin=250 mW, d=10mm/Zoom Scan (7x7x7)/Cube 0:

Measurement grid: dx=5mm, dy=5mm, dz=5mm

Reference Value = 115.4 V/m; Power Drift = -0.08 dB

Peak SAR (extrapolated) = 32.0 W/kg

SAR(1 g) = 14.7 W/kg; SAR(10 g) = 6.48 W/kg

Maximum value of SAR (measured) = 24.5 W/kg

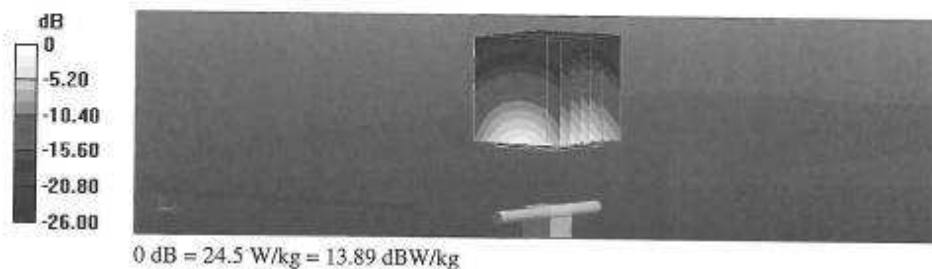

### Impedance Measurement Plot for Head TSL

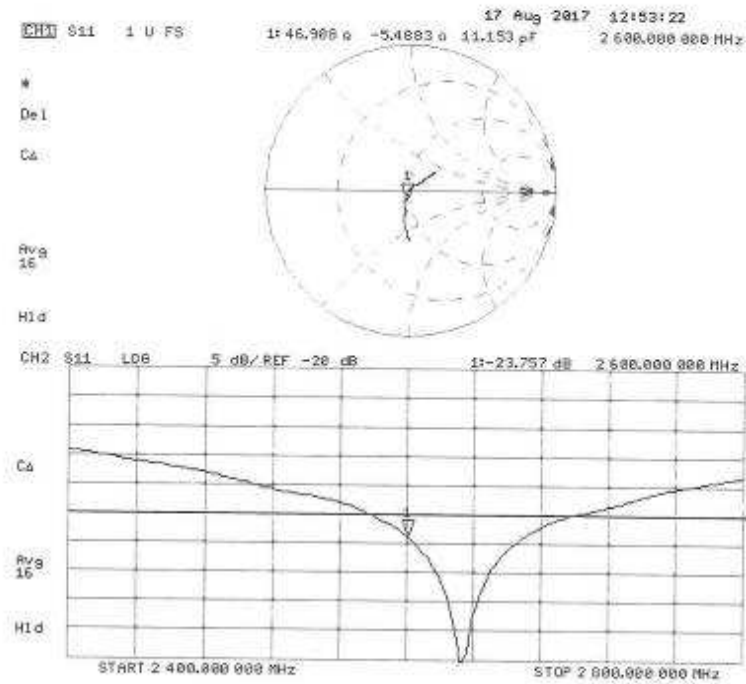

## DASY5 Validation Report for Body TSL

Date: 17.08.2017

Test Laboratory: SPEAG, Zurich, Switzerland

**DUT: Dipole 2600 MHz; Type: D2600V2; Serial: D2600V2 - SN: 1023**

Communication System: UID 0 - CW; Frequency: 2600 MHz

Medium parameters used:  $f = 2600$  MHz;  $\sigma = 2.22$  S/m;  $\epsilon_r = 51.4$ ;  $\rho = 1000$  kg/m<sup>3</sup>

Phantom section: Flat Section

Measurement Standard: DASY5 (IEEE/IEC/ANSI C63.19-2011)

DASY52 Configuration:

- Probe: EX3DV4 - SN7349; ConvF(7.94, 7.94, 7.94); Calibrated: 31.05.2017;
- Sensor-Surface: 1.4mm (Mechanical Surface Detection)
- Electronics: DAE4 Sn601; Calibrated: 28.03.2017
- Phantom: Flat Phantom 5.0 (back); Type: QD 000 P50 AA; Serial: 1002
- DASY52 52.10.0(1446); SEMCAD X 14.6.10(7417)

### Dipole Calibration for Body Tissue/Pin=250 mW, d=10mm/Zoom Scan (7x7x7)/Cube 0:

Measurement grid: dx=5mm, dy=5mm, dz=5mm

Reference Value = 105.5 V/m; Power Drift = -0.06 dB

Peak SAR (extrapolated) = 29.7 W/kg

SAR(1 g) = 13.9 W/kg; SAR(10 g) = 6.15 W/kg

Maximum value of SAR (measured) = 22.8 W/kg

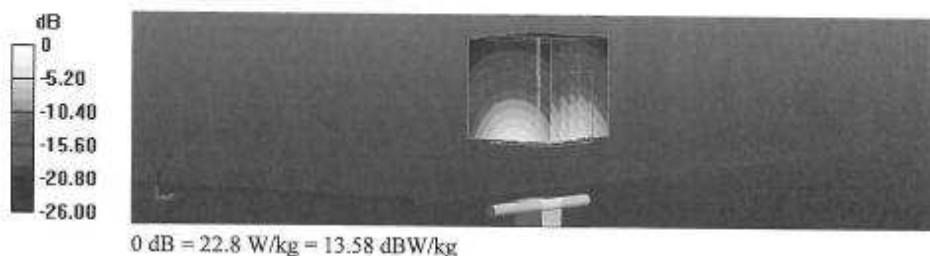

### Impedance Measurement Plot for Body TSL

