

**SERCOM**

**Samsara Freya\_NA  
Antenna Datasheet**

Nov. 02, 2023

Prepared by David Chu

# Outline

- Antenna Specification
- Antenna Structure & Placement
- Return Loss & Isolation
- Radiation Pattern
- Peak Gain & Efficiency

° Vu' U                    M °  
° Vu' U                    Q ° · · ·  
° Vu' U                    V ‡ ° · · ·  
° Vu' U                    U ‡ ° · · ·

Manufacturer Name: Sercomm Corporation

Address: 8F, No. 3-1, YuanQu St., NanKang, Taipei 115, Taiwan, R.O.C.

# Antenna Specification

Item	LTE_Main	
Operation Band	B5/B12/B13	B2/B4
Peak Gain (dBi)	< 2.5	< 1.5
Efficiency (%)	> 45	B2 > 50 B4 > 55
Return Loss (dB)	≥ 6dB	

Item	LTE_Div.	
Operation Band	B5/B12/B13	B2/B4
Peak Gain (dBi)	< 0.5	B2 < 2 B4 < 2.5
Efficiency (%)	B5 > 35 B12/B13 > 30	B2 > 45 B4 > 55
Return Loss (dB)	≥ 6dB	

# Antenna Specification

Item	GPS	WiFi/BT
Frequency (MHz)	1559-1601	2400-2500
Peak Gain (dBi)	< 2	< 2.5
Efficiency (%)	> 60	> 60
Return Loss (dB)	$\geq 10$ dB	$\geq 10$ dB

# Antenna Structure & Placement

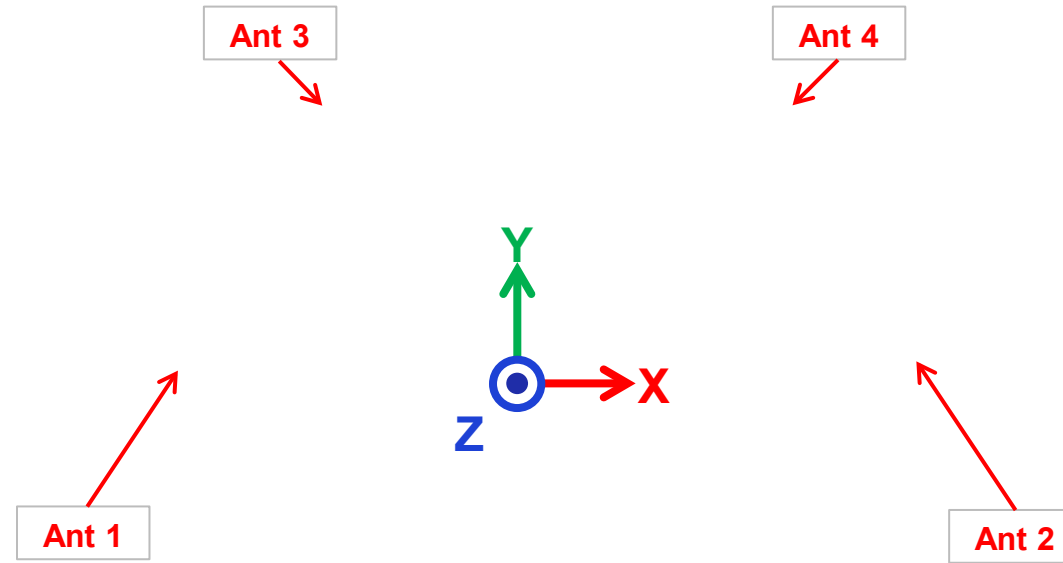

Full unit is used for antenna performance measurement.

Ant No.	Operating Band	Type	Material	Feeding	Dimension
Ant 1 (LTE Main)	B2/B4/B5/B12/B13	PIFA	Metal	Trace	59.9 x 8.6 x 9.8 mm <sup>3</sup>
Ant 2 (LTE Div.)	B2/B4/B5/B12/B13	Monopole	Metal	Trace	64.1 x 8.6 x 9.6 mm <sup>3</sup>
Ant 3	GPS	PIFA	Metal	Trace	25.5 x 4.9 x 8.8 mm <sup>3</sup>
Ant 4	WiFi 2.4G / BT	PIFA	Metal	Trace	20 x 4.9 x 8.8 mm <sup>3</sup>

# Return Loss – Ant 1 LTE Main

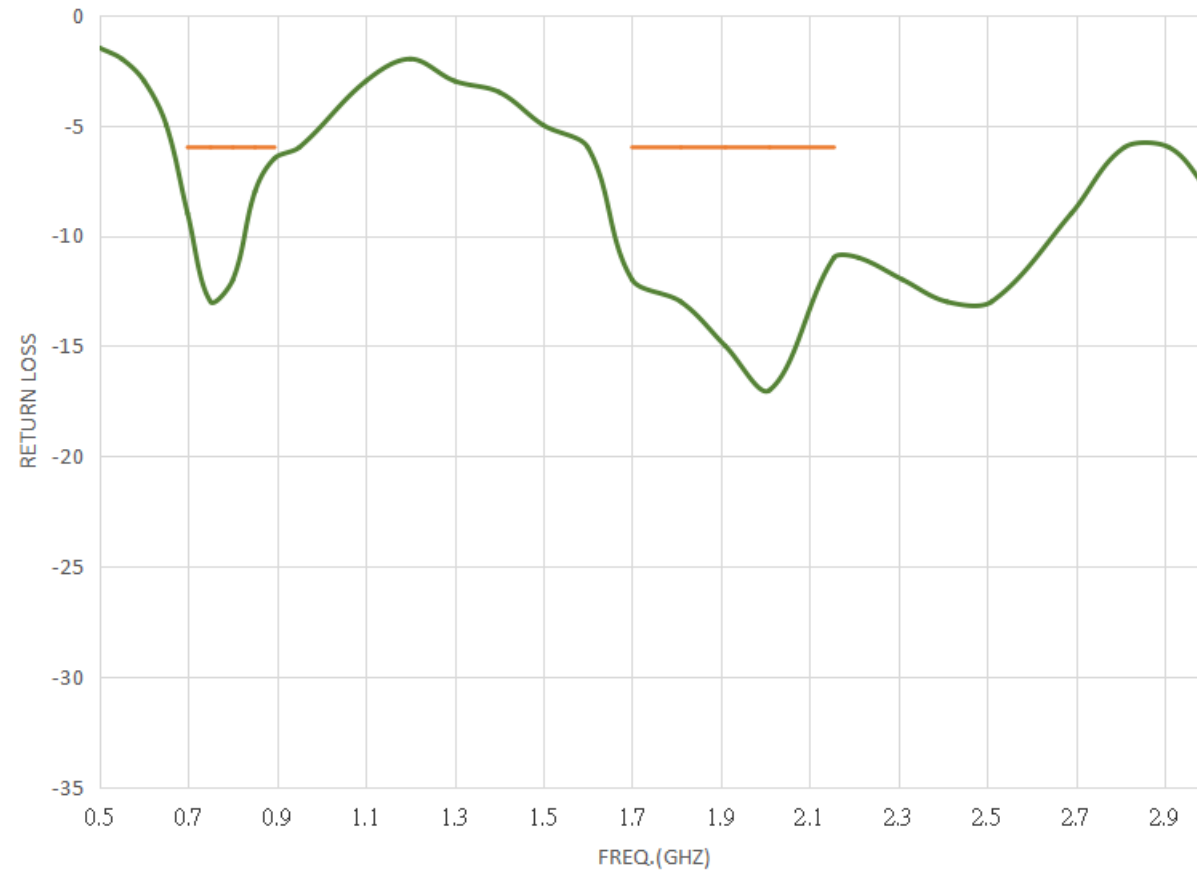

## Matching values

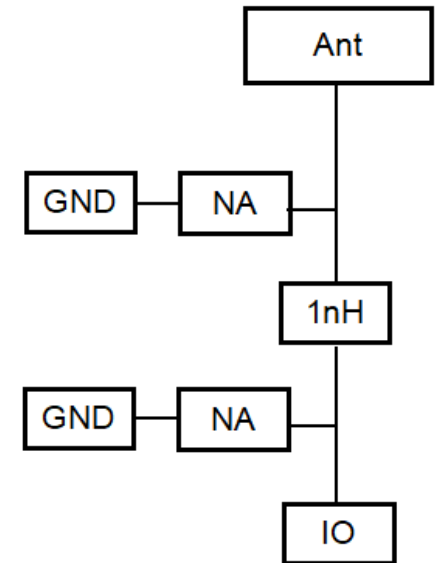

# Return Loss – Ant 2 LTE Div.

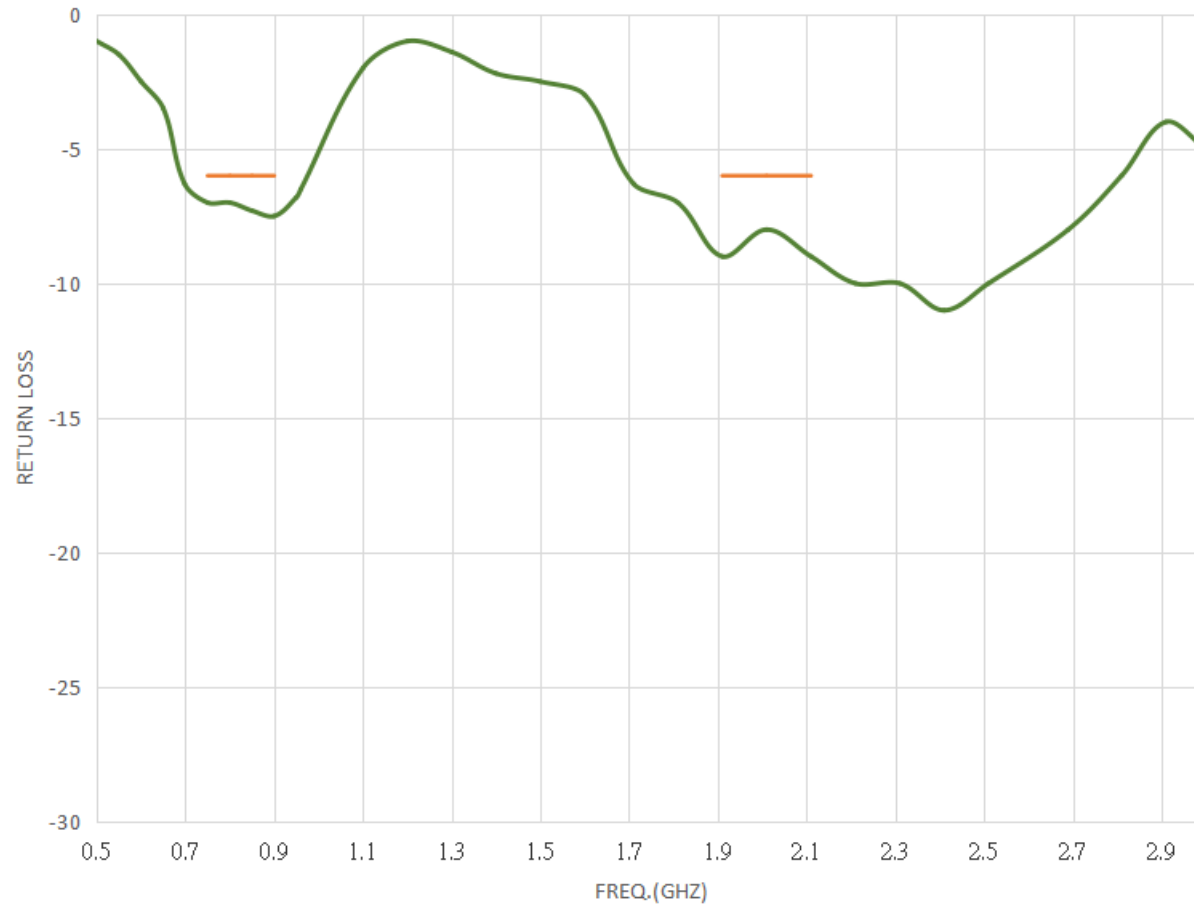

## Matching values

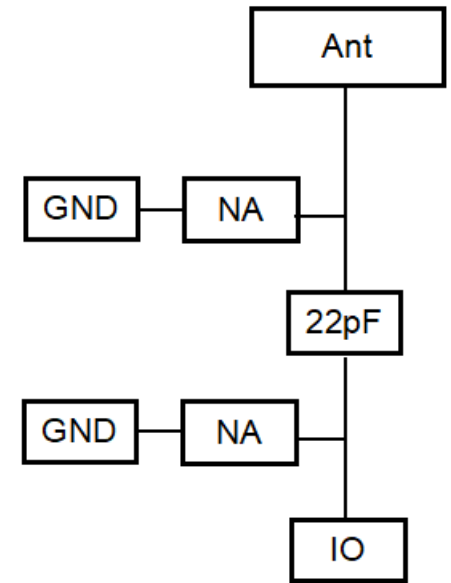

# Return Loss – Ant 3 GPS

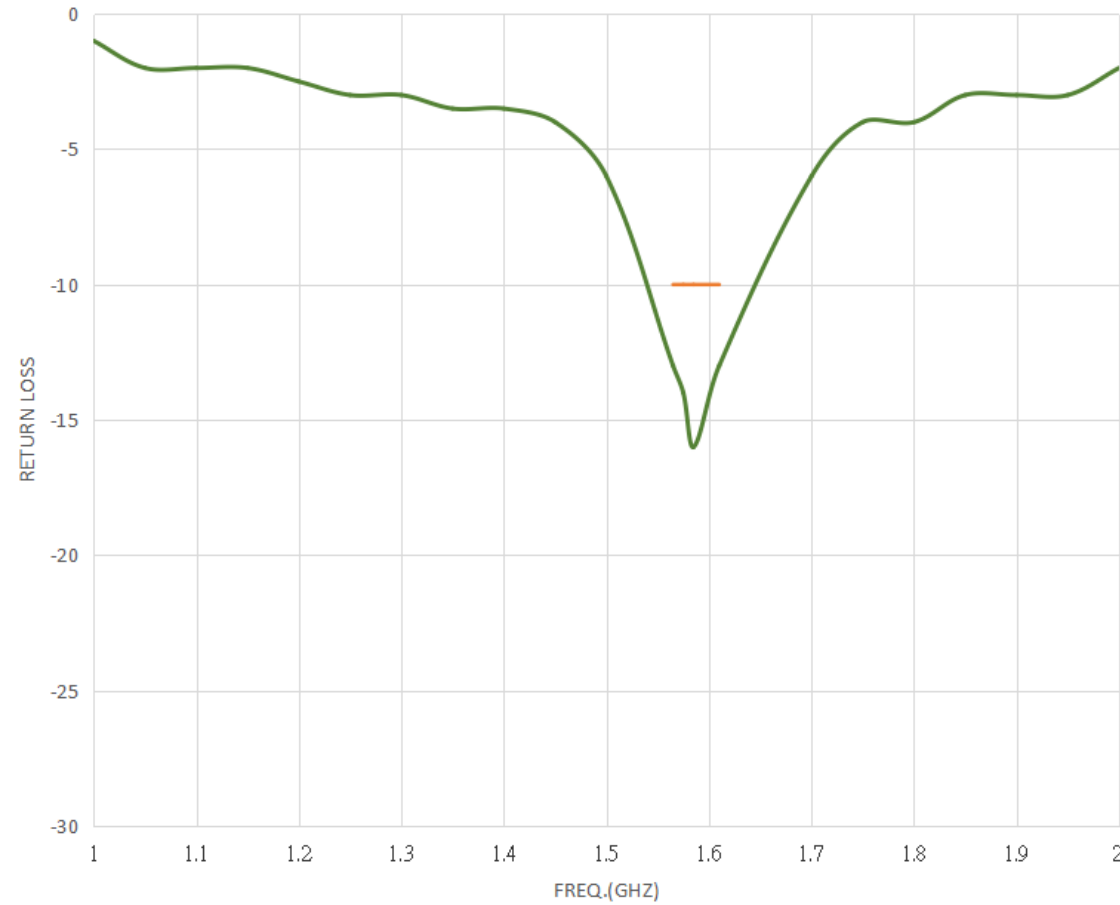

## Matching values

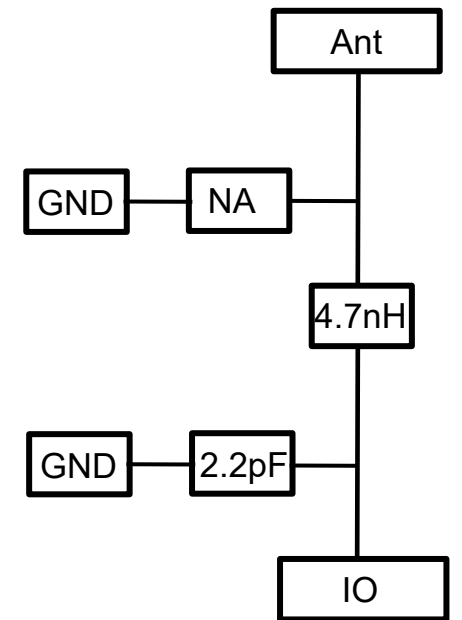



# Return Loss – Ant 4 WiFi 2.4G/BT

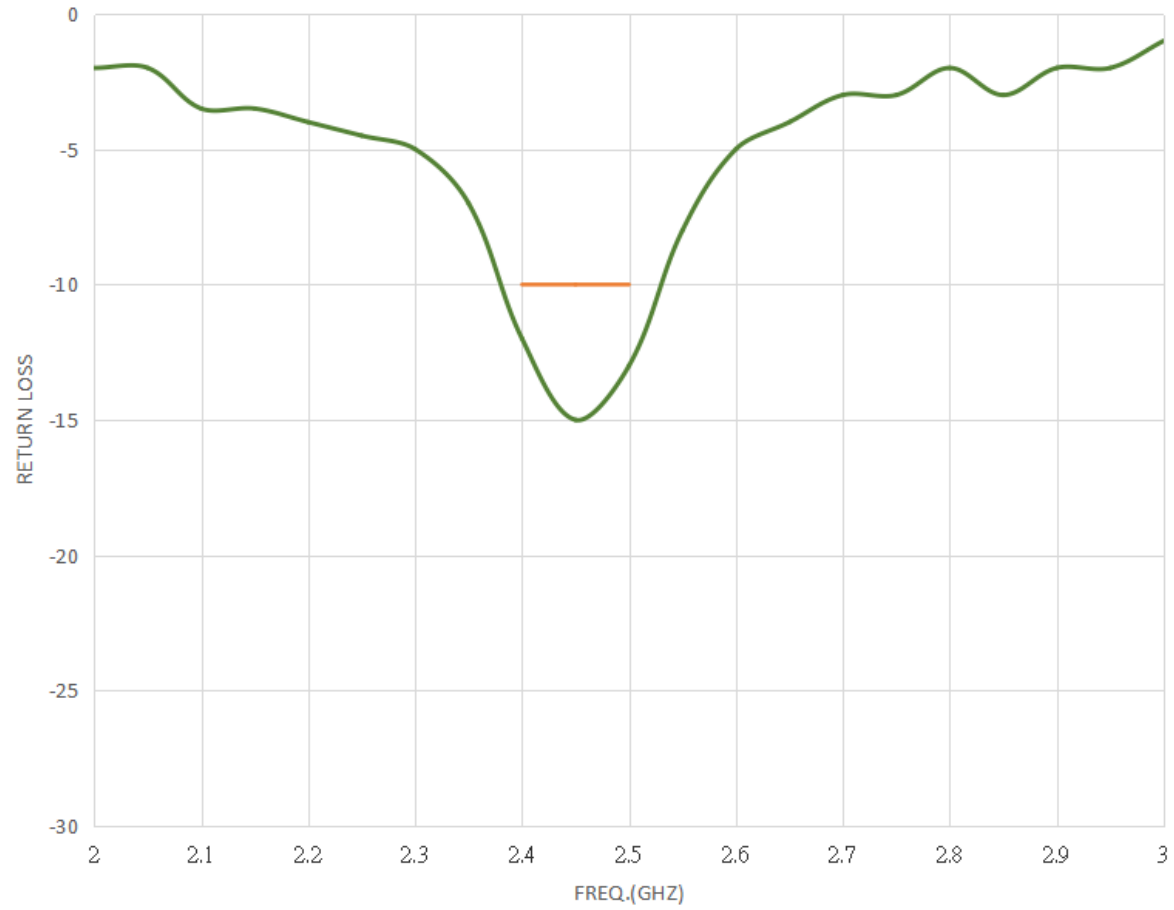

# Isolation – Ant 1 & Ant 2

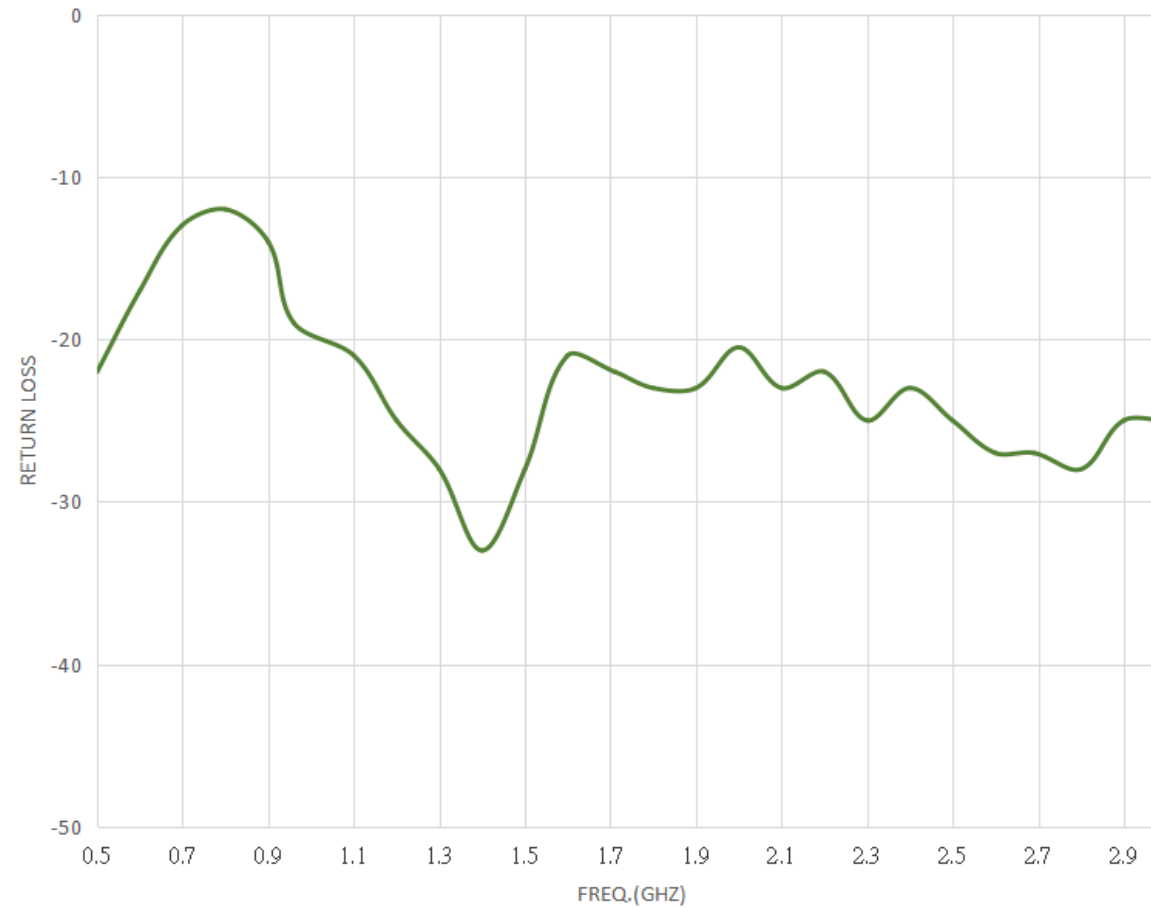

# Isolation – Ant 1 & Ant 3, 4

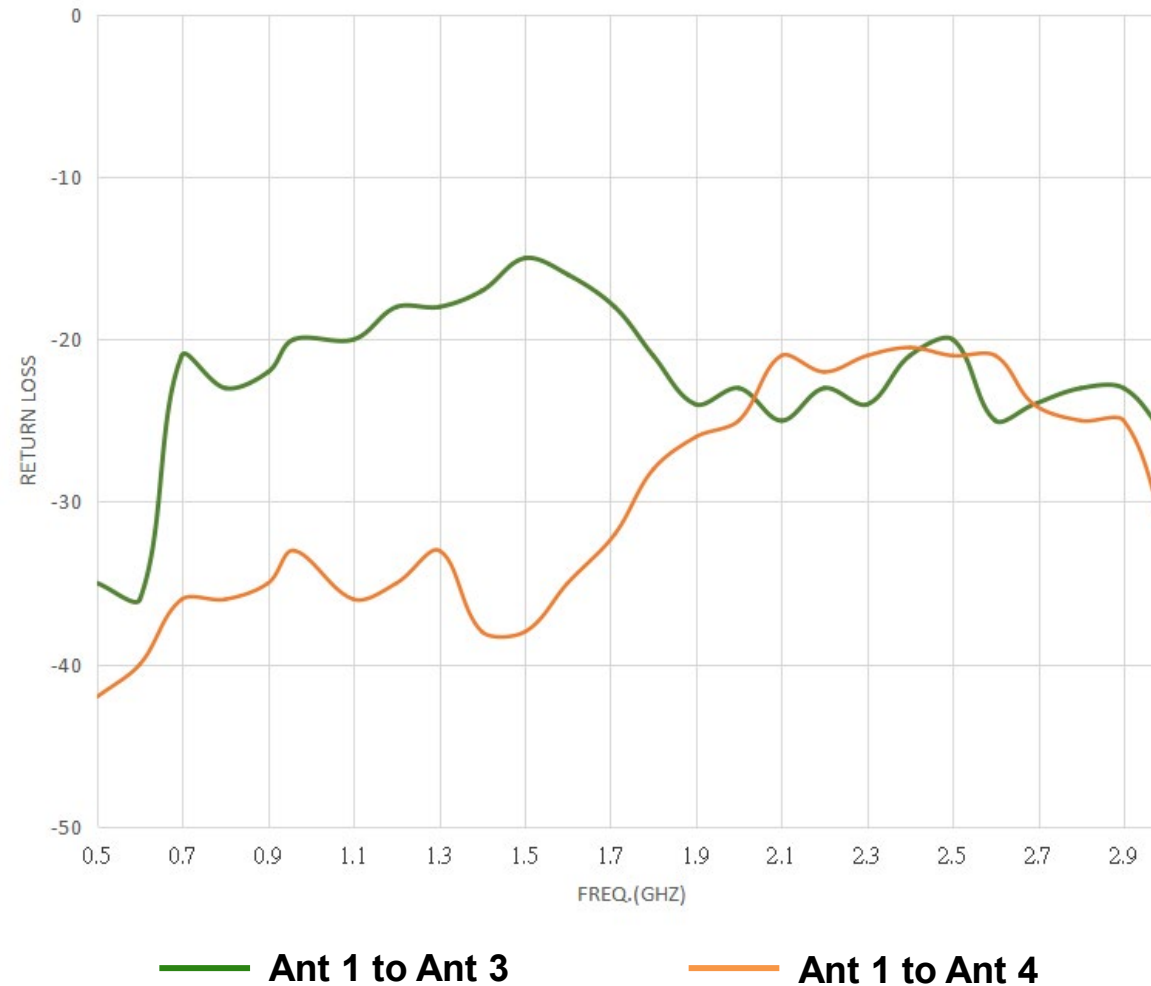

# Isolation – Ant 2 & Ant 3, 4

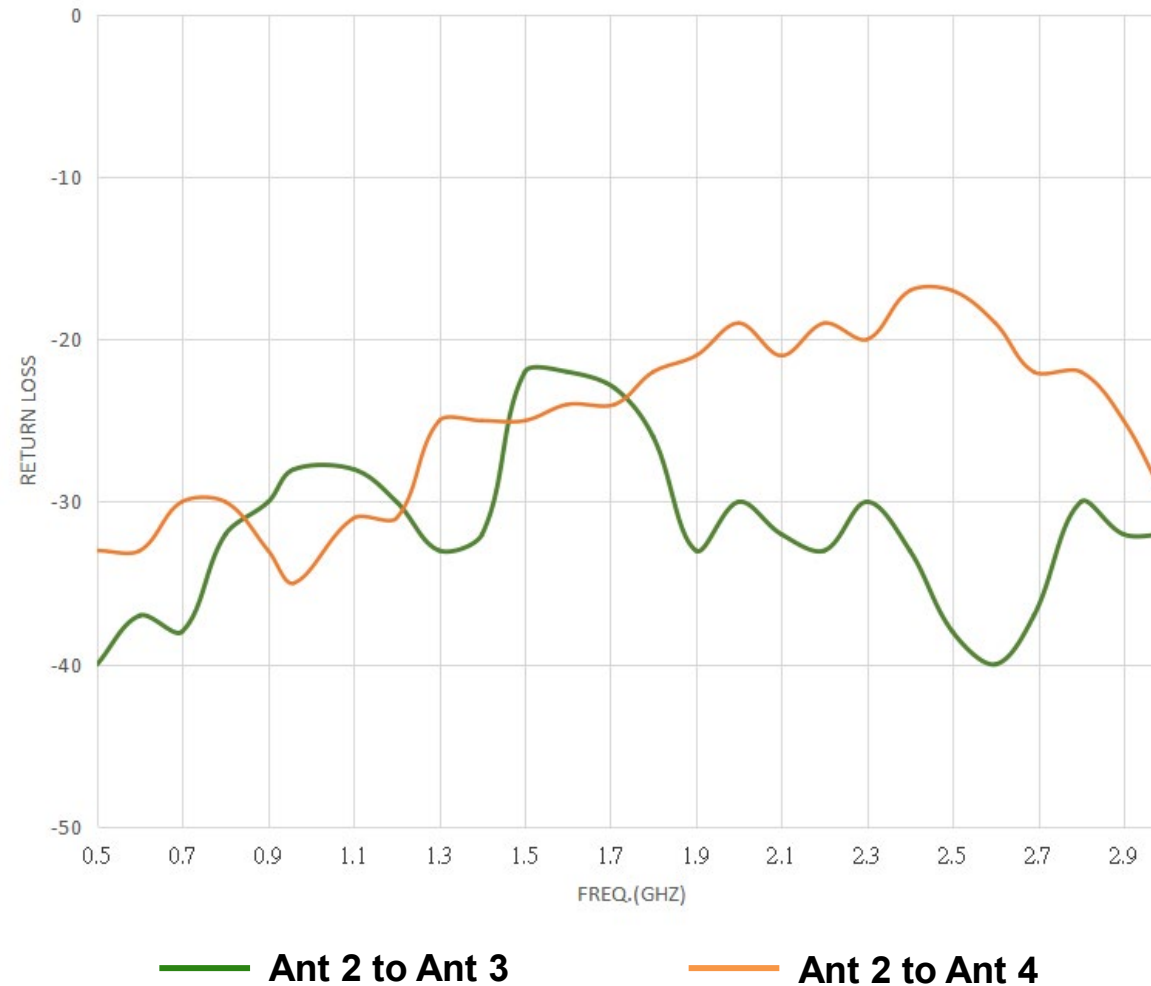

# 3D Radiation Pattern – Ant 1 @ B5

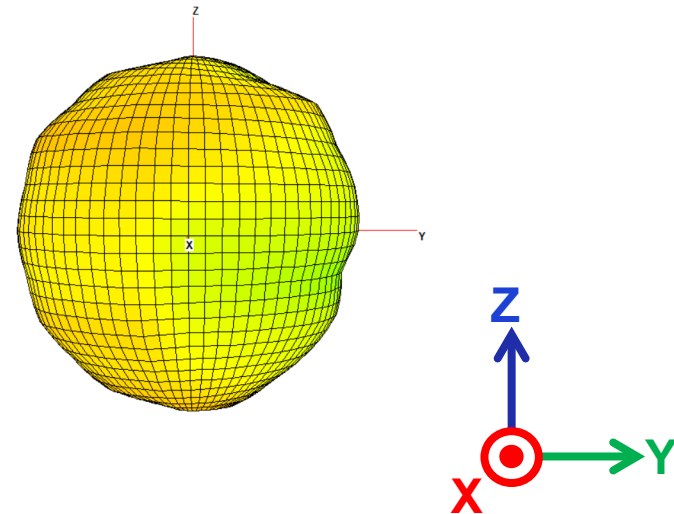
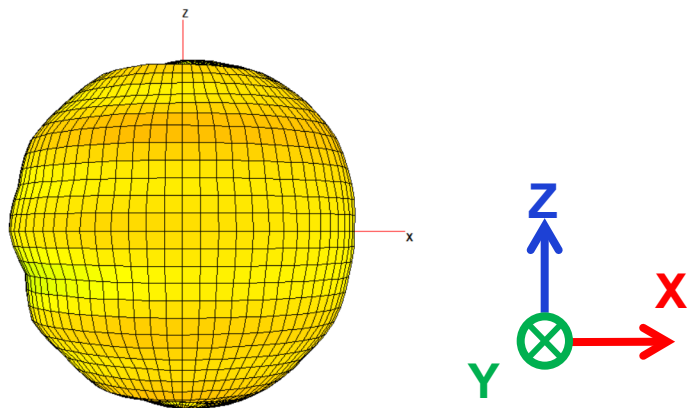
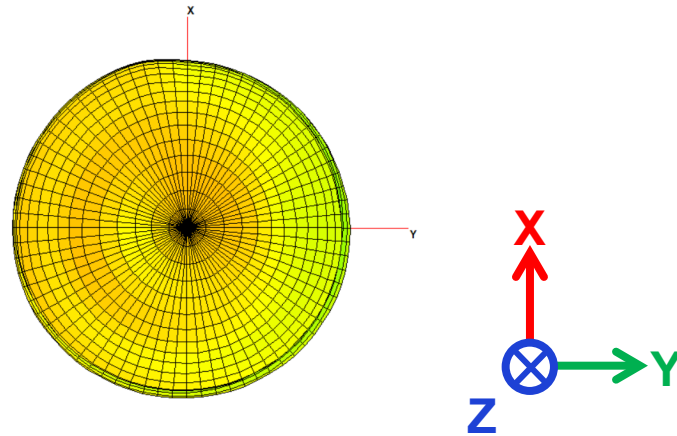
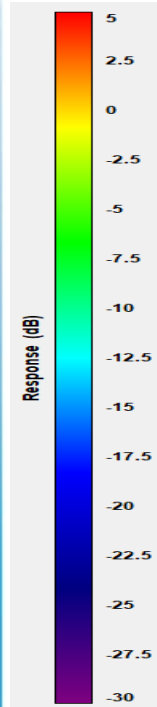

# 3D Radiation Pattern – Ant 1 @ B12

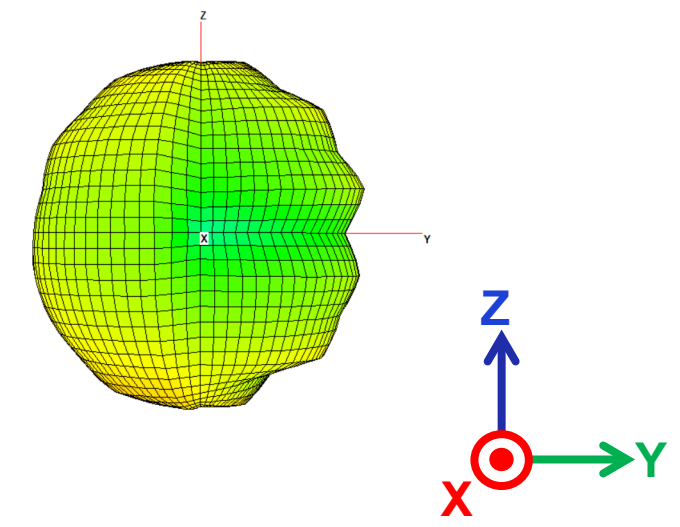
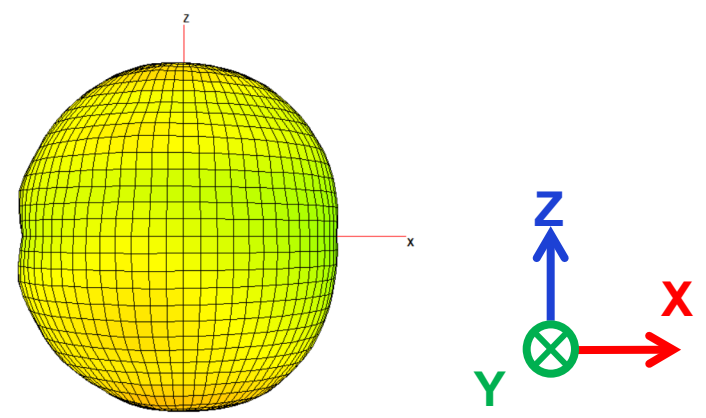
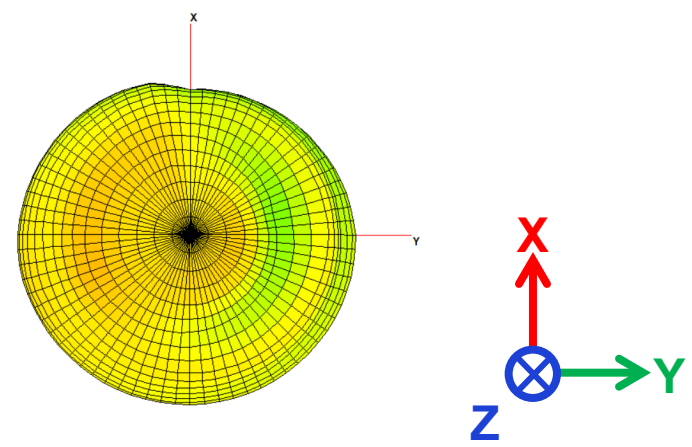
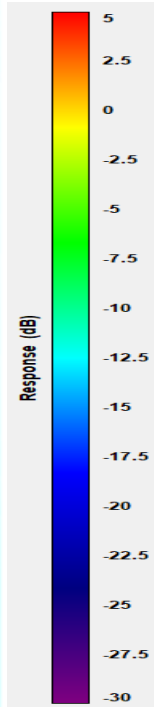

# 3D Radiation Pattern – Ant 1 @ B13

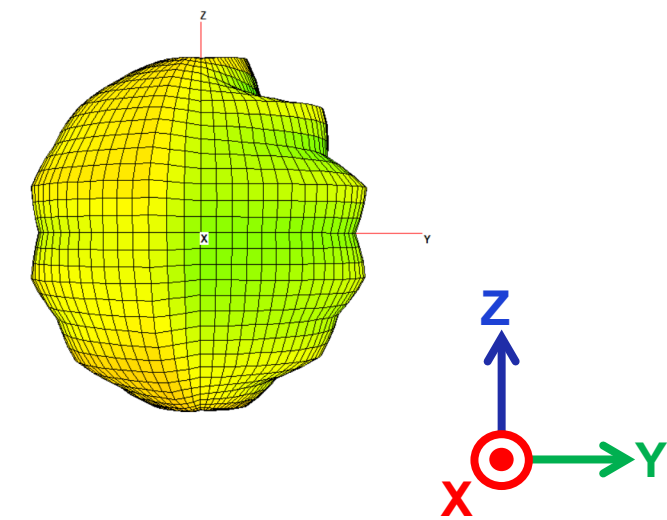
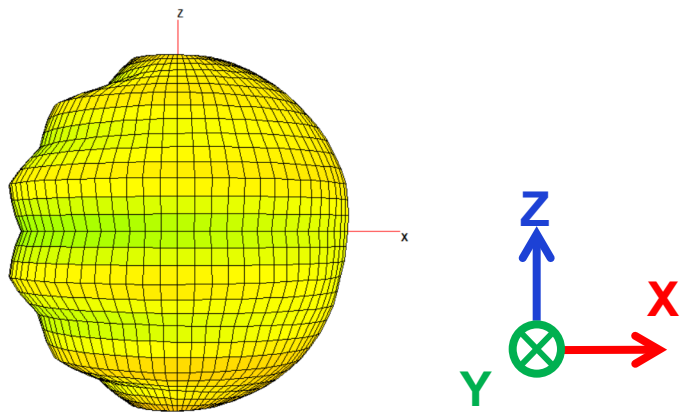
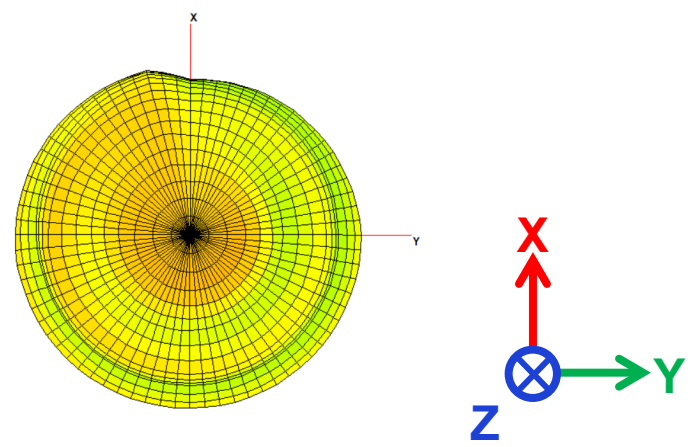
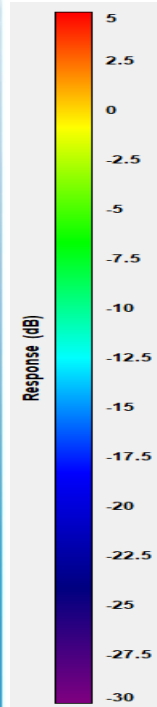

# 3D Radiation Pattern – Ant 1 @ B2

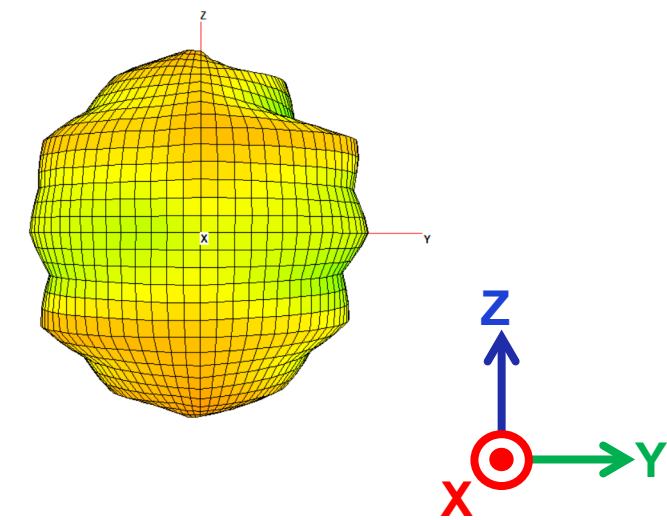
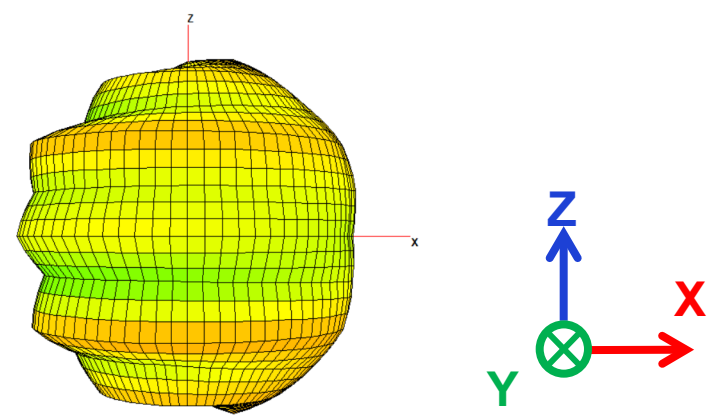
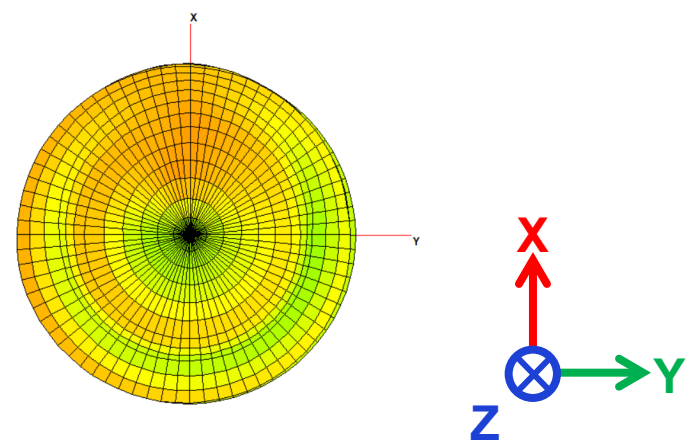
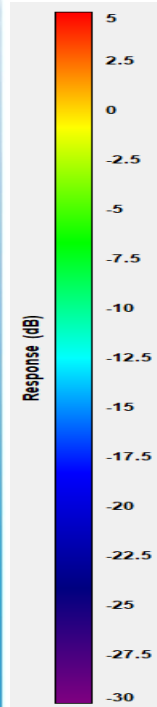



# 3D Radiation Pattern – Ant 1 @ B4

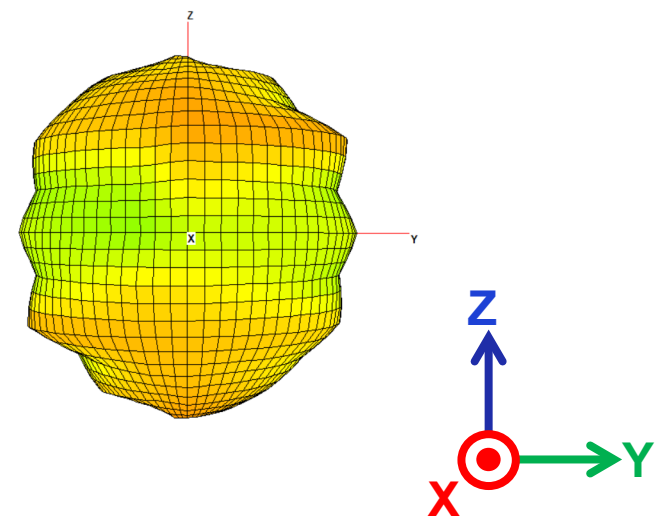
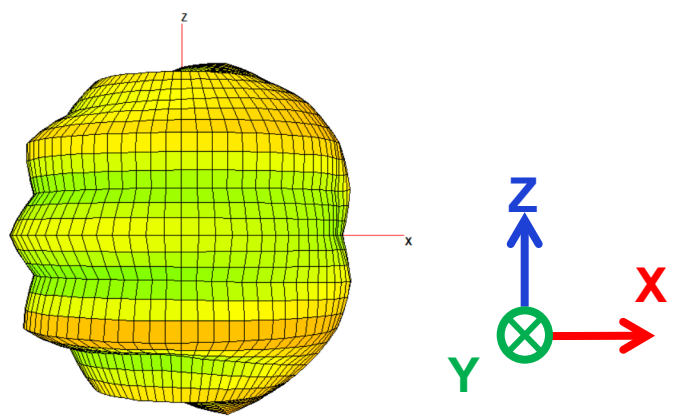
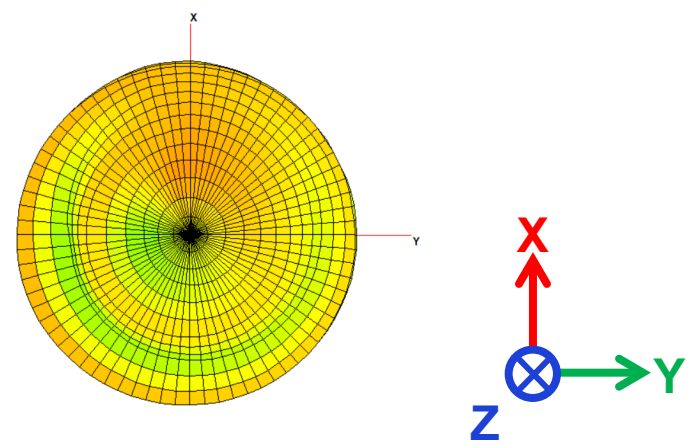
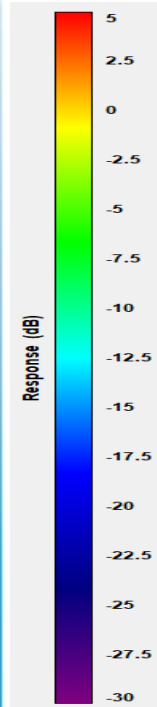

# 3D Radiation Pattern – Ant 2 @ B5

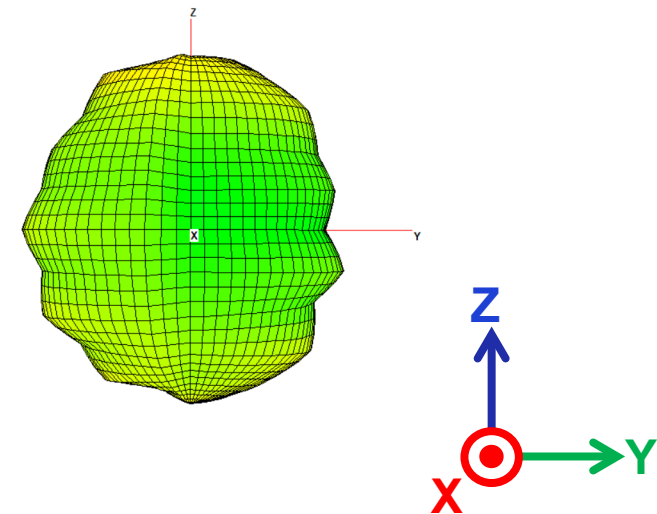
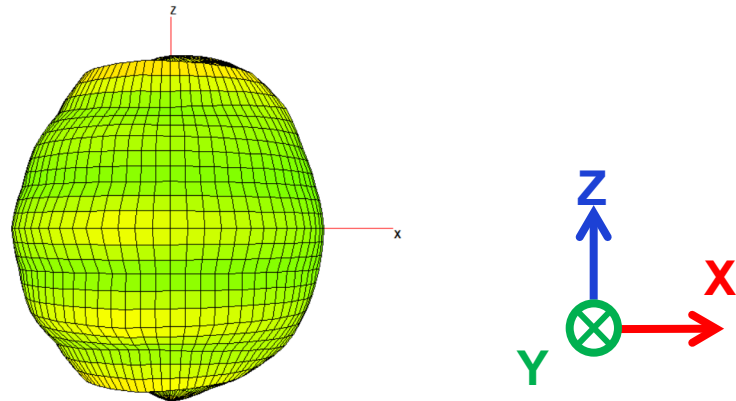
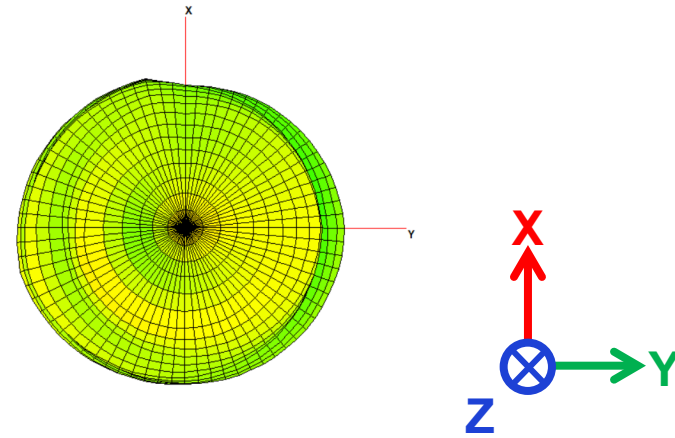
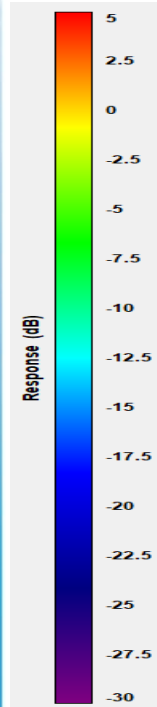

# 3D Radiation Pattern – Ant 2 @ B12

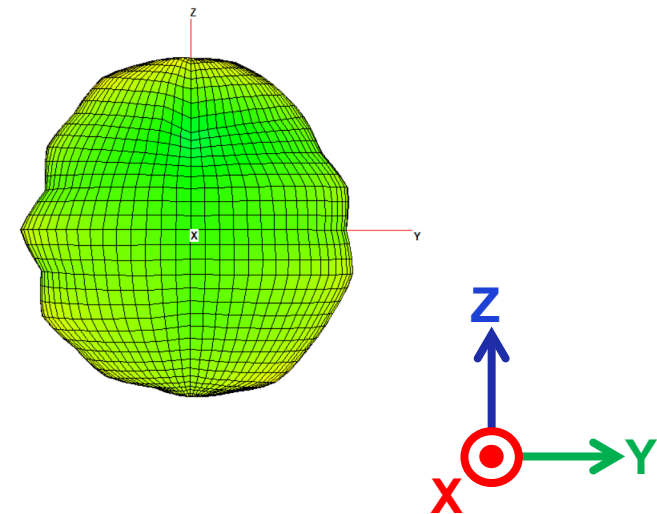
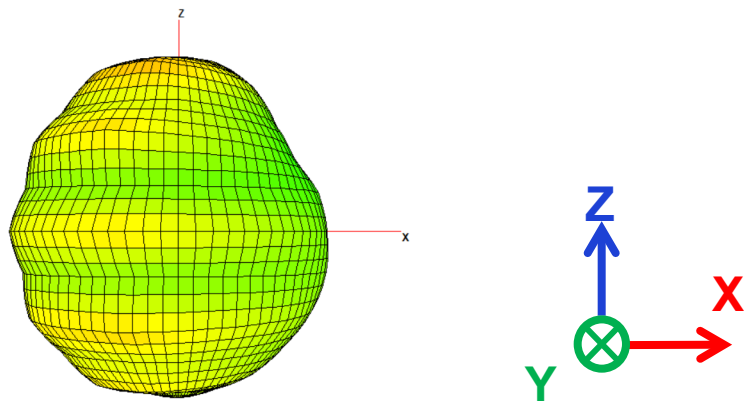
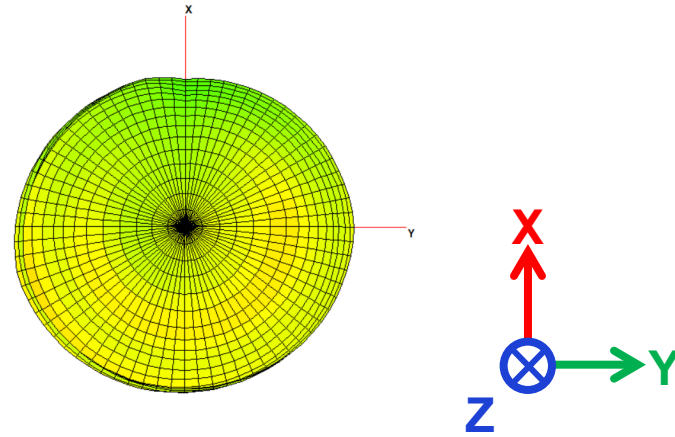
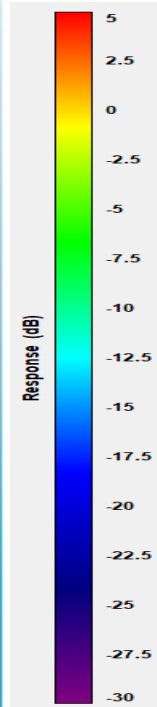

# 3D Radiation Pattern – Ant 2 @ B13

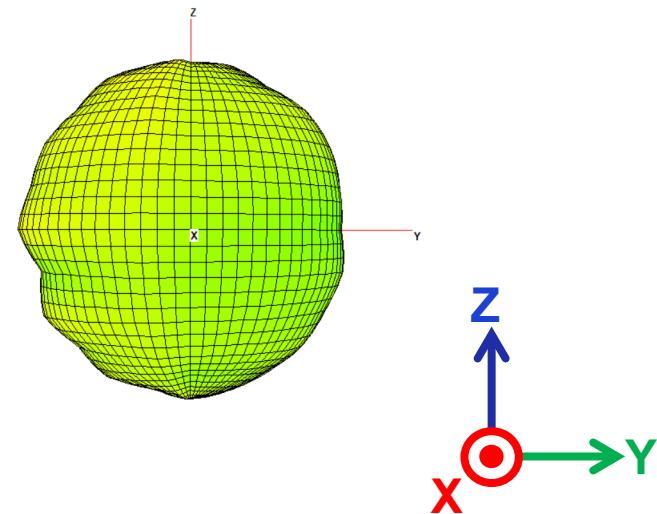
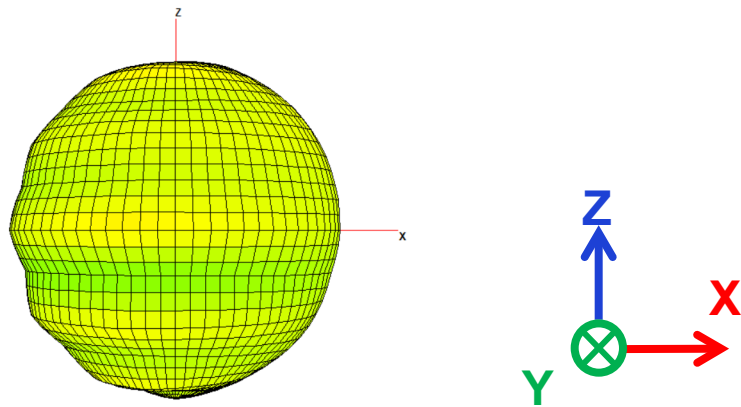
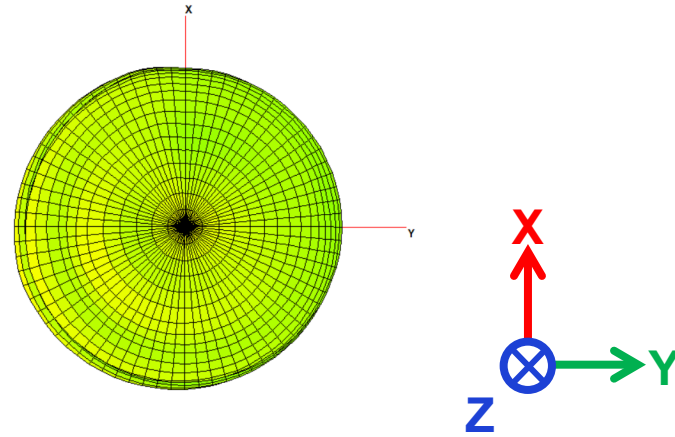
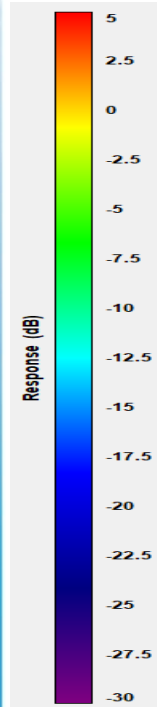

# 3D Radiation Pattern – Ant 2 @ B2

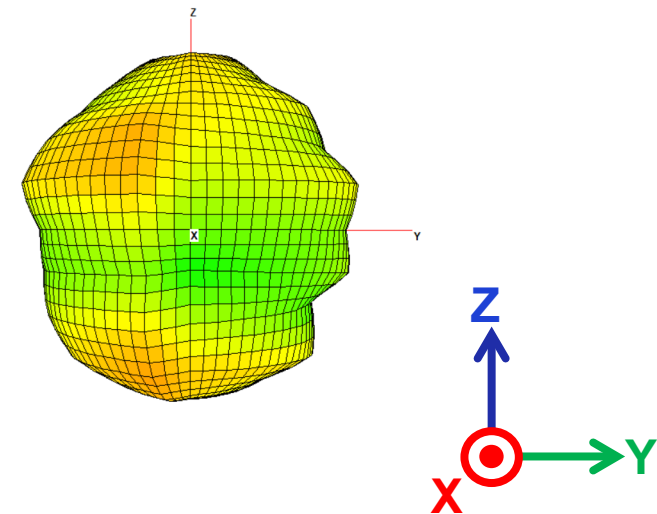
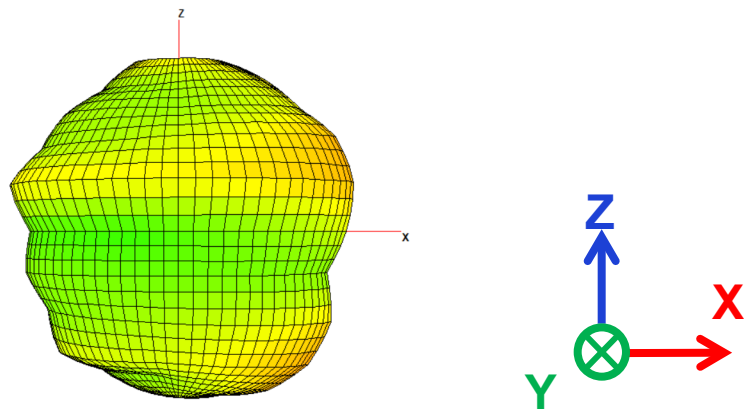
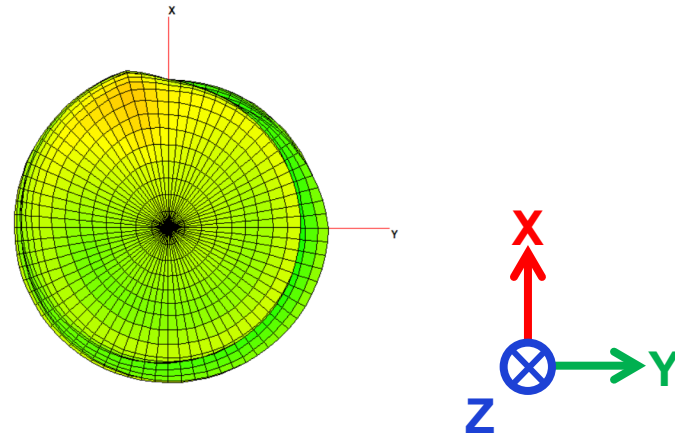
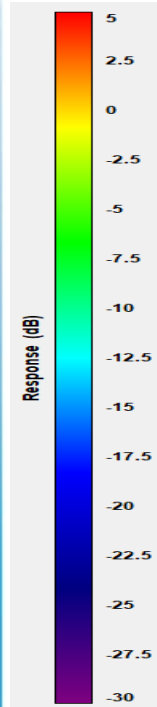

# 3D Radiation Pattern – Ant 2 @ B4

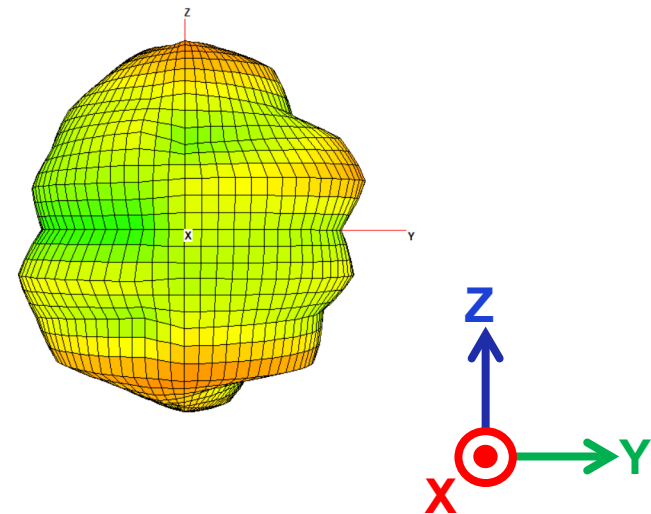
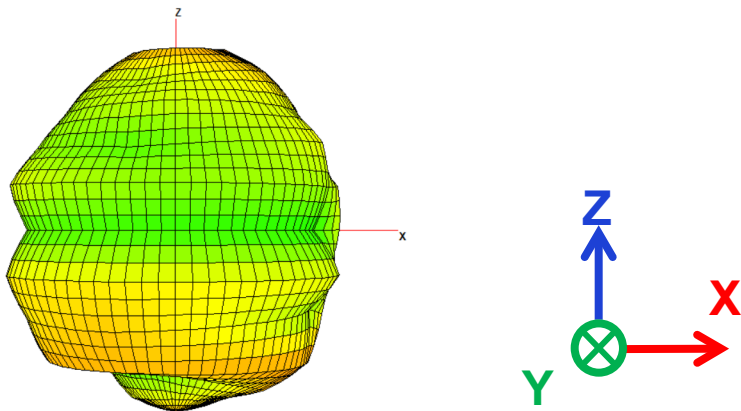
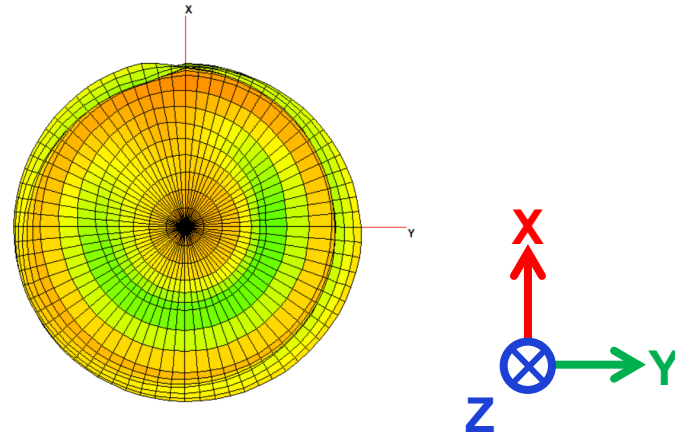
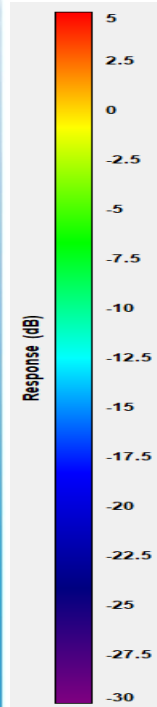

# 3D Radiation Pattern – Ant 3 @ 1.575G

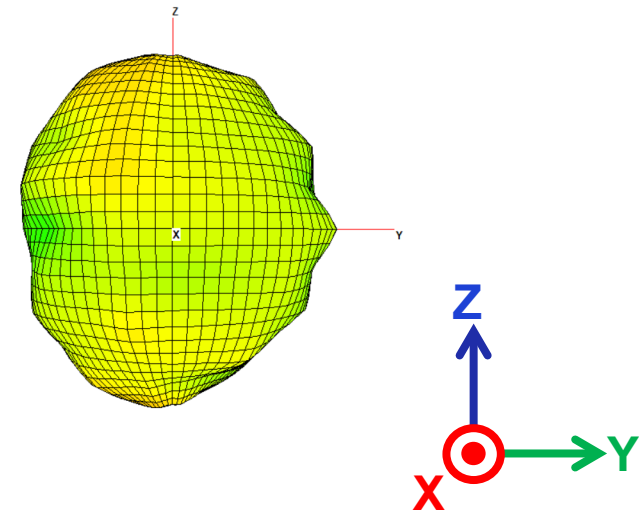
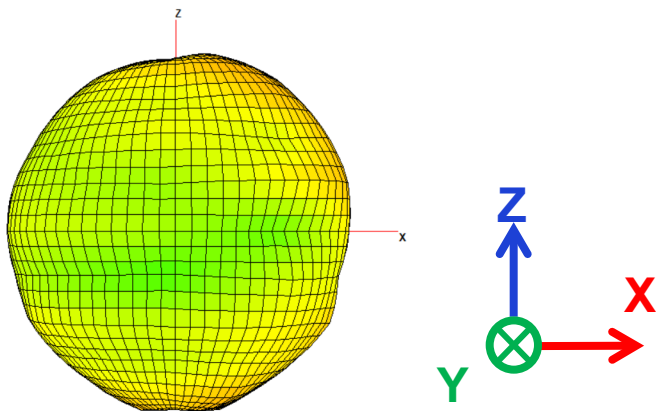
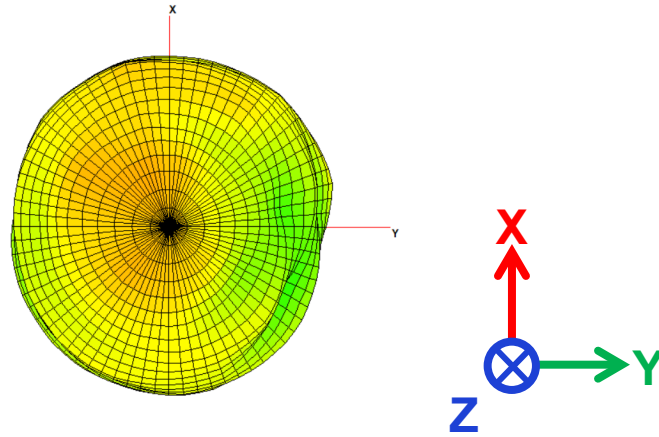
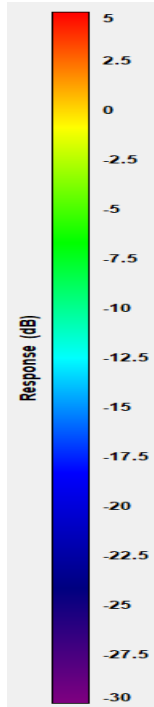

# 3D Radiation Pattern – Ant 4 @ 2.4GHz

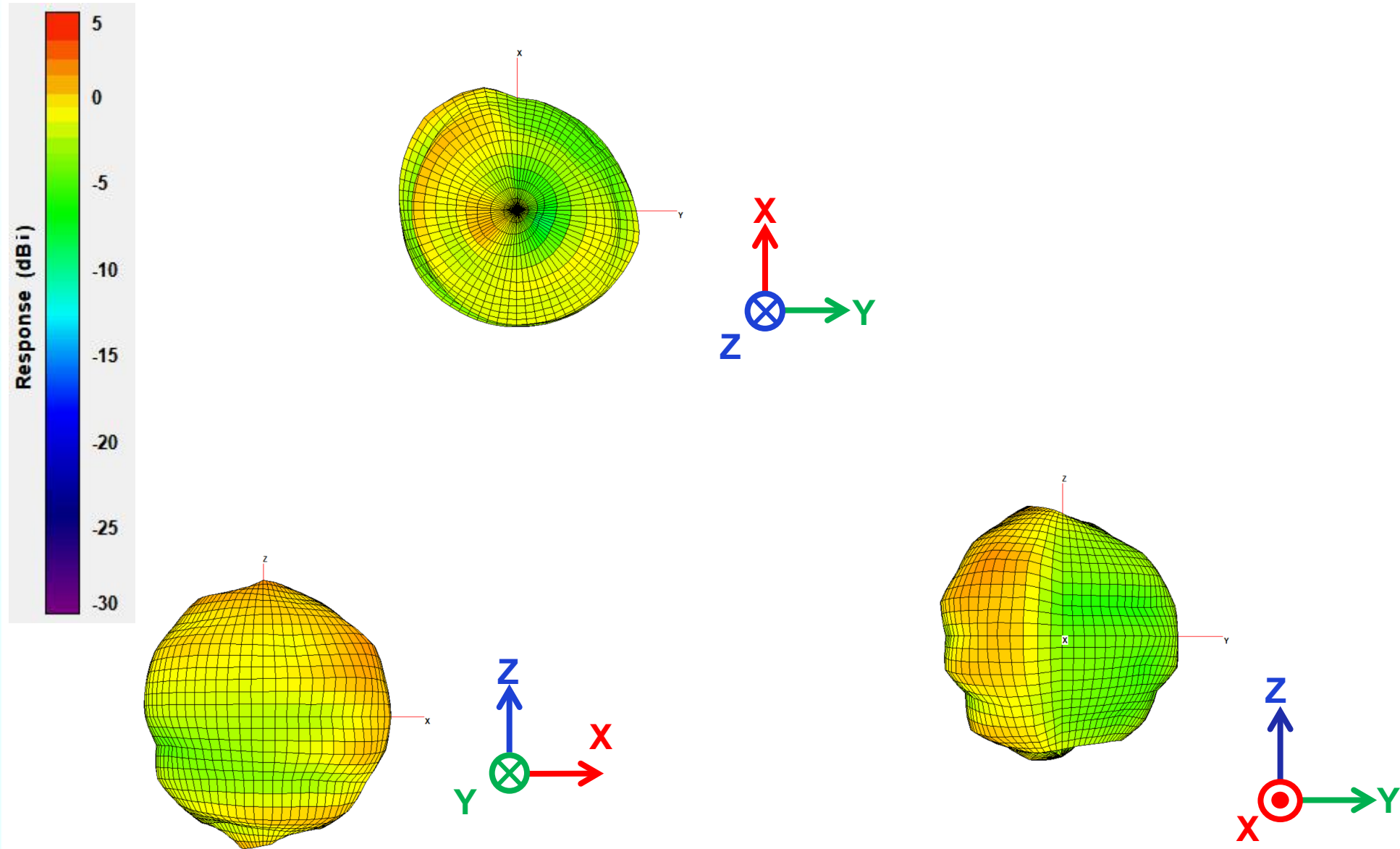



# Peak Gain & Efficiency

## Ant 1 LTE Main

Frequency (MHz)	B5	B12	B13	B2	B4
Peak Gain (dBi)	TX : 1.2 RX : 1.5	TX : 0.9 RX : 1.1	TX : 1.4 RX : 1.3	TX : 1.5 RX : 2.1	TX : 1.6 RX : 2.4
Efficiency (%)	49 ~ 53	48 ~ 52	47 ~ 53	57 ~ 66	56 ~ 67

## Ant 2 LTE Div.

Frequency (MHz)	B5	B12	B13	B2	B4
Peak Gain (dBi)	RX : 0.3	RX : -0.1	RX : 0.2	RX : 1.7	RX : 2.2
Efficiency (%)	37 ~ 41	35 ~ 37	35 ~ 38	55 ~ 59	56 ~ 61

## Ant 3 GPS

Frequency (MHz)	GPS
Peak Gain (dBi)	2.1
Efficiency (%)	61 ~ 65

## Ant 4 WiFi 2.4G/BT

Frequency (MHz)	WiFi 2.4G/BT
Peak Gain (dBi)	2.4
Efficiency (%)	63 ~ 66

**SERCOMM**

[www.sercomm.com](http://www.sercomm.com)