



FCC RF Test Report

APPLICANT : Wistron NeWeb Corporation
EQUIPMENT : LGA Module
BRAND NAME : Wistron Neweb Corporation
MODEL NAME : M18Q2, M18Q2F, M18Q2G, M18Q2FG
FCC ID : NKRM18Q2
STANDARD : 47 CFR Part 2, 22(H), 24(E), 27(L), 27(H)
CLASSIFICATION : PCS Licensed Transmitter (PCB)

The product was received on Feb. 26, 2016 and completely tested on Apr. 12, 2016. We, SPORTON INTERNATIONAL (KUNSHAN) INC., would like to declare that the tested sample has been evaluated in accordance with the test procedures given in ANSI / TIA / EIA-603-D-2010 and the testing has shown the tested sample to be in compliance with the applicable technical standards.

The test results in this report apply exclusively to the tested model / sample. Without written approval of SPORTON INTERNATIONAL (KUNSHAN) INC., the test report shall not be reproduced except in full.

Prepared by: James Huang / Manager

Approved by: Jones Tsai / Manager



SPORTON INTERNATIONAL (KUNSHAN) INC.
No. 3-2, PingXiang Road, Kunshan, Jiangsu Province, P. R. China



TABLE OF CONTENTS

REVISION HISTORY..... 3
SUMMARY OF TEST RESULT 4
1 GENERAL DESCRIPTION 6
1.1 Applicant 6
1.2 Manufacturer 6
1.3 Product Feature of Equipment Under Test..... 6
1.4 Product Specification of Equipment Under Test..... 7
1.5 Modification of EUT 8
1.6 Emission Designator 8
1.7 Testing Location 10
1.8 Applicable Standards..... 10
2 TEST CONFIGURATION OF EQUIPMENT UNDER TEST 11
2.1 Test Mode 11
2.2 Connection Diagram of Test System..... 13
2.3 Support Unit used in test configuration and system 14
2.4 Measurement Results Explanation Example..... 14
2.5 Frequency List of Low/Middle/High Channels 15
3 CONDUCTED TEST ITEMS 17
3.1 Measuring Instruments 17
3.2 Test Setup 17
3.3 Test Result of Conducted Test 17
3.4 Conducted Output Power and ERP/EIRP 18
3.5 Peak-to-Average Ratio 19
3.6 Occupied Bandwidth 20
3.7 Conducted Band Edge 21
3.8 Conducted Spurious Emission 23
3.9 Frequency Stability 24
4 RADIATED TEST ITEMS 25
4.1 Measuring Instruments 25
4.2 Test Setup 25
4.3 Test Result of Radiated Test 25
4.4 Radiated Spurious Emission 26
5 LIST OF MEASURING EQUIPMENT 27
6 UNCERTAINTY OF EVALUATION 28
APPENDIX A. TEST RESULTS OF CONDUCTED TEST
APPENDIX B. TEST RESULTS OF RADIATED TEST
APPENDIX C. TEST SETUP PHOTOGRAPHS



SUMMARY OF TEST RESULT

| Report Section | FCC Rule | Description | Limit | Result | Remark |
|----------------|---|---|------------------------|--------|--------|
| 3.4 | §2.1046 | Conducted Output Power | Reporting Only | PASS | - |
| 3.4 | §22.913(a)(2) | Effective Radiated Power (Band 5) | ERP < 7 Watt | PASS | - |
| | §27.50(c)(10) | Effective Radiated Power (Band 12) | ERP < 3 Watt | | |
| | §24.232(c) | Equivalent Isotropic Radiated Power (Band 2) | EIRP < 2Watt | | |
| | §27.50(d)(4) | Equivalent Isotropic Radiated Power (Band 4) | EIRP < 1Watt | | |
| 3.5 | §24.232(d) | Peak-to-Average Ratio | <13 dB | PASS | - |
| 3.6 | §2.1049 | Occupied Bandwidth | Reporting Only | PASS | - |
| 3.7 | §2.1051 §22.917(a) §24.238(a) §27.53(g) §27.53(h) | Conducted Band Edge Measurement (Band 2) (Band 4) (Band 5) (Band 12) | < 43+10log10(P[Watts]) | PASS | - |



| Report Section | FCC Rule | Description | Limit | Result | Remark |
|----------------|---|--|-------------------------------------|--------|---|
| 3.8 | §2.1051 §22.917(a) §24.238(a) §27.53(g) §27.53(h) | Conducted Spurious Emission (Band 2) (Band 4) (Band 5) (Band 12) | $< 43+10\log_{10}(P[\text{Watts}])$ | PASS | - |
| 3.9 | §2.1055 §22.355 | Frequency Stability Temperature & Voltage | $< 2.5 \text{ ppm for Part 22}$ | PASS | - |
| | §2.1055 §24.235 §27.54 | | Within Authorized Band | | |
| 4.4 | §2.1053 §22.917(a) §24.238(a) §27.53(g) §27.53(h) | Radiated Spurious Emission (Band 2) (Band 4) (Band 5) (Band 12) | $< 43+10\log_{10}(P[\text{Watts}])$ | PASS | Under limit 6.88 dB at 2122.000 MHz |



1 General Description

1.1 Applicant

Wistron NeWeb Corporation

20 Park Avenue II, Hsinchu Science Park, Hsinchu 308, Taiwan, R.O.C

1.2 Manufacturer

Wistron NeWeb Corporation

20 Park Avenue II, Hsinchu Science Park, Hsinchu 308, Taiwan, R.O.C

1.3 Product Feature of Equipment Under Test

| Product Feature | |
|---------------------------------|--|
| Equipment | LGA Module |
| Brand Name | Wistron Neweb Corporation |
| Model Name | M18Q2, M18Q2F, M18Q2G, M18Q2FG |
| FCC ID | NKRM18Q2 |
| EUT supports Radios application | WCDMA/HSPA/HSPA+(16QAM uplink is not supported)/DC-HSDPA/LTE |
| HW Version | v1.0 |
| SW Version | M18Q2_v12.03 |
| EUT Stage | Identical Prototype |

Remark: There are four types of EUT, the details are summary as the following table.

| Function | Model Name | | | |
|----------|---------------|---------------|---------------|---------------|
| | M18Q2 | M18Q2F | M18Q2G | M18Q2FG |
| LTE | Supported | Supported | Supported | Supported |
| UMTS | Not Supported | Supported | Not Supported | Supported |
| Voice | Not Supported | Not Supported | Not Supported | Not Supported |
| AGPS | Not Supported | Not Supported | Supported | Supported |
| VoLTE | Not Supported | Not Supported | Not Supported | Not Supported |

All the functions are enabled or disabled by software; the hardware part is electrically identical for each model. According to the difference list above, we evaluate is not affect RF performance, so only choose M18Q2F to perform RF test.



1.4 Product Specification of Equipment Under Test

| Standards-related Product Specification | |
|---|---|
| Tx Frequency | LTE Band 2 : 1850.7 MHz ~ 1909.3 MHz LTE Band 4 : 1710.7 MHz ~ 1754.3 MHz LTE Band 5 : 824.7 MHz ~ 848.3 MHz LTE Band 12 : 699.7 MHz ~ 715.3 MHz |
| Rx Frequency | LTE Band 2 : 1930.7 MHz ~ 1989.3 MHz LTE Band 4 : 2110.7 MHz ~ 2154.3 MHz LTE Band 5 : 869.7 MHz ~ 893.3 MHz LTE Band 12 : 729.7 MHz ~ 745.3 MHz |
| Bandwidth | LTE Band 2 : 1.4MHz / 3MHz / 5MHz / 10MHz / 15MHz / 20MHz LTE Band 4 : 1.4MHz / 3MHz / 5MHz / 10MHz / 15MHz / 20MHz LTE Band 5 : 1.4MHz / 3MHz / 5MHz / 10MHz LTE Band 12 : 1.4MHz / 3MHz / 5MHz / 10MHz |
| Maximum Output Power to Antenna | LTE Band 2 : 23.07 dBm LTE Band 4 : 23.77 dBm LTE Band 5 : 23.43 dBm LTE Band 12 : 23.50 dBm |
| Type of Modulation | QPSK / 16QAM |



1.5 Modification of EUT

No modifications are made to the EUT during all test items.

1.6 Emission Designator

| LTE Band 2 | | QPSK | | 16QAM | | |
|------------|------------------------------|---------------------------|-----------------|------------------------------|---------------------------|-----------------|
| BW(MHz) | Emission Designator (99%OBW) | Frequency Tolerance (ppm) | Maximum EIRP(W) | Emission Designator (99%OBW) | Frequency Tolerance (ppm) | Maximum EIRP(W) |
| 1.4 | 1M10G7D | - | 1.3459 | 1M09W7D | - | 1.1482 |
| 3 | 2M74G7D | - | 1.2972 | 2M73W7D | - | 1.0940 |
| 5 | 4M52G7D | - | 1.2647 | 4M50W7D | - | 1.0304 |
| 10 | 9M03G7D | 0.0025 | 1.3552 | 9M03W7D | - | 1.0990 |
| 15 | 13M5G7D | - | 1.3032 | 13M5W7D | - | 0.9931 |
| 20 | 18M5G7D | - | 1.4355 | 18M3W7D | - | 1.0000 |
| LTE Band 4 | | QPSK | | 16QAM | | |
| BW(MHz) | Emission Designator (99%OBW) | Frequency Tolerance (ppm) | Maximum EIRP(W) | Emission Designator (99%OBW) | Frequency Tolerance (ppm) | Maximum EIRP(W) |
| 1.4 | 1M09G7D | - | 0.9162 | 1M09W7D | - | 0.7063 |
| 3 | 2M73G7D | - | 0.8995 | 2M72W7D | - | 0.6668 |
| 5 | 4M50G7D | - | 0.8551 | 4M51W7D | - | 0.6761 |
| 10 | 9M03G7D | 0.0029 | 0.9462 | 8M97W7D | - | 0.6699 |
| 15 | 13M5G7D | - | 0.9376 | 13M5W7D | - | 0.6902 |
| 20 | 18M3G7D | - | 0.9484 | 18M3W7D | - | 0.7015 |



| LTE Band 5 | QPSK | | | 16QAM | | |
|-------------|------------------------------|---------------------------|----------------|------------------------------|---------------------------|----------------|
| BW(MHz) | Emission Designator (99%OBW) | Frequency Tolerance (ppm) | Maximum ERP(W) | Emission Designator (99%OBW) | Frequency Tolerance (ppm) | Maximum ERP(W) |
| 1.4 | 1M10G7D | - | 1.0399 | 1M09W7D | - | 0.8630 |
| 3 | 2M73G7D | - | 1.0139 | 2M73W7D | - | 0.8670 |
| 5 | 4M51G7D | - | 1.0280 | 4M52W7D | - | 0.7745 |
| 10 | 8M99G7D | 0.0063 | 1.0666 | 9M07W7D | - | 0.7834 |
| LTE Band 12 | QPSK | | | 16QAM | | |
| BW(MHz) | Emission Designator (99%OBW) | Frequency Tolerance (ppm) | Maximum ERP(W) | Emission Designator (99%OBW) | Frequency Tolerance (ppm) | Maximum ERP(W) |
| 1.4 | 1M10G7D | - | 1.0691 | 1M10W7D | - | 0.8810 |
| 3 | 2M73G7D | - | 1.0544 | 2M73W7D | - | 0.8017 |
| 5 | 4M50G7D | - | 1.0568 | 4M52W7D | - | 0.7962 |
| 10 | 9M11G7D | 0.0088 | 1.0839 | 9M07W7D | - | 0.8017 |



1.7 Testing Location

| | | | |
|---------------------------|---|-----------|-----------------------------|
| Test Site | SPORTON INTERNATIONAL (KUNSHAN) INC. | | |
| Test Site Location | No. 3-2, PingXiang Road, Kunshan, Jiangsu Province, P. R. China TEL: +86-0512-5790-0158 FAX: +86-0512-5790-0958 | | |
| Test Site No. | Sporton Site No. | | FCC Registration No. |
| | TH01-KS | 03CH02-KS | 418269 |

1.8 Applicable Standards

According to the specifications of the manufacturer, the EUT must comply with the requirements of the following standards:

- ♦ 47 CFR Part 2, 22(H), 24(E), 27(L), 27(H)
- ♦ ANSI / TIA / EIA-603-D-2010
- ♦ FCC KDB 971168 D01 Power Meas. License Digital Systems v02r02
- ♦ FCC KDB 412172 D01 Determining ERP and EIRP v01r01

Remark:

1. All test items were verified and recorded according to the standards and without any deviation during the test.
2. This EUT has also been tested and complied with the requirements of FCC Part 15, Subpart B, recorded in a separate test report.



2 Test Configuration of Equipment Under Test

2.1 Test Mode

Antenna port conducted and radiated test items listed below are performed according to KDB 971168 D01 Power Meas. License Digital Systems v02r02 with maximum output power.

Radiated measurements are performed by rotating the EUT in three different orthogonal test planes to find the maximum emission.

| Test Items | Band | Bandwidth (MHz) | | | | | | Modulation | | RB # | | | Test Channel | | |
|------------------------|------|-----------------|---|---|----|----|----|------------|-------|------|------|------|--------------|---|---|
| | | 1.4 | 3 | 5 | 10 | 15 | 20 | QPSK | 16QAM | 1 | Half | Full | L | M | H |
| Max. Output Power | 2 | ✓ | ✓ | ✓ | ✓ | ✓ | ✓ | ✓ | ✓ | ✓ | ✓ | ✓ | ✓ | ✓ | ✓ |
| | 4 | ✓ | ✓ | ✓ | ✓ | ✓ | ✓ | ✓ | ✓ | ✓ | ✓ | ✓ | ✓ | ✓ | ✓ |
| | 5 | ✓ | ✓ | ✓ | ✓ | - | - | ✓ | ✓ | ✓ | ✓ | ✓ | ✓ | ✓ | ✓ |
| | 12 | ✓ | ✓ | ✓ | ✓ | - | - | ✓ | ✓ | ✓ | ✓ | ✓ | ✓ | ✓ | ✓ |
| Peak-to-Average Ratio | 2 | | | | | | ✓ | ✓ | ✓ | ✓ | | ✓ | ✓ | ✓ | ✓ |
| | 4 | | | | | | ✓ | ✓ | ✓ | ✓ | | ✓ | ✓ | ✓ | ✓ |
| | 5 | | | | ✓ | - | - | ✓ | ✓ | ✓ | | ✓ | ✓ | ✓ | ✓ |
| | 12 | | | | ✓ | - | - | ✓ | ✓ | ✓ | | ✓ | ✓ | ✓ | ✓ |
| 26dB and 99% Bandwidth | 2 | ✓ | ✓ | ✓ | ✓ | ✓ | ✓ | ✓ | ✓ | | | ✓ | ✓ | ✓ | ✓ |
| | 4 | ✓ | ✓ | ✓ | ✓ | ✓ | ✓ | ✓ | ✓ | | | ✓ | ✓ | ✓ | ✓ |
| | 5 | ✓ | ✓ | ✓ | ✓ | - | - | ✓ | ✓ | | | ✓ | ✓ | ✓ | ✓ |
| | 12 | ✓ | ✓ | ✓ | ✓ | - | - | ✓ | ✓ | | | ✓ | ✓ | ✓ | ✓ |
| Conducted Band Edge | 2 | ✓ | ✓ | ✓ | ✓ | ✓ | ✓ | ✓ | ✓ | ✓ | | ✓ | ✓ | | ✓ |
| | 4 | ✓ | ✓ | ✓ | ✓ | ✓ | ✓ | ✓ | ✓ | ✓ | | ✓ | ✓ | | ✓ |
| | 5 | ✓ | ✓ | ✓ | ✓ | - | - | ✓ | ✓ | ✓ | | ✓ | ✓ | | ✓ |
| | 12 | ✓ | ✓ | ✓ | ✓ | - | - | ✓ | ✓ | ✓ | | ✓ | ✓ | | ✓ |



| Test Items | Band | Bandwidth (MHz) | | | | | | Modulation | | RB # | | | Test Channel | | |
|-----------------------------|---|-----------------|---|---|----|----|----|------------|-------|------|------|------|--------------|---|---|
| | | 1.4 | 3 | 5 | 10 | 15 | 20 | QPSK | 16QAM | 1 | Half | Full | L | M | H |
| Conducted Spurious Emission | 2 | √ | √ | √ | √ | √ | √ | √ | √ | √ | | | √ | √ | √ |
| | 4 | √ | √ | √ | √ | √ | √ | √ | √ | √ | | | √ | √ | √ |
| | 5 | √ | √ | √ | √ | - | - | √ | √ | √ | | | √ | √ | √ |
| | 12 | √ | √ | √ | √ | - | - | √ | √ | √ | | | √ | √ | √ |
| Frequency Stability | 2 | | | | √ | | | √ | | | | √ | | √ | |
| | 4 | | | | √ | | | √ | | | | √ | | √ | |
| | 5 | | | | √ | - | - | √ | | | | √ | | √ | |
| | 12 | | | | √ | - | - | √ | | | | √ | | √ | |
| E.R.P./ E.I.R.P. | 2 | √ | √ | √ | √ | √ | √ | √ | √ | √ | √ | | √ | √ | √ |
| | 4 | √ | √ | √ | √ | √ | √ | √ | √ | √ | √ | | √ | √ | √ |
| | 5 | √ | √ | √ | √ | - | - | √ | √ | √ | √ | | √ | √ | √ |
| | 12 | √ | √ | √ | √ | - | - | √ | √ | √ | √ | | √ | √ | √ |
| Radiated Spurious Emission | 2 | √ | √ | √ | √ | √ | √ | √ | | √ | | | | √ | |
| | 4 | √ | √ | √ | √ | √ | √ | √ | | √ | | | | √ | |
| | 5 | √ | √ | √ | √ | - | - | √ | | √ | | | | √ | |
| | 12 | √ | √ | √ | √ | - | - | √ | | √ | | | | √ | |
| Note | <p>1. The mark “√” means that this configuration is chosen for testing</p> <p>2. The mark “-” means that this bandwidth is not supported.</p> <p>3. The device is investigated from 30MHz to 10 times of fundamental signal for radiated spurious emission test under different RB size/offset and modulations in exploratory test. Subsequently, only the worst case emissions are reported.</p> | | | | | | | | | | | | | | |

2.2 Connection Diagram of Test System

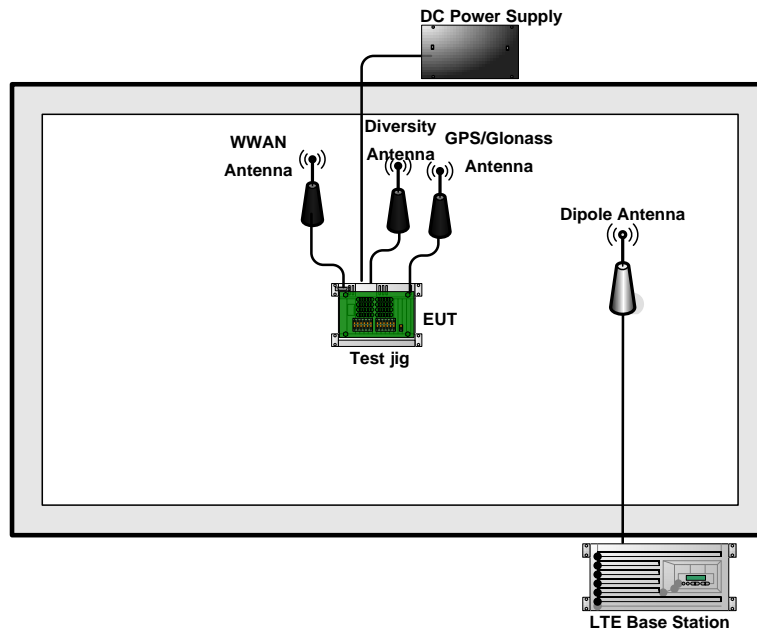



2.3 Support Unit used in test configuration and system

| Item | Equipment | Trade Name | Model No. | FCC ID | Data Cable | Power Cord |
|------|---------------------|------------|-----------|--------|------------|-------------------|
| 1. | LTE Base Station | Anritsu | MT8820C | N/A | N/A | Unshielded, 1.8 m |
| 2. | DC Power Supply | GW | GPS-3030D | N/A | N/A | Unshielded, 1.8 m |
| 3. | WWAN Antenna | N/A | N/A | N/A | N/A | N/A |
| 4. | Diversity Antenna | N/A | N/A | N/A | N/A | N/A |
| 5. | GPS/Glonass Antenna | N/A | N/A | N/A | N/A | N/A |
| 6. | Test jig | N/A | N/A | N/A | N/A | N/A |

2.4 Measurement Results Explanation Example

For all conducted test items:

The offset level is set in the spectrum analyzer to compensate the RF cable loss between EUT conducted output port and spectrum analyzer. With the offset compensation, the spectrum analyzer reading level is exactly the EUT RF output level.

The spectrum analyzer offset is derived from RF cable loss.

$$\text{Offset} = \text{RF cable loss.}$$

Following shows an offset computation example with cable loss 4.5 dB.

Example :

$$\begin{aligned} \text{Offset(dB)} &= \text{RF cable loss(dB)}. \\ &= 4.5 \text{ (dB)} \end{aligned}$$



2.5 Frequency List of Low/Middle/High Channels

| LTE Band 2 Channel and Frequency List | | | | |
|---------------------------------------|------------------------|--------|--------|---------|
| BW [MHz] | Channel/Frequency(MHz) | Lowest | Middle | Highest |
| 20 | Channel | 18700 | 18900 | 19100 |
| | Frequency | 1860 | 1880 | 1900 |
| 15 | Channel | 18675 | 18900 | 19125 |
| | Frequency | 1857.5 | 1880 | 1902.5 |
| 10 | Channel | 18650 | 18900 | 19150 |
| | Frequency | 1855 | 1880 | 1905 |
| 5 | Channel | 18625 | 18900 | 19175 |
| | Frequency | 1852.5 | 1880 | 1907.5 |
| 3 | Channel | 18615 | 18900 | 19185 |
| | Frequency | 1851.5 | 1880 | 1908.5 |
| 1.4 | Channel | 18607 | 18900 | 19193 |
| | Frequency | 1850.7 | 1880 | 1909.3 |

| LTE Band 4 Channel and Frequency List | | | | |
|---------------------------------------|------------------------|--------|--------|---------|
| BW [MHz] | Channel/Frequency(MHz) | Lowest | Middle | Highest |
| 20 | Channel | 20050 | 20175 | 20300 |
| | Frequency | 1720 | 1732.5 | 1745 |
| 15 | Channel | 20025 | 20175 | 20325 |
| | Frequency | 1717.5 | 1732.5 | 1747.5 |
| 10 | Channel | 20000 | 20175 | 20350 |
| | Frequency | 1715 | 1732.5 | 1750 |
| 5 | Channel | 19975 | 20175 | 20375 |
| | Frequency | 1712.5 | 1732.5 | 1752.5 |
| 3 | Channel | 19965 | 20175 | 20385 |
| | Frequency | 1711.5 | 1732.5 | 1753.5 |
| 1.4 | Channel | 19957 | 20175 | 20393 |
| | Frequency | 1710.7 | 1732.5 | 1754.3 |



| LTE Band 5 Channel and Frequency List | | | | |
|---------------------------------------|------------------------|--------|--------|---------|
| BW [MHz] | Channel/Frequency(MHz) | Lowest | Middle | Highest |
| 10 | Channel | 20450 | 20525 | 20600 |
| | Frequency | 829 | 836.5 | 844 |
| 5 | Channel | 20425 | 20525 | 20625 |
| | Frequency | 826.5 | 836.5 | 846.5 |
| 3 | Channel | 20415 | 20525 | 20635 |
| | Frequency | 825.5 | 836.5 | 847.5 |
| 1.4 | Channel | 20407 | 20525 | 20643 |
| | Frequency | 824.7 | 836.5 | 848.3 |

| LTE Band 12 Channel and Frequency List | | | | |
|--|------------------------|--------|--------|---------|
| BW [MHz] | Channel/Frequency(MHz) | Lowest | Middle | Highest |
| 10 | Channel | 23060 | 23095 | 23130 |
| | Frequency | 704 | 707.5 | 711 |
| 5 | Channel | 23035 | 23095 | 23155 |
| | Frequency | 701.5 | 707.5 | 713.5 |
| 3 | Channel | 23025 | 23095 | 23165 |
| | Frequency | 700.5 | 707.5 | 714.5 |
| 1.4 | Channel | 23017 | 23095 | 23173 |
| | Frequency | 699.7 | 707.5 | 715.3 |

3 Conducted Test Items

3.1 Measuring Instruments

See list of measuring instruments of this test report.

3.2 Test Setup

3.2.1 Conducted Output Power

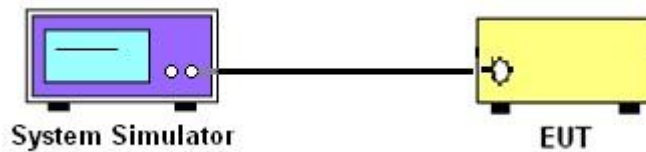

3.2.2 Peak-to-Average Ratio, Occupied Bandwidth ,Conducted Band-Edge and Conducted Spurious Emission

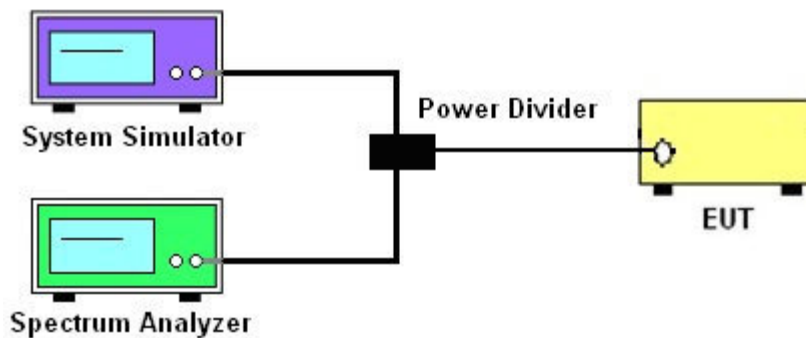

3.2.3 Frequency Stability

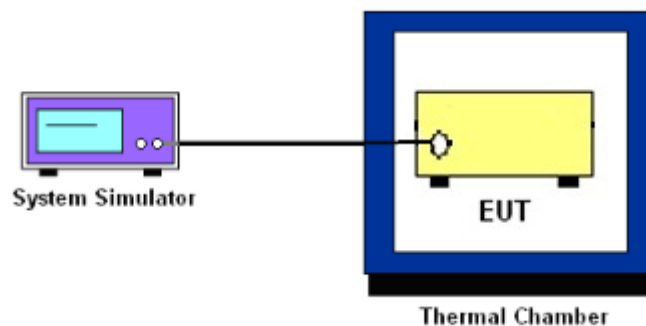

3.3 Test Result of Conducted Test

Please refer to Appendix A.



3.4 Conducted Output Power and ERP/EIRP

3.4.1 Description of the Conducted Output Power Measurement and ERP/EIRP Measurement

A system simulator was used to establish communication with the EUT. Its parameters were set to force the EUT transmitting at maximum output power. The measured power in the radio frequency on the transmitter output terminals shall be reported.

The ERP of mobile transmitters must not exceed 7 Watts for LTE Band 5.

The ERP of mobile transmitters must not exceed 3 Watts for LTE Band 12. (FCC Only)

The EIRP of mobile transmitters must not exceed 2 Watts for LTE Band 2.

The EIRP of mobile transmitters must not exceed 1 Watts for LTE Band 4.

According to KDB 412172 D01 Power Approach,

$EIRP = P_T + G_T - L_C$, $ERP = EIRP - 2.15$, where

P_T = transmitter output power in dBm

G_T = gain of the transmitting antenna in dBi

L_C = signal attenuation in the connecting cable between the transmitter and antenna in dB

3.4.2 Test Procedures

1. The transmitter output port was connected to the system simulator.
2. Set EUT at maximum power through the system simulator.
3. Select lowest, middle, and highest channels for each band and different modulation.
4. Measure and record the power level from the system simulator.



3.5 Peak-to-Average Ratio

3.5.1 Description of the PAR Measurement

Power Complementary Cumulative Distribution Function (CCDF) curves provide a means for characterizing the power peaks of a digitally modulated signal on a statistical basis. A CCDF curve depicts the probability of the peak signal amplitude exceeding the average power level. Most contemporary measurement instrumentation include the capability to produce CCDF curves for an input signal provided that the instrument's resolution bandwidth can be set wide enough to accommodate the entire input signal bandwidth. In measuring transmissions in this band using an average power technique, the peak-to-average ratio (PAR) of the transmission may not exceed 13 dB.

3.5.2 Test Procedures

1. The testing follows FCC KDB 971168 v02r02 Section 5.7.1.
2. The EUT was connected to spectrum and system simulator via a power divider.
3. Set the CCDF (Complementary Cumulative Distribution Function) option in spectrum analyzer.
4. The highest RF powers were measured and recorded the maximum PAPR level associated with a probability of 0.1 %.
5. Record the deviation as Peak to Average Ratio.



3.6 Occupied Bandwidth

3.6.1 Description of Occupied Bandwidth Measurement

The occupied bandwidth is the width of a frequency band such that, below the lower and above the upper frequency limits, the mean powers emitted are each equal to a specified percentage 0.5% of the total mean transmitted power.

The 26 dB emission bandwidth is defined as the frequency range between two points, one above and one below the carrier frequency, at which the spectral density of the emission is attenuated 26 dB below the maximum in-band spectral density of the modulated signal. Spectral density (power per unit bandwidth) is to be measured with a detector of resolution bandwidth equal to approximately 1.0% of the emission bandwidth.

3.6.2 Test Procedures

1. The testing follows FCC KDB 971168 v02r02 Section 4.2.
2. The EUT was connected to spectrum analyzer and system simulator via a power divider.
3. The spectrum analyzer center frequency is set to the nominal EUT channel center frequency. The span range for the spectrum analyzer shall be between two and five times the anticipated OBW.
4. The nominal resolution bandwidth (RBW) shall be in the range of 1 to 5 % of the anticipated OBW, and the VBW shall be at least 3 times the RBW.
5. Set the detection mode to peak, and the trace mode to max hold.
6. Determine the reference value: Set the EUT to transmit a modulated signal. Allow the trace to stabilize. Set the spectrum analyzer marker to the highest level of the displayed trace.
(this is the reference value)
7. Determine the “-26 dB down amplitude” as equal to (Reference Value – X).
8. Place two markers, one at the lowest and the other at the highest frequency of the envelope of the spectral display such that each marker is at or slightly below the “-X dB down amplitude” determined in step 6. If a marker is below this “-X dB down amplitude” value it shall be placed as close as possible to this value. The OBW is the positive frequency difference between the two markers.
9. Use the 99 % power bandwidth function of the spectrum analyzer and report the measured bandwidth.



3.7 Conducted Band Edge

3.7.1 Description of Conducted Band Edge Measurement

22.917(a) for Band 5

For operations in the 824 – 849 MHz band, the FCC limit is $43 + 10\log_{10}(P[\text{Watts}])$ dB below the transmitter power $P(\text{Watts})$ in a 100kHz bandwidth. However, in the 1MHz bands immediately outside and adjacent to the licensee's frequency block, a resolution bandwidth of at least one percent of the emission bandwidth of the fundamental emission of the transmitter may be employed.

24.238 (a) for Band 2

For operations in the 1850-1910 and 1930-1990 MHz band, the FCC limit is $43 + 10\log_{10}(P[\text{Watts}])$ dB below the transmitter power $P(\text{Watts})$ in a 1MHz bandwidth. However, in the 1 MHz bands immediately outside and adjacent to the frequency block a resolution bandwidth of at least one percent of the emission bandwidth of the fundamental emission of the transmitter may be employed.

27.53 (g) for Band 12

For operations in the 698 -746 MHz band, the FCC limit is $43 + 10\log_{10}(P[\text{Watts}])$ dB below the transmitter power $P(\text{Watts})$ in a 100 kHz bandwidth. However, in the 100 kilohertz bands immediately outside and adjacent to a licensee's frequency block, a resolution bandwidth of at least 30 kHz may be employed.

27.53 (h) for Band 4

For operations in the 1710 – 1755 MHz band, the FCC limit is $43 + 10\log_{10}(P[\text{Watts}])$ dB below the transmitter power $P(\text{Watts})$ in a 1 MHz bandwidth. However, in the 1MHz bands immediately outside and adjacent to the licensee's frequency block, a resolution bandwidth of at least one percent of the emission bandwidth of the fundamental emission of the transmitter may be employed.



3.7.2 Test Procedures

1. The testing follows FCC KDB 971168 v02r02 Section 6.0.
2. The EUT was connected to spectrum analyzer and system simulator via a power divider.
3. The band edges of low and high channels for the highest RF powers were measured.
4. Set RBW \geq 1% EBW in the 1MHz band immediately outside and adjacent to the band edge.
5. Beyond the 1 MHz band from the band edge, RBW=1MHz was used
6. Set spectrum analyzer with RMS detector.
7. The RF fundamental frequency should be excluded against the limit line in the operating frequency band.
8. Checked that all the results comply with the emission limit line.

Example:

The limit line is derived from $43 + 10\log(P)$ dB below the transmitter power P(Watts)
= P(W)- [43 + 10log(P)] (dB)
= [30 + 10log(P)] (dBm) - [43 + 10log(P)] (dB)
= -13dBm.



3.8 Conducted Spurious Emission

3.8.1 Description of Conducted Spurious Emission Measurement

The power of any emission outside of the authorized operating frequency ranges must be lower than the transmitter power (P) by a factor of at least $43 + 10 \log (P)$ dB.

It is measured by means of a calibrated spectrum analyzer and scanned from 30 MHz up to a frequency including its 10th harmonic.

3.8.2 Test Procedures

1. The testing follows FCC KDB 971168 v02r02 Section 6.0.
2. The EUT was connected to spectrum analyzer and system simulator via a power divider.
3. The RF output of EUT was connected to the spectrum analyzer by RF cable and attenuator. The path loss was compensated to the results for each measurement.
4. The middle channel for the highest RF power within the transmitting frequency was measured.
5. The conducted spurious emission for the whole frequency range was taken.
6. Make the measurement with the spectrum analyzer's RBW = 1MHz, VBW = 3MHz.
7. Set spectrum analyzer with RMS detector.
8. Taking the record of maximum spurious emission.
9. The RF fundamental frequency should be excluded against the limit line in the operating frequency band.
10. The limit line is derived from $43 + 10\log(P)$ dB below the transmitter power P(Watts)
= P(W)- [43 + 10log(P)] (dB)
= [30 + 10log(P)] (dBm) - [43 + 10log(P)] (dB)
= -13dBm.



3.9 Frequency Stability

3.9.1 Description of Frequency Stability Measurement

The frequency stability shall be measured by variation of ambient temperature and variation of primary supply voltage to ensure that the fundamental emission stays within the authorized frequency block. The frequency stability of the transmitter shall be maintained within $\pm 0.00025\%$ ($\pm 2.5\text{ppm}$) of the center frequency.

3.9.2 Test Procedures for Temperature Variation

1. The testing follows FCC KDB 971168 v02r02 Section 9.0.
2. The EUT was set up in the thermal chamber and connected with the system simulator.
3. With power OFF, the temperature was decreased to -30°C and the EUT was stabilized before testing. Power was applied and the maximum change in frequency was recorded within one minute.
4. With power OFF, the temperature was raised in 10°C step up to 50°C . The EUT was stabilized at each step for at least half an hour. Power was applied and the maximum frequency change was recorded within one minute.

3.9.3 Test Procedures for Voltage Variation

1. The testing follows FCC KDB 971168 v02r02 Section 9.0.
2. The EUT was placed in a temperature chamber at $25\pm 5^{\circ}\text{C}$ and connected with the system simulator.
3. The power supply voltage to the EUT was varied from 85% to 115% of the nominal value measured at the input to the EUT.
4. The variation in frequency was measured for the worst case.

4 Radiated Test Items

4.1 Measuring Instruments

See list of measuring instruments of this test report.

4.2 Test Setup

4.2.1 For radiated test from 30MHz to 1GHz

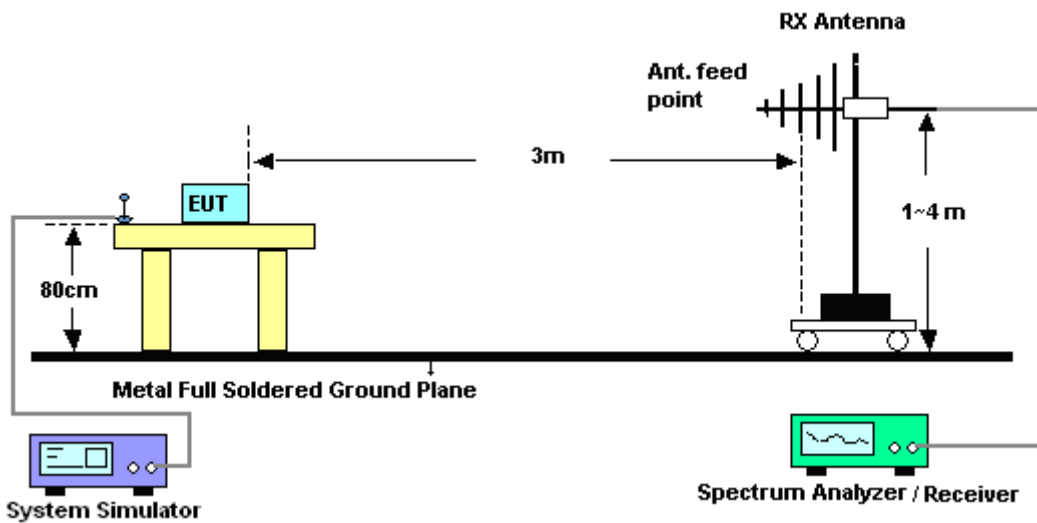

4.2.2 For radiated test above 1GHz

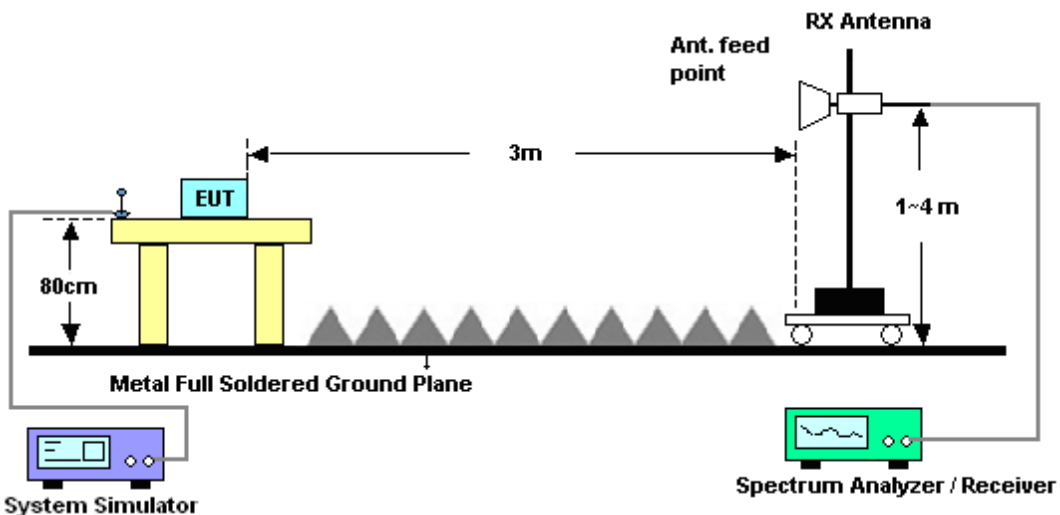

4.3 Test Result of Radiated Test

Please refer to Appendix B.



4.4 Radiated Spurious Emission

4.4.1 Description of Radiated Spurious Emission

The radiated spurious emission was measured by substitution method according to ANSI / TIA / EIA-603-D-2010. The power of any emission outside of the authorized operating frequency ranges must be attenuated below the transmitter power (P) by a factor of at least $43 + 10 \log (P)$ dB.

For LTE Band 12

For operations in the 746-758 MHz, 775-788 MHz, and 805-806 MHz bands, emissions in the band 1559-1610 MHz shall be limited to -70 dBW/MHz equivalent isotropically radiated power (EIRP) for wideband signals, and -80 dBW EIRP for discrete emissions of less than 700 Hz bandwidth.

The spectrum is scanned from 30 MHz up to a frequency including its 10th harmonic.

4.4.2 Test Procedures

1. The testing follows FCC KDB 971168 v02r02 Section 5.8 and ANSI / TIA-603-D-2010 Section 2.2.12.
2. The EUT was placed on a rotatable wooden table with 0.8 meter above ground.
3. The EUT was set 3 meters from the receiving antenna, which was mounted on the antenna tower.
4. The table was rotated 360 degrees to determine the position of the highest spurious emission.
5. The height of the receiving antenna is varied between one meter and four meters to search the maximum spurious emission for both horizontal and vertical polarizations.
6. Make the measurement with the spectrum analyzer's RBW = 1MHz, VBW = 3MHz, taking the record of maximum spurious emission.
7. A horn antenna was substituted in place of the EUT and was driven by a signal generator.
8. Tune the output power of signal generator to the same emission level with EUT maximum spurious emission.
9. Taking the record of output power at antenna port.
10. Repeat step 7 to step 8 for another polarization.
11. The RF fundamental frequency should be excluded against the limit line in the operating frequency band.

The limit line is derived from $43 + 10\log(P)$ dB below the transmitter power P(Watts)
 $= P(W) - [43 + 10\log(P)]$ (dB)
 $= [30 + 10\log(P)]$ (dBm) - $[43 + 10\log(P)]$ (dB)
 $= -13$ dBm.

12. EIRP (dBm) = S.G. Power – Tx Cable Loss + Tx Antenna Gain
13. ERP (dBm) = EIRP - 2.15



5 List of Measuring Equipment

| Instrument | Manufacturer | Model No. | Serial No. | Characteristics | Calibration Date | Test Date | Due Date | Remark |
|---------------------------|--------------|--------------------------|--------------|---------------------------|------------------|---------------------------------|---------------|--------------------------|
| Spectrum Analyzer | R&S | FSV40 | 101040 | 10Hz~40GHz | Sep. 10, 2015 | Mar. 18, 2016~ Mar. 19, 2016 | Sep. 09, 2016 | Conducted (TH01-KS) |
| Thermal Chamber | Ten Billion | TTC-B3S | TBN-960502 | -40~+150°C | Oct. 24, 2015 | Mar. 18, 2016~ Mar. 19, 2016 | Oct. 23, 2016 | Conducted (TH01-KS) |
| EMI Test Receiver | R&S | ESR7 | 101403 | 9kHz~7GHz; Max 30dBm | Sep. 10, 2015 | Apr. 04, 2016~ Apr. 12, 2016 | Sep. 09, 2016 | Radiation (03CH02-KS) |
| Spectrum Analyzer | R&S | FSV40 | 101040 | 10kHz~40GHz;Ma x 30dBm | Sep. 10, 2015 | Apr. 04, 2016~ Apr. 12, 2016 | Sep. 09, 2016 | Radiation (03CH02-KS) |
| Bilog Antenna | TeseQ | CBL6112D | 23182 | 25MHz-2GHz | Mar. 12, 2016 | Apr. 04, 2016~ Apr. 12, 2016 | Mar. 11, 2017 | Radiation (03CH02-KS) |
| Double Ridge Horn Antenna | ETS-Lindgren | 3117 | 75957 | 1GHz~18GHz | Nov. 07, 2015 | Apr. 04, 2016~ Apr. 12, 2016 | Nov. 06, 2016 | Radiation (03CH02-KS) |
| high gain Amplifier | MITEQ | AMF-7D-00 101800-30-1 | 1865802 | 1GHz~18GHz | Jan. 20, 2016 | Apr. 04, 2016~ Apr. 12, 2016 | Jan. 19, 2017 | Radiation (03CH02-KS) |
| SHF-EHF Horn | com-power | AH-840 | 101070 | 18GHz~40Ghz | Oct. 10, 2015 | Apr. 04, 2016~ Apr. 12, 2016 | Oct. 09, 2016 | Radiation (03CH02-KS) |
| Amplifier | com-power | PA-103A | 161069 | 1kHz~1000MHz / 32 dB | May 04, 2015 | Apr. 04, 2016~ Apr. 12, 2016 | May 03, 2016 | Radiation (03CH02-KS) |
| Amplifier | Agilent | 8449B | 3008A02384 | 1-26.5GHz Gain 30dB | Oct. 24, 2015 | Apr. 04, 2016~ Apr. 12, 2016 | Oct. 23, 2016 | Radiation (03CH02-KS) |
| Amplifier | MITEQ | TTA1840-35 -HG | 1887435 | 18GHz~40GHz | Aug. 27, 2015 | Apr. 04, 2016~ Apr. 12, 2016 | Aug. 26, 2016 | Radiation (03CH02-KS) |
| AC Power Source | Chroma | 61601 | 616010002473 | N/A | NCR | Apr. 04, 2016~ Apr. 12, 2016 | NCR | Radiation (03CH02-KS) |
| Turn Table | MF | MF7802 | N/A | 0~360 degree | NCR | Apr. 04, 2016~ Apr. 12, 2016 | NCR | Radiation (03CH02-KS) |
| Antenna Mast | MF | MF7802 | N/A | 1 m~4 m | NCR | Apr. 04, 2016~ Apr. 12, 2016 | NCR | Radiation (03CH02-KS) |



6 Uncertainty of Evaluation

Uncertainty of Radiated Emission Measurement (30 MHz ~ 1000 MHz)

| | |
|---|--------|
| Measuring Uncertainty for a Level of Confidence of 95% ($U = 2Uc(y)$) | 5.1 dB |
|---|--------|



Appendix A. Test Results of Conducted Test

Conducted Output Power(Average power)



| LTE Band 2 Maximum Average Power [dBm] | | | | | | |
|--|---------|-----------|--------|--------|--------|---------|
| BW [MHz] | RB Size | RB Offset | Mod | Lowest | Middle | Highest |
| 20 | 1 | 0 | QPSK | 22.25 | 22.28 | 22.30 |
| 20 | 1 | 49 | | 23.07 | 22.74 | 22.65 |
| 20 | 1 | 99 | | 22.27 | 22.58 | 22.24 |
| 20 | 50 | 0 | | 21.79 | 21.78 | 21.68 |
| 20 | 50 | 24 | | 21.65 | 21.65 | 21.67 |
| 20 | 50 | 50 | | 21.44 | 21.73 | 21.51 |
| 20 | 100 | 0 | | 21.69 | 21.59 | 21.67 |
| 20 | 1 | 0 | 16-QAM | 21.37 | 21.40 | 21.24 |
| 20 | 1 | 49 | | 21.35 | 21.50 | 21.43 |
| 20 | 1 | 99 | | 21.12 | 21.33 | 21.23 |
| 20 | 50 | 0 | | 20.63 | 20.75 | 20.71 |
| 20 | 50 | 24 | | 20.60 | 20.71 | 20.73 |
| 20 | 50 | 50 | | 20.58 | 20.69 | 20.47 |
| 20 | 100 | 0 | | 20.58 | 20.57 | 20.60 |
| 15 | 1 | 0 | QPSK | 22.32 | 22.42 | 22.32 |
| 15 | 1 | 37 | | 22.65 | 22.54 | 22.53 |
| 15 | 1 | 74 | | 22.32 | 22.58 | 22.35 |
| 15 | 36 | 0 | | 21.56 | 21.62 | 21.56 |
| 15 | 36 | 20 | | 21.65 | 21.62 | 21.57 |
| 15 | 36 | 39 | | 21.47 | 21.66 | 21.52 |
| 15 | 75 | 0 | | 21.49 | 21.64 | 21.53 |
| 15 | 1 | 0 | 16-QAM | 21.32 | 21.37 | 21.26 |
| 15 | 1 | 37 | | 21.39 | 21.47 | 21.24 |
| 15 | 1 | 74 | | 21.10 | 21.34 | 21.13 |
| 15 | 36 | 0 | | 20.63 | 20.58 | 20.54 |
| 15 | 36 | 20 | | 20.61 | 20.58 | 20.52 |
| 15 | 36 | 39 | | 20.42 | 20.69 | 20.50 |
| 15 | 75 | 0 | | 20.54 | 20.61 | 20.55 |



| LTE Band 2 Maximum Average Power [dBm] | | | | | | |
|--|---------|-----------|--------|--------|--------|---------|
| BW [MHz] | RB Size | RB Offset | Mod | Lowest | Middle | Highest |
| 10 | 1 | 0 | QPSK | 22.09 | 22.14 | 22.29 |
| 10 | 1 | 25 | | 22.64 | 22.82 | 22.74 |
| 10 | 1 | 49 | | 22.02 | 22.34 | 22.22 |
| 10 | 25 | 0 | | 21.48 | 21.56 | 21.51 |
| 10 | 25 | 12 | | 21.60 | 21.58 | 21.60 |
| 10 | 25 | 25 | | 21.35 | 21.52 | 21.49 |
| 10 | 50 | 0 | | 21.55 | 21.54 | 21.49 |
| 10 | 1 | 0 | 16-QAM | 21.17 | 21.23 | 21.23 |
| 10 | 1 | 25 | | 21.91 | 21.40 | 21.30 |
| 10 | 1 | 49 | | 21.11 | 21.30 | 21.11 |
| 10 | 25 | 0 | | 20.54 | 20.75 | 20.70 |
| 10 | 25 | 12 | | 20.58 | 20.79 | 20.79 |
| 10 | 25 | 25 | | 20.43 | 20.89 | 20.66 |
| 10 | 50 | 0 | | 20.53 | 20.52 | 20.37 |
| 5 | 1 | 0 | QPSK | 22.35 | 22.32 | 22.29 |
| 5 | 1 | 12 | | 22.36 | 22.49 | 22.52 |
| 5 | 1 | 24 | | 22.48 | 22.40 | 22.06 |
| 5 | 12 | 0 | | 21.44 | 21.47 | 21.52 |
| 5 | 12 | 7 | | 21.53 | 21.52 | 21.43 |
| 5 | 12 | 13 | | 21.47 | 21.48 | 21.47 |
| 5 | 25 | 0 | | 21.52 | 21.51 | 21.47 |
| 5 | 1 | 0 | 16-QAM | 21.17 | 21.17 | 21.63 |
| 5 | 1 | 12 | | 21.50 | 21.55 | 21.28 |
| 5 | 1 | 24 | | 21.13 | 21.24 | 21.24 |
| 5 | 12 | 0 | | 20.34 | 20.57 | 20.41 |
| 5 | 12 | 7 | | 20.56 | 20.62 | 20.40 |
| 5 | 12 | 13 | | 20.46 | 20.53 | 20.49 |
| 5 | 25 | 0 | | 20.60 | 20.60 | 20.56 |



| LTE Band 2 Maximum Average Power [dBm] | | | | | | |
|--|---------|-----------|--------|--------|--------|---------|
| BW [MHz] | RB Size | RB Offset | Mod | Lowest | Middle | Highest |
| 3 | 1 | 0 | QPSK | 22.63 | 22.36 | 22.40 |
| 3 | 1 | 8 | | 22.51 | 22.55 | 22.20 |
| 3 | 1 | 14 | | 22.47 | 22.51 | 22.16 |
| 3 | 8 | 0 | | 21.63 | 21.52 | 21.63 |
| 3 | 8 | 4 | | 21.63 | 21.51 | 21.44 |
| 3 | 8 | 7 | | 21.58 | 21.47 | 21.42 |
| 3 | 15 | 0 | | 21.54 | 21.59 | 21.43 |
| 3 | 1 | 0 | 16-QAM | 21.23 | 21.43 | 21.49 |
| 3 | 1 | 8 | | 21.12 | 21.89 | 21.26 |
| 3 | 1 | 14 | | 21.09 | 21.24 | 21.22 |
| 3 | 8 | 0 | | 20.41 | 20.56 | 20.46 |
| 3 | 8 | 4 | | 20.56 | 20.56 | 20.48 |
| 3 | 8 | 7 | | 20.54 | 20.51 | 20.47 |
| 3 | 15 | 0 | | 20.60 | 20.60 | 20.53 |
| 1.4 | 1 | 0 | QPSK | 22.60 | 22.57 | 22.55 |
| 1.4 | 1 | 3 | | 22.63 | 22.60 | 22.69 |
| 1.4 | 1 | 5 | | 22.58 | 22.51 | 22.55 |
| 1.4 | 3 | 0 | | 22.56 | 22.67 | 22.63 |
| 1.4 | 3 | 1 | | 22.71 | 22.79 | 22.73 |
| 1.4 | 3 | 3 | | 22.58 | 22.56 | 22.60 |
| 1.4 | 6 | 0 | | 21.56 | 21.52 | 21.59 |
| 1.4 | 1 | 0 | 16-QAM | 21.41 | 21.51 | 21.28 |
| 1.4 | 1 | 3 | | 21.74 | 22.10 | 21.58 |
| 1.4 | 1 | 5 | | 21.69 | 21.59 | 21.63 |
| 1.4 | 3 | 0 | | 21.75 | 21.67 | 21.55 |
| 1.4 | 3 | 1 | | 21.74 | 21.70 | 21.42 |
| 1.4 | 3 | 3 | | 21.74 | 21.58 | 21.41 |
| 1.4 | 6 | 0 | | 20.68 | 20.58 | 20.46 |



| LTE Band 4 Maximum Average Power [dBm] | | | | | | |
|--|---------|-----------|--------|--------|--------|---------|
| BW [MHz] | RB Size | RB Offset | Mod | Lowest | Middle | Highest |
| 20 | 1 | 0 | QPSK | 23.10 | 23.19 | 23.38 |
| 20 | 1 | 49 | | 23.76 | 23.77 | 23.55 |
| 20 | 1 | 99 | | 23.24 | 23.17 | 23.14 |
| 20 | 50 | 0 | | 22.57 | 22.62 | 22.61 |
| 20 | 50 | 24 | | 22.47 | 22.55 | 22.60 |
| 20 | 50 | 50 | | 22.55 | 22.49 | 22.54 |
| 20 | 100 | 0 | | 22.49 | 22.45 | 22.59 |
| 20 | 1 | 0 | 16-QAM | 22.14 | 22.28 | 22.46 |
| 20 | 1 | 49 | | 22.20 | 22.20 | 22.35 |
| 20 | 1 | 99 | | 22.17 | 22.16 | 22.09 |
| 20 | 50 | 0 | | 21.46 | 21.57 | 21.56 |
| 20 | 50 | 24 | | 21.54 | 21.43 | 21.55 |
| 20 | 50 | 50 | | 21.52 | 21.26 | 21.41 |
| 20 | 100 | 0 | | 21.41 | 21.30 | 21.52 |
| 15 | 1 | 0 | QPSK | 23.15 | 23.38 | 23.26 |
| 15 | 1 | 37 | | 23.72 | 23.63 | 23.67 |
| 15 | 1 | 74 | | 23.30 | 23.35 | 23.41 |
| 15 | 36 | 0 | | 22.45 | 22.55 | 22.55 |
| 15 | 36 | 20 | | 22.49 | 22.46 | 22.57 |
| 15 | 36 | 39 | | 22.48 | 22.52 | 22.55 |
| 15 | 75 | 0 | | 22.45 | 22.47 | 22.60 |
| 15 | 1 | 0 | 16-QAM | 22.08 | 22.31 | 22.39 |
| 15 | 1 | 37 | | 22.15 | 22.12 | 22.18 |
| 15 | 1 | 74 | | 22.12 | 22.14 | 22.13 |
| 15 | 36 | 0 | | 21.41 | 21.40 | 21.40 |
| 15 | 36 | 20 | | 21.36 | 21.42 | 21.55 |
| 15 | 36 | 39 | | 21.36 | 21.38 | 21.53 |
| 15 | 75 | 0 | | 21.42 | 21.53 | 21.55 |



| LTE Band 4 Maximum Average Power [dBm] | | | | | | |
|--|---------|-----------|--------|--------|--------|---------|
| BW [MHz] | RB Size | RB Offset | Mod | Lowest | Middle | Highest |
| 10 | 1 | 0 | QPSK | 23.03 | 23.31 | 23.08 |
| 10 | 1 | 25 | | 23.32 | 23.76 | 23.69 |
| 10 | 1 | 49 | | 23.07 | 23.17 | 23.21 |
| 10 | 25 | 0 | | 22.51 | 22.51 | 22.59 |
| 10 | 25 | 12 | | 22.48 | 22.46 | 22.57 |
| 10 | 25 | 25 | | 22.49 | 22.50 | 22.52 |
| 10 | 50 | 0 | | 22.49 | 22.48 | 22.50 |
| 10 | 1 | 0 | 16-QAM | 22.07 | 22.26 | 22.14 |
| 10 | 1 | 25 | | 22.23 | 22.16 | 22.20 |
| 10 | 1 | 49 | | 22.05 | 22.14 | 22.16 |
| 10 | 25 | 0 | | 21.69 | 21.70 | 21.55 |
| 10 | 25 | 12 | | 21.48 | 21.44 | 21.54 |
| 10 | 25 | 25 | | 21.36 | 21.37 | 21.40 |
| 10 | 50 | 0 | | 21.47 | 21.48 | 21.37 |
| 5 | 1 | 0 | QPSK | 23.16 | 23.27 | 23.26 |
| 5 | 1 | 12 | | 23.27 | 23.32 | 23.31 |
| 5 | 1 | 24 | | 23.23 | 23.18 | 23.22 |
| 5 | 12 | 0 | | 22.39 | 22.43 | 22.46 |
| 5 | 12 | 7 | | 22.42 | 22.43 | 22.46 |
| 5 | 12 | 13 | | 22.41 | 22.50 | 22.55 |
| 5 | 25 | 0 | | 22.40 | 22.43 | 22.45 |
| 5 | 1 | 0 | 16-QAM | 21.98 | 22.12 | 22.17 |
| 5 | 1 | 12 | | 22.15 | 22.15 | 22.26 |
| 5 | 1 | 24 | | 22.06 | 22.09 | 22.30 |
| 5 | 12 | 0 | | 21.13 | 21.40 | 21.35 |
| 5 | 12 | 7 | | 21.16 | 21.18 | 21.43 |
| 5 | 12 | 13 | | 21.36 | 21.58 | 21.44 |
| 5 | 25 | 0 | | 21.23 | 21.51 | 21.54 |



| LTE Band 4 Maximum Average Power [dBm] | | | | | | |
|--|---------|-----------|--------|--------|--------|---------|
| BW [MHz] | RB Size | RB Offset | Mod | Lowest | Middle | Highest |
| 3 | 1 | 0 | QPSK | 23.24 | 23.54 | 23.18 |
| 3 | 1 | 8 | | 23.27 | 23.13 | 23.10 |
| 3 | 1 | 14 | | 23.17 | 23.05 | 23.01 |
| 3 | 8 | 0 | | 22.19 | 22.48 | 22.40 |
| 3 | 8 | 4 | | 22.34 | 22.39 | 22.37 |
| 3 | 8 | 7 | | 22.36 | 22.41 | 22.40 |
| 3 | 15 | 0 | | 22.32 | 22.45 | 22.37 |
| 3 | 1 | 0 | 16-QAM | 22.10 | 22.23 | 22.16 |
| 3 | 1 | 8 | | 22.07 | 22.05 | 22.10 |
| 3 | 1 | 14 | | 22.24 | 22.05 | 22.07 |
| 3 | 8 | 0 | | 21.26 | 21.02 | 21.43 |
| 3 | 8 | 4 | | 21.30 | 21.23 | 21.40 |
| 3 | 8 | 7 | | 21.28 | 21.40 | 21.09 |
| 3 | 15 | 0 | | 21.06 | 21.52 | 21.13 |
| 1.4 | 1 | 0 | QPSK | 23.15 | 23.33 | 23.35 |
| 1.4 | 1 | 3 | | 23.13 | 23.33 | 23.35 |
| 1.4 | 1 | 5 | | 23.15 | 23.40 | 23.36 |
| 1.4 | 3 | 0 | | 23.29 | 23.47 | 23.43 |
| 1.4 | 3 | 1 | | 23.32 | 23.52 | 23.46 |
| 1.4 | 3 | 3 | | 23.25 | 23.53 | 23.62 |
| 1.4 | 6 | 0 | | 22.20 | 22.48 | 22.37 |
| 1.4 | 1 | 0 | 16-QAM | 22.12 | 22.19 | 22.21 |
| 1.4 | 1 | 3 | | 22.24 | 22.24 | 22.25 |
| 1.4 | 1 | 5 | | 22.11 | 22.23 | 22.15 |
| 1.4 | 3 | 0 | | 22.12 | 22.43 | 22.42 |
| 1.4 | 3 | 1 | | 22.26 | 22.49 | 22.44 |
| 1.4 | 3 | 3 | | 22.18 | 22.35 | 22.45 |
| 1.4 | 6 | 0 | | 21.11 | 21.20 | 21.24 |



| LTE Band 5 Maximum Average Power [dBm] | | | | | | |
|--|---------|-----------|--------|--------|--------|---------|
| BW [MHz] | RB Size | RB Offset | Mod | Lowest | Middle | Highest |
| 10 | 1 | 0 | QPSK | 22.86 | 23.03 | 22.90 |
| 10 | 1 | 25 | | 23.33 | 23.43 | 23.24 |
| 10 | 1 | 49 | | 22.94 | 23.07 | 22.86 |
| 10 | 25 | 0 | | 22.22 | 22.31 | 22.26 |
| 10 | 25 | 12 | | 22.17 | 22.20 | 22.26 |
| 10 | 25 | 25 | | 22.28 | 22.35 | 22.34 |
| 10 | 50 | 0 | | 22.25 | 22.38 | 22.26 |
| 10 | 1 | 0 | 16-QAM | 21.99 | 21.79 | 22.03 |
| 10 | 1 | 25 | | 21.96 | 22.09 | 21.99 |
| 10 | 1 | 49 | | 21.92 | 21.86 | 21.78 |
| 10 | 25 | 0 | | 21.22 | 21.35 | 21.11 |
| 10 | 25 | 12 | | 21.44 | 21.04 | 20.99 |
| 10 | 25 | 25 | | 21.06 | 21.15 | 21.28 |
| 10 | 50 | 0 | | 21.21 | 21.18 | 21.32 |
| 5 | 1 | 0 | QPSK | 23.07 | 22.74 | 23.12 |
| 5 | 1 | 12 | | 23.27 | 23.24 | 23.25 |
| 5 | 1 | 24 | | 22.78 | 22.93 | 22.78 |
| 5 | 12 | 0 | | 22.24 | 22.05 | 22.29 |
| 5 | 12 | 7 | | 22.19 | 22.09 | 22.28 |
| 5 | 12 | 13 | | 22.20 | 22.19 | 22.20 |
| 5 | 25 | 0 | | 22.20 | 22.19 | 22.31 |
| 5 | 1 | 0 | 16-QAM | 21.93 | 21.87 | 22.04 |
| 5 | 1 | 12 | | 21.90 | 21.68 | 21.94 |
| 5 | 1 | 24 | | 21.72 | 21.86 | 21.84 |
| 5 | 12 | 0 | | 21.02 | 21.03 | 21.35 |
| 5 | 12 | 7 | | 20.95 | 21.04 | 21.40 |
| 5 | 12 | 13 | | 21.04 | 21.14 | 21.01 |
| 5 | 25 | 0 | | 20.99 | 21.14 | 21.25 |



| LTE Band 5 Maximum Average Power [dBm] | | | | | | |
|--|---------|-----------|--------|--------|--------|---------|
| BW [MHz] | RB Size | RB Offset | Mod | Lowest | Middle | Highest |
| 3 | 1 | 0 | QPSK | 22.97 | 23.05 | 23.21 |
| 3 | 1 | 8 | | 23.07 | 22.94 | 22.99 |
| 3 | 1 | 14 | | 23.11 | 22.95 | 23.19 |
| 3 | 8 | 0 | | 22.31 | 22.07 | 22.40 |
| 3 | 8 | 4 | | 22.32 | 22.18 | 22.32 |
| 3 | 8 | 7 | | 22.26 | 22.24 | 22.23 |
| 3 | 15 | 0 | | 22.25 | 22.17 | 22.26 |
| 3 | 1 | 0 | 16-QAM | 22.07 | 21.58 | 22.14 |
| 3 | 1 | 8 | | 22.00 | 21.86 | 22.53 |
| 3 | 1 | 14 | | 21.93 | 21.98 | 22.30 |
| 3 | 8 | 0 | | 21.22 | 21.06 | 21.29 |
| 3 | 8 | 4 | | 21.21 | 21.15 | 21.22 |
| 3 | 8 | 7 | | 21.33 | 21.14 | 21.25 |
| 3 | 15 | 0 | | 21.05 | 21.02 | 21.11 |
| 1.4 | 1 | 0 | QPSK | 22.94 | 23.05 | 23.09 |
| 1.4 | 1 | 3 | | 23.26 | 23.17 | 23.05 |
| 1.4 | 1 | 5 | | 23.21 | 23.17 | 23.00 |
| 1.4 | 3 | 0 | | 23.27 | 23.17 | 23.18 |
| 1.4 | 3 | 1 | | 23.30 | 23.23 | 23.30 |
| 1.4 | 3 | 3 | | 23.19 | 23.25 | 23.32 |
| 1.4 | 6 | 0 | | 22.34 | 22.15 | 22.19 |
| 1.4 | 1 | 0 | 16-QAM | 22.35 | 21.87 | 21.94 |
| 1.4 | 1 | 3 | | 22.51 | 22.02 | 22.03 |
| 1.4 | 1 | 5 | | 22.26 | 21.90 | 21.88 |
| 1.4 | 3 | 0 | | 22.27 | 22.33 | 22.15 |
| 1.4 | 3 | 1 | | 22.38 | 22.31 | 22.27 |
| 1.4 | 3 | 3 | | 22.20 | 22.20 | 22.12 |
| 1.4 | 6 | 0 | | 21.02 | 21.05 | 21.21 |



| LTE Band 12 Maximum Average Power [dBm] | | | | | | |
|---|---------|-----------|--------|--------|--------|---------|
| BW [MHz] | RB Size | RB Offset | Mod | Lowest | Middle | Highest |
| 10 | 1 | 0 | QPSK | 22.88 | 23.00 | 22.97 |
| 10 | 1 | 25 | | 23.22 | 23.50 | 23.42 |
| 10 | 1 | 49 | | 23.02 | 23.00 | 22.89 |
| 10 | 25 | 0 | | 22.37 | 22.39 | 22.38 |
| 10 | 25 | 12 | | 22.22 | 22.34 | 22.29 |
| 10 | 25 | 25 | | 22.24 | 22.34 | 22.34 |
| 10 | 50 | 0 | | 22.30 | 22.38 | 22.31 |
| 10 | 1 | 0 | 16-QAM | 21.91 | 22.01 | 22.04 |
| 10 | 1 | 25 | | 22.16 | 22.19 | 22.12 |
| 10 | 1 | 49 | | 21.99 | 22.04 | 21.90 |
| 10 | 25 | 0 | | 21.44 | 21.58 | 21.43 |
| 10 | 25 | 12 | | 21.37 | 21.35 | 21.38 |
| 10 | 25 | 25 | | 21.31 | 21.31 | 21.27 |
| 10 | 50 | 0 | | 21.18 | 21.37 | 21.36 |
| 5 | 1 | 0 | QPSK | 23.14 | 23.12 | 22.96 |
| 5 | 1 | 12 | | 23.31 | 23.39 | 23.15 |
| 5 | 1 | 24 | | 23.06 | 23.11 | 22.87 |
| 5 | 12 | 0 | | 22.35 | 22.32 | 22.27 |
| 5 | 12 | 7 | | 22.37 | 22.45 | 22.26 |
| 5 | 12 | 13 | | 22.24 | 22.36 | 22.16 |
| 5 | 25 | 0 | | 22.30 | 22.24 | 22.14 |
| 5 | 1 | 0 | 16-QAM | 21.89 | 22.16 | 22.05 |
| 5 | 1 | 12 | | 22.15 | 22.06 | 21.78 |
| 5 | 1 | 24 | | 22.08 | 22.02 | 21.93 |
| 5 | 12 | 0 | | 21.32 | 21.25 | 21.19 |
| 5 | 12 | 7 | | 21.13 | 21.21 | 21.13 |
| 5 | 12 | 13 | | 20.99 | 21.36 | 21.14 |
| 5 | 25 | 0 | | 21.35 | 21.29 | 21.20 |



| LTE Band 12 Maximum Average Power [dBm] | | | | | | |
|---|---------|-----------|--------|--------|--------|---------|
| BW [MHz] | RB Size | RB Offset | Mod | Lowest | Middle | Highest |
| 3 | 1 | 0 | QPSK | 23.25 | 23.22 | 23.03 |
| 3 | 1 | 8 | | 23.38 | 23.25 | 23.05 |
| 3 | 1 | 14 | | 23.16 | 23.26 | 23.03 |
| 3 | 8 | 0 | | 22.36 | 22.33 | 22.28 |
| 3 | 8 | 4 | | 22.40 | 22.40 | 22.28 |
| 3 | 8 | 7 | | 22.42 | 22.35 | 22.21 |
| 3 | 15 | 0 | | 22.36 | 22.22 | 22.20 |
| 3 | 1 | 0 | 16-QAM | 22.19 | 22.12 | 22.08 |
| 3 | 1 | 8 | | 22.03 | 22.11 | 21.95 |
| 3 | 1 | 14 | | 22.18 | 22.13 | 22.09 |
| 3 | 8 | 0 | | 21.39 | 21.33 | 21.28 |
| 3 | 8 | 4 | | 21.32 | 21.36 | 21.19 |
| 3 | 8 | 7 | | 21.52 | 21.49 | 21.22 |
| 3 | 15 | 0 | | 21.54 | 21.32 | 21.09 |
| 1.4 | 1 | 0 | QPSK | 23.12 | 23.17 | 23.14 |
| 1.4 | 1 | 3 | | 23.41 | 23.33 | 23.19 |
| 1.4 | 1 | 5 | | 23.33 | 23.29 | 23.13 |
| 1.4 | 3 | 0 | | 23.29 | 23.30 | 23.13 |
| 1.4 | 3 | 1 | | 23.36 | 23.29 | 23.23 |
| 1.4 | 3 | 3 | | 23.44 | 23.34 | 23.30 |
| 1.4 | 6 | 0 | | 22.35 | 22.43 | 22.25 |
| 1.4 | 1 | 0 | 16-QAM | 22.21 | 22.40 | 22.14 |
| 1.4 | 1 | 3 | | 22.59 | 22.32 | 22.17 |
| 1.4 | 1 | 5 | | 22.32 | 22.18 | 22.08 |
| 1.4 | 3 | 0 | | 22.38 | 22.50 | 22.22 |
| 1.4 | 3 | 1 | | 22.31 | 22.60 | 22.34 |
| 1.4 | 3 | 3 | | 22.53 | 22.55 | 22.20 |
| 1.4 | 6 | 0 | | 21.32 | 21.32 | 21.09 |



ERP/EIRP

| LTE Band 2 QPSK (GT - LC =8.5 dB) | | | | | | | | | |
|-----------------------------------|-------------|--------|--------|-----------|--------|--------|------------|--------|--------|
| Bandwidth | 1.4M(3RB-1) | | | 3M(1RB-0) | | | 5M(1RB-12) | | |
| Channel | 18607 | 18900 | 19193 | 18615 | 18900 | 19185 | 18625 | 18900 | 19175 |
| | (Low) | (Mid) | (High) | (Low) | (Mid) | (High) | (Low) | (Mid) | (High) |
| Frequency | 1850.7 | 1880 | 1909.3 | 1851.5 | 1880 | 1908.5 | 1852.5 | 1880 | 1907.5 |
| (MHz) | | | | | | | | | |
| Conducted Power (dBm) | 22.71 | 22.79 | 22.73 | 22.63 | 22.36 | 22.40 | 22.36 | 22.49 | 22.52 |
| Conducted Power (Watts) | 0.1866 | 0.1901 | 0.1875 | 0.1832 | 0.1722 | 0.1738 | 0.1722 | 0.1774 | 0.1786 |
| EIRP(dBm) | 31.21 | 31.29 | 31.23 | 31.13 | 30.86 | 30.90 | 30.86 | 30.99 | 31.02 |
| EIRP(Watts) | 1.3213 | 1.3459 | 1.3274 | 1.2972 | 1.2190 | 1.2303 | 1.2190 | 1.2560 | 1.2647 |

| LTE Band 2 QPSK (GT - LC =8.5 dB) | | | | | | | | | |
|-----------------------------------|-------------|--------|--------|-------------|--------|--------|-------------|--------|--------|
| Bandwidth | 10M(1RB-25) | | | 15M(1RB-37) | | | 20M(1RB-49) | | |
| Channel | 18650 | 18900 | 19150 | 18675 | 18900 | 19125 | 18700 | 18900 | 19100 |
| | (Low) | (Mid) | (High) | (Low) | (Mid) | (High) | (Low) | (Mid) | (High) |
| Frequency | 1855 | 1880 | 1905 | 1857.5 | 1880 | 1902.5 | 1860 | 1880 | 1900 |
| (MHz) | | | | | | | | | |
| Conducted Power (dBm) | 22.64 | 22.82 | 22.74 | 22.65 | 22.54 | 22.53 | 23.07 | 22.74 | 22.65 |
| Conducted Power (Watts) | 0.1837 | 0.1914 | 0.1879 | 0.1841 | 0.1795 | 0.1791 | 0.2028 | 0.1879 | 0.1841 |
| EIRP(dBm) | 31.14 | 31.32 | 31.24 | 31.15 | 31.04 | 31.03 | 31.57 | 31.24 | 31.15 |
| EIRP(Watts) | 1.3002 | 1.3552 | 1.3305 | 1.3032 | 1.2706 | 1.2677 | 1.4355 | 1.3305 | 1.3032 |



| LTE Band 2 16QAM (GT - LC =8.5 dB) | | | | | | | | | |
|------------------------------------|-------------|--------|--------|-----------|--------|--------|-----------|--------|--------|
| Bandwidth | 1.4M(1RB-3) | | | 3M(1RB-8) | | | 5M(1RB-0) | | |
| Channel | 18607 | 18900 | 19193 | 18615 | 18900 | 19185 | 18625 | 18900 | 19175 |
| | (Low) | (Mid) | (High) | (Low) | (Mid) | (High) | (Low) | (Mid) | (High) |
| Frequency | 1850.7 | 1880 | 1909.3 | 1851.5 | 1880 | 1908.5 | 1852.5 | 1880 | 1907.5 |
| (MHz) | | | | | | | | | |
| Conducted Power (dBm) | 21.74 | 22.10 | 21.58 | 21.12 | 21.89 | 21.26 | 21.17 | 21.17 | 21.63 |
| Conducted Power (Watts) | 0.1493 | 0.1622 | 0.1439 | 0.1294 | 0.1545 | 0.1337 | 0.1309 | 0.1309 | 0.1455 |
| EIRP(dBm) | 30.24 | 30.60 | 30.08 | 29.62 | 30.39 | 29.76 | 29.67 | 29.67 | 30.13 |
| EIRP(Watts) | 1.0568 | 1.1482 | 1.0186 | 0.9162 | 1.0940 | 0.9462 | 0.9268 | 0.9268 | 1.0304 |

| LTE Band 2 16QAM (GT - LC =8.5 dB) | | | | | | | | | |
|------------------------------------|-------------|--------|--------|-------------|--------|--------|-------------|--------|--------|
| Bandwidth | 10M(1RB-25) | | | 15M(1RB-37) | | | 20M(1RB-49) | | |
| Channel | 18650 | 18900 | 19150 | 18675 | 18900 | 19125 | 18650 | 18900 | 19100 |
| | (Low) | (Mid) | (High) | (Low) | (Mid) | (High) | (Low) | (Mid) | (High) |
| Frequency | 1855 | 1880 | 1905 | 1857.5 | 1880 | 1902.5 | 1860 | 1880 | 1900 |
| (MHz) | | | | | | | | | |
| Conducted Power (dBm) | 21.91 | 21.40 | 21.30 | 21.39 | 21.47 | 21.24 | 21.35 | 21.50 | 21.43 |
| Conducted Power (Watts) | 0.1552 | 0.1380 | 0.1349 | 0.1377 | 0.1403 | 0.1330 | 0.1365 | 0.1413 | 0.1390 |
| EIRP(dBm) | 30.41 | 29.9 | 29.8 | 29.89 | 29.97 | 29.74 | 29.85 | 30 | 29.93 |
| EIRP(Watts) | 1.0990 | 0.9772 | 0.9550 | 0.9750 | 0.9931 | 0.9419 | 0.9661 | 1.0000 | 0.9840 |



| LTE Band 4 QPSK (GT - LC =6 dB) | | | | | | | | | |
|---------------------------------|-------------|--------|--------|-----------|--------|--------|------------|--------|--------|
| Bandwidth | 1.4M(3RB-3) | | | 3M(1RB-0) | | | 5M(1RB-12) | | |
| Channel | 19957 | 20175 | 20393 | 19965 | 20175 | 20385 | 19975 | 20175 | 20375 |
| | (Low) | (Mid) | (High) | (Low) | (Mid) | (High) | (Low) | (Mid) | (High) |
| Frequency | 1710.7 | 1732.5 | 1754.3 | 1711.5 | 1732.5 | 1753.5 | 1712.5 | 1732.5 | 1752.5 |
| (MHz) | | | | | | | | | |
| Conducted Power (dBm) | 23.25 | 23.53 | 23.62 | 23.24 | 23.54 | 23.18 | 23.27 | 23.32 | 23.31 |
| Conducted Power (Watts) | 0.2113 | 0.2254 | 0.2301 | 0.2109 | 0.2259 | 0.2080 | 0.2123 | 0.2148 | 0.2143 |
| EIRP(dBm) | 29.25 | 29.53 | 29.62 | 29.24 | 29.54 | 29.18 | 29.27 | 29.32 | 29.31 |
| EIRP(Watts) | 0.8414 | 0.8974 | 0.9162 | 0.8395 | 0.8995 | 0.8279 | 0.8453 | 0.8551 | 0.8531 |

| LTE Band 4 QPSK (GT - LC =6 dB) | | | | | | | | | |
|---------------------------------|-------------|--------|--------|-------------|--------|--------|-------------|--------|--------|
| Bandwidth | 10M(1RB-25) | | | 15M(1RB-37) | | | 20M(1RB-49) | | |
| Channel | 20000 | 20175 | 20350 | 20025 | 20175 | 20325 | 20050 | 20175 | 20300 |
| | (Low) | (Mid) | (High) | (Low) | (Mid) | (High) | (Low) | (Mid) | (High) |
| Frequency | 1715 | 1732.5 | 1750 | 1717.5 | 1732.5 | 1747.5 | 1720 | 1732.5 | 1745 |
| (MHz) | | | | | | | | | |
| Conducted Power (dBm) | 23.32 | 23.76 | 23.69 | 23.72 | 23.63 | 23.67 | 23.76 | 23.77 | 23.55 |
| Conducted Power (Watts) | 0.2148 | 0.2377 | 0.2339 | 0.2355 | 0.2307 | 0.2328 | 0.2377 | 0.2382 | 0.2265 |
| EIRP(dBm) | 29.32 | 29.76 | 29.69 | 29.72 | 29.63 | 29.67 | 29.76 | 29.77 | 29.55 |
| EIRP(Watts) | 0.8551 | 0.9462 | 0.9311 | 0.9376 | 0.9183 | 0.9268 | 0.9462 | 0.9484 | 0.9016 |



| LTE Band 4 16QAM (GT - LC =6 dB) | | | | | | | | | |
|----------------------------------|-------------|--------|--------|------------|--------|--------|------------|--------|--------|
| Bandwidth | 1.4M(3RB-1) | | | 3M(1RB-14) | | | 5M(1RB-24) | | |
| Channel | 19957 | 20175 | 20393 | 19965 | 20175 | 20385 | 19975 | 20175 | 20375 |
| | (Low) | (Mid) | (High) | (Low) | (Mid) | (High) | (Low) | (Mid) | (High) |
| Frequency | 1710.7 | 1732.5 | 1754.3 | 1711.5 | 1732.5 | 1753.5 | 1712.5 | 1732.5 | 1752.5 |
| (MHz) | | | | | | | | | |
| Conducted Power (dBm) | 22.26 | 22.49 | 22.44 | 22.24 | 22.05 | 22.07 | 22.06 | 22.09 | 22.30 |
| Conducted Power (Watts) | 0.1683 | 0.1774 | 0.1754 | 0.1675 | 0.1603 | 0.1611 | 0.1607 | 0.1618 | 0.1698 |
| EIRP(dBm) | 28.26 | 28.49 | 28.44 | 28.24 | 28.05 | 28.07 | 28.06 | 28.09 | 28.30 |
| EIRP(Watts) | 0.6699 | 0.7063 | 0.6982 | 0.6668 | 0.6383 | 0.6412 | 0.6397 | 0.6442 | 0.6761 |

| LTE Band 4 16QAM (GT - LC =6 dB) | | | | | | | | | |
|----------------------------------|------------|--------|--------|------------|--------|--------|------------|--------|--------|
| Bandwidth | 10M(1RB-0) | | | 15M(1RB-0) | | | 20M(1RB-0) | | |
| Channel | 20000 | 20175 | 20350 | 20025 | 20175 | 20325 | 20050 | 20175 | 20300 |
| | (Low) | (Mid) | (High) | (Low) | (Mid) | (High) | (Low) | (Mid) | (High) |
| Frequency | 1715 | 1732.5 | 1750 | 1717.5 | 1732.5 | 1747.5 | 1720 | 1732.5 | 1745 |
| (MHz) | | | | | | | | | |
| Conducted Power (dBm) | 22.07 | 22.26 | 22.14 | 22.08 | 22.31 | 22.39 | 22.14 | 22.28 | 22.46 |
| Conducted Power (Watts) | 0.1611 | 0.1683 | 0.1637 | 0.1614 | 0.1702 | 0.1734 | 0.1637 | 0.1690 | 0.1762 |
| EIRP(dBm) | 28.07 | 28.26 | 28.14 | 28.08 | 28.31 | 28.39 | 28.14 | 28.28 | 28.46 |
| EIRP(Watts) | 0.6412 | 0.6699 | 0.6516 | 0.6427 | 0.6776 | 0.6902 | 0.6516 | 0.6730 | 0.7015 |



| LTE Band 5 QPSK (GT - LC =9 dB) | | | | | | | | | |
|---------------------------------|-------------|--------|--------|-----------|--------|--------|------------|--------|--------|
| Bandwidth | 1.4M(3RB-3) | | | 3M(1RB-0) | | | 5M(1RB-12) | | |
| Channel | 20407 | 20525 | 20643 | 20415 | 20525 | 20635 | 20450 | 20525 | 20600 |
| Frequency (MHz) | (Low) | (Mid) | (High) | (Low) | (Mid) | (High) | (Low) | (Mid) | (High) |
| | 824.7 | 836.5 | 848.3 | 825.5 | 836.5 | 847.5 | 829 | 836.5 | 844 |
| Conducted Power (dBm) | 23.19 | 23.25 | 23.32 | 22.97 | 23.05 | 23.21 | 23.27 | 23.24 | 23.25 |
| Conducted Power (Watts) | 0.2084 | 0.2113 | 0.2148 | 0.1982 | 0.2018 | 0.2094 | 0.2123 | 0.2109 | 0.2113 |
| ERP(dBm) | 30.04 | 30.10 | 30.17 | 29.82 | 29.90 | 30.06 | 30.12 | 30.09 | 30.10 |
| ERP(Watts) | 1.0093 | 1.0233 | 1.0399 | 0.9594 | 0.9772 | 1.0139 | 1.0280 | 1.0209 | 1.0233 |

| LTE Band 5 QPSK(GT - LC =9 dB) | | | |
|--------------------------------|-----------------------|--------|--------|
| Bandwidth | 10M(1RB-25) | | |
| Channel | 20450 | 20525 | 20600 |
| | (Low) | (Mid) | (High) |
| Frequency (MHz) | 829 | 836.5 | 844 |
| | Conducted Power (dBm) | 23.33 | 23.43 |
| Conducted Power (Watts) | 0.2153 | 0.2203 | 0.2109 |
| ERP(dBm) | 30.18 | 30.28 | 30.09 |
| ERP(Watts) | 1.0423 | 1.0666 | 1.0209 |



| LTE Band 5 16QAM(GT - LC =9 dB) | | | | | | | | | |
|---------------------------------|-------------|--------|--------|-----------|--------|--------|-----------|--------|--------|
| Bandwidth | 1.4M(1RB-3) | | | 3M(1RB-8) | | | 5M(1RB-0) | | |
| Channel | 20407 | 20525 | 20643 | 20415 | 20525 | 20635 | 20425 | 20525 | 20625 |
| Frequency (MHz) | (Low) | (Mid) | (High) | (Low) | (Mid) | (High) | (Low) | (Mid) | (High) |
| | | 824.7 | 836.5 | 848.3 | 825.5 | 836.5 | 847.5 | 826.5 | 836.5 |
| Conducted Power (dBm) | 22.51 | 22.02 | 22.03 | 22.00 | 21.86 | 22.53 | 21.93 | 21.87 | 22.04 |
| Conducted Power (Watts) | 0.1782 | 0.1592 | 0.1596 | 0.1585 | 0.1535 | 0.1791 | 0.1560 | 0.1538 | 0.1600 |
| ERP(dBm) | 29.36 | 28.87 | 28.88 | 28.85 | 28.71 | 29.38 | 28.78 | 28.72 | 28.89 |
| ERP(Watts) | 0.8630 | 0.7709 | 0.7727 | 0.7674 | 0.7430 | 0.8670 | 0.7551 | 0.7447 | 0.7745 |

| LTE Band 5 16QAM (GT - LC =9 dB) | | | |
|----------------------------------|-------------|--------|--------|
| Bandwidth | 10M(1RB-25) | | |
| Channel | 20450 | 20525 | 20600 |
| | (Low) | (Mid) | (High) |
| Frequency (MHz) | 829 | 836.5 | 844 |
| Conducted Power (dBm) | 21.96 | 22.09 | 21.99 |
| Conducted Power (Watts) | 0.1570 | 0.1618 | 0.1581 |
| ERP(dBm) | 28.81 | 28.94 | 28.84 |
| ERP(Watts) | 0.7603 | 0.7834 | 0.7656 |



| LTE Band 12 QPSK (GT - LC =9 dB) | | | | | | | | | |
|----------------------------------|-------------|--------|--------|-----------|--------|--------|------------|--------|--------|
| Bandwidth | 1.4M(3RB-3) | | | 3M(1RB-8) | | | 5M(1RB-12) | | |
| Channel | 23017 | 23095 | 23173 | 23025 | 23095 | 23165 | 23035 | 23095 | 23155 |
| Frequency (MHz) | (Low) | (Mid) | (High) | (Low) | (Mid) | (High) | (Low) | (Mid) | (High) |
| | 699.7 | 707.5 | 715.3 | 700.5 | 707.5 | 714.5 | 701.5 | 707.5 | 713.5 |
| Conducted Power (dBm) | 23.44 | 23.34 | 23.30 | 23.38 | 23.25 | 23.05 | 23.31 | 23.39 | 23.15 |
| Conducted Power (Watts) | 0.2208 | 0.2158 | 0.2138 | 0.2178 | 0.2113 | 0.2018 | 0.2143 | 0.2183 | 0.2065 |
| ERP(dBm) | 30.29 | 30.19 | 30.15 | 30.23 | 30.10 | 29.90 | 30.16 | 30.24 | 30.00 |
| ERP(Watts) | 1.0691 | 1.0447 | 1.0351 | 1.0544 | 1.0233 | 0.9772 | 1.0375 | 1.0568 | 1.0000 |

| LTE Band 12 QPSK(GT - LC =9 dB) | | | |
|---------------------------------|-------------|--------|--------|
| Bandwidth | 10M(1RB-25) | | |
| Channel | 23060 | 23095 | 23130 |
| Frequency (MHz) | (Low) | (Mid) | (High) |
| | 704 | 707.5 | 711 |
| Conducted Power (dBm) | 23.22 | 23.5 | 23.42 |
| Conducted Power (Watts) | 0.2099 | 0.2239 | 0.2198 |
| ERP(dBm) | 30.07 | 30.35 | 30.27 |
| ERP(Watts) | 1.0162 | 1.0839 | 1.0641 |



| LTE Band 12 16QAM(GT - LC =9 dB) | | | | | | | | | |
|----------------------------------|-------------|--------|--------|-----------|--------|--------|-----------|--------|--------|
| Bandwidth | 1.4M(3RB-1) | | | 3M(1RB-0) | | | 5M(1RB-0) | | |
| Channel | 23017 | 23095 | 23173 | 23025 | 23095 | 23165 | 23035 | 23095 | 23155 |
| Frequency (MHz) | (Low) | (Mid) | (High) | (Low) | (Mid) | (High) | (Low) | (Mid) | (High) |
| | 699.7 | 707.5 | 715.3 | 700.5 | 707.5 | 714.5 | 701.5 | 707.5 | 713.5 |
| Conducted Power (dBm) | 22.31 | 22.6 | 22.34 | 22.19 | 22.12 | 22.08 | 21.89 | 22.16 | 22.05 |
| Conducted Power (Watts) | 0.1702 | 0.1820 | 0.1714 | 0.1656 | 0.1629 | 0.1614 | 0.1545 | 0.1644 | 0.1603 |
| ERP(dBm) | 29.16 | 29.45 | 29.19 | 29.04 | 28.97 | 28.93 | 28.74 | 29.01 | 28.90 |
| ERP(Watts) | 0.8241 | 0.8810 | 0.8299 | 0.8017 | 0.7889 | 0.7816 | 0.7482 | 0.7962 | 0.7762 |

| LTE Band 12 16QAM (GT - LC =9 dB) | | | |
|-----------------------------------|-------------|--------|--------|
| Bandwidth | 10M(1RB-25) | | |
| Channel | 23060 | 23095 | 23130 |
| Frequency (MHz) | (Low) | (Mid) | (High) |
| | 704 | 707.5 | 711 |
| Conducted Power (dBm) | 22.16 | 22.19 | 22.12 |
| Conducted Power (Watts) | 0.1644 | 0.1656 | 0.1629 |
| ERP(dBm) | 29.01 | 29.04 | 28.97 |
| ERP(Watts) | 0.7962 | 0.8017 | 0.7889 |



Peak-to-Average Ratio

| Mode | LTE Band 2 / 20MHz | | | | |
|------------|--------------------|---------|-------|---------|-------------|
| Mod. | QPSK | | 16QAM | | Limit: 13dB |
| RB Size | 1RB | Full RB | 1RB | Full RB | Result |
| Lowest CH | 4.49 | 4.49 | 5.33 | 5.59 | PASS |
| Middle CH | 3.86 | 4.49 | 4.75 | 5.42 | |
| Highest CH | 4.64 | 4.38 | 5.22 | 5.45 | |

| Mode | LTE Band 4 / 20MHz | | | | |
|------------|--------------------|---------|-------|---------|-------------|
| Mod. | QPSK | | 16QAM | | Limit: 13dB |
| RB Size | 1RB | Full RB | 1RB | Full RB | Result |
| Lowest CH | 4.78 | 4.78 | 5.54 | 5.88 | PASS |
| Middle CH | 4.70 | 4.93 | 5.51 | 6.03 | |
| Highest CH | 4.70 | 4.64 | 5.80 | 5.74 | |

| Mode | LTE Band 5 / 10MHz | | | | |
|------------|--------------------|---------|-------|---------|-------------|
| Mod. | QPSK | | 16QAM | | Limit: 13dB |
| RB Size | 1RB | Full RB | 1RB | Full RB | Result |
| Lowest CH | 4.32 | 4.81 | 5.04 | 5.62 | PASS |
| Middle CH | 4.64 | 5.10 | 5.42 | 6.06 | |
| Highest CH | 4.67 | 4.87 | 5.36 | 5.77 | |

| Mode | LTE Band 12 / 10MHz | | | | |
|------------|---------------------|---------|-------|---------|-------------|
| Mod. | QPSK | | 16QAM | | Limit: 13dB |
| RB Size | 1RB | Full RB | 1RB | Full RB | Result |
| Lowest CH | 4.38 | 4.29 | 5.16 | 5.59 | PASS |
| Middle CH | 4.26 | 4.75 | 4.99 | 5.62 | |
| Highest CH | 3.97 | 4.72 | 4.99 | 5.74 | |



LTE Band 2 / 20MHz / QPSK

Lowest Channel / 1RB

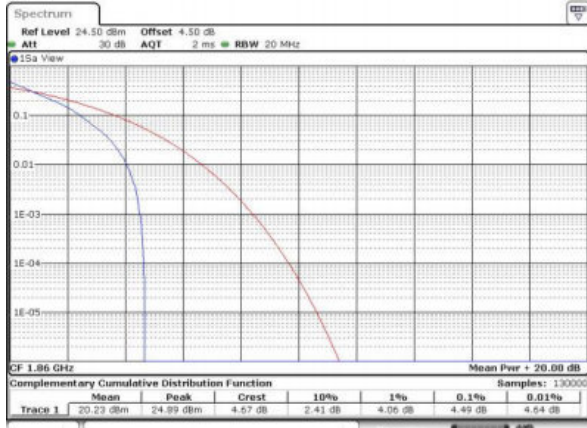

Date: 18 MAR 2016 17:37:18

Lowest Channel / Full RB

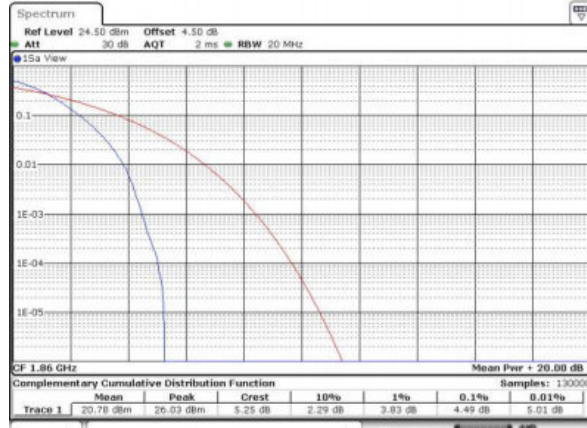

Date: 18 MAR 2016 17:37:54

Middle Channel / 1RB

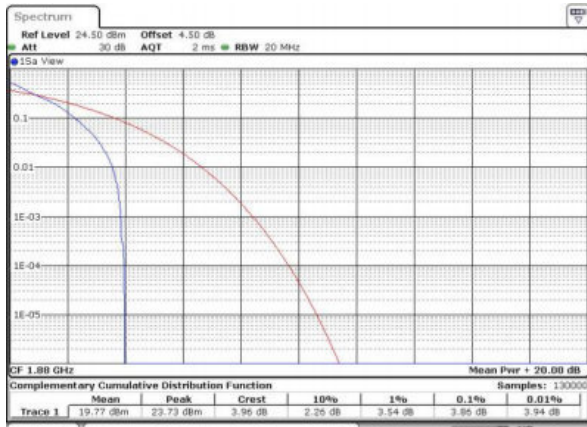

Date: 18 MAR 2016 17:46:07

Middle Channel / Full RB

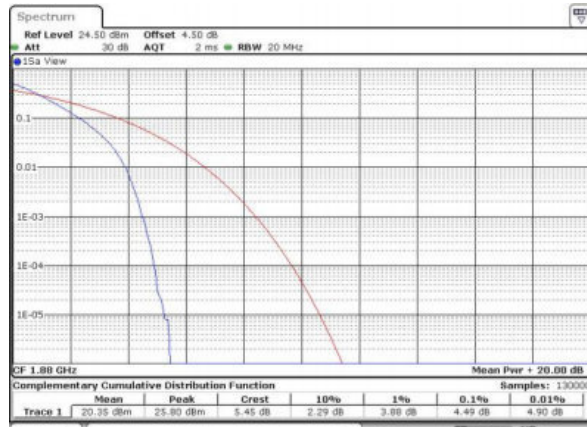

Date: 18 MAR 2016 17:44:52

Highest Channel / 1RB

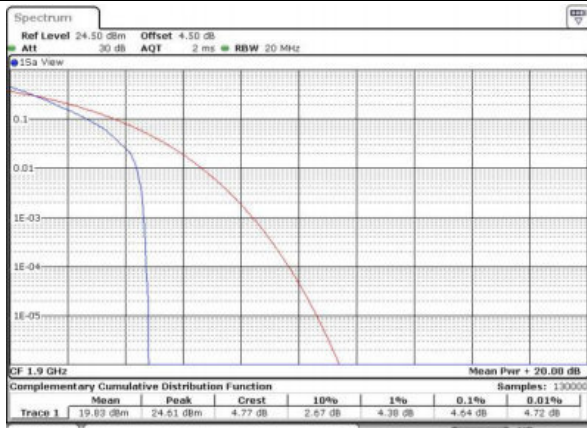

Date: 18 MAR 2016 17:46:24

Highest Channel / Full RB

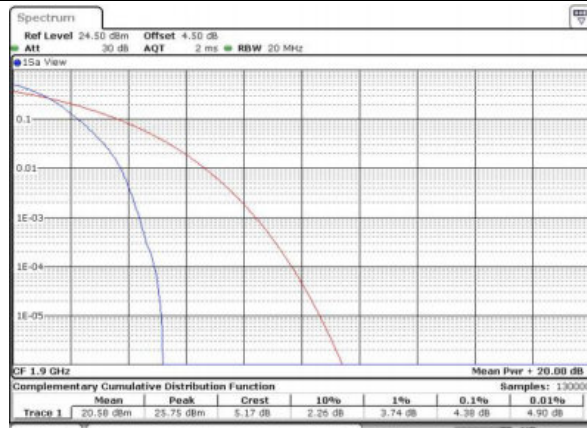

Date: 18 MAR 2016 17:40:16



LTE Band 2 / 20MHz / 16QAM

Lowest Channel / 1RB

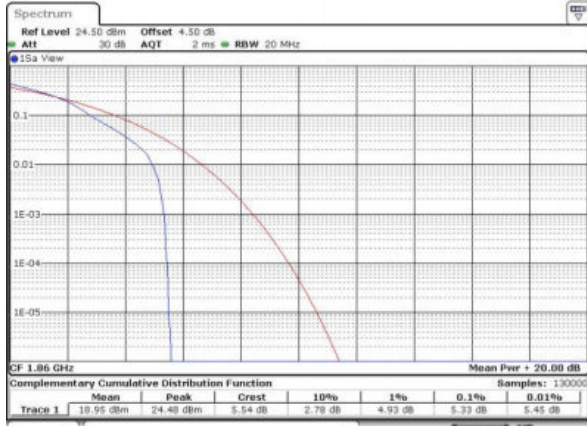

Date: 18 MAR 2016 17:37:29

Lowest Channel / Full RB

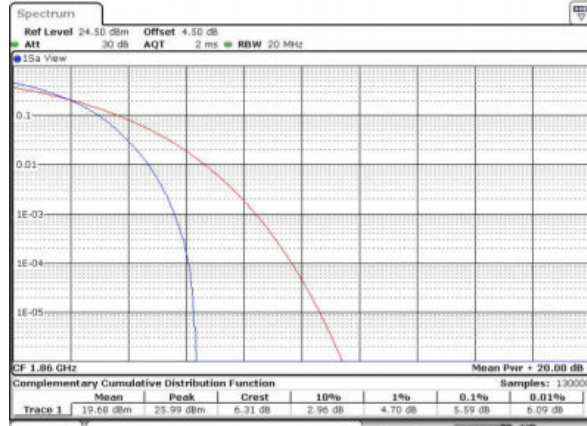

Date: 18 MAR 2016 17:37:42

Middle Channel / 1RB

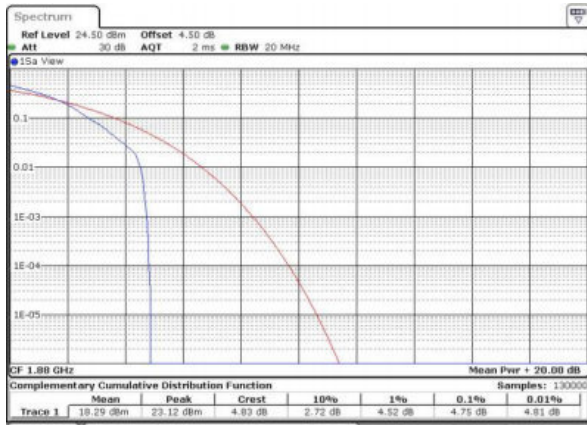

Date: 18 MAR 2016 17:39:04

Middle Channel / Full RB

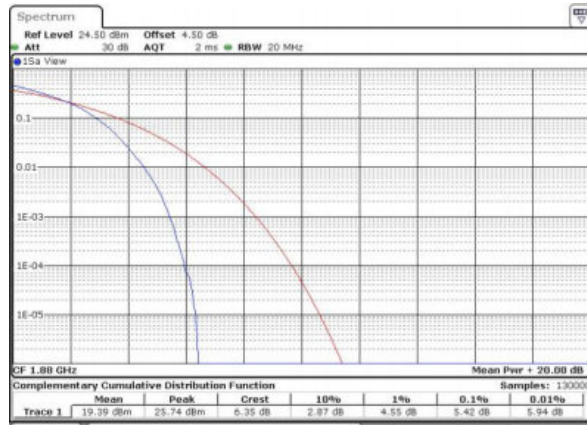

Date: 18 MAR 2016 17:43:08

Highest Channel / 1RB

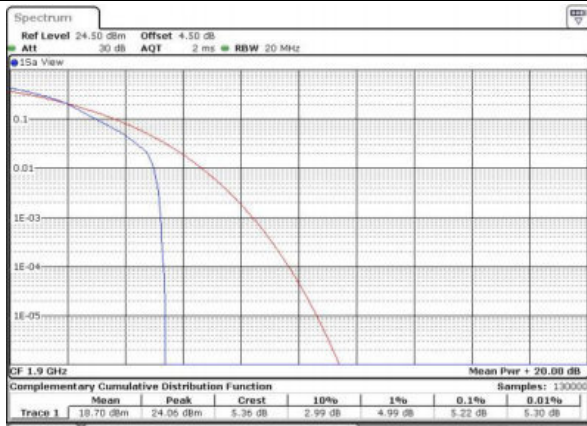

Date: 18 MAR 2016 17:39:17

Highest Channel / Full RB

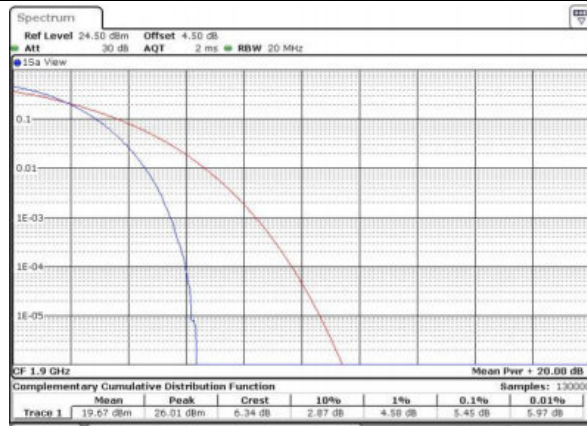

Date: 18 MAR 2016 17:41:33



LTE Band 4 / 20MHz / QPSK

Lowest Channel / 1RB

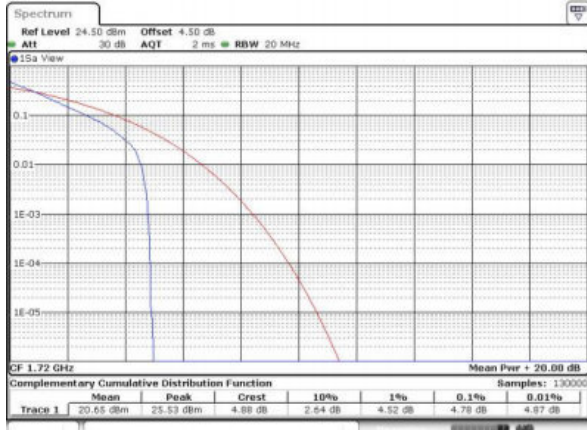

Date: 19 MAR 2016 11:46:31

Lowest Channel / Full RB

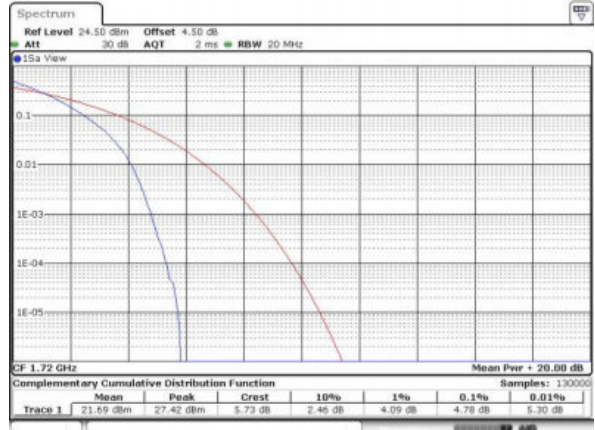

Date: 19 MAR 2016 11:46:19

Middle Channel / 1RB

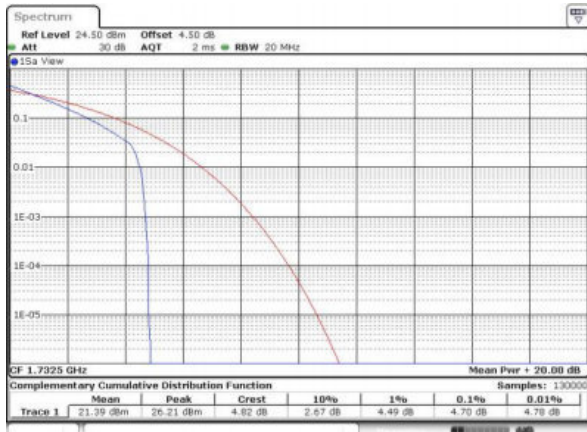

Date: 19 MAR 2016 11:46:56

Middle Channel / Full RB

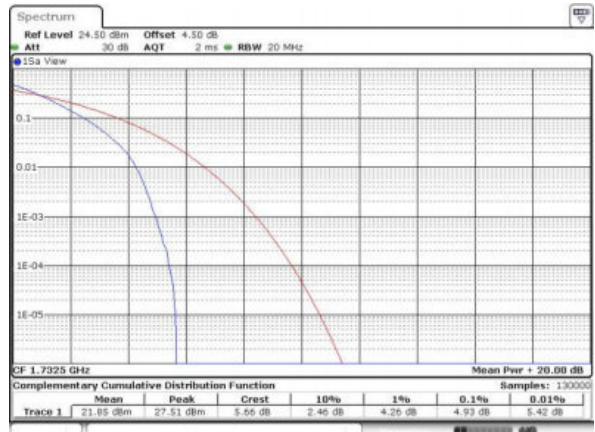

Date: 19 MAR 2016 11:46:07

Highest Channel / 1RB

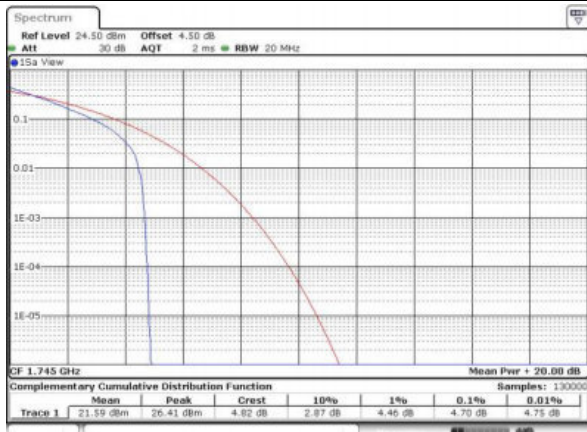

Date: 19 MAR 2016 11:45:43

Highest Channel / Full RB

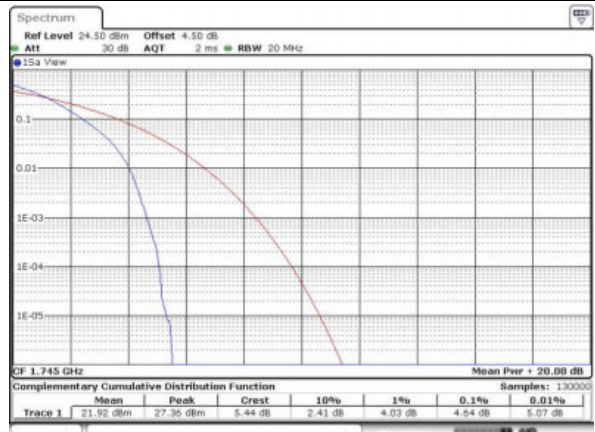

Date: 19 MAR 2016 11:45:31



LTE Band 4 / 20MHz / 16QAM

Lowest Channel / 1RB

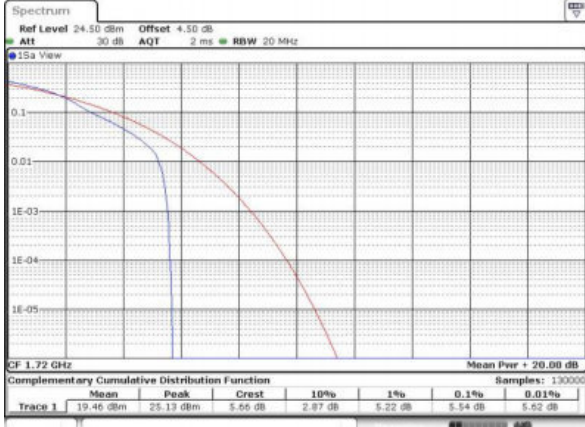

Date: 19 MAR 2016 11:43:02

Lowest Channel / Full RB

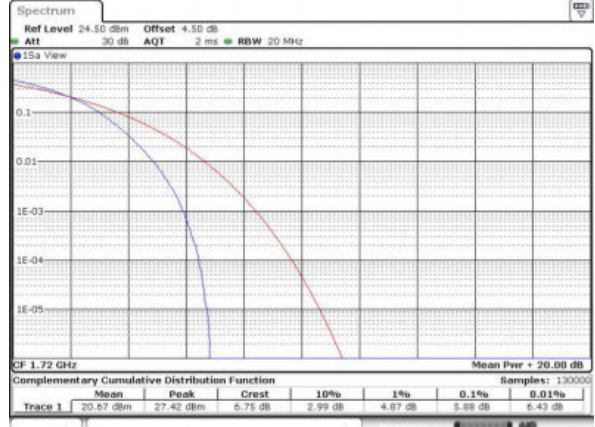

Date: 19 MAR 2016 11:43:11

Middle Channel / 1RB

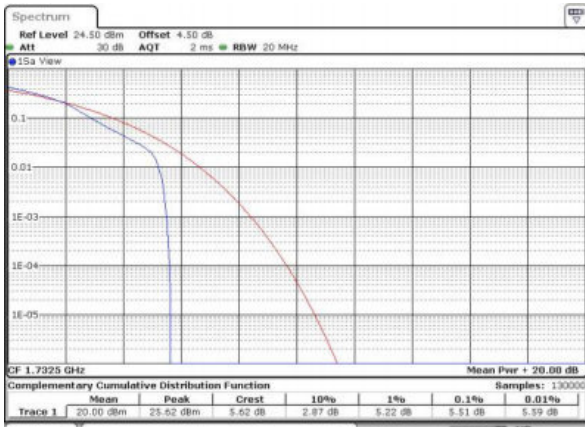

Date: 19 MAR 2016 11:43:20

Middle Channel / Full RB

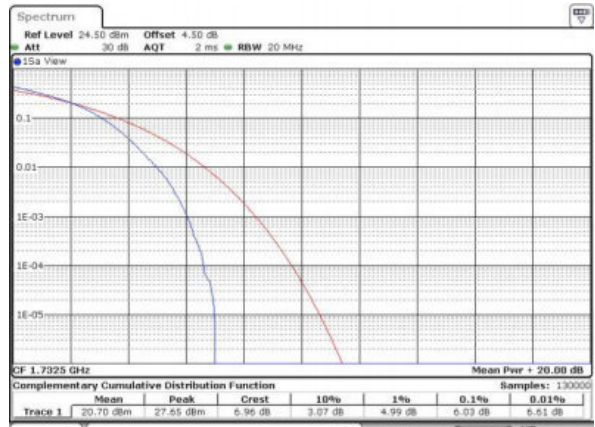

Date: 19 MAR 2016 11:43:30

Highest Channel / 1RB

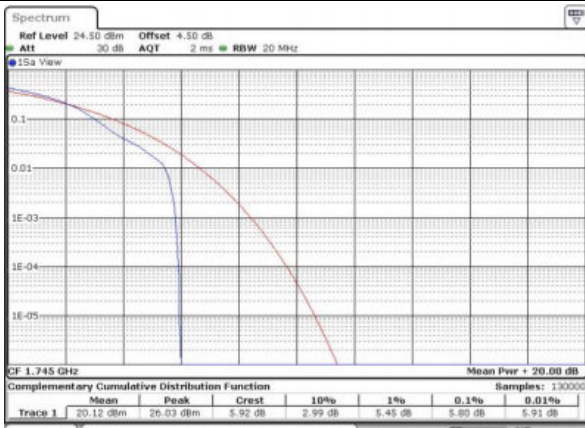

Date: 19 MAR 2016 11:43:39

Highest Channel / Full RB

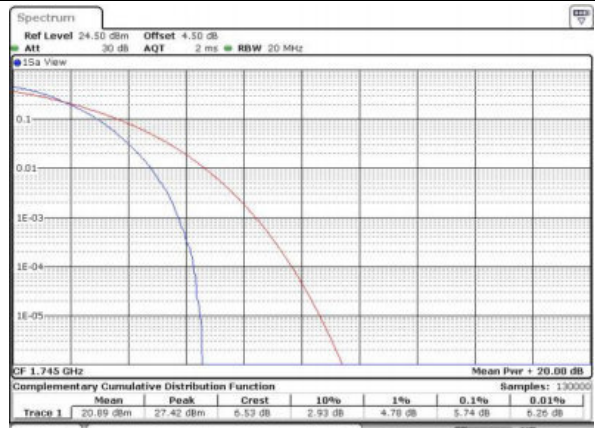

Date: 19 MAR 2016 11:44:26



LTE Band 5 / 10MHz / QPSK

Lowest Channel / 1RB

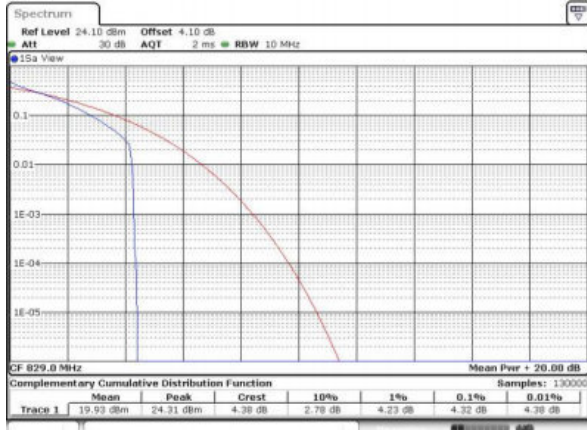

Date: 19 MAR 2016 00:08:05

Lowest Channel / Full RB

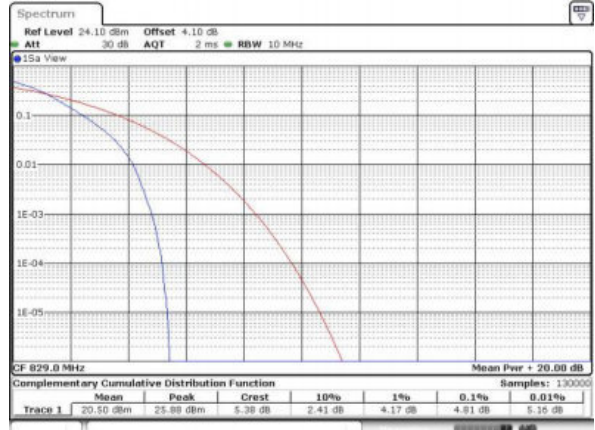

Date: 19 MAR 2016 00:08:22

Middle Channel / 1RB

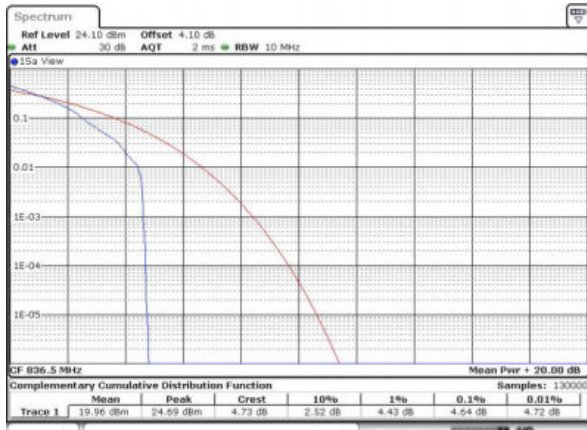

Date: 19 MAR 2016 00:08:50

Middle Channel / Full RB

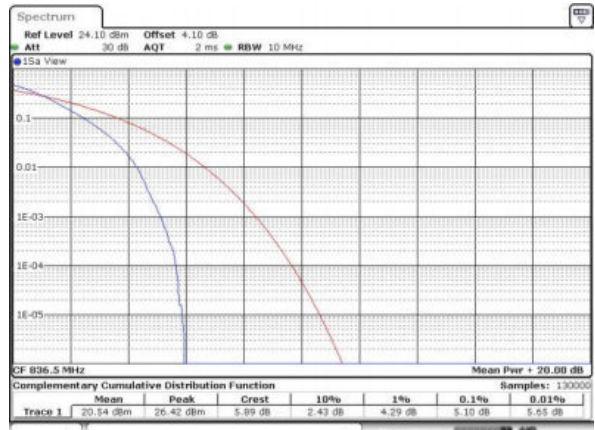

Date: 19 MAR 2016 00:08:56

Highest Channel / 1RB

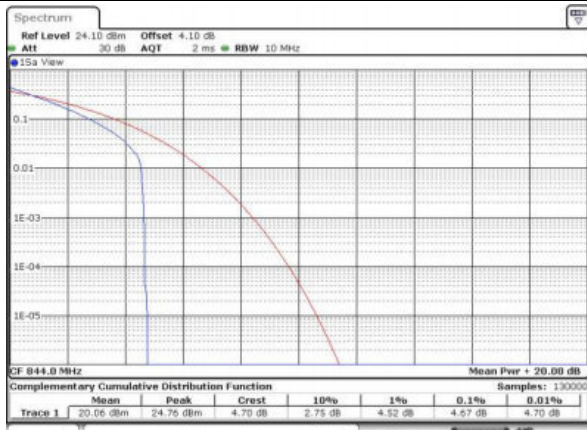

Date: 19 MAR 2016 00:09:07

Highest Channel / Full RB

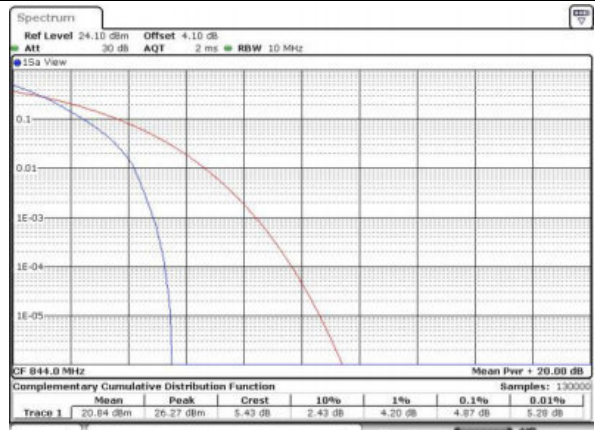

Date: 19 MAR 2016 00:09:24



LTE Band 5 / 10MHz / 16QAM

Lowest Channel / 1RB

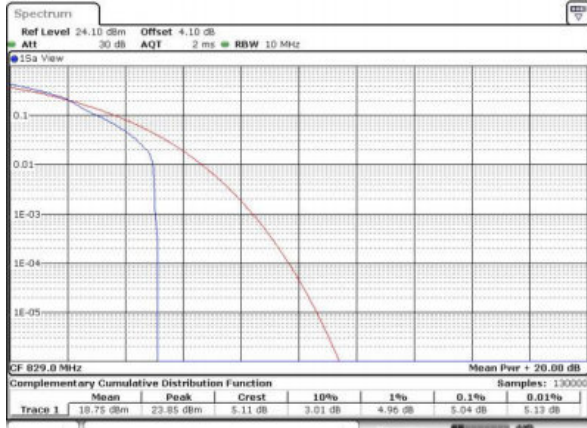

Date: 19 MAR 2016 00:06:21

Lowest Channel / Full RB



Date: 19 MAR 2016 00:06:32

Middle Channel / 1RB

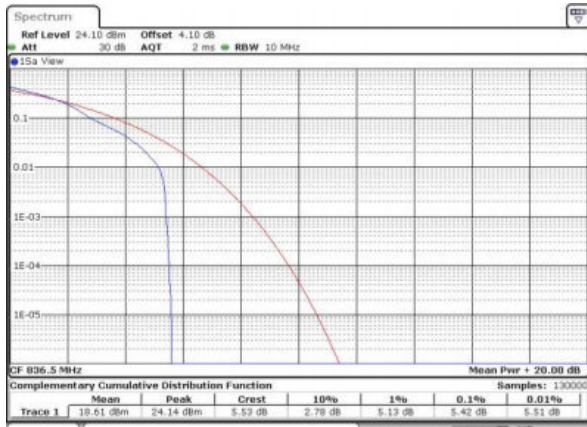

Date: 19 MAR 2016 00:06:42

Middle Channel / Full RB

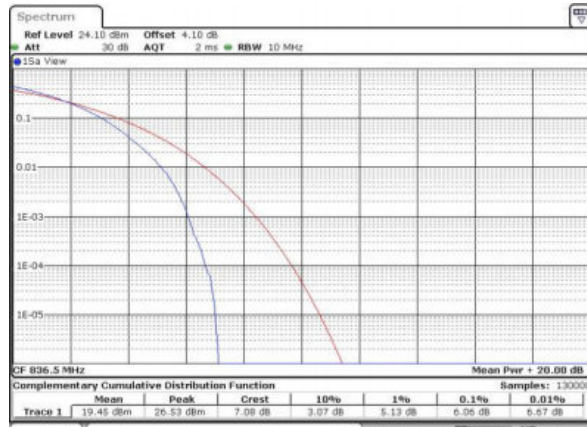

Date: 19 MAR 2016 00:06:52

Highest Channel / 1RB

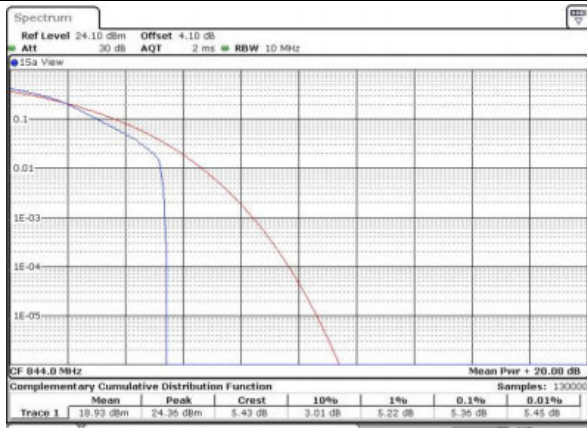

Date: 19 MAR 2016 00:07:02

Highest Channel / Full RB

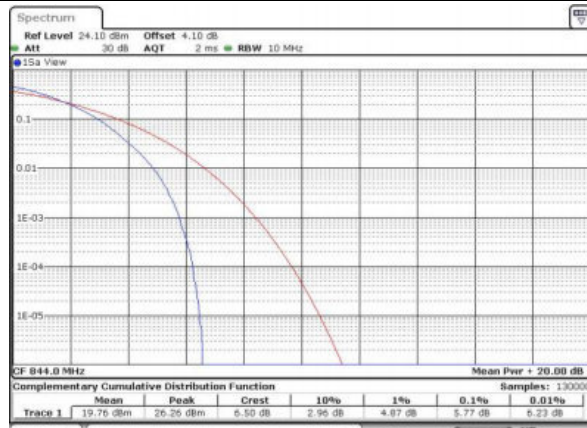

Date: 19 MAR 2016 00:07:13



LTE Band 12 / 10MHz / QPSK

Lowest Channel / 1RB

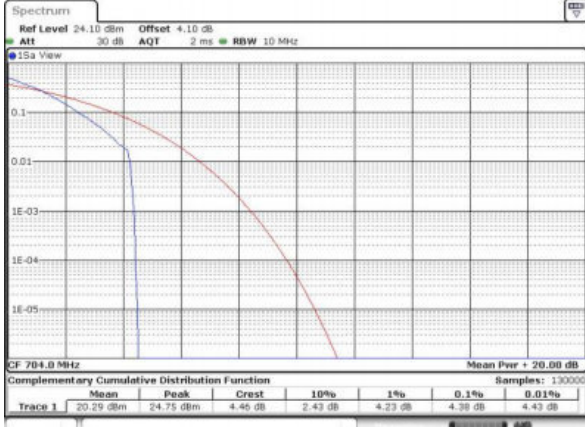

Date: 19 MAR 2016 16:27:16

Lowest Channel / Full RB

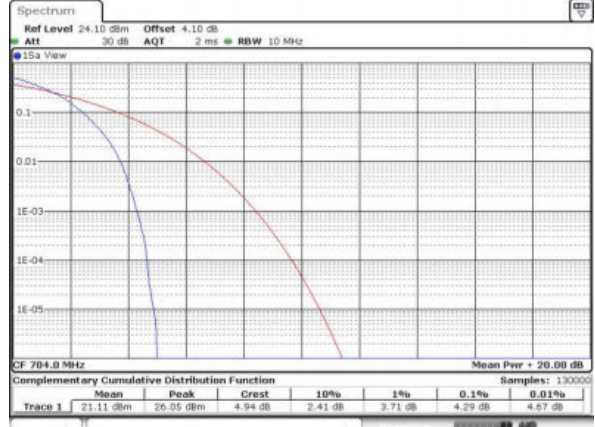

Date: 19 MAR 2016 16:27:50

Middle Channel / 1RB

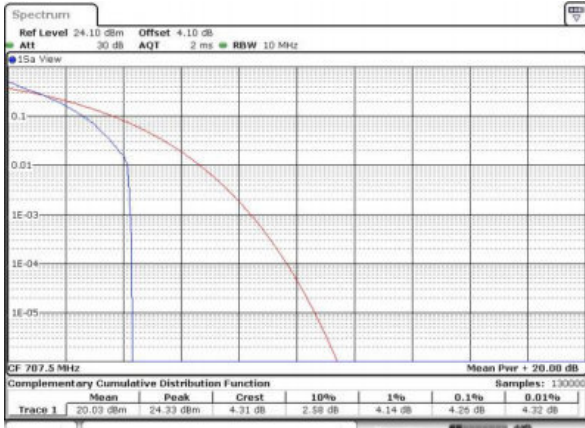

Date: 19 MAR 2016 16:28:47

Middle Channel / Full RB

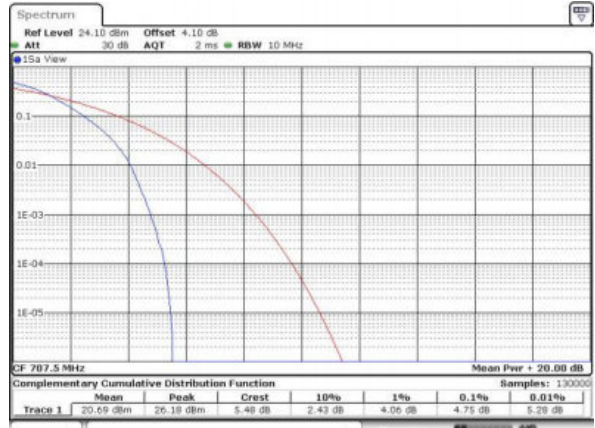

Date: 19 MAR 2016 16:28:06

Highest Channel / 1RB

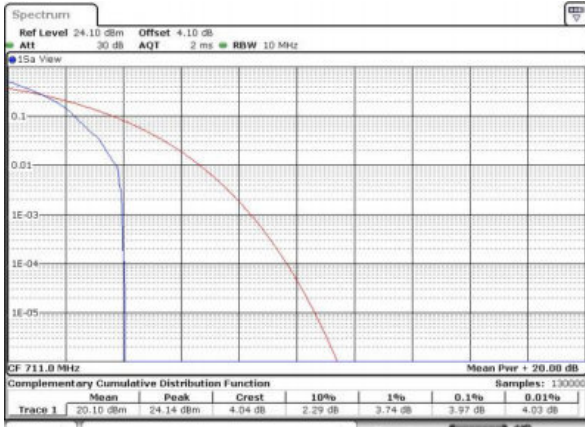

Date: 19 MAR 2016 16:28:57

Highest Channel / Full RB

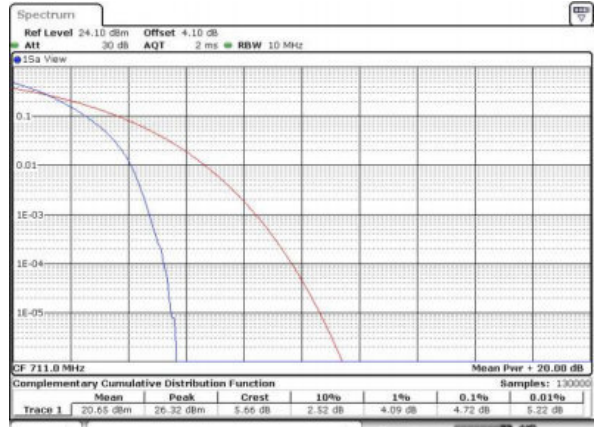

Date: 19 MAR 2016 16:29:33



LTE Band 12 / 10MHz / 16QAM

Lowest Channel / 1RB

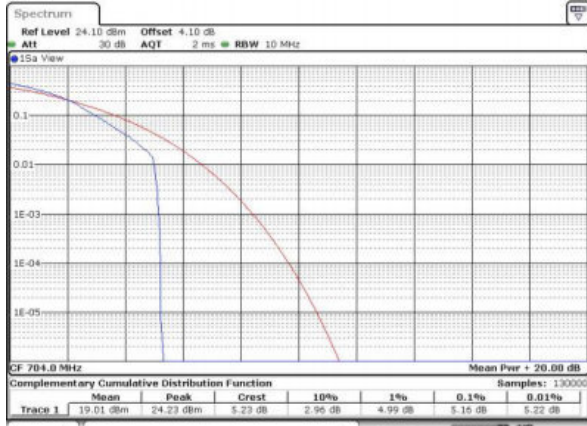

Date: 19 MAR 2016 16:27:27

Lowest Channel / Full RB

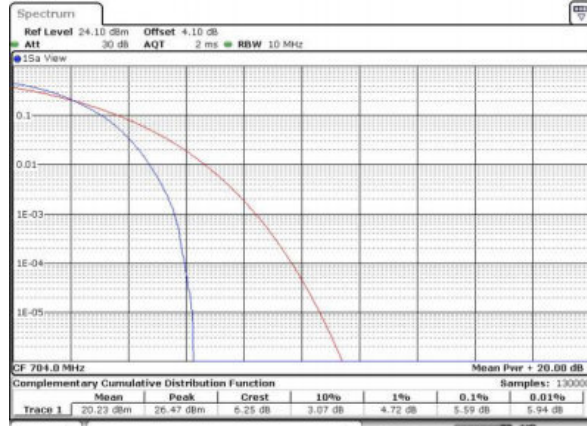

Date: 19 MAR 2016 16:27:38

Middle Channel / 1RB

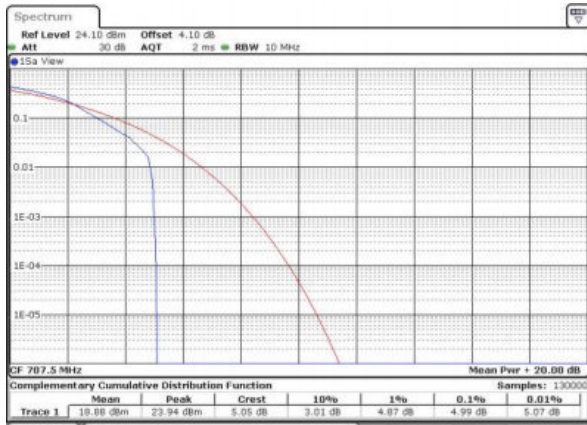

Date: 19 MAR 2016 16:28:34

Middle Channel / Full RB

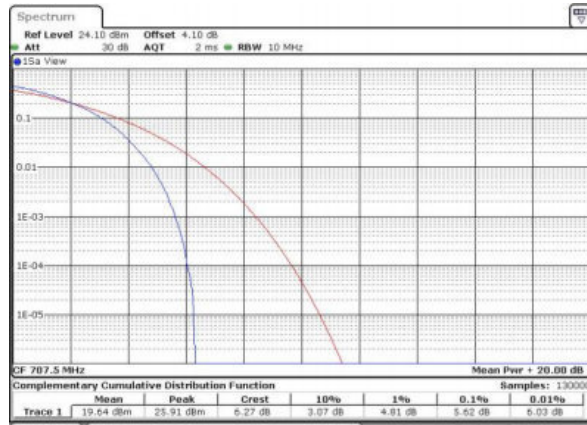

Date: 19 MAR 2016 16:28:21

Highest Channel / 1RB

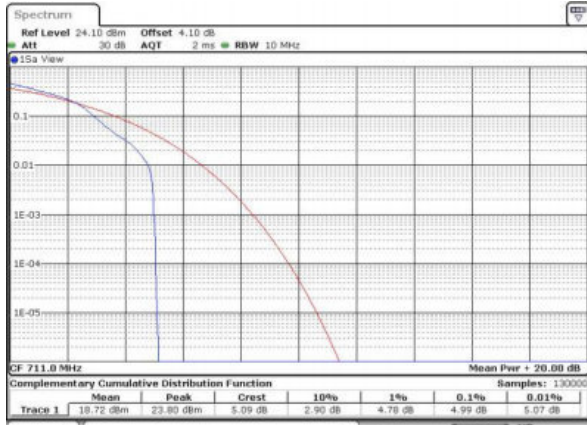

Date: 19 MAR 2016 16:29:11

Highest Channel / Full RB

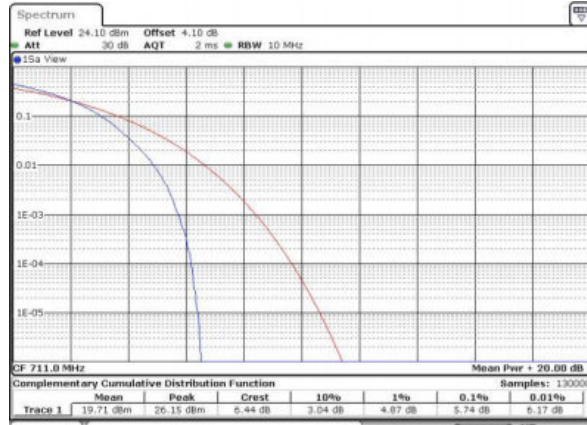

Date: 19 MAR 2016 16:29:21



26dB Bandwidth

| Mode | LTE Band 2 : 26dB BW(MHz) | | | | | | | | | | | |
|------------|---------------------------|-------|------|-------|------|-------|-------|-------|-------|-------|-------|-------|
| | 1.4MHz | | 3MHz | | 5MHz | | 10MHz | | 15MHz | | 20MHz | |
| Mod. | QPSK | 16QAM | QPSK | 16QAM | QPSK | 16QAM | QPSK | 16QAM | QPSK | 16QAM | QPSK | 16QAM |
| Lowest CH | 1.28 | 1.30 | 3.00 | 3.00 | 4.96 | 5.08 | 9.81 | 9.89 | 14.48 | 14.36 | 20.26 | 20.18 |
| Middle CH | 1.29 | 1.29 | 2.98 | 3.04 | 4.94 | 4.96 | 9.85 | 10.03 | 14.36 | 14.54 | 20.18 | 20.22 |
| Highest CH | 1.26 | 1.26 | 3.03 | 2.99 | 4.94 | 4.88 | 9.75 | 9.75 | 14.24 | 14.51 | 20.02 | 20.22 |

| Mode | LTE Band 4 : 26dB BW(MHz) | | | | | | | | | | | |
|------------|---------------------------|-------|------|-------|------|-------|-------|-------|-------|-------|-------|-------|
| | 1.4MHz | | 3MHz | | 5MHz | | 10MHz | | 15MHz | | 20MHz | |
| Mod. | QPSK | 16QAM | QPSK | 16QAM | QPSK | 16QAM | QPSK | 16QAM | QPSK | 16QAM | QPSK | 16QAM |
| Lowest CH | 1.26 | 1.27 | 3.02 | 3.02 | 4.88 | 4.90 | 9.75 | 10.01 | 14.27 | 14.21 | 20.06 | 20.02 |
| Middle CH | 1.27 | 1.28 | 2.99 | 3.02 | 5.01 | 4.99 | 9.79 | 9.77 | 14.45 | 14.45 | 20.22 | 20.10 |
| Highest CH | 1.28 | 1.28 | 3.02 | 3.02 | 4.88 | 4.79 | 9.85 | 9.83 | 14.27 | 14.27 | 20.02 | 20.14 |

| Mode | LTE Band 5 : 26dB BW(MHz) | | | | | | | | | | | |
|------------|---------------------------|-------|------|-------|------|-------|-------|-------|-------|-------|-------|-------|
| | 1.4MHz | | 3MHz | | 5MHz | | 10MHz | | 15MHz | | 20MHz | |
| Mod. | QPSK | 16QAM | QPSK | 16QAM | QPSK | 16QAM | QPSK | 16QAM | QPSK | 16QAM | QPSK | 16QAM |
| Lowest CH | 1.27 | 1.29 | 2.99 | 3.00 | 4.90 | 4.88 | 9.85 | 9.73 | - | - | - | - |
| Middle CH | 1.28 | 1.29 | 3.00 | 3.02 | 4.94 | 4.83 | 9.87 | 9.93 | - | - | - | - |
| Highest CH | 1.30 | 1.28 | 2.99 | 3.02 | 4.97 | 4.95 | 9.87 | 9.85 | - | - | - | - |

| Mode | LTE Band 12 : 26dB BW(MHz) | | | | | | | | | | | |
|------------|----------------------------|-------|------|-------|------|-------|-------|-------|-------|-------|-------|-------|
| | 1.4MHz | | 3MHz | | 5MHz | | 10MHz | | 15MHz | | 20MHz | |
| Mod. | QPSK | 16QAM | QPSK | 16QAM | QPSK | 16QAM | QPSK | 16QAM | QPSK | 16QAM | QPSK | 16QAM |
| Lowest CH | 1.28 | 1.28 | 3.02 | 2.99 | 4.84 | 4.95 | 9.67 | 9.77 | - | - | - | - |
| Middle CH | 1.27 | 1.26 | 3.00 | 3.03 | 4.94 | 4.94 | 9.93 | 9.71 | - | - | - | - |
| Highest CH | 1.26 | 1.26 | 3.04 | 3.03 | 4.91 | 4.99 | 10.07 | 9.77 | - | - | - | - |



LTE Band 2

Lowest Channel / 1.4MHz / QPSK

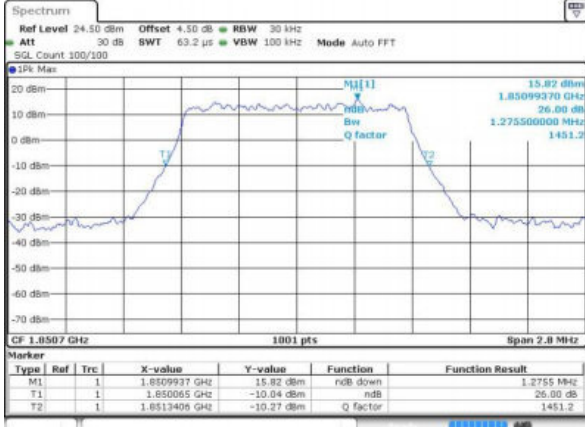

Date: 18 MAR 2016 15:16:07

Lowest Channel / 1.4MHz / 16QAM

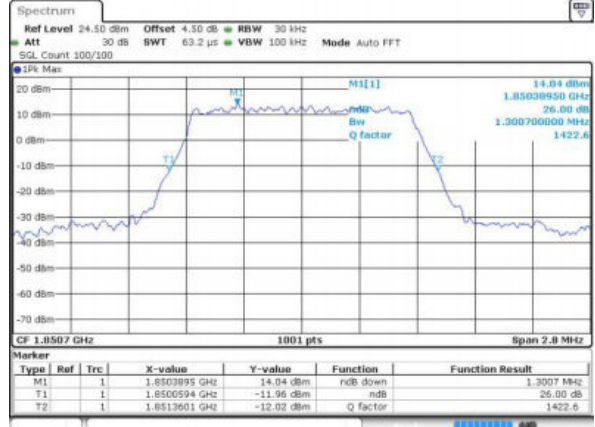

Date: 18 MAR 2016 15:16:17

Middle Channel / 1.4MHz / QPSK

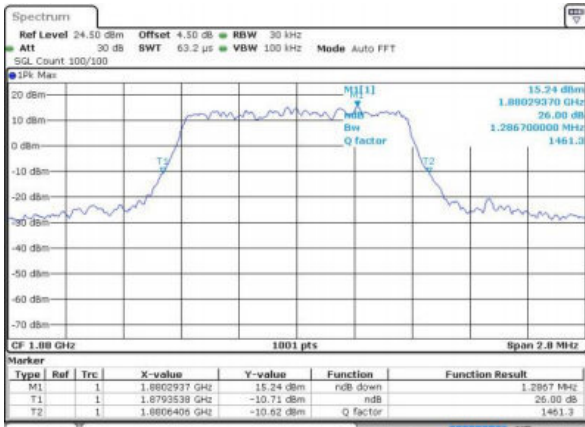

Date: 18 MAR 2016 15:23:13

Middle Channel / 1.4MHz / 16QAM

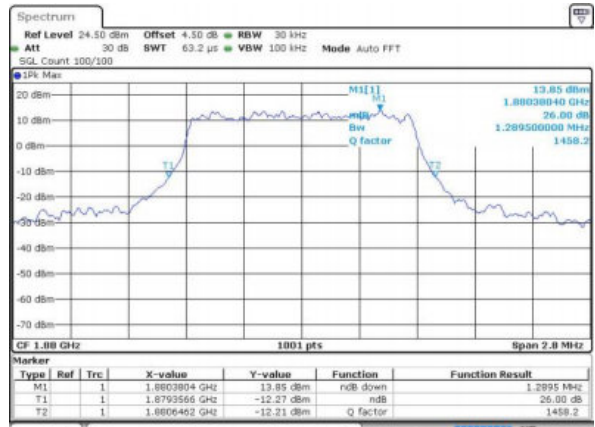

Date: 18 MAR 2016 15:23:23

Highest Channel / 1.4MHz / QPSK

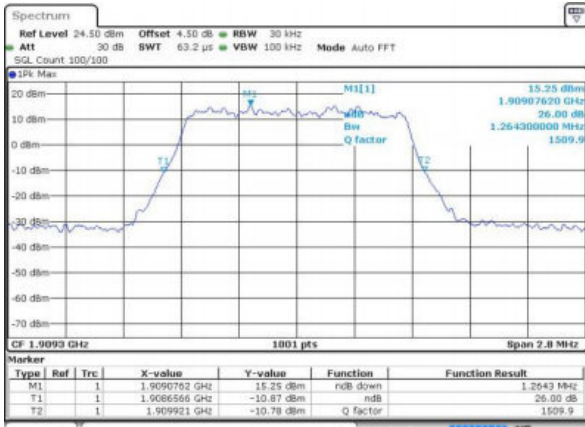

Date: 18 MAR 2016 15:25:45

Highest Channel / 1.4MHz / 16QAM

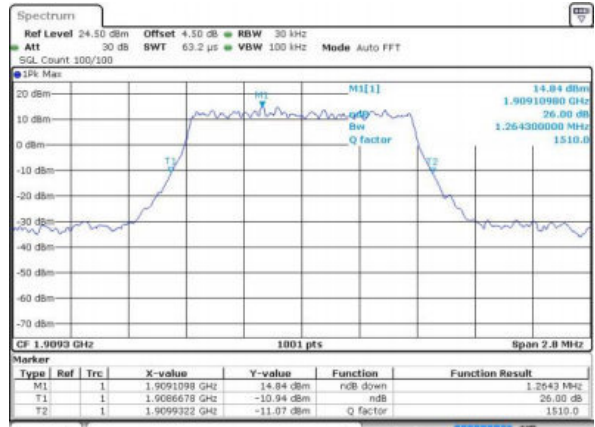

Date: 18 MAR 2016 15:25:55



LTE Band 2

Lowest Channel / 3MHz / QPSK



Date: 18 MAR 2016 15:32:49

Lowest Channel / 3MHz / 16QAM

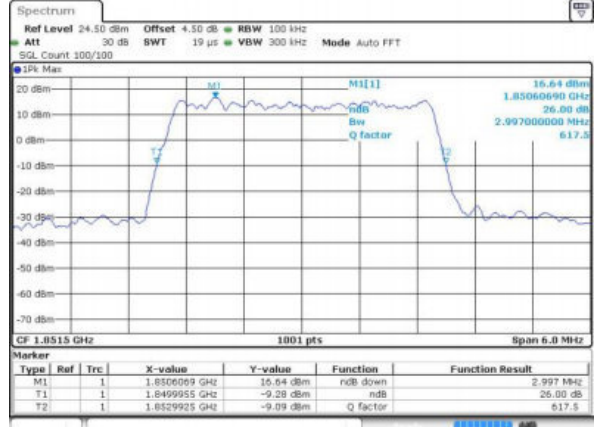

Date: 18 MAR 2016 15:33:00

Middle Channel / 3MHz / QPSK

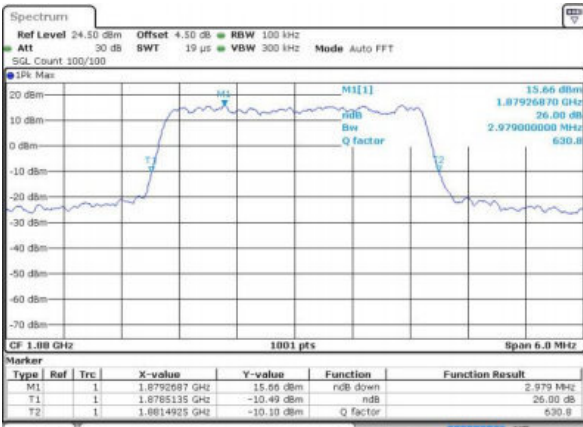

Date: 18 MAR 2016 15:39:54

Middle Channel / 3MHz / 16QAM

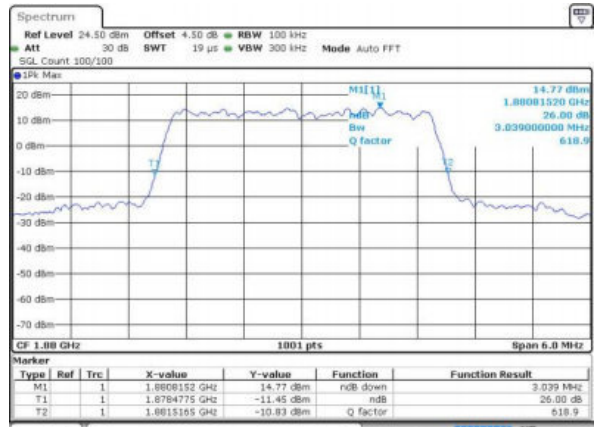

Date: 18 MAR 2016 15:40:04

Highest Channel / 3MHz / QPSK

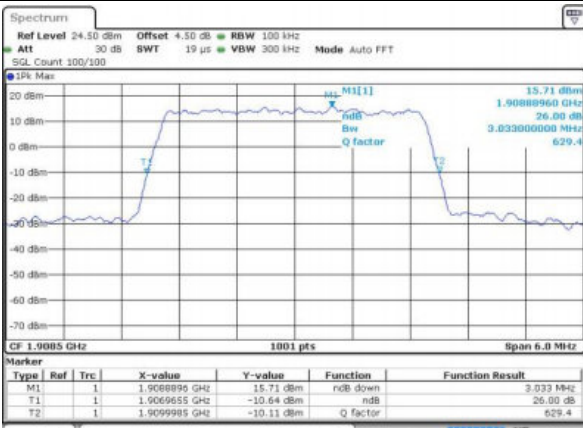

Date: 18 MAR 2016 15:42:26

Highest Channel / 3MHz / 16QAM

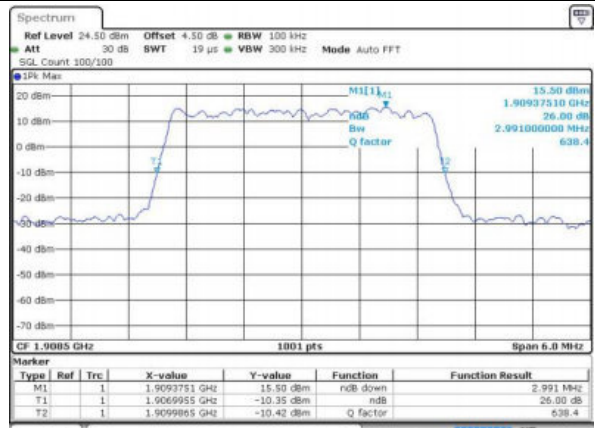

Date: 18 MAR 2016 15:42:37



LTE Band 2

Lowest Channel / 5MHz / QPSK

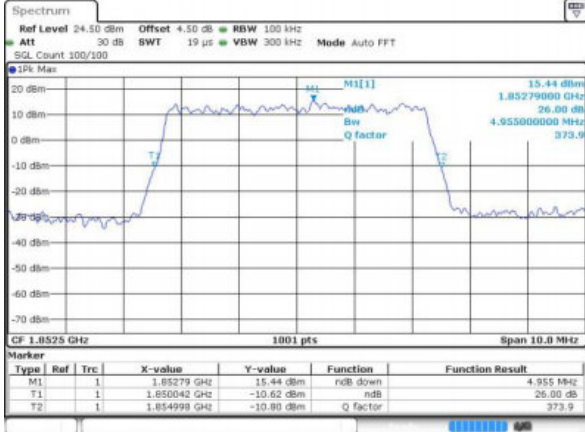

Date: 18 MAR 2016 15:49:30

Lowest Channel / 5MHz / 16QAM

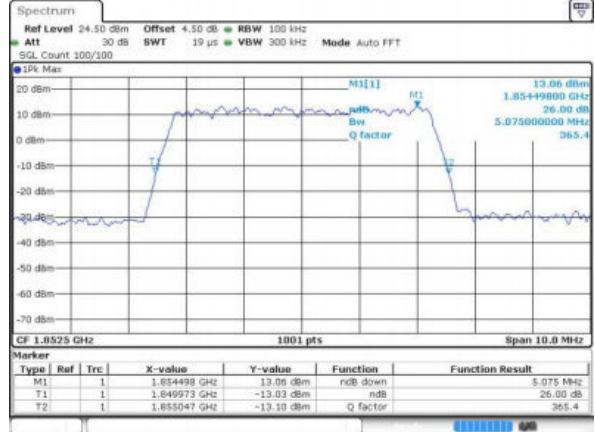

Date: 18 MAR 2016 15:49:41

Middle Channel / 5MHz / QPSK

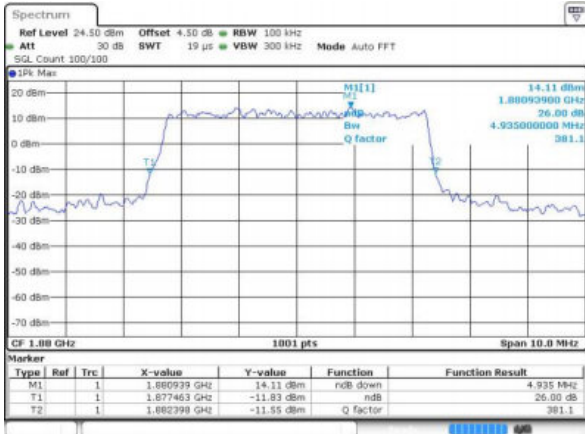

Date: 18 MAR 2016 17:54:49

Middle Channel / 5MHz / 16QAM

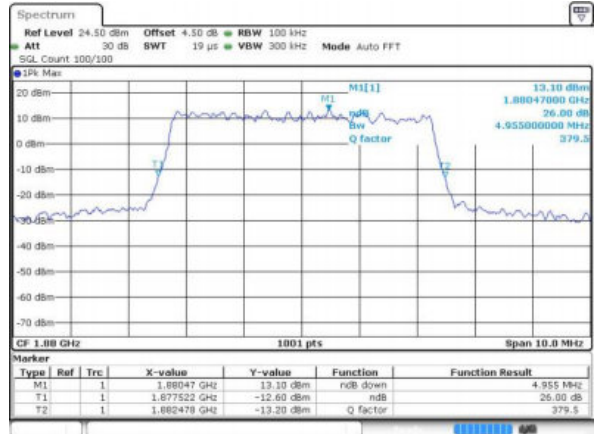

Date: 18 MAR 2016 15:56:45

Highest Channel / 5MHz / QPSK

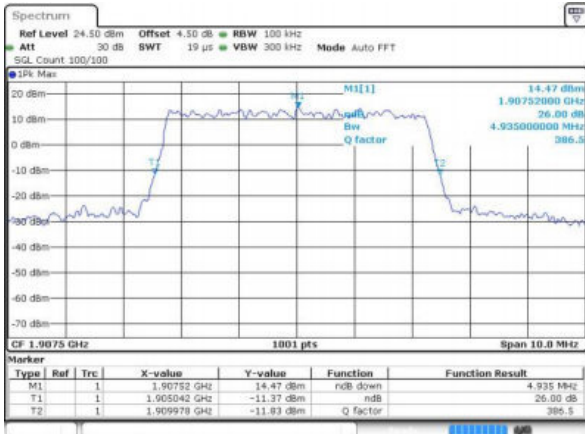

Date: 18 MAR 2016 15:59:08

Highest Channel / 5MHz / 16QAM

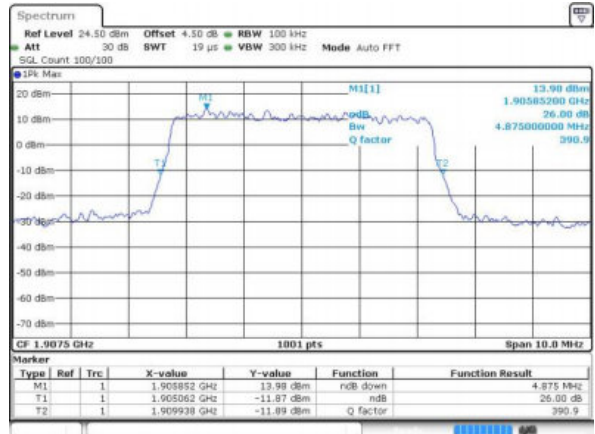

Date: 18 MAR 2016 15:59:18



LTE Band 2

Lowest Channel / 10MHz / QPSK



Date: 18 MAR 2016 16:06:12

Lowest Channel / 10MHz / 16QAM

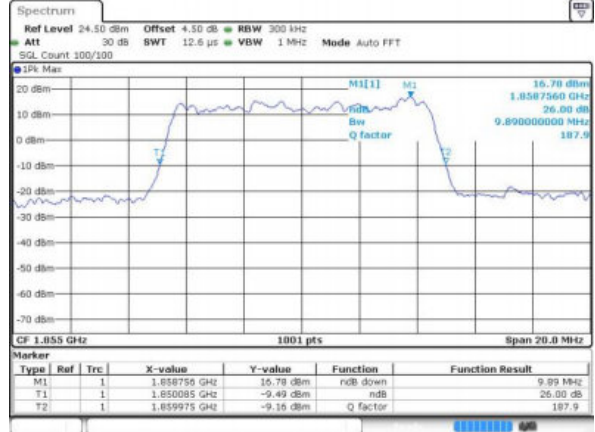

Date: 18 MAR 2016 16:06:22

Middle Channel / 10MHz / QPSK



Date: 18 MAR 2016 17:55:43

Middle Channel / 10MHz / 16QAM

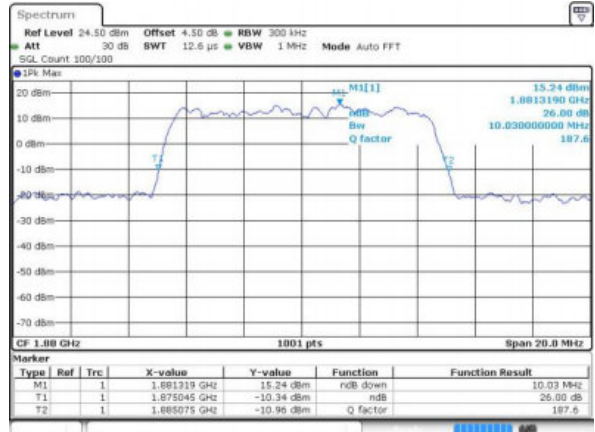

Date: 18 MAR 2016 16:13:27

Highest Channel / 10MHz / QPSK



Date: 18 MAR 2016 16:15:49

Highest Channel / 10MHz / 16QAM



Date: 18 MAR 2016 16:15:59



LTE Band 2

Lowest Channel / 15MHz / QPSK

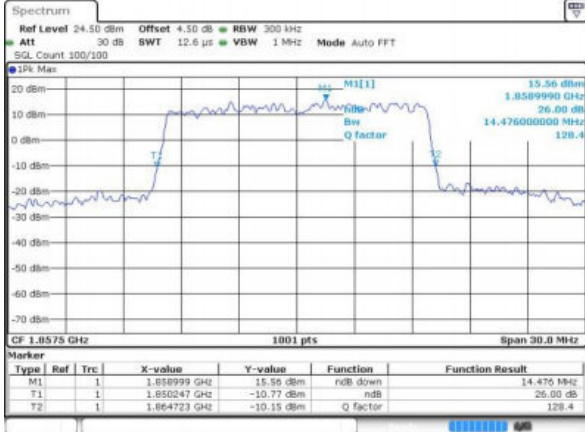

Date: 18 MAR 2016 17:04:11

Lowest Channel / 15MHz / 16QAM

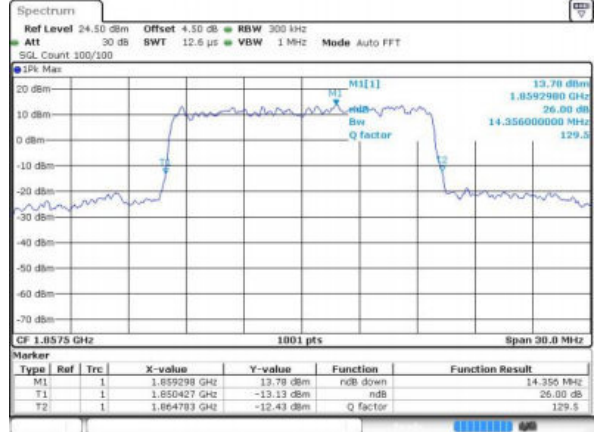

Date: 18 MAR 2016 17:04:22

Middle Channel / 15MHz / QPSK

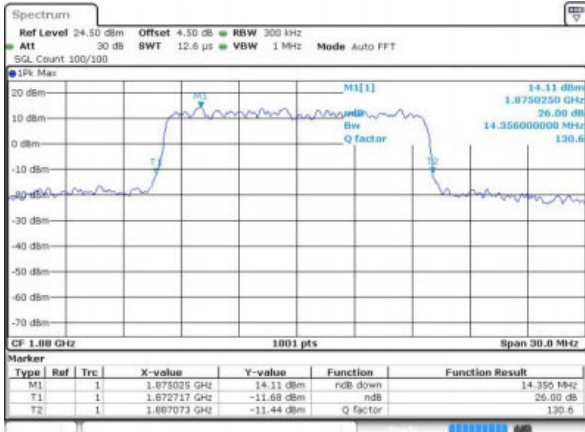

Date: 18 MAR 2016 17:04:45

Middle Channel / 15MHz / 16QAM

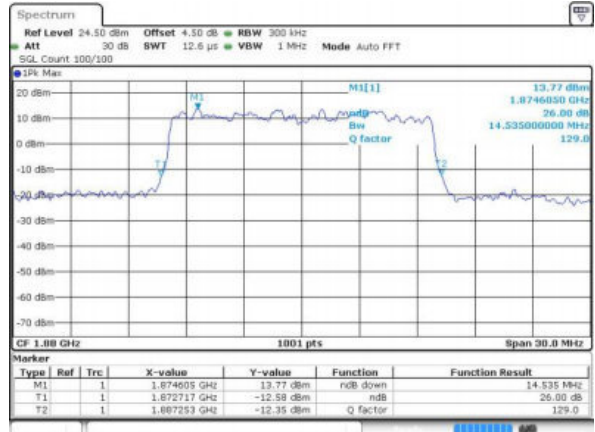

Date: 18 MAR 2016 17:04:54

Highest Channel / 15MHz / QPSK

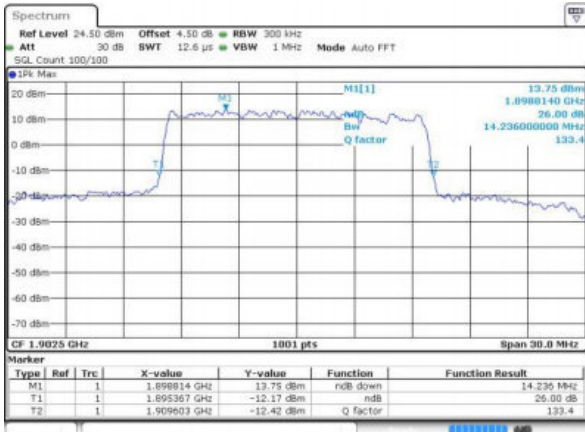

Date: 18 MAR 2016 17:56:57

Highest Channel / 15MHz / 16QAM



Date: 18 MAR 2016 17:06:53



LTE Band 2

Lowest Channel / 20MHz / QPSK



Date: 18 MAR 2016 17:58:01

Lowest Channel / 20MHz / 16QAM

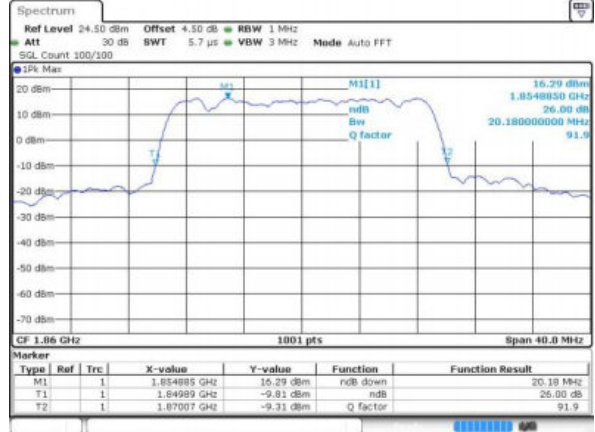

Date: 18 MAR 2016 17:16:08

Middle Channel / 20MHz / QPSK

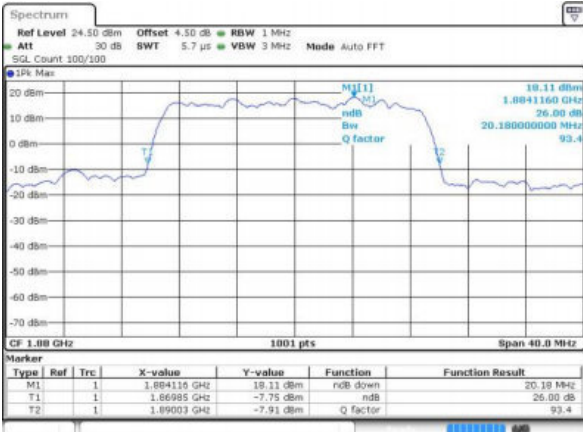

Date: 18 MAR 2016 17:20:28

Middle Channel / 20MHz / 16QAM

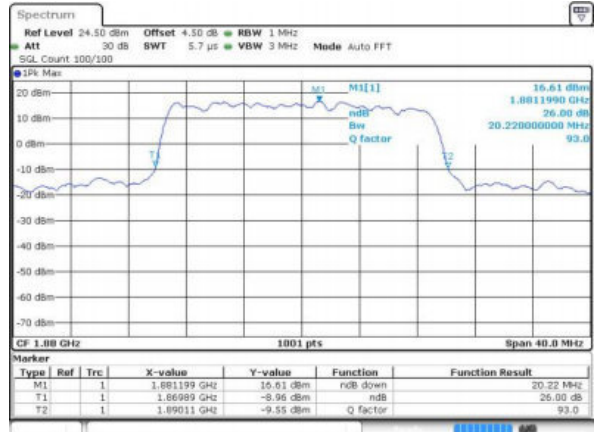

Date: 18 MAR 2016 17:20:39

Highest Channel / 20MHz / QPSK



Date: 18 MAR 2016 18:02:16

Highest Channel / 20MHz / 16QAM



Date: 18 MAR 2016 17:20:56



LTE Band 4

Lowest Channel / 1.4MHz / QPSK

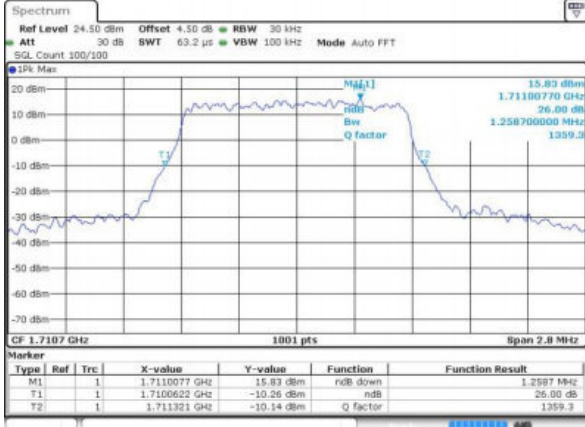

Date: 19 MAR 2016 09:01:20

Lowest Channel / 1.4MHz / 16QAM

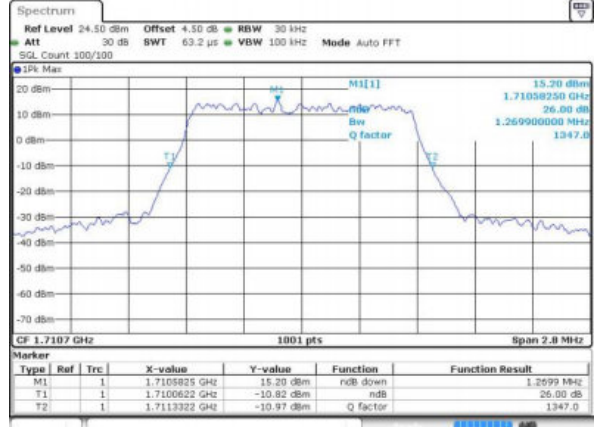

Date: 19 MAR 2016 09:01:30

Middle Channel / 1.4MHz / QPSK



Date: 19 MAR 2016 13:57:23

Middle Channel / 1.4MHz / 16QAM

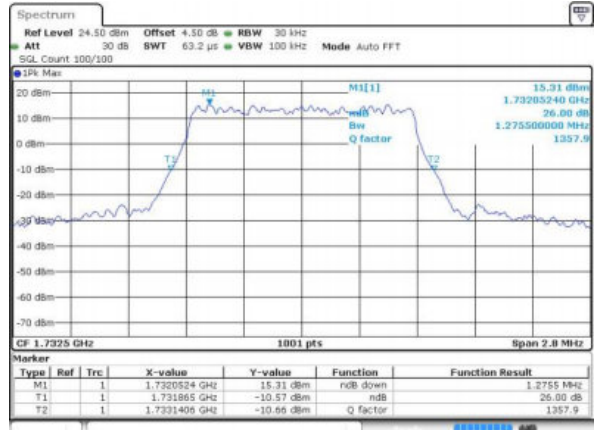

Date: 19 MAR 2016 09:08:35

Highest Channel / 1.4MHz / QPSK

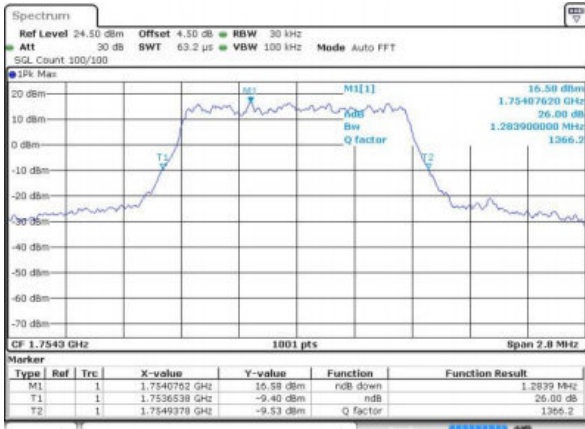

Date: 19 MAR 2016 09:10:57

Highest Channel / 1.4MHz / 16QAM

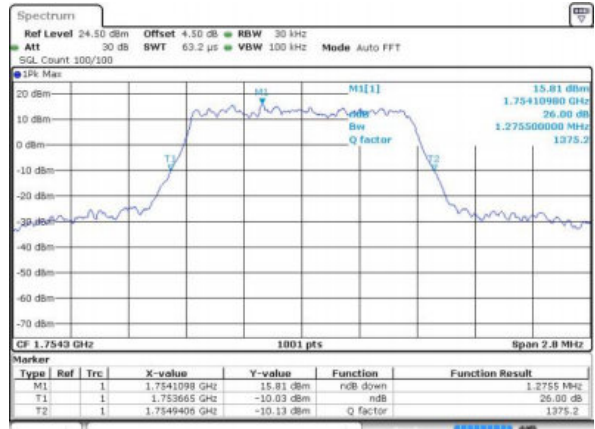

Date: 19 MAR 2016 09:11:08



LTE Band 4

Lowest Channel / 3MHz / QPSK

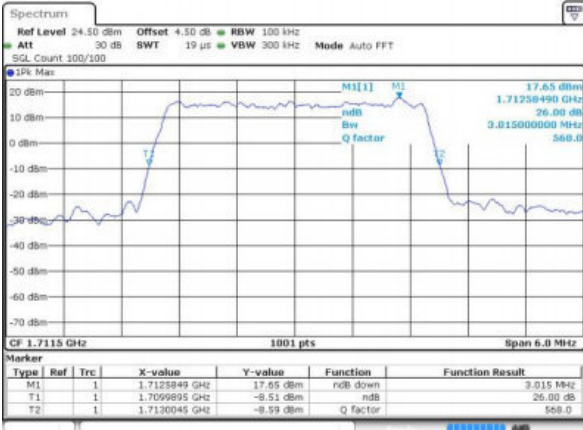

Date: 19 MAR 2016 09:18:01

Lowest Channel / 3MHz / 16QAM

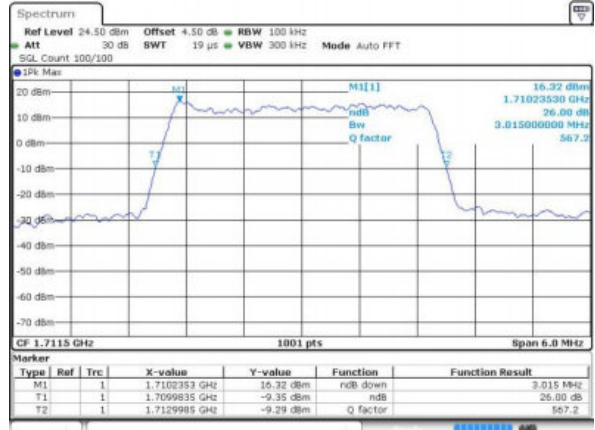

Date: 19 MAR 2016 08:18:12

Middle Channel / 3MHz / QPSK

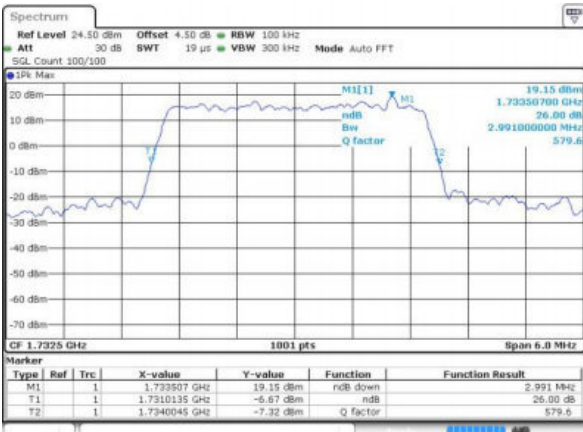

Date: 19 MAR 2016 14:00:31

Middle Channel / 3MHz / 16QAM

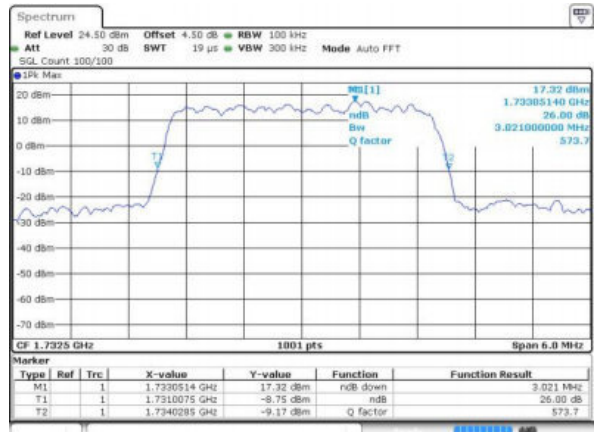

Date: 19 MAR 2016 14:00:01

Highest Channel / 3MHz / QPSK

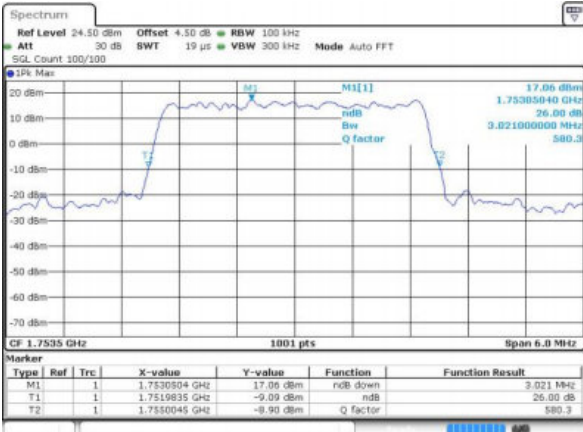

Date: 19 MAR 2016 09:27:38

Highest Channel / 3MHz / 16QAM



Date: 19 MAR 2016 09:27:49



LTE Band 4

Lowest Channel / 5MHz / QPSK

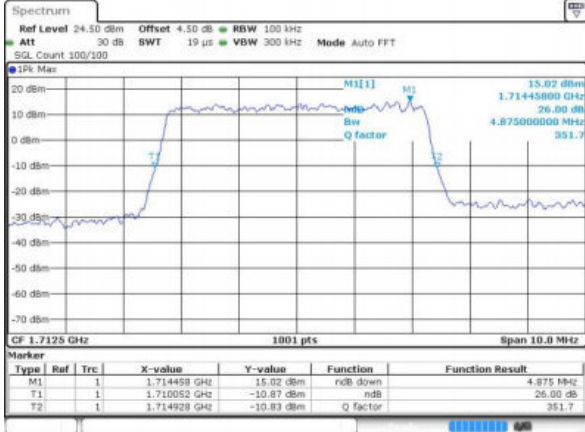

Date: 19 MAR 2016 09:34:42

Lowest Channel / 5MHz / 16QAM

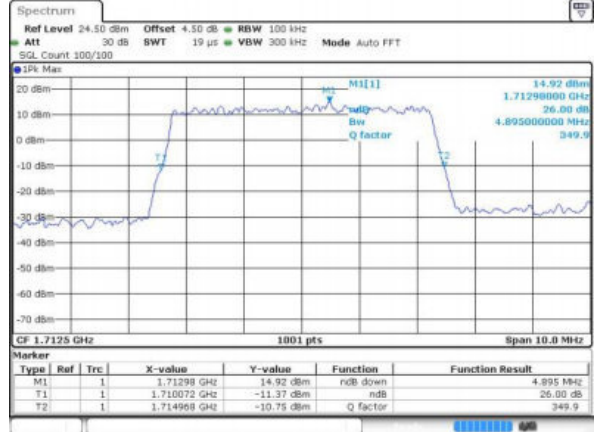

Date: 19 MAR 2016 09:34:53

Middle Channel / 5MHz / QPSK

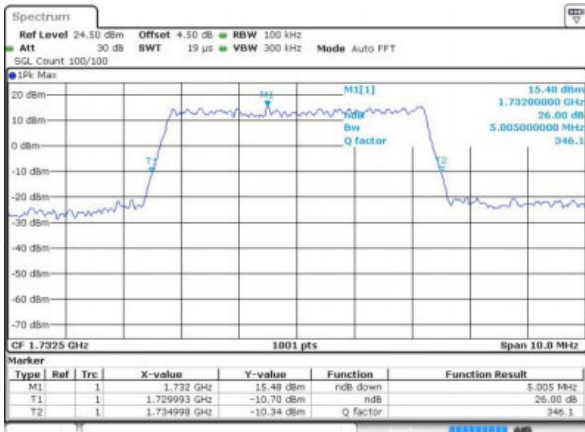

Date: 19 MAR 2016 14:03:10

Middle Channel / 5MHz / 16QAM

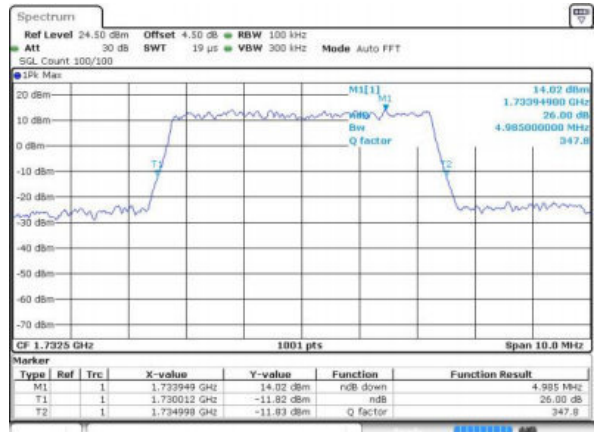

Date: 19 MAR 2016 09:41:57

Highest Channel / 5MHz / QPSK



Date: 19 MAR 2016 09:44:19

Highest Channel / 5MHz / 16QAM

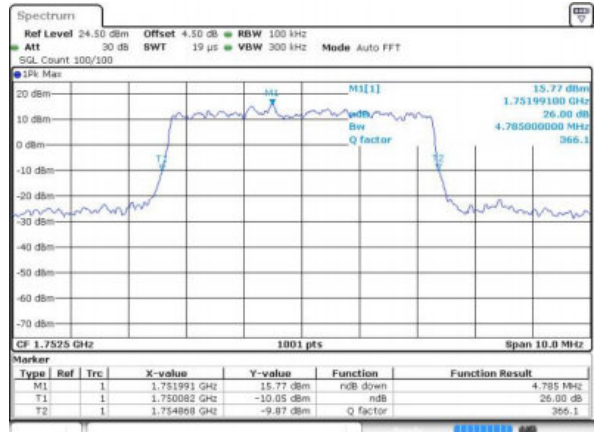

Date: 19 MAR 2016 09:44:30



LTE Band 4

Lowest Channel / 10MHz / QPSK



Date: 19 MAR 2016 14:04:38

Lowest Channel / 10MHz / 16QAM

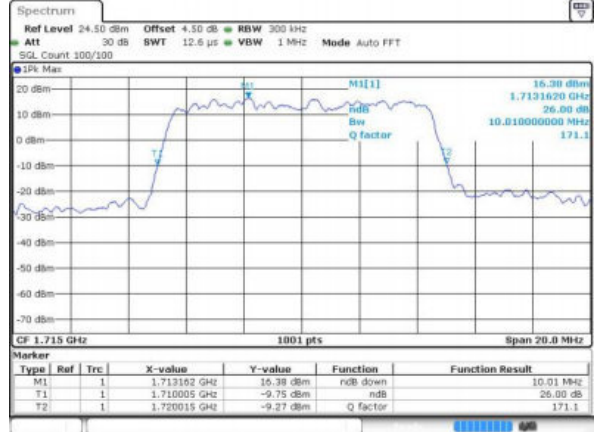

Date: 19 MAR 2016 09:51:43

Middle Channel / 10MHz / QPSK



Date: 19 MAR 2016 09:58:36

Middle Channel / 10MHz / 16QAM



Date: 19 MAR 2016 09:58:47

Highest Channel / 10MHz / QPSK



Date: 19 MAR 2016 10:01:09

Highest Channel / 10MHz / 16QAM



Date: 19 MAR 2016 10:01:19



LTE Band 4

Lowest Channel / 15MHz / QPSK

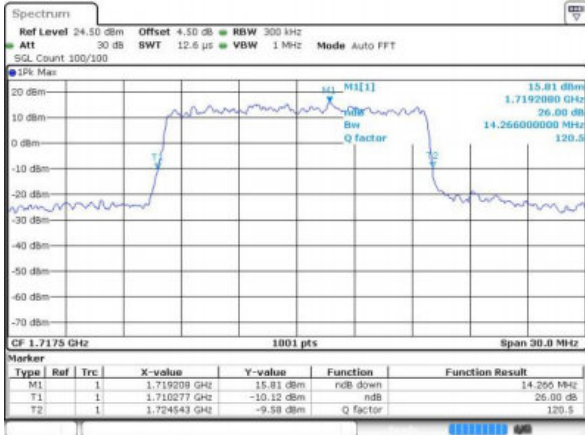

Date: 19 MAR 2016 11:30:59

Lowest Channel / 15MHz / 16QAM

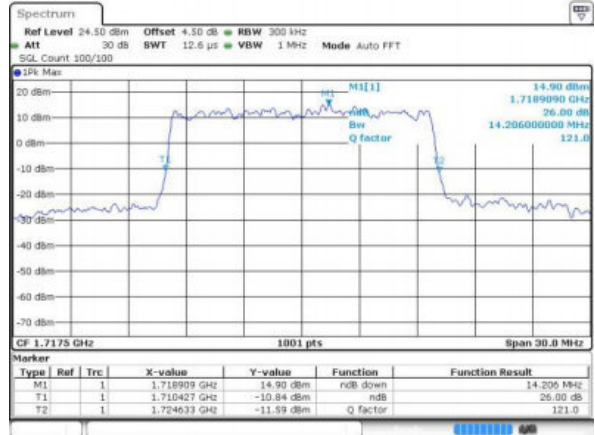

Date: 19 MAR 2016 11:31:10

Middle Channel / 15MHz / QPSK

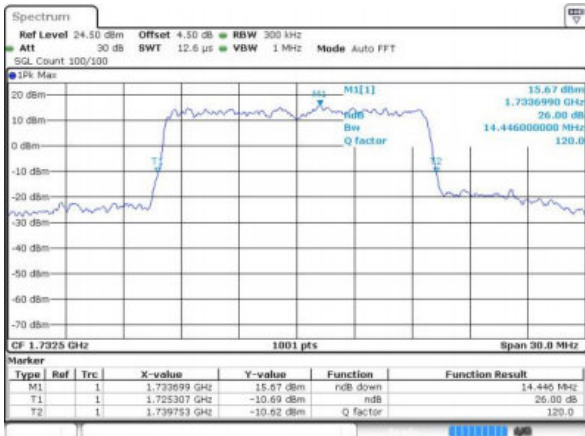

Date: 19 MAR 2016 11:31:41

Middle Channel / 15MHz / 16QAM

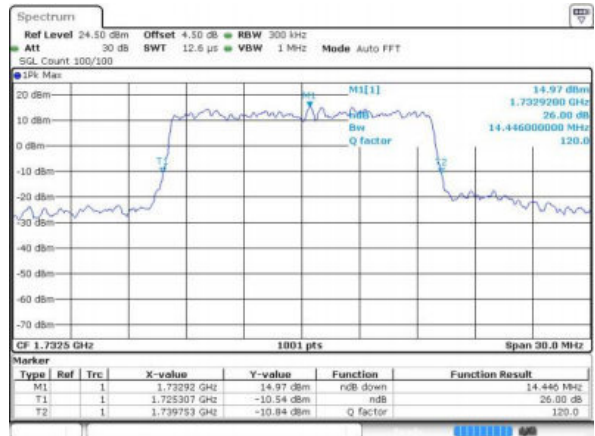

Date: 19 MAR 2016 11:31:51

Highest Channel / 15MHz / QPSK

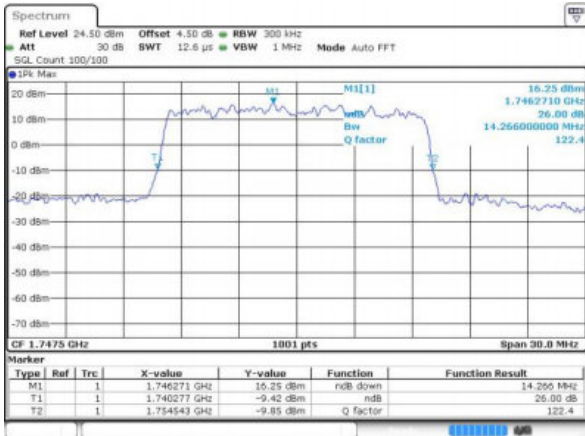

Date: 19 MAR 2016 11:32:23

Highest Channel / 15MHz / 16QAM

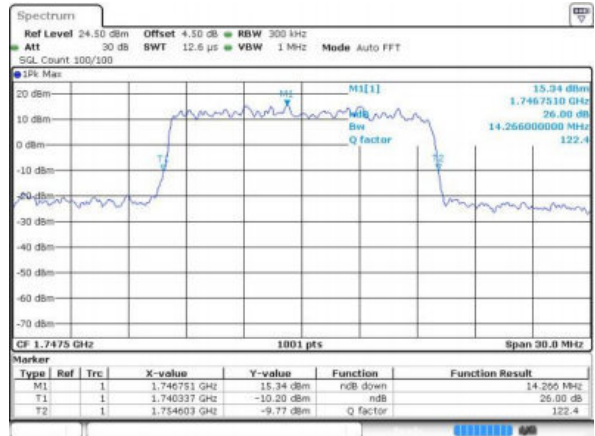

Date: 19 MAR 2016 11:36:07



LTE Band 4

Lowest Channel / 20MHz / QPSK

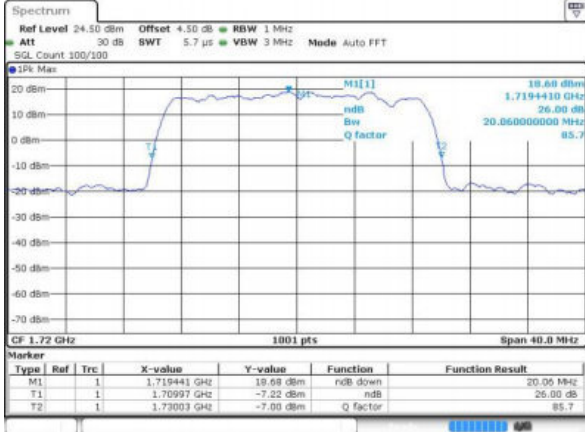

Date: 19 MAR 2016 11:40:37

Lowest Channel / 20MHz / 16QAM



Date: 19 MAR 2016 11:40:48

Middle Channel / 20MHz / QPSK

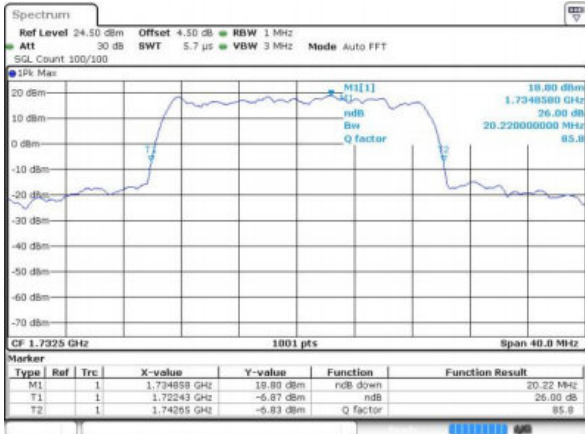

Date: 19 MAR 2016 11:48:10

Middle Channel / 20MHz / 16QAM

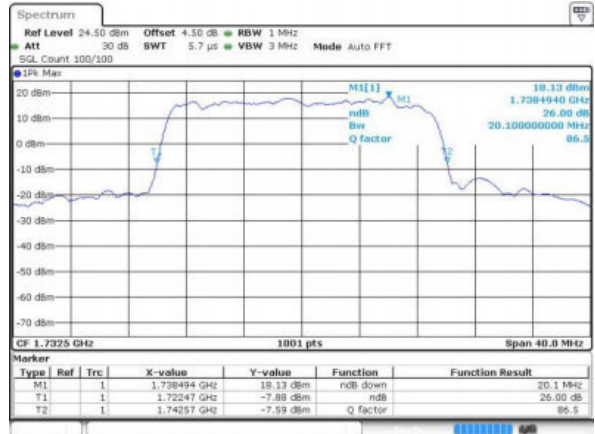

Date: 19 MAR 2016 11:41:30

Highest Channel / 20MHz / QPSK

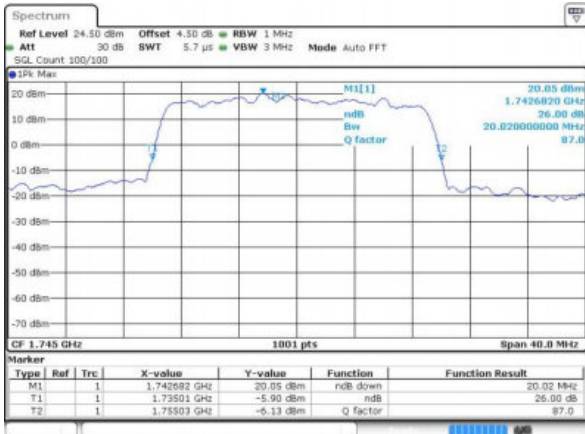

Date: 19 MAR 2016 11:42:40

Highest Channel / 20MHz / 16QAM



Date: 19 MAR 2016 11:42:50