

FCC Test Report (Part 22)

Report No.: RF171206E01C

FCC ID: NKRM14Q2SG

Test Model: M14Q2SG

Received Date: Jan. 02, 2019

Test Date: Jan. 03 ~ Jan. 15, 2019

Issued Date: Jan. 23, 2019

Applicant: Wistron NeWeb Corporation

Address: 20 Park Ave. II, Hsinchu Science Park, Hsichu 308, Taiwan

Issued By: Bureau Veritas Consumer Products Services (H.K.) Ltd., Taoyuan Branch

Lab Address: No. 47-2, 14th Ling, Chia Pau Vil., Lin Kou Dist., New Taipei City, Taiwan
(R.O.C.)

Test Location: No. 19, Hwa Ya 2nd Rd., Wen Hwa Vil., Kwei Shan Dist., Taoyuan City
33383, TAIWAN (R.O.C.)

FCC Registration / 788550 / TW0003

Designation Number:



This report is for your exclusive use. Any copying or replication of this report to or for any other person or entity, or use of our name or trademark, is permitted only with our prior written permission. This report sets forth our findings solely with respect to the test samples identified herein. The results set forth in this report are not indicative or representative of the quality or characteristics of the lot from which a test sample was taken or any similar or identical product unless specifically and expressly noted. Our report includes all of the tests requested by you and the results thereof based upon the information that you provided to us. You have 60 days from date of issuance of this report to notify us of any material error or omission caused by our negligence, provided, however, that such notice shall be in writing and shall specifically address the issue you wish to raise. A failure to raise such issue within the prescribed time shall constitute your unqualified acceptance of the completeness of this report, the tests conducted and the correctness of the report contents. Unless specific mention, the uncertainty of measurement has been explicitly taken into account to declare the compliance or non-compliance to the specification. The report must not be used by the client to claim product certification, approval, or endorsement by TAF or any government agencies

Table of Contents

Release Control Record	4
1 Certificate of Conformity	5
2 Summary of Test Results	6
2.1 Measurement Uncertainty.....	6
2.2 Test Site and Instruments.....	7
3 General Information	8
3.1 General Description of EUT.....	8
3.2 Configuration of System under Test.....	9
3.2.1 Description of Support Units.....	9
3.3 Test Mode Applicability and Tested Channel Detail.....	10
3.4 EUT Operating Conditions.....	13
3.5 General Description of Applied Standards.....	13
4 Test Types and Results	14
4.1 Output Power Measurement.....	14
4.1.1 Limits of Output Power Measurement.....	14
4.1.2 Test Procedures.....	14
4.1.3 Test Setup.....	15
4.1.4 Test Results.....	16
4.2 Modulation Characteristics Measurement.....	28
4.2.1 Limits of Modulation Characteristics.....	28
4.2.2 Test Procedure.....	28
4.2.3 Test Setup.....	28
4.2.4 Test Results.....	28
4.3 Frequency Stability Measurement.....	29
4.3.1 Limits of Frequency Stability Measurement.....	29
4.3.2 Test Procedure.....	29
4.3.3 Test Setup.....	29
4.3.4 Test Results.....	30
4.4 Occupied Bandwidth Measurement.....	35
4.4.1 Test Procedure.....	35
4.4.2 Test Setup.....	35
4.4.3 Test Result.....	36
4.5 Band Edge Measurement.....	40
4.5.1 Limits of Band Edge Measurement.....	40
4.5.2 Test Setup.....	40
4.5.3 Test Procedures.....	40
4.5.4 Test Results.....	41
4.6 Peak to Average Ratio.....	46
4.6.1 Limits of Peak to Average Ratio Measurement.....	46
4.6.2 Test Setup.....	46
4.6.3 Test Procedures.....	46
4.6.4 Test Results.....	47
4.7 Conducted Spurious Emissions.....	49
4.7.1 Limits of Conducted Spurious Emissions Measurement.....	49
4.7.2 Test Setup.....	49
4.7.3 Test Procedure.....	49
4.7.4 Test Results.....	50
4.8 Radiated Emission Measurement.....	65
4.8.1 Limits of Radiated Emission Measurement.....	65
4.8.2 Test Procedure.....	65
4.8.3 Deviation from Test Standard.....	65
4.8.4 Test Setup.....	66
4.8.5 Test Results.....	67

5	Pictures of Test Arrangements.....	79
	Appendix – Information of the Testing Laboratories	80

Release Control Record

Issue No.	Description	Date Issued
RF171206E01C	Original release	Jan. 23, 2019

1 Certificate of Conformity

Product: LGA Module

Brand: Wistron NeWeb Corporation

Test Model: M14Q2SG

Sample Status: Engineering sample

Applicant: Wistron NeWeb Corporation

Test Date: Jan. 03 ~ Jan. 15, 2019

Standards: FCC Part 22, Subpart H

The above equipment has been tested by **Bureau Veritas Consumer Products Services (H.K.) Ltd., Taoyuan Branch**, and found compliance with the requirement of the above standards. The test record, data evaluation & Equipment Under Test (EUT) configurations represented herein are true and accurate accounts of the measurements of the sample's RF characteristics under the conditions specified in this report.

Prepared by : Celine Chou , **Date:** Jan. 23, 2019
Celine Chou / Senior Specialist

Approved by : Bruce Chen , **Date:** Jan. 23, 2019
Bruce Chen / Project Engineer

2 Summary of Test Results

Applied Standard: FCC Part 22 & Part 2			
FCC Clause	Test Item	Result	Remarks
2.1046 22.913 (a)	Effective radiated power	Pass	Meet the requirement of limit.
2.1047	Modulation Characteristics	Pass	Meet the requirement
---	Peak To Average Ratio	Pass	Meet the requirement of limit.
2.1055 22.355	Frequency Stability	Pass	Meet the requirement of limit.
2.1049	Occupied Bandwidth	Pass	Meet the requirement of limit.
22.917	Band Edge Measurements	Pass	Meet the requirement of limit.
2.1051 22.917	Conducted Spurious Emissions	Pass	Meet the requirement of limit.
2.1053 22.917	Radiated Spurious Emissions	Pass	Meet the requirement of limit. Minimum passing margin is -31.6dB at 142.52MHz.

Note: Determining compliance based on the results of the compliance measurement, not taking into account measurement instrumentation uncertainty.

2.1 Measurement Uncertainty

Where relevant, the following measurement uncertainty levels have been estimated for tests performed on the EUT as specified in CISPR 16-4-2:

Measurement	Frequency	Expanded Uncertainty (k=2) (±)
Radiated Emissions up to 1 GHz	30MHz ~ 200MHz	3.63 dB
	200MHz ~1000MHz	3.64 dB
Radiated Emissions above 1 GHz	1GHz ~ 18GHz	2.29 dB
	18GHz ~ 40GHz	2.29 dB

2.2 Test Site and Instruments

Description & Manufacturer	Model No.	Serial No.	Cal. Date	Cal. Due
Test Receiver ROHDE & SCHWARZ	ESIB7	100187	May 29, 2018	May 28, 2019
Spectrum Analyzer ROHDE & SCHWARZ	FSP40	100040	Sep. 25, 2018	Sep. 24, 2019
BILOG Antenna SCHWARZBECK	VULB9168	9168-155	Nov. 21, 2018	Nov. 20, 2019
HORN Antenna SCHWARZBECK	BBHA 9120D	9120D-1170	Nov. 25, 2018	Nov. 24, 2019
HORN Antenna SCHWARZBECK	BBHA 9170	BBHA9170241	Nov. 25, 2018	Nov. 24, 2019
Preamplifier Agilent (Below 1GHz)	8447D	2944A10631	Aug. 08, 2018	Aug. 07, 2019
Preamplifier KEYSIGHT (Above 1GHz)	83017A	MY53270295	Jul. 02, 2018	Jul. 01, 2019
RF signal cable HUBER+SUHNER	SUCOFLEX 104	MY 13380+295012/04	Aug. 08, 2018	Aug. 07, 2019
RF signal cable HUBER+SUHNER	SUCOFLEX 104	Cable-CH4-03 (250724)	Aug. 08, 2018	Aug. 07, 2019
Software BV ADT	ADT_Radiated_ V7.6.15.9.5	NA	NA	NA
Antenna Tower inn-co GmbH	MA 4000	010303	NA	NA
Antenna Tower Controller BV ADT	AT100	AT93021703	NA	NA
Turn Table BV ADT	TT100	TT93021703	NA	NA
Turn Table Controller BV ADT	SC100	SC93021703	NA	NA
Boresight Antenna Fixture	FBA-01	FBA-SIP01	NA	NA
WIT Standard Temperature And Humidity Chamber	TH-4S-C	W981030	Jun. 04, 2018	Jun. 03, 2019
JFW 20dB attenuation	50HF-020-SMA	NA	NA	NA

- Note:
1. The calibration interval of the above test instruments is 12 months and the calibrations are traceable to NML/ROC and NIST/USA.
 2. The test was performed in HwaYa Chamber 4.
 3. The FCC Designation Number is TW0003. The number will be varied with the Lab location and scope as attached.
 4. The IC Site Registration No. is 7450F-4.

3 General Information

3.1 General Description of EUT

Product	LGA Module		
Brand	Wistron NeWeb Corporation		
Test Model	M14Q2SG		
Sample Status	Engineering sample		
Power Supply Rating	5Vdc (Host equipment)		
Modulation Type	QPSK, 16QAM		
Operating Frequency	LTE Band 26 (Channel Bandwidth 1.4MHz)	824.7~848.3MHz	
	LTE Band 26 (Channel Bandwidth 3MHz)	825.5~847.5MHz	
	LTE Band 26 (Channel Bandwidth 5MHz)	826.5~846.5MHz	
	LTE Band 26 (Channel Bandwidth 10MHz)	829.0~844.0MHz	
	LTE Band 26 (Channel Bandwidth 15MHz)	831.5~841.5MHz	
Max. ERP Power		QPSK	16QAM
	LTE Band 26 (Channel Bandwidth 1.4MHz)	229.087mW (23.6dBm)	181.970mW (22.6dBm)
	LTE Band 26 (Channel Bandwidth 3MHz)	234.423mW (23.7dBm)	186.209mW (22.7dBm)
	LTE Band 26 (Channel Bandwidth 5MHz)	218.776mW (23.4dBm)	177.828mW (22.5dBm)
	LTE Band 26 (Channel Bandwidth 10MHz)	229.087mW (23.6dBm)	186.209mW (22.7dBm)
	LTE Band 26 (Channel Bandwidth 15MHz)	229.087mW (23.6dBm)	186.209mW (22.7dBm)
Emission Designator		QPSK	16QAM
	LTE Band 26 (Channel Bandwidth 1.4MHz)	1M08G7D	1M09W7D
	LTE Band 26 (Channel Bandwidth 3MHz)	2M70G7D	2M69W7D
	LTE Band 26 (Channel Bandwidth 5MHz)	4M49G7D	4M49W7D
	LTE Band 26 (Channel Bandwidth 10MHz)	8M95G7D	8M95W7D
	LTE Band 26 (Channel Bandwidth 15MHz)	13M4G7D	13M4W7D
Antenna Type	Dipole antenna with -3.5dBi gain		
Antenna Connector	SMA		
Accessory Device	NA		
Cable Supplied	NA		

Note: The EUT uses following adapter. (For support unit only)

Brand	I.T.E POWER SUPPLY
Model	MU24-Y120200-A1
Input Power	100-240Vac, 50/60Hz, 0.7A
Output Power	12Vdc, 2A
Power Line	1.5m cable without core attached on adapter

3.2 Configuration of System under Test

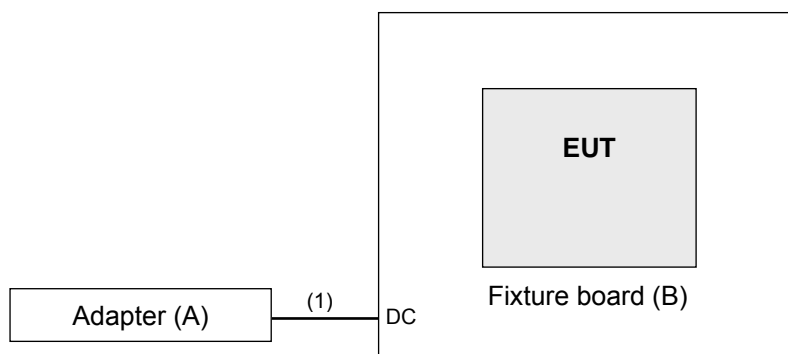

Remote site



3.2.1 Description of Support Units

The EUT has been tested as an independent unit together with other necessary accessories or support units. The following support units or accessories were used to form a representative test configuration during the tests.

ID	Product	Brand	Model No.	Serial No.	FCC ID	Remarks
A.	Adapter	I.T.E POWER SUPPLY	MU24-Y120200-A1	NA	NA	Provided by manufacturer
B.	Fixture board	NA	NA	NA	NA	Provided by manufacturer
C.	Radio Communication Analyzer	Anritsu	MT8860C	1702001	NA	-

Note:

1. All power cords of the above support units are non-shielded (1.8m).
2. Item A acted as a communication partner to transfer data.

ID	Descriptions	Qty.	Length (m)	Shielding (Yes/No)	Cores (Qty.)	Remarks
1.	DC cable	1	1.5	-	0	Attached on adapter

3.3 Test Mode Applicability and Tested Channel Detail

Pre-Scan has been conducted to determine the worst-case mode from all possible combinations between available modulations, data rates, XYZ axis and antenna ports. The worst case was found when positioned on X-plane. Following channel(s) was (were) selected for the final test as listed below.

LTE Band 26

EUT Configure Mode	Test item	Available channel	Tested channel	Channel Bandwidth	Modulation	Mode
-	ERP	26797 to 27033	26797 (824.7MHz), 26915 (836.5MHz), 27033 (848.3MHz)	1.4MHz	QPSK / 16QAM	1 RB / 0 RB Offset
		26805 to 27025	26805 (825.5MHz), 26915 (836.5MHz), 27025 (847.5MHz)	3MHz	QPSK / 16QAM	1 RB / 0 RB Offset
		26815 to 27015	26815 (826.5MHz), 26915 (836.5MHz), 27015 (846.5MHz)	5MHz	QPSK / 16QAM	1 RB / 0 RB Offset
		26840 to 26990	26840 (829MHz), 26915 (836.5MHz), 26990 (844MHz)	10MHz	QPSK / 16QAM	1 RB / 0 RB Offset
		26865 to 26965	26865 (831.5MHz), 26915 (836.5MHz), 26965 (841.5MHz)	15MHz	QPSK / 16QAM	1 RB / 0 RB Offset
-	Modulation Characteristics	26865 to 26965	26865 (831.5MHz)	15MHz	QPSK / 16QAM	75 RB / 0 RB Offset
-	Frequency Stability	26797 to 27033	26797 (824.7MHz), 27033 (848.3MHz)	1.4MHz	QPSK	1 RB / 0 RB Offset
		26805 to 27025	26805 (825.5MHz), 27025 (847.5MHz)	3MHz	QPSK	1 RB / 0 RB Offset
		26815 to 27015	26815 (826.5MHz), 27015 (846.5MHz)	5MHz	QPSK	1 RB / 0 RB Offset
		26840 to 26990	26840 (829MHz), 26990 (844MHz)	10MHz	QPSK	1 RB / 0 RB Offset
		26865 to 26965	26865 (831.5MHz), 26965 (841.5MHz)	15MHz	QPSK	1 RB / 0 RB Offset
-	Occupied Bandwidth	26797 to 27033	26797 (824.7MHz), 26915 (836.5MHz), 27033 (848.3MHz)	1.4MHz	QPSK / 16QAM	6 RB / 0 RB Offset
		26805 to 27025	26805 (825.5MHz), 26915 (836.5MHz), 27025 (847.5MHz)	3MHz	QPSK / 16QAM	15 RB / 0 RB Offset
		26815 to 27015	26815 (826.5MHz), 26915 (836.5MHz), 27015 (846.5MHz)	5MHz	QPSK / 16QAM	25 RB / 0 RB Offset
		26840 to 26990	26840 (829MHz), 26915 (836.5MHz), 26990 (844MHz)	10MHz	QPSK / 16QAM	50 RB / 0 RB Offset
		26865 to 26965	26865 (831.5MHz), 26915 (836.5MHz), 26965 (841.5MHz)	15MHz	QPSK / 16QAM	75 RB / 0 RB Offset

EUT Configure Mode	Test item	Available channel	Tested channel	Channel Bandwidth	Modulation	Mode
-	Band Edge	26797 to 27033	26797 (824.7MHz), 27033 (848.3MHz)	1.4MHz	QPSK	1 RB / 0 RB Offset 1 RB / 5 RB Offset 6 RB / 0 RB Offset
		26805 to 27025	26805 (825.5MHz), 27025 (847.5MHz)	3MHz	QPSK	1 RB / 0 RB Offset 1 RB / 14 RB Offset 15 RB / 0 RB Offset
		26815 to 27015	26815 (826.5MHz), 27015 (846.5MHz)	5MHz	QPSK	1 RB / 0 RB Offset 1 RB / 24 RB Offset 25 RB / 0 RB Offset
		26840 to 26990	26840 (829MHz), 26990 (844MHz)	10MHz	QPSK	1 RB / 0 RB Offset 1 RB / 49 RB Offset 50 RB / 0 RB Offset
		26865 to 26965	26865 (831.5MHz), 26965 (841.5MHz)	15MHz	QPSK	1 RB / 0 RB Offset 1 RB / 74 RB Offset 75 RB / 0 RB Offset
-	Peak to Average Ratio	26797 to 27033	26797 (824.7MHz), 26915 (836.5MHz), 27033 (848.3MHz)	1.4MHz	QPSK / 16QAM	1 RB / 0 RB Offset
		26805 to 27025	26805 (825.5MHz), 26915 (836.5MHz), 27025 (847.5MHz)	3MHz	QPSK / 16QAM	1 RB / 0 RB Offset
		26815 to 27015	26815 (826.5MHz), 26915 (836.5MHz), 27015 (846.5MHz)	5MHz	QPSK / 16QAM	1 RB / 0 RB Offset
		26840 to 26990	26840 (829MHz), 26915 (836.5MHz), 26990 (844MHz)	10MHz	QPSK / 16QAM	1 RB / 0 RB Offset
		26865 to 26965	26865 (831.5MHz), 26915 (836.5MHz), 26965 (841.5MHz)	15MHz	QPSK / 16QAM	1 RB / 0 RB Offset
-	Conducted Emission	26797 to 27033	26797 (824.7MHz), 26915 (836.5MHz), 27033 (848.3MHz)	1.4MHz	QPSK	1 RB / 0 RB Offset
		26805 to 27025	26805 (825.5MHz), 26915 (836.5MHz), 27025 (847.5MHz)	3MHz	QPSK	1 RB / 0 RB Offset
		26815 to 27015	26815 (826.5MHz), 26915 (836.5MHz), 27015 (846.5MHz)	5MHz	QPSK	1 RB / 0 RB Offset
		26840 to 26990	26840 (829MHz), 26915 (836.5MHz), 26990 (844MHz)	10MHz	QPSK	1 RB / 0 RB Offset
		26865 to 26965	26865 (831.5MHz), 26915 (836.5MHz), 26965 (841.5MHz)	15MHz	QPSK	1 RB / 0 RB Offset

EUT Configure Mode	Test item	Available channel	Tested channel	Channel Bandwidth	Modulation	Mode
-	Radiated Emission Below 1GHz	26797 to 27033	26797 (824.7MHz)	1.4MHz	QPSK	1 RB / 0 RB Offset
		26815 to 27015	26815 (826.5MHz)	5MHz	QPSK	1 RB / 0 RB Offset
		26865 to 26965	26865 (831.5MHz)	15MHz	QPSK	1 RB / 0 RB Offset
-	Radiated Emission Above 1GHz	26797 to 27033	26797 (824.7MHz), 26915 (836.5MHz), 27033 (848.3MHz)	1.4MHz	QPSK	1 RB / 0 RB Offset
		26815 to 27015	26815 (826.5MHz), 26915 (836.5MHz), 27015 (846.5MHz)	5MHz	QPSK	1 RB / 0 RB Offset
		26865 to 26965	26865 (831.5MHz), 26915 (836.5MHz), 26965 (841.5MHz)	15MHz	QPSK	1 RB / 0 RB Offset

Note:

- For radiated emission above 1GHz, according to 3GPP 36.521 Section 6.6.3.1.4, choose the lowest, 5MHz & highest channel bandwidth for final test.
- For radiated emission below 1GHz, low, mid and high channels were pre-tested in chamber. Low channel was the worst case for all final tests.
- The conducted output power for QPSK and 16QAM, measured value of QPSK is higher than 16QAM mode. Therefore, only ERP, Modulation Characteristics, Emission Bandwidth and Peak to average ratio had been tested under QPSK and 16QAM modes, the other test items were performed under QPSK mode only.

Test Condition:

Test Item	Environmental Conditions	Input Power (system)	Tested By
ERP	25deg. C, 70%RH	120Vac, 60Hz	Noah Chang
Modulation Characteristics	24deg. C, 64%RH	120Vac, 60Hz	James Yang
Frequency Stability	24deg. C, 64%RH	5Vdc	James Yang
Occupied Bandwidth	24deg. C, 64%RH	120Vac, 60Hz	James Yang
Band Edge	24deg. C, 64%RH	120Vac, 60Hz	James Yang
Peak To Average Ratio	24deg. C, 64%RH	120Vac, 60Hz	James Yang
Conducted Emission	24deg. C, 64%RH	120Vac, 60Hz	James Yang
Radiated Emission	25deg. C, 70%RH	120Vac, 60Hz	Noah Chang

3.4 EUT Operating Conditions

The EUT makes a call to the communication simulator. The communication simulator station system controlled a EUT to export maximum output power under transmission mode and specific channel frequency

3.5 General Description of Applied Standards

The EUT is a RF Product. According to the specifications of the manufacturer, it must comply with the requirements of the following standards:

FCC 47 CFR Part 2

FCC 47 CFR Part 22

KDB 971168 D01 Power Meas License Digital Systems v03r01

ANSI/TIA/EIA-603-E 2016

ANSI 63.26-2015

All test items have been performed and recorded as per the above standards.

4 Test Types and Results

4.1 Output Power Measurement

4.1.1 Limits of Output Power Measurement

Mobile / Portable station are limited to 7 watts e.r.p.

4.1.2 Test Procedures

EIRP / ERP Measurement:

- a. All measurements were done at low, middle and high operational frequency range. RBW and VBW is 10MHz for LTE mode.
- b. Substitution method is used for E.I.R.P measurement. In the semi-anechoic chamber, EUT placed on the 0.8m(below or equal 1GHz) and/or 1.5m(above 1GHz) height of Turn Table, rotated the table around 360 degrees to search the maximum radiation power and receiver antenna shall be rotated vertical and horizontal polarization and moved height from 1m to 4m to find the maximum polar radiated power. The "Read Value" is the spectrum reading the maximum power value.
- c. The substitution horn antenna is substituted for EUT at the same position and signals generator export the CW signal to the substitution antenna via a TX cable. Rotated the Turn Table and moved receiving antenna to find the maximum radiation power. Adjust output power level of S.G to get a Value of spectrum reading equal to "Read Value" of step b. Record the power level of S.G
- d. EIRP = Output power level of S.G – TX cable loss + Antenna gain of substitution horn. E.R.P power can be calculated form E.I.R.P power by subtracting the gain of dipole, E.R.P power = E.I.R.P power - 2.15dBi.

Where:

$$ERP/EIRP = P_{Meas} + G_T - L_C$$

P_{Meas} : Measure transmitter output power.

G_T : Gain of the transmitting antenna.

L_C : signal attenuation in the connecting cable between the transmitter and antenna.

Conducted Power Measurement:

The EUT was set up for the maximum power with LTE link data modulation and link up with simulator. Set the EUT to transmit under low, middle and high channel and record the power level shown on simulator.

4.1.3 Test Setup

EIRP / ERP Measurement:

For radiated emission 30MHz to 1GHz

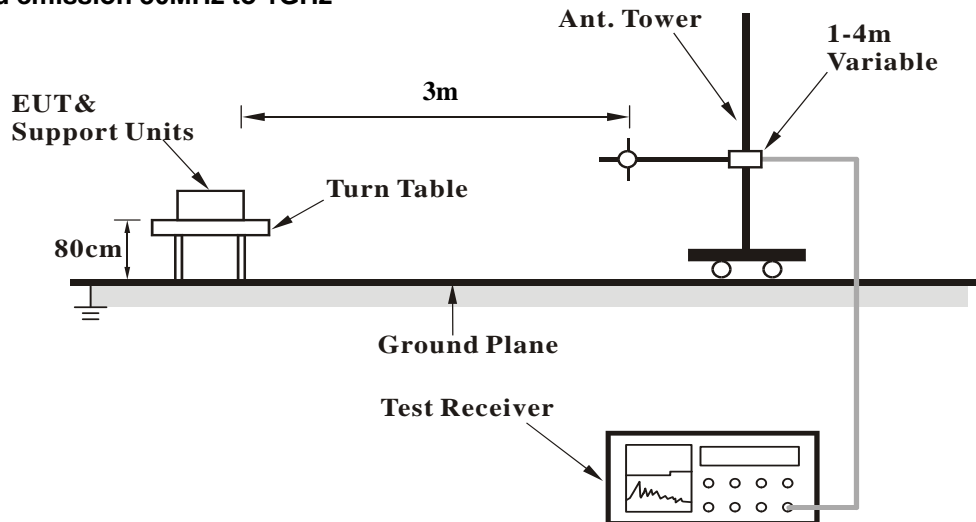

For radiated emission above 1GHz

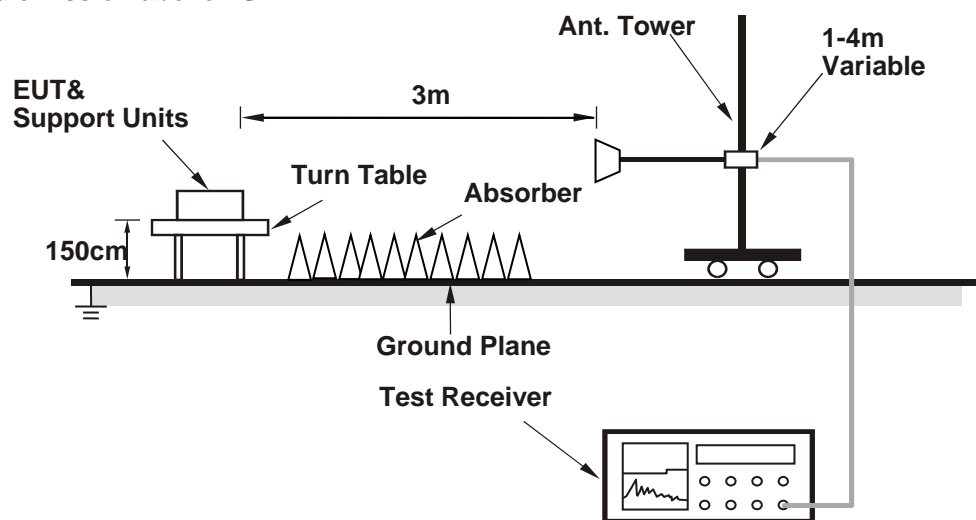

For the actual test configuration, please refer to the attached file (Test Setup Photo).

Conducted Power Measurement:



For the actual test configuration, please refer to the attached file (Test Setup Photo).

4.1.4 Test Results

Conducted Output Power (dBm)

Band / BW	RB Size	RB Offset	QPSK			16QAM		
			Low CH 26797	Mid CH 26915	High CH 27033	Low CH 26797	Mid CH 26915	High CH 27033
			824.7 MHz	836.5 MHz	848.3 MHz	824.7 MHz	836.5 MHz	848.3 MHz
26 / 1.4M	1	0	23.61	23.68	23.37	23.63	23.76	23.34
	1	2	23.61	23.53	23.50	23.66	23.61	23.50
	1	5	23.65	23.51	23.41	23.60	23.55	23.33
	3	0	22.66	22.57	22.45	22.53	22.36	22.10
	3	1	22.48	22.67	22.54	22.87	22.59	22.26
	3	3	22.46	22.69	22.44	22.83	22.68	22.35
	6	0	22.80	22.46	22.50	21.88	21.62	21.37
Band / BW	RB Size	RB Offset	QPSK			16QAM		
			Low CH 26805	Mid CH 26915	High CH 27025	Low CH 26805	Mid CH 26915	High CH 27025
			825.5 MHz	836.5 MHz	847.5 MHz	825.5 MHz	836.5 MHz	847.5 MHz
26 / 3M	1	0	23.67	23.91	23.50	22.71	22.93	22.63
	1	7	23.51	23.83	23.83	22.85	22.61	22.61
	1	14	23.73	23.61	23.61	22.81	22.62	22.62
	8	0	22.82	22.68	22.68	22.60	22.62	22.35
	8	3	22.45	22.49	22.41	21.47	21.59	21.58
	8	7	22.53	22.76	22.60	21.79	21.55	21.45
	15	0	21.76	21.64	21.45	21.72	21.69	21.51
Band / BW	RB Size	RB Offset	QPSK			16QAM		
			Low CH 26815	Mid CH 26915	High CH 27015	Low CH 26815	Mid CH 26915	High CH 27015
			826.5 MHz	836.5 MHz	846.5 MHz	826.5 MHz	836.5 MHz	846.5 MHz
26 / 5M	1	0	23.63	23.88	23.47	22.73	22.81	22.57
	1	12	23.70	23.83	23.78	22.77	22.72	22.51
	1	24	23.68	23.51	23.34	22.79	22.61	22.51
	12	0	22.73	22.64	22.49	22.56	22.47	22.22
	12	6	22.49	22.29	22.46	21.66	21.50	21.42
	12	13	22.89	22.74	22.30	21.85	21.62	21.46
	25	0	21.70	21.44	21.33	21.72	21.64	21.48

Band / BW	RB Size	RB Offset	QPSK			16QAM		
			Low CH 26840	Mid CH 26915	High CH 26990	Low CH 26840	Mid CH 26915	High CH 26990
			829 MHz	836.5 MHz	844 MHz	829 MHz	836.5 MHz	844 MHz
26 / 10M	1	0	22.50	23.80	22.74	22.20	22.98	22.79
	1	24	22.58	23.77	22.91	22.13	22.54	22.85
	1	49	22.67	23.79	22.87	22.54	22.86	22.74
	25	0	21.80	22.84	22.62	22.51	22.43	22.36
	25	12	21.65	22.61	22.17	21.68	21.55	21.54
	25	25	21.33	22.71	21.64	21.29	21.75	21.48
	50	0	20.98	21.62	21.58	21.58	21.62	21.63
Band / BW	RB Size	RB Offset	QPSK			16QAM		
			Low CH 26865	Mid CH 26915	High CH 26965	Low CH 26865	Mid CH 26915	High CH 26965
			831.5 MHz	836.5 MHz	841.5 MHz	831.5 MHz	836.5 MHz	841.5 MHz
26 / 15M	1	0	23.59	24.09	23.47	22.74	22.80	22.69
	1	37	23.58	23.77	23.69	22.70	22.65	22.66
	1	74	23.70	23.98	23.39	22.58	22.62	22.48
	36	0	22.54	22.36	22.56	22.66	22.33	21.73
	36	19	22.70	22.82	22.14	21.56	21.41	21.30
	36	39	22.96	22.90	22.49	21.58	21.40	21.22
	75	0	21.31	21.84	21.49	21.00	20.79	20.59

ERP Power

Modulation Type: QPSK

LTE Band 26, Channel Bandwidth 1.4MHz

MODE		TX channel 26797					
Antenna Polarity & Test Distance: Horizontal at 3 M							
No.	Freq. (MHz)	Reading (dBm)	S.G Power Value (dBm)	Correction Factor (dB)	ERP (dBm)	Limit (dBm)	Margin (dB)
1	824.70	-7.8	23.3	0.0	23.3	38.5	-15.2
Antenna Polarity & Test Distance: Vertical at 3 M							
No.	Freq. (MHz)	Reading (dBm)	S.G Power Value (dBm)	Correction Factor (dB)	ERP (dBm)	Limit (dBm)	Margin (dB)
1	824.70	-9.8	22.1	0.0	22.1	38.5	-16.4

MODE		TX channel 26915					
Antenna Polarity & Test Distance: Horizontal at 3 M							
No.	Freq. (MHz)	Reading (dBm)	S.G Power Value (dBm)	Correction Factor (dB)	ERP (dBm)	Limit (dBm)	Margin (dB)
1	836.50	-7.9	23.3	0.2	23.5	38.5	-15.0
Antenna Polarity & Test Distance: Vertical at 3 M							
No.	Freq. (MHz)	Reading (dBm)	S.G Power Value (dBm)	Correction Factor (dB)	ERP (dBm)	Limit (dBm)	Margin (dB)
1	836.50	-9.5	22.3	0.2	22.5	38.5	-16.0

MODE		TX channel 27033					
Antenna Polarity & Test Distance: Horizontal at 3 M							
No.	Freq. (MHz)	Reading (dBm)	S.G Power Value (dBm)	Correction Factor (dB)	ERP (dBm)	Limit (dBm)	Margin (dB)
1	848.30	-7.4	23.1	0.5	23.6	38.5	-14.9
Antenna Polarity & Test Distance: Vertical at 3 M							
No.	Freq. (MHz)	Reading (dBm)	S.G Power Value (dBm)	Correction Factor (dB)	ERP (dBm)	Limit (dBm)	Margin (dB)
1	848.30	-9.9	21.5	0.5	22.0	38.5	-16.5

Note: ERP (dBm) = S.G Power Value (dBm) + Correction Factor (dB).

LTE Band 26, Channel Bandwidth 3MHz

MODE		TX channel 26805					
Antenna Polarity & Test Distance: Horizontal at 3 M							
No.	Freq. (MHz)	Reading (dBm)	S.G Power Value (dBm)	Correction Factor (dB)	ERP (dBm)	Limit (dBm)	Margin (dB)
1	825.50	-7.4	23.7	0.0	23.7	38.5	-14.8
Antenna Polarity & Test Distance: Vertical at 3 M							
No.	Freq. (MHz)	Reading (dBm)	S.G Power Value (dBm)	Correction Factor (dB)	ERP (dBm)	Limit (dBm)	Margin (dB)
1	825.50	-9.7	22.2	0.0	22.2	38.5	-16.3

MODE		TX channel 26915					
Antenna Polarity & Test Distance: Horizontal at 3 M							
No.	Freq. (MHz)	Reading (dBm)	S.G Power Value (dBm)	Correction Factor (dB)	ERP (dBm)	Limit (dBm)	Margin (dB)
1	836.50	-8.2	23.0	0.2	23.2	38.5	-15.3
Antenna Polarity & Test Distance: Vertical at 3 M							
No.	Freq. (MHz)	Reading (dBm)	S.G Power Value (dBm)	Correction Factor (dB)	ERP (dBm)	Limit (dBm)	Margin (dB)
1	836.50	-9.9	21.9	0.2	22.1	38.5	-16.4

MODE		TX channel 27025					
Antenna Polarity & Test Distance: Horizontal at 3 M							
No.	Freq. (MHz)	Reading (dBm)	S.G Power Value (dBm)	Correction Factor (dB)	ERP (dBm)	Limit (dBm)	Margin (dB)
1	847.50	-7.4	23.2	0.4	23.6	38.5	-14.9
Antenna Polarity & Test Distance: Vertical at 3 M							
No.	Freq. (MHz)	Reading (dBm)	S.G Power Value (dBm)	Correction Factor (dB)	ERP (dBm)	Limit (dBm)	Margin (dB)
1	847.50	-9.4	21.9	0.4	22.3	38.5	-16.2

Note: ERP (dBm) = S.G Power Value (dBm) + Correction Factor (dB).

LTE Band 26, Channel Bandwidth 5MHz

MODE		TX channel 26815					
Antenna Polarity & Test Distance: Horizontal at 3 M							
No.	Freq. (MHz)	Reading (dBm)	S.G Power Value (dBm)	Correction Factor (dB)	ERP (dBm)	Limit (dBm)	Margin (dB)
1	826.50	-7.8	23.4	0.0	23.4	38.5	-15.1
Antenna Polarity & Test Distance: Vertical at 3 M							
No.	Freq. (MHz)	Reading (dBm)	S.G Power Value (dBm)	Correction Factor (dB)	ERP (dBm)	Limit (dBm)	Margin (dB)
1	826.50	-9.9	22.0	0.0	22.0	38.5	-16.5

MODE		TX channel 26915					
Antenna Polarity & Test Distance: Horizontal at 3 M							
No.	Freq. (MHz)	Reading (dBm)	S.G Power Value (dBm)	Correction Factor (dB)	ERP (dBm)	Limit (dBm)	Margin (dB)
1	836.50	-8.2	22.9	0.2	23.1	38.5	-15.4
Antenna Polarity & Test Distance: Vertical at 3 M							
No.	Freq. (MHz)	Reading (dBm)	S.G Power Value (dBm)	Correction Factor (dB)	ERP (dBm)	Limit (dBm)	Margin (dB)
1	836.50	-9.6	22.2	0.2	22.4	38.5	-16.1

MODE		TX channel 27015					
Antenna Polarity & Test Distance: Horizontal at 3 M							
No.	Freq. (MHz)	Reading (dBm)	S.G Power Value (dBm)	Correction Factor (dB)	ERP (dBm)	Limit (dBm)	Margin (dB)
1	846.50	-7.5	23.0	0.4	23.4	38.5	-15.1
Antenna Polarity & Test Distance: Vertical at 3 M							
No.	Freq. (MHz)	Reading (dBm)	S.G Power Value (dBm)	Correction Factor (dB)	ERP (dBm)	Limit (dBm)	Margin (dB)
1	846.50	-9.4	21.8	0.4	22.2	38.5	-16.3

Note: ERP (dBm) = S.G Power Value (dBm) + Correction Factor (dB).

LTE Band 26, Channel Bandwidth 10MHz

MODE		TX channel 26840					
Antenna Polarity & Test Distance: Horizontal at 3 M							
No.	Freq. (MHz)	Reading (dBm)	S.G Power Value (dBm)	Correction Factor (dB)	ERP (dBm)	Limit (dBm)	Margin (dB)
1	829.00	-7.8	23.2	0.1	23.3	38.5	-15.2
Antenna Polarity & Test Distance: Vertical at 3 M							
No.	Freq. (MHz)	Reading (dBm)	S.G Power Value (dBm)	Correction Factor (dB)	ERP (dBm)	Limit (dBm)	Margin (dB)
1	829.00	-10.0	21.8	0.1	21.9	38.5	-16.6

MODE		TX channel 26915					
Antenna Polarity & Test Distance: Horizontal at 3 M							
No.	Freq. (MHz)	Reading (dBm)	S.G Power Value (dBm)	Correction Factor (dB)	ERP (dBm)	Limit (dBm)	Margin (dB)
1	836.50	-8.4	22.8	0.2	23.0	38.5	-15.5
Antenna Polarity & Test Distance: Vertical at 3 M							
No.	Freq. (MHz)	Reading (dBm)	S.G Power Value (dBm)	Correction Factor (dB)	ERP (dBm)	Limit (dBm)	Margin (dB)
1	836.50	-10.2	21.6	0.2	21.8	38.5	-16.7

MODE		TX channel 26990					
Antenna Polarity & Test Distance: Horizontal at 3 M							
No.	Freq. (MHz)	Reading (dBm)	S.G Power Value (dBm)	Correction Factor (dB)	ERP (dBm)	Limit (dBm)	Margin (dB)
1	844.00	-7.4	23.2	0.4	23.6	38.5	-14.9
Antenna Polarity & Test Distance: Vertical at 3 M							
No.	Freq. (MHz)	Reading (dBm)	S.G Power Value (dBm)	Correction Factor (dB)	ERP (dBm)	Limit (dBm)	Margin (dB)
1	844.00	-10.2	21.3	0.4	21.7	38.5	-16.8

Note: ERP (dBm) = S.G Power Value (dBm) + Correction Factor (dB).

LTE Band 26, Channel Bandwidth 15MHz

MODE		TX channel 26865					
Antenna Polarity & Test Distance: Horizontal at 3 M							
No.	Freq. (MHz)	Reading (dBm)	S.G Power Value (dBm)	Correction Factor (dB)	ERP (dBm)	Limit (dBm)	Margin (dB)
1	831.50	-7.8	23.3	0.1	23.4	38.5	-15.1
Antenna Polarity & Test Distance: Vertical at 3 M							
No.	Freq. (MHz)	Reading (dBm)	S.G Power Value (dBm)	Correction Factor (dB)	ERP (dBm)	Limit (dBm)	Margin (dB)
1	831.50	-10.1	21.5	0.1	21.6	38.5	-16.9

MODE		TX channel 26915					
Antenna Polarity & Test Distance: Horizontal at 3 M							
No.	Freq. (MHz)	Reading (dBm)	S.G Power Value (dBm)	Correction Factor (dB)	ERP (dBm)	Limit (dBm)	Margin (dB)
1	836.50	-8.2	23.0	0.2	23.2	38.5	-15.3
Antenna Polarity & Test Distance: Vertical at 3 M							
No.	Freq. (MHz)	Reading (dBm)	S.G Power Value (dBm)	Correction Factor (dB)	ERP (dBm)	Limit (dBm)	Margin (dB)
1	836.50	-10.1	21.7	0.2	21.9	38.5	-16.6

MODE		TX channel 26965					
Antenna Polarity & Test Distance: Horizontal at 3 M							
No.	Freq. (MHz)	Reading (dBm)	S.G Power Value (dBm)	Correction Factor (dB)	ERP (dBm)	Limit (dBm)	Margin (dB)
1	841.50	-7.5	23.3	0.3	23.6	38.5	-14.9
Antenna Polarity & Test Distance: Vertical at 3 M							
No.	Freq. (MHz)	Reading (dBm)	S.G Power Value (dBm)	Correction Factor (dB)	ERP (dBm)	Limit (dBm)	Margin (dB)
1	841.50	-9.7	21.9	0.3	22.2	38.5	-16.3

Note: ERP (dBm) = S.G Power Value (dBm) + Correction Factor (dB).

Modulation Type: 16QAM

LTE Band 26, Channel Bandwidth 1.4MHz

MODE		TX channel 26797					
Antenna Polarity & Test Distance: Horizontal at 3 M							
No.	Freq. (MHz)	Reading (dBm)	S.G Power Value (dBm)	Correction Factor (dB)	ERP (dBm)	Limit (dBm)	Margin (dB)
1	824.70	-8.8	22.3	0.0	22.3	38.5	-16.2
Antenna Polarity & Test Distance: Vertical at 3 M							
No.	Freq. (MHz)	Reading (dBm)	S.G Power Value (dBm)	Correction Factor (dB)	ERP (dBm)	Limit (dBm)	Margin (dB)
1	824.70	-10.8	21.1	0.0	21.1	38.5	-17.4

MODE		TX channel 26915					
Antenna Polarity & Test Distance: Horizontal at 3 M							
No.	Freq. (MHz)	Reading (dBm)	S.G Power Value (dBm)	Correction Factor (dB)	ERP (dBm)	Limit (dBm)	Margin (dB)
1	836.50	-8.8	22.4	0.2	22.6	38.5	-15.9
Antenna Polarity & Test Distance: Vertical at 3 M							
No.	Freq. (MHz)	Reading (dBm)	S.G Power Value (dBm)	Correction Factor (dB)	ERP (dBm)	Limit (dBm)	Margin (dB)
1	836.50	-10.5	21.3	0.2	21.5	38.5	-17.0

MODE		TX channel 27033					
Antenna Polarity & Test Distance: Horizontal at 3 M							
No.	Freq. (MHz)	Reading (dBm)	S.G Power Value (dBm)	Correction Factor (dB)	ERP (dBm)	Limit (dBm)	Margin (dB)
1	848.30	-8.4	22.1	0.5	22.6	38.5	-15.9
Antenna Polarity & Test Distance: Vertical at 3 M							
No.	Freq. (MHz)	Reading (dBm)	S.G Power Value (dBm)	Correction Factor (dB)	ERP (dBm)	Limit (dBm)	Margin (dB)
1	848.30	-10.9	20.5	0.5	21.0	38.5	-17.5

Note: ERP (dBm) = S.G Power Value (dBm) + Correction Factor (dB).

LTE Band 26, Channel Bandwidth 3MHz

MODE		TX channel 26805					
Antenna Polarity & Test Distance: Horizontal at 3 M							
No.	Freq. (MHz)	Reading (dBm)	S.G Power Value (dBm)	Correction Factor (dB)	ERP (dBm)	Limit (dBm)	Margin (dB)
1	825.50	-8.4	22.7	0.0	22.7	38.5	-15.8
Antenna Polarity & Test Distance: Vertical at 3 M							
No.	Freq. (MHz)	Reading (dBm)	S.G Power Value (dBm)	Correction Factor (dB)	ERP (dBm)	Limit (dBm)	Margin (dB)
1	825.50	-10.7	21.2	0.0	21.2	38.5	-17.3

MODE		TX channel 26915					
Antenna Polarity & Test Distance: Horizontal at 3 M							
No.	Freq. (MHz)	Reading (dBm)	S.G Power Value (dBm)	Correction Factor (dB)	ERP (dBm)	Limit (dBm)	Margin (dB)
1	836.50	-9.2	22.0	0.2	22.2	38.5	-16.3
Antenna Polarity & Test Distance: Vertical at 3 M							
No.	Freq. (MHz)	Reading (dBm)	S.G Power Value (dBm)	Correction Factor (dB)	ERP (dBm)	Limit (dBm)	Margin (dB)
1	836.50	-11.0	20.8	0.2	21.0	38.5	-17.5

MODE		TX channel 27025					
Antenna Polarity & Test Distance: Horizontal at 3 M							
No.	Freq. (MHz)	Reading (dBm)	S.G Power Value (dBm)	Correction Factor (dB)	ERP (dBm)	Limit (dBm)	Margin (dB)
1	847.50	-8.6	22.0	0.4	22.4	38.5	-16.1
Antenna Polarity & Test Distance: Vertical at 3 M							
No.	Freq. (MHz)	Reading (dBm)	S.G Power Value (dBm)	Correction Factor (dB)	ERP (dBm)	Limit (dBm)	Margin (dB)
1	847.50	-10.4	20.9	0.4	21.3	38.5	-17.2

Note: ERP (dBm) = S.G Power Value (dBm) + Correction Factor (dB).

LTE Band 26, Channel Bandwidth 5MHz

MODE		TX channel 26815					
Antenna Polarity & Test Distance: Horizontal at 3 M							
No.	Freq. (MHz)	Reading (dBm)	S.G Power Value (dBm)	Correction Factor (dB)	ERP (dBm)	Limit (dBm)	Margin (dB)
1	826.50	-8.8	22.4	0.0	22.4	38.5	-16.1
Antenna Polarity & Test Distance: Vertical at 3 M							
No.	Freq. (MHz)	Reading (dBm)	S.G Power Value (dBm)	Correction Factor (dB)	ERP (dBm)	Limit (dBm)	Margin (dB)
1	826.50	-10.9	21.0	0.0	21.0	38.5	-17.5

MODE		TX channel 26915					
Antenna Polarity & Test Distance: Horizontal at 3 M							
No.	Freq. (MHz)	Reading (dBm)	S.G Power Value (dBm)	Correction Factor (dB)	ERP (dBm)	Limit (dBm)	Margin (dB)
1	836.50	-9.2	21.9	0.2	22.1	38.5	-16.4
Antenna Polarity & Test Distance: Vertical at 3 M							
No.	Freq. (MHz)	Reading (dBm)	S.G Power Value (dBm)	Correction Factor (dB)	ERP (dBm)	Limit (dBm)	Margin (dB)
1	836.50	-10.6	21.2	0.2	21.4	38.5	-17.1

MODE		TX channel 27015					
Antenna Polarity & Test Distance: Horizontal at 3 M							
No.	Freq. (MHz)	Reading (dBm)	S.G Power Value (dBm)	Correction Factor (dB)	ERP (dBm)	Limit (dBm)	Margin (dB)
1	846.50	-8.4	22.1	0.4	22.5	38.5	-16.0
Antenna Polarity & Test Distance: Vertical at 3 M							
No.	Freq. (MHz)	Reading (dBm)	S.G Power Value (dBm)	Correction Factor (dB)	ERP (dBm)	Limit (dBm)	Margin (dB)
1	846.50	-10.4	20.8	0.4	21.2	38.5	-17.3

Note: ERP (dBm) = S.G Power Value (dBm) + Correction Factor (dB).

LTE Band 26, Channel Bandwidth 10MHz

MODE		TX channel 26840					
Antenna Polarity & Test Distance: Horizontal at 3 M							
No.	Freq. (MHz)	Reading (dBm)	S.G Power Value (dBm)	Correction Factor (dB)	ERP (dBm)	Limit (dBm)	Margin (dB)
1	829.00	-8.8	22.2	0.1	22.3	38.5	-16.2
Antenna Polarity & Test Distance: Vertical at 3 M							
No.	Freq. (MHz)	Reading (dBm)	S.G Power Value (dBm)	Correction Factor (dB)	ERP (dBm)	Limit (dBm)	Margin (dB)
1	829.00	-11.0	20.8	0.1	20.9	38.5	-17.6

MODE		TX channel 26915					
Antenna Polarity & Test Distance: Horizontal at 3 M							
No.	Freq. (MHz)	Reading (dBm)	S.G Power Value (dBm)	Correction Factor (dB)	ERP (dBm)	Limit (dBm)	Margin (dB)
1	836.50	-9.4	21.8	0.2	22.0	38.5	-16.5
Antenna Polarity & Test Distance: Vertical at 3 M							
No.	Freq. (MHz)	Reading (dBm)	S.G Power Value (dBm)	Correction Factor (dB)	ERP (dBm)	Limit (dBm)	Margin (dB)
1	836.50	-11.3	20.5	0.2	20.7	38.5	-17.8

MODE		TX channel 26990					
Antenna Polarity & Test Distance: Horizontal at 3 M							
No.	Freq. (MHz)	Reading (dBm)	S.G Power Value (dBm)	Correction Factor (dB)	ERP (dBm)	Limit (dBm)	Margin (dB)
1	844.00	-8.3	22.3	0.4	22.7	38.5	-15.8
Antenna Polarity & Test Distance: Vertical at 3 M							
No.	Freq. (MHz)	Reading (dBm)	S.G Power Value (dBm)	Correction Factor (dB)	ERP (dBm)	Limit (dBm)	Margin (dB)
1	844.00	-10.9	20.6	0.4	21.0	38.5	-17.5

Note: ERP (dBm) = S.G Power Value (dBm) + Correction Factor (dB).

LTE Band 26, Channel Bandwidth 15MHz

MODE		TX channel 26865					
Antenna Polarity & Test Distance: Horizontal at 3 M							
No.	Freq. (MHz)	Reading (dBm)	S.G Power Value (dBm)	Correction Factor (dB)	ERP (dBm)	Limit (dBm)	Margin (dB)
1	831.50	-8.8	22.3	0.1	22.4	38.5	-16.1
Antenna Polarity & Test Distance: Vertical at 3 M							
No.	Freq. (MHz)	Reading (dBm)	S.G Power Value (dBm)	Correction Factor (dB)	ERP (dBm)	Limit (dBm)	Margin (dB)
1	831.50	-11.1	20.5	0.1	20.6	38.5	-17.9

MODE		TX channel 26915					
Antenna Polarity & Test Distance: Horizontal at 3 M							
No.	Freq. (MHz)	Reading (dBm)	S.G Power Value (dBm)	Correction Factor (dB)	ERP (dBm)	Limit (dBm)	Margin (dB)
1	836.50	-9.2	22.0	0.2	22.2	38.5	-16.3
Antenna Polarity & Test Distance: Vertical at 3 M							
No.	Freq. (MHz)	Reading (dBm)	S.G Power Value (dBm)	Correction Factor (dB)	ERP (dBm)	Limit (dBm)	Margin (dB)
1	836.50	-11.2	20.6	0.2	20.8	38.5	-17.7

MODE		TX channel 26965					
Antenna Polarity & Test Distance: Horizontal at 3 M							
No.	Freq. (MHz)	Reading (dBm)	S.G Power Value (dBm)	Correction Factor (dB)	ERP (dBm)	Limit (dBm)	Margin (dB)
1	841.50	-8.4	22.4	0.3	22.7	38.5	-15.8
Antenna Polarity & Test Distance: Vertical at 3 M							
No.	Freq. (MHz)	Reading (dBm)	S.G Power Value (dBm)	Correction Factor (dB)	ERP (dBm)	Limit (dBm)	Margin (dB)
1	841.50	-10.7	20.9	0.3	21.2	38.5	-17.3

Note: ERP (dBm) = S.G Power Value (dBm) + Correction Factor (dB).

4.2 Modulation Characteristics Measurement

4.2.1 Limits of Modulation Characteristics

N/A

4.2.2 Test Procedure

Connect the EUT to Communication Simulator via the antenna connector, The frequency band is set as EUT supported Modulation and Channels, the EUT output is matched with 50 ohm load, the waveform quality and constellation of the EUT was tested.

4.2.3 Test Setup



4.2.4 Test Results

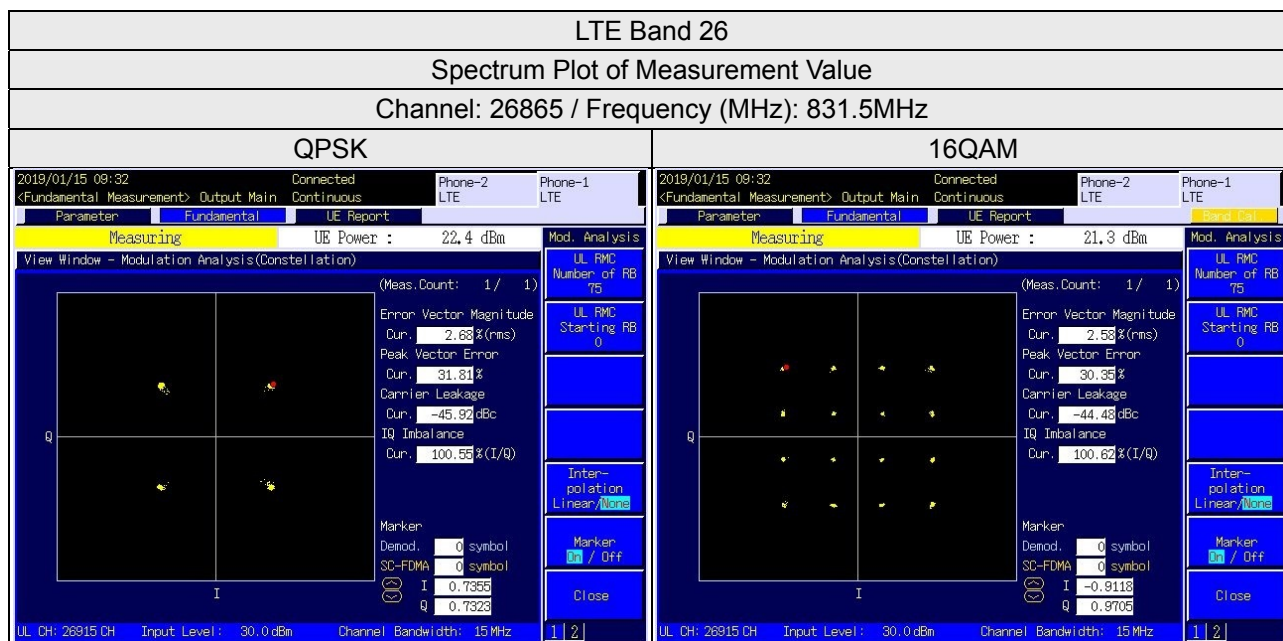

4.3 Frequency Stability Measurement

4.3.1 Limits of Frequency Stability Measurement

1.5 ppm is for base and fixed station. 2.5 ppm is for mobile station.

4.3.2 Test Procedure

- Device is placed at the oven room. The oven room could control the temperatures and humidity. Power warm up is at least 15 min and power applied should perform before recording frequency error.
- EUT is connected the external power supply to control the DC input power. The test voltage range is from minimum to maximum working voltage. Each step shall be record the frequency error rate.
- The temperature range step is 10 degrees in this test items. All temperature levels shall be hold the ± 0.5 °C during the measurement testing. The each temperature step shall be at least 0.5 hours, consider the EUT could be test under the stability condition.

Note: The frequency error was recorded frequency error from the communication simulator.

4.3.3 Test Setup

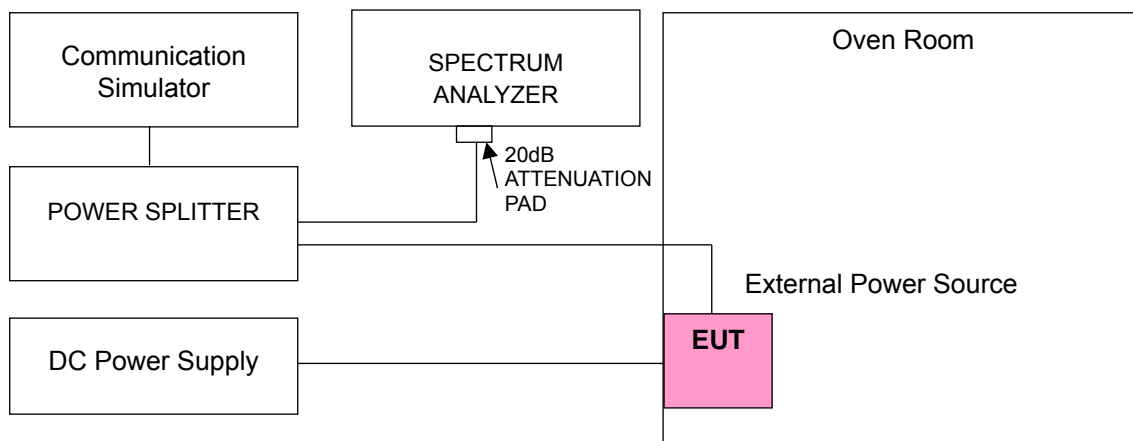

4.3.4 Test Results

Frequency Error vs. Voltage

Voltage (Volts)	LTE Band 26			
	Channel Bandwidth: 1.4 MHz			
	Low Channel		High Channel	
	Frequency (MHz)	Frequency Error (ppm)	Frequency (MHz)	Frequency Error (ppm)
8	824.700001	0.001	848.300000	0.003
5	824.700003	0.004	848.300000	0.003
12	824.700004	0.005	848.300000	0.003

Note: The applicant defined the normal working voltage is from 5Vdc to 12Vdc.

Frequency Error vs. Temperature

Temp. (°C)	LTE Band 26			
	Channel Bandwidth: 1.4 MHz			
	Low Channel		High Channel	
	Frequency (MHz)	Frequency Error (ppm)	Frequency (MHz)	Frequency Error (ppm)
-30	824.700001	0.002	848.300000	0.004
-20	824.700003	0.003	848.300000	0.004
-10	824.700002	0.003	848.300000	0.003
0	824.700002	0.003	848.300000	0.005
10	824.700001	0.001	848.300000	0.005
20	824.699999	-0.001	848.300000	-0.002
30	824.699999	-0.001	848.300000	-0.002
40	824.699996	-0.004	848.300000	-0.004
50	824.699999	-0.001	848.300000	-0.004
60	824.699997	-0.004	848.300000	-0.002

Frequency Error vs. Voltage

Voltage (Volts)	LTE Band 26			
	Channel Bandwidth: 3 MHz			
	Low Channel		High Channel	
	Frequency (MHz)	Frequency Error (ppm)	Frequency (MHz)	Frequency Error (ppm)
8	825.500001	0.001	847.500000	0.003
5	825.500001	0.001	847.500000	0.002
12	825.500004	0.005	847.500000	0.005

Note: The applicant defined the normal working voltage is from 5Vdc to 12Vdc.

Frequency Error vs. Temperature

Temp. (°C)	LTE Band 26			
	Channel Bandwidth: 3 MHz			
	Low Channel		High Channel	
	Frequency (MHz)	Frequency Error (ppm)	Frequency (MHz)	Frequency Error (ppm)
-30	825.500003	0.004	847.500000	0.003
-20	825.500004	0.004	847.500000	0.002
-10	825.500002	0.003	847.500000	0.003
0	825.500002	0.003	847.500000	0.001
10	825.500002	0.002	847.500000	0.002
20	825.499996	-0.005	847.500000	-0.001
30	825.499996	-0.005	847.500000	-0.002
40	825.499997	-0.004	847.500000	-0.001
50	825.499999	-0.001	847.500000	-0.003
60	825.499997	-0.004	847.500000	-0.004

Frequency Error vs. Voltage

Voltage (Volts)	LTE Band 26			
	Channel Bandwidth: 5 MHz			
	Low Channel		High Channel	
	Frequency (MHz)	Frequency Error (ppm)	Frequency (MHz)	Frequency Error (ppm)
8	826.500003	0.004	846.500003	0.003
5	826.500001	0.002	846.500004	0.005
12	826.500002	0.003	846.500002	0.002

Note: The applicant defined the normal working voltage is from 5Vdc to 12Vdc.

Frequency Error vs. Temperature

Temp. (°C)	LTE Band 26			
	Channel Bandwidth: 5 MHz			
	Low Channel		High Channel	
	Frequency (MHz)	Frequency Error (ppm)	Frequency (MHz)	Frequency Error (ppm)
-30	826.500004	0.005	846.500001	0.002
-20	826.500004	0.004	846.500001	0.001
-10	826.500002	0.002	846.500002	0.003
0	826.500004	0.005	846.500003	0.004
10	826.500002	0.002	846.500004	0.004
20	826.499997	-0.004	846.499997	-0.004
30	826.499999	-0.001	846.499998	-0.002
40	826.499999	-0.001	846.499997	-0.003
50	826.499998	-0.003	846.499997	-0.004
60	826.499997	-0.004	846.499997	-0.003

Frequency Error vs. Voltage

Voltage (Volts)	LTE Band 26			
	Channel Bandwidth: 10 MHz			
	Low Channel		High Channel	
	Frequency (MHz)	Frequency Error (ppm)	Frequency (MHz)	Frequency Error (ppm)
8	829.000002	0.003	844.000002	0.002
5	829.000002	0.003	844.000003	0.004
12	829.000004	0.005	844.000003	0.003

Note: The applicant defined the normal working voltage is from 5Vdc to 12Vdc.

Frequency Error vs. Temperature

Temp. (°C)	LTE Band 26			
	Channel Bandwidth: 10 MHz			
	Low Channel		High Channel	
	Frequency (MHz)	Frequency Error (ppm)	Frequency (MHz)	Frequency Error (ppm)
-30	829.000003	0.004	844.000003	0.003
-20	829.000003	0.004	844.000001	0.001
-10	829.000003	0.003	844.000001	0.002
0	829.000001	0.001	844.000001	0.001
10	829.000002	0.003	844.000001	0.002
20	828.999999	-0.002	843.999997	-0.004
30	828.999997	-0.004	843.999997	-0.003
40	828.999998	-0.003	843.999998	-0.002
50	828.999996	-0.005	843.999999	-0.001
60	828.999997	-0.004	843.999996	-0.005

Frequency Error vs. Voltage

Voltage (Volts)	LTE Band 26			
	Channel Bandwidth: 15 MHz			
	Low Channel		High Channel	
	Frequency (MHz)	Frequency Error (ppm)	Frequency (MHz)	Frequency Error (ppm)
8	831.500004	0.004	841.500004	0.005
5	831.500002	0.002	841.500002	0.002
12	831.500003	0.004	841.500002	0.002

Note: The applicant defined the normal working voltage is from 5Vdc to 12Vdc.

Frequency Error vs. Temperature

Temp. (°C)	LTE Band 26			
	Channel Bandwidth: 15 MHz			
	Low Channel		High Channel	
	Frequency (MHz)	Frequency Error (ppm)	Frequency (MHz)	Frequency Error (ppm)
-30	831.500001	0.001	841.500004	0.005
-20	831.500003	0.003	841.500003	0.004
-10	831.500002	0.002	841.500002	0.002
0	831.500003	0.003	841.500003	0.004
10	831.500001	0.001	841.500004	0.004
20	831.499997	-0.003	841.499997	-0.004
30	831.499999	-0.002	841.499997	-0.004
40	831.499999	-0.001	841.499999	-0.001
50	831.499998	-0.003	841.499996	-0.005
60	831.499999	-0.001	841.499998	-0.002

4.4 Occupied Bandwidth Measurement

4.4.1 Test Procedure

The EUT makes a call to the communication simulator. All measurements were done at low, middle and high operational frequency range. The communication simulator station system controlled a EUT to export maximum output power under transmission mode and specific channel frequency. Use OBW measurement function of Spectrum analyzer to measure 99 % occupied bandwidth.

4.4.2 Test Setup

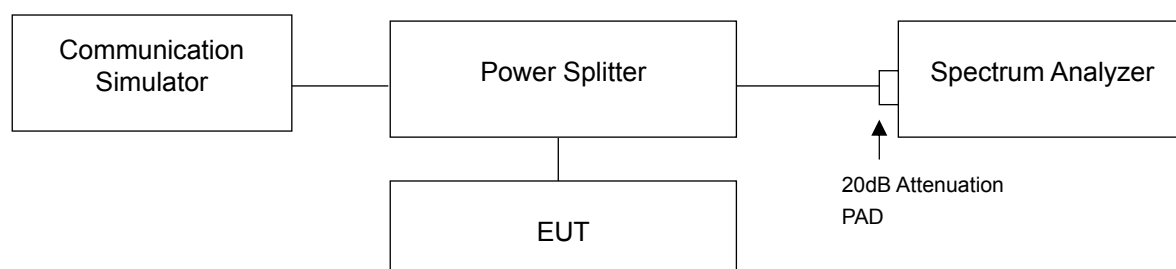

4.4.3 Test Result

Occupied Bandwidth

LTE Band 26, Channel Bandwidth 1.4MHz			
Channel	Frequency (MHz)	99% Occupied Bandwidth (MHz)	
		QPSK	16QAM
26797	824.7	1.08	1.09
26915	836.5	1.08	1.09
27033	848.3	1.08	1.08

LTE Band 26, Channel Bandwidth 3MHz			
Channel	Frequency (MHz)	99% Occupied Bandwidth (MHz)	
		QPSK	16QAM
26805	825.5	2.70	2.69
26915	836.5	2.69	2.69
27025	847.5	2.69	2.69

LTE Band 26, Channel Bandwidth 5MHz			
Channel	Frequency (MHz)	99% Occupied Bandwidth (MHz)	
		QPSK	16QAM
26815	826.5	4.49	4.49
26915	836.5	4.49	4.49
27015	846.5	4.48	4.48

LTE Band 26, Channel Bandwidth 10MHz			
Channel	Frequency (MHz)	99% Occupied Bandwidth (MHz)	
		QPSK	16QAM
26840	829.0	8.95	8.95
26915	836.5	8.95	8.95
26990	844.0	8.92	8.92

LTE Band 26, Channel Bandwidth 15MHz			
Channel	Frequency (MHz)	99% Occupied Bandwidth (MHz)	
		QPSK	16QAM
26865	831.5	13.41	13.40
26915	836.5	13.46	13.43
26965	841.5	13.39	13.40

Spectrum Plot of Worst Value

1.4MHz / 16QAM

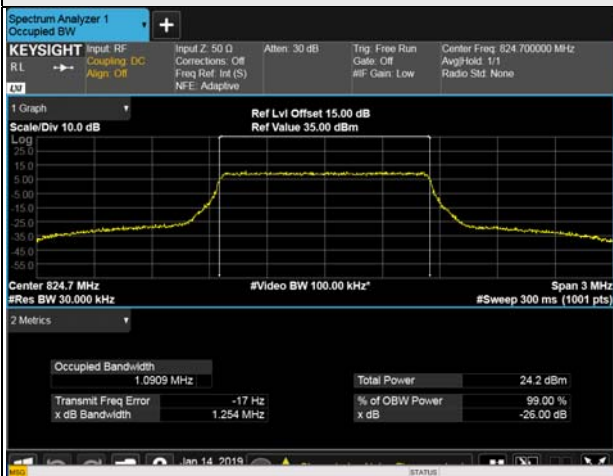

3MHz / QPSK

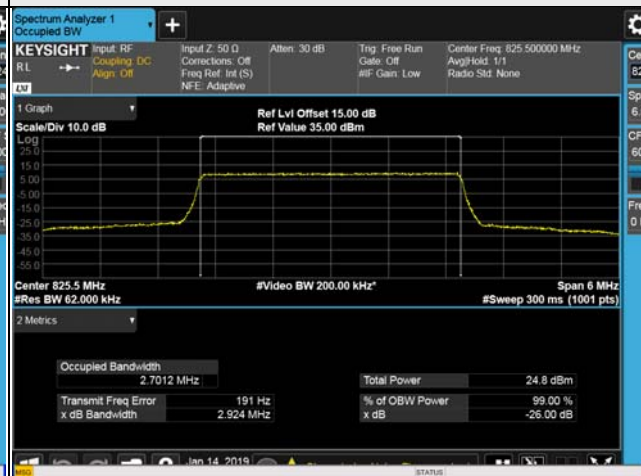

5MHz / QPSK



10MHz / QPSK



15MHz / QPSK



26dB Bandwidth

LTE Band 26, Channel Bandwidth 1.4MHz			
Channel	Frequency (MHz)	26dB Bandwidth (MHz)	
		QPSK	16QAM
26797	824.7	1.25	1.25
26915	836.5	1.24	1.26
27033	848.3	1.26	1.26

LTE Band 26, Channel Bandwidth 3MHz			
Channel	Frequency (MHz)	26dB Bandwidth (MHz)	
		QPSK	16QAM
26805	825.5	2.92	2.93
26915	836.5	2.91	2.92
27025	847.5	2.92	2.90

LTE Band 26, Channel Bandwidth 5MHz			
Channel	Frequency (MHz)	26dB Bandwidth (MHz)	
		QPSK	16QAM
26815	826.5	4.81	4.81
26915	836.5	4.84	4.80
27015	846.5	4.82	4.82

LTE Band 26, Channel Bandwidth 10MHz			
Channel	Frequency (MHz)	26dB Bandwidth (MHz)	
		QPSK	16QAM
26840	829.0	9.51	9.51
26915	836.5	9.50	9.52
26990	844.0	9.50	9.50

LTE Band 26, Channel Bandwidth 15MHz			
Channel	Frequency (MHz)	26dB Bandwidth (MHz)	
		QPSK	16QAM
26865	831.5	14.22	14.21
26915	836.5	14.24	14.23
26965	841.5	14.22	14.22

Spectrum Plot of Worst Value

1.4MHz / 16QAM

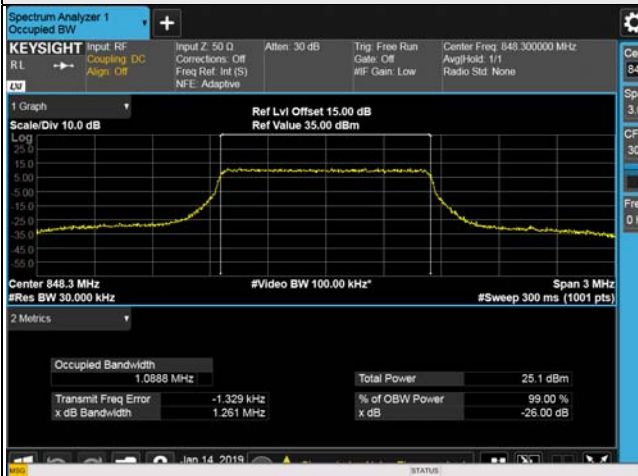

3MHz / 16QAM

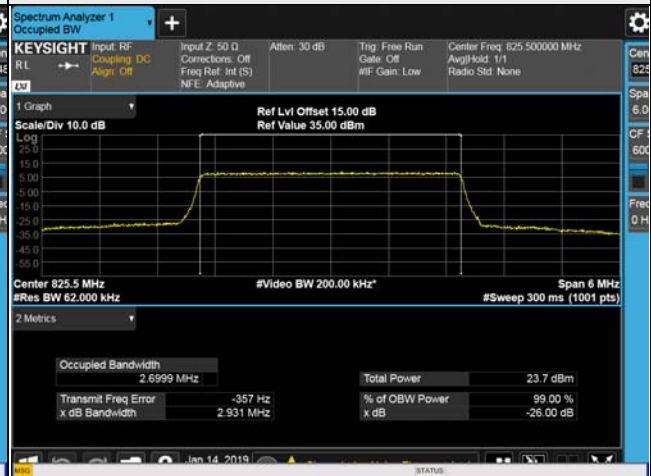

5MHz / QPSK

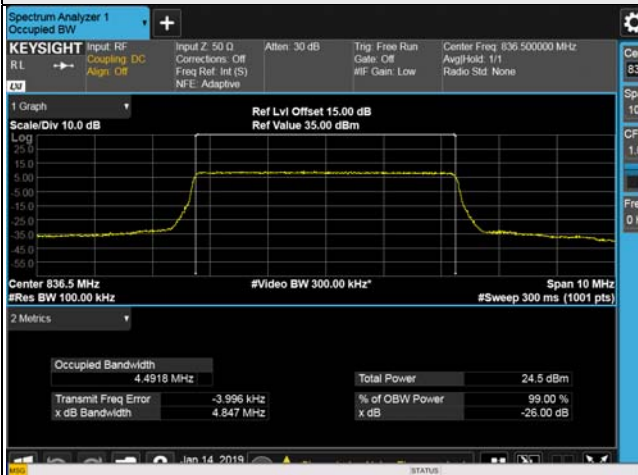

10MHz / 16QAM



15MHz / QPSK

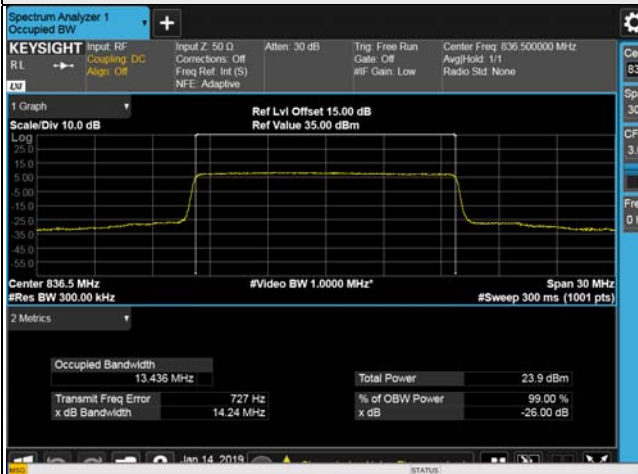

4.5 Band Edge Measurement

4.5.1 Limits of Band Edge Measurement

Power of any emission outside of the authorized operating frequency ranges must be attenuated below the transmitting power (P) by a factor of at least $43 + 10 \log(P)$ dB. In the 1 MHz bands immediately outside and adjacent to the frequency block a resolution bandwidth of at least one percent of the emission bandwidth of the fundamental emission of the transmitter may be employed.

4.5.2 Test Setup

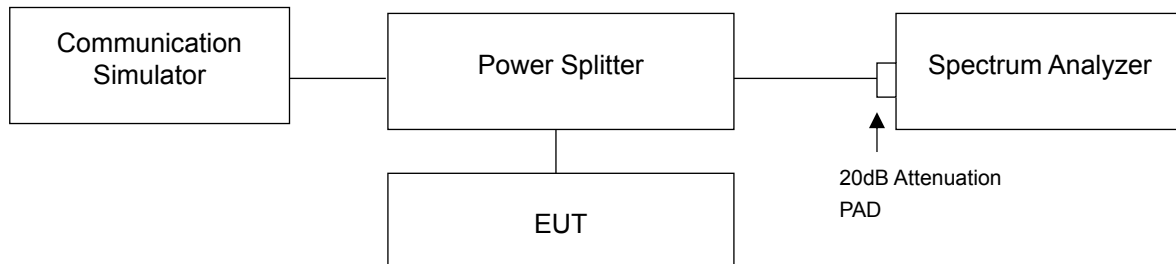

4.5.3 Test Procedures

- All measurements were done at low and high operational frequency range.
- The center frequency of spectrum is the band edge frequency and span is 1.5MHz. RB of the spectrum is 15kHz and VB of the spectrum is 51kHz (LTE Channel Bandwidth 1.4MHz).
- The center frequency of spectrum is the band edge frequency and span is 1.5MHz. RB of the spectrum is 30kHz and VB of the spectrum is 100kHz (LTE Channel Bandwidth 3MHz).
- The center frequency of spectrum is the band edge frequency and span is 1.5MHz. RB of the spectrum is 62kHz and VB of the spectrum is 200kHz (LTE Channel Bandwidth 5MHz).
- The center frequency of spectrum is the band edge frequency and span is 1.5MHz. RB of the spectrum is 100kHz and VB of the spectrum is 300kHz (LTE Channel Bandwidth 10MHz).
- The center frequency of spectrum is the band edge frequency and span is 1.5MHz. RB of the spectrum is 150kHz and VB of the spectrum is 470kHz (LTE Channel Bandwidth 15MHz).
- Record the max trace plot into the test report.

4.5.4 Test Results

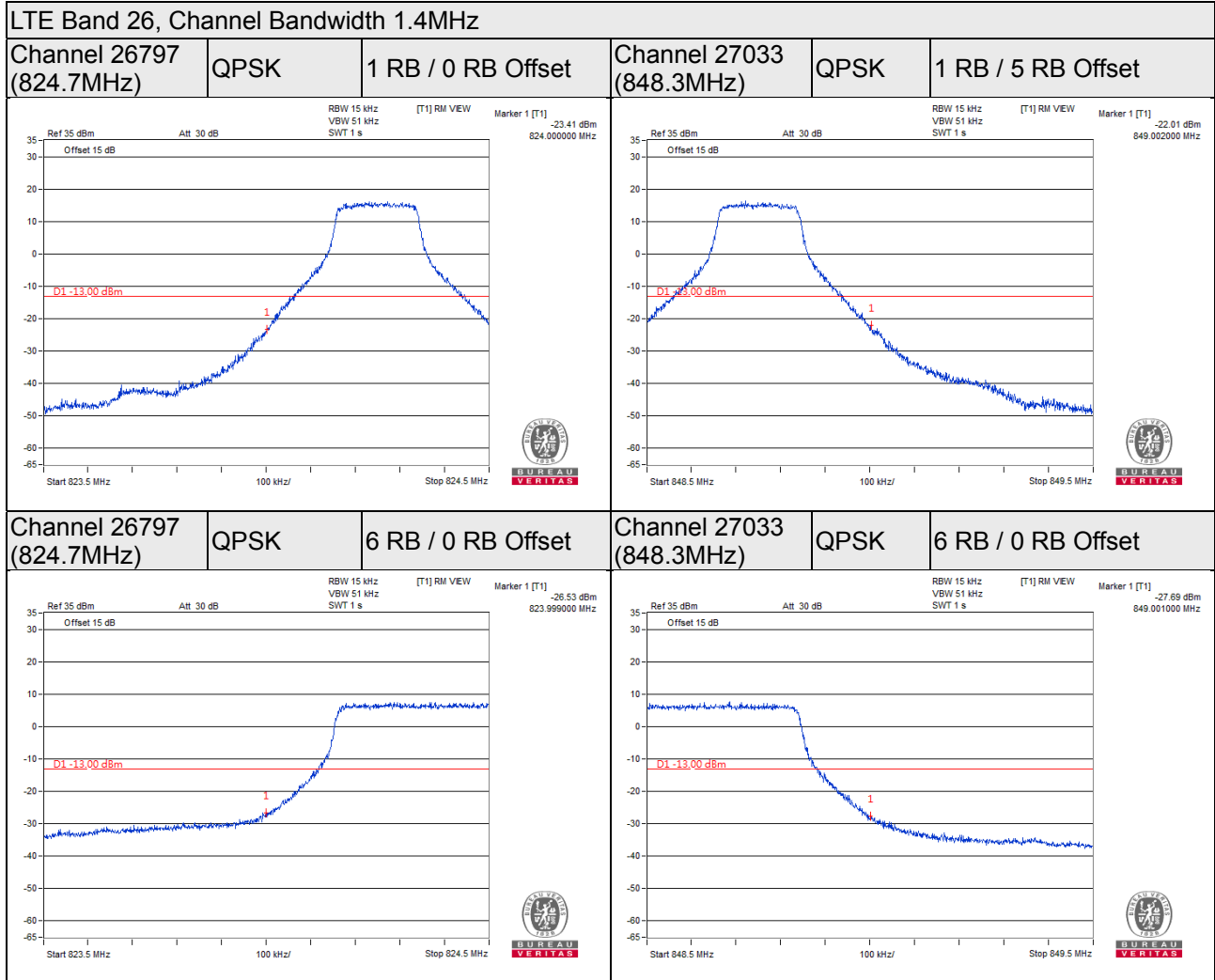

LTE Band 26, Channel Bandwidth 3MHz

Channel 26805 (825.5MHz)	QPSK	1 RB / 0 RB Offset	Channel 27025 (847.5MHz)	QPSK	1 RB / 14 RB Offset
-----------------------------	------	--------------------	-----------------------------	------	---------------------

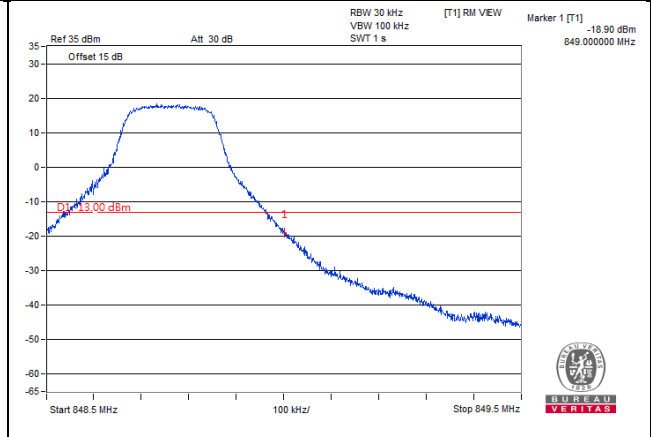
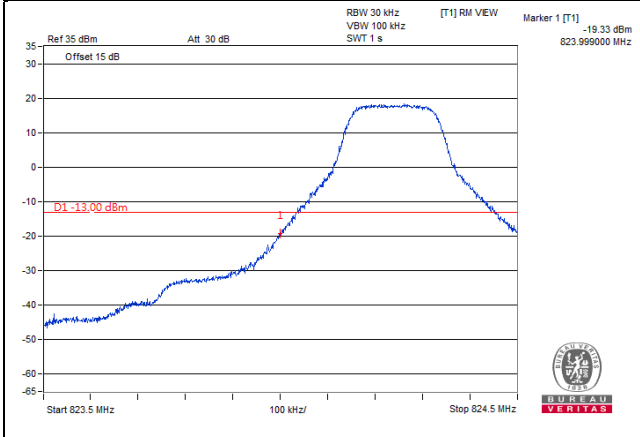

Channel 26805 (825.5MHz)	QPSK	15 RB / 0 RB Offset
-----------------------------	------	---------------------

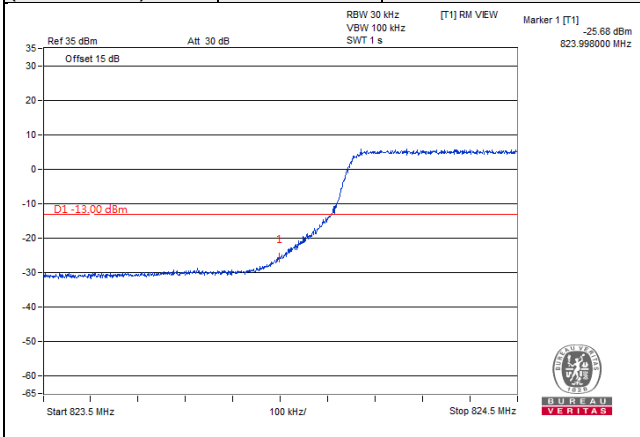

Channel 27025 M(847.5MHz)	QPSK	15 RB / 0 RB Offset
------------------------------	------	---------------------

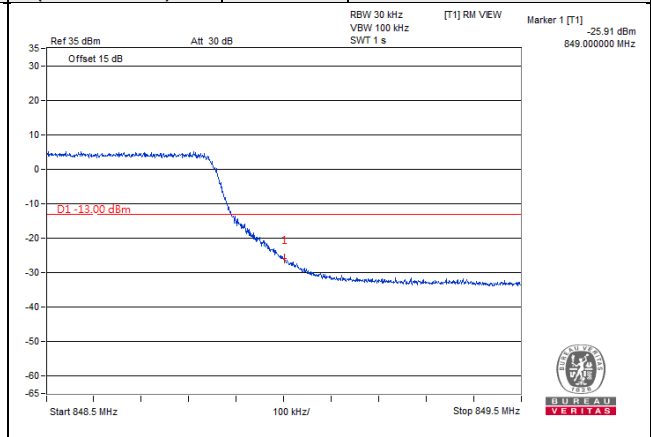

LTE Band 26, Channel Bandwidth 5MHz

Channel 26815 (826.5MHz)	QPSK	1 RB / 0 RB Offset	Channel 27015 (846.5MHz)	QPSK	1 RB / 24 RB Offset
-------------------------------------	-------------	---------------------------	-------------------------------------	-------------	----------------------------

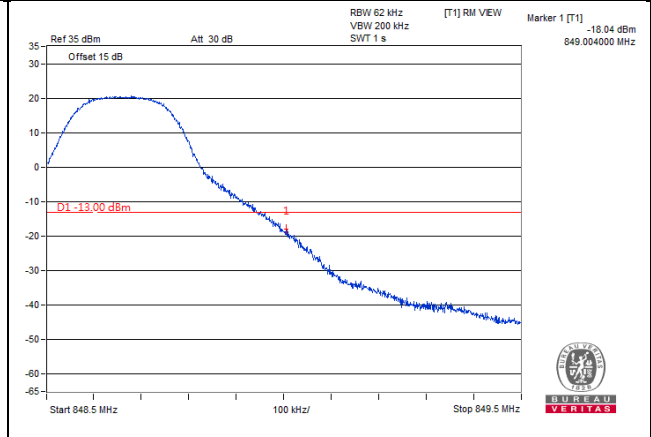
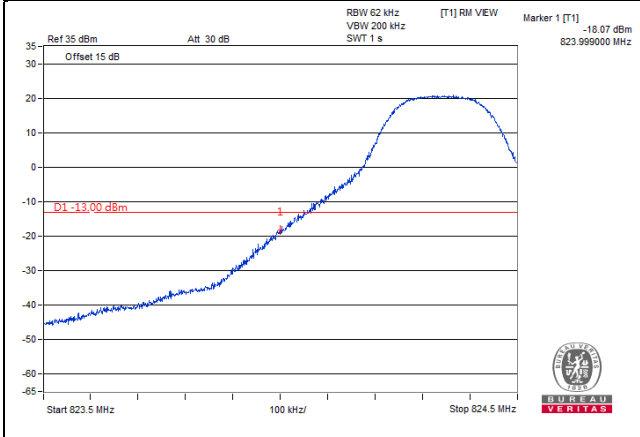

Channel 26815 (826.5MHz)	QPSK	25 RB / 0 RB Offset	Channel 27015 (846.5MHz)	QPSK	25 RB / 0 RB Offset
-------------------------------------	-------------	----------------------------	-------------------------------------	-------------	----------------------------

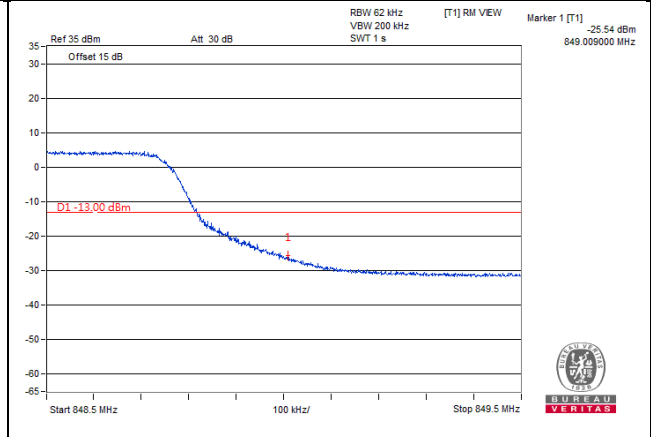
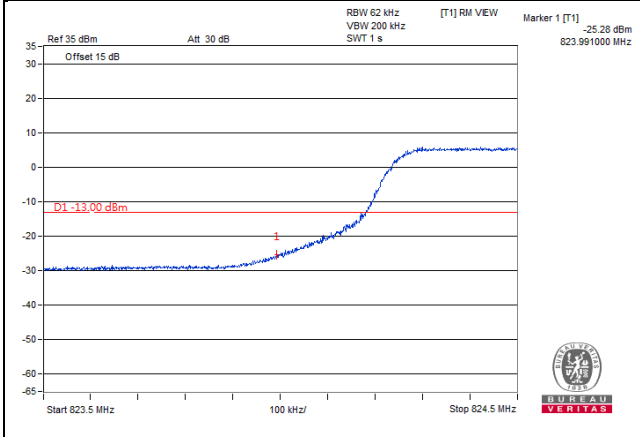

LTE Band 26, Channel Bandwidth 10MHz

Channel 26840 (829MHz)	QPSK	1 RB / 0 RB Offset	Channel 26990 (844MHz)	QPSK	1 RB / 49 RB Offset
---------------------------	------	--------------------	---------------------------	------	---------------------

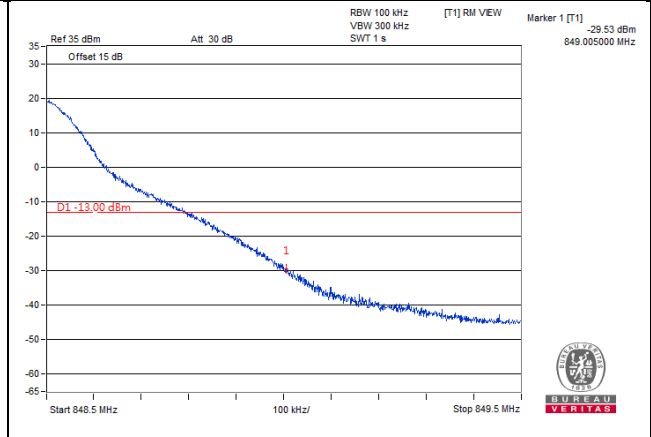
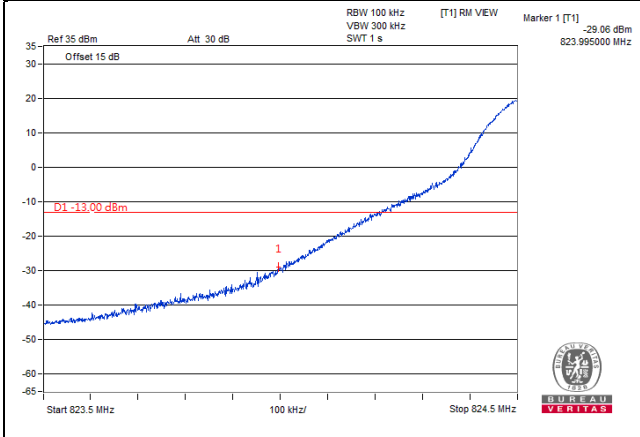

Channel 26840 (829MHz)	QPSK	50 RB / 0 RB Offset	Channel 26990 (844MHz)	QPSK	50 RB / 0 RB Offset
---------------------------	------	---------------------	---------------------------	------	---------------------

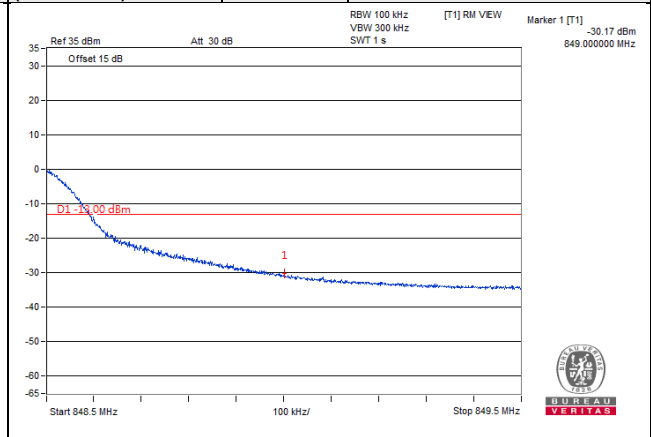
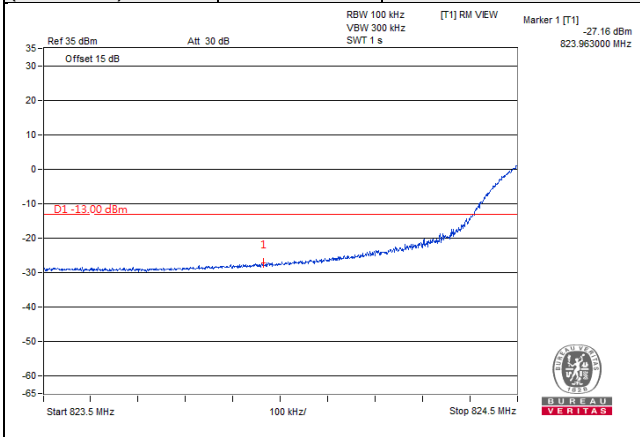

LTE Band 26, Channel Bandwidth 15MHz

Channel 26915 (831.5MHz)	QPSK	1 RB / 0 RB Offset	Channel 26965 (841.5MHz)	QPSK	1 RB / 74 RB Offset
-------------------------------------	-------------	---------------------------	-------------------------------------	-------------	----------------------------

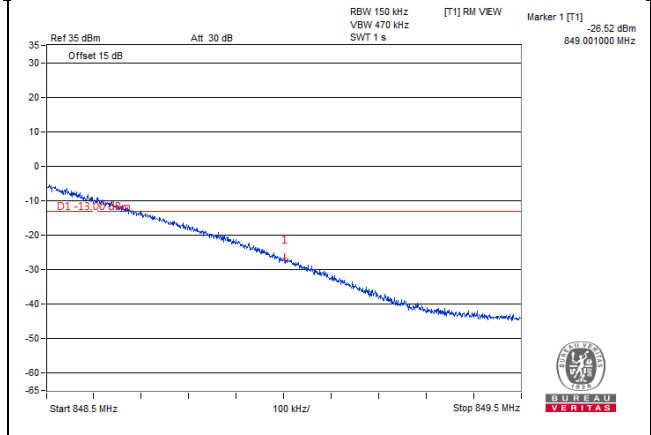
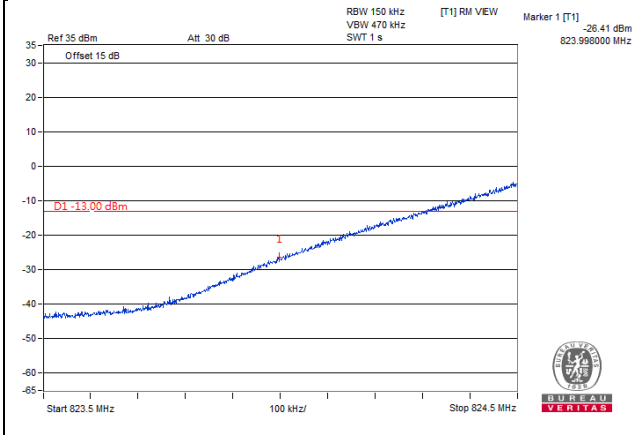

Channel 26915 (831.5MHz)	QPSK	75 RB / 0 RB Offset	Channel 26965 (841.5MHz)	QPSK	75 RB / 0 RB Offset
-------------------------------------	-------------	----------------------------	-------------------------------------	-------------	----------------------------

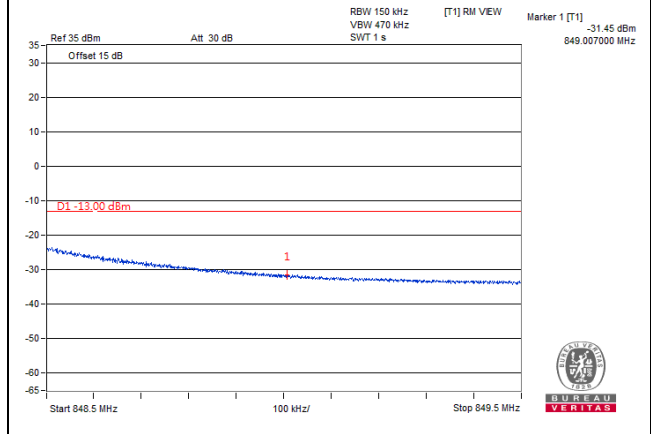
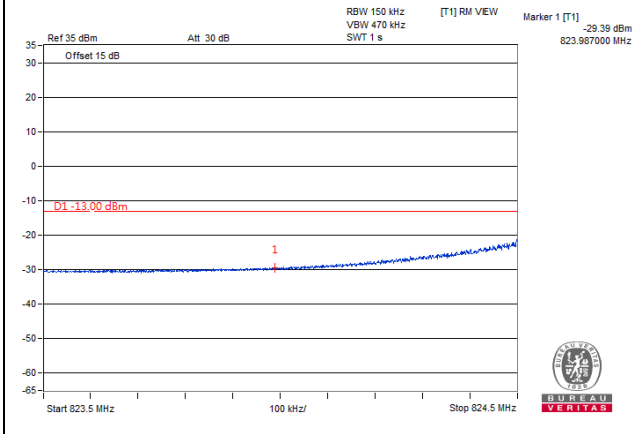

4.6 Peak to Average Ratio

4.6.1 Limits of Peak to Average Ratio Measurement

In measuring transmissions in this band using an average power technique, the peak to-average ratio (PAR) of the transmission may not exceed 13 dB

4.6.2 Test Setup

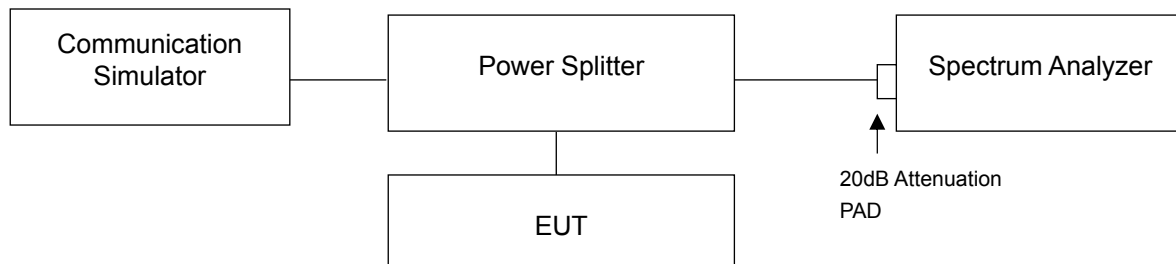

4.6.3 Test Procedures

- Set resolution/measurement bandwidth \geq signal's occupied bandwidth;
- Set the number of counts to a value that stabilizes the measured CCDF curve;
- Record the maximum PAPR level associated with a probability of 0.1%.

4.6.4 Test Results

LTE Band 26, Channel Bandwidth 1.4MHz			
Channel	Frequency (MHz)	Peak To Average Ratio (dB)	
		QPSK	16QAM
26797	824.7	5.06	5.84
26915	836.5	4.50	5.29
27033	848.3	3.96	4.86

LTE Band 26, Channel Bandwidth 3MHz			
Channel	Frequency (MHz)	Peak To Average Ratio (dB)	
		QPSK	16QAM
26805	825.5	5.08	5.87
26915	836.5	4.46	5.25
27025	847.5	3.79	4.66

LTE Band 26, Channel Bandwidth 5MHz			
Channel	Frequency (MHz)	Peak To Average Ratio (dB)	
		QPSK	16QAM
26815	826.5	4.99	5.77
26915	836.5	4.38	5.17
27015	846.5	4.21	5.08

LTE Band 26, Channel Bandwidth 10MHz			
Channel	Frequency (MHz)	Peak To Average Ratio (dB)	
		QPSK	16QAM
26840	829.0	5.01	5.81
26915	836.5	4.33	5.22
26990	844.0	4.74	5.53

LTE Band 26, Channel Bandwidth 15MHz			
Channel	Frequency (MHz)	Peak To Average Ratio (dB)	
		QPSK	16QAM
26865	831.5	4.95	5.66
26915	836.5	4.55	5.38
26965	841.5	4.36	5.20

Spectrum Plot of Worst Value

1.4MHz / 16QAM



3MHz / 16QAM



5MHz / 16QAM



10MHz / 16QAM



15MHz / 16QAM



4.7 Conducted Spurious Emissions

4.7.1 Limits of Conducted Spurious Emissions Measurement

The power of any emission outside of the authorized operating frequency ranges must be attenuated below the transmitting power (P) by a factor of at least $43 + 10 \log(P)$ dB. The emission limit equal to -13dBm .

4.7.2 Test Setup

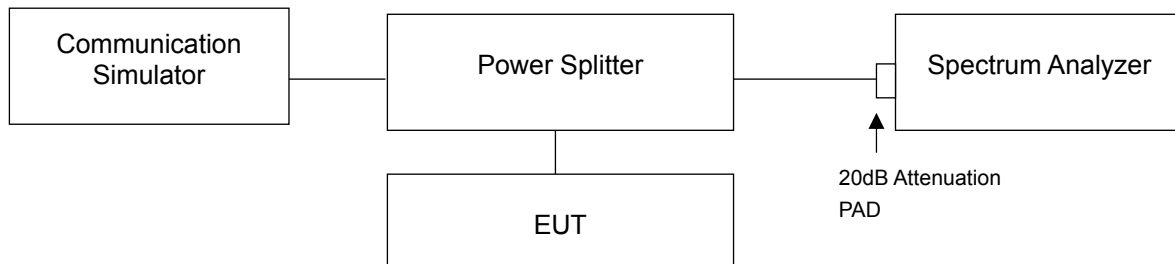

4.7.3 Test Procedure

- The EUT makes a phone call to the communication simulator. All measurements were done at low, middle and high operational frequency range.
- Measuring frequency range is from 9 kHz to 1GHz. 20dB attenuation pad is connected with spectrum. RBW=100kHz and VBW=300kHz is used for conducted emission measurement.
- Measuring frequency range is from 1GHz to 26.5GHz. 20dB attenuation pad is connected with spectrum. RBW=1MHz and VBW=3MHz is used for conducted emission measurement.

4.7.4 Test Results

LTE Band 26, Channel Bandwidth 1.4MHz

Channel 26897 (824.7MHz)

Frequency Range : 9kHz~1GHz

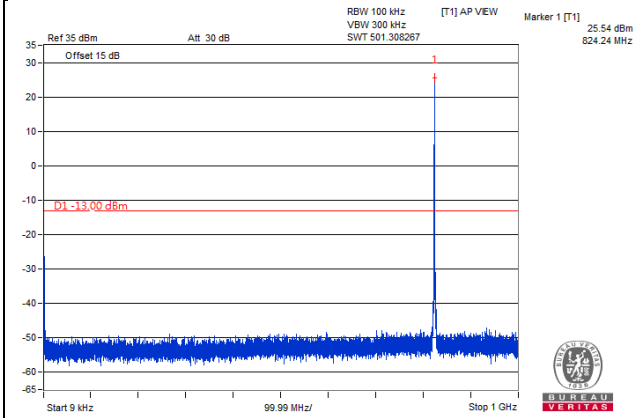

Frequency Range : 1GHz~10GHz

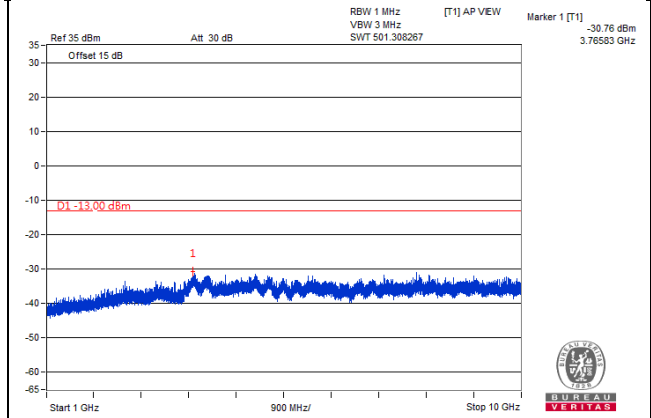

Frequency Range : 10GHz~27GHz

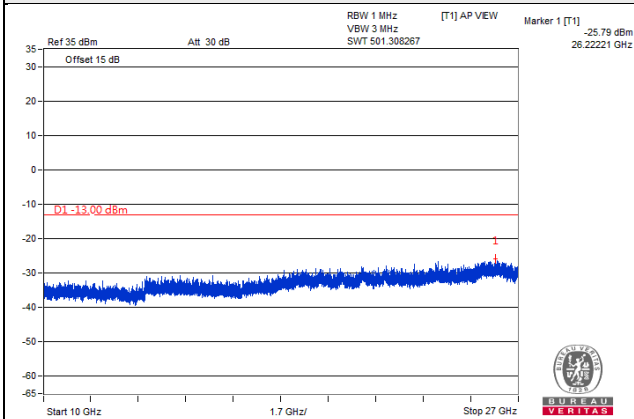

*The 9kHz signal over the limit is from Spectrum.

LTE Band 26, Channel Bandwidth 1.4MHz

Channel 26915 (836.5MHz)

Frequency Range : 9kHz~1GHz

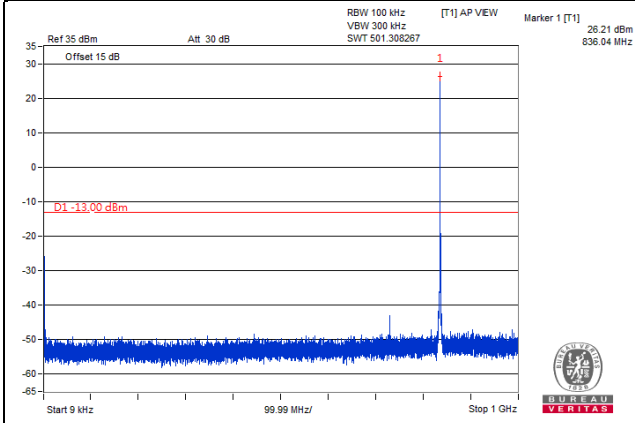

Frequency Range : 1GHz~10GHz

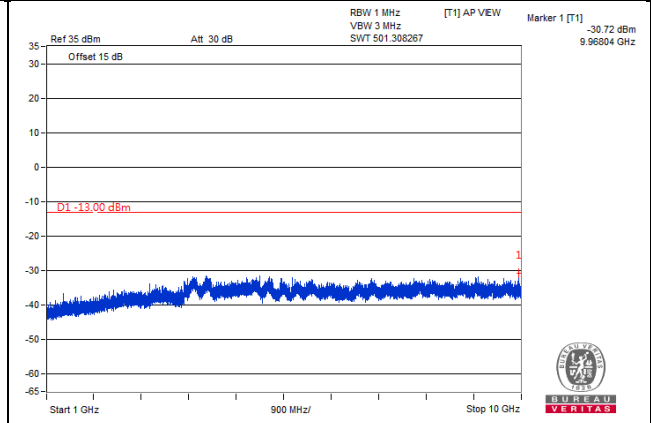

Frequency Range : 10GHz~27GHz

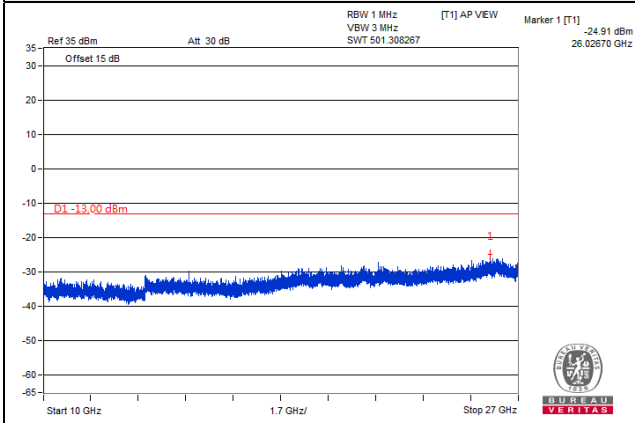

*The 9kHz signal over the limit is from Spectrum.

LTE Band 26, Channel Bandwidth 1.4MHz

Channel 27033 (848.3MHz)

Frequency Range : 9kHz~1GHz

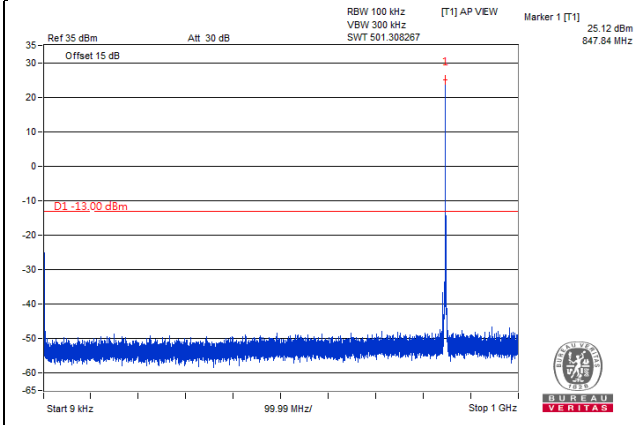

Frequency Range : 1GHz~10GHz

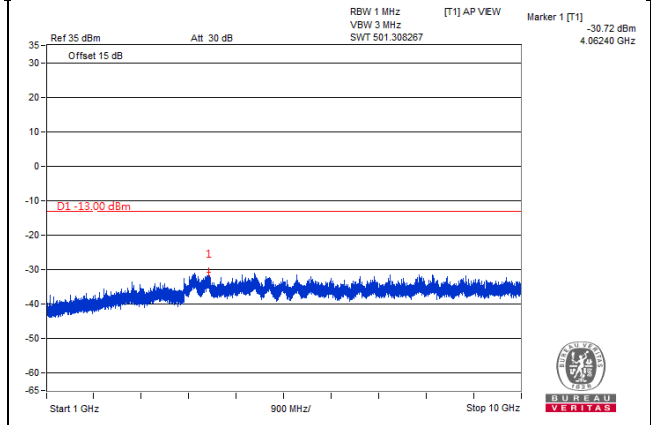

Frequency Range : 10GHz~27GHz

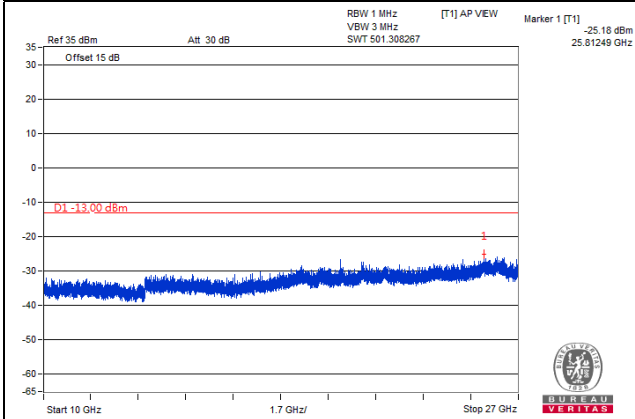

*The 9kHz signal over the limit is from Spectrum.

LTE Band 26, Channel Bandwidth 3MHz

Channel 26805 (825.5MHz)

Frequency Range : 9kHz~1GHz

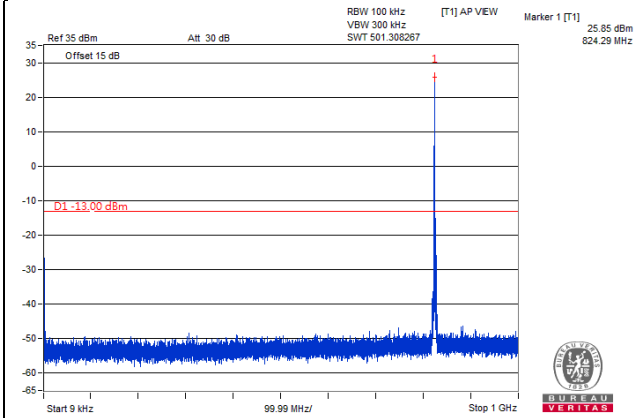

Frequency Range : 1GHz~10GHz

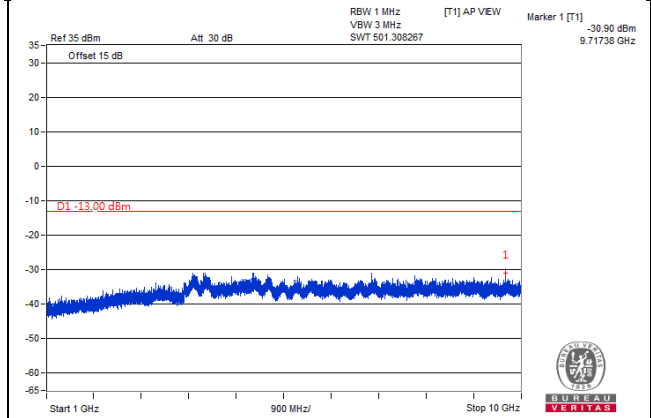

Frequency Range : 10GHz~27GHz

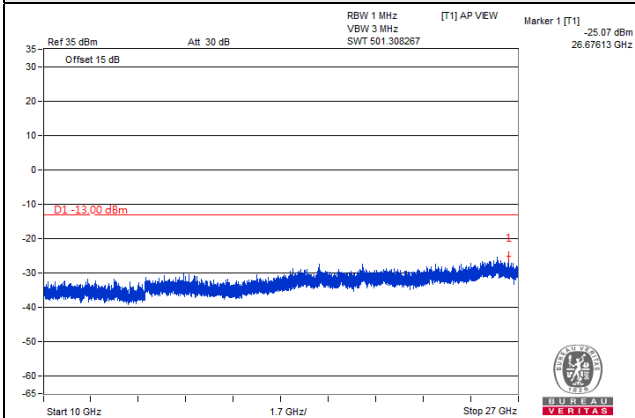

*The 9kHz signal over the limit is from Spectrum.

LTE Band 26, Channel Bandwidth 3MHz

Channel 26915 (836.5MHz)

Frequency Range : 9kHz~1GHz

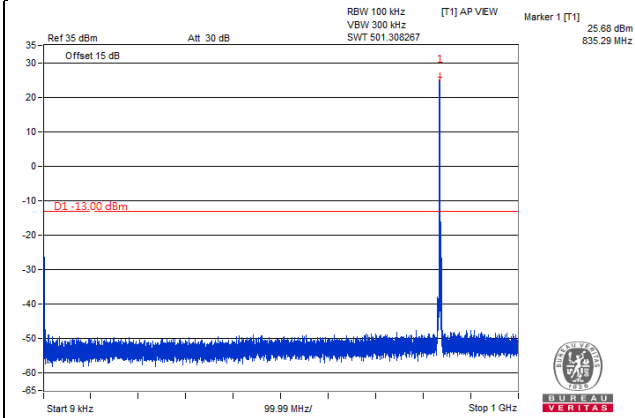

Frequency Range : 1GHz~10GHz

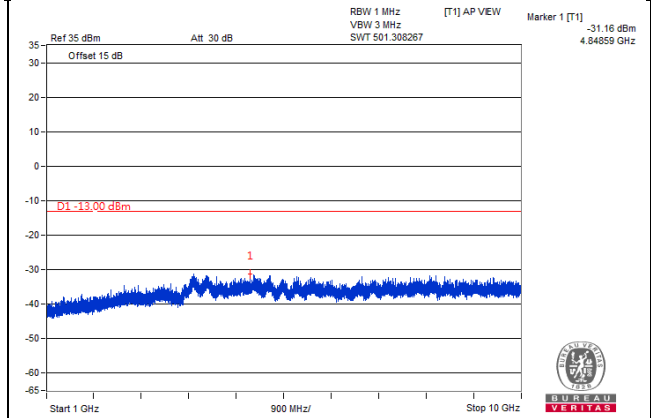

Frequency Range : 10GHz~27GHz

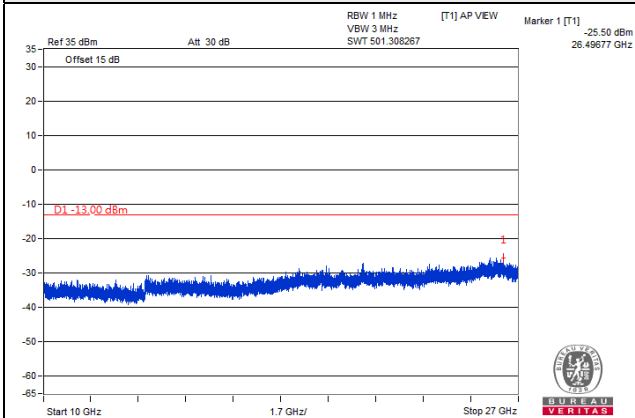

*The 9kHz signal over the limit is from Spectrum.

LTE Band 26, Channel Bandwidth 3MHz

Channel 27025 (847.5MHz)

Frequency Range : 9kHz~1GHz

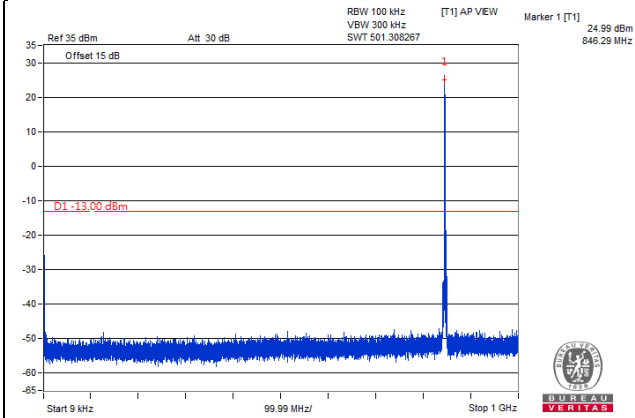

Frequency Range : 1GHz~10GHz

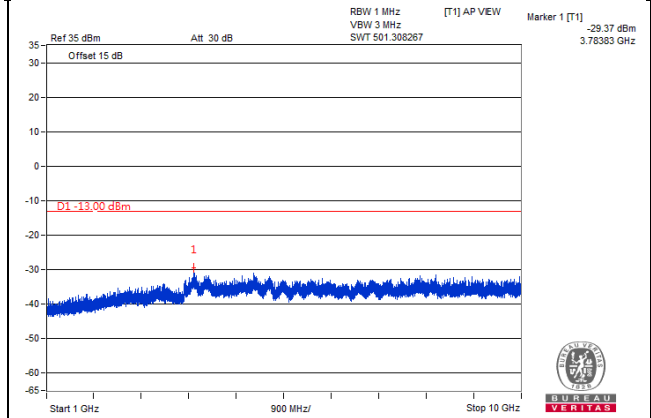

Frequency Range : 10GHz~27GHz

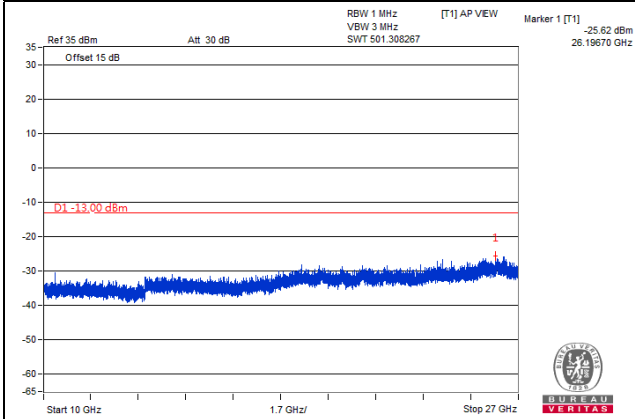

*The 9kHz signal over the limit is from Spectrum.

LTE Band 26, Channel Bandwidth 5MHz

Channel 26815 (826.5MHz)

Frequency Range : 9kHz~1GHz

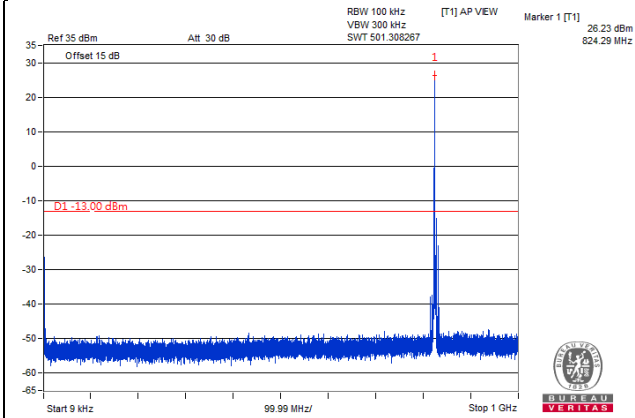

Frequency Range : 1GHz~10GHz

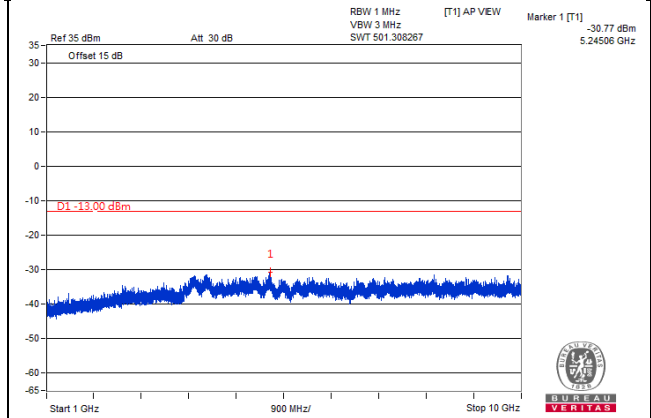

Frequency Range : 10GHz~27GHz

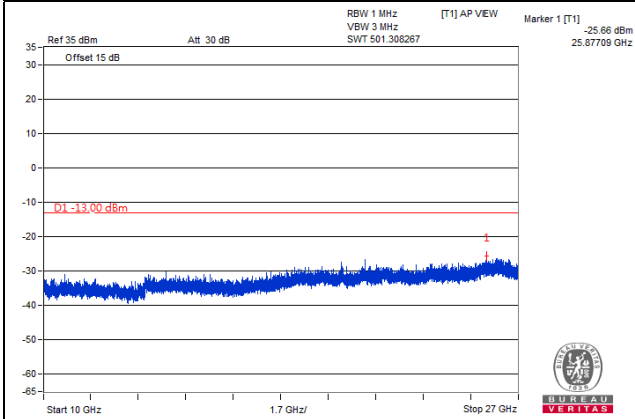

*The 9kHz signal over the limit is from Spectrum.

LTE Band 26, Channel Bandwidth 5MHz

Channel 26915 (836.5MHz)

Frequency Range : 9kHz~1GHz

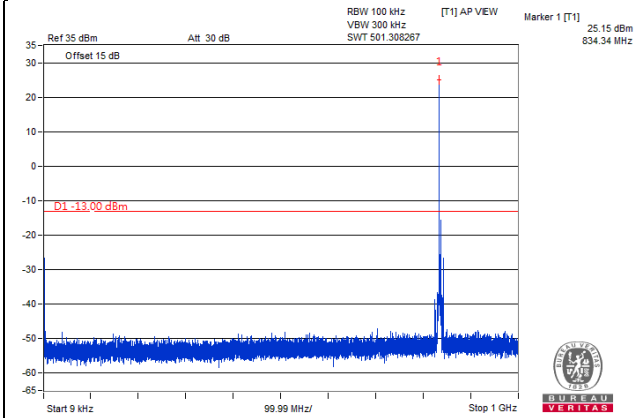

Frequency Range : 1GHz~10GHz

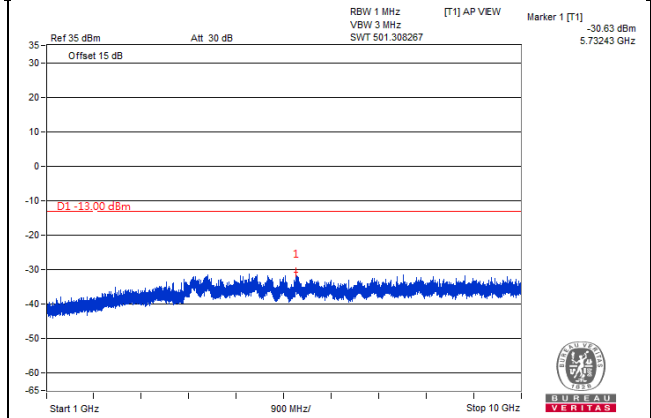

Frequency Range : 10GHz~27GHz

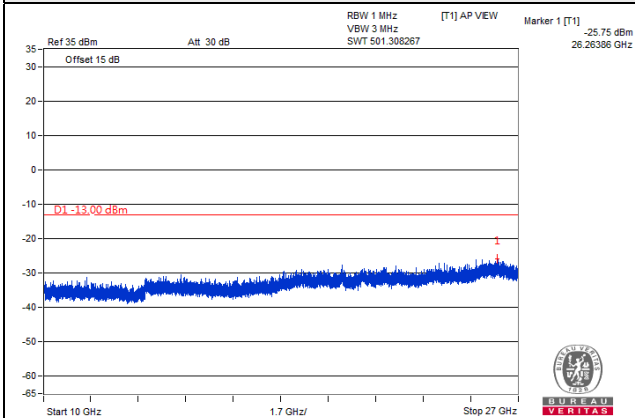

*The 9kHz signal over the limit is from Spectrum.

LTE Band 26, Channel Bandwidth 5MHz

Channel 27015 (846.5MHz)

Frequency Range : 9kHz~1GHz

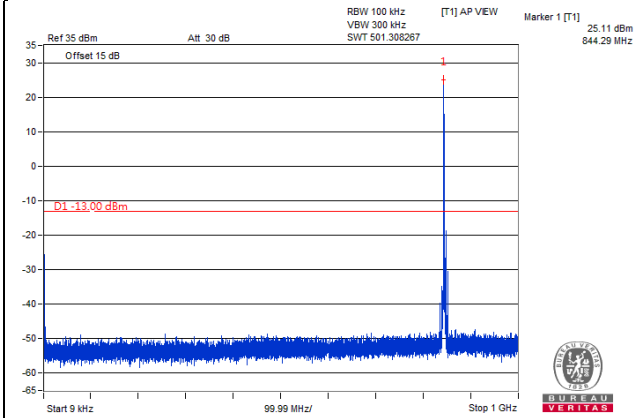

Frequency Range : 1GHz~10GHz

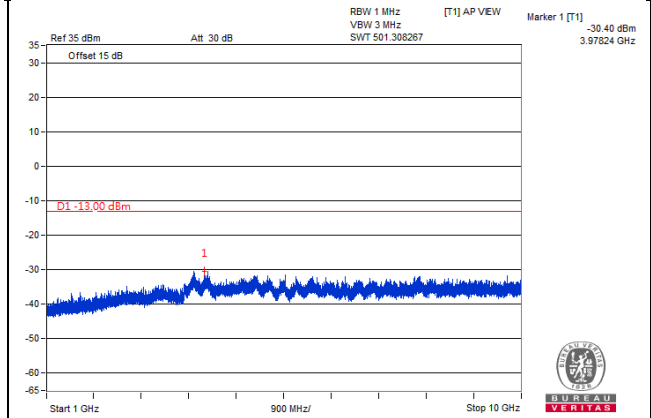

Frequency Range : 10GHz~27GHz

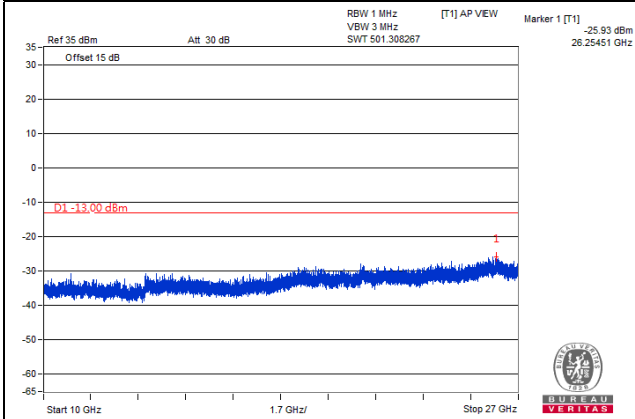

*The 9kHz signal over the limit is from Spectrum.

LTE Band 26, Channel Bandwidth 10MHz

Channel 26840 (829MHz)

Frequency Range : 9kHz~1GHz

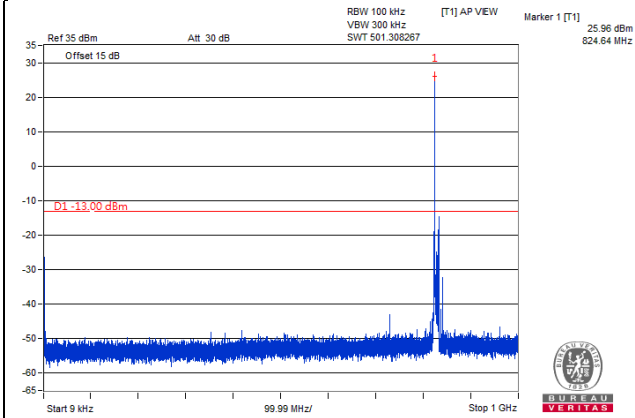

Frequency Range : 1GHz~10GHz

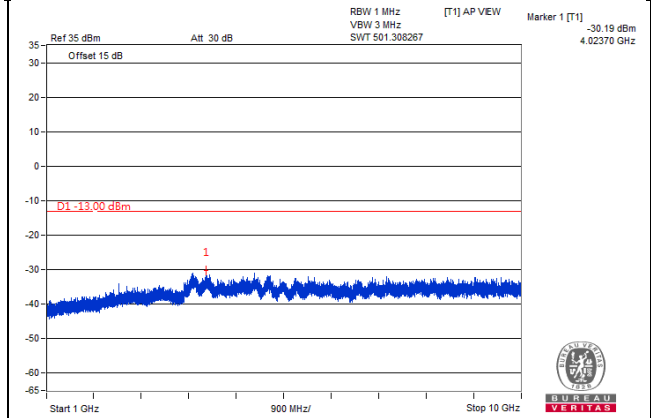

Frequency Range : 10GHz~27GHz

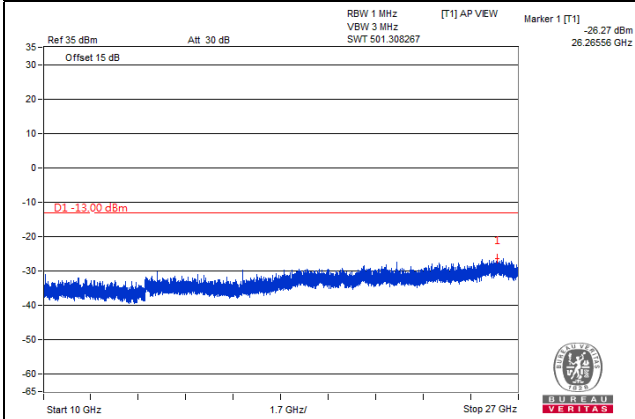

*The 9kHz signal over the limit is from Spectrum.

LTE Band 26, Channel Bandwidth 10MHz

Channel 26915 (836.5MHz)

Frequency Range : 9kHz~1GHz

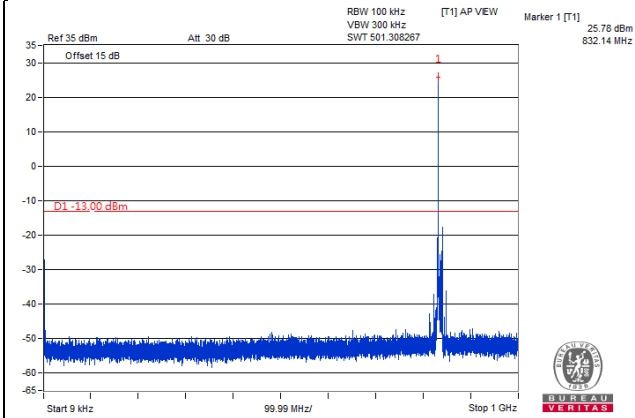

Frequency Range : 1GHz~10GHz

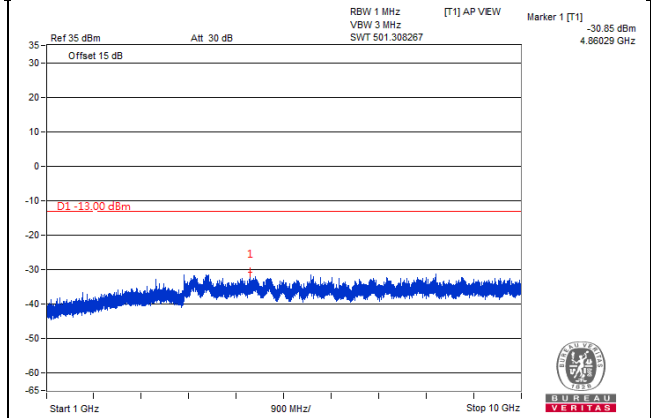

Frequency Range : 10GHz~27GHz

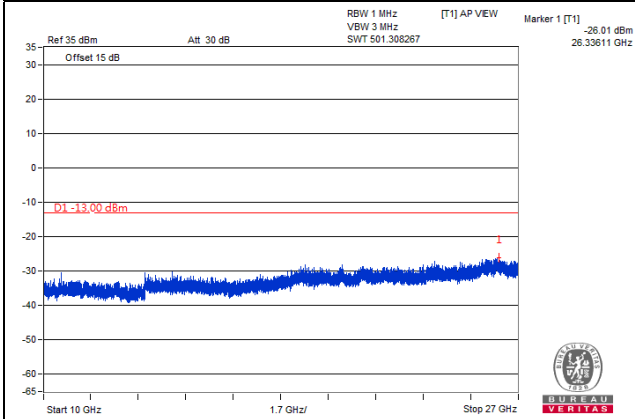

*The 9kHz signal over the limit is from Spectrum.

LTE Band 26, Channel Bandwidth 10MHz

Channel 26990 (844MHz)

Frequency Range : 9kHz~1GHz

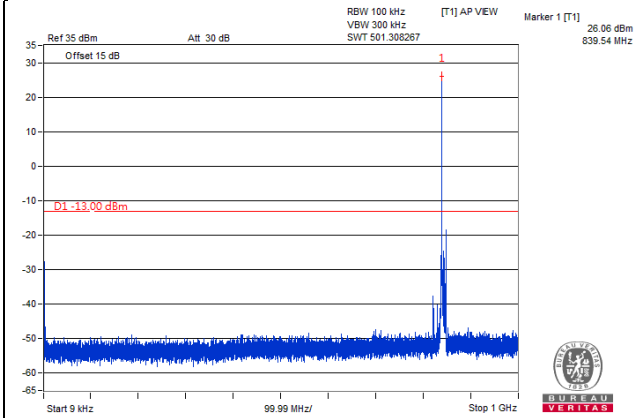

Frequency Range : 1GHz~10GHz

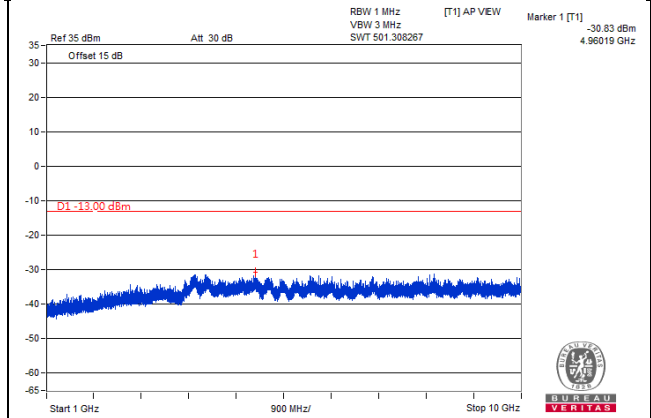

Frequency Range : 10GHz~27GHz

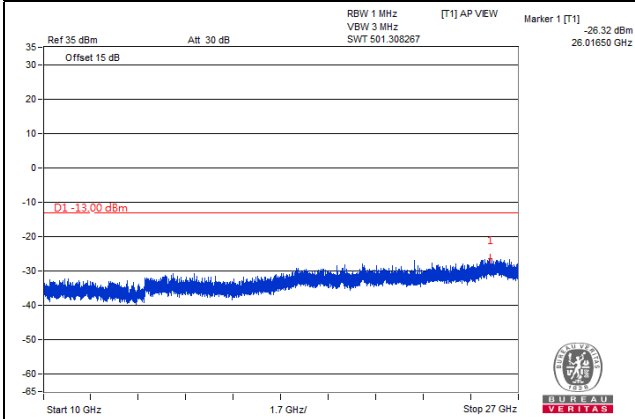

*The 9kHz signal over the limit is from Spectrum.

LTE Band 26, Channel Bandwidth 15MHz

Channel 26865 (831.5MHz)

Frequency Range : 9kHz~1GHz

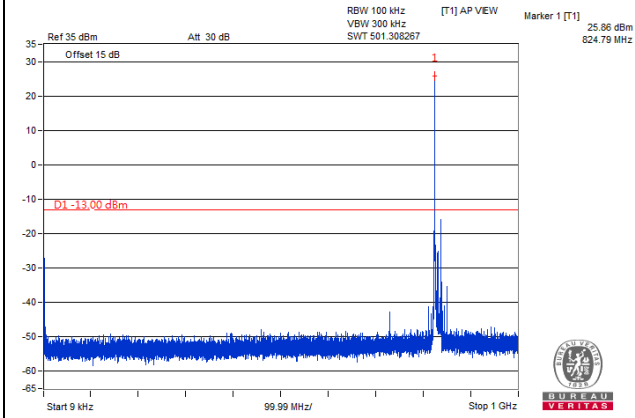

Frequency Range : 1GHz~10GHz

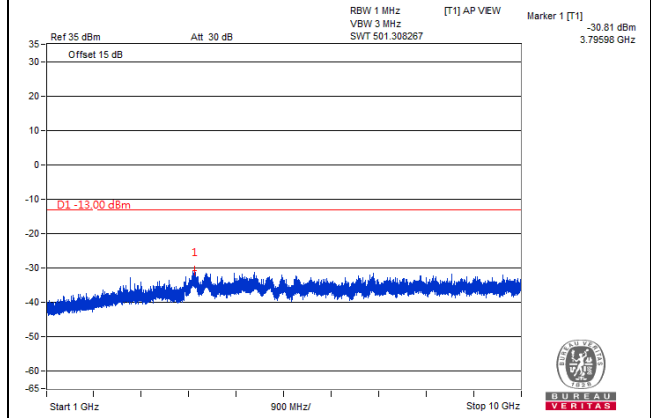

Frequency Range : 10GHz~27GHz

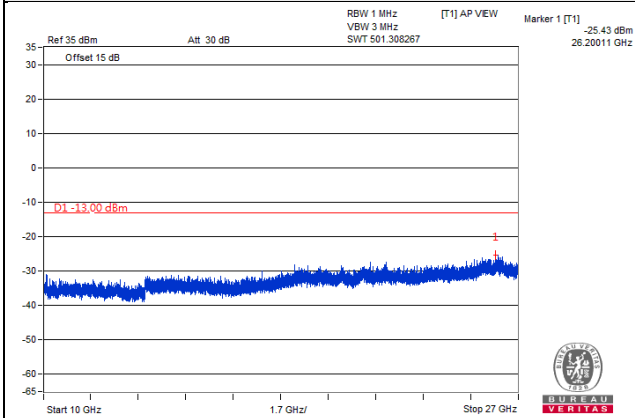

*The 9kHz signal over the limit is from Spectrum.

LTE Band 26, Channel Bandwidth 15MHz

Channel 26915 (836.5MHz)

Frequency Range : 9kHz~1GHz

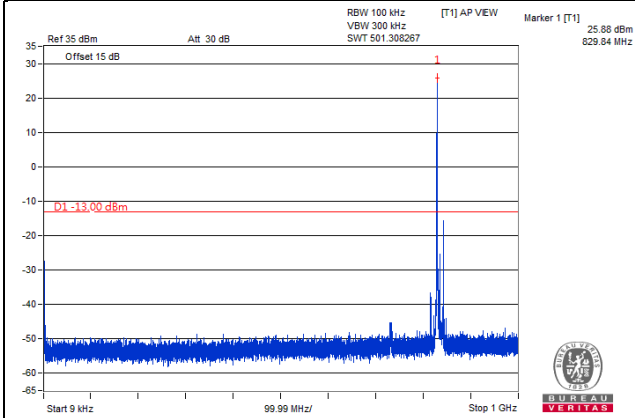

Frequency Range : 1GHz~10GHz

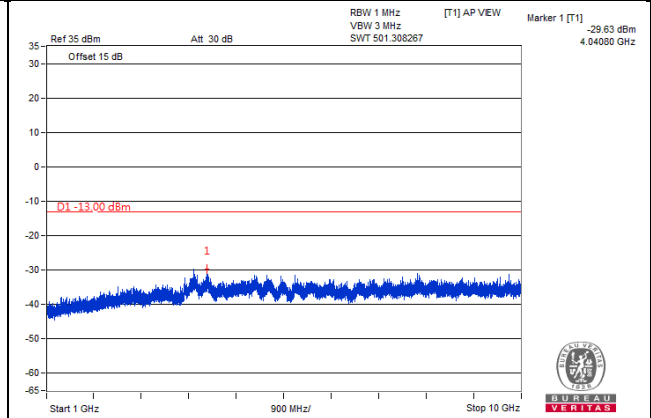

Frequency Range : 10GHz~27GHz

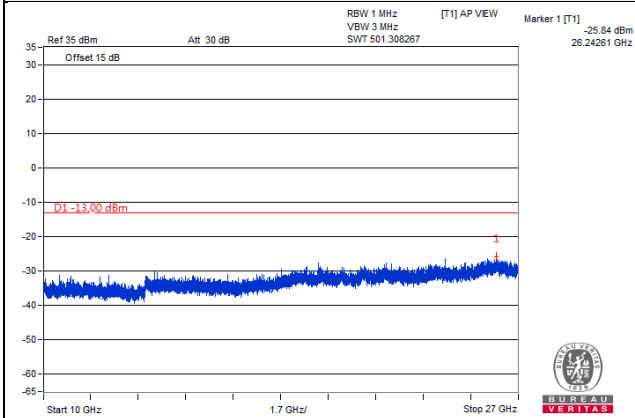

*The 9kHz signal over the limit is from Spectrum.

LTE Band 26, Channel Bandwidth 15MHz

Channel 26965 (841.5MHz)

Frequency Range : 9kHz~1GHz

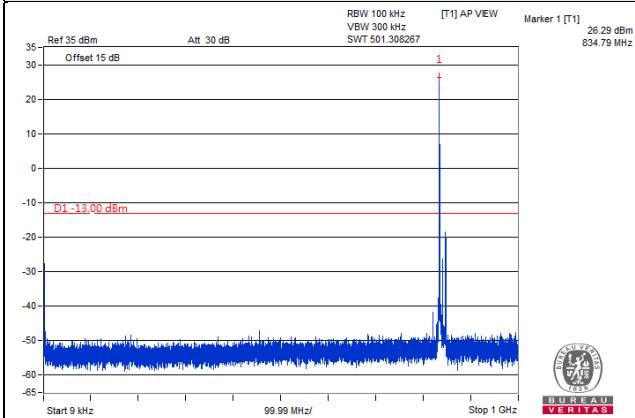

Frequency Range : 1GHz~10GHz

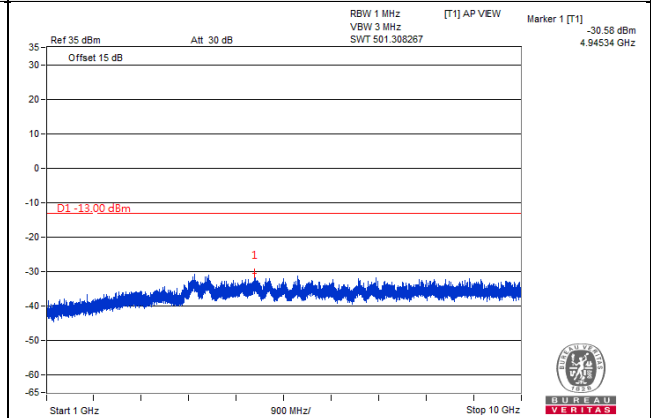

Frequency Range : 10GHz~27GHz

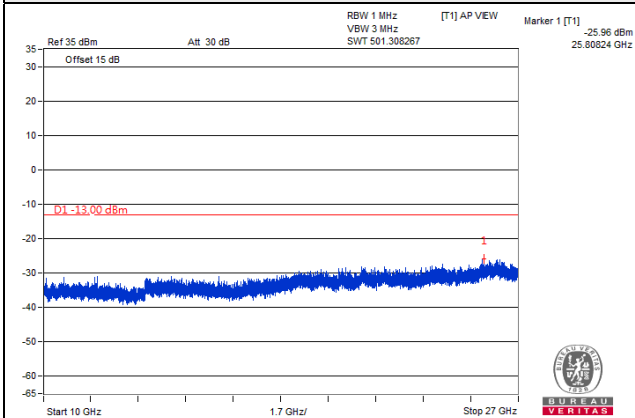

*The 9kHz signal over the limit is from Spectrum.

4.8 Radiated Emission Measurement

4.8.1 Limits of Radiated Emission Measurement

The power of any emission outside of the authorized operating frequency ranges must be attenuated below the transmitting power (P) by a factor of at least $43 + 10 \log(P)$ dB. The emission limit equal to -13dBm .

4.8.2 Test Procedure

- a. Substitution method is used for E.I.R.P measurement. In the semi-anechoic chamber, EUT placed on the 0.8m height of Turn Table, rotated the table around 360 degrees to search the maximum radiation power and receiver antenna shall be rotated vertical and horizontal polarization and moved height from 1m to 4m to find the maximum polar radiated power. The "Read Value" is the spectrum reading the maximum power value.
- b. The substitution horn antenna is substituted for EUT at the same position and signals generator export the CW signal to the substitution antenna via a TX cable. Rotated the Turn Table and moved receiving antenna to find the maximum radiation power. Adjust output power level of S.G to get a Value of spectrum reading equal to "Read Value" of step a. Record the power level of S.G
- c. $\text{EIRP} = \text{Output power level of S.G} - \text{TX cable loss} + \text{Antenna gain of substitution horn}$.
- d. E.R.P power can be calculated form E.I.R.P power by subtracting the gain of dipole, $\text{E.R.P power} = \text{E.I.R.P power} - 2.15\text{dBi}$.

NOTE: The resolution bandwidth and video bandwidth of test receiver/spectrum analyzer is 1MHz/3MHz.

4.8.3 Deviation from Test Standard

No deviation.

4.8.4 Test Setup

For radiated emission 30MHz to 1GHz

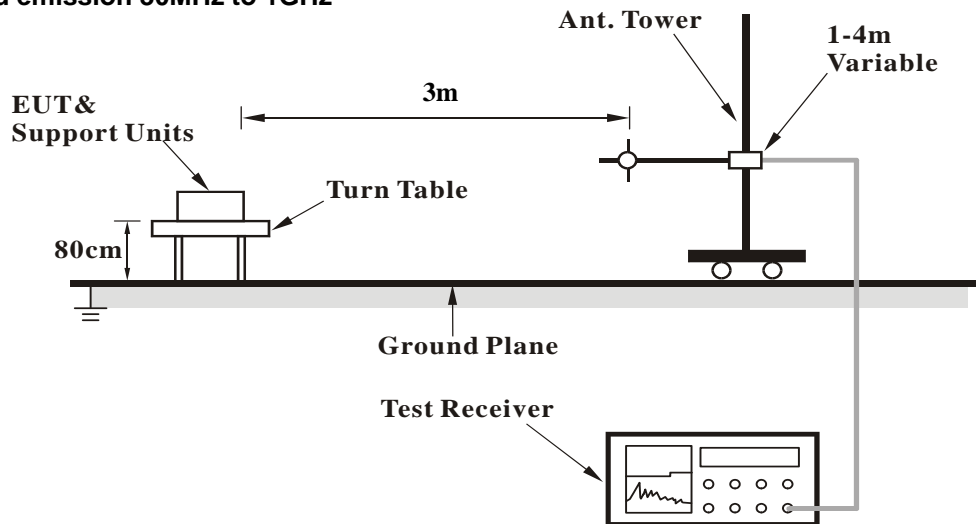

For radiated emission above 1GHz

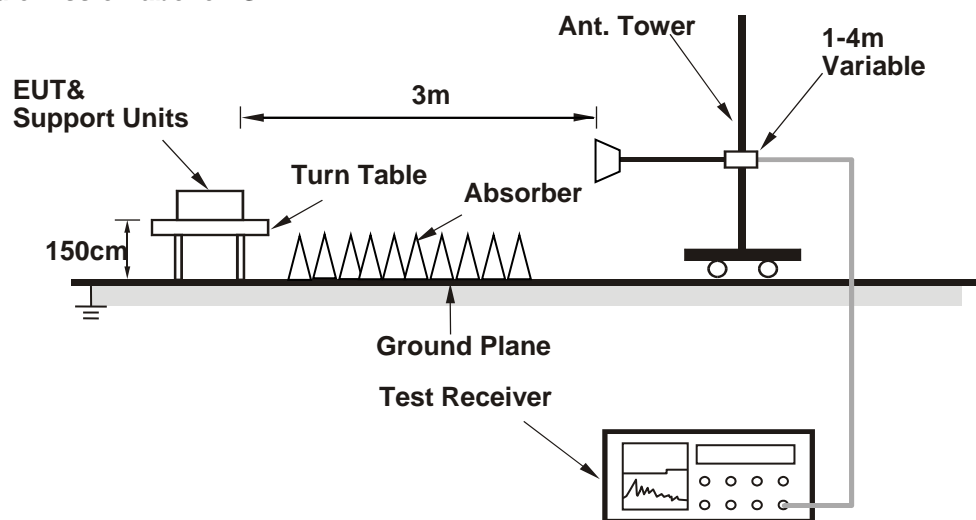

For the actual test configuration, please refer to the attached file (Test Setup Photo).

4.8.5 Test Results

Below 1GHz

LTE Band 26, Channel Bandwidth 1.4MHz

Mode	TX channel 26797 (824.7MHz)	Frequency Range	Below 1000 MHz
Environmental Conditions	25deg. C, 70%RH	Input Power	120Vac, 60Hz
Tested By	Noah Chang		

Antenna Polarity & Test Distance: Horizontal at 3 M							
No.	Freq. (MHz)	Reading (dBm)	S.G Power Value (dBm)	Correction Factor (dB)	ERP (dBm)	Limit (dBm)	Margin (dB)
1	33.88	-56.9	-44.5	-11.7	-56.2	-13.0	-43.2
2	62.98	-53.0	-53.8	-6.8	-60.6	-13.0	-47.6
3	142.52	-38.0	-45.2	-0.3	-45.5	-13.0	-32.5
4	189.08	-57.1	-72.1	4.1	-68.0	-13.0	-55.0
5	569.32	-64.0	-71.0	4.5	-66.5	-13.0	-53.5
6	817.64	-65.3	-65.8	4.0	-61.8	-13.0	-48.8

Remarks:

- ERP (dBm) = S.G Value (dBm) + Correction Factor (dB).
- Correction Factor (dB) = Substitution Antenna Gain (dB) + Cable Loss (dB).

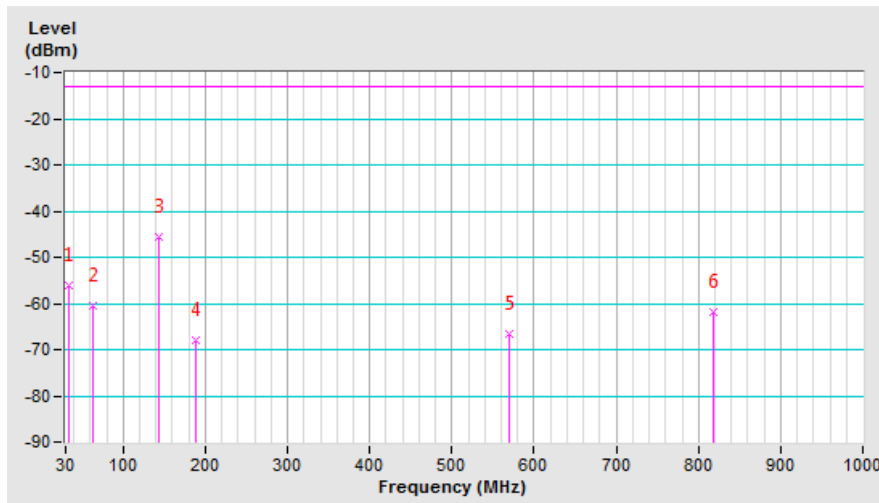

Mode	TX channel 26797 (824.7MHz)	Frequency Range	Below 1000 MHz
Environmental Conditions	25deg. C, 70%RH	Input Power	120Vac, 60Hz
Tested By	Noah Chang		

Antenna Polarity & Test Distance: Vertical at 3 M							
No.	Freq. (MHz)	Reading (dBm)	S.G Power Value (dBm)	Correction Factor (dB)	ERP (dBm)	Limit (dBm)	Margin (dB)
1	51.34	-48.9	-48.8	-8.9	-57.7	-13.0	-44.7
2	142.52	-42.1	-47.1	-0.3	-47.4	-13.0	-34.4
3	289.96	-69.2	-76.4	5.2	-71.2	-13.0	-58.2
4	621.70	-70.8	-72.6	4.6	-68.0	-13.0	-55.0
5	747.80	-60.8	-62.0	4.7	-57.3	-13.0	-44.3
6	817.64	-70.8	-70.6	4.0	-66.6	-13.0	-53.6

Remarks:

1. ERP (dBm) = S.G Value (dBm) + Correction Factor (dB).
2. Correction Factor (dB) = Substitution Antenna Gain (dB) + Cable Loss (dB).

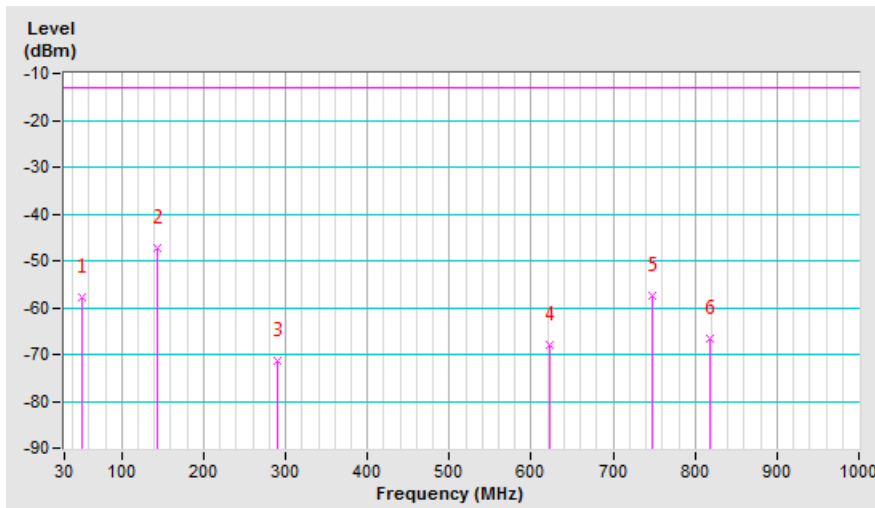

LTE Band 26, Channel Bandwidth 5MHz

Mode	TX channel 26815 (826.5MHz)	Frequency Range	Below 1000 MHz
Environmental Conditions	25deg. C, 70%RH	Input Power	120Vac, 60Hz
Tested By	Noah Chang		

Antenna Polarity & Test Distance: Horizontal at 3 M							
No.	Freq. (MHz)	Reading (dBm)	S.G Power Value (dBm)	Correction Factor (dB)	ERP (dBm)	Limit (dBm)	Margin (dB)
1	80.44	-59.7	-66.1	-1.6	-67.7	-13.0	-54.7
2	142.52	-37.2	-44.3	-0.3	-44.6	-13.0	-31.6
3	189.08	-61.2	-76.2	4.1	-72.1	-13.0	-59.1
4	425.76	-66.0	-74.9	5.2	-69.7	-13.0	-56.7
5	569.32	-63.5	-70.6	4.5	-66.1	-13.0	-53.1
6	817.64	-64.7	-65.1	4.0	-61.1	-13.0	-48.1

Remarks:

- ERP (dBm) = S.G Value (dBm) + Correction Factor (dB).
- Correction Factor (dB) = Substitution Antenna Gain (dB) + Cable Loss (dB).

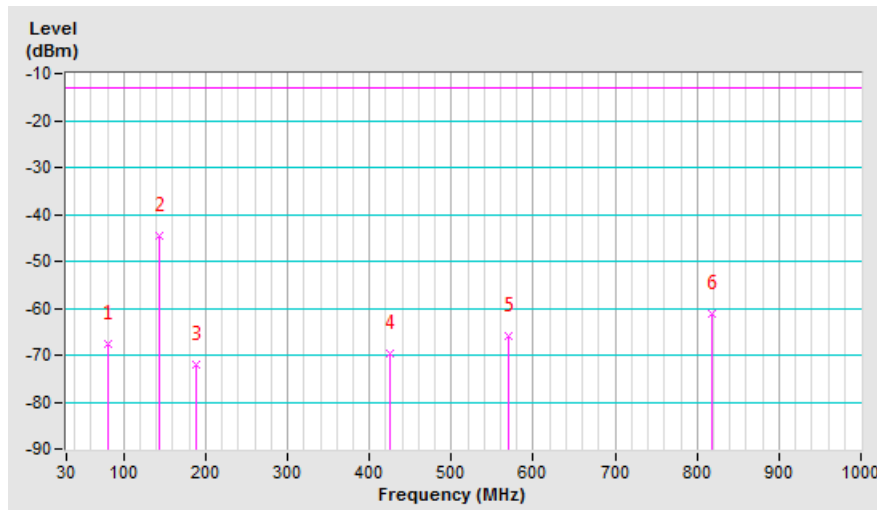

Mode	TX channel 26815 (826.5MHz)	Frequency Range	Below 1000 MHz
Environmental Conditions	25deg. C, 70%RH	Input Power	120Vac, 60Hz
Tested By	Noah Chang		

Antenna Polarity & Test Distance: Vertical at 3 M							
No.	Freq. (MHz)	Reading (dBm)	S.G Power Value (dBm)	Correction Factor (dB)	ERP (dBm)	Limit (dBm)	Margin (dB)
1	66.86	-54.6	-57.5	-5.8	-63.3	-13.0	-50.3
2	142.52	-42.1	-47.1	-0.3	-47.4	-13.0	-34.4
3	237.58	-65.8	-73.2	5.4	-67.8	-13.0	-54.8
4	369.50	-68.4	-76.9	5.2	-71.7	-13.0	-58.7
5	615.88	-71.8	-73.6	4.6	-69.0	-13.0	-56.0
6	730.34	-67.0	-68.4	4.9	-63.5	-13.0	-50.5

Remarks:

- ERP (dBm) = S.G Value (dBm) + Correction Factor (dB).
- Correction Factor (dB) = Substitution Antenna Gain (dB) + Cable Loss (dB).

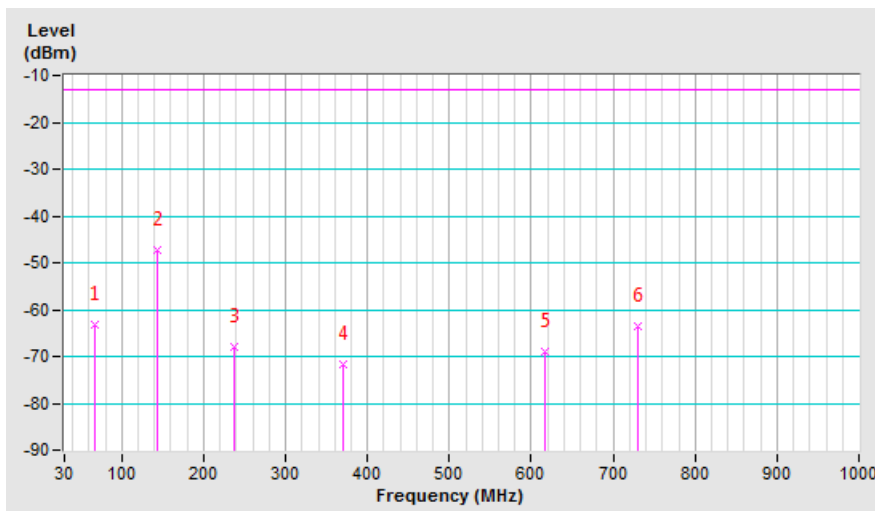

LTE Band 26, Channel Bandwidth 15MHz

Mode	TX channel 26865 (831.5MHz)	Frequency Range	Below 1000 MHz
Environmental Conditions	25deg. C, 70%RH	Input Power	120Vac, 60Hz
Tested By	Noah Chang		

Antenna Polarity & Test Distance: Horizontal at 3 M							
No.	Freq. (MHz)	Reading (dBm)	S.G Power Value (dBm)	Correction Factor (dB)	ERP (dBm)	Limit (dBm)	Margin (dB)
1	61.04	-56.0	-55.6	-7.3	-62.9	-13.0	-49.9
2	142.52	-37.2	-44.4	-0.3	-44.7	-13.0	-31.7
3	189.08	-59.6	-74.5	4.1	-70.4	-13.0	-57.4
4	425.76	-66.0	-74.9	5.2	-69.7	-13.0	-56.7
5	569.32	-66.5	-73.5	4.5	-69.0	-13.0	-56.0
6	817.64	-66.5	-66.9	4.0	-62.9	-13.0	-49.9

Remarks:

- ERP (dBm) = S.G Value (dBm) + Correction Factor (dB).
- Correction Factor (dB) = Substitution Antenna Gain (dB) + Cable Loss (dB).

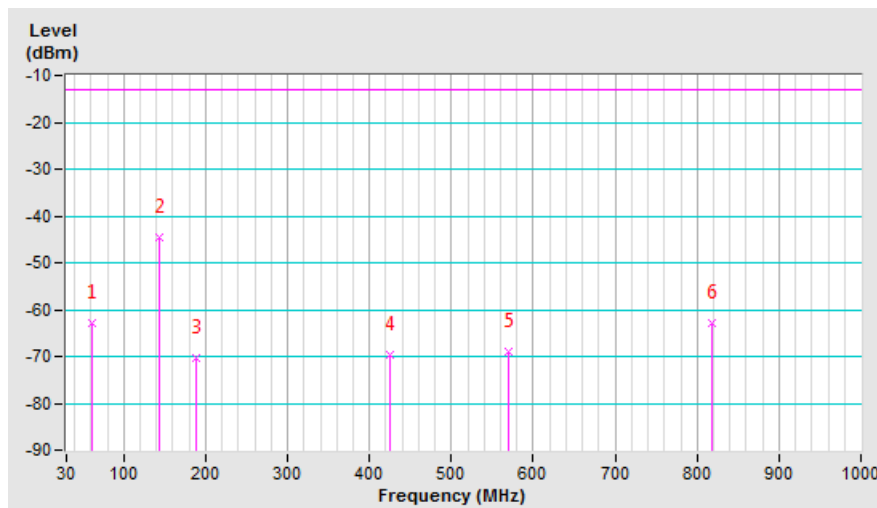

Mode	TX channel 26865 (831.5MHz)	Frequency Range	Below 1000 MHz
Environmental Conditions	25deg. C, 70%RH	Input Power	120Vac, 60Hz
Tested By	Noah Chang		

Antenna Polarity & Test Distance: Vertical at 3 M							
No.	Freq. (MHz)	Reading (dBm)	S.G Power Value (dBm)	Correction Factor (dB)	ERP (dBm)	Limit (dBm)	Margin (dB)
1	66.86	-54.6	-57.5	-5.8	-63.3	-13.0	-50.3
2	142.52	-42.1	-47.1	-0.3	-47.4	-13.0	-34.4
3	237.58	-65.8	-73.2	5.4	-67.8	-13.0	-54.8
4	369.50	-68.4	-76.9	5.2	-71.7	-13.0	-58.7
5	615.88	-71.8	-73.6	4.6	-69.0	-13.0	-56.0
6	730.34	-67.0	-68.4	4.9	-63.5	-13.0	-50.5

Remarks:

1. ERP (dBm) = S.G Value (dBm) + Correction Factor (dB).
2. Correction Factor (dB) = Substitution Antenna Gain (dB) + Cable Loss (dB).

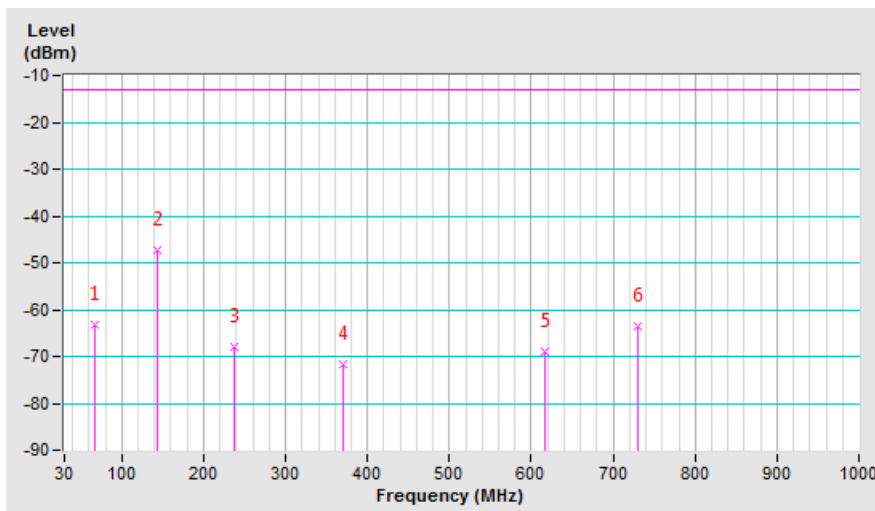

Above 1GHz
 LTE Band 26, Channel Bandwidth 1.4MHz

Mode	TX channel 26797 (824.7MHz)	Frequency Range	1GH~10GHz
Environmental Conditions	25deg. C, 70%RH	Input Power	120Vac, 60Hz
Tested By	Noah Chang		

Antenna Polarity & Test Distance: Horizontal at 3 M							
No.	Freq. (MHz)	Reading (dBm)	S.G Power Value (dBm)	Correction Factor (dB)	ERP (dBm)	Limit (dBm)	Margin (dB)
1	1649.40	-65.5	-68.7	5.5	-63.2	-13.0	-50.2
Antenna Polarity & Test Distance: Vertical at 3 M							
No.	Freq. (MHz)	Reading (dBm)	S.G Power Value (dBm)	Correction Factor (dB)	ERP (dBm)	Limit (dBm)	Margin (dB)
1	1649.40	-66.5	-67.7	5.5	-62.2	-13.0	-49.2

Remarks:

1. ERP (dBm) = S.G Value (dBm) + Correction Factor (dB).
2. Correction Factor (dB) = Substitution Antenna Gain (dB) + Cable Loss (dB).

Mode	TX channel 26915 (836.5MHz)	Frequency Range	1GH~10GHz
Environmental Conditions	25deg. C, 70%RH	Input Power	120Vac, 60Hz
Tested By	Noah Chang		

Antenna Polarity & Test Distance: Horizontal at 3 M							
No.	Freq. (MHz)	Reading (dBm)	S.G Power Value (dBm)	Correction Factor (dB)	ERP (dBm)	Limit (dBm)	Margin (dB)
1	1673.00	-68.2	-71.2	5.5	-65.7	-13.0	-52.7
Antenna Polarity & Test Distance: Vertical at 3 M							
No.	Freq. (MHz)	Reading (dBm)	S.G Power Value (dBm)	Correction Factor (dB)	ERP (dBm)	Limit (dBm)	Margin (dB)
1	1673.00	-67.3	-68.1	5.5	-62.6	-13.0	-49.6

Remarks:

1. ERP (dBm) = S.G Value (dBm) + Correction Factor (dB).
2. Correction Factor (dB) = Substitution Antenna Gain (dB) + Cable Loss (dB).

Mode	TX channel 27033 (848.3MHz)	Frequency Range	1GH~10GHz
Environmental Conditions	25deg. C, 70%RH	Input Power	120Vac, 60Hz
Tested By	Noah Chang		

Antenna Polarity & Test Distance: Horizontal at 3 M							
No.	Freq. (MHz)	Reading (dBm)	S.G Power Value (dBm)	Correction Factor (dB)	ERP (dBm)	Limit (dBm)	Margin (dB)
1	1696.60	-68.2	-71.0	5.6	-65.4	-13.0	-52.4
Antenna Polarity & Test Distance: Vertical at 3 M							
No.	Freq. (MHz)	Reading (dBm)	S.G Power Value (dBm)	Correction Factor (dB)	ERP (dBm)	Limit (dBm)	Margin (dB)
1	1696.60	-67.0	-67.6	5.6	-62.0	-13.0	-49.0

Remarks:

1. ERP (dBm) = S.G Value (dBm) + Correction Factor (dB).
2. Correction Factor (dB) = Substitution Antenna Gain (dB) + Cable Loss (dB).

LTE Band 26, Channel Bandwidth 5MHz

Mode	TX channel 26815 (826.5MHz)	Frequency Range	1GH~10GHz
Environmental Conditions	25deg. C, 70%RH	Input Power	120Vac, 60Hz
Tested By	Noah Chang		

Antenna Polarity & Test Distance: Horizontal at 3 M							
No.	Freq. (MHz)	Reading (dBm)	S.G Power Value (dBm)	Correction Factor (dB)	ERP (dBm)	Limit (dBm)	Margin (dB)
1	1653.00	-65.7	-68.9	5.5	-63.4	-13.0	-50.4
Antenna Polarity & Test Distance: Vertical at 3 M							
No.	Freq. (MHz)	Reading (dBm)	S.G Power Value (dBm)	Correction Factor (dB)	ERP (dBm)	Limit (dBm)	Margin (dB)
1	1653.00	-68.9	-67.8	5.5	-62.3	-13.0	-49.3

Remarks:

1. ERP (dBm) = S.G Value (dBm) + Correction Factor (dB).
2. Correction Factor (dB) = Substitution Antenna Gain (dB) + Cable Loss (dB).

Mode	TX channel 26915 (836.5MHz)	Frequency Range	1GH~10GHz
Environmental Conditions	25deg. C, 70%RH	Input Power	120Vac, 60Hz
Tested By	Noah Chang		

Antenna Polarity & Test Distance: Horizontal at 3 M							
No.	Freq. (MHz)	Reading (dBm)	S.G Power Value (dBm)	Correction Factor (dB)	ERP (dBm)	Limit (dBm)	Margin (dB)
1	1673.00	-67.7	-70.7	5.5	-65.2	-13.0	-52.2
Antenna Polarity & Test Distance: Vertical at 3 M							
No.	Freq. (MHz)	Reading (dBm)	S.G Power Value (dBm)	Correction Factor (dB)	ERP (dBm)	Limit (dBm)	Margin (dB)
1	1673.00	-66.3	-67.1	5.5	-61.6	-13.0	-48.6

Remarks:

1. ERP (dBm) = S.G Value (dBm) + Correction Factor (dB).
2. Correction Factor (dB) = Substitution Antenna Gain (dB) + Cable Loss (dB).

Mode	TX channel 27015 (846.5MHz)	Frequency Range	1GH~10GHz
Environmental Conditions	25deg. C, 70%RH	Input Power	120Vac, 60Hz
Tested By	Noah Chang		

Antenna Polarity & Test Distance: Horizontal at 3 M							
No.	Freq. (MHz)	Reading (dBm)	S.G Power Value (dBm)	Correction Factor (dB)	ERP (dBm)	Limit (dBm)	Margin (dB)
1	1693.00	-64.9	-67.7	5.6	-62.1	-13.0	-49.1
Antenna Polarity & Test Distance: Vertical at 3 M							
No.	Freq. (MHz)	Reading (dBm)	S.G Power Value (dBm)	Correction Factor (dB)	ERP (dBm)	Limit (dBm)	Margin (dB)
1	1693.00	-66.0	-66.6	5.6	-61.0	-13.0	-48.0

Remarks:

1. $ERP (dBm) = S.G \text{ Value (dBm)} + \text{Correction Factor (dB)}$.
2. $\text{Correction Factor (dB)} = \text{Substitution Antenna Gain (dB)} + \text{Cable Loss (dB)}$.

LTE Band 26, Channel Bandwidth 15MHz

Mode	TX channel 26865 (831.5MHz)	Frequency Range	1GH~10GHz
Environmental Conditions	25deg. C, 70%RH	Input Power	120Vac, 60Hz
Tested By	Noah Chang		

Antenna Polarity & Test Distance: Horizontal at 3 M							
No.	Freq. (MHz)	Reading (dBm)	S.G Power Value (dBm)	Correction Factor (dB)	ERP (dBm)	Limit (dBm)	Margin (dB)
1	1663.00	-65.8	-69.0	5.6	-63.4	-13.0	-50.4
Antenna Polarity & Test Distance: Vertical at 3 M							
No.	Freq. (MHz)	Reading (dBm)	S.G Power Value (dBm)	Correction Factor (dB)	ERP (dBm)	Limit (dBm)	Margin (dB)
1	1663.00	-66.7	-67.7	5.6	-62.1	-13.0	-49.1

Remarks:

1. ERP (dBm) = S.G Value (dBm) + Correction Factor (dB).
2. Correction Factor (dB) = Substitution Antenna Gain (dB) + Cable Loss (dB).

Mode	TX channel 26915 (836.5MHz)	Frequency Range	1GH~10GHz
Environmental Conditions	25deg. C, 70%RH	Input Power	120Vac, 60Hz
Tested By	Noah Chang		

Antenna Polarity & Test Distance: Horizontal at 3 M							
No.	Freq. (MHz)	Reading (dBm)	S.G Power Value (dBm)	Correction Factor (dB)	ERP (dBm)	Limit (dBm)	Margin (dB)
1	1673.00	-68.0	-71.0	5.5	-65.5	-13.0	-52.5
Antenna Polarity & Test Distance: Vertical at 3 M							
No.	Freq. (MHz)	Reading (dBm)	S.G Power Value (dBm)	Correction Factor (dB)	ERP (dBm)	Limit (dBm)	Margin (dB)
1	1673.00	-66.7	-67.4	5.5	-61.9	-13.0	-48.9

Remarks:

1. ERP (dBm) = S.G Value (dBm) + Correction Factor (dB).
2. Correction Factor (dB) = Substitution Antenna Gain (dB) + Cable Loss (dB).

Mode	TX channel 26965 (841.5MHz)	Frequency Range	1GH~10GHz
Environmental Conditions	25deg. C, 70%RH	Input Power	120Vac, 60Hz
Tested By	Noah Chang		

Antenna Polarity & Test Distance: Horizontal at 3 M							
No.	Freq. (MHz)	Reading (dBm)	S.G Power Value (dBm)	Correction Factor (dB)	ERP (dBm)	Limit (dBm)	Margin (dB)
1	1683.00	-65.8	-68.6	5.5	-63.1	-13.0	-50.1
Antenna Polarity & Test Distance: Vertical at 3 M							
No.	Freq. (MHz)	Reading (dBm)	S.G Power Value (dBm)	Correction Factor (dB)	ERP (dBm)	Limit (dBm)	Margin (dB)
1	1683.00	-67.3	-68.0	5.5	-62.5	-13.0	-49.5

Remarks:

1. $ERP (dBm) = S.G \text{ Value (dBm)} + \text{Correction Factor (dB)}$.
2. $\text{Correction Factor (dB)} = \text{Substitution Antenna Gain (dB)} + \text{Cable Loss (dB)}$.

5 Pictures of Test Arrangements

Please refer to the attached file (Test Setup Photo).

Appendix – Information of the Testing Laboratories

We, Bureau Veritas Consumer Products Services (H.K.) Ltd., Taoyuan Branch, were founded in 1988 to provide our best service in EMC, Radio, Telecom and Safety consultation. Our laboratories are FCC recognized accredited test firms and accredited and approved according to ISO/IEC 17025.

If you have any comments, please feel free to contact us at the following:

Linko EMC/RF Lab

Tel: 886-2-26052180
Fax: 886-2-26051924

Hsin Chu EMC/RF/Telecom Lab

Tel: 886-3-6668565
Fax: 886-3-6668323

Hwa Ya EMC/RF/Safety Lab

Tel: 886-3-3183232
Fax: 886-3-3270892

Email: service.adt@tw.bureauveritas.com

Web Site: www.bureauveritas-adt.com

The address and road map of all our labs can be found in our web site also.

--- END ---