



User Manual

Project Name: IMA2 Series

Author: Wistron NeWeb Corporation

Revision: 1.3

Revision Date: 2022/08/12

Contact Information

Technical Support Website	https://supportiot.wnc.com.tw/
Company Website	www.wnc.com.tw

Revision History

Rev. #	Author	Summary of Changes	Date
1.0	WNC	Draft release	2020/05/11
1.1	WNC	Update design guide Update Important Notice to OEM integrators	2020/05/29
1.2	WNC	Update maximum antenna gain	2020/06/03
1.3	WNC	Update band config and data	2022/08/12

© Wistron NeWeb Corporation

THIS DOCUMENT AND THE INFORMATION CONTAINED HEREIN IS PROPRIETARY AND IS THE EXCLUSIVE PROPERTY OF WNC AND SHALL NOT BE DISTRIBUTED, REPRODUCED, OR DISCLOSED IN WHOLE OR IN PART WITHOUT PRIOR WRITTEN PERMISSION FROM WNC.

LIMITATION OF LIABILITY

THIS DOCUMENT AND THE INFORMATION CONTAINED HEREIN IS PURELY FOR DESIGN REFERENCE AND SUBJECT TO REVISION BY WNC AT ANY TIME. NOTHING IN THIS DOCUMENT SHALL BE CONSTRUED AS GRANTING ANY WARRANTY OR RIGHT TO USE THE MATERIAL CONTAINED HEREIN WITHOUT WNC'S PRIOR EXPRESS WRITTEN CONSENT. WNC SHALL NOT BE LIABLE FOR ANY USE, APPLICATION OR DEVELOPMENT DERIVED FROM THE MATERIAL WITHOUT SUCH PRIOR EXPRESS WRITTEN CONSENT.

Important Notice to OEM integrators

1. This module is limited to OEM installation ONLY.
2. This module is limited to installation in mobile or fixed applications, according to Part 2.1091(b).
3. The separate approval is required for all other operating configurations, including portable configurations with respect to Part 2.1093 and different antenna configurations
4. For FCC Part 15.31 (h) and (k): The host manufacturer is responsible for additional testing to verify compliance as a composite system. When testing the host device for compliance with Part 15 Subpart B, the host manufacturer is required to show compliance with Part 15 Subpart B while the transmitter module(s) are installed and operating. The modules should be transmitting and the evaluation should confirm that the module's intentional emissions are compliant (i.e. fundamental and out of band emissions). The host manufacturer must verify that there are no additional unintentional emissions other than what is permitted in Part 15 Subpart B or emissions are compliant with the transmitter(s) rule(s).

End Product Labeling

When the module is installed in the host device, the FCC ID label must be visible through a window on the final device or it must be visible when an access panel, door or cover is easily removed. If not, a second label must be placed on the outside of the final device that contains the following text: “Contains FCC ID: NKRIMA2”

“Contains IC: 4441A-IMA2”

The grantee's FCC ID/IC ID can be used only when all FCC/IC compliance requirements are met.

Antenna Installation

- (1) The antenna must be installed such that 20 cm is maintained between the antenna and users,
- (2) The transmitter module may not be co-located with any other transmitter or antenna.
- (3) To comply with FCC/IC regulations limiting both maximum RF output power and human exposure to RF radiation, the maximum antenna gain including cable loss in a mobile exposure condition must not exceed:

Standalone Condition:

- Gain(dBi) = 2 ± 0.5

Assuming collocated with an ordinary WLAN transmitter with 5 dBi antenna gain

- No WLAN in this case -

In the event that these conditions cannot be met (for example certain laptop configurations or co-

location with another transmitter), then the FCC/IC authorization is no longer considered valid and the FCC ID/IC ID cannot be used on the final product. In these circumstances, the OEM integrator will be responsible for re-evaluating the end product (including the transmitter) and obtaining a separate FCC/IC authorization.

Manual Information to the End User

The OEM integrator has to be aware not to provide information to the end user regarding how to install or remove this RF module in the user's manual of the end product which integrates this module. The end user manual shall include all required regulatory information/warning as show in this manual.

Federal Communication Commission Interference Statement

This device complies with Part 15 of the FCC Rules. Operation is subject to the following two conditions: (1) This device may not cause harmful interference, and (2) this device must accept any interference received, including interference that may cause undesired operation.

This equipment has been tested and found to comply with the limits for a Class B digital device, pursuant to Part 15 of the FCC Rules. These limits are designed to provide reasonable protection against harmful interference in a residential installation. This equipment generates, uses and can radiate radio frequency energy and, if not installed and used in accordance with the instructions, may cause harmful interference to radio communications. However, there is no guarantee that interference will not occur in a particular installation. If this equipment does cause harmful interference to radio or television reception, which can be determined by turning the equipment off and on, the user is encouraged to try to correct the interference by one of the following measures:

- Reorient or relocate the receiving antenna.
- Increase the separation between the equipment and receiver.
- Connect the equipment into an outlet on a circuit different from that to which the receiver is connected.
- Consult the dealer or an experienced radio/TV technician for help.

Any changes or modifications not expressly approved by the party responsible for compliance could void the user's authority to operate this equipment. This transmitter must not be co-located or operating in conjunction with any other antenna or transmitter.

Canada Statement

This device contains licence-exempt transmitter(s)/receiver(s) that comply with Innovation, Science and Economic Development Canada's licence-exempt RSS(s). Operation is subject to the following two conditions: (1) This device may not cause interference. (2) This device must accept any interference, including interference that may cause undesired operation of the device.

L'émetteur/récepteur exempt de licence contenu dans le présent appareil est conforme aux CNR d'Innovation, Sciences et Développement économique Canada applicables aux appareils radio exempts de licence. L'exploitation est autorisée aux deux conditions suivantes : 1) L'appareil ne doit pas produire de brouillage; 2) L'appareil doit accepter tout brouillage radioélectrique
CAN ICES-3(B)/ NMB-3(B)

Radiation Exposure Statement

This equipment complies with FCC/IC radiation exposure limits set forth for an uncontrolled environment. This equipment should be installed and operated with minimum distance 20 cm between the radiator & your body.

Contents

Contact Information.....	2
Revision History.....	2
Contents.....	7
1. Introduction.....	9
1.1 General Features.....	9
1.2 Architecture.....	10
1.3 Connection Interface.....	11
1.4 Environmental Specifications and Certifications.....	11
1.4.1 Environmental Specifications.....	11
1.4.2 Certifications.....	11
1.4.3 Green Product Compliance.....	11
2. Pin Definitions.....	12
2.1 LGA Module Pin Diagram.....	12
2.2 LGA Module Pin Definitions.....	13
3. Electrical Specifications.....	16
3.1 Power Supply.....	16
3.2 Power Consumption.....	16
3.3 Control Interfaces.....	17
3.3.1 Power-On Signal.....	17
3.3.2 Wake-Up Interface(TBD).....	17
3.3.3 Reset Signal.....	17
3.4 UART Interface.....	17
3.5 UIM Interface.....	18
3.6 I/O Characteristics.....	19
3.7 EJTAG Interface.....	19
3.8 ADC Interface.....	20
3.9 RF Interface.....	20
3.9.1 Bandwidth Support.....	20
3.9.2 RF Transmission Specifications.....	20
3.9.3 RF Receiver Specifications.....	21
3.9.4 RF GNSS Receiver Specifications.....	21
4. Mechanical Information.....	22
4.1 Physical Dimensions.....	22
4.2 Pin Dimensions.....	22
4.3 Marking Information(TBD).....	24
5. Packing Information(TBD).....	25
5.1 Tape-and-Reel Package.....	25
5.2 Single Packaging for Samples.....	26
5.3 MSL level.....	27
6. Design Guide.....	28

6.1 Power Trace Design.....	28
6.2 RF Pad Design.....	29
6.3 RF Matching Guide.....	31
6.4 Mounting Considerations(TBD).....	31
6.5 PCB Pad Design.....	34
6.6 LTE Power Saving Mode.....	35
7.0 Safety Recommendations.....	35
8.Initialisms.....	36

1. Introduction

The WNC IMA2 series modules include the Altair ALT1250 Cat. M1 baseband, a complete LTE RF front-end, memory, and required circuitry to fulfill 3GPP E-UTRA and AT&T Wireless LTE Cat. M1 UE specifications. The following table enumerates the frequencies supported by the IMA2 series modules.

Band	Uplink (MHz)	Downlink (MHz)
LTE Band 2	1860-1910	1930-1990
LTE Band 4	1710–1755	2110–2155
LTE Band 12	699-716	729-746
LTE Band 13	777-787	746-756

Table 1-1. Band support

Two SKUs are defined according to GNSS support capacity; refer to Table 1-2 for details.

Module	Power class	GNSS
IMA2	3	✘
IMA2G	3	✔

Table 1-2 SKU description

1.1 General Features

The table below summarizes the IMA2 module features.

General interfaces	• JTAG
	• USIM
	• PCM/I2C/GPIO
	• UART
Supported frequency bands	• LTE Band 2
	• LTE Band 4
	• LTE Band 12
	• LTE Band 13
Operating voltage	• V _{CC} (range: 3.3 V–4.2 V)
Packaging	• LGA module
	• 80 pads (15.5 mm × 15.5 mm × 1.96 mm W/O label)
	• RoHS compliant

Table 1-3. General features of the IMA2

Standards compliance	<ul style="list-style-type: none"> • 3GPP Release 13–compliant; software upgradable to Release 14
PHY	<ul style="list-style-type: none"> • Category M1: Up to 300 Kbps DL/375 Kbps UL • HD-FDD duplexing support
	<ul style="list-style-type: none"> • Power-saving mode
MAC	<ul style="list-style-type: none"> • Random access procedure in normal subframes • Scheduling request, buffer status reporting, and power headroom reporting
	<ul style="list-style-type: none"> • Discontinuous reception (eDRX) with long and short cycles
	<ul style="list-style-type: none"> • IPv4, IPv6
NAS and above	<ul style="list-style-type: none"> • NAS
	<ul style="list-style-type: none"> • SMS over SG

Table 1-4. LTE-related features of the IMA2

1.2 Architecture

The architecture block diagram of the IMA2 series is presented in Figure 1-1 below.

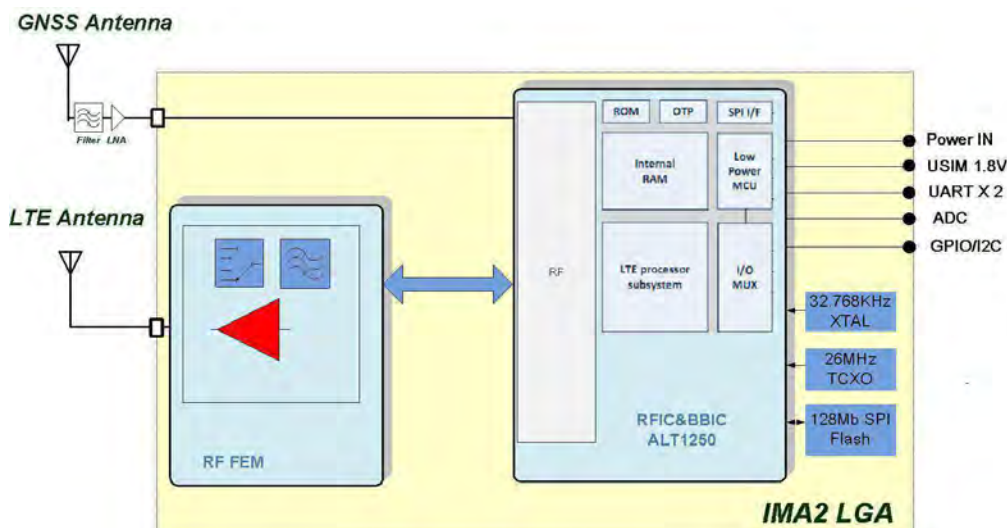

Figure 1-1. IMA2 series block diagram

1.3 Connection Interface

The IMA2 module is an LGA device. All electrical and mechanical connections are made through the 80 pads on the bottom side of the PCB.

1.4 Environmental Specifications and Certifications

1.4.1 Environmental Specifications

The environmental specifications for both operating and storage conditions are defined in the table below.

Condition	Temperature Range	Remark
Normal ambient operating temp. range	-20 °C to 60 °C	Fully functional and complies with 3GPP specifications
Extended ambient operating temp. range	-40 °C to 85°C (TBD)	RF performance may be affected outside normal ambient operating range temp., although the module will still function.
Storage	-40 °C to 85 °C	

Table 1-5. Temperature range

1.4.2 Certifications

The IMA2 module is compliant with the following regulations: PTCRB, FCC, IC, and AT&T TA.

1.4.3 Green Product Compliance

RoHS (2011/65/EU)

2. Pin Definitions

2.1 LGA Module Pin Diagram

The IMA2 LGA module pin layout is illustrated below.

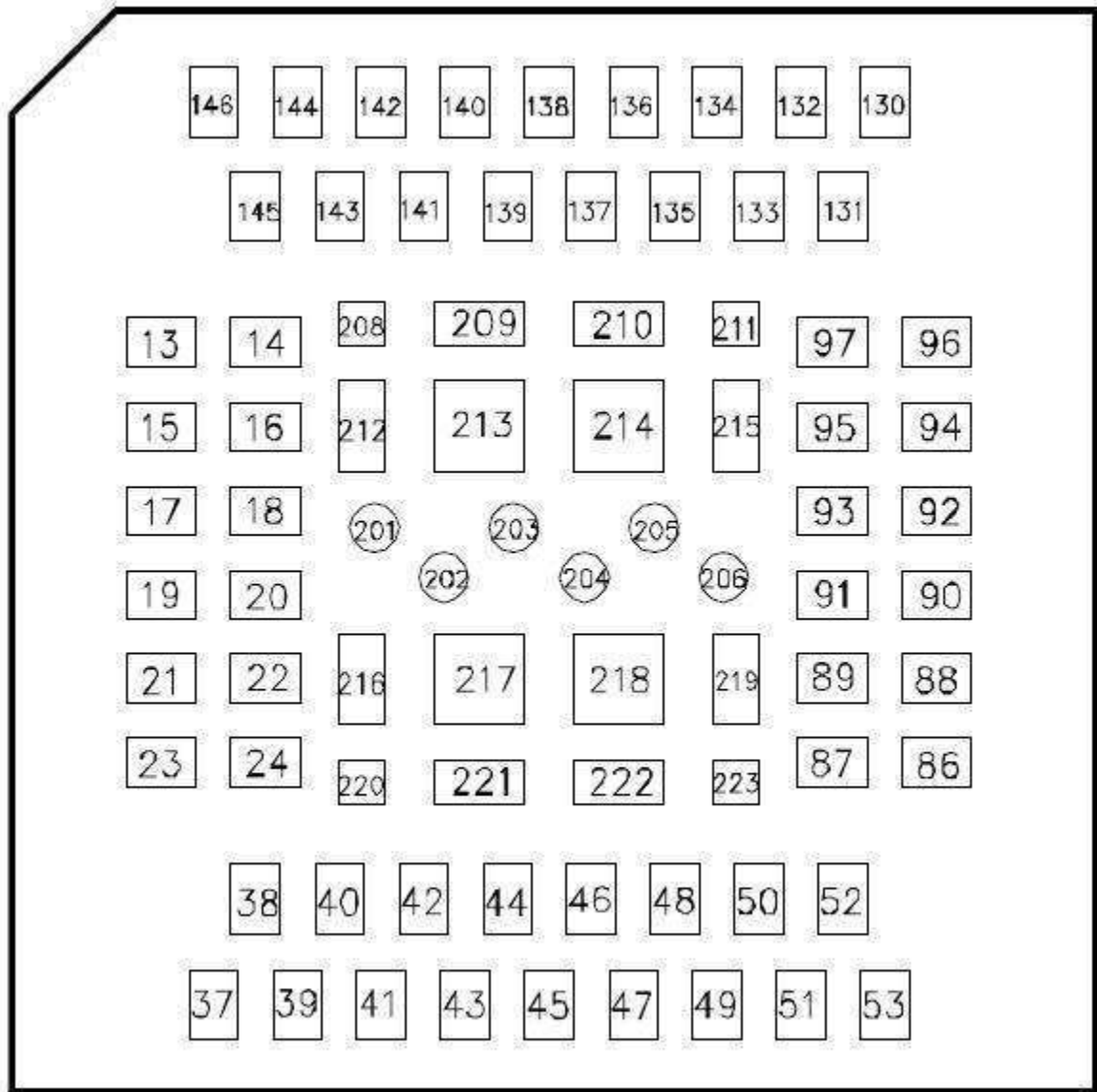

Figure 2-1. IMA2 LGA module pin layout (top view)

2.2 LGA Module Pin Definitions

The signals and all the related details are listed in the below table.

Pin No.	Name	Description
13	GND	Ground
14	GND	Ground
15	Main antenna	Main antenna port
16	GND	Ground
17	GND	Ground
18	GND	Ground
19	GND	Ground
20	GND	Ground
21	RF_GNSS	Antenna for a GNSS receiver
22	GND	Ground
23	GND	Ground
24	GND	Ground
37	Power	Power
38	Power	Power
39	Power	Power
40	Power	Power
41	Power	Power
42	Power	Power
43	PMU_VBACKUP	Power Input for Real Time Clock
44	GND	Ground
45	GND	Ground
46	PCM_FS/GPIO46	General purpose input/output
47	PCM_IN/GPIO47	General purpose input/output
48	PCM_OUT/GPIO48	General purpose input/output
49	PCM_CLK/GPIO49	General purpose input/output
50	GND	Ground
51	GND	Ground
52	I2C1_SCL/GPIO01	General purpose input/output
53	I2C1_SDA/GPIO02	General purpose input/output
86	USB_Dp	USB Data Positive
87	VBUS	VBUS (3.3V)

88	USB_Dn	USB Data Negative
89	UART2_RTS	Request to send for UART 2
90	GND	Ground
91	UART2_CTS	Clear to send for UART 2
92	UART0_CTS	Clear to send for UART 0
93	UART0_TX	Transmit for UART 0
94	UART2_TX	Transmit for UART 2
95	UART0_RX	Receive for UART 0
96	UART2_RX	Receive for UART 2
97	UART0_RTS	Request to send for UART 0
130	ADC1	Analog-to-digital converter
131	ADC2	Analog-to-digital converter
132	GNSS_EN/GPIO08	GNSS external LNA enable/General purpose input/output
133	UIM_VCC	SIM card power
134	UIM DATA	SIM card data line
135	UIM CLK	SIM card clock line
136	UIM RESET	SIM card reset line
137	UIM DETECT	SIM card detect line
138	NC	Not connected
139	GND	Ground
140	GND	Ground
141	WWAN_STATE	Wireless WAN radio state
142	Power on ¹	Power-on of the module (RFU)
143	WAKEUP_OUT	Module wake-up of the host
144	WAKEUP_IN ²	Host wake-up of the module
145	RESET	Hardware reset signal
146	VREF ³	Reference logic voltage (1.8 V voltage)
201	EJ_TCK	EJ_TCK
202	EJ_TDI	EJ_TDI
203	EJ_TDO	EJ_TDO
204	EJ_TMS	EJ_TMS
205	EJ_TRST	EJ_TRST
206	DEBUG_RSTN	Reset pin for the JTAG probe
208	NA	NA
209	NA	NA
210	NA	NA
211	NA	NA

212	GND	Ground
213	GND	Ground
214	GND	Ground
215	GND	Ground
216	GND	Ground
217	GND	Ground
218	GND	Ground
219	GND	Ground
220	NA	NA
221	NA	NA
222	NA	NA
223	NA	NA

Table 2-1. IMA2 module pin definitions

Notes:

- 1: Leave pin 142 floating; the module can turn on automatically when a power supply exists.
- 2: Pin 144 can be used as a wake-up as the module enters deep-sleep status. The default configuration is active high to wake up the LGA module.
- 3: The VREF voltage will turn off when entering the deep sleep state.

3. Electrical Specifications

3.1 Power Supply

The IMA2 module is supplied through the power signal with the following characteristics.

	Direction	Minimum	Typical	Maximum
Power (37–42)	In	3.3 V	3.8 V	4.2 V
VREF	Out	1.71 V	1.8 V	1.89 V
SIM_VCC (1.8 V)	Out	1.71 V	1.8 V	1.89 V

Table 3-1. Power supply

3.2 Power Consumption

This section describes the typical power consumption of the IMA2 (for reference).

Working Mode	Conditions	Result
Power saving mode		
	Floor current	1.7uA
LTE Band 2 working mode		
	Max Tx power without throughput Power voltage 3.8 V; average current	143mA
LTE Band 4 working mode		
	Max Tx power without throughput Power voltage 3.8 V; average current	136mA
LTE Band 12 working mode		
	Max Tx power without throughput Power voltage 3.8 V; average current	187mA
LTE Band 13 working mode		
	Max Tx power without throughput Power voltage 3.8 V; average current	178mA
Power On	Conditions	Result
Peak power consumption		
	Power consumption peaks	450mA
Power Off	Conditions	Result
Power off consumption		
	Only the module; no other devices; only RTC functions in deep sleep	1.7uA

Table 3-2. LTE power consumption

3.3 Control Interfaces

This section describes the power on/off, wake-up, and reset interface for controlling the module.

3.3.1 Power-On Signal

This function is not available in the present firmware; the module will be turned on automatically when the power supply exists. Set this pin as “floating” or use 0 Ω as a reserve.

3.3.2 Wake-Up Interface(TBD)

3.3.3 Reset Signal

The Reset Signal is a hardware reset signal to control the system reset directly. You can connect it to a key or a control signal. Reserve a 100k resistor to pull up to VREF and maintain a sufficient physical distance between the reset signal trace and noise and radiating signals on the PCB.

3.4 UART Interface

There are two UART interfaces: a 4-bit for high-speed data transfer, and the UARTs. Definitions of the IMA2 are listed below.

1. UART0 for PPP and AT
2. UART2 for firmware download, recovery mode, and firmware debug view

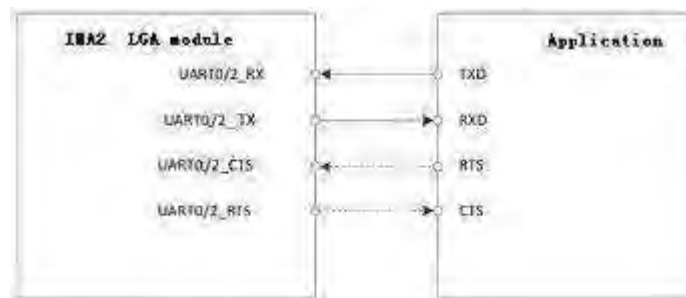

Figure 3-1. UART connection (example)

3.5 UIM Interface

IMA2 modules provide a UIM_DETECT input pin for UIM connectors to detect a UIM card. When a UIM card is present, UIM_DETECT should be high (1.8 V). If a UIM card is absent, UIM_DETECT should be low. Pulling UIM_DETECT to VREF with a 100k resistor is necessary. We recommend placing a 0.1 μF and a 33 pF capacitor between UIM_VCC and the Ground in parallel. We also recommend placing a 33 pF capacitor between UIM_RESET, UIM_CLK, and UIM_DATA and the Ground in parallel. Refer to Figure 5 for details.

We also recommend placing an electrostatic discharge (ESD) protection circuit near the UIM socket as close as possible. The Ground pin of the ESD protection component must be well-connected to the Ground plane.

The following figure shows an example of a UIM card circuit. The default configuration is active High.

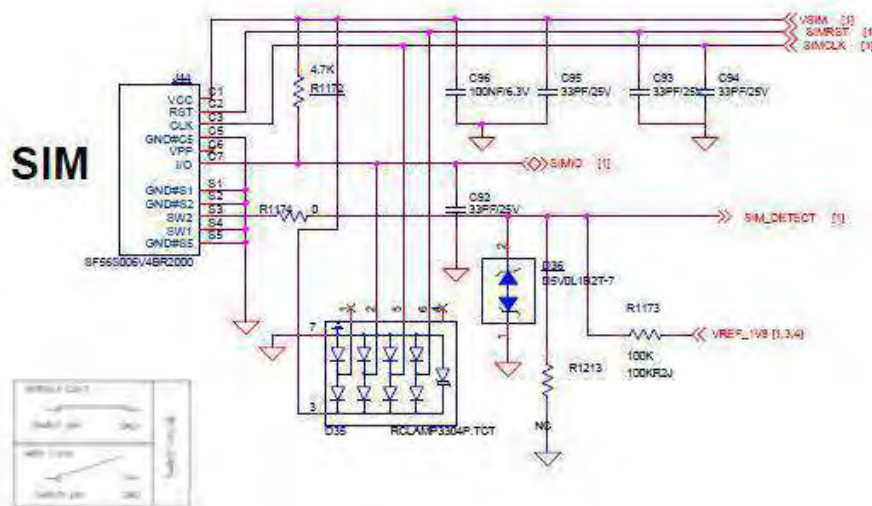

Figure 3-2. UIM card circuit example

It support internal SIM (iSIM) as an option

3.6 I/O Characteristics

The voltage and current characteristics of the various IO pads of the IMA2 versus IO bank supply voltage are illustrated in the tables below.

Parameter	Drive Strength	Min.	Nom.	Max.	Unit
VIL Input Low Voltage				0.3 × VIO	V
VIH Input High Voltage		0.7 × VIO			V
VOL Output Low Voltage				0.2 × VIO	V
VOH Output High Voltage		0.8 × VIO			V
VH Input Hysteresis		0.1 × VIO			V
IRATED IO Drive Strength	2 mA			12	mA

Table 3-3. DC characteristics for digital IOs, voltage 1.8 V—BIDIR and IN types

3.7 EJTAG Interface

The IMA2 series provides one EJTAG interface; leave JTAG pins floating if not used.

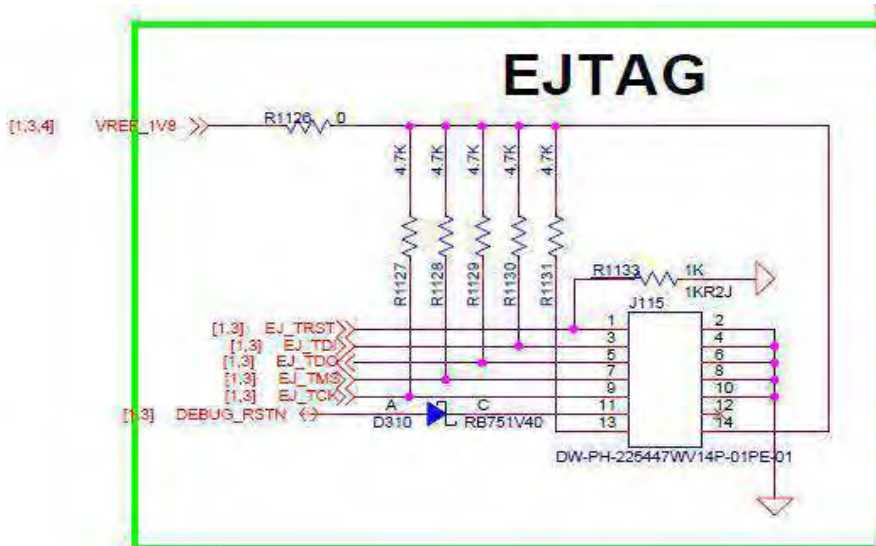

Figure 3-3. EJTAG schematic (example)

3.8 ADC Interface

The IMA2 contains two ADC ports; the characteristics will be updated according to the ALT1250 datasheet in the future.

Table 3-4. ADC characteristics (TBD)

3.9 RF Interface

Each IMA2 module has only one RF pad; developers must connect it via the 50 Ω traces to the main board.

- Main antenna pad (Pin15) – RX/TX path
- RF GNSS pad (Pin21) – GNSS RX path

3.9.1 Bandwidth Support

Band	Bandwidth					
	1.4 MHz	3 MHz	5 MHz	10 MHz	15 MHz	20 MHz
LTE Band 2	✓	✓	✓	✓	✓	✓
LTE Band 4	✓	✓	✓	✓	✓	✓
LTE Band 12	✓	✓	✓	✓	-	-
LTE Band 13	-	-	✓	✓	-	-

Table 3-5. Bandwidth support

3.9.2 RF Transmission Specifications

Band	Item	Parameter	Unit	Min.	Typ.	Max.
LTE Band 2	Max. Tx Power	20 MHz 1RBs/QPSK	dBm	20.3	23	25.7
LTE Band 4	Max. Tx Power	20 MHz 1RBs/QPSK	dBm	20.3	23	25.7
LTE Band 12	Max. Tx Power	10 MHz 1RBs/QPSK	dBm	20.3	23	25.7
LTE Band 13	Max. Tx Power	10 MHz 1RBs/QPSK	dBm	20.3	23	25.7

Table 3-6. Conductive Tx output power

Notes: 1.The RF transmission specification is defined at the LGA pad.
2. Complies with 3GPP test standards.

3.9.3 RF Receiver Specifications

Band	Item	Parameter	Unit	Min.	Typ.	Max.
LTE Band 2	Rx Sensitivity	5 MHz with 4 RBs	dBm			-100.3
LTE Band 4	Rx Sensitivity	5 MHz with 4 RBs	dBm			-102.3
LTE Band 12	Rx Sensitivity	5 MHz with 4 RBs	dBm			-99.3
LTE Band 13	Rx Sensitivity	5 MHz with 4 RBs	dBm			-99.3

Table 3-7. Conductive Rx sensitivity—3GPP

Notes: 1. The RF receiver specification is defined at the LGA pad.
2. Compliant with 3GPP test standards

3.9.4 RF GNSS Receiver Specifications

Test Items	Parameter	Min.	Typ.	Max.
Cold start TTFF	At -130 dBm	-	36s	-
Hot start TTFF	At -130 dBm	-	2s	-
CEP-50 accuracy	Open sky with -130 dBm input	-	2m	-
Cold start sensitivity	Acquire first with signal level	-	-146	-
Tracking sensitivity (GPS)	Detecting an in-view satellite 50% of the time	-	-160	-
Tracking sensitivity (GLONASS)	Detecting an in-view satellite 50% of the time	-	TBD	-

Table 3-8. Conductive GNSS performance

Note 1: Test points are displayed below.

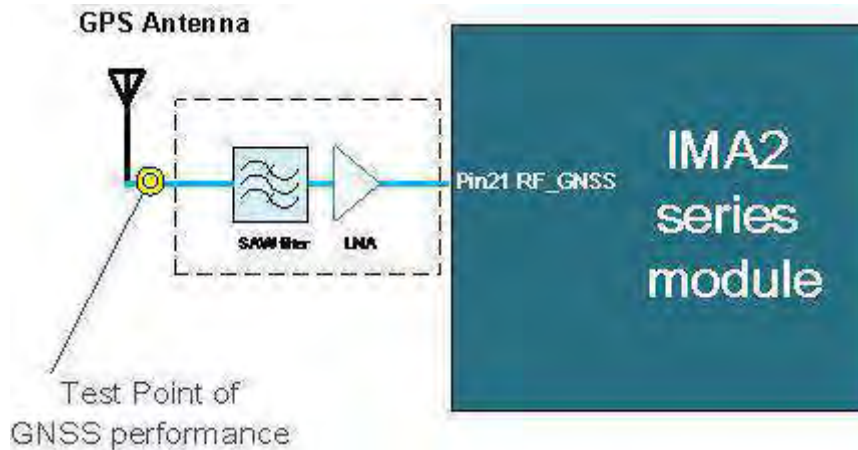

4. Mechanical Information

4.1 Physical Dimensions

Physical dimensions are illustrated in Figure 4-1 and Figure 4-2 below.

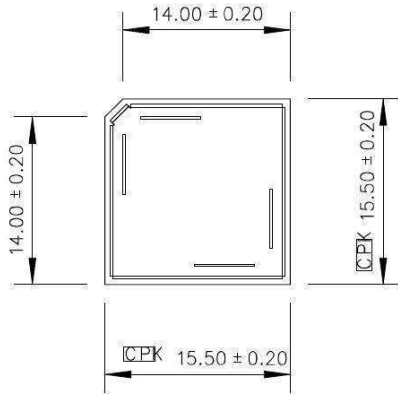

Figure 4-1. Top view

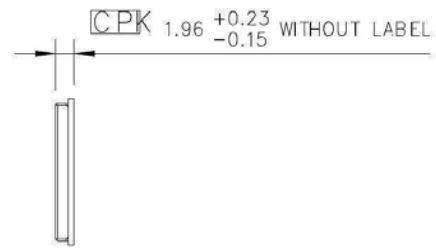

Figure 4-2. Right view

Note: The tolerance of top view dimensions is TBD.

4.2 Pin Dimensions

Pin dimensions are illustrated in Figure 4-3, and Figure 4-4 below.

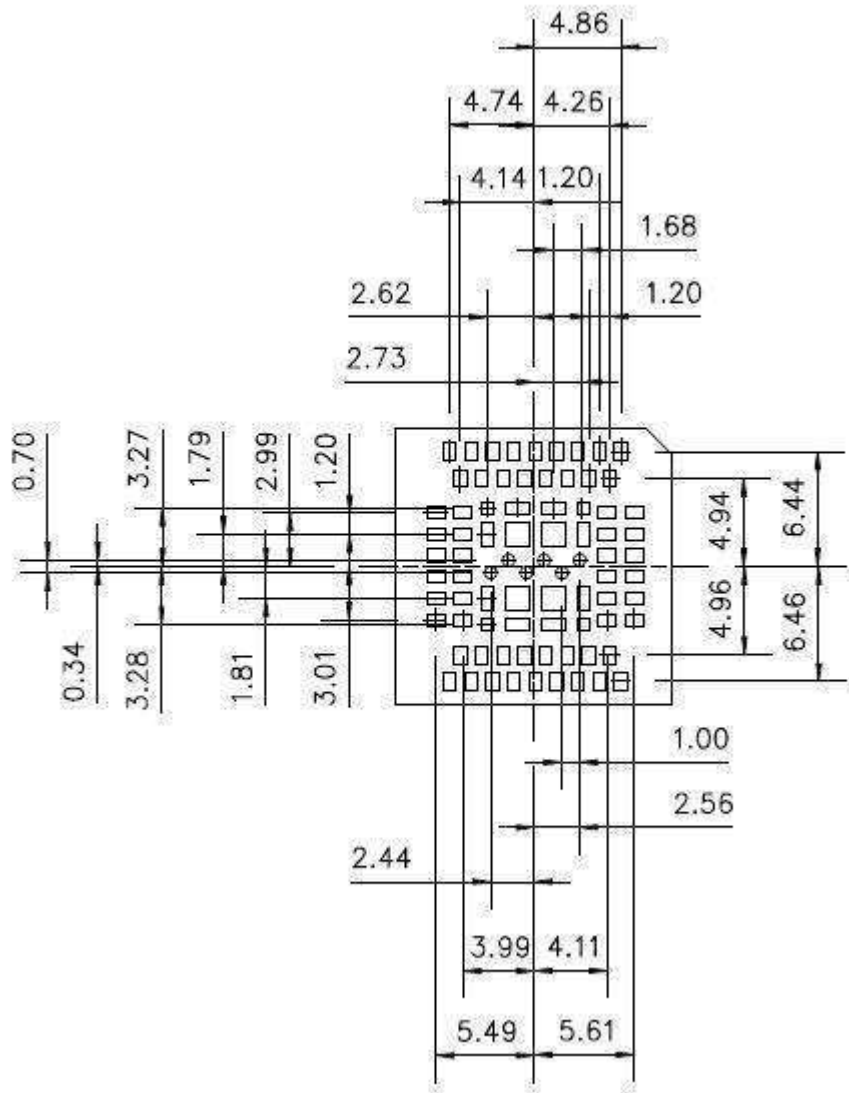

Figure 4-3. PIN dimensions (bottom view)

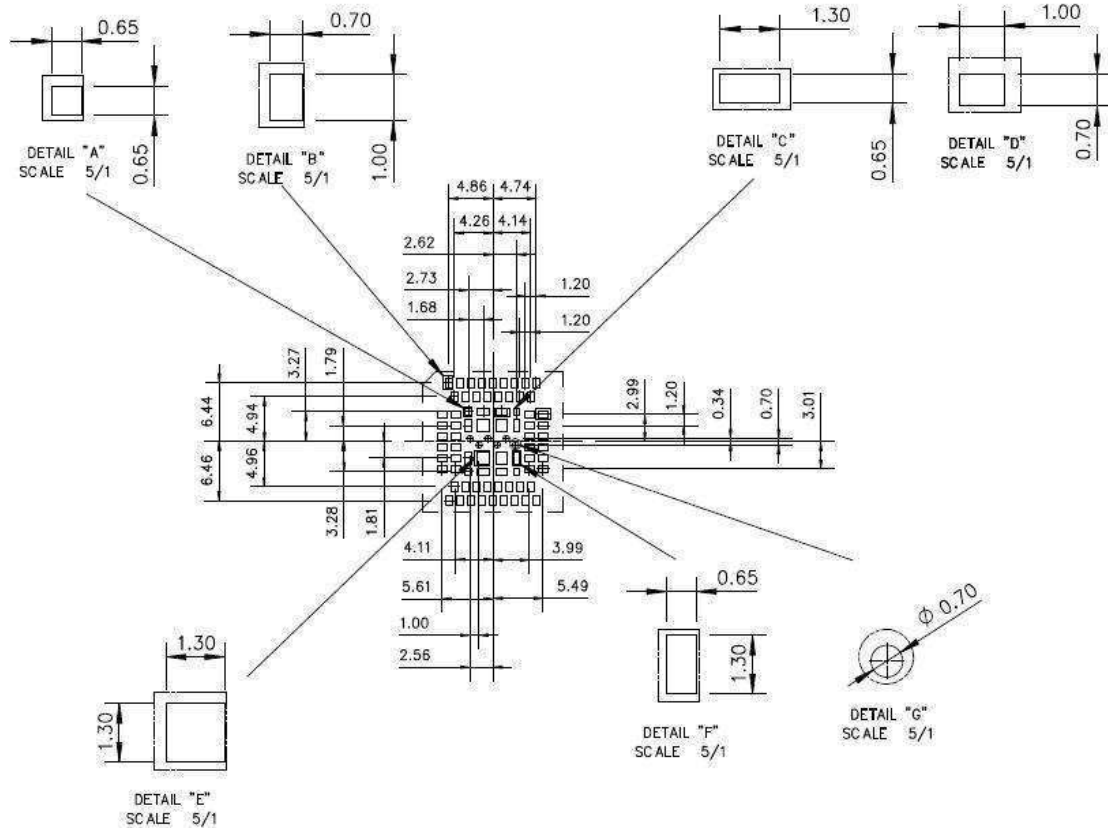

Figure 4-4. Pin dimensions

4.3 Marking Information(TBD)

The IMA2 series module label is illustrated below.

P/N: Variable; for the specific customer

S/N: Variable; unique for each module

IMEI: Variable; unique for each module

FCC: TBD

IC: TBD

If customers request their own S/Ns and IMEIs, they should inform WNC before production. The S/N and IMEI only can be written once onto each unit.