



FCC RADIO TEST REPORT

FCC ID : NKRD54A4
Equipment : Cellular Backup Bridge
Brand Name : ADT
Model Name : S30B1R0-01
Applicant : Wistron NeWeb Corp.
20 Park Avenue II, Hsinchu Science Park,
Hsinchu 308, Taiwan
Manufacturer : Wistron NeWeb Corp.
20 Park Avenue II, Hsinchu Science Park,
Hsinchu 308, Taiwan
Standard : FCC 47 CFR Part 2, 22(H), 24(E)

The product was received on Oct. 04, 2021 and testing was started from Oct. 20, 2021 and completed on Nov. 15, 2021. We, Sporton International Inc. EMC & Wireless Communications Laboratory, would like to declare that the tested sample has been evaluated in accordance with the test procedures given in ANSI / TIA-603-E and has been in compliance with the applicable technical standards.

The test results in this report apply exclusively to the tested model / sample. Without written approval of Sporton International Inc. EMC & Wireless Communications Laboratory, the test report shall not be reproduced except in full.

Louis Wu

Approved by: Louis Wu

Sporton International Inc. EMC & Wireless Communications Laboratory

No. 52, Huaya 1st Rd., Guishan Dist., Taoyuan City 333, Taiwan (R.O.C.)



Table of Contents

History of this test report.....	3
Summary of Test Result.....	4
1 General Description	5
1.1 Product Feature of Equipment Under Test	5
1.2 Modification of EUT	5
1.3 Testing Location	6
1.4 Applicable Standards	7
2 Test Configuration of Equipment Under Test	8
2.1 Test Mode.....	8
2.2 Connection Diagram of Test System	8
2.3 Support Unit used in test configuration	9
2.4 Measurement Results Explanation Example	9
2.5 Frequency List of Low/Middle/High Channels.....	9
3 Conducted Test Result	10
3.1 Measuring Instruments.....	10
3.2 Conducted Output Power and ERP/EIRP	11
3.3 Peak-to-Average Ratio	12
3.4 99% Occupied Bandwidth and 26dB Bandwidth Measurement.....	13
3.5 Conducted Band Edge	14
3.6 Conducted Spurious Emission	15
3.7 Frequency Stability.....	16
4 Radiated Test Items	17
4.1 Measuring Instruments.....	17
4.2 Test Setup	17
4.3 Test Result of Radiated Test.....	18
4.4 Field Strength of Spurious Radiation Measurement	19
5 List of Measuring Equipment.....	20
6 Uncertainty of Evaluation	22
Appendix A. Test Results of Conducted Test	
Appendix B. Test Results of Radiated Test	
Appendix C. Test Setup Photographs	



History of this test report

Report No.	Version	Description	Issued Date
FG193024A	01	Initial issue of report	Nov. 17, 2021



Summary of Test Result

Report Clause	Ref Std. Clause	Test Items	Result (PASS/FAIL)	Remark
3.2	§2.1046	Conducted Output Power	Pass	-
	§22.913 (a)(5)	Effective Radiated Power (WCDMA Band V)		
	§24.232 (c)	Equivalent Isotropic Radiated Power (WCDMA Band II)		
3.3	§24.232 (d)	Peak-to-Average Ratio	Pass	
3.4	§2.1049 §22.917 (b) §24.238 (b)	Occupied Bandwidth (WCDMA Band V) (WCDMA Band II)	Pass	-
3.5	§2.1051 §22.917 (a) §24.238 (a)	Band Edge Measurement (WCDMA Band V) (WCDMA Band II)	Pass	-
3.6	§2.1051 §22.917 (a) §24.238 (a)	Conducted Emission (WCDMA Band V) (WCDMA Band II)	Pass	-
3.7	§2.1055 §22.355 §24.235	Frequency Stability Temperature & Voltage	Pass	-
4.4	§2.1053 §22.917 (a) §24.238 (a)	Field Strength of Spurious Radiation (WCDMA Band V) (WCDMA Band II)	Pass	Under limit 31.80 dB at 5722.000 MHz

Declaration of Conformity:
 The test results with all measurement uncertainty excluded are presented in accordance with the regulation limits or requirements declared by manufacturers.

Comments and Explanations:
 The declared of product specification for EUT presented in the report are provided by the manufacturer, and the manufacturer takes all the responsibilities for the accuracy of product specification.

Reviewed by: Keven Cheng
Report Producer: Vivian Hsu



1 General Description

1.1 Product Feature of Equipment Under Test

The EUT is Cellular Backup Bridge with radio features (WCDMA/LTE and Wi-Fi 2.4GHz 802.11b/g/n) and uses integrated antenna as antenna configuration in the following table:

Antenna information	
Antenna Type	WWAN: Fixed Internal Antenna WLAN: PCB Antenna
Antenna Gain	Cellular Band:0.15dBi PCS Band: 3.43dBi

Remark: The above EUT's information was declared by manufacturer. Please refer to Comments and Explanations in report summary.

1.2 Modification of EUT

No modifications are made to the EUT during all test items.



1.3 Testing Location

Test Site	Sporton International Inc. EMC & Wireless Communications Laboratory
Test Site Location	No.52, Huaya 1st Rd., Guishan Dist., Taoyuan City 333, Taiwan (R.O.C.) TEL: +886-3-327-3456 FAX: +886-3-328-4978
Test Site No.	Sporton Site No. TH03-HY
Test Engineer	Oscar Chi
Temperature	21~24°C
Relative Humidity	51~55%

Test Site	Sporton International Inc. Wensan Laboratory
Test Site Location	No.58, Aly. 75, Ln. 564, Wenhua 3rd, Rd., Guishan Dist., Taoyuan City 333010, Taiwan (R.O.C.) TEL: +886-3-327-0868 FAX: +886-3-327-0855
Test Site No.	Sporton Site No. 03CH20-HY (TAF Code: 3786)
Test Engineer	Troye Hsieh
Temperature	19.3~20.5°C
Relative Humidity	63.9~66.5%
Remark	The Radiated Spurious Emission test item subcontracted to Sporton International Inc. Wensan Laboratory.

Note: The test site complies with ANSI C63.4 2014 requirement.

FCC Designation No.: TW1190 and TW3786



1.4 Applicable Standards

According to the specifications of the manufacturer, the EUT must comply with the requirements of the following standards:

- ♦ ANSI C63.26-2015
- ♦ ANSI / TIA-603-E
- ♦ FCC 47 CFR Part 2, 22(H), 24(E)
- ♦ FCC KDB 971168 D01 Power Meas. License Digital Systems v03r01
- ♦ FCC KDB 412172 D01 Determining ERP and EIRP v01r01
- ♦ FCC KDB 414788 D01 Radiated Test Site v01r01

Remark:

1. All test items were verified and recorded according to the standards and without any deviation during the test.
2. This EUT has also been tested and complied with the requirements of FCC Part 15, Subpart B, recorded in a separate test report.
3. The TAF code is not including all the FCC KDB listed without accreditation.

2 Test Configuration of Equipment Under Test

2.1 Test Mode

Antenna port conducted and radiated test items were performed according to KDB 971168 D01 Power Meas. License Digital Systems v03r01 with maximum output power.

For radiated measurement, the measured emission level of the EUT was maximized by rotating the EUT on a turntable, adjusting the orientation of the EUT and EUT antenna in three orthogonal axis (X: flat, Y: portrait, Z: landscape), and adjusting the measurement antenna orientation, following C63.26 exploratory test procedures and find X Plane as worst plane

Radiated emissions were investigated as following frequency range:

1. 30 MHz to 9000 MHz for WCDMA Band V
2. 30 MHz to 19100 MHz for WCDMA Band II

All modes, data rates and positions were investigated.

Test modes are chosen to be reported as the worst case configuration below:

Test Modes		
Band	Radiated TCs	Conducted TCs
WCDMA Band V	■ RMC 12.2Kbps Link	■ RMC 12.2Kbps Link
WCDMA Band II	■ RMC 12.2Kbps Link	■ RMC 12.2Kbps Link

2.2 Connection Diagram of Test System

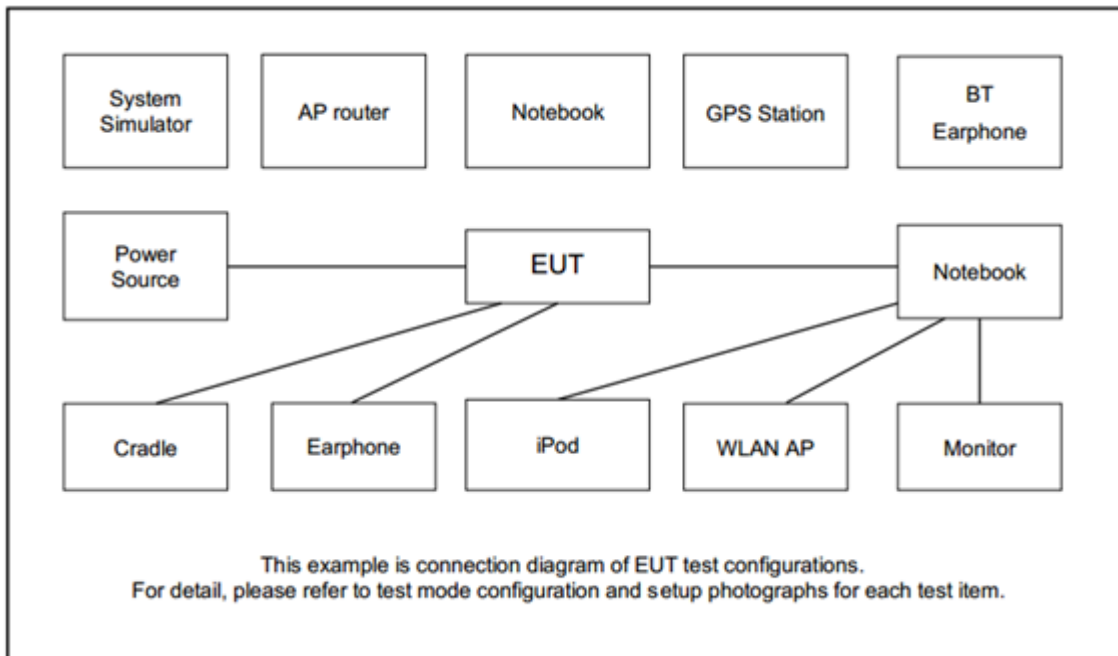



2.3 Support Unit used in test configuration

Item	Equipment	Brand Name	Model No.	FCC ID	Data Cable	Power Cord
1.	System Simulator	Anritsu	MT8820C	N/A	N/A	Unshielded, 1.8 m

2.4 Measurement Results Explanation Example

For all conducted test items:

The offset level is set in the spectrum analyzer to compensate the RF cable loss and attenuator factor between RF conducted output port and spectrum analyzer. With the offset compensation, the spectrum analyzer reading level will be exactly the RF output level.

The spectrum analyzer offset is derived from RF cable loss and attenuator factor.

Offset = RF cable loss + attenuator factor.

The following shows an offset computation example with RF cable loss 4.2 dB and a 10 dB attenuator.

Example:

$$\begin{aligned} \text{Offset(dB)} &= \text{RF cable loss(dB)} + \text{attenuator factor(dB)}. \\ &= 4.2 + 10 = 14.2 \text{ (dB)} \end{aligned}$$

2.5 Frequency List of Low/Middle/High Channels

Frequency List				
Band	Channel/Frequency(MHz)	Lowest	Middle	Highest
WCDMA Band V	Channel	4132	4182	4233
	Frequency	826.4	836.4	846.6
WCDMA Band II	Channel	9262	9400	9538
	Frequency	1852.4	1880.0	1907.6

3 Conducted Test Result

3.1 Measuring Instruments

See list of measuring instruments of this test report.

3.1.1 Test Setup

3.1.2 Conducted Output Power



3.1.3 Peak-to-Average Ratio, Occupied Bandwidth, Conducted Band-Edge and Conducted Spurious Emission

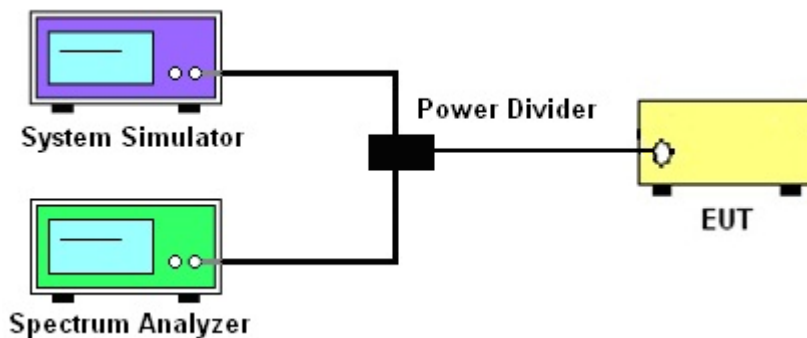

3.1.4 Frequency Stability

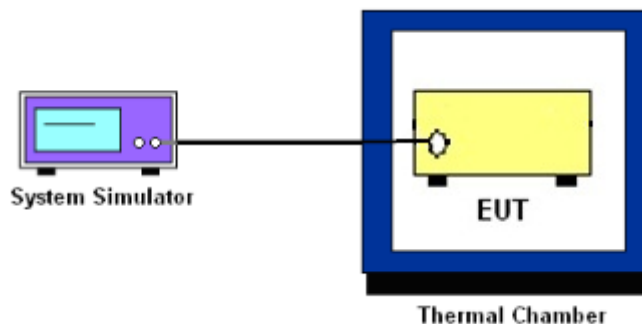

3.1.5 Test Result of Conducted Test

Please refer to Appendix A.



3.2 Conducted Output Power and ERP/EIRP

3.2.1 Description of the Conducted Output Power and ERP/EIRP

A system simulator was used to establish communication with the EUT. Its parameters were set to enforce EUT transmitting at the maximum power. The measured power in the radio frequency on the transmitter output terminals shall be reported.

The ERP of mobile transmitters must not exceed 7 Watts for WCDMA Band V

The EIRP of mobile transmitters must not exceed 2 Watts for WCDMA Band II

According to KDB 412172 D01 Power Approach,

$EIRP = P_T + G_T - L_C$, $ERP = EIRP - 2.15$, where

P_T = transmitter output power in dBm

G_T = gain of the transmitting antenna in dBi

L_C = signal attenuation in the connecting cable between the transmitter and antenna in dB

3.2.2 Test Procedures

1. The transmitter output port was connected to the system simulator.
2. Set EUT at maximum power through system simulator.
3. Select the lowest, middle, and the highest channels for each band and different modulation.
4. Measure the maximum burst average power for GSM and maximum average power for other modulation signal.



3.3 Peak-to-Average Ratio

3.3.1 Description of the PAR Measurement

The peak-to-average ratio (PAR) of the transmission may not exceed 13 dB.

3.3.2 Test Procedures

The testing follows ANSI C63.26-2015 Section 5.2.6

1. The EUT was connected to spectrum analyzer and system simulator via a power divider.
2. Set EUT to transmit at maximum output power.
3. When the duty cycle is less than 98%, then signal gating will be implemented on the spectrum analyzer by triggering from the system simulator.
4. Set the CCDF (Complementary Cumulative Distribution Function) option of the spectrum analyzer.
5. Record the maximum PAPR level associated with a probability of 0.1%.



3.4 99% Occupied Bandwidth and 26dB Bandwidth Measurement

3.4.1 Description of 99% Occupied Bandwidth and 26dB Bandwidth Measurement

The occupied bandwidth is the width of a frequency band such that, below the lower and above the upper frequency limits, the mean powers emitted are each equal to a specified percentage 0.5% of the total mean transmitted power.

The 26 dB emission bandwidth is defined as the frequency range between two points, one above and one below the carrier frequency, at which the spectral density of the emission is attenuated 26 dB below the maximum in-band spectral density of the modulated signal. Spectral density (power per unit bandwidth) is to be measured with a detector of resolution bandwidth equal to approximately 1.0% of the emission bandwidth.

3.4.2 Test Procedures

The testing follows ANSI C63.26-2015 Section 5.4.3 (26dB) and Section 5.4.4 (99OB)

1. The EUT was connected to spectrum analyzer and system simulator via a power divider.
2. The spectrum analyzer center frequency is set to the nominal EUT channel center frequency. The span range for the spectrum analyzer shall be between two and five times the anticipated OBW.
3. The nominal resolution bandwidth (RBW) shall be in the range of 1 to 5 % of the anticipated OBW, and the VBW shall be at least 3 times the RBW.
4. Set the detection mode to peak, and the trace mode to max hold.
5. Determine the reference value: Set the EUT to transmit a modulated signal. Allow the trace to stabilize. Set the spectrum analyzer marker to the highest level of the displayed trace.
(This is the reference value)
6. Determine the “-26 dB down amplitude” as equal to (Reference Value – X).
7. Place two markers, one at the lowest and the other at the highest frequency of the envelope of the spectral display such that each marker is at or slightly below the “-X dB down amplitude” determined in step 6. If a marker is below this “-X dB down amplitude” value it shall be placed as close as possible to this value. The OBW is the positive frequency difference between the two markers.
8. Use the 99 % power bandwidth function of the spectrum analyzer and report the measured bandwidth.



3.5 Conducted Band Edge

3.5.1 Description of Conducted Band Edge Measurement

The power of any emission outside of the authorized operating frequency ranges must be lower than the transmitter power (P) by a factor of at least $43 + 10 \log (P)$ dB.

3.5.2 Test Procedures

The testing follows FCC KDB 971168 D01 v03r01 Section 6.1.

1. The EUT was connected to the spectrum analyzer and system simulator via a power divider.
2. The RF output of EUT was connected to the spectrum analyzer by an RF cable and attenuator. The path loss was compensated to the results for each measurement.
3. The band edges of low and high channels for the highest RF powers were measured.
4. The RF fundamental frequency should be excluded against the limit line in the operating frequency band.
5. The limit line is derived from $43 + 10\log(P)$ dB below the transmitter power P(Watts)



3.6 Conducted Spurious Emission

3.6.1 Description of Conducted Spurious Emission Measurement

The power of any emission outside of the authorized operating frequency ranges must be lower than the transmitter power (P) by a factor of at least $43 + 10 \log (P)$ dB.

It is measured by means of a calibrated spectrum analyzer and scanned from 30 MHz up to a frequency including its 10th harmonic.

3.6.2 Test Procedures

The testing follows FCC KDB 971168 D01 v03r01 Section 6.1.

1. The EUT was connected to the spectrum analyzer and system simulator via a power divider.
2. The RF output of EUT was connected to the spectrum analyzer by an RF cable and attenuator. The path loss was compensated to the results for each measurement.
3. The middle channel for the highest RF power within the transmitting frequency was measured.
4. The conducted spurious emission for the whole frequency range was taken.
5. The RF fundamental frequency should be excluded against the limit line in the operating frequency band.
6. The limit line is derived from $43 + 10\log(P)$ dB below the transmitter power P(Watts)



3.7 Frequency Stability

3.7.1 Description of Frequency Stability Measurement

22.355

The frequency stability shall be measured by variation of ambient temperature and variation of primary supply voltage to ensure that the fundamental emission stays within the authorized frequency block. The frequency stability of the transmitter shall be maintained within $\pm 0.00025\%$ ($\pm 2.5\text{ppm}$) of the center frequency.

24.235

The frequency stability shall be sufficient to ensure that the fundamental emission stays within the authorized frequency block.

3.7.2 Test Procedures for Temperature Variation

The testing follows FCC KDB 971168 D01 v03r01 Section 9.0.

1. The EUT was set up in the thermal chamber and connected with the system simulator.
2. With power OFF, the temperature was decreased to -30°C and the EUT was stabilized before testing. Power was applied and the maximum change in frequency was recorded within one minute.
3. With power OFF, the temperature was raised in 10°C steps up to 50°C . The EUT was stabilized at each step for at least half an hour. Power was applied and the maximum frequency change was recorded within one minute.

3.7.3 Test Procedures for Voltage Variation

The testing follows FCC KDB 971168 D01 v03r01 Section 9.0.

1. The EUT was placed in a temperature chamber at $20\pm 5^{\circ}\text{C}$ and connected with the system simulator.
2. The power supply voltage to the EUT was varied from 85% to 115% of the nominal value measured at the input to the EUT.
3. The variation in frequency was measured for the worst case.

4 Radiated Test Items

4.1 Measuring Instruments

See list of measuring instruments of this test report.

4.2 Test Setup

For radiated test below 30MHz



For radiated test from 30MHz to 1GHz

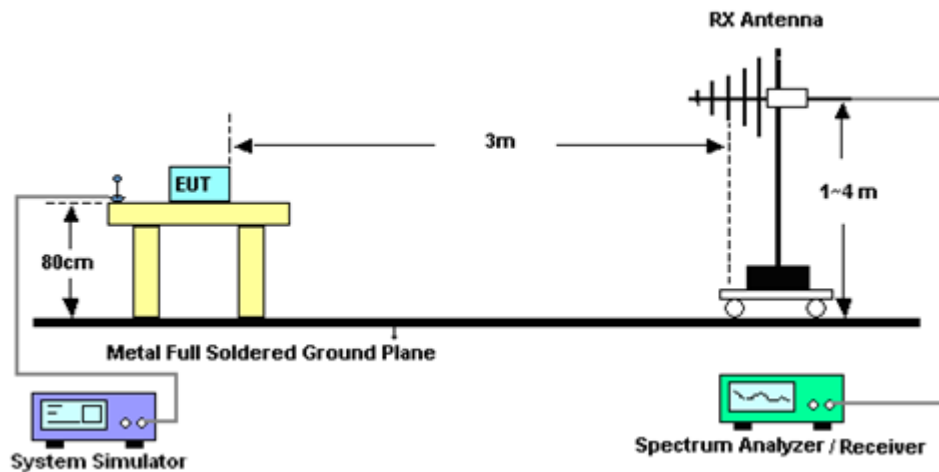

For radiated test above 1GHz

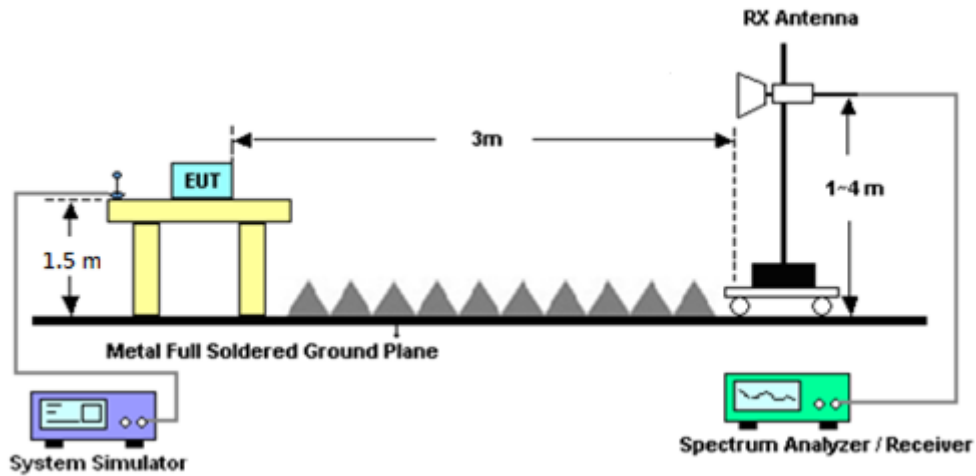

4.3 Test Result of Radiated Test

Please refer to Appendix B.

Note:

The low frequency, which started from 9 kHz to 30 MHz, was pre-scanned and the result which was 20 dB lower than the limit line was not reported.

There is adequate comparison measurement of both open-field test site and alternative test site - semi-Anechoic chamber according to 414788 D01 Radiated Test Site v01r01, and the result came out very similar.



4.4 Field Strength of Spurious Radiation Measurement

4.4.1 Description of Field Strength of Spurious Radiated Measurement

The power of any emission outside of the authorized operating frequency ranges must be attenuated below the transmitter power (P) by a factor of at least $43 + 10 \log (P)$ dB. The spectrum is scanned from 30 MHz up to a frequency including its 10th harmonic.

4.4.2 Test Procedures

The testing follows FCC KDB 971168 D01 v03r01 Section 7 and ANSI / TIA-603-E Section 2.2.12.

1. The EUT was placed on a rotatable wooden table 0.8 meters for frequency below 1 GHz and 1.5 meter for frequency above 1 GHz above the ground.
2. The EUT was set 3 meters from the receiving antenna, which was mounted on the antenna tower.
3. The table was rotated 360 degrees to determine the position of the highest spurious emission.
4. The height of the receiving antenna is varied between one meter and four meters to search for the maximum spurious emission for both horizontal and vertical polarizations.
5. Make the measurement with the spectrum analyzer's RBW = 1 MHz, VBW = 3 MHz, taking record of maximum spurious emission.
6. A horn antenna was substituted in place of the EUT and was driven by a signal generator.
7. Tune the output power of signal generator to the same emission level with EUT maximum spurious emission.
8. Take the record of output power at antenna port.
9. Repeat step 7 to step 8 for another polarization.
10. $EIRP (dBm) = S.G. Power - Tx Cable Loss + Tx Antenna Gain$
11. $ERP (dBm) = EIRP - 2.15$
12. The RF fundamental frequency should be excluded against the limit line in the operating frequency band.
13. The limit line is derived from $43 + 10\log(P)$ dB below the transmitter power P(Watts)



5 List of Measuring Equipment

Instrument	Brand Name	Model No.	Serial No.	Characteristics	Calibration Date	Test Date	Due Date	Remark
EMI Test Receiver	Keysight	N9010B	MY60240520	10Hz~44GHz	Dec. 02, 2020	Oct. 20, 2021~ Oct. 21, 2021	Dec. 01, 2021	Radiation (03CH20-HY)
Preamplifier	COM-POWER	PAM-103	18020201	1MHz-1000MHz	Jan. 04, 2021	Oct. 20, 2021~ Oct. 21, 2021	Jan. 03, 2022	Radiation (03CH20-HY)
Amplifier	EMCI	EMC118A45SE	980792	N/A	Nov. 16, 2020	Oct. 20, 2021~ Oct. 21, 2021	Nov. 15, 2021	Radiation (03CH20-HY)
Preamplifier	EMEC	EM18G40G	060715	18GHz~40GHz	Dec. 11, 2020	Oct. 20, 2021~ Oct. 21, 2021	Dec. 10, 2021	Radiation (03CH20-HY)
Loop Antenna	Rohde & Schwarz	HFH2-Z2	100315	9 kHz~30 MHz	Jan. 04, 2021	Oct. 20, 2021~ Oct. 21, 2021	Jan. 03, 2022	Radiation (03CH20-HY)
Bilog Antenna	TESEQ	CBL 6111D&00802 N1D01N-06	55606 & 08	30MHz~1GHz	Oct. 17, 2021	Oct. 20, 2021~ Oct. 21, 2021	Oct. 16, 2022	Radiation (03CH20-HY)
Horn Antenna	SCHWARZBECK	BBHA 9120 D	002360	1GHz-18GHz	Nov. 03, 2020	Oct. 20, 2021~ Oct. 21, 2021	Nov. 02, 2021	Radiation (03CH20-HY)
SHF-EHF Horn Antenna	SCHWARZBECK	BBHA9170	009910	18GHz-40GHz	May 12, 2021	Oct. 20, 2021~ Oct. 21, 2021	May 11, 2022	Radiation (03CH20-HY)
Filter	Wainwright	WLK4-1000-15 30-8000-40SS	SN27	1.53GHz Low Pass Filter	May 25, 2021	Oct. 20, 2021~ Oct. 21, 2021	May 24, 2022	Radiation (03CH20-HY)
Filter	Wainwright	WHKX12-2700 -3000-18000-6 0ST	SN8	N/A	Mar. 26, 2021	Oct. 20, 2021~ Oct. 21, 2021	Mar. 25, 2022	Radiation (03CH20-HY)
Filter	Wainwright	WHKX12-900- 1000-15000-6 0SS	SN9	N/A	Nov. 05, 2020	Oct. 20, 2021~ Oct. 21, 2021	Nov. 04, 2021	Radiation (03CH20-HY)
Notch Filter	ST1	STI15_9935_5 150-5850	NA	N/A	Apr. 08, 2021	Oct. 20, 2021~ Oct. 21, 2021	Apr. 07, 2022	Radiation (03CH20-HY)
Notch Filter	Marvelous Microwave Inc	MFN_2400.24 85.S5	40009N	N/A	Apr. 16, 2021	Oct. 20, 2021~ Oct. 21, 2021	Apr. 15, 2022	Radiation (03CH20-HY)
Hygrometer	TECEPEL	DTM-303B	TP200728	N/A	Mar. 09, 2021	Oct. 20, 2021~ Oct. 21, 2021	Mar. 08, 2022	Radiation (03CH20-HY)
RF Cable	HUBER + SUHNER	SUCOFLEX 102	519229/2,80 4015/2,8040 27/2	N/A	Jan. 20, 2021	Oct. 20, 2021~ Oct. 21, 2021	Jan. 19, 2022	Radiation (03CH20-HY)
Software	Audix	E3 6.2009-8-24	RK-002156	N/A	N/A	Oct. 20, 2021~ Oct. 21, 2021	N/A	Radiation (03CH20-HY)
Antenna Mast	EMEC	AM-BS-4500-B	N/A	1m~4m	N/A	Oct. 20, 2021~ Oct. 21, 2021	N/A	Radiation (03CH20-HY)
Turn Table	EMEC	TT2000	N/A	0~360 Degree	N/A	Oct. 20, 2021~ Oct. 21, 2021	N/A	Radiation (03CH20-HY)
Controller	EMEC	EM1000	N/A	Control Turn table & Ant Mast	N/A	Oct. 20, 2021~ Oct. 21, 2021	N/A	Radiation (03CH20-HY)



Instrument	Brand Name	Model No.	Serial No.	Characteristics	Calibration Date	Test Date	Due Date	Remark
Hygrometer	Testo	608-H1	34893241	N/A	Mar. 01, 2021	Nov. 15, 2021	Feb. 28, 2022	Conducted (TH03-HY)
Spectrum Analyzer	Rohde & Schwarz	FSP30	101329	9kHz~30GHz	Sep. 30, 2021	Nov. 15, 2021	Sep. 29, 2022	Conducted (TH03-HY)
Temperature & Humidity Cabinet Chamber	ESPEC	LHU-113	1012005860	-20°C~85°C	Jan. 18, 2021	Nov. 15, 2021	Jan. 17, 2022	Conducted (TH03-HY)
Programmable Power Supply	GW Instek	PSS-2005	EL890001	1V~20V 0.5A~4A	Oct. 06, 2021	Nov. 15, 2021	Oct. 05, 2022	Conducted (TH03-HY)
Base Station (Measure)	Rohde & Schwarz	CMU200	117995	GSM / GPRS / WCDMA / CDMA	Jul. 13, 2021	Nov. 15, 2021	Jul. 12, 2022	Conducted (TH03-HY)
Power Divider	Warison	WCOU-0.4-26.5S-20	#A	N/A	Nov. 01, 2021	Nov. 15, 2021	Oct. 31, 2022	Conducted (TH03-HY)



6 Uncertainty of Evaluation

Uncertainty of Radiated Emission Measurement (30 MHz ~ 1000 MHz)

Measuring Uncertainty for a Level of Confidence of 95% ($U = 2Uc(y)$)	3.31 dB
---	---------

Uncertainty of Radiated Emission Measurement (1 GHz ~ 18 GHz)

Measuring Uncertainty for a Level of Confidence of 95% ($U = 2Uc(y)$)	3.63 dB
---	---------

Uncertainty of Radiated Emission Measurement (18 GHz ~ 40 GHz)

Measuring Uncertainty for a Level of Confidence of 95% ($U = 2Uc(y)$)	4.03 dB
---	---------



Appendix A. Test Results of Conducted Test

Conducted Output Power(Average power) & ERP / EIRP

WCDMA Band V Maximum Average Power [dBm] (GT - LC = 0.15 dB)					
Channel	4132	4182	4233	ERP (dBm)	ERP (W)
Frequency	826.4	836.4	846.6		
RMC 12.2K	23.35	23.37	23.54	21.54	0.1426
HSDPA Subtest-1	22.37	22.31	22.50		
HSDPA Subtest-2	22.30	22.28	22.45		
HSDPA Subtest-3	21.80	21.78	21.97		
HSDPA Subtest-4	21.81	21.79	21.97		
HSUPA Subtest-1	22.15	22.12	22.38		
HSUPA Subtest-2	21.26	20.86	21.01		
HSUPA Subtest-3	20.67	21.07	21.02		
HSUPA Subtest-4	21.56	21.84	22.00		
HSUPA Subtest-5	22.40	22.30	22.40		
Limit	ERP < 7W				

WCDMA Band II Maximum Average Power [dBm] (GT - LC = 3.43 dB)					
Channel	9262	9400	9538	EIRP (dBm)	EIRP (W)
Frequency	1852.4	1880	1907.6		
RMC 12.2K	23.08	23.00	23.02	26.51	0.4477
HSDPA Subtest-1	22.06	22.07	22.15		
HSDPA Subtest-2	22.15	22.19	22.25		
HSDPA Subtest-3	21.66	21.69	21.68		
HSDPA Subtest-4	21.65	21.70	21.70		
HSUPA Subtest-1	22.09	22.12	22.06		
HSUPA Subtest-2	20.95	21.17	21.21		
HSUPA Subtest-3	21.13	21.14	21.23		
HSUPA Subtest-4	21.16	21.21	21.04		
HSUPA Subtest-5	22.10	22.10	22.20		
Limit	EIRP < 2W				



A2. WCDMA

Peak-to-Average Ratio

Mode	WCDMA Band V	WCDMA Band II	Limit: 13dB
Mod.	RMC 12.2Kbps	RMC 12.2Kbps	Result
Lowest CH	3.32	3.68	PASS
Middle CH	3.56	3.64	
Highest CH	3.44	4.04	

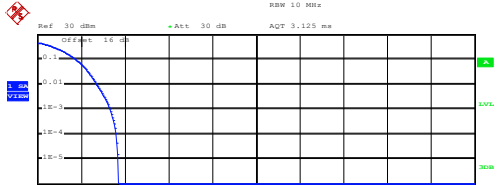
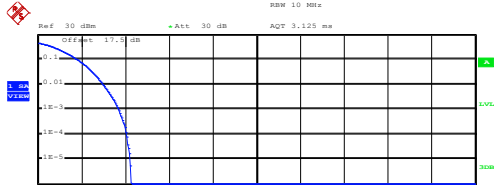
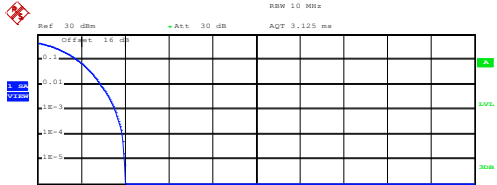
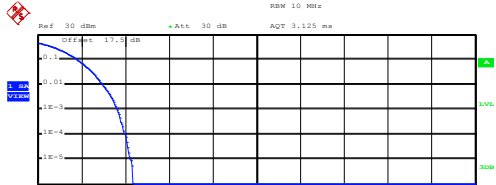
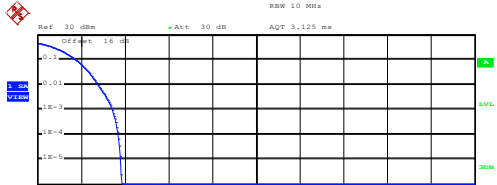
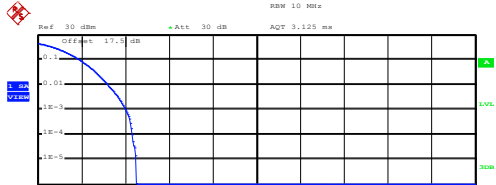

WCDMA Band V (RMC 12.2Kbps)	WCDMA Band II (RMC 12.2Kbps)
<p style="text-align: center;">Lowest Channel</p>  <p>Center 826.4 MHz 2 dB/ Mean Pwr + 20 dB</p> <p>Complementary Cumulative Distribution Function (100000 samples)</p> <p>Trace 1</p> <p>Mean 22.09 dBm Peak 25.81 dBm Crest 3.71 dB</p> <p>10 % 1.76 dB 1 % 2.72 dB .1 % 3.32 dB .01 % 3.60 dB</p> <p>Date: 15.NOV.2021 14:33:58</p>	<p style="text-align: center;">Lowest Channel</p>  <p>Center 1.8524 GHz 2 dB/ Mean Pwr + 20 dB</p> <p>Complementary Cumulative Distribution Function (100000 samples)</p> <p>Trace 1</p> <p>Mean 21.34 dBm Peak 25.59 dBm Crest 4.25 dB</p> <p>10 % 1.84 dB 1 % 3.00 dB .1 % 3.68 dB .01 % 4.08 dB</p> <p>Date: 15.NOV.2021 13:54:30</p>
<p style="text-align: center;">Middle Channel</p>  <p>Center 836.6 MHz 2 dB/ Mean Pwr + 20 dB</p> <p>Complementary Cumulative Distribution Function (100000 samples)</p> <p>Trace 1</p> <p>Mean 22.14 dBm Peak 26.16 dBm Crest 4.01 dB</p> <p>10 % 1.84 dB 1 % 2.88 dB .1 % 3.56 dB .01 % 3.88 dB</p> <p>Date: 15.NOV.2021 14:34:14</p>	<p style="text-align: center;">Middle Channel</p>  <p>Center 1.88 GHz 2 dB/ Mean Pwr + 20 dB</p> <p>Complementary Cumulative Distribution Function (100000 samples)</p> <p>Trace 1</p> <p>Mean 21.52 dBm Peak 25.88 dBm Crest 4.35 dB</p> <p>10 % 1.84 dB 1 % 2.96 dB .1 % 3.64 dB .01 % 4.00 dB</p> <p>Date: 15.NOV.2021 13:54:47</p>
<p style="text-align: center;">Highest Channel</p>  <p>Center 846.8 MHz 2 dB/ Mean Pwr + 20 dB</p> <p>Complementary Cumulative Distribution Function (100000 samples)</p> <p>Trace 1</p> <p>Mean 22.04 dBm Peak 25.88 dBm Crest 3.84 dB</p> <p>10 % 1.76 dB 1 % 2.76 dB .1 % 3.44 dB .01 % 3.68 dB</p> <p>Date: 15.NOV.2021 14:34:30</p>	<p style="text-align: center;">Highest Channel</p>  <p>Center 1.9076 GHz 2 dB/ Mean Pwr + 20 dB</p> <p>Complementary Cumulative Distribution Function (100000 samples)</p> <p>Trace 1</p> <p>Mean 21.30 dBm Peak 25.81 dBm Crest 4.51 dB</p> <p>10 % 1.92 dB 1 % 3.20 dB .1 % 4.04 dB .01 % 4.32 dB</p> <p>Date: 15.NOV.2021 13:55:05</p>



26dB Bandwidth

Mode	WCDMA Band V: 26dB BW(MHz)	WCDMA Band II: 26dB BW(MHz)
Mod.	RMC 12.2Kbps	RMC 12.2Kbps
Lowest CH	4.72	4.70
Middle CH	4.74	4.69
Highest CH	4.74	4.68



WCDMA Band V (RMC 12.2Kbps)

WCDMA Band II (RMC 12.2Kbps)

Lowest Channel

Lowest Channel

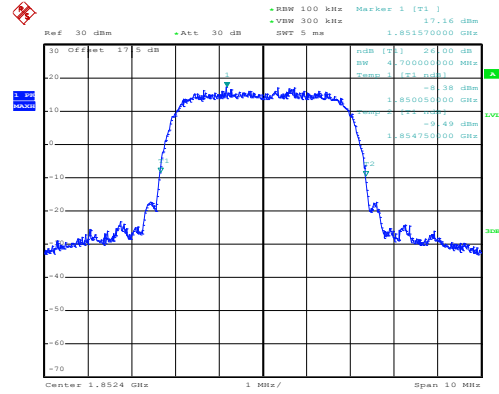
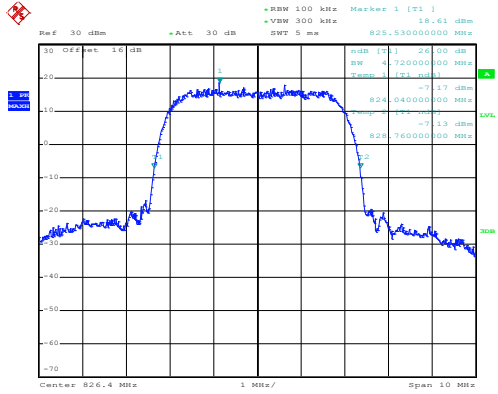

Date: 15.NOV.2021 14:22:00

Date: 15.NOV.2021 13:41:29

Middle Channel

Middle Channel

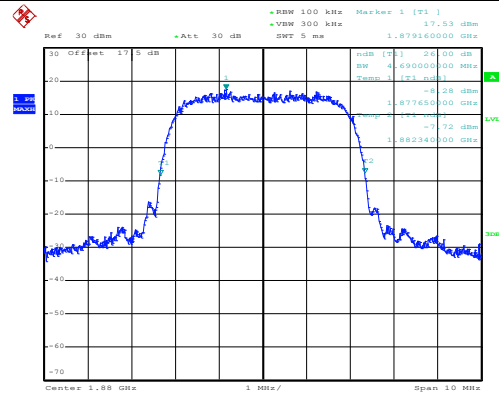
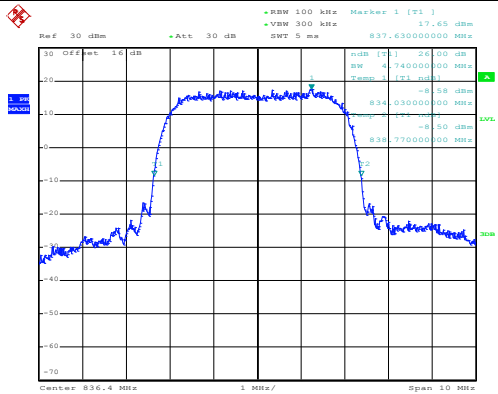

Date: 15.NOV.2021 14:22:36

Date: 15.NOV.2021 13:42:14

Highest Channel

Highest Channel

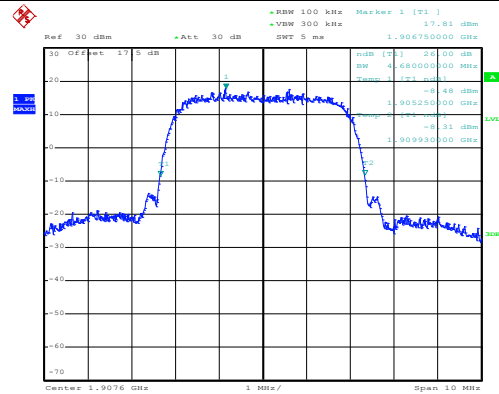
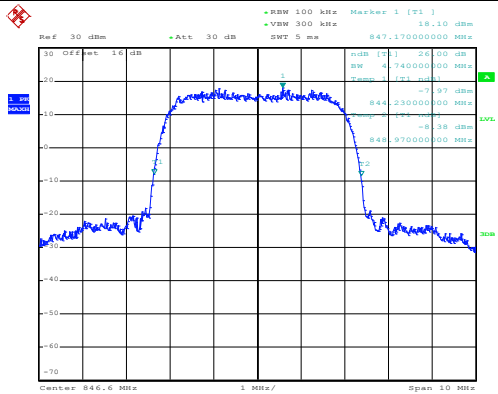

Date: 15.NOV.2021 14:23:11

Date: 15.NOV.2021 13:43:16



Occupied Bandwidth

Mode	WCDMA Band V: 99% OBW(MHz)	WCDMA Band II: 99% OBW(MHz)
Mod.	RMC 12.2Kbps	RMC 12.2Kbps
Lowest CH	4.16	4.12
Middle CH	4.16	4.14
Highest CH	4.16	4.13

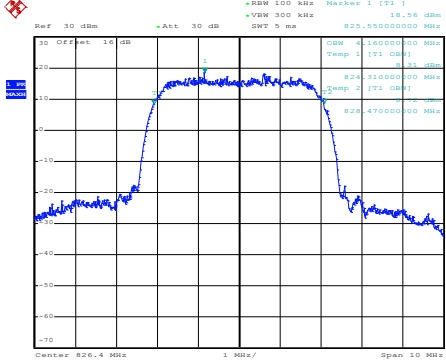
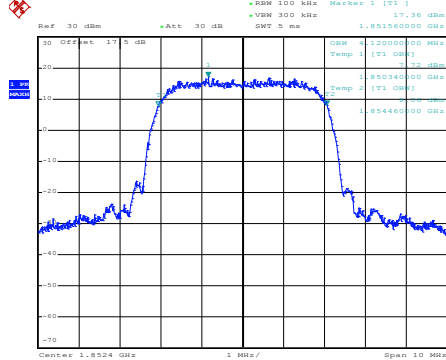
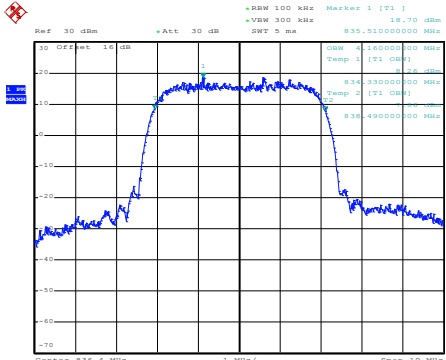
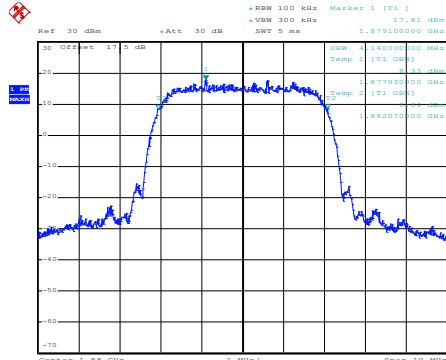
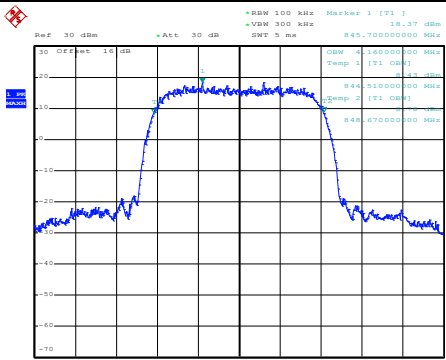
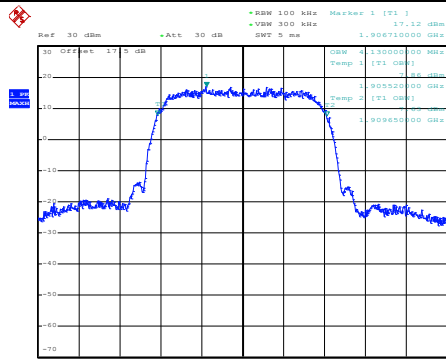

WCDMA Band V (RMC 12.2Kbps)	WCDMA Band II (RMC 12.2Kbps)
<p style="text-align: center;">Lowest Channel</p>  <p style="text-align: center;">Date: 15.NOV.2021 14:26:37</p>	<p style="text-align: center;">Lowest Channel</p>  <p style="text-align: center;">Date: 15.NOV.2021 13:46:57</p>
<p style="text-align: center;">Middle Channel</p>  <p style="text-align: center;">Date: 15.NOV.2021 14:27:12</p>	<p style="text-align: center;">Middle Channel</p>  <p style="text-align: center;">Date: 15.NOV.2021 13:47:33</p>
<p style="text-align: center;">Highest Channel</p>  <p style="text-align: center;">Date: 15.NOV.2021 14:27:48</p>	<p style="text-align: center;">Highest Channel</p>  <p style="text-align: center;">Date: 15.NOV.2021 13:48:12</p>



Conducted Band Edge

WCDMA Band V (RMC 12.2Kbps)

Lowest Band Edge

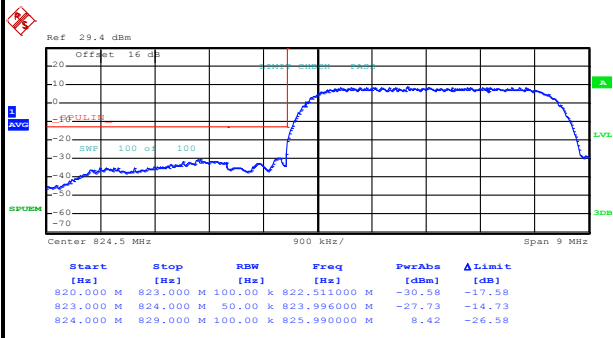

Date: 15.NOV.2021 14:30:45

Highest Band Edge

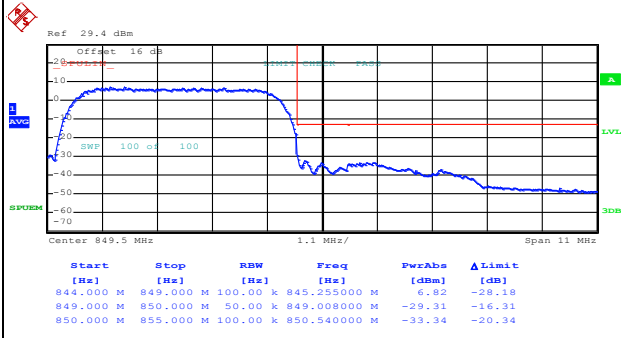

Date: 15.NOV.2021 14:33:36



WCDMA Band II (RMC 12.2Kbps)

Lowest Band Edge

Highest Band Edge

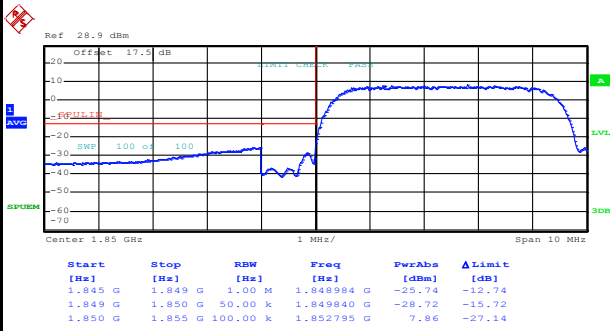

Date: 15.NOV.2021 13:51:10

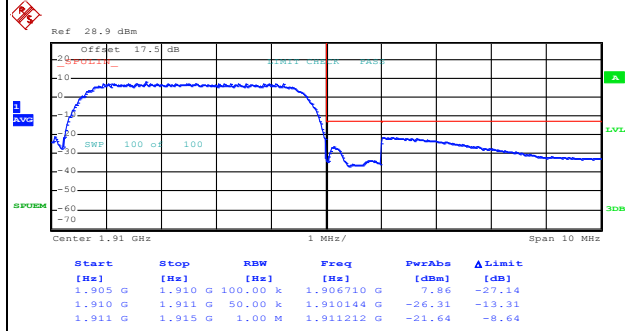

Date: 15.NOV.2021 13:54:04

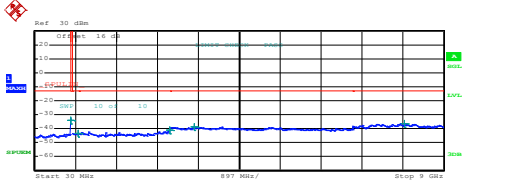
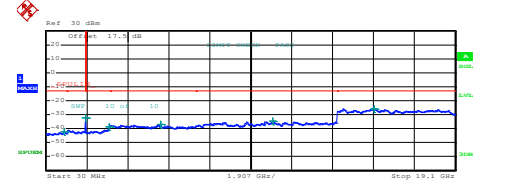
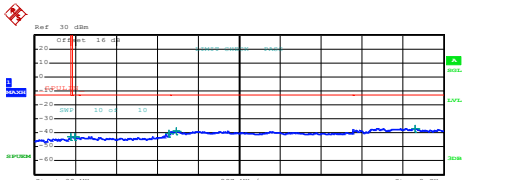
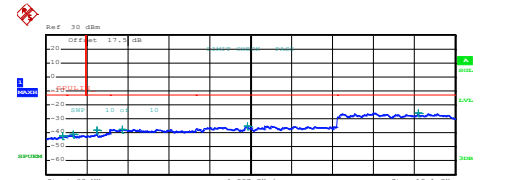
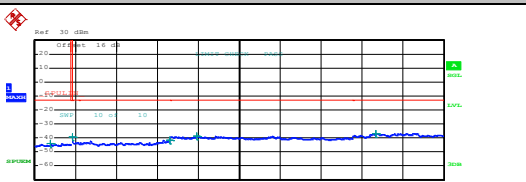
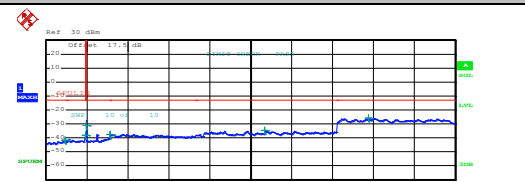

Conducted Spurious Emission

WCDMA Band V (RMC 12.2Kbps)	WCDMA Band II (RMC 12.2Kbps)																																																																																										
Lowest Channel	Lowest Channel																																																																																										
 <table border="1" data-bbox="239 660 702 739"> <thead> <tr> <th>Start</th> <th>Stop</th> <th>RBW</th> <th>Freq</th> <th>PwrAbs</th> <th>ΔLimit</th> </tr> <tr> <th>[Hz]</th> <th>[Hz]</th> <th>[Hz]</th> <th>[Hz]</th> <th>[dBm]</th> <th>[dB]</th> </tr> </thead> <tbody> <tr> <td>30,000 M</td> <td>820,000 M</td> <td>1,000 M</td> <td>818,000000 M</td> <td>-44.00</td> <td>-21.00</td> </tr> <tr> <td>855,000 M</td> <td>1,000 G</td> <td>1,000 G</td> <td>988,053759 M</td> <td>-43.26</td> <td>-30.26</td> </tr> <tr> <td>1,000 G</td> <td>3,000 G</td> <td>1,000 M</td> <td>2,997000 G</td> <td>-40.86</td> <td>-27.86</td> </tr> <tr> <td>3,000 G</td> <td>7,000 G</td> <td>1,000 M</td> <td>3,524000 G</td> <td>-38.76</td> <td>-25.76</td> </tr> <tr> <td>7,000 G</td> <td>9,000 G</td> <td>1,000 M</td> <td>8,142000 G</td> <td>-36.61</td> <td>-23.61</td> </tr> </tbody> </table> <p>Date: 15.NOV.2021 14:24:08</p>	Start	Stop	RBW	Freq	PwrAbs	ΔLimit	[Hz]	[Hz]	[Hz]	[Hz]	[dBm]	[dB]	30,000 M	820,000 M	1,000 M	818,000000 M	-44.00	-21.00	855,000 M	1,000 G	1,000 G	988,053759 M	-43.26	-30.26	1,000 G	3,000 G	1,000 M	2,997000 G	-40.86	-27.86	3,000 G	7,000 G	1,000 M	3,524000 G	-38.76	-25.76	7,000 G	9,000 G	1,000 M	8,142000 G	-36.61	-23.61	 <table border="1" data-bbox="877 660 1340 739"> <thead> <tr> <th>Start</th> <th>Stop</th> <th>RBW</th> <th>Freq</th> <th>PwrAbs</th> <th>ΔLimit</th> </tr> <tr> <th>[Hz]</th> <th>[Hz]</th> <th>[Hz]</th> <th>[Hz]</th> <th>[dBm]</th> <th>[dB]</th> </tr> </thead> <tbody> <tr> <td>30,000 M</td> <td>1,000 G</td> <td>1,000 M</td> <td>852,070000 M</td> <td>-42.30</td> <td>-29.30</td> </tr> <tr> <td>1,000 G</td> <td>3,000 G</td> <td>1,000 M</td> <td>3,844789 G</td> <td>-32.39</td> <td>-19.39</td> </tr> <tr> <td>3,000 G</td> <td>3,000 G</td> <td>1,000 M</td> <td>2,9800399 G</td> <td>-39.96</td> <td>-25.96</td> </tr> <tr> <td>3,000 G</td> <td>7,000 G</td> <td>1,000 M</td> <td>5,376000 G</td> <td>-37.20</td> <td>-24.20</td> </tr> <tr> <td>7,000 G</td> <td>13,600 G</td> <td>1,000 M</td> <td>10,609375 G</td> <td>-34.86</td> <td>-21.86</td> </tr> <tr> <td>13,600 G</td> <td>19,100 G</td> <td>1,000 M</td> <td>15,311188 G</td> <td>-25.88</td> <td>-12.88</td> </tr> </tbody> </table> <p>Date: 15.NOV.2021 13:44:16</p>	Start	Stop	RBW	Freq	PwrAbs	ΔLimit	[Hz]	[Hz]	[Hz]	[Hz]	[dBm]	[dB]	30,000 M	1,000 G	1,000 M	852,070000 M	-42.30	-29.30	1,000 G	3,000 G	1,000 M	3,844789 G	-32.39	-19.39	3,000 G	3,000 G	1,000 M	2,9800399 G	-39.96	-25.96	3,000 G	7,000 G	1,000 M	5,376000 G	-37.20	-24.20	7,000 G	13,600 G	1,000 M	10,609375 G	-34.86	-21.86	13,600 G	19,100 G	1,000 M	15,311188 G	-25.88	-12.88
Start	Stop	RBW	Freq	PwrAbs	ΔLimit																																																																																						
[Hz]	[Hz]	[Hz]	[Hz]	[dBm]	[dB]																																																																																						
30,000 M	820,000 M	1,000 M	818,000000 M	-44.00	-21.00																																																																																						
855,000 M	1,000 G	1,000 G	988,053759 M	-43.26	-30.26																																																																																						
1,000 G	3,000 G	1,000 M	2,997000 G	-40.86	-27.86																																																																																						
3,000 G	7,000 G	1,000 M	3,524000 G	-38.76	-25.76																																																																																						
7,000 G	9,000 G	1,000 M	8,142000 G	-36.61	-23.61																																																																																						
Start	Stop	RBW	Freq	PwrAbs	ΔLimit																																																																																						
[Hz]	[Hz]	[Hz]	[Hz]	[dBm]	[dB]																																																																																						
30,000 M	1,000 G	1,000 M	852,070000 M	-42.30	-29.30																																																																																						
1,000 G	3,000 G	1,000 M	3,844789 G	-32.39	-19.39																																																																																						
3,000 G	3,000 G	1,000 M	2,9800399 G	-39.96	-25.96																																																																																						
3,000 G	7,000 G	1,000 M	5,376000 G	-37.20	-24.20																																																																																						
7,000 G	13,600 G	1,000 M	10,609375 G	-34.86	-21.86																																																																																						
13,600 G	19,100 G	1,000 M	15,311188 G	-25.88	-12.88																																																																																						
Middle Channel	Middle Channel																																																																																										
 <table border="1" data-bbox="239 1176 702 1254"> <thead> <tr> <th>Start</th> <th>Stop</th> <th>RBW</th> <th>Freq</th> <th>PwrAbs</th> <th>ΔLimit</th> </tr> <tr> <th>[Hz]</th> <th>[Hz]</th> <th>[Hz]</th> <th>[Hz]</th> <th>[dBm]</th> <th>[dB]</th> </tr> </thead> <tbody> <tr> <td>30,000 M</td> <td>820,000 M</td> <td>1,000 M</td> <td>818,000000 M</td> <td>-42.75</td> <td>-29.75</td> </tr> <tr> <td>855,000 M</td> <td>1,000 G</td> <td>1,000 M</td> <td>988,056284 M</td> <td>-43.09</td> <td>-30.09</td> </tr> <tr> <td>1,000 G</td> <td>3,000 G</td> <td>1,000 M</td> <td>2,967000 G</td> <td>-40.26</td> <td>-27.26</td> </tr> <tr> <td>3,000 G</td> <td>7,000 G</td> <td>1,000 M</td> <td>3,139000 G</td> <td>-38.90</td> <td>-25.90</td> </tr> <tr> <td>7,000 G</td> <td>9,000 G</td> <td>1,000 M</td> <td>8,365000 G</td> <td>-36.70</td> <td>-23.70</td> </tr> </tbody> </table> <p>Date: 15.NOV.2021 14:25:02</p>	Start	Stop	RBW	Freq	PwrAbs	ΔLimit	[Hz]	[Hz]	[Hz]	[Hz]	[dBm]	[dB]	30,000 M	820,000 M	1,000 M	818,000000 M	-42.75	-29.75	855,000 M	1,000 G	1,000 M	988,056284 M	-43.09	-30.09	1,000 G	3,000 G	1,000 M	2,967000 G	-40.26	-27.26	3,000 G	7,000 G	1,000 M	3,139000 G	-38.90	-25.90	7,000 G	9,000 G	1,000 M	8,365000 G	-36.70	-23.70	 <table border="1" data-bbox="877 1176 1340 1254"> <thead> <tr> <th>Start</th> <th>Stop</th> <th>RBW</th> <th>Freq</th> <th>PwrAbs</th> <th>ΔLimit</th> </tr> <tr> <th>[Hz]</th> <th>[Hz]</th> <th>[Hz]</th> <th>[Hz]</th> <th>[dBm]</th> <th>[dB]</th> </tr> </thead> <tbody> <tr> <td>30,000 M</td> <td>1,000 G</td> <td>1,000 M</td> <td>809,880000 M</td> <td>-42.42</td> <td>-29.42</td> </tr> <tr> <td>1,000 G</td> <td>3,000 G</td> <td>1,000 M</td> <td>3,288707 G</td> <td>-41.33</td> <td>-28.33</td> </tr> <tr> <td>1,915 G</td> <td>3,000 G</td> <td>1,000 M</td> <td>2,410845 G</td> <td>-38.24</td> <td>-25.24</td> </tr> <tr> <td>3,000 G</td> <td>7,000 G</td> <td>1,000 M</td> <td>3,587000 G</td> <td>-37.41</td> <td>-24.41</td> </tr> <tr> <td>7,000 G</td> <td>13,600 G</td> <td>1,000 M</td> <td>9,468175 G</td> <td>-35.00</td> <td>-22.00</td> </tr> <tr> <td>13,600 G</td> <td>19,100 G</td> <td>1,000 M</td> <td>17,364750 G</td> <td>-25.92</td> <td>-12.92</td> </tr> </tbody> </table> <p>Date: 15.NOV.2021 13:45:11</p>	Start	Stop	RBW	Freq	PwrAbs	ΔLimit	[Hz]	[Hz]	[Hz]	[Hz]	[dBm]	[dB]	30,000 M	1,000 G	1,000 M	809,880000 M	-42.42	-29.42	1,000 G	3,000 G	1,000 M	3,288707 G	-41.33	-28.33	1,915 G	3,000 G	1,000 M	2,410845 G	-38.24	-25.24	3,000 G	7,000 G	1,000 M	3,587000 G	-37.41	-24.41	7,000 G	13,600 G	1,000 M	9,468175 G	-35.00	-22.00	13,600 G	19,100 G	1,000 M	17,364750 G	-25.92	-12.92
Start	Stop	RBW	Freq	PwrAbs	ΔLimit																																																																																						
[Hz]	[Hz]	[Hz]	[Hz]	[dBm]	[dB]																																																																																						
30,000 M	820,000 M	1,000 M	818,000000 M	-42.75	-29.75																																																																																						
855,000 M	1,000 G	1,000 M	988,056284 M	-43.09	-30.09																																																																																						
1,000 G	3,000 G	1,000 M	2,967000 G	-40.26	-27.26																																																																																						
3,000 G	7,000 G	1,000 M	3,139000 G	-38.90	-25.90																																																																																						
7,000 G	9,000 G	1,000 M	8,365000 G	-36.70	-23.70																																																																																						
Start	Stop	RBW	Freq	PwrAbs	ΔLimit																																																																																						
[Hz]	[Hz]	[Hz]	[Hz]	[dBm]	[dB]																																																																																						
30,000 M	1,000 G	1,000 M	809,880000 M	-42.42	-29.42																																																																																						
1,000 G	3,000 G	1,000 M	3,288707 G	-41.33	-28.33																																																																																						
1,915 G	3,000 G	1,000 M	2,410845 G	-38.24	-25.24																																																																																						
3,000 G	7,000 G	1,000 M	3,587000 G	-37.41	-24.41																																																																																						
7,000 G	13,600 G	1,000 M	9,468175 G	-35.00	-22.00																																																																																						
13,600 G	19,100 G	1,000 M	17,364750 G	-25.92	-12.92																																																																																						
Highest Channel	Highest Channel																																																																																										
 <table border="1" data-bbox="239 1691 702 1769"> <thead> <tr> <th>Start</th> <th>Stop</th> <th>RBW</th> <th>Freq</th> <th>PwrAbs</th> <th>ΔLimit</th> </tr> <tr> <th>[Hz]</th> <th>[Hz]</th> <th>[Hz]</th> <th>[Hz]</th> <th>[dBm]</th> <th>[dB]</th> </tr> </thead> <tbody> <tr> <td>30,000 M</td> <td>820,000 M</td> <td>1,000 M</td> <td>379,770000 M</td> <td>-43.70</td> <td>-30.70</td> </tr> <tr> <td>855,000 M</td> <td>1,000 G</td> <td>1,000 M</td> <td>855,072000 M</td> <td>-39.07</td> <td>-26.07</td> </tr> <tr> <td>1,000 G</td> <td>3,000 G</td> <td>1,000 M</td> <td>2,999000 G</td> <td>-42.46</td> <td>-28.46</td> </tr> <tr> <td>3,000 G</td> <td>7,000 G</td> <td>1,000 M</td> <td>3,191000 G</td> <td>-38.81</td> <td>-25.81</td> </tr> <tr> <td>7,000 G</td> <td>9,000 G</td> <td>1,000 M</td> <td>7,515000 G</td> <td>-36.69</td> <td>-23.69</td> </tr> </tbody> </table> <p>Date: 15.NOV.2021 14:25:54</p>	Start	Stop	RBW	Freq	PwrAbs	ΔLimit	[Hz]	[Hz]	[Hz]	[Hz]	[dBm]	[dB]	30,000 M	820,000 M	1,000 M	379,770000 M	-43.70	-30.70	855,000 M	1,000 G	1,000 M	855,072000 M	-39.07	-26.07	1,000 G	3,000 G	1,000 M	2,999000 G	-42.46	-28.46	3,000 G	7,000 G	1,000 M	3,191000 G	-38.81	-25.81	7,000 G	9,000 G	1,000 M	7,515000 G	-36.69	-23.69	 <table border="1" data-bbox="877 1691 1340 1769"> <thead> <tr> <th>Start</th> <th>Stop</th> <th>RBW</th> <th>Freq</th> <th>PwrAbs</th> <th>ΔLimit</th> </tr> <tr> <th>[Hz]</th> <th>[Hz]</th> <th>[Hz]</th> <th>[Hz]</th> <th>[dBm]</th> <th>[dB]</th> </tr> </thead> <tbody> <tr> <td>30,000 M</td> <td>1,000 G</td> <td>1,000 M</td> <td>895,061000 M</td> <td>-41.92</td> <td>-28.92</td> </tr> <tr> <td>1,000 G</td> <td>3,000 G</td> <td>1,000 M</td> <td>3,843521 G</td> <td>-38.40</td> <td>-25.40</td> </tr> <tr> <td>3,000 G</td> <td>3,000 G</td> <td>1,000 M</td> <td>2,932071 G</td> <td>-33.38</td> <td>-18.38</td> </tr> <tr> <td>3,000 G</td> <td>7,000 G</td> <td>1,000 M</td> <td>3,013000 G</td> <td>-37.29</td> <td>-24.29</td> </tr> <tr> <td>7,000 G</td> <td>13,600 G</td> <td>1,000 M</td> <td>10,221625 G</td> <td>-34.67</td> <td>-21.67</td> </tr> <tr> <td>13,600 G</td> <td>19,100 G</td> <td>1,000 M</td> <td>15,031313 G</td> <td>-25.89</td> <td>-12.89</td> </tr> </tbody> </table> <p>Date: 15.NOV.2021 13:46:06</p>	Start	Stop	RBW	Freq	PwrAbs	ΔLimit	[Hz]	[Hz]	[Hz]	[Hz]	[dBm]	[dB]	30,000 M	1,000 G	1,000 M	895,061000 M	-41.92	-28.92	1,000 G	3,000 G	1,000 M	3,843521 G	-38.40	-25.40	3,000 G	3,000 G	1,000 M	2,932071 G	-33.38	-18.38	3,000 G	7,000 G	1,000 M	3,013000 G	-37.29	-24.29	7,000 G	13,600 G	1,000 M	10,221625 G	-34.67	-21.67	13,600 G	19,100 G	1,000 M	15,031313 G	-25.89	-12.89
Start	Stop	RBW	Freq	PwrAbs	ΔLimit																																																																																						
[Hz]	[Hz]	[Hz]	[Hz]	[dBm]	[dB]																																																																																						
30,000 M	820,000 M	1,000 M	379,770000 M	-43.70	-30.70																																																																																						
855,000 M	1,000 G	1,000 M	855,072000 M	-39.07	-26.07																																																																																						
1,000 G	3,000 G	1,000 M	2,999000 G	-42.46	-28.46																																																																																						
3,000 G	7,000 G	1,000 M	3,191000 G	-38.81	-25.81																																																																																						
7,000 G	9,000 G	1,000 M	7,515000 G	-36.69	-23.69																																																																																						
Start	Stop	RBW	Freq	PwrAbs	ΔLimit																																																																																						
[Hz]	[Hz]	[Hz]	[Hz]	[dBm]	[dB]																																																																																						
30,000 M	1,000 G	1,000 M	895,061000 M	-41.92	-28.92																																																																																						
1,000 G	3,000 G	1,000 M	3,843521 G	-38.40	-25.40																																																																																						
3,000 G	3,000 G	1,000 M	2,932071 G	-33.38	-18.38																																																																																						
3,000 G	7,000 G	1,000 M	3,013000 G	-37.29	-24.29																																																																																						
7,000 G	13,600 G	1,000 M	10,221625 G	-34.67	-21.67																																																																																						
13,600 G	19,100 G	1,000 M	15,031313 G	-25.89	-12.89																																																																																						



Frequency Stability

Test Conditions	Middle Channel	WCDMA Band V (RMC 12.2Kbps)	Limit 2.5ppm
Temperature (°C)	Voltage (Volt)	Deviation (ppm)	Result
50	Normal Voltage	0.0060	PASS
40	Normal Voltage	0.0024	
30	Normal Voltage	0.0048	
20(Ref.)	Normal Voltage	0.0000	
10	Normal Voltage	0.0000	
0	Normal Voltage	0.0036	
-10	Normal Voltage	0.0048	
-20	Normal Voltage	0.0060	
-30	Normal Voltage	0.0096	
20	Maximum Voltage	0.0024	
20	Normal Voltage	0.0000	
20	Battery End Point	0.0048	



Test Conditions	Middle Channel	WCDMA Band II (RMC 12.2Kbps)	Limit Note 2.
Temperature (°C)	Voltage (Volt)	Deviation (ppm)	Result
50	Normal Voltage	0.0027	PASS
40	Normal Voltage	0.0005	
30	Normal Voltage	0.0011	
20(Ref.)	Normal Voltage	0.0000	
10	Normal Voltage	0.0005	
0	Normal Voltage	0.0005	
-10	Normal Voltage	0.0005	
-20	Normal Voltage	0.0000	
-30	Normal Voltage	0.0011	
20	Maximum Voltage	0.0011	
20	Normal Voltage	0.0000	
20	Battery End Point	0.0005	

Note:

1. Normal Voltage = 12V. ; Battery End Point (BEP) = 11.4 V. ; Maximum Voltage =12.6 V
2. The frequency fundamental emissions stay within the authorized frequency block.



Appendix B. Test Results of Radiated Test

WCDMA 850

WCDMA 850									
Channel	Frequency (MHz)	ERP (dBm)	Limit (dBm)	Over Limit (dB)	SPA Reading (dBm)	S.G. Power (dBm)	TX Cable loss (dB)	TX Antenna Gain (dBi)	Polarization (H/V)
Lowest	1652	-54.07	-13	-41.07	-64.03	-56.50	4.93	9.51	H
	2479	-58.63	-13	-45.63	-71.68	-60.90	6.08	10.50	H
	3305	-61.60	-13	-48.60	-78.34	-63.52	7.04	11.11	H
									H
									H
									H
	1652	-58.79	-13	-45.79	-68.52	-61.22	4.93	9.51	V
	2479	-59.94	-13	-46.94	-72.94	-62.21	6.08	10.50	V
	3305	-62.76	-13	-49.76	-79.25	-64.68	7.04	11.11	V
									V
									V
									V
Middle	1672	-53.87	-13	-40.87	-63.83	-56.39	4.96	9.63	H
	2509	-58.71	-13	-45.71	-71.88	-60.94	6.12	10.50	H
	3344	-62.45	-13	-49.45	-79.14	-64.41	7.08	11.19	H
									H
									H
									H
	1672	-58.09	-13	-45.09	-67.83	-60.61	4.96	9.63	V
	2508	-59.16	-13	-46.16	-72.23	-61.39	6.12	10.50	V
	3344	-62.94	-13	-49.94	-79.38	-64.90	7.08	11.19	V
									V
									V
									V



Highest	1693	-53.47	-13	-40.47	-63.45	-56.09	4.99	9.76	H
	2539	-58.72	-13	-45.72	-72.1	-60.91	6.16	10.50	H
	3386	-61.71	-13	-48.71	-78.34	-63.71	7.13	11.27	H
									H
									H
									H
	1693	-58.52	-13	-45.52	-68.28	-61.14	4.99	9.76	V
	2539	-58.63	-13	-45.63	-71.88	-60.82	6.16	10.50	V
	3386	-61.99	-13	-48.99	-78.37	-63.99	7.13	11.27	V
									V
									V
									V

Remark: Spurious emissions within 30-1000MHz were found more than 20dB below limit line.



WCDMA 1900

WCDMA 1900									
Channel	Frequency (MHz)	EIRP (dBm)	Limit (dBm)	Over Limit (dB)	SPA Reading (dBm)	S.G. Power (dBm)	TX Cable loss (dB)	TX Antenna Gain (dBi)	Polarization (H/V)
Lowest	3704	-54.20	-13	-41.20	-72.66	-58.59	7.50	11.89	H
	5557	-49.07	-13	-36.07	-71.55	-52.36	9.19	12.49	H
	7409	-56.70	-13	-43.70	-83.26	-57.25	10.68	11.24	H
									H
									H
									H
	3704	-53.22	-13	-40.22	-71.3	-57.61	7.50	11.89	V
	5557	-48.98	-13	-35.98	-71.41	-52.27	9.19	12.49	V
	7409	-56.46	-13	-43.46	-83.36	-57.01	10.68	11.24	V
									V
									V
									V
Middle	3760	-52.58	-13	-39.58	-71.33	-56.77	7.57	11.76	H
	5640	-51.75	-13	-38.75	-74.52	-54.72	9.27	12.24	H
	7520	-57.49	-13	-44.49	-84.05	-58.31	10.76	11.58	H
									H
									H
									H
	3760	-55.25	-13	-42.25	-73.69	-59.44	7.57	11.76	V
	5640	-50.35	-13	-37.35	-73.15	-53.32	9.27	12.24	V
	7520	-57.27	-13	-44.27	-84.05	-58.09	10.76	11.58	V
									V
									V
									V



Highest	3815	-53.26	-13	-40.26	-72.27	-57.17	7.63	11.54	H
	5722	-48.34	-13	-35.34	-71.45	-50.91	9.34	11.91	H
	7630	-54.84	-13	-41.84	-81.59	-55.63	10.85	11.64	H
									H
									H
									H
	3815	-52.33	-13	-39.33	-71.09	-56.24	7.63	11.54	V
	5722	-44.80	-13	-31.80	-68.09	-47.37	9.34	11.91	V
	7630	-54.14	-13	-41.14	-81.17	-54.93	10.85	11.64	V
									V
									V
									V

Remark: Spurious emissions within 30-1000MHz were found more than 20dB below limit line.