

# Connected Cooler Radio

## Quick Start Guide



# Table of Contents

---

<b>1. GETTING STARTED</b> .....	<b>5</b>
1.1 UNPACKING INFORMATION .....	5
1.2 INTRODUCTION.....	5
<b>2. PORTS AND LED INDICATORS</b> .....	<b>6</b>
2.1 PORTS .....	6
2.2 LED INDICATORS.....	7
<b>3. INSTALLATION</b> .....	<b>8</b>
<b>4. SPECIFICATIONS</b> .....	<b>10</b>

# Declaration of Conformity

---

## Manufacturer:

**Name:** Wistron NeWeb Corporation

**Address:** 20 Park Avenue II, Hsinchu Science Park, Hsinchu 308, Taiwan,  
R.O.C

## Radio Equipment:

**Model:** D52A1

**Description:** Connected Cooler Radio Rest of World version

**Marketing Name:** D52A1

**Radio-related Software Version:** D52A1\_v00.00

**Supplied Accessories and Components:** NA

We, Wistron NeWeb Corporation, declare under our sole responsibility that the product described above is in conformity with the relevant Union harmonization legislation:

### **RE Directive (2014/53/EU), RoHS Directive (2011/65/EU)**

The following harmonized standards and/or other relevant standards have been applied:

#### **1. Health and Safety (Article 3.1(a) of the RE Directive)**

- EN 62311:2008
- EN 60950-1:2006/A11:2009+A1:2010+A12:2011+A2:2013

#### **2. Electromagnetic compatibility (Article 3.1 (b) of the RE Directive)**

- Final Draft ETSI EN 301 489-1 V2.1.1,
- Draft ETSI EN 301 489-3 V2.1.0
- Final Draft ETSI EN 301 489-17 V3.1.1
- Draft ETSI EN 301 489-52 V1.1.0

#### **3. Radio frequency spectrum usage (Article 3.2 of the RE Directive)**

- ETSI EN 301 908-1 V11.1.1, ETSI EN 301 908-2 V11.1.1
- ETSI EN 300 328 V2.1.1
- Draft ETSI EN 301 511 V12.1.10
- Draft ETSI EN 300 440 V2.1.0

#### **4. RoHS Directive (2011/65/EU)**

- EN 50581:2012

**Signed for and on behalf of:** Wistron NeWeb Corporation

**Place:** 20 Park Avenue II, Hsinchu Science Park, Hsinchu 308, Taiwan, R.O.C; **date:** January 4, 2017

**Name:** Brian Lin; **function:** Technical Manager; **signature:**

# 1. Getting Started

---

## 1.1 Unpacking Information

- The Connected Cooler Radio (CCR)
- Battery notice card

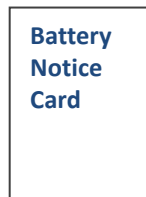

## 1.2 Introduction

The Connected Cooler Radio (CCR) works with sensors installed in coolers to deliver cooler information to Cloud servers for better monitoring and management. The Wi-Fi, AGPS, and 2G/3G (based on the models you select) functions of the CCR enables stable delivery of accurate information collected by analog or digital sensors.

## 2. Ports and LED Indicators

---

### 2.1 Ports

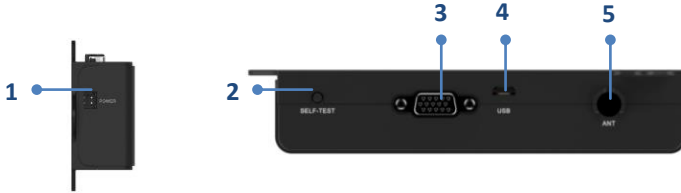

	Port	Description
1	Power	Power supply connection
2	Self-test button	The button for activating the self-test process
3	Sensor port	Connects to sensors installed in the cooler
4	Engineering	For engineering uses only
5	ANT	Antenna connection

## 2.2 LED Indicators

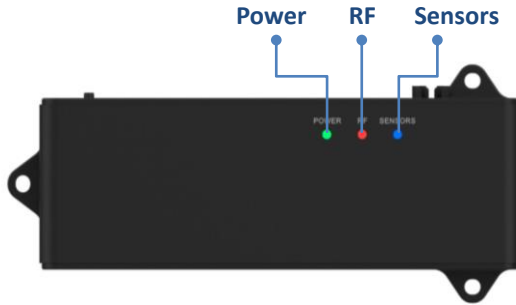

LED	Indication	Description
<b>Power</b>	Steady green	All self-tests passed, and the battery is full.
	Blinking green	All self-tests passed, and the battery is charging
	Off	No power connection
<b>RF</b>	Steady red	Other failures; for example, SIM card, battery, or Wi-Fi functions
	Blinking red	Unsuccessful antenna connection
<b>Sensors</b>	Steady blue	The self-test mode is running.
	Blinking blue	Detected function failure of the temperature sensor or door-open sensor.

### Notes:

- 1) This table is only valid for checking the information after pressing the self-test button.
- 2) The Power LED (Green) will be on during Operating AC mode.

# 3. Installation

---

1. Place the CCR in the specified location (for example wall) and affix the screws.

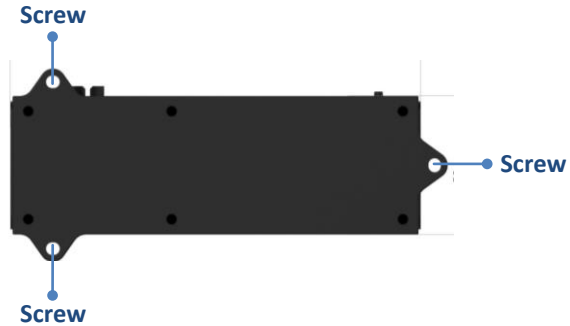

Screw use type M4

2. Attach the antenna to the antenna port of the CCR.



3. Connect the power port to the power supply.

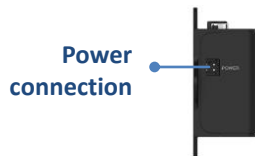



4. Connect the Sensor port to the sensors.

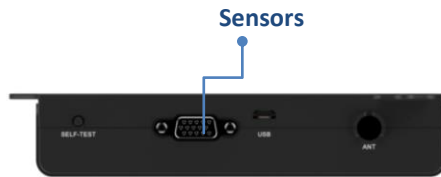

5. Press the Self-test button. The system begins testing the CCR and the sensors attached to the CCR.



6. The system will be ready for use when the Power LED returns to steady green, indicating the system functions normally.  
Refer to the “LED Indicators” section of this document for details if other LED indications are displayed.

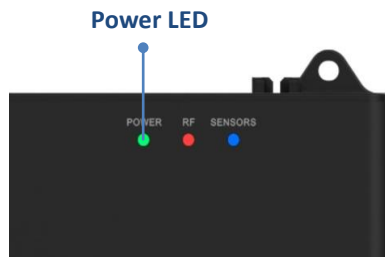

# 4. Specifications

## Specifications

**Standards**      Wi-Fi: IEEE 802.11b/g/n (2.4 GHz)  
 BLE  
 3G: B1/2/5/8; GPRS/EDGE Quad-Band

**Max. power for each frequency And Antenna Typy Antenna Gain**

<b>Mobile</b>			
		<b>Max. Power (dBm)</b>	<b>Antenna peak Gain (dBi)</b>
<b>GPRS Band(s)</b>	GSM 850	34	1
	E-GSM 900	34	0
	DCS 1800	32	4
	PCS 1900	30.8	4
<b>UMTS Band(s)</b>	FDD I	25	4
	FDD II	25	4
	FDD V	25	1
	FDD VIII	25	0
<b>*Antenna Type</b>			
<b>*Antenna</b>	2G/3G	Fixed External	Antenna

WLAN	
WiFi TX	11b/g/n
Max Power(dBm)	17.9
Antenna peak Gain (dBi)	1
Antenna type	internal PCB antenna
BLE	
Max Power(dBm)	4
Antenna peak Gain (dBi)	1
Antenna type	internal PCB antenna

**Regions and countries applicable**

Worldwide, out of USA and Canada.

**Connection interfaces**

USIM 3FF, VGA for sensor(optional)

**Power input**

12 V DC/ 1A (powered by UL Listed power source.)  
Backup battery: 3.7 V > 900 mAH Li-Ion

**Environment**

Ambient operating temperature: -20 °C to +60 °C  
Storage temperature: -40 °C to +70 °C

**Dimensions**

150 mm (L) × 50 mm (W) ×30 mm (H)  
(without antenna and screws)

# 5. Instruction

---

## Instruction

### CAUTION

- Only authorized service providers shall replace battery.
  - Do not disassemble or open crush, bend or deform, puncture or shred
  - Do not modify or remanufacture, attempt to insert foreign objects into the battery, immerse or expose to water or other liquids, expose to fire, explosion or other hazard.
  - Only use the battery with a charging system that has been qualified with the system per CTIA Certification Requirements for Battery System Compliance to IEEE 1725. Use of an unqualified battery or charger may present a risk of fire, explosion, leakage, or other hazard.
  - Replace the battery only with another battery that has been qualified with the system per this standard, IEEE-Std-1725. Use of an unqualified battery may present a risk of fire, explosion, leakage or other hazard.
  - Promptly dispose of used batteries in accordance with local regulations
  - Avoid dropping the device or battery. If the device or battery is dropped, especially on a hard surface, and the user suspects damage, take it to a service center for inspection.
  - Improper battery use may result in a fire, explosion or other hazard.
- For those host devices that utilize a USB port as a charging source, the host device's user manual shall include a statement that the device shall only be connected to CTIA certified adapters, products that bear the USB-IF logo or products that have



## **Specific Absorption Rate information**

This mobile device meets the government's requirements for exposure to radio waves. Your mobile device is a radio transmitter and receiver. The exposure standard for mobile devices employs a unit of measurement known as the Specific Absorption Rate, or SAR. The SAR limit adopted by Europe is 2.0 W/kg averaged over 10 grams of tissue. Tests for SAR are conducted using standard operating positions with the device transmitting at its highest certified power level in all tested frequency bands. The minimum distance between the user and/or any bystander and the radiating structure of the transmitter is 20cm.

## **FCC Regulations:**

This device complies with part 15 of the FCC Rules.

Operation is subject to the following two conditions: (1) This device may not cause harmful interference, and (2) this device must accept any interference received, including interference that may cause undesired operation.

This device has been tested and found to comply with the limits for a Class B digital device, pursuant to Part 15 of the FCC Rules. These limits are designed to provide reasonable protection against harmful interference in a residential installation. This equipment generates, uses and can radiated radio frequency energy and, if not installed and used in accordance with the instructions, may cause harmful interference to radio communications. However, there is no guarantee that interference will not occur in a particular installation. If this equipment does cause harmful interference to radio or television reception, which can be determined by turning the equipment off and on, the user is encouraged to try to correct the interference by one or more of the following measures:

- Reorient or relocate the receiving antenna.
- Increase the separation between the equipment and receiver.
- Connect the equipment into an outlet on a circuit different from that to which the receiver is connected.
- Consult the dealer or an experienced radio/TV technician for help.

**Caution:** Changes or modifications not expressly approved by the party responsible for compliance could void the user's authority to operate the equipment.

### **RF Exposure Information**

This device complies with FCC radiation exposure limits set forth for an uncontrolled environment. In order to avoid the possibility of exceeding the FCC radio frequency exposure limits, human proximity to the antenna shall not be less than 20cm (8 inches) during normal operation.