



DFS TEST REPORT

REPORT NO.: RF960328L02

MODEL NO.: CM9, CM9-GP

RECEIVED: March 28, 2007

TESTED: April 12, 2007

ISSUED: April 13, 2007

APPLICANT: Wistron NeWeb Corp.

ADDRESS: No. 10-1, Li-hsin Road I, Hsinchu Science Park, Hsinchu 300, Taiwan, R.O.C.

ISSUED BY: Advance Data Technology Corporation

TEST LOCATION: No. 81-1, Lu Liao Keng, 9 Ling, Wu Lung Tsuen, Chiung Lin Hsiang, Hsin Chu Hsien, Taiwan, R.O.C.

This test report consists of 19 pages in total. It may be duplicated completely for legal use with the approval of the applicant. It should not be reproduced except in full, without the written approval of our laboratory. The client should not use it to claim product endorsement by TAF, A2LA or any government agencies. The test results in the report only apply to the tested sample.



No.: 2177-01



Table of Contents

1.	LAB DECLARATION	3
2.	EUT INFORMATION	4
2.1	OPERATING FREQUENCY BANDS AND MODE OF EUT	4
2.2	EUT SOFTWARE AND FIRMWARE VERSION	4
2.3	DESCRIPTION OF AVAILABLE ANTENNAS TO THE EUT	4
2.4	EUT MAXIMUM AND MINIMUM CONDUCTED POWER.....	5
2.5	EUT MAXIMUM AND MINIMUM E.I.R.P. POWER.....	5
2.6	STATEMENT OF MAUNFACTURER.....	5
3.	NII DFS RULE REQUIREMENTS.....	6
3.1	WORKING MODES AND REQUIRED TEST ITEMS	6
3.2	TEST LIMITS AND RADAR SIGNAL PARAMETERS	7
4.	TEST & SUPPORT EQUIPMENT LIST	9
4.1	TEST INSTRUMENTS	9
4.2	DESCRIPTION OF SUPPORT UNITS	9
5.	TEST PROCEDURE	10
5.1	ADT DFS MEASUREMENT SYSTEM:.....	10
5.2	CALIBRATION OF DFS DETECTION THRESHOLD LEVEL:	11
5.3	DEVIATION FROM TEST STANDARD	12
5.4	CONDUCTED TEST SETUP CONFIGURATION.....	12
5.4.1	CLIENT WITHOUT RADAR DETECTION MODE.....	12
6.	TEST RESULTS	13
6.1	SUMMARY OF TEST RESULT	13
6.2	DETELED TEST RESULTS	14
6.2.1	TEST MODE: DEVICE OPERATING IN CLIENT WITHOUT RADAR DETECTION MODE.....	14
6.2.1.1	DFS DETECTION THRESHOLD.....	14
6.2.1.2	CHANNEL CLOSING TRANSMISSION AND CHANNEL MOVE TIME.....	15
7.	TESTING LABORATORIES INFORMATION	18
8.	APPENDIX-A- MODIFICATIONS RECORDERS FOR ENGINEERING CHANGES TO THE EUT BY THE LAB	19



1. LAB DECLARATION

PRODUCT: WLAN 802.11a/b/g mini-PCI module (RoHS version)
BRAND NAME: WNC
MODEL NO.: CM9, CM9-GP
TEST SAMPLE: ENGINEERING SAMPLE
TESTED: April 12, 2007
APPLICANT: Wistron NeWeb Corp.
STANDARDS: **FCC Part 15, Subpart E (Section 15.407)**
FCC 06-96

The above equipment (Model: CM9, CM9-GP) has been tested by **Advance Data Technology Corporation**, and found compliance with the requirement of the above standards. The test record, data evaluation & Equipment Under Test (EUT) configurations represented herein are true and accurate accounts of the measurements of the sample's EMC characteristics under the conditions specified in this report.

PREPARED BY : Midoli Peng , **DATE:** July 09, 2007
(Midoli Peng, Specialist)

TECHNICAL ACCEPTANCE : Hank Chung , **DATE:** July 09, 2007
Responsible for RF (Hank Chung, Deputy Manager)

APPROVED BY : May Chen , **DATE:** July 09, 2007
(May Chen, Deputy Manager)

2. EUT INFORMATION

2.1 OPERATING FREQUENCY BANDS AND MODE OF EUT

Table 1: Operating frequency bands and mode of EUT.

Operational Mode	Operating Frequency Range
	5250~5350MHz
Client without radar detection	✓

2.2 EUT SOFTWARE AND FIRMWARE VERSION

Table 2: The EUT software/firmware version.

No.	Product	Model No.	Software/Firmware Version
1	WLAN 802.11a/b/g mini-PCI module (RoHS version)	CM9	Atheros Client Utility Version 11.50.0.43969

2.3 DESCRIPTION OF AVAILABLE ANTENNAS TO THE EUT

Table 3: Antenna list.

Ant NO.	Antenna	Type	Operation Frequency Range	Max. Gain(dBi)
1	FCF-004 , made by Long-Chu Co.	Dipole	5.15 – 5.85 GHz	3.50
2	DBA-IPEX-01 , made by Long-Chu Co.	Dipole	5.15 – 5.85 GHz	3.11
3	SRSM5150MRA;SRSM240 0MRA , made by CUSLICRAFT	Dipole	5.15 – 5.85 GHz	2.00
4	DBA-BSMA-01 , made by Wistron NeWeb	Dipole	5.15 – 5.85 GHz	2.50
5	DBA-SSMA-01 , made by Wistron NeWeb	Dipole	5.15 – 5.85 GHz	2.50
6	DBA-IPEX-02 , made by Long-Chu Co.	Dipole	5.15 – 5.85 GHz	3.19
7	1770460-1 , made by TYCO	Dipole	5.15 – 5.85 GHz	3.64
8	1770461-1 , made by TYCO	Dipole	5.15 – 5.85 GHz	2.19
9	1770462-1 , made by TYCO	Dipole	5.15 – 5.85 GHz	1.19

2.4 EUT MAXIMUM AND MINIMUM CONDUCTED POWER

Table 4: The measured conducted output power.

Ant NO.	Frequency Band(MHz)	MAX. Power		MIN. Power	
		Output Power(dBm)	Output Power(mW)	Output Power(dBm)	Output Power(mW)
1	5250~5350MHz	18.39	69.02398038	11.61	14.48771854

2.5 EUT MAXIMUM AND MINIMUM E.I.R.P. POWER

Table 5: The E.I.R.P output power list.

Ant NO.	Frequency Band(MHz)	MAX. Power		MIN. Power	
		Output Power(dBm)	Output Power(mW)	Output Power(dBm)	Output Power(mW)
1	5250~5350MHz	22.03	159.5879147	15.25	33.49654392

2.6 STATEMENT OF MAUNFACTURER

Manufacturer statement confirming that information regarding the parameters of the detected Radar Waveforms is not available to the end user. **And the device doesn't have Ad Hoc mode on DFS frequency band.**

3. NII DFS RULE REQUIREMENTS

3.1 WORKING MODES AND REQUIRED TEST ITEMS

The manufacturer shall state whether the UUT is capable of operating as a Master and/or a Client. If the UUT is capable of operating in more than one operating mode then each operating mode shall be tested separately. See tables 1 and 2 for the applicability of DFS requirements for each of the operational modes.

Table 6: Applicability of DFS requirements prior to use a channel

Requirement	Operational Mode		
	Master	Client without radar detection	Client with radar detection
Non-Occupancy Period	✓	Not required	✓
DFS Detection Threshold	✓	Not required	✓
Channel Availability Check Time	✓	Not required	Not required
Uniform Spreading	✓	Not required	Not required
U-NII Detection Bandwidth	✓	Not required	✓

Table 7: Applicability of DFS requirements during normal operation.

Requirement	Operational Mode		
	Master	Client without radar detection	Client with radar detection
DFS Detection Threshold	✓	Not required	✓
Channel Closing Transmission Time	✓	✓	✓
Channel Move Time	✓	✓	✓
U-NII Detection Bandwidth	✓	Not required	✓

3.2 TEST LIMITS AND RADAR SIGNAL PARAMETERS

DETECTION THRESHOLD VALUES

Table 8: DFS Detection Thresholds for Master Devices and Client Devices With Radar Detection.

Maximum Transmit Power	Value (See Notes 1 and 2)
≥ 200 milliwatt	-64 dBm
< 200 milliwatt	-62 dBm

Note 1: This is the level at the input of the receiver assuming a 0 dBi receive antenna.
 Note 2: Throughout these test procedures an additional 1 dB has been added to the amplitude of the test transmission waveforms to account for variations in measurement equipment. This will ensure that the test signal is at or above the detection threshold level to trigger a DFS response.

Table 9: DFS Response Requirement Values

Parameter	Value
Non-occupancy period	Minimum 30 minutes
Channel Availability Check Time	60 seconds
Channel Move Time	10 seconds See Note 1.
Channel Closing Transmission Time	200 milliseconds + an aggregate of 60 milliseconds over remaining 10 second period. See Notes 1 and 2.
U-NII Detection Bandwidth	Minimum 80% of the UNII 99% transmission power bandwidth. See Note 3.

Note 1: The instant that the Channel Move Time and the Channel Closing Transmission Time begins is as follows:
 • For the Short Pulse Radar Test Signals this instant is the end of the Burst.
 • For the Frequency Hopping radar Test Signal, this instant is the end of the last radar Burst generated.
 • For the Long Pulse Radar Test Signal this instant is the end of the 12 second period defining the Radar Waveform.
Note 2: The Channel Closing Transmission Time is comprised of 200 milliseconds starting at the beginning of the Channel Move Time plus any additional intermittent control signals required to facilitate a Channel move (an aggregate of 60 milliseconds) during the remainder of the 10 second period. The aggregate duration of control signals will not count quiet periods in between transmissions.
Note 3: During the U-NII Detection Bandwidth detection test, radar type 1 is used and for each frequency step the minimum percentage of detection is 90 percent. Measurements are performed with no data traffic.

PARAMETERS OF DFS TEST SIGNALS

Step intervals of 0.1 microsecond for Pulse Width, 1 microsecond for PRI, 1 MHz for chirp width and 1 for the number of pulses will be utilized for the random determination of specific test waveforms.

Table 10: Short Pulse Radar Test Waveforms.

Radar Type	Pulse Width (μsec)	PRI (μsec)	Number of Pulses	Minimum Percentage of Successful Detection	Minimum Number of Trials
1	1	1428	18	60%	30
2	1-5	150-230	23-29	60%	30
3	6-10	200-500	16-18	60%	30
4	11-20	200-500	12-16	60%	30
Aggregate (Radar Types 1-4)				80%	120

Table 11: Long Pulse Radar Test Waveform

Radar Type	Pulse Width (μsec)	Chirp Width (MHz)	PRI (μsec)	Number of Pulses per Burst	Number of Bursts	Minimum Percentage of Successful Detection	Minimum Number of Trials
5	50-100	5-20	1000-2000	1-3	8-20	80%	30

Table 12: Frequency Hopping Radar Test Waveform

Radar Type	Pulse Width (μsec)	PRI (μsec)	Pulses per Hop	Hopping Rate (kHz)	Hopping Sequence Length (msec)	Minimum Percentage of Successful Detection	Minimum Number of Trials
6	1	333	9	0.333	300	70%	30

4. TEST & SUPPORT EQUIPMENT LIST

4.1 TEST INSTRUMENTS

Table 1: Test instruments list.

DESCRIPTION & MANUFACTURER	MODEL NO.	BRAND	CALIBRATED UNTIL
R&S Spectrum analyzer	FSP40	R&S	Aug. 15, 2007
Signal generator	8645A	Agilent	May. 26, 2008
Oscilloscope	TDS 5104	Tektronix	Apr. 16. 2008

4.2 DESCRIPTION OF SUPPORT UNITS

Table 2: Support Unit information.

No.	Product	Brand	Model No.	ID	Spec.
1	802.11a/b/g Access Point	Cisco	AIR-AP1242AG-A-K9	LDK102056	The maximum EIRP is 21.5 dBm, Antenna Gain is 3dBi

Note: This device was functioned as a Master device during the DFS test.

Table 3: Software/Firmware information.

No.	Product	Model No.	Software/Firmware Version
1.	802.11a/b/g Access Point	AIR-AP1242AG-A-K9	C1240-K9W7-TAR.123-8.JEA

5. TEST PROCEDURE

5.1 ADT DFS MEASUREMENT SYSTEM:

A complete ADT DFS Measurement System consists of two subsystems: (1) the Radar Signal Generating Subsystem and (2) the Traffic Monitoring Subsystem. The control PC is necessary for generating the Radar waveforms in Table 6, 7 and 8. The traffic monitoring subsystem is specified to the type of unit under test (UUT).

Conducted setup configuration of ADT DFS Measurement System

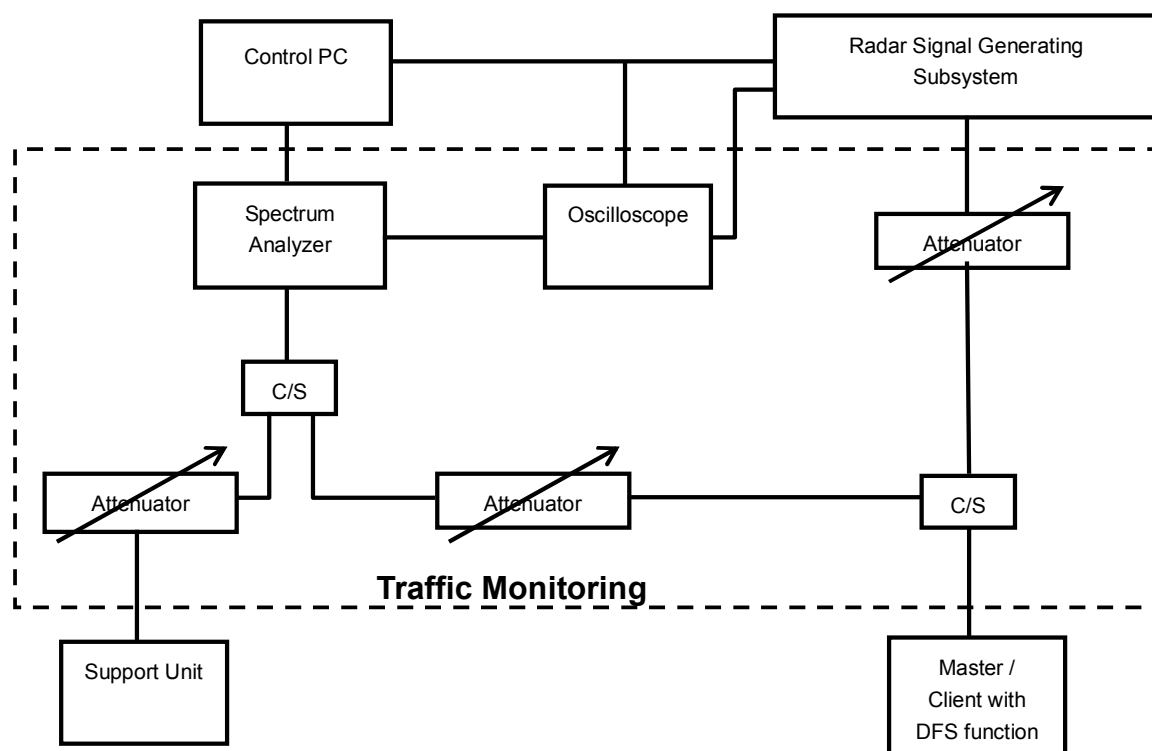

The test transmission will always be from the Master Device to the Client Device. While the Client device is set up to associate with the Master device and play the MPEG file (6 $\frac{1}{2}$ Magic Hours) from Master device, the designated MPEG test file and instructions are located at:

<http://ntiacsd.ntia.doc.gov/dfs/>.

5.2 CALIBRATION OF DFS DETECTION THRESHOLD LEVEL:

The measured channel is 5320MHz. The radar signal was the same as transmitted channels, and injected into the antenna port of AP (master) or Client Device with Radar Detection, measured the channel closing transmission time and channel move time. The Master antenna gain is 3dBi and required detection threshold is -58dBm (= -62 +1+3)dBm. The calibrated conducted detection threshold level is set to -59dBm. The tested level is lower than required level hence it provides margin to the limit.

Conducted setup configuration of Calibration of DFS Detection Threshold Level

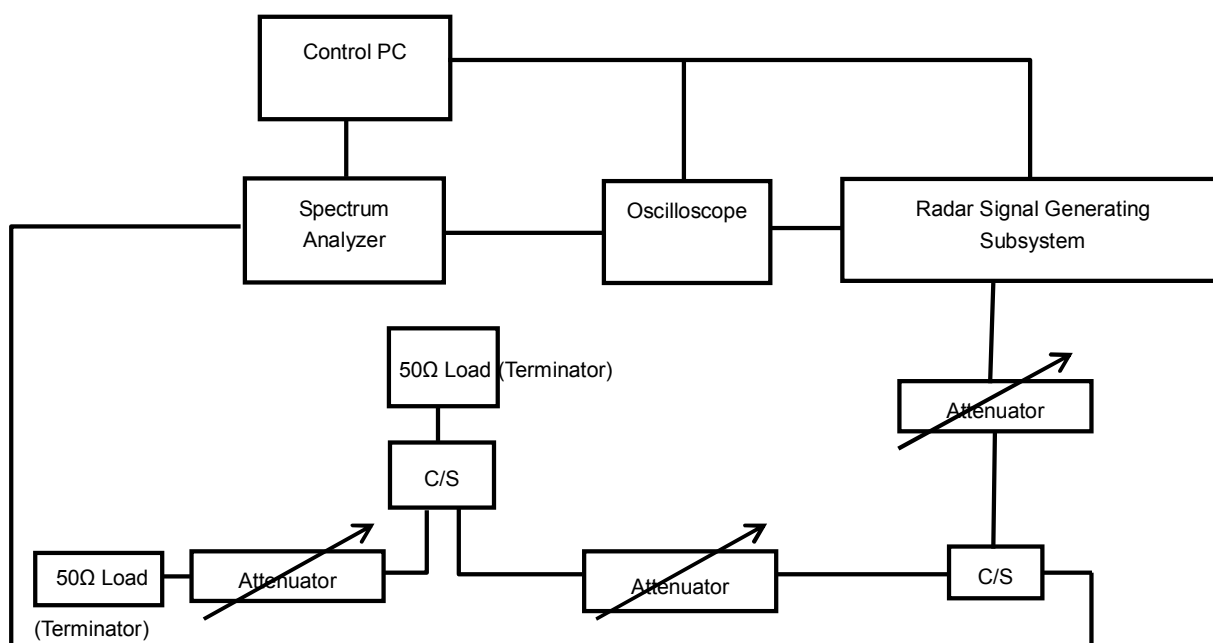

5.3 DEVIATION FROM TEST STANDARD

No deviation.

5.4 CONDUCTED TEST SETUP CONFIGURATION

5.4.1 CLIENT WITHOUT RADAR DETECTION MODE

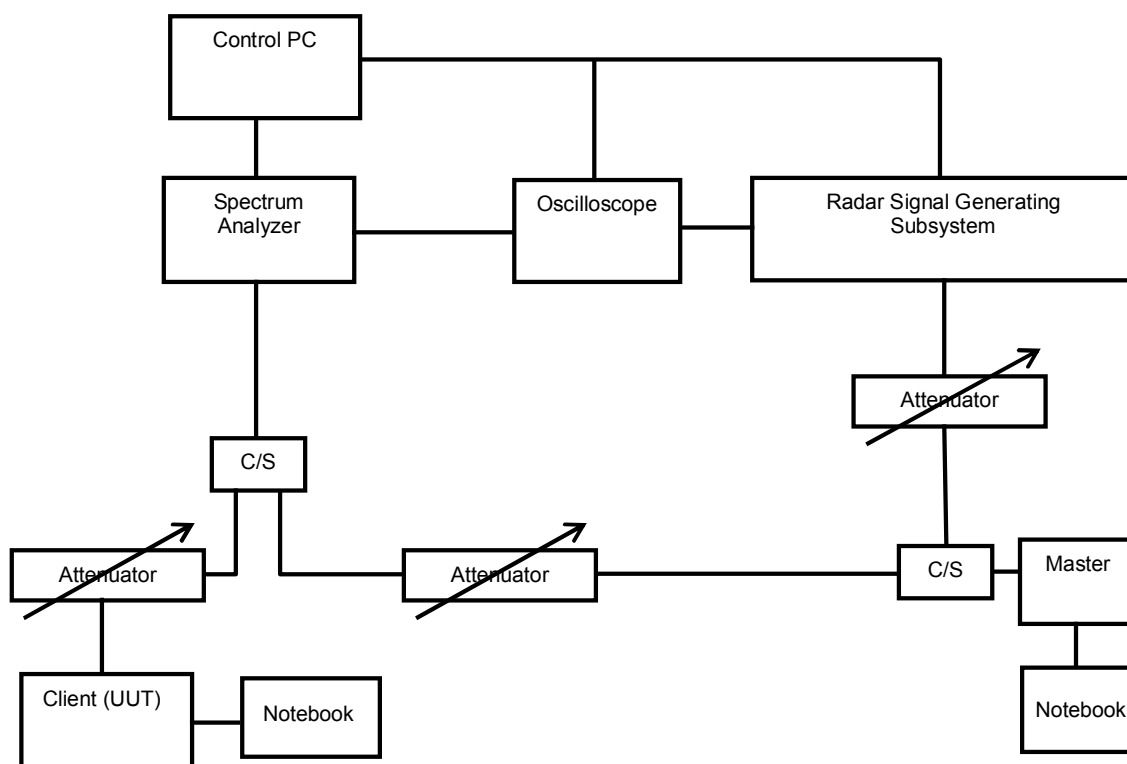

The UUT is a U-NII Device operating in Client mode without radar detection. The radar test signals are injected into the Master Device.

6. TEST RESULTS

6.1 SUMMARY OF TEST RESULT

Clause	Test Parameter	Remarks	Pass/Fail
15.407	DFS Detection Threshold	Not Applicable	NA
15.407	Channel Availability Check Time	Not Applicable	NA
15.407	Channel Move Time	Applicable	Pass
15.407	Channel Closing Transmission Time	Applicable	Pass
15.407	Non- Occupancy Period	Not Applicable	NA
15.407	Uniform Spreading	Not Applicable	NA
15.407	U-NII Detection Bandwidth	Not Applicable	NA

6.2 DETELED TEST RESULTS

6.2.1 TEST MODE: DEVICE OPERATING IN CLIENT WITHOUT RADAR DETECTION MODE.

The radar test signals are injected into the Master Device.

6.2.1.1 DFS DETECTION THRESHOLD

For a detection threshold level of -62dBm and the Master antenna gain is 3dBi . The Required detection threshold is -58dBm ($= -62 + 1 + 3$) dBm . The conducted radar burst level is set to -59dBm . The tested level is lower than required level hence it provides margin to the limit.

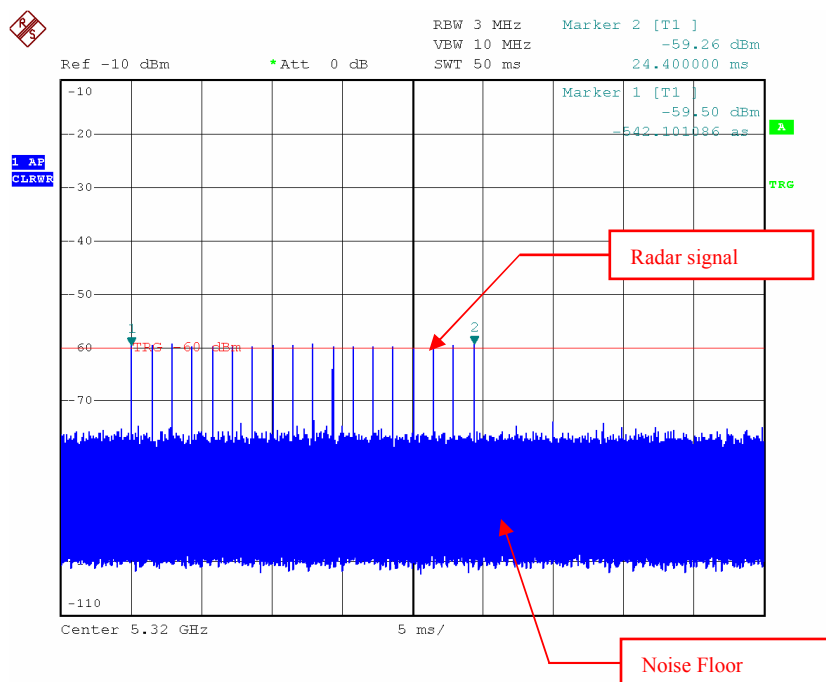

Date: 21.MAR.2007 02:15:56

Radar Signal 1

6.2.1.2 CHANNEL CLOSING TRANSMISSION AND CHANNEL MOVE TIME

WLAN Traffic

Duty Cycle @ CH064 - 5320MHz

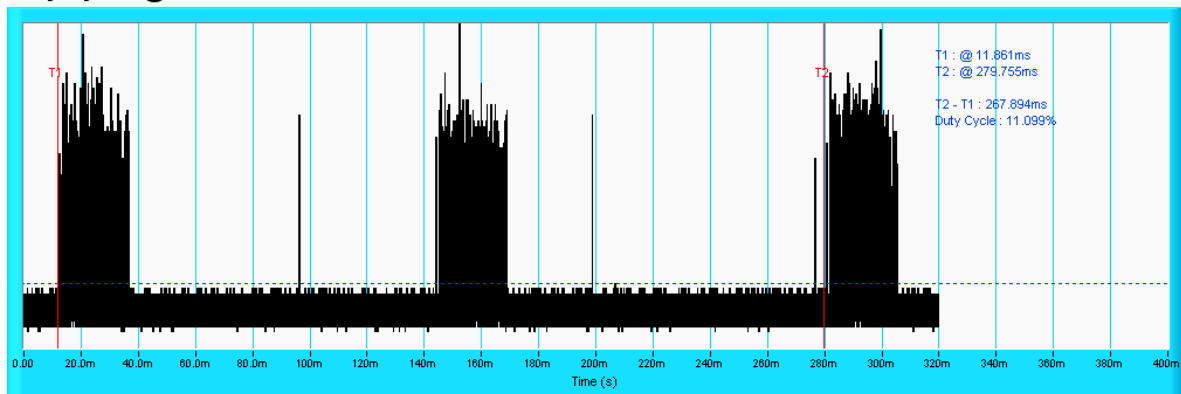

NOTE: T1 denotes the start of duty cycle period is 0.011861th second. T2 denotes the end of duty cycle period is 0.267894th second. T2 – T1= 0.267894 seconds. Duty Cycle = 11.099%

Radar signal 1

Channel Closing Transmission Time & Channel Move Time @ CH064 - 5320MHz

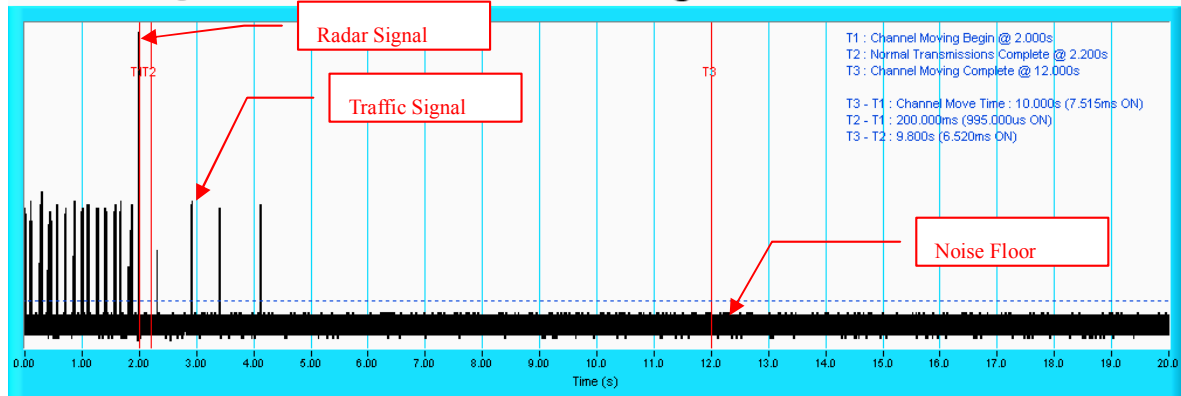

NOTE: T1 denotes the start of Channel Move Time upon the end of the last Radar burst. T2 denotes the data transmission time of 200ms from T1. T3 denotes the 10 second from T1 to observe the aggregate duration of transmissions.

Channel Closing Transmission Time & Channel Move Time @ CH064 - 5320MHz

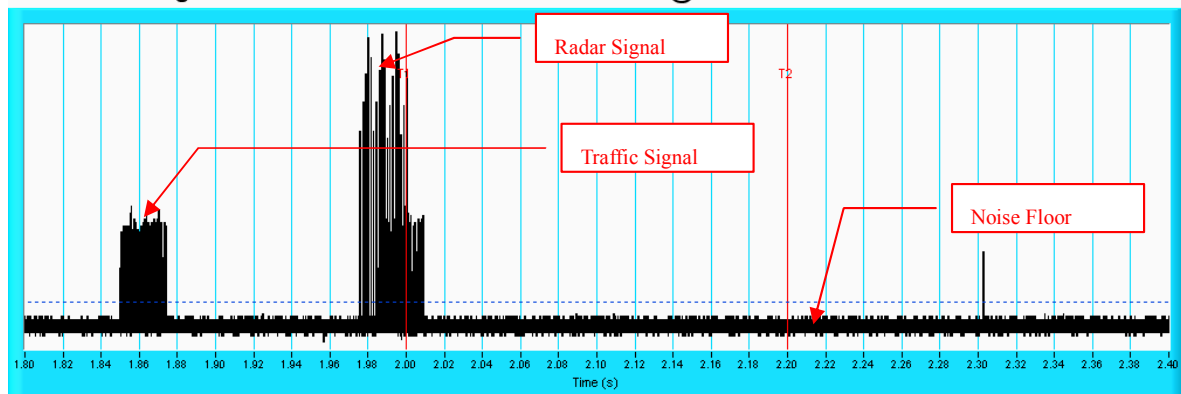

NOTE: An expanded plot for the device vacates the channel in the required 200ms.



Type 1 Radar Statistical Performances

Trial #	Pulses per Burst	Pulse Width (s)	PRI (s)	Detection
1	18	1.0u	1.428m	Yes
2	18	1.0u	1.428m	Yes
3	18	1.0u	1.428m	Yes
4	18	1.0u	1.428m	Yes
5	18	1.0u	1.428m	Yes
6	18	1.0u	1.428m	Yes
7	18	1.0u	1.428m	Yes
8	18	1.0u	1.428m	Yes
9	18	1.0u	1.428m	Yes
10	18	1.0u	1.428m	Yes
11	18	1.0u	1.428m	Yes
12	18	1.0u	1.428m	Yes
13	18	1.0u	1.428m	Yes
14	18	1.0u	1.428m	Yes
15	18	1.0u	1.428m	Yes
16	18	1.0u	1.428m	Yes
17	18	1.0u	1.428m	Yes
18	18	1.0u	1.428m	Yes
19	18	1.0u	1.428m	Yes
20	18	1.0u	1.428m	Yes
21	18	1.0u	1.428m	Yes
22	18	1.0u	1.428m	Yes
23	18	1.0u	1.428m	Yes
24	18	1.0u	1.428m	Yes
25	18	1.0u	1.428m	Yes
26	18	1.0u	1.428m	Yes
27	18	1.0u	1.428m	Yes
28	18	1.0u	1.428m	Yes
29	18	1.0u	1.428m	Yes
30	18	1.0u	1.428m	Yes

Detection Rate: 100 %



7. TESTING LABORATORIES INFORMATION

We, ADT Corp., were founded in 1988 to provide our best service in EMC, Radio, Telecom and Safety consultation. Our laboratories are accredited and approved by the following approval agencies according to ISO/IEC 17025.

USA	FCC, UL, A2LA
Germany	TUV Rheinland
Japan	VCCI
Norway	NEMKO
Canada	INDUSTRY CANADA , CSA
R.O.C.	TAF, BSMI, NCC
Netherlands	Telefication
Singapore	PSB , GOST-ASIA(MOU)
Russia	CERTIS(MOU)

Copies of accreditation certificates of our laboratories obtained from approval agencies can be downloaded from our web site:

www.adt.com.tw/index.5/phtml. If you have any comments, please feel free to contact us at the following:

Linko EMC/RF Lab:
Tel: 886-2-26052180
Fax: 886-2-26051924

Hsin Chu EMC/RF Lab:
Tel: 886-3-5935343
Fax: 886-3-5935342

Hwa Ya EMC/RF/Safety Telecom Lab:
Tel: 886-3-3183232
Fax: 886-3-3185050

Web Site: www.adt.com.tw

The address and road map of all our labs can be found in our web site also.



8. APPENDIX-A- MODIFICATIONS RECORDERS FOR ENGINEERING CHANGES TO THE EUT BY THE LAB

No any modifications are made to the EUT by the lab during the test.