



Test Report
for
FCC Part 15 Subpart B & C & E
(Part 1 for Dipole Antenna)

of

Product Name

WLAN 802.11a/b/g mini-PCI module (RoHS version)

Model

CM9); CM9-GP
(Brand: Wistron NeWeb)

Applied by:

Wistron Neweb Corporation
No. 10-1, Li-hsin Road 1,
Science-based Industrial Park, Hsinchu 300,
Taiwan, R. O. C.

Test Performed by:

International Standards Laboratory

No. 120, Lane 180, San Ho Tsuen, Hsin Ho Rd.
Lung-Tan Hsiang, Tao Yuan County 325
Taiwan, R.O.C.
Tel:(03)407-1718 Fax:(03)407-1738

Report Number: ISL-06LR009FC

Issue Date: 2006/04/12

HC LAB: NVLAP:200234-0; VCCI: R-341,C-354; NEMKO:ELA 113A; BSMI:SL2-IN-E-0037; SL2-R1-E-0037; CNLA:1178; IC:IC4067

LT LAB: NVLAP:200234-0; VCCI: R-1435,C-1440; NEMKO:ELA 113B; CNLA:0997; IC:IC4164-1

ISL-T10-R2-3

Contents of Report

- 1. General..... 1
 - 1.1 Certification of Accuracy of Test Data 1
- 2. Test Results Summary 2
- 3. Description of Equipment Under Test (EUT) 3
- 4. TEST RESULTS (802.11a) 6
 - 4.1 Maximum Peak Output Power [Section 15.407 (a)(1)(2)(3)] 6
 - 4.1.1 Test Procedure 6
 - 4.1.2 Test Setup 6
 - 4.1.3 Test Data: (Normal Mode) 6
 - 4.1.4 Test Data: (Turbo Mode) 6
 - 4.2 Peak Power Spectral Density [Section 15.407(a)(1)(2)(3)] 7
 - 4.2.1 Test Procedure 7
 - 4.2.2 Test Setup 7
 - 4.2.3 Test Data: (Normal Mode) 7
 - 4.2.4 Test Data: (Turbo Mode) 7
 - 4.3 Peak Power Excursion Measurement [Section 15.407(a)(6)] 8
 - 4.3.1 Test Procedure 8
 - 4.3.2 Test Setup 8
 - 4.3.3 Test Data: (Normal Mode) 8
 - 4.3.4 Test Data: (Turbo Mode) 8
 - 4.4 Powerline Conducted Emissions [Section 15.207 & 15.407 (b)(5)] 9
 - 4.4.1 EUT Configuration 9
 - 4.4.2 Test Procedure 9
 - 4.4.3 EMI Receiver/Spectrum Analyzer Configuration (for the frequencies tested) . 9
 - 4.4.4 Test Data: 10
 - 4.5 Radiated Emission Measurement [Section 15.209 & 15.407(b)(5)] 12
 - 4.5.1 EUT Configuration 12
 - 4.5.2 Test Procedure 12
 - 4.5.3 EMI Receiver/Spectrum Analyzer Configuration 12
 - 4.5.4 Test Data (30MHz – 1GHz) 13
 - 4.5.5 Test Data (1GHz – 40 GHz, Transmitting) 14
 - 4.6 Band Edge Measurement (Section 15.407 (b) (1) (2)) 26
 - 4.6.1 Test Procedure (Conducted) 26
 - 4.6.2 Test Setup (Conducted) 26
 - 4.6.3 Test Data (conducted): 27
 - 4.6.4 Bandedge Measurement Test Procedure (Radiated) 28
 - 4.6.5 Test Setup (Radiated) 29
 - 4.6.6 Test Data (Radiated): 30
 - 4.7 RF Exposure Measurement [Section 15.407(f)(4) & 1.1307(b)] 40
 - 4.8 Frequency Stability [Section 15.407(g)] 41
 - 4.8.1 Limits of Frequency Stability Measurement 41
 - 4.8.2 Test Procedure 41
 - 4.8.3 Test Setup 41



4.8.4 Test Data..... 42

5. TEST RESULTS (802.11b)..... 43

5.1 Powerline Conducted Emissions [Section 15.207] 43

5.1.1 EUT Configuration 43

5.1.2 Test Procedure 43

5.1.3 EMI Receiver/Spectrum Analyzer Configuration (for the frequencies tested) 43

5.1.4 Test Data:..... 44

5.2 Bandwidth for DSSS [Section 15.247 (a)(2)]..... 46

5.2.1 Test Procedure 46

5.2.2 Test Setup 46

5.2.3 Test Data:..... 46

5.3 DSSS Maximum Peak Output Power [Section 15.247 (b)(1)]..... 47

5.3.1 Test Procedure 47

5.3.2 Test Setup 47

5.3.3 Test Data..... 47

5.4 Radiated Emission Measurement [Section [15.247(c)(4)] 48

5.4.1 EUT Configuration 48

5.4.2 Test Procedure 48

5.4.3 EMI Receiver/Spectrum Analyzer Configuration (for the frequencies tested) 48

5.4.4 Test Data (30MHz – 1GHz): 49

5.4.5 Test Data (1GHz – 25 GHz) 50

5.5 Band Edge Measurement..... 53

5.5.1 Test Procedure (Conducted) 53

5.5.2 Test Setup (Conducted) 53

5.5.3 Test Data:..... 53

5.5.4 Test Procedure (Radiated) 54

5.5.5 Test Setup (Radiated)..... 54

5.5.6 Test Data 55

5.6 RF Exposure Measurement [Section 15.247(b)(4) & 1.1307(b)]..... 58

5.7 DSSS Peak Power Spectral Density [Section 15.247(d)]..... 59

5.7.1 Test Procedure 59

5.7.2 Test Setup 59

5.7.3 Test Data..... 59

6. TEST RESULTS (802.11g)..... 60

6.1 Powerline Conducted Emissions [Section 15.207] 60

6.1.1 EUT Configuration 60

6.1.2 Test Procedure 60

6.1.3 EMI Receiver/Spectrum Analyzer Configuration (for the frequencies tested) 60

6.1.4 Test Data:..... 61

6.2 Bandwidth for DSSS [Section 15.247 (a)(2)]..... 63

6.2.1 Test Procedure 63

6.2.2 Test Setup 63

6.2.3 Test Data:..... 63

6.3 DSSS Maximum Peak Output Power [Section 15.247 (b)(1)]..... 64

6.3.1 Test Procedure 64

6.3.2 Test Setup 64

6.3.3 Test Data..... 64

6.4	Radiated Emission Measurement [Section [15.247(c)(4)]	65
6.4.1	EUT Configuration	65
6.4.2	Test Procedure	65
6.4.3	EMI Receiver/Spectrum Analyzer Configuration (for the frequencies tested)	65
6.4.4	Test Data (30MHz – 1GHz):	66
6.4.5	Test Data (1GHz – 25 GHz)	67
6.5	Band Edge Measurement	70
6.5.1	Test Procedure (Conducted)	70
6.5.2	Test Setup (Conducted)	70
6.5.3	Test Data:	70
6.5.4	Test Procedure (Radiated)	71
6.5.5	Test Setup (Radiated)	71
6.5.6	Test Data	72
6.6	RF Exposure Measurement [Section 15.247(b)(4) & 1.1307(b)]	75
6.7	DSSS Peak Power Spectral Density [Section 15.247(d)]	76
6.7.1	Test Procedure	76
6.7.2	Test Setup	76
6.7.3	Test Data	76
7.	Appendix	77
7.1	Appendix A: Measurement Procedure for Power line Conducted Emissions	77
7.2	Appendix B: Test Procedure for Radiated Emissions	78
7.3	Appendix C: Test Equipment	79
7.3.1	Test Equipment List	79
7.3.2	Software for Controlling Spectrum/Receiver and Calculating Test Data	79
7.4	Appendix D: Layout of EUT and Support Equipment	80
7.4.1	General Conducted Test Configuration	80
7.4.2	General Radiation Test Configuration	81
7.5	Appendix E: Description of Support Equipment	82
7.5.1	Description of Support Equipment	82
7.5.2	Software for Controlling Support Unit	85
7.5.3	I/O Cable Condition of EUT and Support Units	86
7.6	Appendix F: Accuracy of Measurement	87
7.7	Appendix G: Photographs of EUT Configuration Test Set Up	89
7.8	Appendix H: Antenna Spec.	92



1. General

1.1 Certification of Accuracy of Test Data

Standards: CFR 47 Part 15 Subpart B Class B
 CFR 47 Part 15 Subpart C (Section 15.247)
 CFR 47 Part 15 Subpart E (Section 15.407)

Test Procedure: ANSI C63.4:2003

Equipment Tested: WLAN 802.11a/b/g mini-PCI module (RoHS version)

Model: CM9;CM9-GP

Applied by: Wistron Neweb Corporation

Sample received Date: 2006/03/21

Final test Date : 2006/04/03- 2006/04/12

Test Result PASS

Test Site: Chamber 02, Conduction 02

Temperature Refer to each site test data

Humidity: Refer to each site test data

Test Engineer:

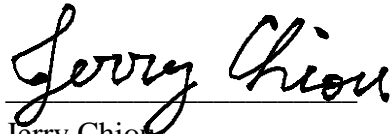
 Jerry Chiou

All the tests in this report have been performed and recorded in accordance with the standards described above and performed by an independent electromagnetic compatibility consultant, International Standards Laboratory.

The test results contained in this report accurately represent the measurements of the characteristics and the energy generated by sample equipment under test at the time of the test. The sample equipment tested as described in this report is in compliance with the limits of above standards.

Approve & Signature



 Eddy Hsiung/Director

Test results given in this report apply only to the specific sample(s) tested under stated test conditions. This report shall not be reproduced other than in full without the explicit written consent of ISL. This report totally contains 96 pages, including 1 cover page, 3 contents page, and 92 pages for the test description. This report must not be use to claim product endorsement by NVLAP or any agency of the U.S. Government.

This test data shown below is traceable to NIST or national or international standard. International Standards Laboratory certifies that no party to this application has been denied the FCC benefits pursuant to Section 5301 of the Anti-Drug Abuse Act of 1988, 21 U.S.C. 853(a).

2. Test Results Summary

The 802.11b functions of EUT has been tested according to the FCC regulations listed below:

Tested Standards: 47 CFR Part 15 Subpart C			
Standard Section	Test Type	Result	Remarks
15.207	AC Power Line Emissions	Pass	
15.247(a)(2)	Spectrum Bandwidth Of DSSS device	Pass	
15.247(b)	Max. Peak Output Power	Pass	
15.247(c)	Radiated Emissions 30MHz – 25 GHz	Pass	
15.247 (c)	Band Edge Measurement	Pass	
15.247(b)(4)	Radiation Exposure	Pass	MPE report attached
15.247 (d)	Power Spectral Density	Pass	

The 802.11g functions of EUT has been tested according to the FCC regulations listed below:

Tested Standards: 47 CFR Part 15 Subpart C			
Standard Section	Test Type	Result	Remarks
15.207	AC Power Line Emissions	Pass	
15.247(a)(2)	Spectrum Bandwidth Of DSSS device	Pass	
15.247(b)	Max. Peak Output Power	Pass	
15.247(c)	Radiated Emissions 30MHz – 25 GHz	Pass	
15.247 (c)	Band Edge Measurement	Pass	
15.247(b)(4)	Radiation Exposure	Pass	MPE report attached
15.247 (d)	Power Spectral Density	Pass	

The 802.11a functions of EUT has been tested to the FCC regulations listed below:

Tested Standards: 47 CFR Part 15 Subpart E			
Standard Section	Test Type	Result	Remarks
15.407 (a)(1)(2)(3)	Peak Transmit Power	Pass	
15.407 (a)(1)(2)(3)	Peak Power Spectral Density	Pass	
15.407 (a)(6)	Peak Power Excursion	Pass	
15.407 (b)(5)	AC Power Line Emissions	Pass	
15.407 (b)(5)	Radiated Emissions 30MHz – 40 GHz	Pass	
15.407(f)	Radiation exposure	Pass	MPE report attached
15.407 (g)	Frequency Stability	Pass	

3. Description of Equipment Under Test (EUT)

Description: WLAN 802.11a/b/g mini-PCI module (RoHS version)
Model No.: CM9 ; CM9GP
Brand: Wistron NeWeb
Frequency Range 802.11a: 5150~5350 MHz, 5725~5825 MHz
Frequency Range 802.11b/g: 2400~2483.5 MHz
Support channel:
802.11a Normal mode 12 Channels
802.11a Turbo mode 5 Channels
802.11b/g 11 Channels

Modulation Skill:
802.11a Normal mode OFDM (6 Mbps – 54 Mbps)
802.11a Turbo mode OFDM (12 Mbps – 108 MBps)
802.11b DBPSK(1Mbps), DQPSK(2Mbps),
CCK(5.5/11Mbps)
802.11g OFDM (6M - 54Mbps)

Antennas Type:

Antenna 1: Dipole (FCF-004 , made by Long-Chu Co.)
Antenna 2: Dipole (DBA-IPEX-01 , made by Long-Chu Co.)
Antenna 3: Dipole (SRSM5150MRA;SRSM2400MRA ,
made by CUSLICRAFT)
Antenna 4: Dipole (DBA-BSMA-01 , made by Wistron NeWeb)
Antenna 5: Dipole (DBA-SSMA-01, made by Wistron NeWeb)
Antenna 6: Dipole (DBA-IPEX-02 , made by Long-Chu Co.)
Antenna 7: Dipole (1770460-1 , made by TYCO)
Antenna 8: Printed (1770461-1 , made by TYCO)
Antenna 9: Printed (1770462-1 , made by TYCO)

Antenna Connected: The antenna is connected to the RF connector of the WLAN adapter.

Antenna peak Gain:

Antenna 1: 4.00 dBi (11b/g) ,3.50 dBi(11a)
Antenna 2: 1.89 dBi (11b/g) ,3.11 dBi(11a)
Antenna 3: 2.00 dBi (11b/g) ,2.00 dBi(11a)
Antenna 4: 2.00 dBi (11b/g) ,2.50 dBi(11a)
Antenna 5: 2.00 dBi (11b/g) ,2.50 dBi(11a)
Antenna 6: 2.91 dBi (11b/g) ,3.19 dBi(11a)
Antenna 7: 2.49 dBi (11b/g) ,3.64 dBi(11a)
Antenna 8: -1.6 dBi (11b/g) ,2.19 dBi(11a)
Antenna 9: 2.81 dBi (11b/g) ,1.19 dBi(11a)

WLAN Power Type : 3.3V DC from the EUT

The channel and the operation frequency of 802.11b and 802.11g is listed below:

Channel	Frequency(MHz)	Channel	Frequency(MHz)
01	2412	07	2442
02	2417	08	2447
03	2422	09	2452
04	2427	10	2457
05	2432	11	2462
06	2437		

The channel and the operation frequency of 802.11a Normal Mode is listed below:

Channel	Frequency(MHz)	Channel	Frequency(MHz)
01	5180	07	5300
02	5200	08	5320
03	5220	09	5745
04	5240	10	5765
05	5260	11	5785
06	5280	12	5805

The channel and the operation frequency of 802.11a Turbo Mode is listed below:

Channel	Frequency(MHz)	Channel	Frequency(MHz)
01	5210	04	5760
02	5250	05	5800
03	5290		

There are some differences from the original application:

A. Add one model, CM9-GP. It has some changes:

1. The components of WoW(Wake on wireless) circuit become nonpop..

(Remove Q11,Q12,Q9,R5,R10,R6,U7 ; Add : R9)

The RF performance remain the same after removing above components)

2. All IC switch to Rohs-compliant package. All the dies in the IC are the same.

B. Add new antennas for both CM9 and CM9-GP

Antenna List

No	Antenna Manufacturer	Antenna Model	Antenna Type	Antenna Connect	Antenna Gain	addition
1	TYCO	1770460-1	Dipole	IPX-MHF	2.49 dBi (2.4GHz)	Yes
					3.64 dBi(5GHz)	
2	TYCO	1770461-1	Printed	IPX-MHF	-1.6 dBi (2.4GHz)	Yes
					2.19 dBi(5GHz)	
3	TYCO	1770461-1	Printed	IPX-MHF	2.81 dBi (2.4GHz)	Yes
					1.19 dBi(5GHz)	

During the test, the EUT was tested as a modular device of a notebook PC using a PCMCIA extender board to extend the EUT outside the notebook PC enclosure.

There are nine antennas in the EUT:
The antenna 1,2,3,4,5,6,7 are Dipole type.
The antenna 8,9 are Printed type.

The antenna 1,2,3,4,5,6 (with CM9) has already been tested. Please refer to ISL report 04LR018FC.

All antennas (with CM9-GP) have been tested. The worse data of each antenna type are shown. Configuration list as below:

CM9-GP	Dipole Antenna	Printed Antenna
802.11a	Antenna 7	Antenna 8
802.11b/g	Antenna 1	Antenna 9

4. TEST RESULTS (802.11a)

4.1 Maximum Peak Output Power [Section 15.407 (a)(1)(2)(3)]

4.1.1 Test Procedure

The transmitter output of EUT was connected to the peak power analyzer.

4.1.2 Test Setup

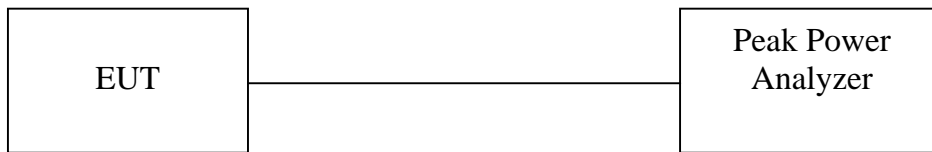

Frequency Band	Limit
5.15 – 5.25 GHz	The lesser of 50mW (17dBm) or 4dBm+10logB
5.25 – 5.35GHz	The lesser of 250mW (24dBm) or 11dBm+10logB
5.725-5.825GHz	The lesser of 1W (30dBm) or 17dBm+10logB

Note: B is the 26dB emission bandwidth in MHz

4.1.3 Test Data: (Normal Mode)

Please refer to ISL report 04LR018FC

4.1.4 Test Data: (Turbo Mode)

Please refer to ISL report 04LR018FC

4.2 Peak Power Spectral Density [Section 15.407(a)(1)(2)(3)]

4.2.1 Test Procedure

1. The Transmitter output of EUT was connected to the spectrum analyzer.
Equipment mode: Spectrum analyzer
Detector function: Peak mode
SPAN: 30MHz or 50MHz
RBW: 1MHz
VBW: 3MHz
Sweep time: 30 or 50 sec.
Center frequency: fundamental frequency tested
2. Peak search was read to the peak power after maximum hold function is completed.

4.2.2 Test Setup

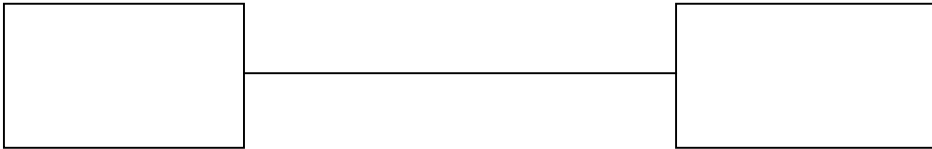

4.2.3 Test Data: (Normal Mode)

Please refer to ISL report 04LR018FC

4.2.4 Test Data: (Turbo Mode)

Please refer to ISL report 04LR018FC

4.3 Peak Power Excursion Measurement [Section 15.407(a)(6)]

4.3.1 Test Procedure

1. The Transmitter output of EUT was connected to the spectrum analyzer.
2. Frequency SPAN of Spectrum: 30MHz or 50MHz.
3. Trace 1 : RBW: 1MHz, VBW: 3MHz. Using positive detector and Max -hold
4. Trace 2 : RBW: 1MHz, VBW: 3MHz. Using Sample detector and Max-hold
5. Record the largest difference between Trace 1 and Trace 2.

4.3.2 Test Setup

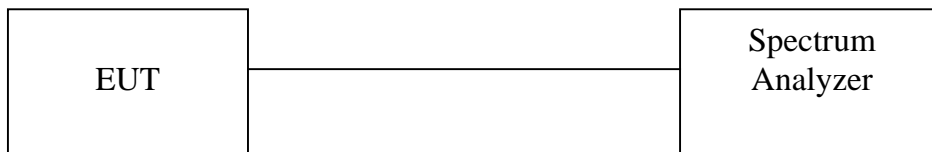

4.3.3 Test Data: (Normal Mode)

Please refer to ISL report 04LR018FC

4.3.4 Test Data: (Turbo Mode)

Please refer to ISL report 04LR018FC

4.4 Powerline Conducted Emissions [Section 15.207 & 15.407 (b)(5)]

4.4.1 EUT Configuration

The EUT was set up on the non-conductive table that is 1.0 by 1.5 meter, 80cm above ground. The wall of the shielded room was located 40cm to the rear of the EUT.

Power to the EUT was provided through the LISN. The impedance vs. frequency characteristic of the LISN is complied with the limit used.

Both lines (neutral and hot) were connected to the LISN in series at testing. A coaxial-type connector which provides one 50 ohms terminating impedance was provided for connecting the test instrument. The excess length of the power cord was folded back and forth at the center of the lead so as to form a bundle not exceeding 40cm in length.

Any changes made to the configuration, or modifications made to the EUT, during testing are noted in the following test record.

If the EUT is a Personal Computer or a peripheral of personal computer, and the personal computer has an auxiliary AC outlet which can be used for providing power to an external monitor, then all measurements will be made with the monitor power from first the computer-mounted AC outlet and then a floor-mounted AC outlet.

4.4.2 Test Procedure

The system was set up as described above, with the EMI diagnostic software running. The main power line conducted EMI tests were run on the hot and neutral conductors of the power cord and the results were recorded. The effect of varying the position of the interface cables has been investigated to find the configuration that produces maximum emission.

At the frequencies where the peak values of the emissions were higher than 6dB below the applicable limits, the emissions were also measured with the quasi-peak detectors. At the frequencies where the quasi-peak values of the emissions were higher than 6dB below the applicable average limits, the emissions were also measured with the average detectors.

The highest emissions were analyzed in details by operating the spectrum analyzer in fixed tuned mode to determine the nature of the emissions and to provide information which could be useful in reducing their amplitude.

4.4.3 EMI Receiver/Spectrum Analyzer Configuration (for the frequencies tested)

Frequency Range:	150 KHz--30MHz
Detector Function:	Quasi-Peak/Average
Bandwidth (RBW):	9KHz

4.4.4 Test Data:

Power Line Conducted Emissions (Hot)

Operator: Jerry Chiou
 Temperature (C): 22
 Humidity (%): 56

Frequency MHz	LISN Loss (dB)	Cable Loss (dB)	QP Corrcr. Amp.(dBuV)	QP Limit (dBuV)	QP Margin (dB)	AVE Corrcr. Amp.(dBuV)	AVE Limit (dBuV)	AVE Margin (dB)
0.53551	0.12	0.03	33.22	56.00	-22.78	30.90	46.00	-15.10
0.66915	0.14	0.04	33.12	56.00	-22.88	31.95	46.00	-14.05
0.73568	0.16	0.05	32.59	56.00	-23.41	29.86	46.00	-16.14
0.87393	0.18	0.06	32.63	56.00	-23.37	29.75	46.00	-16.25
13.6684	0.65	0.27	47.11	60.00	-12.89	41.91	50.00	-8.09
13.8672	0.66	0.27	47.59	60.00	-12.41	42.17	50.00	-7.83
14.135	0.67	0.28	47.48	60.00	-12.52	42.13	50.00	-7.87
14.1998	0.67	0.28	47.70	60.00	-12.30	42.30	50.00	-7.70
14.4688	0.68	0.29	46.39	60.00	-13.61	41.46	50.00	-8.54

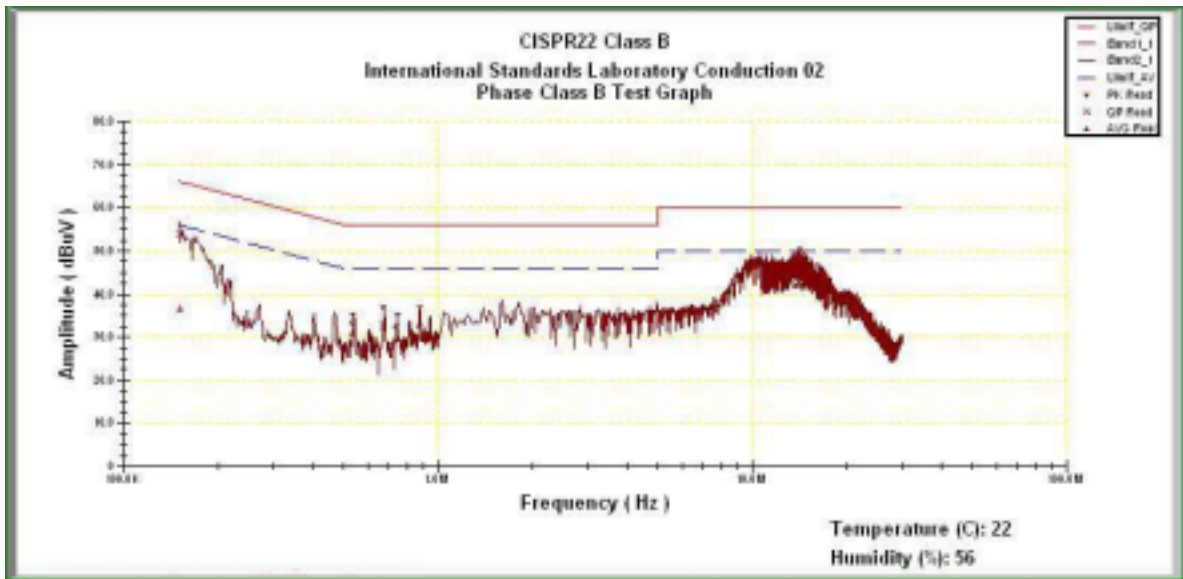

Power Line Conducted Emissions (Neutral)

Operator: Jerry Chiou
 Temperature (C): 22
 Humidity (%): 56

Frequency MHz	LISN Loss (dB)	Cable Loss (dB)	QP Corct. Amp.(dBuV)	QP Limit (dBuV)	QP Margin (dB)	AVE Corct. Amp.(dBuV)	AVE Limit (dBuV)	AVE Margin (dB)
0.24515	0.10	0.02	48.89	63.28	-14.39	28.78	53.28	-24.50
0.24625	0.10	0.02	47.46	63.25	-15.79	28.09	53.25	-25.16
0.26493	0.10	0.02	44.88	62.72	-17.84	33.61	52.72	-19.11
0.39818	0.10	0.02	38.72	58.91	-20.18	30.20	48.91	-18.70
17.9458	0.46	0.28	40.33	60.00	-19.67	35.98	50.00	-14.02
18.4834	0.47	0.27	41.39	60.00	-18.61	37.52	50.00	-12.48
18.6165	0.47	0.27	41.39	60.00	-18.61	37.48	50.00	-12.52
18.6831	0.47	0.27	41.38	60.00	-18.62	37.32	50.00	-12.68
19.1486	0.48	0.27	41.32	60.00	-18.68	36.52	50.00	-13.48

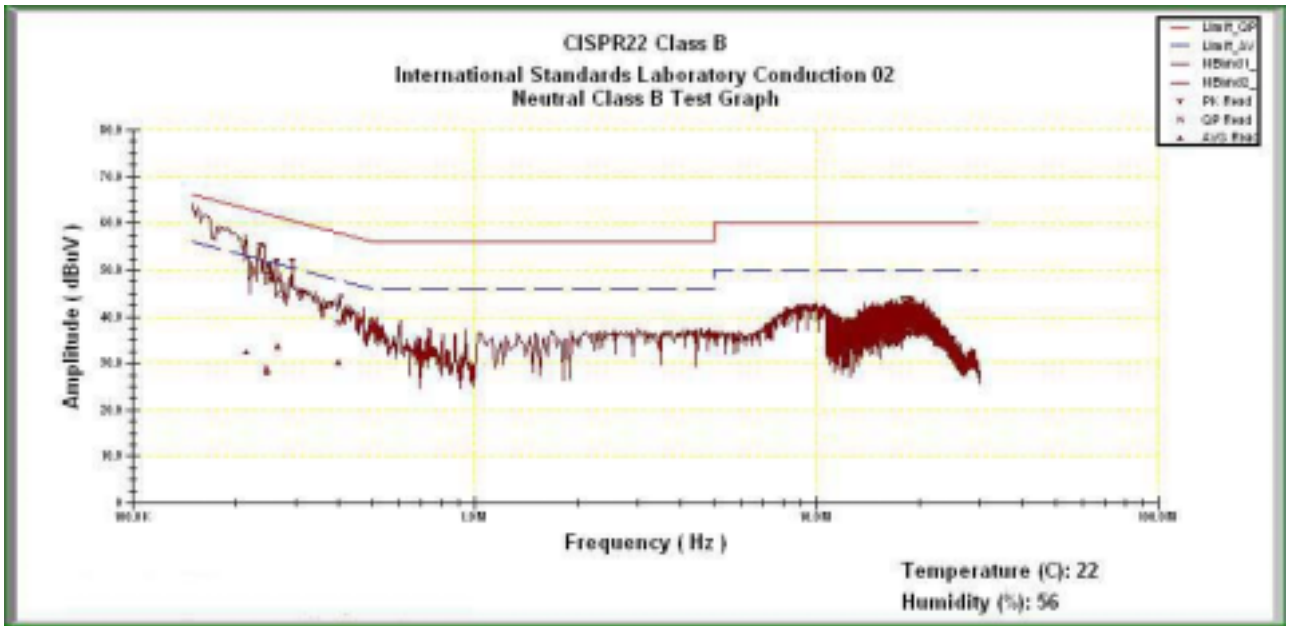

* NOTE: During the test, the EMI receiver was set to Max. Hold then switch the EUT between Main antenna, Aux antenna Channel 1, 4, 5, 8, 9, 12 of Normal Mode and Channel 1, 2, 3, 4, 5 of Turbo Mode to get the maximum reading of all these channels
 Margin = Amplitude + Insertion Loss - Limit
 A margin of -8dB means that the emission is 8dB below the limit

4.5 Radiated Emission Measurement [Section 15.209 & 15.407(b)(5)]

4.5.1 EUT Configuration

The equipment under test was set up on the 10 meter chamber with measurement distance of 3 meters. The EUT was placed on a non-conductive table 80cm above ground.

Any changes made to the configuration, or modifications made to the EUT, during testing are noted in the following test record.

4.5.2 Test Procedure

The system was set up as described above, with the EMI diagnostic software running. We found the maximum readings by varying the height of antenna and then rotating the turntable. Both polarization of antenna, horizontal and vertical, are measured.

30M to 1GHz: The highest emissions between 30 MHz to 1000 MHz were also analyzed in details by operating the spectrum analyzer and/or EMI receiver in quasi-peak mode to determine the precise amplitude of the emissions. While doing so, the interconnecting cables and major parts of the system were moved around, the antenna height was varied between one and four meters, its polarization was varied between vertical and horizontal, and the turntable was slowly rotated, to maximize the emission.

1GHz – 40GHz: The highest emissions were also analyzed in details by operating the spectrum analyzer and/or EMI receiver in peak mode to determine the precise amplitude of the emission. While doing so, the interconnecting cables and major parts of the system were moved around, the antenna height was varied between one and four meters, its polarization was varied between vertical and horizontal, and the turntable was slowly rotated, to maximize the emission. During test the EMI receiver and spectrum was setup according to para. 6.5.3.

For the test of 2nd to 10th harmonics frequencies , the equipment setup was also refer to para.6.5.3. The frequencies were tested using Peak mode first, if the test data is higher than the emissions limit, an additional measurement using Average mode will be performed and the average reading will be compared to the limit and record in test report.

4.5.3 EMI Receiver/Spectrum Analyzer Configuration

Frequency Range Tested:	30MHz~1000MHz
Detector Function:	Quasi-Peak Mode
Resolution Bandwidth (RBW):	120KHz
Video Bandwidth (VBW)	1MHz
Frequency Range Tested:	1GHz – 40 GHz
Detector Function:	Peak Mode
Resolution Bandwidth (RBW):	1MHz
Video Bandwidth (VBW)	3MHz
Frequency Range Tested:	30MHz – 40 GHz
Detector Function:	Average Mode
Resolution Bandwidth (RBW):	1MHz
Video Bandwidth (VBW)	10 Hz

4.5.4 Test Data (30MHz – 1GHz) .

30M – 1GHz Open Field Radiated Emissions (Horizontal)

Operator: Jerry Chiou

Humidity (%): 46
Temperature (C): 25

Frequency	Rx_R.	Ant_F.	Cab_L.	PreAmpl	Emission	Limit	Margin	A.Tower	T.Table
MHz	dBuV	dB/m	dB	dB	dBuV/m	dBuV/m	dB	cm	deg
99.84	22.05	10.27	3.02	0.00	35.33	43.50	-8.17	100.00	200.00
198.78	25.06	8.86	4.18	0.00	38.10	43.50	-5.40	100.00	7.00
232.73	27.45	9.33	4.50	0.00	41.28	46.00	-4.72	100.00	65.00
298.69	21.75	13.57	4.69	0.00	40.02	46.00	-5.98	100.00	237.00
398.6	21.52	15.95	5.31	0.00	42.79	46.00	-3.21	100.00	303.00
431.58	19.00	16.25	5.61	0.00	40.86	46.00	-5.14	100.00	237.00
464.56	15.20	16.78	5.87	0.00	37.85	46.00	-8.15	100.00	65.00
497.54	18.69	17.64	6.04	0.00	42.36	46.00	-3.64	100.00	254.00
563.5	13.17	19.05	6.56	0.00	38.78	46.00	-7.22	100.00	161.00
864.2	7.29	20.54	8.24	0.00	36.07	46.00	-9.93	100.00	181.00

30M – 1GHz Open Field Radiated Emissions (Vertical)

Operator: Jerry Chiou

Humidity (%): 46
Temperature (C): 25

Frequency	Rx_R.	Ant_F.	Cab_L.	PreAmpl	Emission	Limit	Margin	A.Tower	T.Table
MHz	dBuV	dB/m	dB	dB	dBuV/m	dBuV/m	dB	cm	deg
138.64	18.12	10.54	3.55	0.00	32.21	43.50	-11.29	100.00	330.00
231.76	21.00	9.21	4.48	0.00	34.70	46.00	-11.30	100.00	223.00
364.65	14.87	14.80	5.07	0.00	34.73	46.00	-11.27	100.00	223.00
431.58	13.17	16.25	5.61	0.00	35.03	46.00	-10.97	100.00	260.00
497.54	13.12	17.64	6.04	0.00	36.80	46.00	-9.20	100.00	346.00
643.04	8.42	19.07	7.00	0.00	34.50	46.00	-11.50	100.00	280.00
651.77	14.02	19.10	7.04	0.00	40.16	46.00	-5.84	100.00	297.00
661.47	9.30	19.08	7.07	0.00	35.45	46.00	-10.55	100.00	297.00
815.7	8.72	20.19	7.93	0.00	36.83	46.00	-9.17	100.00	96.00
866.14	6.48	20.54	8.26	0.00	35.28	46.00	-10.72	100.00	41.00

* NOTE: During the pre-test, the EUT has been tested for Channel 1, 4, 5, 8, 9, 12 of Normal Mode and Channel 1, 2, 3, 4, 5 of Turbo mode and transmit from Main and Aux antenna respectively to get all the critical emission frequencies. In the final test all the critical emission frequencies has been tested and the test data are listed above.

Margin=Corrected Amplitude-Limit

Corrected Amplitude = Radiated Amplitude + Antenna Correction Factor + Cable Loss - Pre-Amplifier Gain

A margin of -8dB means that the emission is 8dB below the limit

All frequencies from 30MHz to 1GHz have been tested

4.5.5 Test Data (1GHz – 40 GHz, Transmitting) .

1GHz~ 40 GHz (Horizontal), Normal Mode, Channel 1: 5180 MHz

Operator: Jerry Chiou

RBW: 1MHz
Humidity (%): 36
Temperature (C): 24

Frequency	Rx_R.	Ant_F.	Cab_L.	PreAmpl	Emission	Limit	Margin	A.Tower	T.Table
MHz	dBuV	dB/m	dB	dB	dBuV/m	dBuV/m	dB	cm	deg
4807	56.88 pk	34.86	2.12	37.70	56.17 pk	74.00 pk	-17.83	100	20
4807	44.09 av	34.86	2.12	37.70	56.17 av	54.00 av	-10.62	100	20

1GHz~ 40 GHz (Vertical), Normal Mode, Channel 1: 5180 MHz

Operator: Jerry Chiou

RBW: 1MHz
Humidity (%): 36
Temperature (C): 24

Frequency	Rx_R.	Ant_F.	Cab_L.	PreAmpl	Emission	Limit	Margin	A.Tower	T.Table
MHz	dBuV	dB/m	dB	dB	dBuV/m	dBuV/m	dB	cm	deg
3453.33	60.88 pk	31.46	1.68	35.72	58.29 pk	74.00 pk	-15.71	103	242
3453.33	54.52 av	31.46	1.68	35.72	58.29 av	54.00 av	-2.07	103	242
4814.39	65.92 pk	34.80	2.12	37.68	65.16 pk	54.00 pk	-8.84	100	21
4814.39	53.52 av	34.80	2.12	37.68	65.16 av	54.00 av	-1.24	100	21

Note: “*” : Fundamental Frequency

“pk”: peak reading

“av”: average reading

The Spectrum noise level+Correction Factor<Limit-6 dB

Margin = Corrected Amplitude – Limit

Corrected Amplitude=Radiated Amplitude+Antenna Correction Factor+Cable Loss-Pre-Amplifier Gain

A margin of -8dB means that the emission is 8dB below the limit.

All frequencies from 1GHz to 40 GHz have been tested.

1GHz~ 40 GHz (Horizontal), Normal Mode, Channel 4: 5240 MHz

Operator: Jerry Chiou

RBW: 1MHz
 Humidity (%): 36
 Temperature (C): 24

Frequency	Rx_R.	Ant_F.	Cab_L.	PreAmpl	Emission	Limit	Margin	A.Tower	T.Table
MHz	dBuV	dB/m	dB	dB	dBuV/m	dBuV/m	dB	cm	deg
4809.78	56.48 pk	34.89	2.12	37.70	55.78 pk	74.00 pk	-18.22	100	19
4809.78	44.09 av	34.89	2.12	37.70	55.78 av	54.00 av	-10.61	100	19

1GHz~ 40 GHz (Vertical), Normal Mode, Channel 4: 5240 MHz

Operator: Jerry Chiou

RBW: 1MHz
 Humidity (%): 36
 Temperature (C): 24

Frequency	Rx_R.	Ant_F.	Cab_L.	PreAmpl	Emission	Limit	Margin	A.Tower	T.Table
MHz	dBuV	dB/m	dB	dB	dBuV/m	dBuV/m	dB	cm	deg
3485.12	61.16 pk	31.49	1.70	35.82	58.54 pk	74.00 pk	-15.46	103	231
3485.12	54.16 av	31.49	1.70	35.82	58.54 av	54.00 av	-2.64	103	231
4819.97	65.43 pk	34.86	2.12	37.70	64.71 pk	74.00 pk	-9.29	100	20
4819.97	51.70 av	34.86	2.12	37.70	64.71 av	54.00 av	-3.02	100	20

Note: “ * ”: Fundamental Frequency

“ pk ”: peak reading

“ av ”: average reading

The Spectrum noise level+Correction Factor<Limit-6 dB

Margin = Corrected Amplitude – Limit

Corrected Amplitude=Radiated Amplitude+Antenna Correction Factor+Cable Loss-Pre-Amplifier Gain

A margin of -8dB means that the emission is 8dB below the limit.

All frequencies from 1GHz to 40 GHz have been tested.

1GHz~ 40 GHz (Horizontal), Normal Mode, Channel 5: 5260 MHz

Operator: Jerry Chiou

RBW: 1MHz
Humidity (%): 36
Temperature (C): 24

Frequency	Rx_R.	Ant_F.	Cab_L.	PreAmpl	Emission	Limit	Margin	A.Tower	T.Table
MHz	dBuV	dB/m	dB	dB	dBuV/m	dBuV/m	dB	cm	deg
4817.82	56.12 pk	34.89	2.12	37.70	55.42 pk	74.00 pk	-18.58	100	19
4817.82	43.92 av	34.89	2.12	37.70	55.42 av	54.00 av	-10.78	100	19

1GHz~ 40 GHz (Vertical), Normal Mode, Channel 5: 5260 MHz

Operator: Jerry Chiou

RBW: 1MHz
Humidity (%): 36
Temperature (C): 24

Frequency	Rx_R.	Ant_F.	Cab_L.	PreAmpl	Emission	Limit	Margin	A.Tower	T.Table
MHz	dBuV	dB/m	dB	dB	dBuV/m	dBuV/m	dB	cm	deg
3503.1	56.84 pk	31.50	1.71	35.85	54.20 pk	74.00 pk	-19.8	102	228
3503.1	50.57 av	31.50	1.71	35.85	54.20 av	54.00 av	-6.07	102	228
4811.51	65.64 pk	34.91	2.12	37.71	64.97 pk	74.00 pk	-9.03	100	18
4811.51	52.83 av	34.91	2.12	37.71	64.97 av	54.00 av	-1.84	100	18
15780	42.34 pk	42.42	3.88	34.95	53.68 pk	54.00 av	-0.32	102	150

Note: “*” : Fundamental Frequency
 “pk”: peak reading
 “av”: average reading
 The Spectrum noise level+Correction Factor<Limit-6 dB
 Margin = Corrected Amplitude – Limit
 Corrected Amplitude=Radiated Amplitude+Antenna Correction Factor+Cable Loss-Pre-Amplifier Gain
 A margin of -8dB means that the emission is 8dB below the limit.

All frequencies from 1GHz to 40 GHz have been tested.

1GHz~ 40 GHz (Horizontal), Normal Mode, Channel 8: 5320 MHz

Operator: Jerry Chiou

RBW: 1MHz
 Humidity (%): 36
 Temperature (C): 24

Frequency	Rx_R.	Ant_F.	Cab_L.	PreAmpl	Emission	Limit	Margin	A.Tower	T.Table
MHz	dBuV	dB/m	dB	dB	dBuV/m	dBuV/m	dB	cm	deg
1796.7	60.80 pk	29.29	2.45	34.78	57.76 pk	74.00 pk	-16.24	100	57
1796.7	47.56 av	29.29	2.45	34.78	44.52 av	54.00 av	-9.48	100	57
4817	57.50 pk	34.86	2.12	37.70	56.78 pk	74.00 pk	-17.22	100	20
4817	43.50 av	34.86	2.12	37.70	42.78 av	54.00 av	-11.22	100	20

1GHz~ 40 GHz (Vertical), Normal Mode, Channel 8: 5320 MHz

Operator: Jerry Chiou

RBW: 1MHz
 Humidity (%): 36
 Temperature (C): 24

Frequency	Rx_R.	Ant_F.	Cab_L.	PreAmpl	Emission	Limit	Margin	A.Tower	T.Table
MHz	dBuV	dB/m	dB	dB	dBuV/m	dBuV/m	dB	cm	deg
1704.9	59.06 pk	28.52	2.38	34.60	55.36 pk	74.00 pk	-18.64	101	63
1704.9	45.82 av	28.52	2.38	34.60	42.12 av	54.00 av	-11.88	101	63
2035.76	56.69 pk	30.99	2.49	35.18	54.99 pk	74.00 pk	-19.01	100	54
2035.76	43.45 av	30.99	2.49	35.18	41.75 av	54.00 av	-12.25	100	54
4811	66.91 pk	34.86	2.12	37.70	66.19 pk	74.00 pk	-7.81	100	20
4811	53.66 av	34.86	2.12	37.70	52.94 av	54.00 av	-1.06	100	20
7085.11	49.40 pk	39.24	2.95	37.10	54.49 pk	74.00 pk	-19.51	101	121
7085.11	38.34 av	39.24	2.95	37.10	43.43 av	54.00 av	-10.57	101	121
15953.8	41.13 pk	42.88	3.98	34.09	53.90 pk	54.00 av	-0.10	102	184

Note: “*” : Fundamental Frequency

“pk”: peak reading

“av”: average reading

The Spectrum noise level+Correction Factor<Limit-6 dB

Margin = Corrected Amplitude – Limit

Corrected Amplitude=Radiated Amplitude+Antenna Correction Factor+Cable Loss-Pre-Amplifier Gain

A margin of -8dB means that the emission is 8dB below the limit.

All frequencies from 1GHz to 40 GHz have been tested.

1GHz~ 40 GHz (Horizontal), Normal Mode Channel 9: 5745 MHz

Operator: Jerry Chiou

RBW: 1MHz
Humidity (%): 36
Temperature (C): 24

Frequency MHz	Rx_R. dBuV	Ant_F. dB/m	Cab_L. dB	PreAmpl dB	Emission dBuV/m	Limit dBuV/m	Margin dB	A.Tower cm	T.Table deg
1409.99	61.61 pk	26.39	2.22	34.15	56.06 pk	74.00 pk	-17.94	101	84
1409.99	49.03 av	26.39	2.22	34.15	43.48 av	54.00 av	-10.52	101	84
1467.53	73.04 pk	26.65	2.23	34.18	67.73 pk	74.00 pk	-6.27	101	80
1467.53	55.35 av	26.65	2.23	34.18	50.04 av	54.00 av	-3.96	101	80
1791.71	60.57 pk	29.25	2.45	34.77	57.49 pk	74.00 pk	-16.51	100	57
1791.71	47.33 av	29.25	2.45	34.77	44.25 av	54.00 av	-9.75	100	57
11489.5	44.91 pk	40.67	3.08	34.87	53.79 pk	54.00 av	-0.21	101	161

1GHz~ 40 GHz (Vertical) Normal Mode, Channel 9: 5745 MHz

Operator: Jerry Chiou

RBW: 1MHz
Humidity (%): 36
Temperature (C): 24

Frequency MHz	Rx_R. dBuV	Ant_F. dB/m	Cab_L. dB	PreAmpl dB	Emission dBuV/m	Limit dBuV/m	Margin dB	A.Tower cm	T.Table deg
1791.21	58.22 pk	29.25	2.45	34.77	55.14 pk	74.00 pk	-18.86	100	57
1791.21	45.86 av	29.25	2.45	34.77	42.78 av	54.00 av	-11.22	100	57
3819.77	62.48 pk	31.96	1.97	36.83	59.57 pk	74.00 pk	-14.43	102	145
3819.77	55.77 av	31.96	1.97	36.83	52.86 av	54.00 av	-1.14	102	145
4820.19	65.91 pk	34.89	2.12	37.70	65.21 pk	74.00 pk	-8.79	100	19
4820.19	52.47 av	34.89	2.12	37.70	51.77 av	54.00 av	-2.23	100	19
11487.7	47.93 pk	40.65	3.08	34.86	56.80 pk	74.00 pk	-17.2	101	162
11487.7	36.30 av	40.65	3.08	34.86	45.17 av	54.00 av	-8.83	101	162
17226.6	37.21 pk	45.20	3.44	32.14	53.71 pk	54.00 av	-0.29	100	275

Note: “ * ”: Fundamental Frequency

“ pk ”: peak reading

“ av ”: average reading

The Spectrum noise level+Correction Factor<Limit-6 dB

Margin = Corrected Amplitude – Limit

Corrected Amplitude=Radiated Amplitude+Antenna Correction Factor+Cable Loss-Pre-Amplifier Gain

A margin of -8dB means that the emission is 8dB below the limit.

All frequencies from 1GHz to 40 GHz have been tested.

1GHz~ 40 GHz (Horizontal), Normal Mode Channel 10: 5765 MHz

Operator: Jerry Chiou

RBW: 1MHz
Humidity (%): 36
Temperature (C): 24

Frequency	Rx_R.	Ant_F.	Cab_L.	PreAmpl	Emission	Limit	Margin	A.Tower	T.Table
MHz	dBuV	dB/m	dB	dB	dBuV/m	dBuV/m	dB	cm	deg
1388.41	60.33 pk	26.29	2.22	34.14	54.69 pk	74.00 pk	-19.31	101	85
1388.41	45.55 av	26.29	2.22	34.14	39.91 av	54.00 av	-14.09	101	85
1791.71	60.57 pk	29.25	2.45	34.77	57.49 pk	74.00 pk	-16.51	100	57
1791.71	47.33 av	29.25	2.45	34.77	44.25 av	54.00 av	-9.75	100	57
4823	54.78 pk	34.86	2.12	37.70	54.06 pk	74.00 pk	-19.94	100	20
4823	41.29 av	34.86	2.12	37.70	40.57 av	54.00 av	-13.43	100	20

1GHz~ 40 GHz (Vertical) Normal Mode, Channel 10: 5765 MHz

Operator: Jerry Chiou

RBW: 1MHz
Humidity (%): 36
Temperature (C): 24

Frequency	Rx_R.	Ant_F.	Cab_L.	PreAmpl	Emission	Limit	Margin	A.Tower	T.Table
MHz	dBuV	dB/m	dB	dB	dBuV/m	dBuV/m	dB	cm	deg
1409.99	60.95 pk	26.39	2.22	34.15	55.41 pk	74.00 pk	-18.59	101	84
1409.99	49.43 av	26.39	2.22	34.15	43.89 av	54.00 av	-10.11	101	84
1791.21	58.75 pk	29.25	2.45	34.77	55.67 pk	74.00 pk	-18.33	100	57
1791.21	45.43 av	29.25	2.45	34.77	42.6 av	54.00 av	-11.4	100	57
3835.73	62.98 pk	31.98	1.98	36.88	60.07 pk	74.00 pk	-15.93	102	141
3835.73	55.64 av	31.98	1.98	36.88	52.73 av	54.00 av	-1.27	102	141
4806.88	65.06 pk	34.91	2.12	37.71	64.39 pk	74.00 pk	-9.61	100	18
4806.88	53.22 av	34.91	2.12	37.71	52.55 av	54.00 av	-1.45	100	18
11529.1	48.16 pk	40.76	3.09	34.89	57.13 pk	74.00 pk	-16.87	101	156
11529.1	32.94 av	40.76	3.09	34.89	41.91 av	54.00 av	-12.09	101	156
17285.3	36.09 pk	45.33	3.39	32.22	52.60 pk	54.00 av	-1.40	101	269

Note: “ * ”: Fundamental Frequency

“ pk ”: peak reading

“ av ”: average reading

The Spectrum noise level+Correction Factor<Limit-6 dB

Margin = Corrected Amplitude – Limit

Corrected Amplitude=Radiated Amplitude+Antenna Correction Factor+Cable Loss-Pre-Amplifier Gain

A margin of -8dB means that the emission is 8dB below the limit.

All frequencies from 1GHz to 40 GHz have been tested.

1GHz~ 40 GHz (Horizontal), Normal Mode, Channel 12: 5805 MHz

Operator: Jerry Chiou

RBW: 1MHz
 Humidity (%): 36
 Temperature (C): 24

Frequency	Rx_R.	Ant_F.	Cab_L.	PreAmpl	Emission	Limit	Margin	A.Tower	T.Table
MHz	dBuV	dB/m	dB	dB	dBuV/m	dBuV/m	dB	cm	deg
1791.71	60.57 pk	29.25	2.45	34.77	57.49 pk	74.00 pk	-16.51	100	57
1791.71	47.33 av	29.25	2.45	34.77	44.25 av	54.00 av	-9.75	100	57
3862.74	56.13 pk	32.01	2.00	36.94	53.19 pk	54.00 av	-0.81	102	135
4802.23	55.82 pk	34.89	2.12	37.70	55.12 pk	74.00 pk	-18.88	100	19
4802.23	44.24 av	34.89	2.12	37.70	43.54 av	54.00 av	-10.46	100	19
11607	43.84 pk	41.04	3.19	34.97	53.11 pk	54.00 av	-0.89	101	143

1GHz~ 40 GHz (Vertical), Normal Mode, Channel 12: 5805 MHz

Operator: Jerry Chiou

RBW: 1MHz
 Humidity (%): 36
 Temperature (C): 24

Frequency	Rx_R.	Ant_F.	Cab_L.	PreAmpl	Emission	Limit	Margin	A.Tower	T.Table
MHz	dBuV	dB/m	dB	dB	dBuV/m	dBuV/m	dB	cm	deg
3869.28	63.45 pk	32.01	2.00	36.94	60.52 pk	74.00 pk	-15.48	102	135
3869.28	55.92 av	32.01	2.00	36.94	52.99 av	54.00 av	-1.01	102	135
4801.77	67.24 pk	34.89	2.12	37.70	66.55 pk	74.00 pk	-7.45	100	19
4801.77	53.23 av	34.89	2.12	37.70	52.54 av	54.00 av	-1.46	100	19
5382.28	55.19 pk	35.90	2.82	37.91	56.00 pk	74.00 pk	-18.00	100	109
5382.28	42.11 av	35.90	2.82	37.91	42.92 av	54.00 av	-11.08	100	109
11609.9	49.37 pk	41.01	3.18	34.96	58.60 pk	74.00 pk	-15.4	101	145
11609.9	35.41 av	41.01	3.18	34.96	44.64 av	54.00 av	-9.36	101	145

Note: “*” : Fundamental Frequency

“pk”: peak reading

“av”: average reading

The Spectrum noise level+Correction Factor<Limit-6 dB

Margin = Corrected Amplitude – Limit

Corrected Amplitude=Radiated Amplitude+Antenna Correction Factor+Cable Loss-Pre-Amplifier Gain

A margin of -8dB means that the emission is 8dB below the limit.

All frequencies from 1GHz to 40 GHz have been tested.

1GHz~ 40 GHz (Horizontal), Turbo Mode, Channel 1: 5210 MHz

Operator: Jerry Chiou

RBW: 1MHz
 Humidity (%): 36
 Temperature (C): 24

Frequency	Rx_R.	Ant_F.	Cab_L.	PreAmpl	Emission	Limit	Margin	A.Tower	T.Table
MHz	dBuV	dB/m	dB	dB	dBuV/m	dBuV/m	dB	cm	deg
4805.0	56.01 pk	34.86	2.12	37.70	55.29 pk	74.00 pk	-18.71	100	20
4807.11	42.64 av	34.86	2.12	37.70	55.29 av	54.00 av	-12.08	100	20

1GHz~ 40 GHz (Vertical), Turbo Mode, Channel 1: 5210 MHz

Operator: Jerry Chiou

RBW: 1MHz
 Humidity (%): 36
 Temperature (C): 24

Frequency	Rx_R.	Ant_F.	Cab_L.	PreAmpl	Emission	Limit	Margin	A.Tower	T.Table
MHz	dBuV	dB/m	dB	dB	dBuV/m	dBuV/m	dB	cm	deg
3467.13	58.89 pk	31.47	1.69	35.77	56.29 pk	74.00 pk	-17.71	103	237
3471.82	53.38 av	31.47	1.69	35.77	56.29 av	54.00 av	-3.02	103	237
4805	65.63 pk	34.86	2.12	37.70	64.91 pk	74.00 pk	-9.09	100	20
4805	52.19 av	34.86	2.12	37.70	64.91 av	54.00 av	-2.53	100	20

Note: “ * ”: Fundamental Frequency

“ pk ”: peak reading

“ av ”: average reading

The Spectrum noise level+Correction Factor<Limit-6 dB

Margin = Corrected Amplitude – Limit

Corrected Amplitude=Radiated Amplitude+Antenna Correction Factor+Cable Loss-Pre-Amplifier Gain

A margin of -8dB means that the emission is 8dB below the limit.

All frequencies from 1GHz to 40 GHz have been tested.

1GHz~ 40 GHz (Horizontal), Turbo Mode, Channel 2: 5250 MHZ

Operator: Jerry Chiou

RBW: 1MHz
 Humidity (%): 36
 Temperature (C): 24

Frequency	Rx_R.	Ant_F.	Cab_L.	PreAmpl	Emission	Limit	Margin	A.Tower	T.Table
MHz	dBuV	dB/m	dB	dB	dBuV/m	dBuV/m	dB	cm	deg
4797.8	56.17 pk	34.83	2.12	37.69	55.43 pk	74.00 pk	-18.57	100	20
4786.4	44.22 av	34.83	2.12	37.69	55.43 av	54.00 av	-10.52	100	20

1GHz~ 40 GHz (Vertical), Turbo Mode, Channel 2: 5250 MHZ

Operator: Jerry Chiou

RBW: 1MHz
 Humidity (%): 36
 Temperature (C): 24

Frequency	Rx_R.	Ant_F.	Cab_L.	PreAmpl	Emission	Limit	Margin	A.Tower	T.Table
MHz	dBuV	dB/m	dB	dB	dBuV/m	dBuV/m	dB	cm	deg
3495.9	57.17 pk	31.50	1.71	35.83	54.55 pk	74.00 pk	-19.45	103	230
3489.9	50.74 av	31.50	1.71	35.83	54.55 av	54.00 av	-5.88	103	230
4812.19	64.61 pk	34.89	2.12	37.70	63.91 pk	74.00 pk	-10.09	100	19
4815.03	51.25 av	34.89	2.12	37.70	63.91 av	54.00 av	-3.45	100	19

Note: “ * ”: Fundamental Frequency

“ pk ”: peak reading

“ av ”: average reading

The Spectrum noise level+Correction Factor<Limit-6 dB

Margin = Corrected Amplitude – Limit

Corrected Amplitude=Radiated Amplitude+Antenna Correction Factor+Cable Loss-Pre-Amplifier Gain

A margin of -8dB means that the emission is 8dB below the limit.

All frequencies from 1GHz to 40 GHz have been tested.

1GHz~ 40 GHz (Horizontal), Turbo Mode, Channel 3: 5290 MHz

Operator: Jerry Chiou

RBW: 1MHz
 Humidity (%): 36
 Temperature (C): 24

Frequency MHz	Rx_R. dBuV	Ant_F. dB/m	Cab_L. dB	PreAmpl dB	Emission dBuV/m	Limit dBuV/m	Margin dB	A.Tower cm	T.Table deg
1467.53	60.91 pk	26.65	2.23	34.18	55.60 pk	74.00 pk	-18.4	101	80
1467.53	47.67 av	26.65	2.23	34.18	42.20 av	54.00 av	-11.8	101	80
1791.71	60.57 pk	29.25	2.45	34.77	57.49 pk	74.00 pk	-16.51	100	57
1791.71	47.33 av	29.25	2.45	34.77	44.25 av	54.00 av	-9.75	100	57

1GHz~ 40 GHz (Vertical), Turbo Mode, Channel 3: 5290 MHz

Operator: Jerry Chiou

RBW: 1MHz
 Humidity (%): 36
 Temperature (C): 24

Frequency MHz	Rx_R. dBuV	Ant_F. dB/m	Cab_L. dB	PreAmpl dB	Emission dBuV/m	Limit dBuV/m	Margin dB	A.Tower cm	T.Table deg
1870.33	55.73 pk	29.91	2.50	34.93	53.22 pk	54.00 av	-0.78	100	52
3524.68	55.82 pk	31.53	1.73	35.92	53.17 pk	54.00 av	-0.83	102	222
4814	64.88 pk	34.86	2.12	37.70	64.17 pk	74.00 pk	-9.93	100	20
4814	52.46 av	34.86	2.12	37.70	51.75 av	54.00 av	-2.25	100	20
15855.9	46.46 pk	42.63	3.93	34.57	58.44 pk	74.00 pk	-15.56	102	165
15859.1	31.39 av	42.63	3.93	34.57	43.37 av	54.00 av	-10.63	102	165

Note: “*”: Fundamental Frequency

“pk”: peak reading

“av”: average reading

The Spectrum noise level+Correction Factor<Limit-6 dB

Margin = Corrected Amplitude – Limit

Corrected Amplitude=Radiated Amplitude+Antenna Correction Factor+Cable Loss-Pre-Amplifier Gain

A margin of -8dB means that the emission is 8dB below the limit.

All frequencies from 1GHz to 40 GHz have been tested.

1GHz~ 40 GHz (Horizontal), Turbo Mode, Channel 4 : 5760 MHz

Operator: Jerry Chiou

RBW: 1MHz
Humidity (%): 36
Temperature (C): 24

Frequency	Rx_R.	Ant_F.	Cab_L.	PreAmpl	Emission	Limit	Margin	A.Tower	T.Table
MHz	dBuV	dB/m	dB	dB	dBuV/m	dBuV/m	dB	cm	deg
1791.71	60.57 pk	29.25	2.45	34.77	57.49 pk	74.00 pk	-16.51	100	57
1791.71	47.33 av	29.25	2.45	34.77	44.25 av	54.00 av	-9.75	100	57
4824.43	56.79 pk	34.91	2.12	37.71	56.11 pk	74.00 pk	-17.89	100	18
4824.43	43.56 av	34.91	2.12	37.71	42.88 av	54.00 av	-11.12	100	18
11509.1	42.23 pk	40.73	3.08	34.88	51.17 pk	54.00 av	-2.83	101	158

1GHz~ 40 GHz (Vertical) , Turbo Mode, Channel 4: 5760 MHz

Operator: Jerry Chiou

RBW: 1MHz
Humidity (%): 36
Temperature (C): 24

Frequency	Rx_R.	Ant_F.	Cab_L.	PreAmpl	Emission	Limit	Margin	A.Tower	T.Table
MHz	dBuV	dB/m	dB	dB	dBuV/m	dBuV/m	dB	cm	deg
3833.97	62.65 pk	31.97	1.98	36.86	59.74 pk	74.00 pk	-14.26	102	143
3833.97	49.41 av	31.97	1.98	36.86	46.5 av	54.00 av	-7.5	102	143
4812.0	67.10 pk	34.86	2.12	37.70	66.38 pk	74.00 pk	-7.62	100	20
4812.0	53.28 av	34.86	2.12	37.70	52.56 av	54.00 av	-1.44	100	20
5362.12	55.85 pk	35.90	2.82	37.91	56.66 pk	74.00 pk	-17.34	100	107
5362.12	41.27 av	35.90	2.82	37.91	44.74 av	54.00 av	-11.92	100	107
11509.1	43.72 pk	40.73	3.08	34.88	52.65 pk	54.00 av	-1.35	101	158

Note: “*” : Fundamental Frequency

“pk”: peak reading

“av”: average reading

The Spectrum noise level+Correction Factor<Limit-6 dB

Margin = Corrected Amplitude – Limit

Corrected Amplitude=Radiated Amplitude+Antenna Correction Factor+Cable Loss-Pre-Amplifier Gain

A margin of -8dB means that the emission is 8dB below the limit.

All frequencies from 1GHz to 40 GHz have been tested.

1GHz~ 40 GHz (Horizontal) , Turbo Mode, Channel 5 : 5800 MHZ

Operator: Jerry Chiou

RBW: 1MHz
Humidity (%): 36
Temperature (C): 24

Frequency	Rx_R.	Ant_F.	Cab_L.	PreAmpl	Emission	Limit	Margin	A.Tower	T.Table
MHz	dBuV	dB/m	dB	dB	dBuV/m	dBuV/m	dB	cm	deg
1467.53	59.96 pk	26.65	2.23	34.18	54.66 pk	74.00 pk	-19.34	101	80
1467.53	46.72 av	26.65	2.23	34.18	41.42 av	54.00 av	-12.58	101	80
1796.7	60.80 pk	29.29	2.45	34.78	57.76 pk	74.00 pk	-16.24	100	57
1796.7	47.56 av	29.29	2.45	34.78	44.52 av	54.00 av	-9.48	100	57
4811.57	58.06 pk	34.86	2.12	37.70	57.35 pk	74.00 pk	-16.65	100	20
4811.57	44.49 av	34.86	2.12	37.70	43.78 av	54.00 av	-10.22	100	20

1GHz~ 40 GHz (Vertical), Turbo Mode, Channel 5: 5800 MHZ

Operator: Jerry Chiou

RBW: 1MHz
Humidity (%): 36
Temperature (C): 24

Frequency	Rx_R.	Ant_F.	Cab_L.	PreAmpl	Emission	Limit	Margin	A.Tower	T.Table
MHz	dBuV	dB/m	dB	dB	dBuV/m	dBuV/m	dB	cm	deg
1791.71	60.57 pk	29.25	2.45	34.77	57.49 pk	74.00 pk	-16.51	100	57
1791.71	47.33 av	29.25	2.45	34.77	44.25 av	54.00 av	-9.75	100	57
3854.45	64.00 pk	32.01	2.00	36.94	61.07 pk	74.00 pk	-12.93	102	135
3854.45	55.63 av	32.01	2.00	36.94	52.97 av	54.00 av	-1.03	102	135
4818.8	68.29 pk	34.86	2.12	37.70	67.57 pk	74.00 pk	-6.43	100	20
4818.8	53.32 av	34.86	2.12	37.70	52.6 av	54.00 av	-1.4	100	20
5122.46	54.70 pk	35.73	2.59	37.91	55.11 pk	74.00 pk	-18.89	100	47
5122.46	42.94 av	35.73	2.59	37.91	43.35 av	54.00 av	-10.65	100	47

Note: “ * ”: Fundamental Frequency

“ pk ”: peak reading

“ av ”: average reading

The Spectrum noise level+Correction Factor<Limit-6 dB

Margin = Corrected Amplitude – Limit

Corrected Amplitude=Radiated Amplitude+Antenna Correction Factor+Cable Loss-Pre-Amplifier Gain

A margin of -8dB means that the emission is 8dB below the limit.

All frequencies from 1GHz to 40 GHz have been tested.

4.6 Band Edge Measurement (Section 15.407 (b) (1) (2))

4.6.1 Test Procedure (Conducted)

1. The Transmitter output of EUT was connected to the spectrum analyzer.
Equipment mode: Spectrum analyzer

Peak Mode:	
SPAN	100MHz
RBW	1MHz
VBW	1MHz
Sweep Time	200msec.

2. Using Peak Search to read the peak power of Carrier frequencies after Maximum Hold function is completed.
3. Find the next peak frequency outside the operation frequency band.

4.6.2 Test Setup (Conducted)

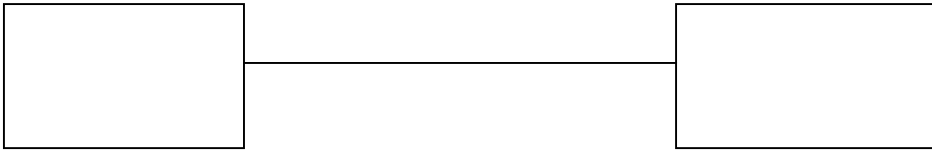



4.6.3 Test Data (conducted):

Please refer to ISL report 04LR018FC

4.6.4 Bandedge Measurement Test Procedure (Radiated)

1. Antenna and Turntable test procedure same as Radiated Emissions measurement listed in Para. 6.5
Equipment mode: Spectrum analyzer

Peak Mode:	
SPAN	100MHz
RBW	1MHz
VBW	3MHz
Sweep Time	200msec.
AVE Mode:	
SPAN	100MHz
RBW	1MHz
VBW	10Hz
Sweep Time	20 sec.

2. Using Peak Search to read the peak power of Carrier frequencies after Maximun Hold function is completed.
3. Find the next peak frequency outside the operation frequency band.
4. Get the spectrum reading after Maximun Hold function is completed.

4.6.5 Test Setup (Radiated)

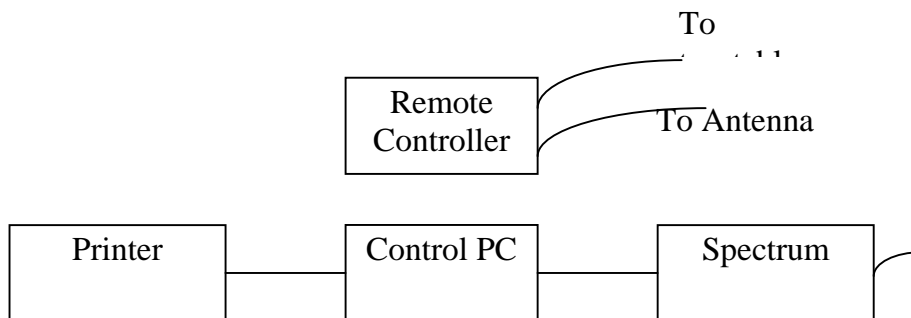
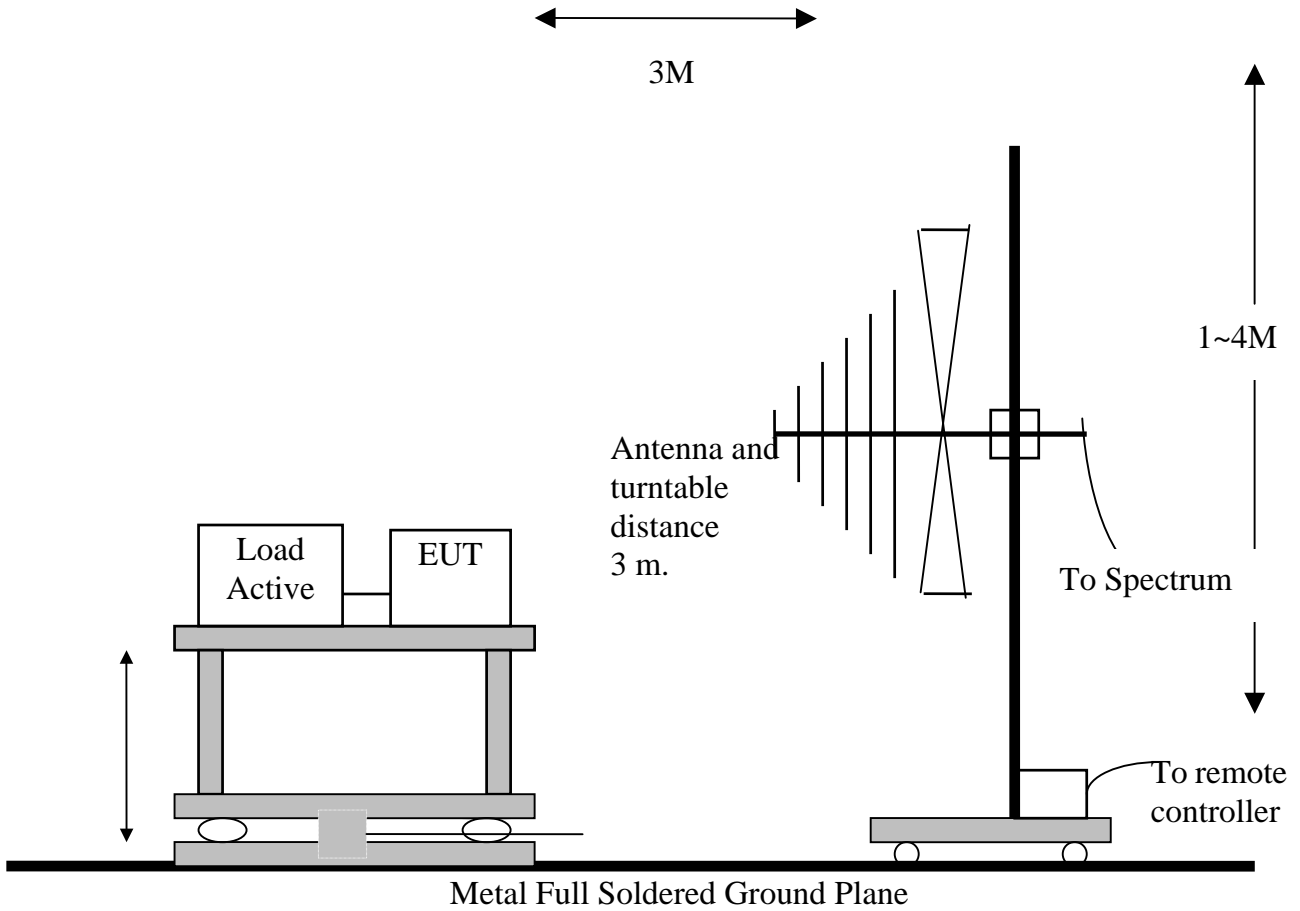

4.6.6 Test Data (Radiated):

Band Edge measurement (Radiated)

Temperature (deg. C): 24

Test Engineer: Jerry Chiou

Humidity (%): 36

Outside Channel (Normal)	Frequency (MHz)	Spectrum Reading (dBUV)	Correction Factor (dB/m)	Emission Level (dBUV/m)	Limit (dBUV/m)	Pass/Fail
1	5150	21.23	39.03	60.26	74	Pass
(Peak)						
1	5150	8.91	39.03	47.94	54	Pass
(Average)						
8	5350	21.33	39.34	60.67	74	Pass
(Peak)						
8	5350	9.13	39.34	48.47	54	Pass
(Average)						
9	5715	21.91	39.41	61.32	74	Pass
(Peak)						
9	5715	9.48	39.41	48.89	54	Pass
(Average)						
12	5835	22.02	39.42	61.44	74	Pass
(Peak)						
12	5835	9.39	39.42	48.81	54	Pass
(Average)						

Outside Channel (Turbo)	Frequency (MHz)	Spectrum Reading (dBUV)	Correction Factor (dB/m)	Emission Level (dBUV/m)	Limit (dBUV/m)	Pass/Fail
1 (Peak)	5150	21.26	39.03	60.29	74	Pass
1 (Average)	5150	9.03	39.03	48.06	54	Pass
3 (Peak)	5350	22.48	39.34	61.82	74	Pass
3 (Average)	5350	9.2	39.34	48.54	54	Pass
4 (Peak)	5715	23.34	39.41	62.75	74	Pass
4 (Average)	5715	10.2	39.41	49.61	54	Pass
5 (Peak)	5835	25.63	39.42	65.05	74	Pass
5 (Average)	5835	11.73	39.42	51.15	54	Pass

Note: “pk”: peak reading
 “av”: average reading
 Emission Level=Spectrum Reading+Correction Factor
 Correction Factor =Antenna Factor+cable loss
 Both Horizontal and Vertical polarization have been tested and the worst data is listed above.

Band Edge measurement for radiated emission in Restricted Band(Radiated) Normal Mode (Channel 1) Peak data

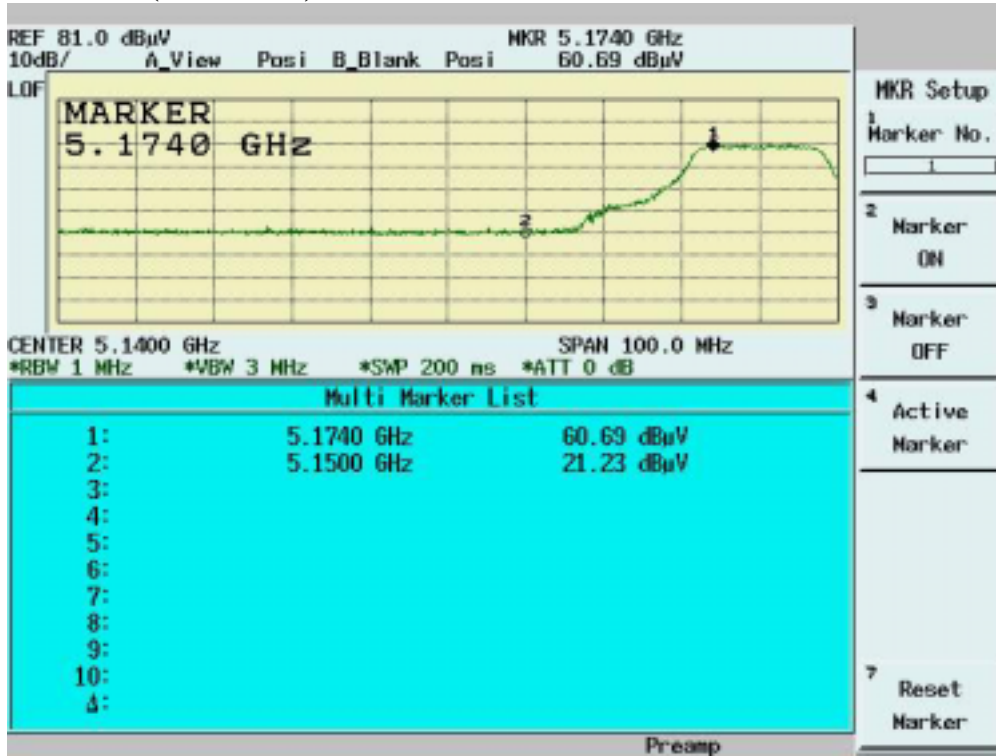

Normal Mode (Channel 1) Average Data

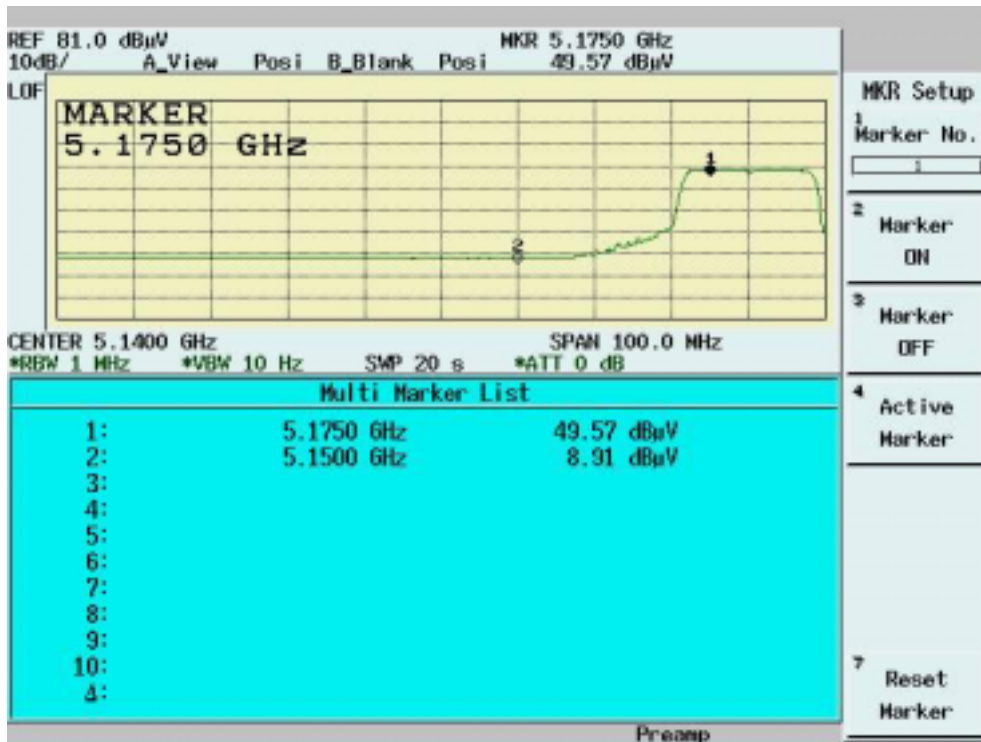

Normal Mode (Channel 8) Peak data

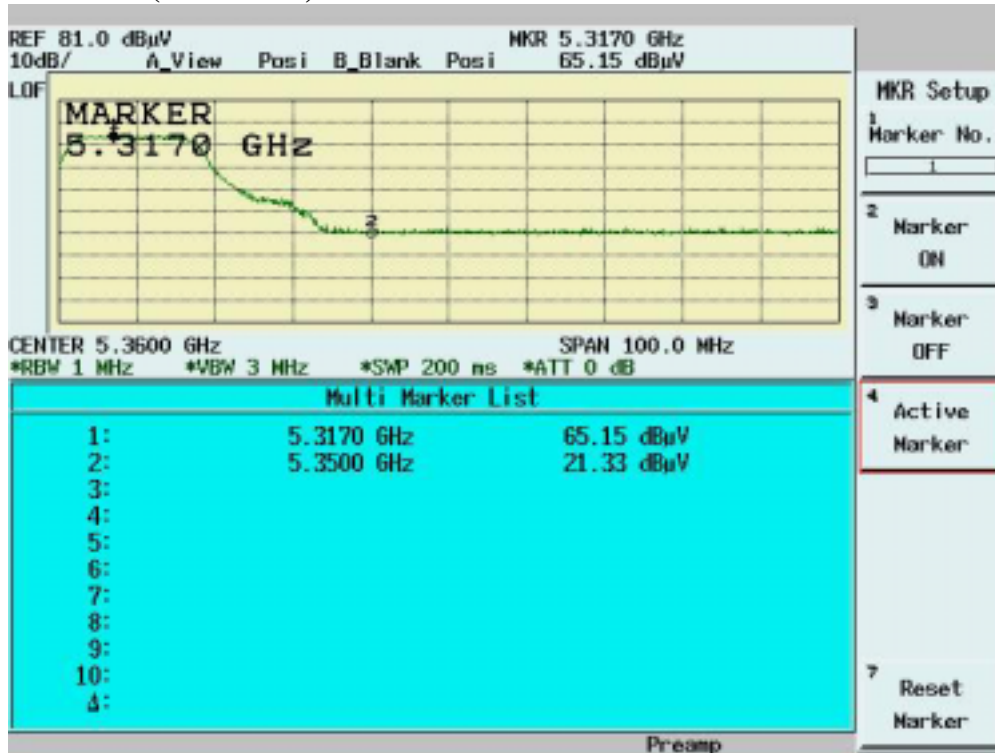

Normal Mode (Channel 8) Average data

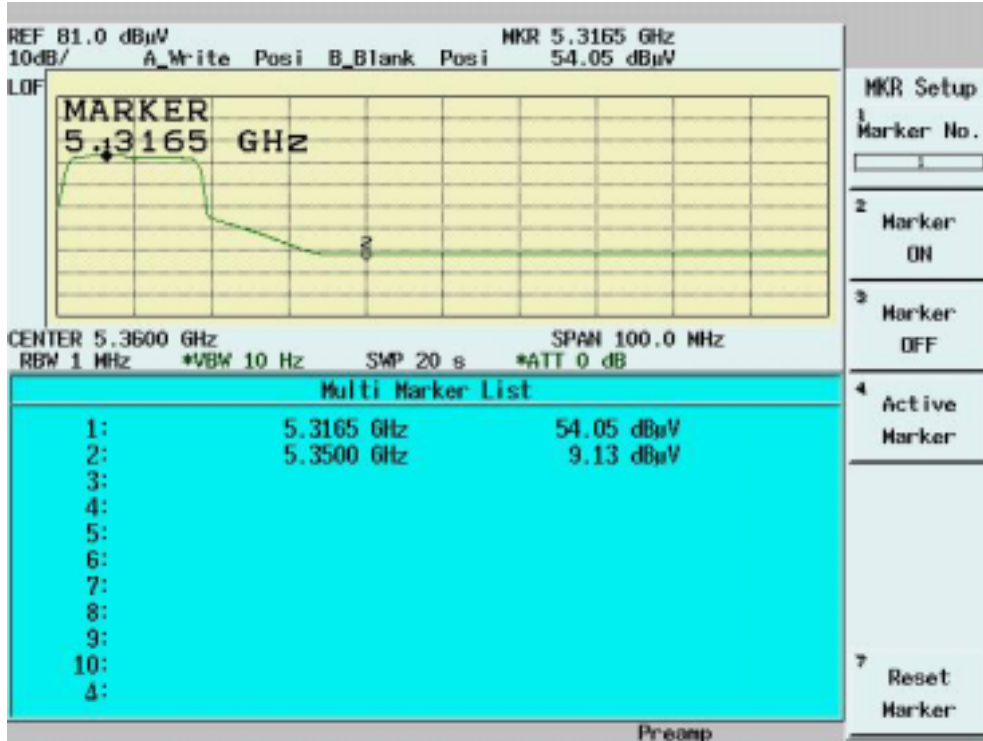

Normal Mode (Channel 9) Peak data

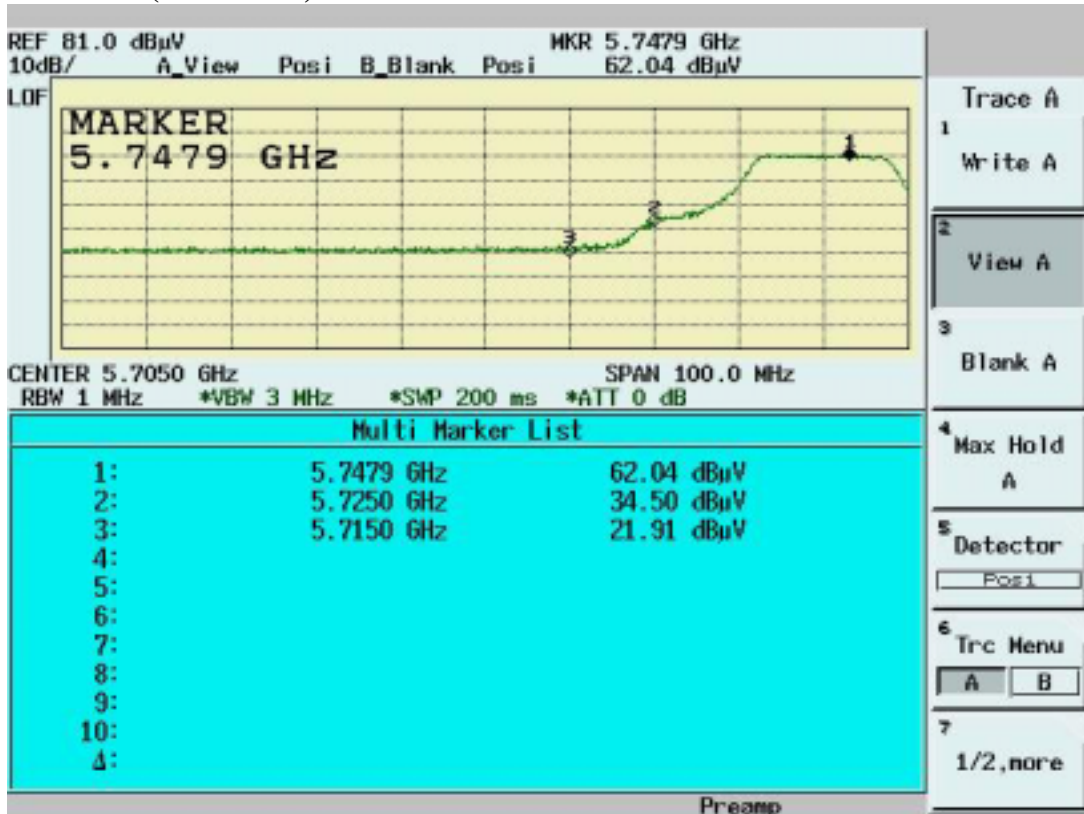

Normal Mode (Channel 9) Average Data

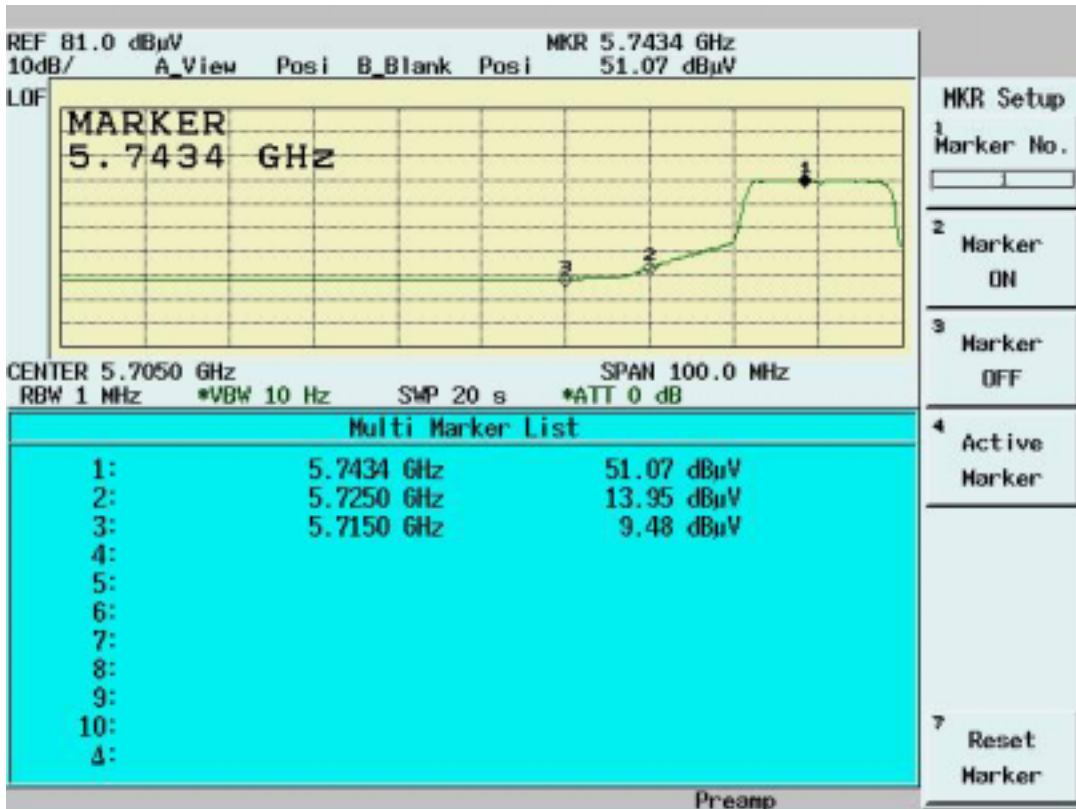

Normal Mode (Channel 12) Peak data

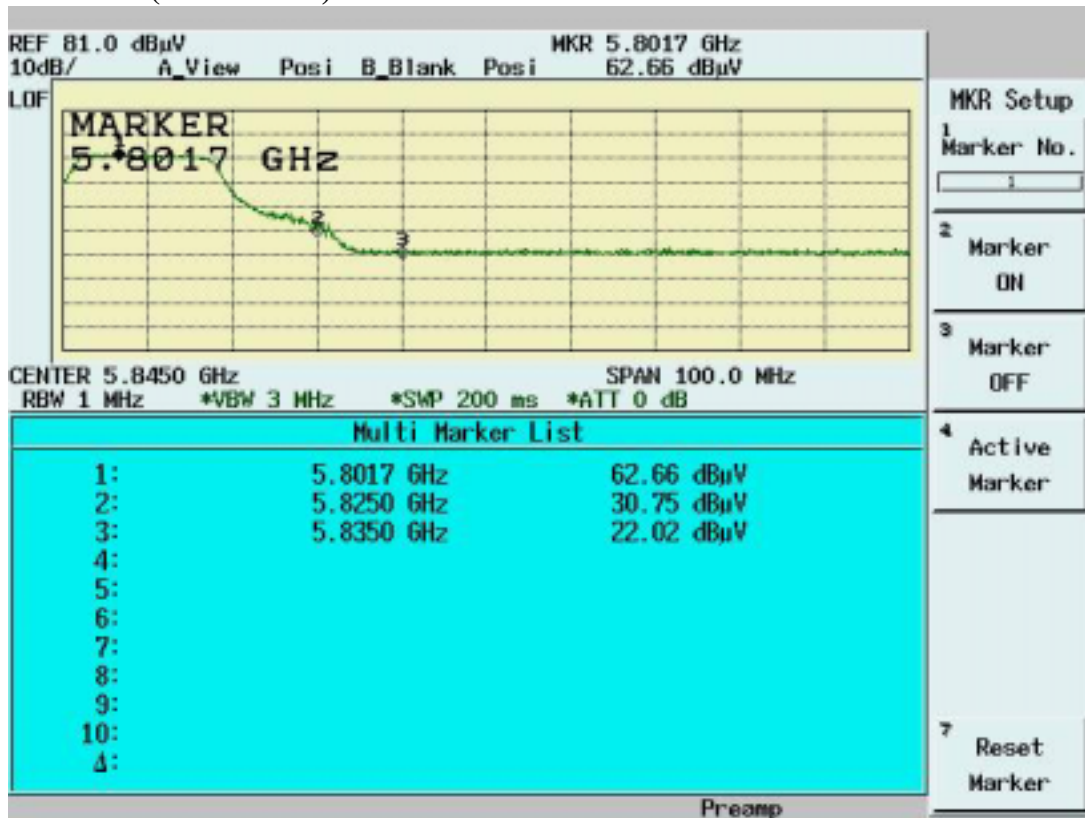

Normal Mode (Channel 12) Average Data

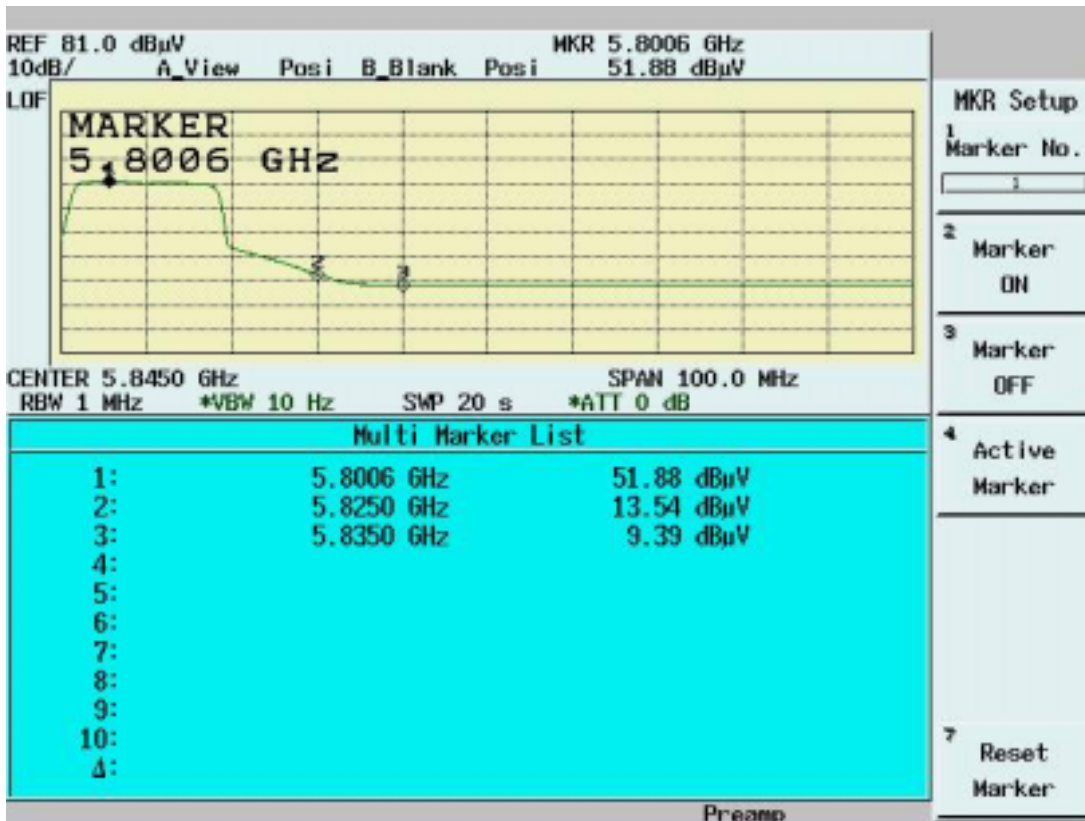

Band Edge measurement for radiated emission in Restricted Band(Radiated) Turbo Mode (Channel 1) Peak data

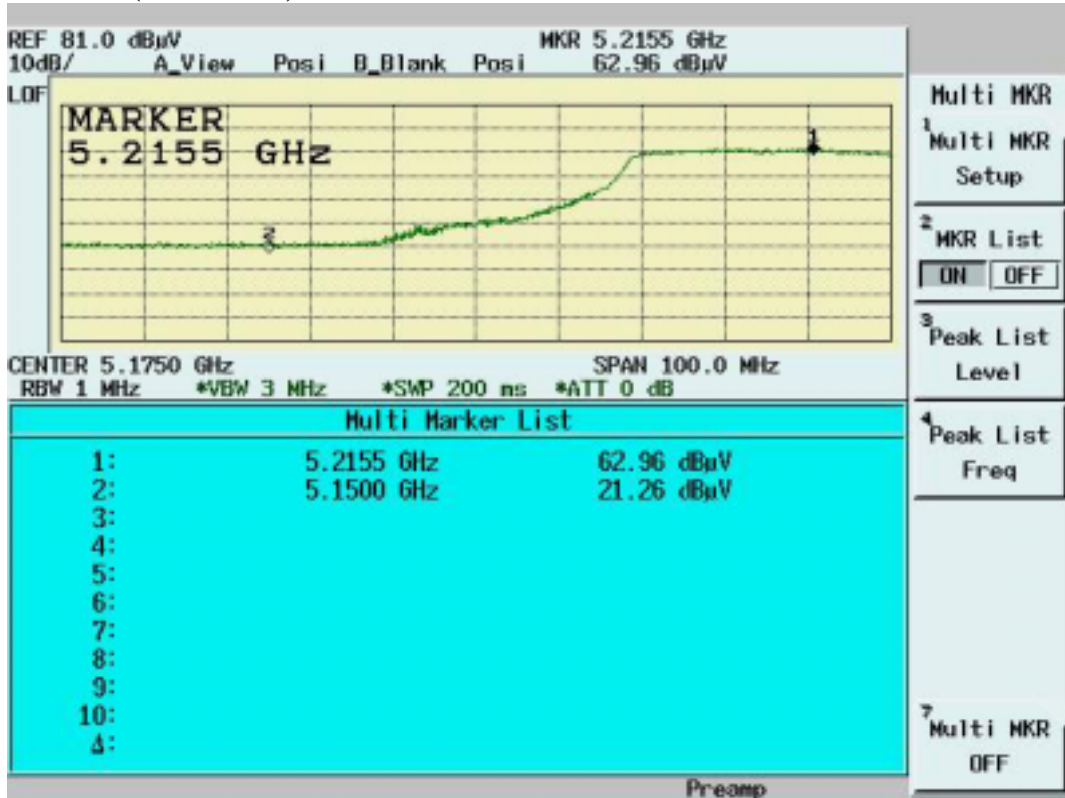

Turbo Mode (Channel 1) Average data

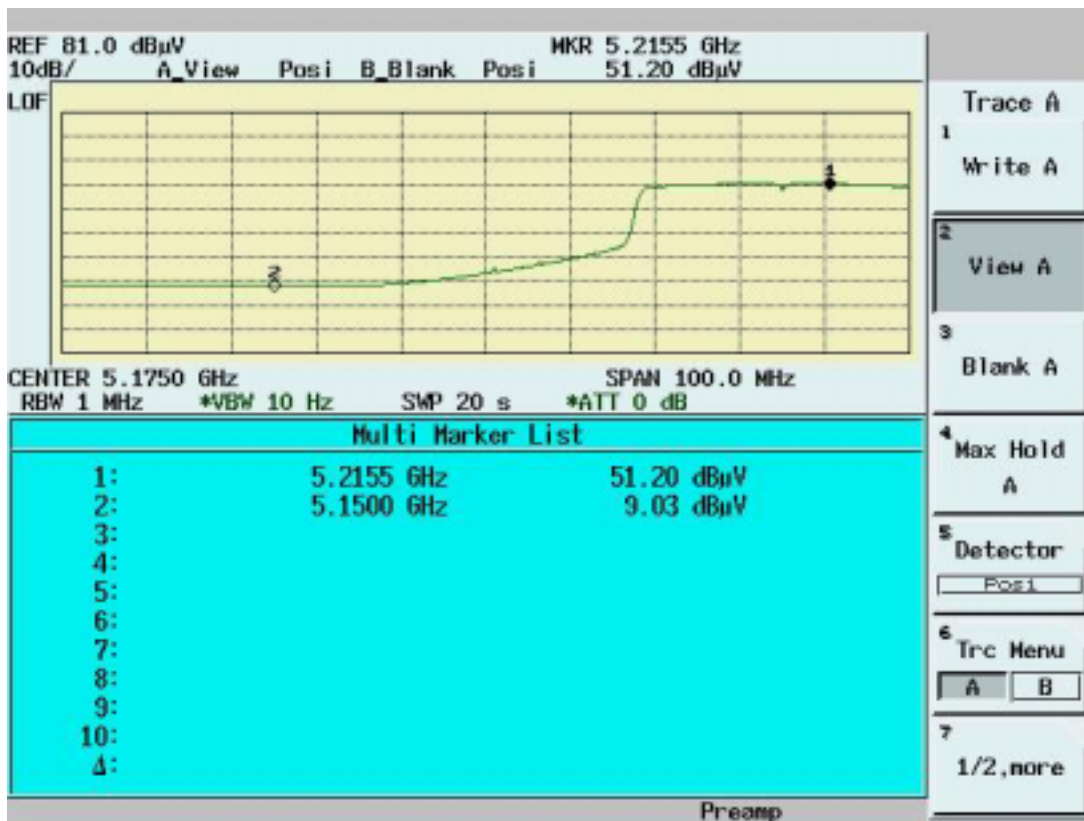

Turbo Mode (Channel 3) Peak data

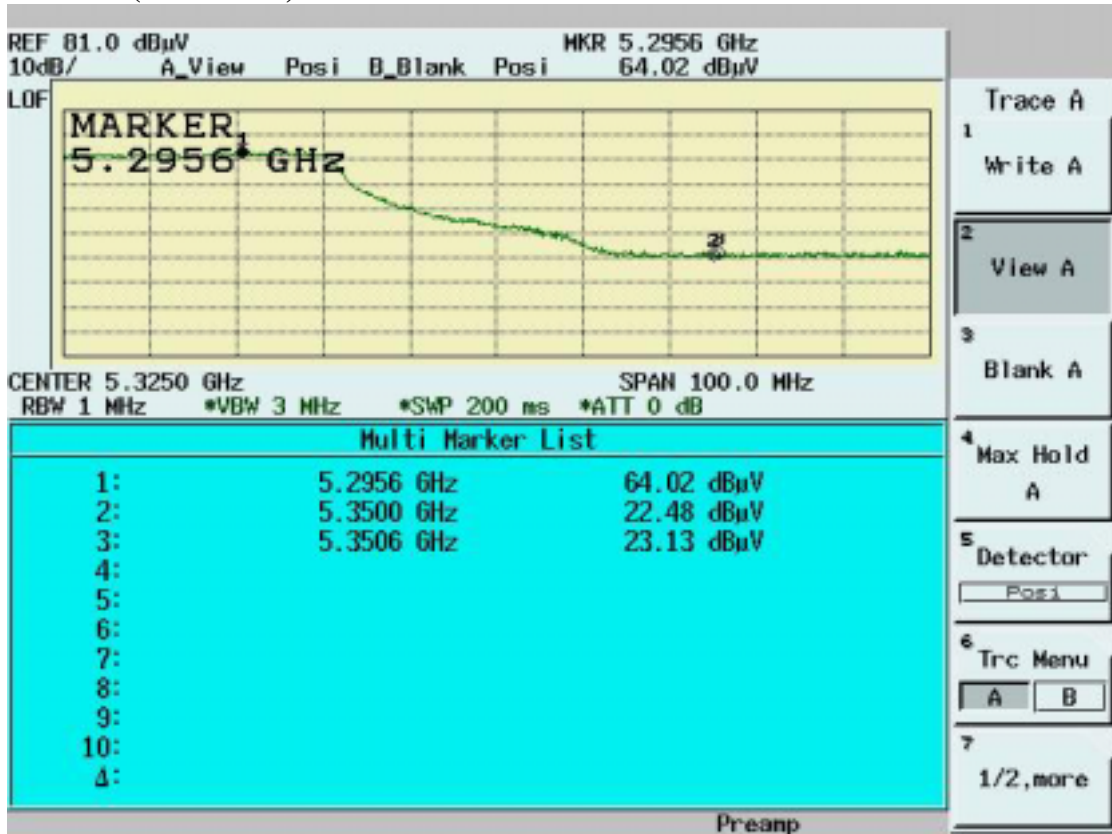

Turbo Mode (Channel 3) Average Data

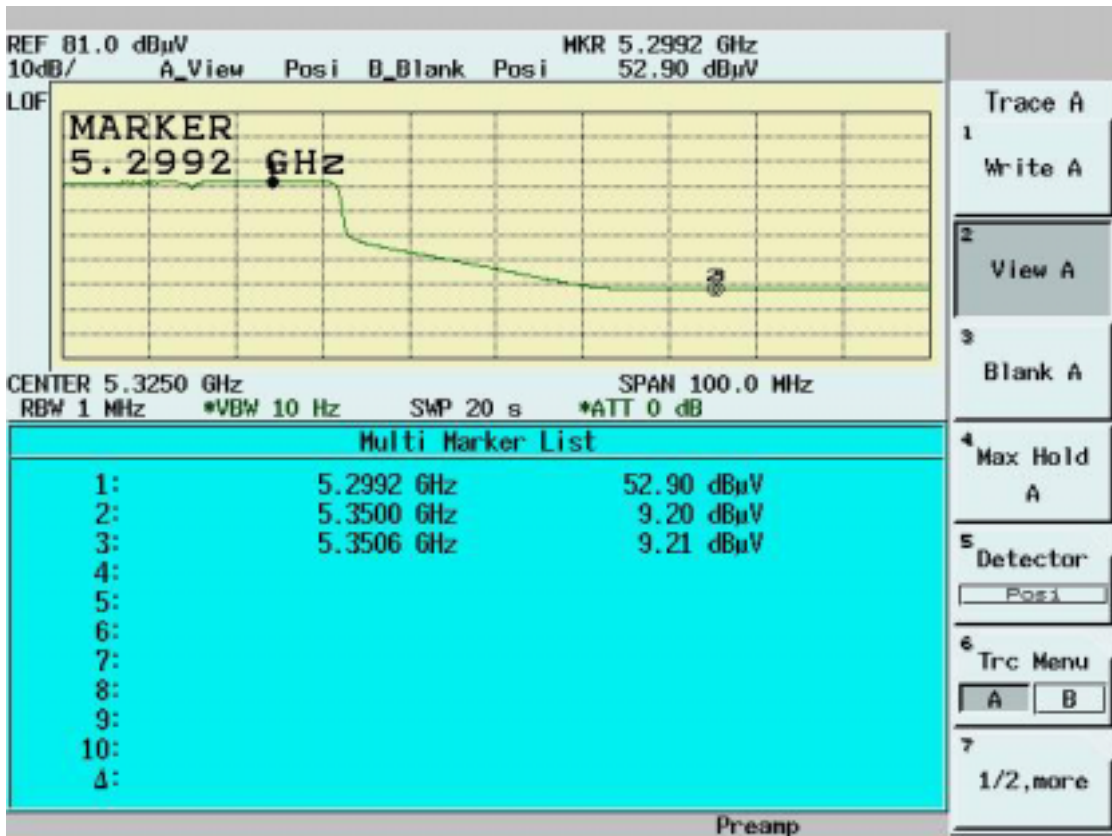

Turbo Mode (Channel 4) Peak data

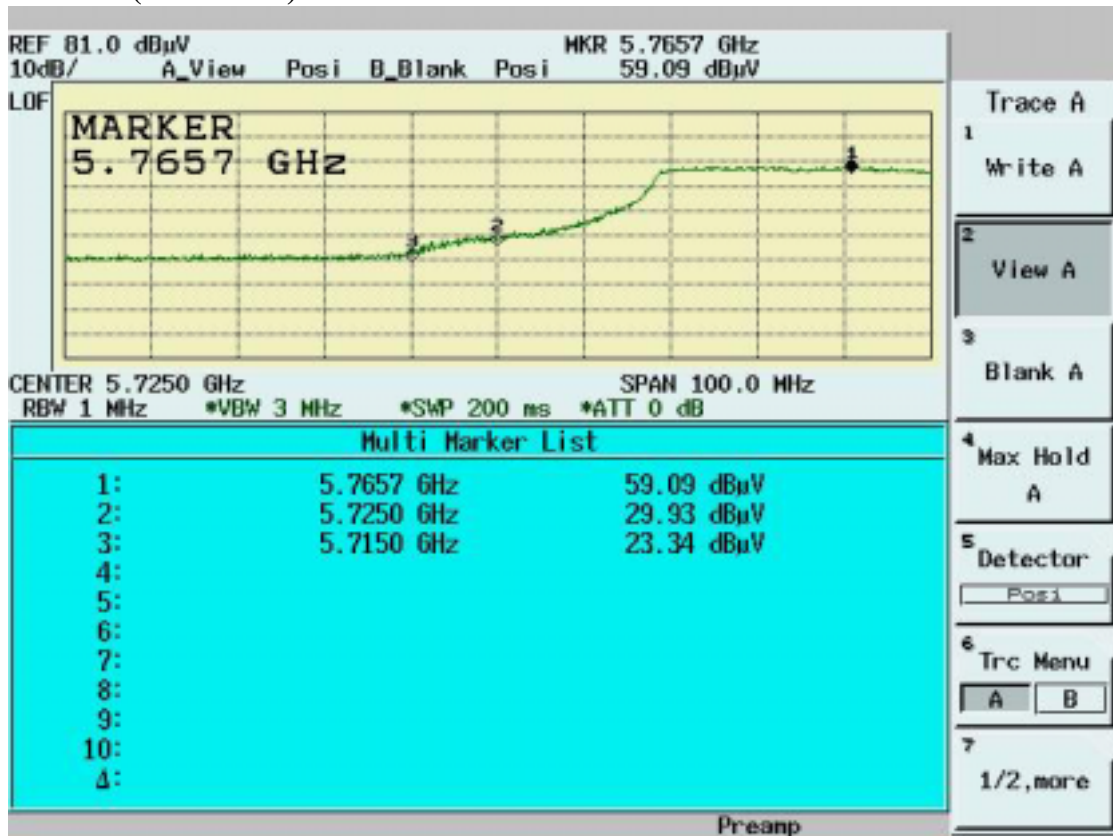

Turbo Mode (Channel 4) Average data

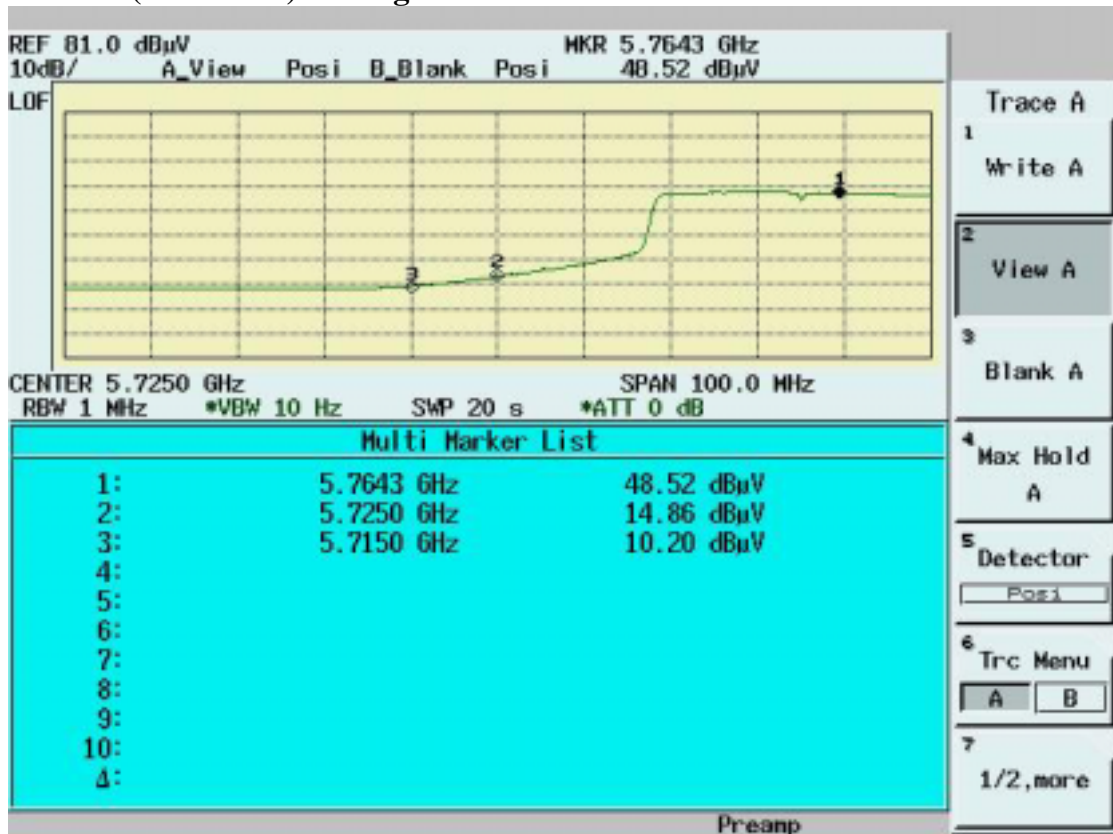

Turbo Mode (Channel 5) Peak data

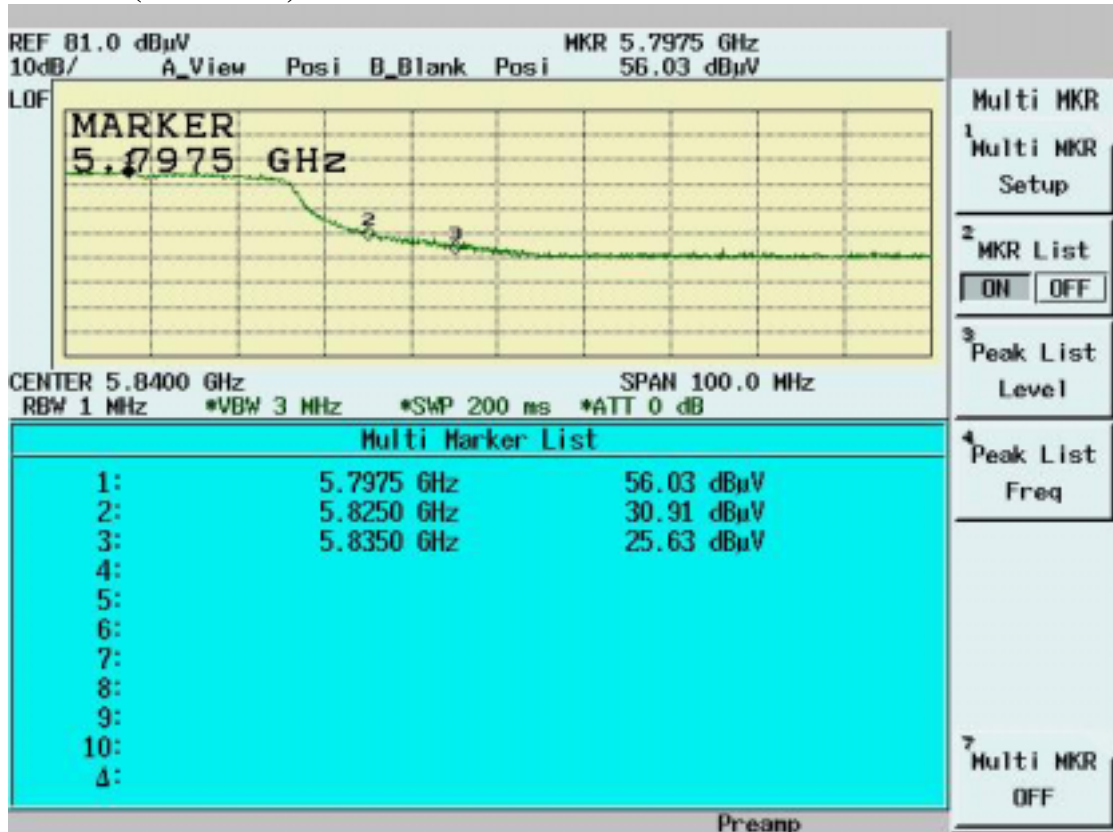

Turbo Mode (Channel 5) Average Data

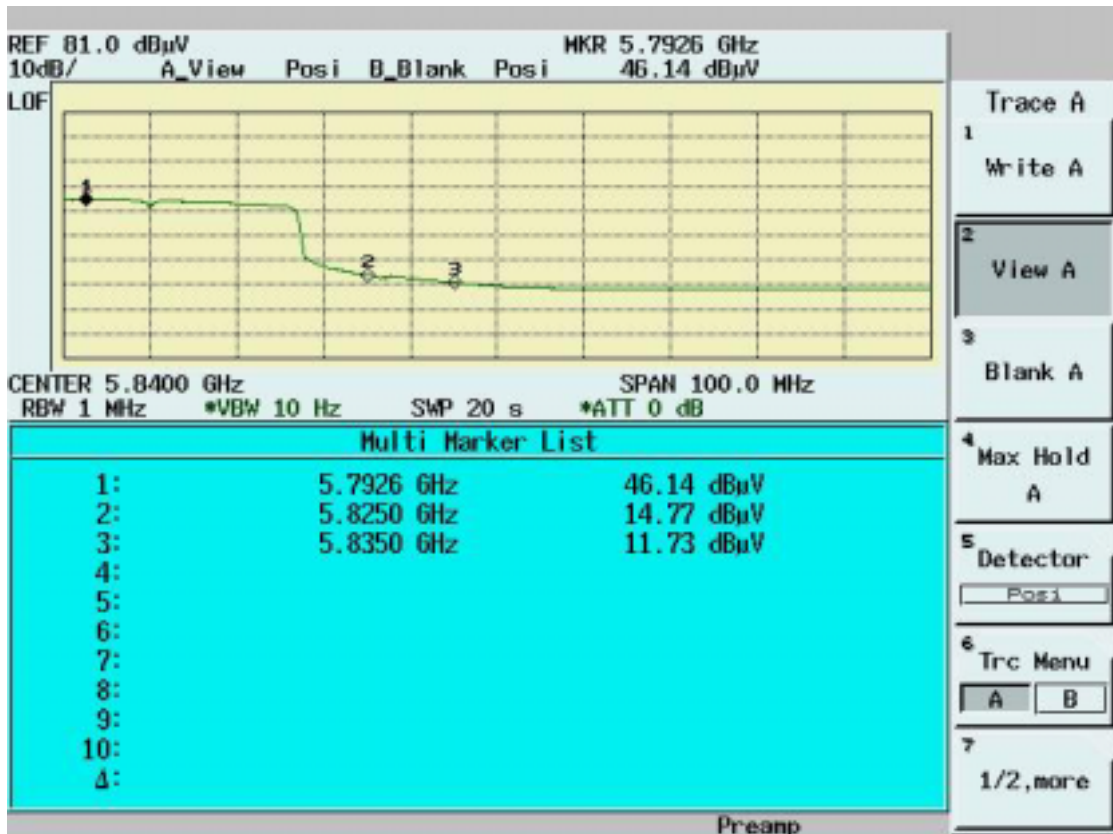



4.7 RF Exposure Measurement [Section 15.407(f)(4) & 1.1307(b)]

Refer to MPE Test Report

4.8 Frequency Stability [Section 15.407(g)]

4.8.1 Limits of Frequency Stability Measurement

The frequency tolerance of the carrier signal shall be maintained within +/- 0.02% of the operating frequency over the operation temperature range of EUT (0°C~35°C), and variation in the primary supply voltage from 85% to 115% of the rated supply voltage (115V AC) at 20°C.

4.8.2 Test Procedure

1. The EUT was placed in the Temperature/Humidity Chamber and powered by a Voltage/Frequency Power converter.
2. Connect the RF output of EUT to Spectrum. Turn on the EUT.
3. Turn the EUT off and set the chamber to the highest temperature specified.
4. Allow sufficient time (approximately 30 min) for the chamber temperature to stabilize. Turn the EUT on and measure the operating frequency after 2, 5, 10 minutes.
5. Set the Voltage/Frequency Power Converter to 85% and 115% of supply voltage, then repeat step 2, 3, 4 respectively.
6. Repeat step 2, 3, 4, 5 with the temperature of chamber set to the lowest temperature.
7. Repeat step 2, 3, 4, 5 with the temperature of chamber set to 20°C.

4.8.3 Test Setup

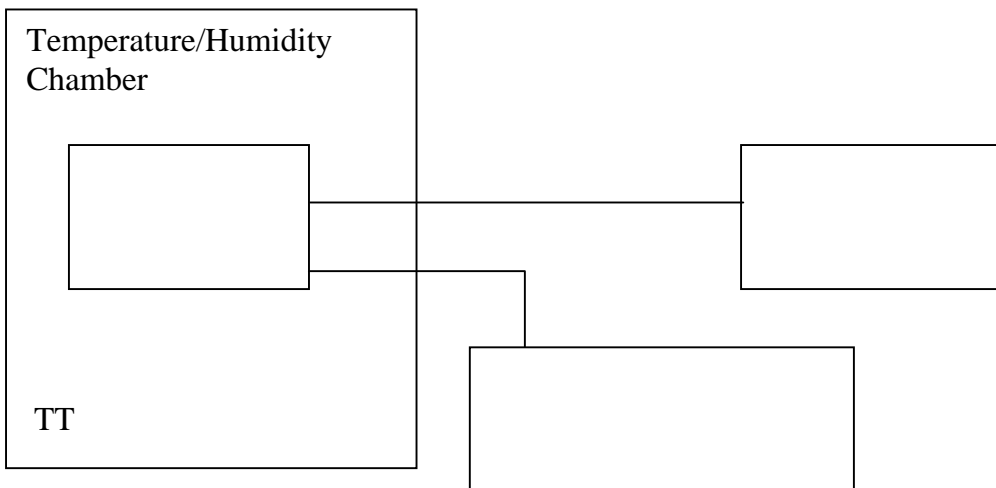

4.8.4 Test Data

Test Engr: Mailes Hsieh

Operating Frequency:		5180 (Mhz)		Limit: +/- 0.02%			
Temp.	Power Supply	2 minutes		5 minutes		10 minutes	
(⁰ C)	(V AC)	(MHz)	(%)	(MHz)	(%)	(MHz)	
35	132	5179.9836	-0.000317	5179.9670	-0.000637	5179.9810	-0.000367
	115	5179.9974	-0.000050	5179.9862	-0.000266	5179.9730	-0.000521
	97	5180.0062	0.000120	5179.9842	-0.000305	5179.9870	-0.000251
0	132	5180.0134	0.000259	5180.0004	0.000008	5180.0116	0.000224
	115	5180.0018	0.000035	5180.0032	0.000062	5180.0086	0.000166
	97	5180.0144	0.000278	5180.0104	0.000201	5180.0116	0.000224
20	132	5179.9424	-0.001112	5179.9778	-0.000429	5179.9710	-0.000560
	115	5179.9876	-0.000239	5179.9748	-0.000486	5179.9712	-0.000556
	97	5179.9678	-0.000622	5179.9692	-0.000595	5179.9680	-0.000618

5. TEST RESULTS (802.11b)

5.1 Powerline Conducted Emissions [Section 15.207]

5.1.1 EUT Configuration

The EUT was set up on the non-conductive table that is 1.0 by 1.5 meter, 80cm above ground. The wall of the shielded room was located 40cm to the rear of the EUT.

Power to the EUT was provided through the LISN. The impedance vs. frequency characteristic of the LISN is complied with the limit used.

Both lines (neutral and hot) were connected to the LISN in series at testing. A coaxial-type connector which provides one 50 ohms terminating impedance was provided for connecting the test instrument. The excess length of the power cord was folded back and forth at the center of the lead so as to form a bundle not exceeding 40cm in length.

Any changes made to the configuration, or modifications made to the EUT, during testing are noted in the following test record.

If the EUT is a Personal Computer or a peripheral of personal computer, and the personal computer has an auxiliary AC outlet which can be used for providing power to an external monitor, then all measurements will be made with the monitor power from first the computer-mounted AC outlet and then a floor-mounted AC outlet.

5.1.2 Test Procedure

The system was set up as described above, with the EMI diagnostic software running. The main power line conducted EMI tests were run on the hot and neutral conductors of the power cord and the results were recorded. The effect of varying the position of the interface cables has been investigated to find the configuration that produces maximum emission.

At the frequencies where the peak values of the emissions were higher than 6dB below the applicable limits, the emissions were also measured with the quasi-peak detectors. At the frequencies where the quasi-peak values of the emissions were higher than 6dB below the applicable average limits, the emissions were also measured with the average detectors.

The highest emissions were analyzed in details by operating the spectrum analyzer in fixed tuned mode to determine the nature of the emissions and to provide information which could be useful in reducing their amplitude.

5.1.3 EMI Receiver/Spectrum Analyzer Configuration (for the frequencies tested)

Frequency Range	150 KHz--30MHz
Detector Function	Quasi-Peak/Average
Bandwidth (RBW)	9KHz

5.1.4 Test Data:

Power Line Conducted Emissions (Hot) Channel 1, 6, 11

Operator: Jerry Chiou
 Temperature (C): 22
 Humidity (%): 56

Frequency MHz	LISN Loss (dB)	Cable Loss (dB)	QP Corrt. Amp.(dBuV)	QP Limit (dBuV)	QP Margin (dB)	AVE Corrt. Amp.(dBuV)	AVE Limit (dBuV)	AVE Margin (dB)
0.46803	0.11	0.03	33.53	56.91	-23.38	30.44	46.91	-16.47
0.53496	0.12	0.03	32.02	56.00	-23.98	29.38	46.00	-16.62
0.67085	0.15	0.04	30.23	56.00	-25.77	27.82	46.00	-18.18
0.81381	0.17	0.06	26.49	56.00	-29.51	11.53	46.00	-34.47
0.86686	0.18	0.06	32.79	56.00	-23.21	30.93	46.00	-15.07
10.2798	0.53	0.19	46.85	60.00	-13.15	42.04	50.00	-7.96
13.4186	0.64	0.26	47.16	60.00	-12.84	41.82	50.00	-8.18
13.688	0.65	0.27	48.22	60.00	-11.78	42.98	50.00	-7.02
13.8204	0.66	0.27	48.53	60.00	-11.47	43.21	50.00	-6.79
14.1525	0.67	0.28	47.82	60.00	-12.18	42.59	50.00	-7.41

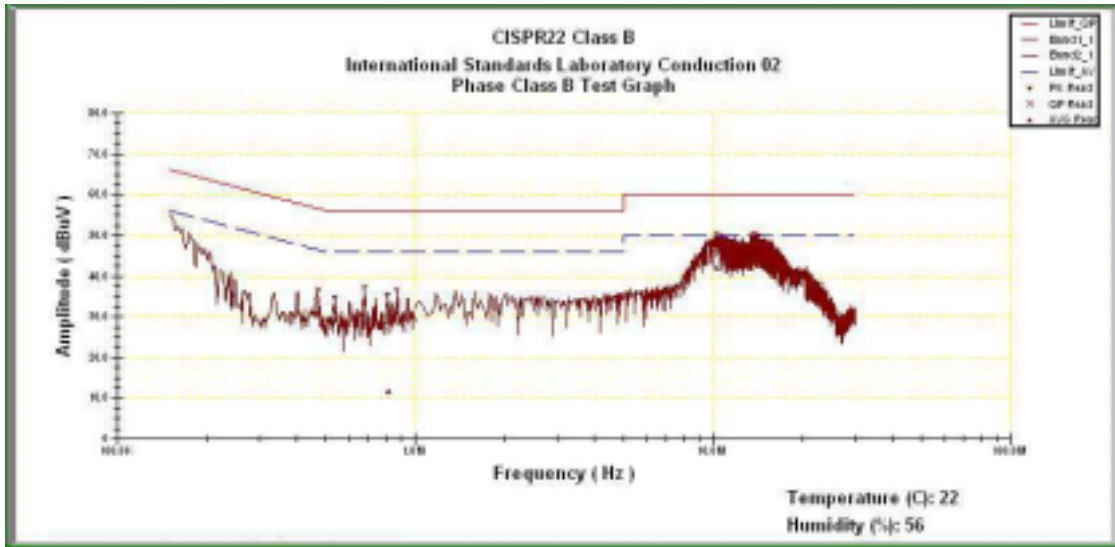

Power Line Conducted Emissions (Neutral) Channel 1, 6, 11

Operator: Jerry Chiou

Temperature (C): 22

Humidity (%): 56

Frequency MHz	LISN Loss (dB)	Cable Loss (dB)	QP Corrcr. Amp.(dBuV)	QP Limit (dBuV)	QP Margin (dB)	AVE Corrcr. Amp.(dBuV)	AVE Limit (dBuV)	AVE Margin (dB)
0.19948	0.10	0.02	54.74	64.59	-9.85	37.06	54.59	-17.52
0.22723	0.10	0.02	50.88	63.79	-12.91	31.11	53.79	-22.69
0.26445	0.10	0.02	47.80	62.73	-14.93	32.43	52.73	-20.30
0.27763	0.10	0.02	44.83	62.35	-17.52	25.86	52.35	-26.50
0.30348	0.10	0.02	43.52	61.61	-18.09	25.97	51.61	-25.64
10.3427	0.32	0.19	40.70	60.00	-19.30	34.38	50.00	-15.62
10.9525	0.33	0.20	48.19	60.00	-11.81	43.58	50.00	-6.42
11.0864	0.33	0.21	48.16	60.00	-11.84	43.51	50.00	-6.49
14.1579	0.38	0.28	47.28	60.00	-12.72	42.09	50.00	-7.91
14.2235	0.39	0.28	46.94	60.00	-13.06	41.54	50.00	-8.46

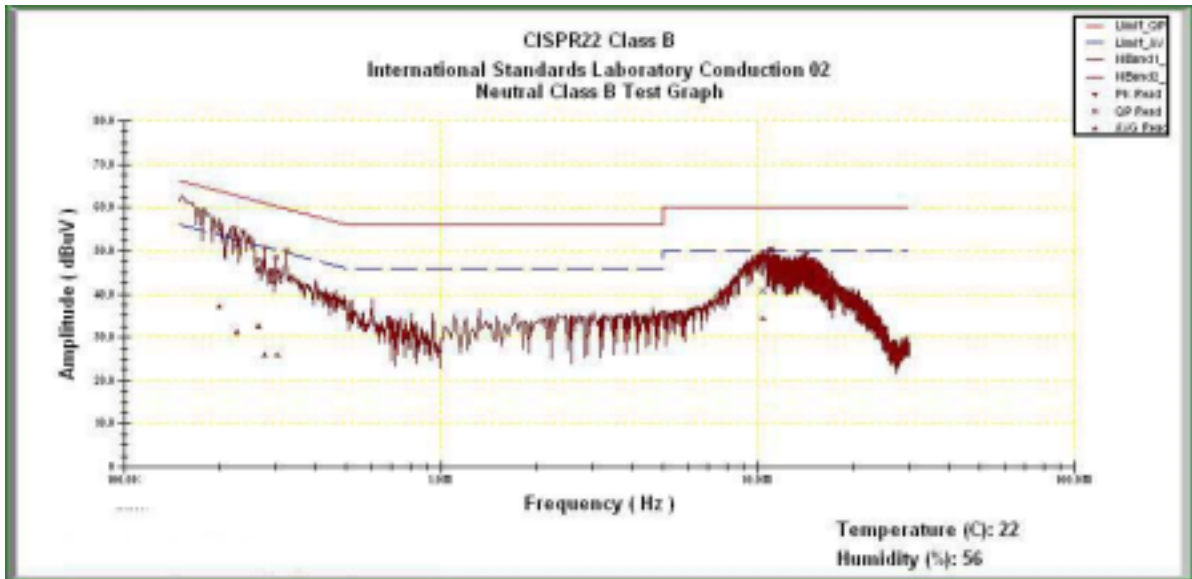

* NOTE: During the test, the EMI receiver was set to Max. Hold then switch the EUT Channel between 1 , 6, 11 to get the maximum reading of all these channels.
 Margin = Amplitude + Insertion Loss- Limit
 A margin of -8dB means that the emission is 8dB below the limit

5.2 Bandwidth for DSSS [Section 15.247 (a)(2)]

5.2.1 Test Procedure

The Transmitter output of EUT was connected to the spectrum analyzer. The 6 dB bandwidth of the fundamental frequency was measured. The setting of spectrum analyzer is as follows

Equipment mode	Spectrum analyzer
Detector function	Peak mode
RBW	100KHz
VBW	100KHz

5.2.2 Test Setup

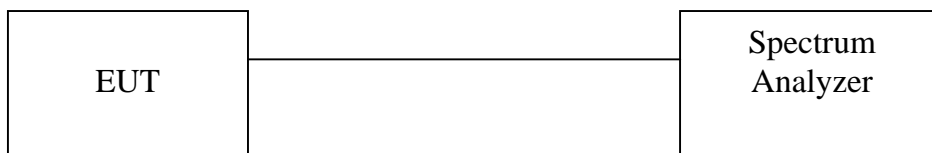

5.2.3 Test Data:

Please refer to ISL report 04LR018FC

5.3 DSSS Maximum Peak Output Power [Section 15.247 (b)(1)]

5.3.1 Test Procedure

The Transmitter output of EUT was connected to the peak power analyzer.

5.3.2 Test Setup

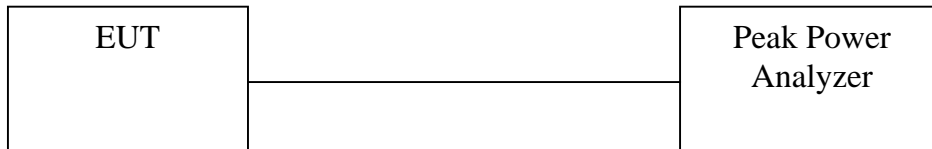

5.3.3 Test Data

Please refer to ISL report 04LR018FC

5.4 Radiated Emission Measurement [Section [15.247(c)(4)]

5.4.1 EUT Configuration

The equipment under test was set up on the 10 meter chamber with measurement distance of 3 meters. The EUT was placed on a non-conductive table 80cm above ground.

Any changes made to the configuration, or modifications made to the EUT, during testing are noted in the following test record.

5.4.2 Test Procedure

The system was set up as described above, with the EMI diagnostic software running. We found the maximum readings by varying the height of antenna and then rotating the turntable. Both polarization of antenna, horizontal and vertical, are measured.

30M to 1GHz: The highest emissions between 30 MHz to 1000 MHz were also analyzed in details by operating the spectrum analyzer and/or EMI receiver in quasi-peak mode to determine the precise amplitude of the emissions. While doing so, the interconnecting cables and major parts of the system were moved around, the antenna height was varied between one and four meters, its polarization was varied between vertical and horizontal, and the turntable was slowly rotated, to maximize the emission.

1GHz – 25GHz: The highest emissions were also analyzed in details by operating the spectrum analyzer and/or EMI receiver in peak mode to determine the precise amplitude of the emission. While doing so, the interconnecting cables and major parts of the system were moved around, the antenna height was varied between one and four meters, its polarization was varied between vertical and horizontal, and the turntable was slowly rotated, to maximize the emission. During test the EMI receiver and spectrum was setup according to *EMI Receiver/Spectrum Analyzer Configuration*.

For the test of 2nd to 10th harmonics frequencies, the equipment setup was also refer to *EMI Receiver/Spectrum Analyzer Configuration*. The frequencies were tested using Peak mode first, if the test data is higher than the emissions limit, an additional measurement using Average mode will be performed and the average reading will be compared to the limit and record in test report.

5.4.3 EMI Receiver/Spectrum Analyzer Configuration (for the frequencies tested)

Frequency Range Tested:	30MHz~1000MHz
Detector Function:	Quasi-Peak Mode
Resolution Bandwidth (RBW):	120KHz
Video Bandwidth (VBW)	1MHz
Frequency Range Tested:	1GHz – 25 GHz
Detector Function:	Peak Mode
Resolution Bandwidth (RBW):	1MHz
Video Bandwidth (VBW)	3MHz
Frequency Range Tested:	1GHz – 25 GHz
Detector Function:	Average Mode
Resolution Bandwidth (RBW):	1MHz
Video Bandwidth (VBW)	10 Hz

5.4.4 Test Data (30MHz – 1GHz):

30M – 1GHz Open Field Radiated Emissions (Horizontal) Channel 1, 6, 11

Operator: Jerry Chiou

Humidity (%): 46
Temperature (C): 25

Frequency MHz	Rx_R. dBuV	Ant_F. dB/m	Cab_L. dB	PreAmpl dB	Emission dBuV/m	Limit dBuV/m	Margin dB	A.Tower cm	T.Table deg
99.84	22.45	10.27	3.02	0.00	35.73	43.50	-7.77	100.00	140.00
198.78	24.94	8.86	4.18	0.00	37.98	43.50	-5.52	100.00	346.00
231.76	27.17	9.21	4.48	0.00	40.87	46.00	-5.13	100.00	9.00
298.69	21.10	13.57	4.69	0.00	39.37	46.00	-6.63	100.00	173.00
365.62	22.66	14.83	5.08	0.00	42.57	46.00	-3.43	100.00	173.00
398.6	19.57	15.95	5.31	0.00	40.83	46.00	-5.17	100.00	239.00
431.58	18.91	16.25	5.61	0.00	40.77	46.00	-5.23	100.00	157.00
465.53	15.27	16.80	5.88	0.00	37.95	46.00	-8.05	100.00	9.00
564.47	13.97	19.04	6.57	0.00	39.58	46.00	-6.42	100.00	305.00
864.2	8.76	20.54	8.24	0.00	37.54	46.00	-8.46	100.00	124.00

30M – 1GHz Open Field Radiated Emissions (Vertical) Channel 1, 6, 11

Operator: Jerry Chiou

Humidity (%): 46
Temperature (C): 25

Frequency MHz	Rx_R. dBuV	Ant_F. dB/m	Cab_L. dB	PreAmpl dB	Emission dBuV/m	Limit dBuV/m	Margin dB	A.Tower cm	T.Table deg
136.7	17.95	10.73	3.54	0.00	32.22	43.50	-11.28	100.00	242.00
364.65	15.38	14.80	5.07	0.00	35.25	46.00	-10.75	100.00	176.00
431.58	12.89	16.25	5.61	0.00	34.75	46.00	-11.25	100.00	209.00
469.41	13.09	16.90	5.89	0.00	35.89	46.00	-10.11	100.00	192.00
497.54	12.74	17.64	6.04	0.00	36.41	46.00	-9.59	100.00	225.00
643.04	7.62	19.07	7.00	0.00	33.70	46.00	-12.30	100.00	242.00
652.74	14.39	19.09	7.05	0.00	40.53	46.00	-5.47	100.00	225.00
661.47	8.12	19.08	7.07	0.00	34.27	46.00	-11.73	100.00	242.00
764.29	5.61	20.07	7.64	0.00	33.32	46.00	-12.68	100.00	209.00
864.2	4.57	20.54	8.24	0.00	33.35	46.00	-12.65	100.00	143.00

NOTE:

- During the Pre-test, the EUT has been tested for Channel 1, 6, 11 transmit from Main and Aux antenna respectively to get all the critical emission frequencies. In the final test all the critical emission frequencies has been tested and the test data are listed above.
- Margin = Corrected Amplitude – Limit
Corrected Amplitude = Radiated Amplitude + Antenna Correction Factor + Cable Loss - Pre-Amplifier Gain
A margin of -8dB means that the emission is 8dB below the limit

All frequencies from 30MHz to 1GHz have been tested

5.4.5 Test Data (1GHz – 25 GHz) .

1GHz~ 25 GHz (Horizontal), Channel 1: 2412 MHz

Operator: Jerry Chiou

RBW: 1MHz
Humidity (%): 39
Temperature (C): 22

Frequency MHz	Rx_R. dBuV	Ant_F. dB/m	Cab_L. dB	PreAmpl dB	Emission dBuV/m	Limit dBuV/m	Margin dB	A.Tower cm	T.Table deg
1222.28	61.56 pk	25.52	2.20	34.05	55.23 pk	74.00 pk	-18.77	102	97
1222.28	50.33 av	25.52	2.20	34.05	44.00 av	54.00 av	-10.00	102	97
1796.7	59.83 pk	29.29	2.45	34.78	56.79 pk	74.00 pk	-17.21	100	57
1796.7	48.60 av	29.29	2.45	34.78	45.56 av	54.00 av	-8.44	100	57
4818.18	44.66 pk	34.11	5.14	37.71	46.19 pk	54.00 av	-7.81	100	18
7222.78	40.42 pk	38.09	3.85	36.85	45.51 pk	54.00 av	-8.49	101	142

1GHz~ 25 GHz (Vertical), Channel 1: 2412 MHz

Operator: Jerry Chiou

RBW: 1MHz
Humidity (%): 39
Temperature (C): 22

Frequency MHz	Rx_R. dBuV	Ant_F. dB/m	Cab_L. dB	PreAmpl dB	Emission dBuV/m	Limit dBuV/m	Margin dB	A.Tower cm	T.Table deg
4824.04	52.73 pk	34.11	5.14	37.71	54.27 pk	74.00 pk	-19.73	100	18
4824.04	49.75 av	34.11	5.14	37.71	51.29 av	54.00 av	-2.71	100	18

Note:

- According to the standards used, Where limits are specified by agencies for both average and peak (or quasi-peak) detection , if the peak (or quasi-peak) measured value complies with the average limit , it is unnecessary to perform an average measurement.
- “ * ”: Fundamental Frequency
- “***”: Not in the restricted band, Limit level=Fundamental Emission-20dB
- “ pk”: peak mode
- “av”: average mode
- “---“: No meter reading data due to the emission level is smaller than spectrum noise level.
- The Spectrum noise level+Correction Factor < Limit - 6 dB
- Margin=Corrected Amplitude – Limit
- Corrected Amplitude=Radiated Amplitude+Antenna Correction Factor+Cable Loss-Pre-Amplifier Gain
- A margin of -8dB means that the emission is 8dB below the limit.

All frequencies from 1GHz to 25 GHz have been tested.

1GHz~ 25 GHz (Horizontal) , Channel 6 : 2437 MHz

Operator: Jerry Chiou

RBW: 1MHz
Humidity (%): 39
Temperature (C): 22

Frequency	Rx_R.	Ant_F.	Cab_L.	PreAmpl	Emission	Limit	Margin	A.Tower	T.Table
MHz	dBuV	dB/m	dB	dB	dBuV/m	dBuV/m	dB	cm	deg
1796.7	60.80 pk	29.29	2.45	34.78	57.76 pk	74.00 pk	-16.24	100	57
1796.7	47.56 av	29.29	2.45	34.78	44.52 av	54.00 av	-9.48	100	57
4861.64	45.38 pk	34.27	5.13	37.76	47.03 pk	54.00 av	-6.97	100	14

1GHz~ 25 GHz (Vertical), Channel 6 : 2437 MHz

Operator: Jerry Chiou

RBW: 1MHz
Humidity (%): 39
Temperature (C): 22

Frequency	Rx_R.	Ant_F.	Cab_L.	PreAmpl	Emission	Limit	Margin	A.Tower	T.Table
MHz	dBuV	dB/m	dB	dB	dBuV/m	dBuV/m	dB	cm	deg
4873.97	53.54 pk	34.27	5.13	37.76	55.19 pk	74.00 pk	-18.81	100	14
4873.97	49.92 av	34.27	5.13	37.76	51.57 av	54.00 av	-2.43	100	14

Note:

- According to the standards used, Where limits are specified by agencies for both average and peak (or quasi-peak) detection , if the peak (or quasi-peak) measured value complies with the average limit , it is unnecessary to perform an average measurement.
- “ * ”: Fundamental Frequency
- “**”: Not in the restricted band, Limit level=Fundamental Emission-20dB
- “ pk”: peak mode
- “av”: average mode
- “---“: No meter reading data due to the emission level is smaller than spectrum noise level.
- The Spectrum noise level+Correction Factor < Limit - 6 dB
- Margin=Corrected Amplitude – Limit
- Corrected Amplitude=Radiated Amplitude+Antenna Correction Factor+Cable Loss-Pre-Amplifier Gain
- A margin of -8dB means that the emission is 8dB below the limit.

All frequencies from 1GHz to 25 GHz have been tested.

1GHz~ 25 GHz (Horizontal), Channel 11: 2462 MHz

Operator: Jerry Chiou

RBW: 1MHz
Humidity (%): 39
Temperature (C): 22

Frequency MHz	Rx_R. dBuV	Ant_F. dB/m	Cab_L. dB	PreAmpl dB	Emission dBuV/m	Limit dBuV/m	Margin dB	A.Tower cm	T.Table deg
1791.71	60.57 pk	29.25	2.45	34.77	57.49 pk	74.00 pk	-16.51	100	57
1791.71	47.33 av	29.25	2.45	34.77	44.25 av	54.00 av	-9.75	100	57
2233.77	59.98 pk	30.95	1.89	35.19	57.63 pk	74.00 pk	-16.37	101	116
2230.12	53.63 av	30.95	1.89	35.19	49.18 av	54.00 av	-4.82	101	116
2775.72	59.49 pk	31.01	1.41	34.95	56.96 pk	74.00 pk	-17.04	102	287
2778.05	53.29 av	31.01	1.41	34.95	50.76 av	54.00 av	-3.24	102	287

1GHz~ 25 GHz (Vertical), Channel 11 : 2462 MHz

Operator: Jerry Chiou

RBW: 1MHz
Humidity (%): 39
Temperature (C): 22

Frequency MHz	Rx_R. dBuV	Ant_F. dB/m	Cab_L. dB	PreAmpl dB	Emission dBuV/m	Limit dBuV/m	Margin dB	A.Tower cm	T.Table deg
4919.58	51.87 pk	34.49	5.13	37.82	53.67 pk	54.00 av	-0.33	100	8

Note:

- According to the standards used, Where limits are specified by agencies for both average and peak (or quasi-peak) detection , if the peak (or quasi-peak) measured value complies with the average limit , it is unnecessary to perform an average measurement.
- “ * ”: Fundamental Frequency
- “**”: Not in the restricted band, Limit level=Fundamental Emission-20dB
- “pk”: peak mode
- “av”: average mode
- “---”: No meter reading data due to the emission level is smaller than spectrum noise level.
- The Spectrum noise level+Correction Factor < Limit - 6 dB
- Margin=Corrected Amplitude – Limit
- Corrected Amplitude=Radiated Amplitude+Antenna Correction Factor+Cable Loss-Pre-Amplifier Gain
- A margin of -8dB means that the emission is 8dB below the limit.

All frequencies from 1GHz to 25 GHz have been tested.

5.5 Band Edge Measurement

5.5.1 Test Procedure (Conducted)

1. The transmitter output of EUT was connected to the spectrum analyzer.
Equipment mode: Spectrum analyzer
Detector function: Peak mode
SPAN: 100MHz
RBW: 100KHz
VBW: 100KHz
Center frequency: 2.4GHz, 2.4835GHz.
2. Using Peak Search to read the peak power of Carrier frequencies after Maximum Hold function is completed
3. Find the next peak frequency outside the operation frequency band

5.5.2 Test Setup (Conducted)

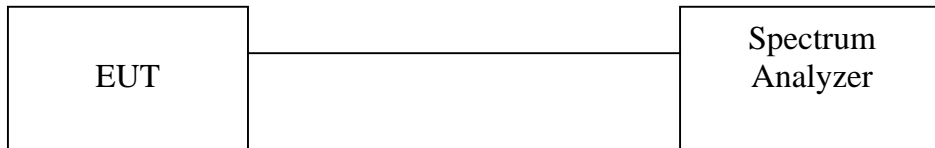

5.5.3 Test Data:

Please refer to ISL report 04LR018FC

5.5.4 Test Procedure (Radiated)

1. Antenna and Turntable test procedure same as Radiated Emission Measurement.
Equipment mode: Spectrum analyzer
Detector function: Peak mode
SPAN: 100MHz
RBW: 1MHz
VBW: 3MHz
Center frequency: 2.395GHz, 2.48GHz.
2. Using Peak Search to read the peak power of Carrier frequencies after Maximum Hold function is completed.
3. Find the next peak frequency outside the operation frequency band
4. For peak frequency emission level measurement in Restricted Band
Change RBW: 1MHz
VBW: 10Hz
Span: 100MHz.
5. Get the spectrum reading after Maximum Hold function is completed.

5.5.5 Test Setup (Radiated)

Same as *Radiated Emission Measurement*

5.5.6 Test Data

Table Band Edge measurement (Radiated)

Temp. (deg. C): 25
 Humidity (%): 50

Test Engr: Jerry Chiou

Description	Frequency (MHz)	Spectrum Reading (dBuV)	Correction Factor (dB/m)	Emission Level (dBuV/m)	dBc (Limit: > 20dBc)	Limit (dBuV/m)	Equip. Setup VBW	Pass or Fail
Channel_1 (average mode)	2412.8	70.93	35.48	106.41	---	---	10Hz	---
Channel_1 (peak mode)	2412.8	76.03	35.48	111.51	---	---	3MHz	---
Outside band (peak mode)	2398.7	40.95	35.48	76.43	35.08	---	3MHz	Pass
Channel_11 (average mode)	2463.7	70.51	35.5	106.01	---	---	10Hz	---
Channel_11 (peak mode)	2460.3	75.08	35.5	110.58	---	---	3MHz	---
Outside band (peak mode)	2476	38.13	35.51	73.64	36.94	---	3MHz	Pass
Channel_1 Restricted band (peak mode)	2385	37.34	35.47	72.81	---	74	3MHz	Pass
Restricted band (average mode)	2385.9	15.55	35.47	51.02	---	54	10Hz	Pass
Channel_11 Restricted band (peak mode)	2484.2	33.37	35.51	68.88	---	74	3MHz	Pass
Restricted band (average mode)	2484.2	10.87	35.51	46.38	---	54	10Hz	Pass

Note:

- The Spectrum plot of emission level measurement in Restricted band is attached.
- Emission Level=Spectrum Reading+Correction Factor
- Correction Factor=Antenna Factor+cable loss–amplifier gain
- Both Horizontal and Vertical polarizaion have been tested and the worst data is listed above.

Band Edge measurement for radiated emission in Restricted Band(Radiated) Peak Mode (Channel 1)

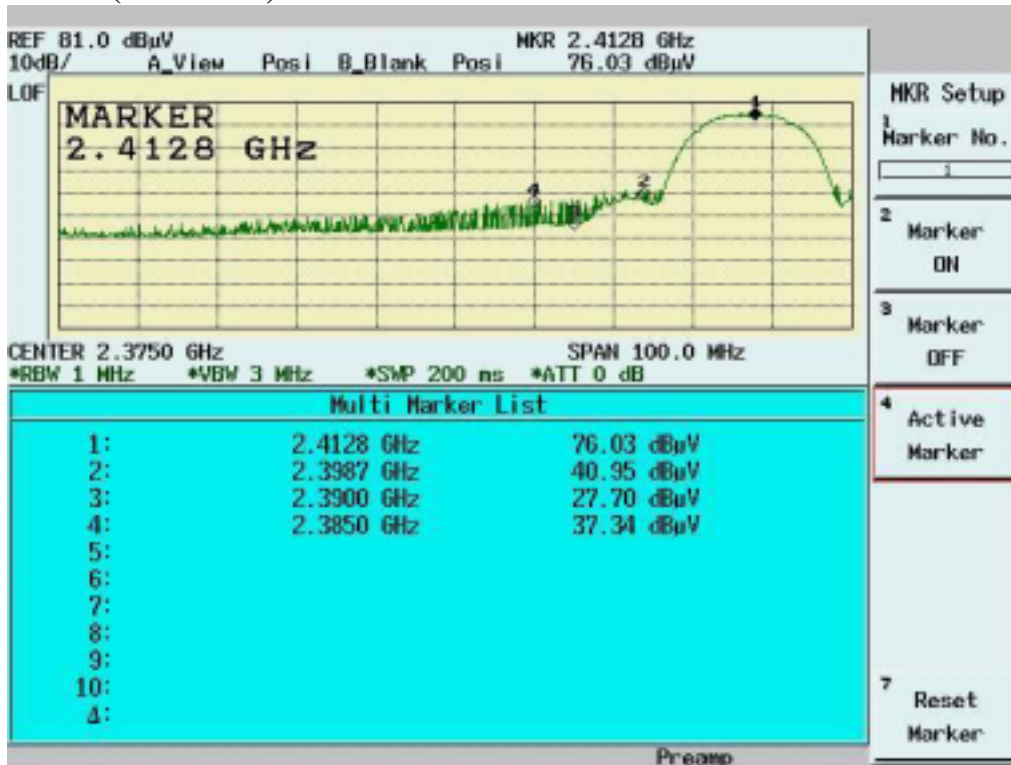

Band Edge measurement for radiated emission in Restricted Band(Radiated) Average Mode (Channel 1)

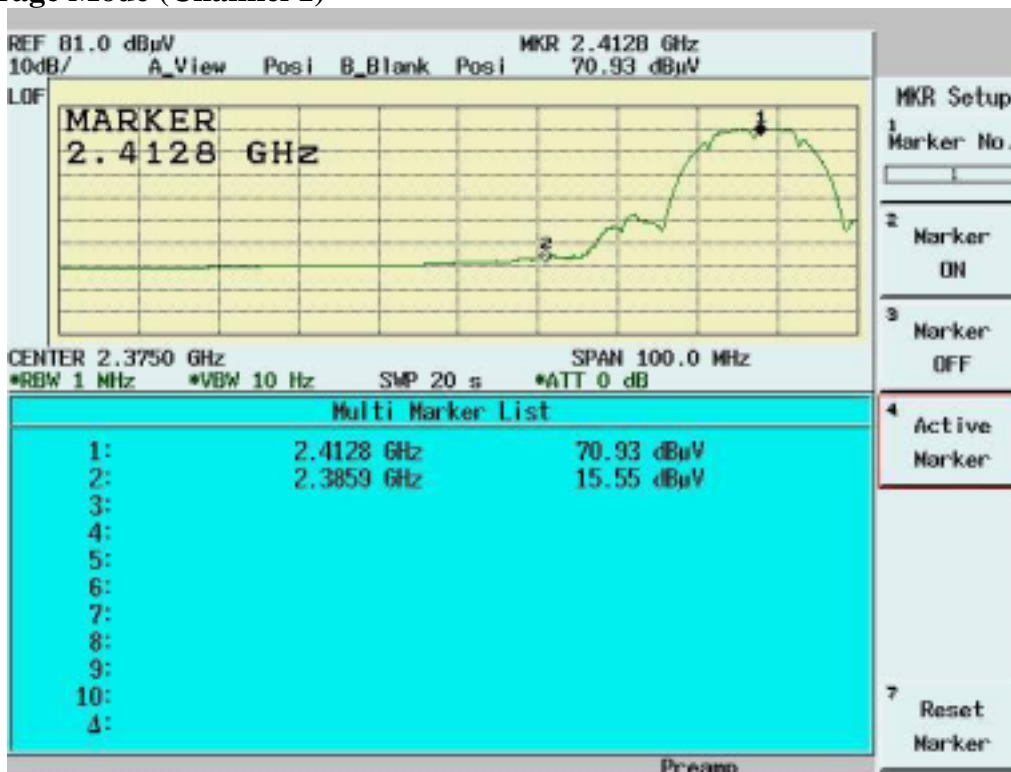

Band Edge measurement for radiated emission in Restricted Band(Radiated) Peak Mode (Channel 11)

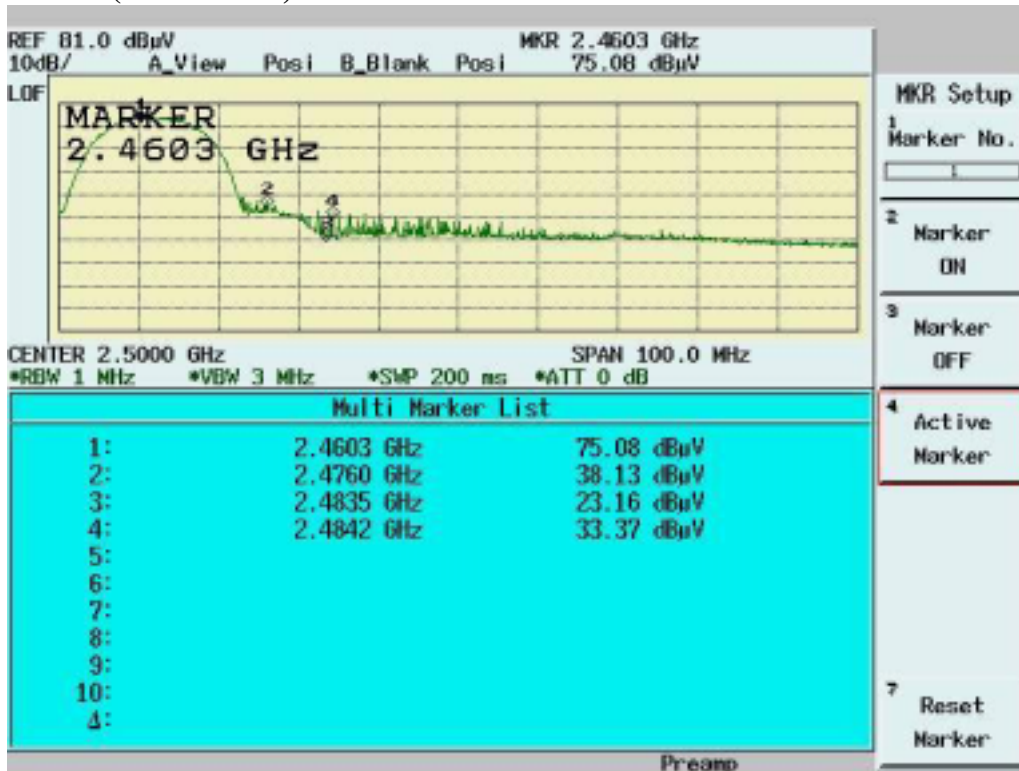

Band Edge measurement for radiated emission in Restricted Band(Radiated) Average Mode (Channel 11)

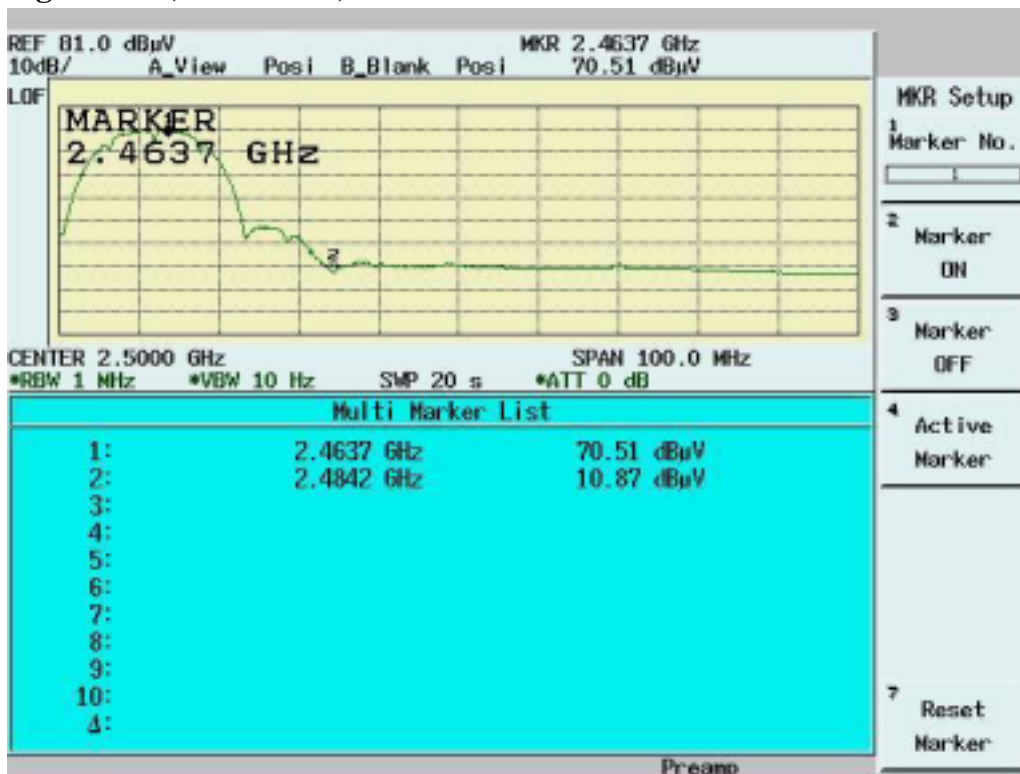



5.6 RF Exposure Measurement [Section 15.247(b)(4) & 1.1307(b)]

See MPE report

5.7 DSSS Peak Power Spectral Density [Section 15.247(d)]

5.7.1 Test Procedure

1. The Transmitter output of EUT was connected to the spectrum analyzer.
Equipment mode: Spectrum analyzer
Detector function: Peak mode
SPAN: 1.5MHz
RBW: 3KHz
VBW: 30KHz
Center frequency: fundamental frequency tested.
Sweep time= 500 sec.
2. Using Peak Search to read the peak power after Maximum Hold function is completed.

5.7.2 Test Setup



5.7.3 Test Data

Please refer to ISL report 04LR018FC

6. TEST RESULTS (802.11g)

6.1 Powerline Conducted Emissions [Section 15.207]

6.1.1 EUT Configuration

The EUT was set up on the non-conductive table that is 1.0 by 1.5 meter, 80cm above ground. The wall of the shielded room was located 40cm to the rear of the EUT.

Power to the EUT was provided through the LISN. The impedance vs. frequency characteristic of the LISN is complied with the limit used.

Both lines (neutral and hot) were connected to the LISN in series at testing. A coaxial-type connector which provides one 50 ohms terminating impedance was provided for connecting the test instrument. The excess length of the power cord was folded back and forth at the center of the lead so as to form a bundle not exceeding 40cm in length.

Any changes made to the configuration, or modifications made to the EUT, during testing are noted in the following test record.

If the EUT is a Personal Computer or a peripheral of personal computer, and the personal computer has an auxiliary AC outlet which can be used for providing power to an external monitor, then all measurements will be made with the monitor power from first the computer-mounted AC outlet and then a floor-mounted AC outlet.

6.1.2 Test Procedure

The system was set up as described above, with the EMI diagnostic software running. The main power line conducted EMI tests were run on the hot and neutral conductors of the power cord and the results were recorded. The effect of varying the position of the interface cables has been investigated to find the configuration that produces maximum emission.

At the frequencies where the peak values of the emissions were higher than 6dB below the applicable limits, the emissions were also measured with the quasi-peak detectors. At the frequencies where the quasi-peak values of the emissions were higher than 6dB below the applicable average limits, the emissions were also measured with the average detectors.

The highest emissions were analyzed in details by operating the spectrum analyzer in fixed tuned mode to determine the nature of the emissions and to provide information which could be useful in reducing their amplitude.

6.1.3 EMI Receiver/Spectrum Analyzer Configuration (for the frequencies tested)

Frequency Range	150 KHz--30MHz
Detector Function	Quasi-Peak/Average
Bandwidth (RBW)	9KHz

6.1.4 Test Data:

Power Line Conducted Emissions (Hot) Channel 1, 6, 11

Operator: Jerry Chiou
 Temperature (C): 22
 Humidity (%): 56

Frequency MHz	LISN Loss (dB)	Cable Loss (dB)	QP Corrc. Amp.(dBuV)	QP Limit (dBuV)	QP Margin (dB)	AVE Corrc. Amp.(dBuV)	AVE Limit (dBuV)	AVE Margin (dB)
0.53828	0.12	0.03	30.44	56.00	-25.56	27.36	46.00	-18.64
0.6683	0.14	0.04	32.66	56.00	-23.34	30.64	46.00	-15.36
0.73431	0.16	0.05	31.14	56.00	-24.86	28.12	46.00	-17.88
0.86946	0.18	0.06	33.28	56.00	-22.72	30.88	46.00	-15.12
0.93993	0.19	0.07	29.46	56.00	-26.54	24.31	46.00	-21.69
10.9046	0.55	0.20	47.46	60.00	-12.54	43.01	50.00	-6.99
13.9134	0.66	0.27	47.69	60.00	-12.31	42.33	50.00	-7.67
14.2884	0.67	0.28	38.92	60.00	-21.08	32.35	50.00	-17.65
14.4344	0.68	0.29	41.35	60.00	-18.65	34.07	50.00	-15.93
14.6037	0.69	0.29	38.30	60.00	-21.70	31.74	50.00	-18.26

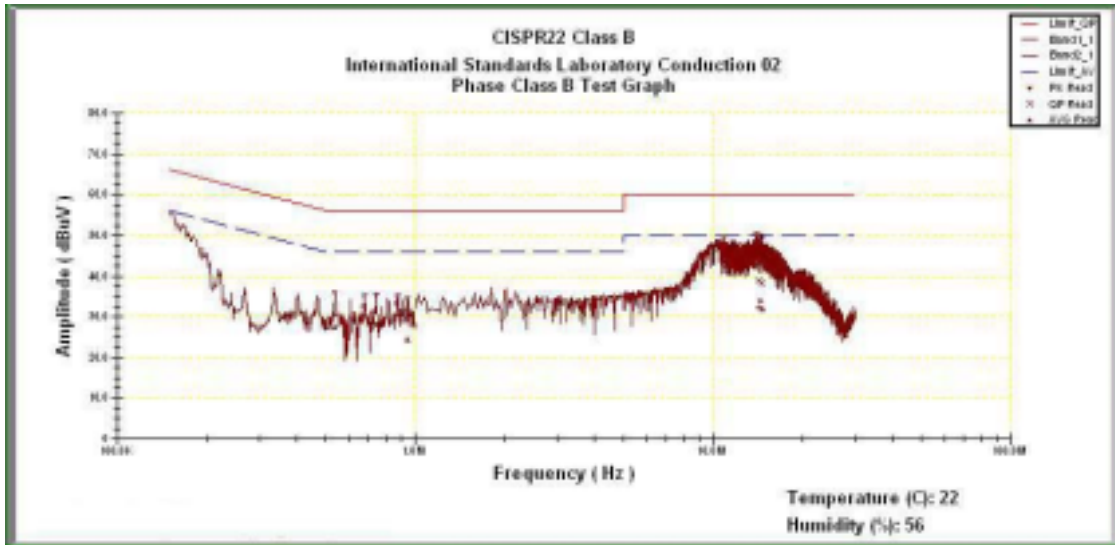

Power Line Conducted Emissions (Neutral) Channel 1, 6, 11

Operator: Jerry Chiou

Temperature (C): 22

Humidity (%): 56

Frequency	LISN Loss	Cable Loss	QP Corrcr.	QP Limit	QP Margin	AVE Corrcr.	AVE Limit	AVE Margin
MHz	(dB)	(dB)	Amp.(dBuV)	(dBuV)	(dB)	Amp.(dBuV)	(dBuV)	(dB)
0.19138	0.10	0.02	55.21	64.82	-9.61	37.26	54.82	-17.56
0.22916	0.10	0.02	49.56	63.74	-14.18	29.72	53.74	-24.02
0.29223	0.10	0.02	42.60	61.94	-19.34	22.29	51.94	-29.65
0.45818	0.11	0.03	33.43	57.19	-23.77	16.38	47.19	-30.82
0.482	0.11	0.03	33.04	56.51	-23.47	14.85	46.51	-31.67
10.491	0.32	0.19	48.06	60.00	-11.94	43.70	50.00	-6.30
10.9588	0.33	0.20	48.22	60.00	-11.78	43.60	50.00	-6.40
11.0265	0.33	0.20	48.04	60.00	-11.96	43.63	50.00	-6.37
11.1362	0.33	0.21	38.20	60.00	-21.80	31.09	50.00	-18.91
14.2993	0.39	0.28	47.25	60.00	-12.75	42.02	50.00	-7.98

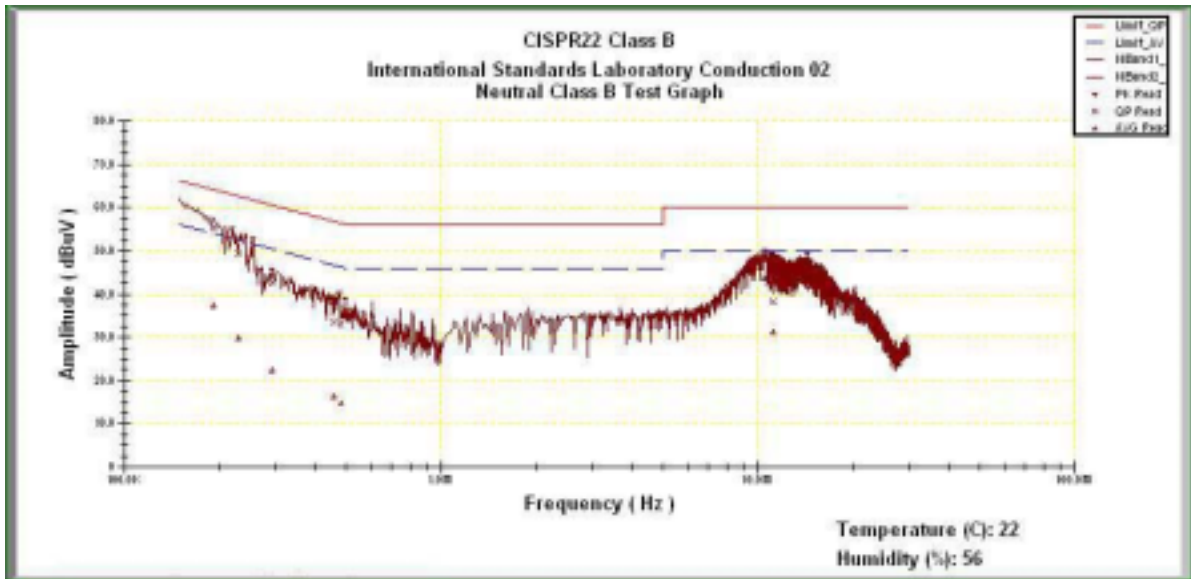

* NOTE: During the test, the EMI receiver was set to Max. Hold then switch the EUT Channel between 1 , 6, 11 to get the maximum reading of all these channels.
 Margin = Amplitude + Insertion Loss- Limit
 A margin of -8dB means that the emission is 8dB below the limit

6.2 Bandwidth for DSSS [Section 15.247 (a)(2)]

6.2.1 Test Procedure

The Transmitter output of EUT was connected to the spectrum analyzer. The 6 dB bandwidth of the fundamental frequency was measured. The setting of spectrum analyzer is as follows

Equipment mode	Spectrum analyzer
Detector function	Peak mode
RBW	100KHz
VBW	100KHz

6.2.2 Test Setup

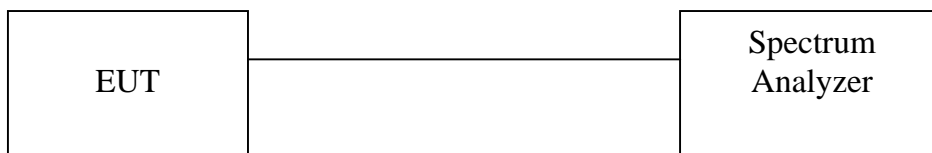

6.2.3 Test Data:

Please refer to ISL report 04LR018FC

6.3 DSSS Maximum Peak Output Power [Section 15.247 (b)(1)]

6.3.1 Test Procedure

The Transmitter output of EUT was connected to the peak power analyzer.

6.3.2 Test Setup

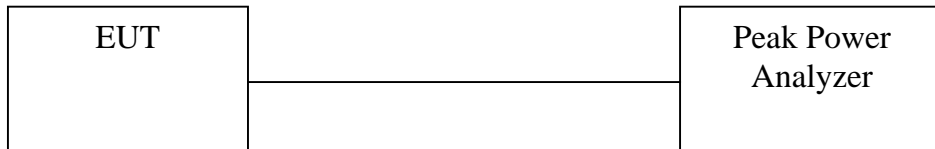

6.3.3 Test Data

Please refer to ISL report 04LR018FC

6.4 Radiated Emission Measurement [Section [15.247(c)(4)]

6.4.1 EUT Configuration

The equipment under test was set up on the 10 meter chamber with measurement distance of 3 meters. The EUT was placed on a non-conductive table 80cm above ground.

Any changes made to the configuration, or modifications made to the EUT, during testing are noted in the following test record.

6.4.2 Test Procedure

The system was set up as described above, with the EMI diagnostic software running. We found the maximum readings by varying the height of antenna and then rotating the turntable. Both polarization of antenna, horizontal and vertical, are measured.

30M to 1GHz: The highest emissions between 30 MHz to 1000 MHz were also analyzed in details by operating the spectrum analyzer and/or EMI receiver in quasi-peak mode to determine the precise amplitude of the emissions. While doing so, the interconnecting cables and major parts of the system were moved around, the antenna height was varied between one and four meters, its polarization was varied between vertical and horizontal, and the turntable was slowly rotated, to maximize the emission.

1GHz – 25GHz: The highest emissions were also analyzed in details by operating the spectrum analyzer and/or EMI receiver in peak mode to determine the precise amplitude of the emission. While doing so, the interconnecting cables and major parts of the system were moved around, the antenna height was varied between one and four meters, its polarization was varied between vertical and horizontal, and the turntable was slowly rotated, to maximize the emission. During test the EMI receiver and spectrum was setup according to *EMI Receiver/Spectrum Analyzer Configuration*.

For the test of 2nd to 10th harmonics frequencies, the equipment setup was also refer to *EMI Receiver/Spectrum Analyzer Configuration*. The frequencies were tested using Peak mode first, if the test data is higher than the emissions limit, an additional measurement using Average mode will be performed and the average reading will be compared to the limit and record in test report.

6.4.3 EMI Receiver/Spectrum Analyzer Configuration (for the frequencies tested)

Frequency Range Tested:	30MHz~1000MHz
Detector Function:	Quasi-Peak Mode
Resolution Bandwidth (RBW):	120KHz
Video Bandwidth (VBW)	1MHz
Frequency Range Tested:	1GHz – 25 GHz
Detector Function:	Peak Mode
Resolution Bandwidth (RBW):	1MHz
Video Bandwidth (VBW)	3MHz
Frequency Range Tested:	1GHz – 25 GHz
Detector Function:	Average Mode
Resolution Bandwidth (RBW):	1MHz
Video Bandwidth (VBW)	10 Hz

6.4.4 Test Data (30MHz – 1GHz):

30M – 1GHz Open Field Radiated Emissions (Horizontal) Channel 1, 6, 11

Operator: Jerry Chiou

Humidity (%): 46
Temperature (C): 25

Frequency MHz	Rx_R. dBuV	Ant_F. dB/m	Cab_L. dB	PreAmpl dB	Emission dBuV/m	Limit dBuV/m	Margin dB	A.Tower cm	T.Table deg
99.84	22.02	10.27	3.02	0.00	35.31	43.50	-8.19	100.00	31.00
198.78	25.45	8.86	4.18	0.00	38.49	43.50	-5.01	100.00	55.00
232.73	27.43	9.33	4.50	0.00	41.26	46.00	-4.74	100.00	55.00
298.69	21.57	13.57	4.69	0.00	39.84	46.00	-6.16	100.00	236.00
365.62	22.02	14.83	5.08	0.00	41.92	46.00	-4.08	100.00	285.00
397.63	20.39	15.92	5.30	0.00	41.61	46.00	-4.39	100.00	301.00
431.58	18.85	16.25	5.61	0.00	40.71	46.00	-5.29	100.00	219.00
465.53	14.70	16.80	5.88	0.00	37.38	46.00	-8.62	100.00	31.00
489.78	18.78	17.43	5.99	0.00	42.21	46.00	-3.79	100.00	31.00
563.5	13.73	19.05	6.56	0.00	39.33	46.00	-6.67	100.00	170.00

30M – 1GHz Open Field Radiated Emissions (Vertical) Channel 1, 6, 11

Operator: Jerry Chiou

Humidity (%): 46
Temperature (C): 25

Frequency MHz	Rx_R. dBuV	Ant_F. dB/m	Cab_L. dB	PreAmpl dB	Emission dBuV/m	Limit dBuV/m	Margin dB	A.Tower cm	T.Table deg
133.79	18.07	11.02	3.52	0.00	32.61	43.50	-10.89	100.00	298.00
364.65	15.85	14.80	5.07	0.00	35.72	46.00	-10.28	100.00	266.00
431.58	13.48	16.25	5.61	0.00	35.34	46.00	-10.66	100.00	266.00
489.78	16.84	17.43	5.99	0.00	40.26	46.00	-5.74	100.00	233.00
498.51	13.65	17.66	6.04	0.00	37.35	46.00	-8.65	100.00	298.00
643.04	9.86	19.07	7.00	0.00	35.94	46.00	-10.06	100.00	282.00
651.77	14.16	19.10	7.04	0.00	40.30	46.00	-5.70	100.00	298.00
662.44	8.76	19.08	7.07	0.00	34.90	46.00	-11.10	100.00	315.00
696.39	7.79	19.01	7.34	0.00	34.14	46.00	-11.86	100.00	315.00
864.2	7.11	20.54	8.24	0.00	35.89	46.00	-10.11	100.00	68.00

NOTE:

- During the Pre-test, the EUT has been tested for Channel 1, 6, 11 transmit from Main and Aux antenna respectively to get all the critical emission frequencies. In the final test all the critical emission frequencies has been tested and the test data are listed above.
- Margin = Corrected Amplitude – Limit
Corrected Amplitude = Radiated Amplitude + Antenna Correction Factor + Cable Loss - Pre-Amplifier Gain
A margin of -8dB means that the emission is 8dB below the limit

All frequencies from 30MHz to 1GHz have been tested

6.4.5 Test Data (1GHz – 25 GHz) .

1GHz~ 25 GHz (Horizontal), Channel 1: 2412 MHz

Operator: Jerry Chiou

RBW: 1MHz
Humidity (%): 39
Temperature (C): 22

Frequency MHz	Rx_R. dBuV	Ant_F. dB/m	Cab_L. dB	PreAmpl dB	Emission dBuV/m	Limit dBuV/m	Margin dB	A.Tower cm	T.Table deg
1209.79	57.42 pk	25.47	2.20	34.04	51.04 pk	54.00 av	-2.96	102	98
1227.27	57.04 pk	25.55	2.20	34.05	50.73 pk	54.00 av	-3.27	102	96
1796.7	59.83 pk	29.29	2.45	34.78	56.79 pk	74.00 pk	-17.21	100	57
1796.7	48.60 av	29.29	2.45	34.78	45.56 av	54.00 av	-8.44	100	57
2358.64	54.65 pk	30.93	1.51	35.19	51.89 pk	54.00 av	-2.11	101	156
7222.78	44.99 pk	38.09	3.85	36.85	50.08 pk	54.00 av	-3.92	101	142

1GHz~ 25 GHz (Vertical), Channel 1: 2412 MHz

Operator: Jerry Chiou

RBW: 1MHz
Humidity (%): 39
Temperature (C): 22

Frequency MHz	Rx_R. dBuV	Ant_F. dB/m	Cab_L. dB	PreAmpl dB	Emission dBuV/m	Limit dBuV/m	Margin dB	A.Tower cm	T.Table deg
1237.26	60.16 pk	25.59	2.20	34.06	53.90 pk	54.00 av	-0.10	102	96
2198.8	55.91 pk	30.96	1.99	35.19	53.68 pk	54.00 av	-0.32	101	105
2318.68	55.92 pk	30.94	1.63	35.19	53.29 pk	54.00 av	-0.71	101	143
4818.18	49.08 pk	34.11	5.14	37.71	50.62 pk	54.00 av	-3.38	100	18
7222.78	46.33 pk	38.09	3.85	36.85	51.41 pk	54.00 av	-2.59	101	142

Note:

- According to the standards used, Where limits are specified by agencies for both average and peak (or quasi-peak) detection , if the peak (or quasi-peak) measured value complies with the average limit , it is unnecessary to perform an average measurement.
- “ * ”: Fundamental Frequency
- “***”: Not in the restricted band, Limit level=Fundamental Emission-20dB
- “ pk” : peak mode
- “ av” : average mode
- “---“: No meter reading data due to the emission level is smaller than spectrum noise level.
- The Spectrum noise level+Correction Factor < Limit - 6 dB
- Margin=Corrected Amplitude – Limit
- Corrected Amplitude=Radiated Amplitude+Antenna Correction Factor+Cable Loss-Pre-Amplifier Gain
- A margin of -8dB means that the emission is 8dB below the limit.

All frequencies from 1GHz to 25 GHz have been tested.

1GHz~ 25 GHz (Horizontal) , Channel 6 : 2437 MHz

Operator: Jerry Chiou

RBW: 1MHz
Humidity (%): 39
Temperature (C): 22

Frequency	Rx_R.	Ant_F.	Cab_L.	PreAmpl	Emission	Limit	Margin	A.Tower	T.Table
MHz	dBuV	dB/m	dB	dB	dBuV/m	dBuV/m	dB	cm	deg
1796.7	60.80 pk	29.29	2.45	34.78	57.76 pk	74.00 pk	-16.24	100	57
1796.7	47.56 av	29.29	2.45	34.78	44.52 av	54.00 av	-9.48	100	57
7295.2	45.29 pk	38.38	3.88	36.72	50.83 pk	54.00 av	-3.17	101	152

1GHz~ 25 GHz (Vertical), Channel 6 : 2437 MHz

Operator: Jerry Chiou

RBW: 1MHz
Humidity (%): 39
Temperature (C): 22

Frequency	Rx_R.	Ant_F.	Cab_L.	PreAmpl	Emission	Limit	Margin	A.Tower	T.Table
MHz	dBuV	dB/m	dB	dB	dBuV/m	dBuV/m	dB	cm	deg
1794.21	57.03 pk	29.27	2.45	34.78	53.98 pk	54.00 av	-0.02	100	57
4876.12	50.98 pk	34.33	5.13	37.77	52.66 pk	54.00 av	-1.34	100	12
7309.69	45.84 pk	38.44	3.89	36.70	51.47 pk	54.00 av	-2.53	101	154

Note:

- According to the standards used, Where limits are specified by agencies for both average and peak (or quasi-peak) detection , if the peak (or quasi-peak) measured value complies with the average limit , it is unnecessary to perform an average measurement.
- “ * ”: Fundamental Frequency
- “***”: Not in the restricted band, Limit level=Fundamental Emission-20dB
- “ pk” : peak mode
- “ av” : average mode
- “---“: No meter reading data due to the emission level is smaller than spectrum noise level.
- The Spectrum noise level+Correction Factor < Limit - 6 dB
- Margin=Corrected Amplitude – Limit
- Corrected Amplitude=Radiated Amplitude+Antenna Correction Factor+Cable Loss-Pre-Amplifier Gain
- A margin of -8dB means that the emission is 8dB below the limit.

All frequencies from 1GHz to 25 GHz have been tested.

1GHz~ 25 GHz (Horizontal), Channel 11: 2462 MHz

Operator: Jerry Chiou

RBW: 1MHz
Humidity (%): 39
Temperature (C): 22

Frequency MHz	Rx_R. dBuV	Ant_F. dB/m	Cab_L. dB	PreAmpl dB	Emission dBuV/m	Limit dBuV/m	Margin dB	A.Tower cm	T.Table deg
1791.71	60.57 pk	29.25	2.45	34.77	57.49 pk	74.00 pk	-16.51	100	57
1791.71	47.33 av	29.25	2.45	34.77	44.25 av	54.00 av	-9.75	100	57
2118.88	50.88 pk	30.98	2.24	35.18	48.91 pk	54.00 av	-5.09	100	80
2321.18	53.35 pk	30.94	1.62	35.19	50.71 pk	54.00 av	-3.29	101	144
2398.6	53.94 pk	30.92	1.46	35.20	51.12 pk	54.00 av	-2.88	101	168
7367.63	46.69 pk	38.67	3.92	36.60	52.68 pk	54.00 av	-1.32	101	163

1GHz~ 25 GHz (Vertical), Channel 11 : 2462 MHz

Operator: Jerry Chiou

RBW: 1MHz
Humidity (%): 39
Temperature (C): 22

Frequency MHz	Rx_R. dBuV	Ant_F. dB/m	Cab_L. dB	PreAmpl dB	Emission dBuV/m	Limit dBuV/m	Margin dB	A.Tower cm	T.Table deg
1549.45	57.25 pk	27.22	2.27	34.30	52.44 pk	54.00 av	-1.56	101	74
2253.75	54.63 pk	30.95	1.83	35.19	52.22 pk	54.00 av	-1.78	101	123
4919.58	53.29 pk	34.49	5.13	37.82	55.09 pk	74.00 pk	-18.91	100	8
4919.58	40.05 av	34.49	5.13	37.82	41.85 av	54.00 av	-12.15	100	8
7367.63	49.99 pk	38.67	3.92	36.60	55.99 pk	74.00 pk	-18.01	101	163
7367.63	33.95 av	38.67	3.92	36.60	39.95 av	54.00 av	-14.05	101	163

Note:

- According to the standards used, Where limits are specified by agencies for both average and peak (or quasi-peak) detection , if the peak (or quasi-peak) measured value complies with the average limit , it is unnecessary to perform an average measurement.
- “ * ”: Fundamental Frequency
- “***”: Not in the restricted band, Limit level=Fundamental Emission-20dB
- “ pk ”: peak mode
- “ av ”: average mode
- “---“: No meter reading data due to the emission level is smaller than spectrum noise level.
- The Spectrum noise level+Correction Factor < Limit - 6 dB
- Margin=Corrected Amplitude – Limit
- Corrected Amplitude=Radiated Amplitude+Antenna Correction Factor+Cable Loss-Pre-Amplifier Gain
- A margin of -8dB means that the emission is 8dB below the limit.

All frequencies from 1GHz to 25 GHz have been tested.

6.5 Band Edge Measurement

6.5.1 Test Procedure (Conducted)

1. The transmitter output of EUT was connected to the spectrum analyzer.
Equipment mode: Spectrum analyzer
Detector function: Peak mode
SPAN: 100MHz
RBW: 100KHz
VBW: 100KHz
Center frequency: 2.4GHz, 2.4835GHz.
2. Using Peak Search to read the peak power of Carrier frequencies after Maximum Hold function is completed
3. Find the next peak frequency outside the operation frequency band

6.5.2 Test Setup (Conducted)

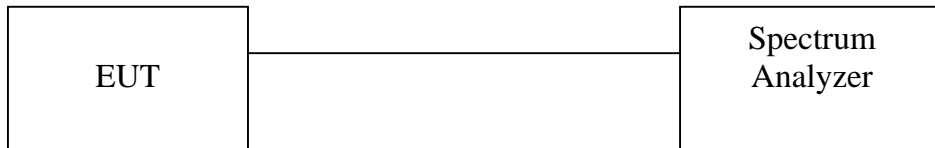

6.5.3 Test Data:

Please refer to ISL report 04LR018FC

6.5.4 Test Procedure (Radiated)

1. Antenna and Turntable test procedure same as Radiated Emission Measurement.
Equipment mode: Spectrum analyzer
Detector function: Peak mode
SPAN: 100MHz
RBW: 1MHz
VBW: 3MHz
Center frequency: 2.395GHz, 2.48GHz.
2. Using Peak Search to read the peak power of Carrier frequencies after Maximum Hold function is completed.
3. Find the next peak frequency outside the operation frequency band
4. For peak frequency emission level measurement in Restricted Band ,
Change RBW: 1MHz
VBW: 10Hz
Span: 100MHz.
5. Get the spectrum reading after Maximum Hold function is completed.

6.5.5 Test Setup (Radiated)

Same as *Radiated Emission Measurement*

6.5.6 Test Data

Table Band Edge measurement (Radiated)

Temp. (deg. C): 25
 Humidity (%): 50

Test Engr: Jerry Chiou

Description	Frequency (MHz)	Spectrum Reading (dBuV)	Correction Factor (dB/m)	Emission Level (dBuV/m)	dBc (Limit: > 20dBc)	Limit (dBuV/m)	Equip. Setup VBW	Pass or Fail
Channel_1 (average mode)	2417.7	64.12	35.48	99.6	---	---	10Hz	---
Channel_1 (peak mode)	2414.5	75.57	35.48	111.05	---	---	3MHz	---
Outside band (peak mode)	2393.6	45.61	35.48	81.09	29.96	---	3MHz	Pass
Channel_11 (average mode)	2460.3	64.09	35.5	99.59	---	---	10Hz	---
Channel_11 (peak mode)	2465.1	74.89	35.5	110.39	---	---	3MHz	---
Outside band (peak mode)	2477.3	44.47	35.51	79.98	30.41	---	3MHz	Pass
Channel_1 Restricted band (peak mode)	2389.9	38.01	35.47	73.48	---	74	3MHz	Pass
Restricted band (average mode)	2389.9	16.86	35.47	52.33	---	54	10Hz	Pass
Channel_11 Restricted band (peak mode)	2487	33.47	35.51	68.98	---	74	3MHz	Pass
Restricted band (average mode)	2487	11.03	35.51	46.54	---	54	10Hz	Pass

Note:

- The Spectrum plot of emission level measurement in Restricted band is attached.
- Emission Level=Spectrum Reading+Correction Factor
- Correction Factor=Antenna Factor+cable loss–amplifier gain
- Both Horizontal and Vertical polarizaion have been tested and the worst data is listed above.

Band Edge measurement for radiated emission in Restricted Band(Radiated) Peak Mode (Channel 1)

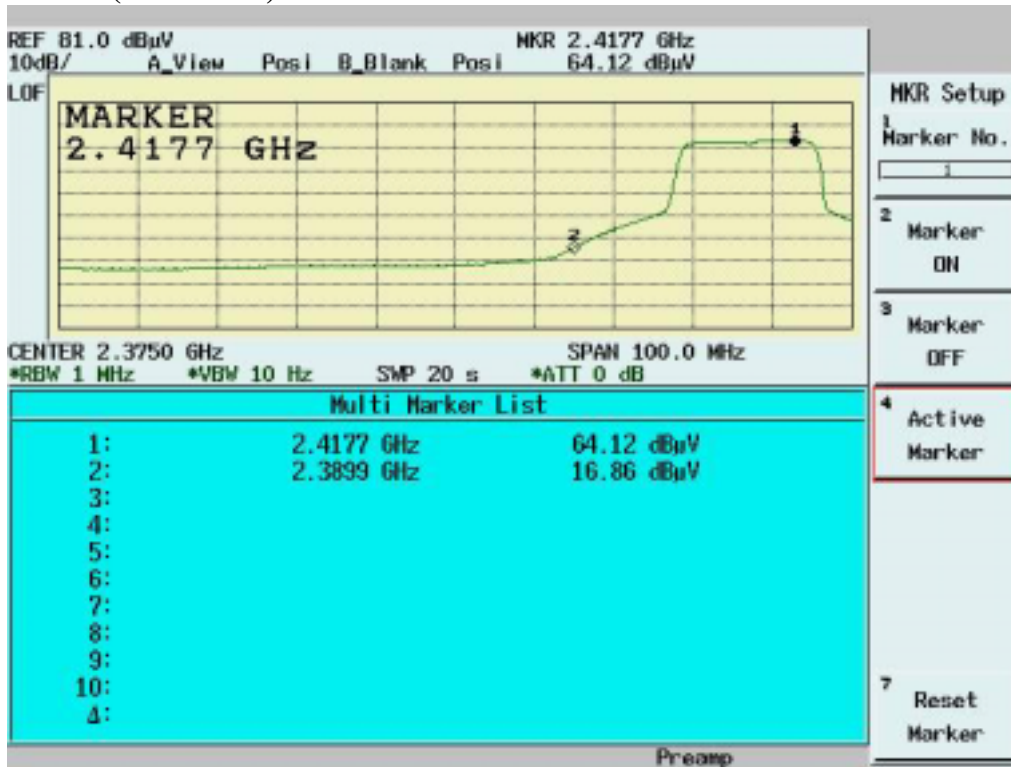

Band Edge measurement for radiated emission in Restricted Band(Radiated) Average Mode (Channel 1)

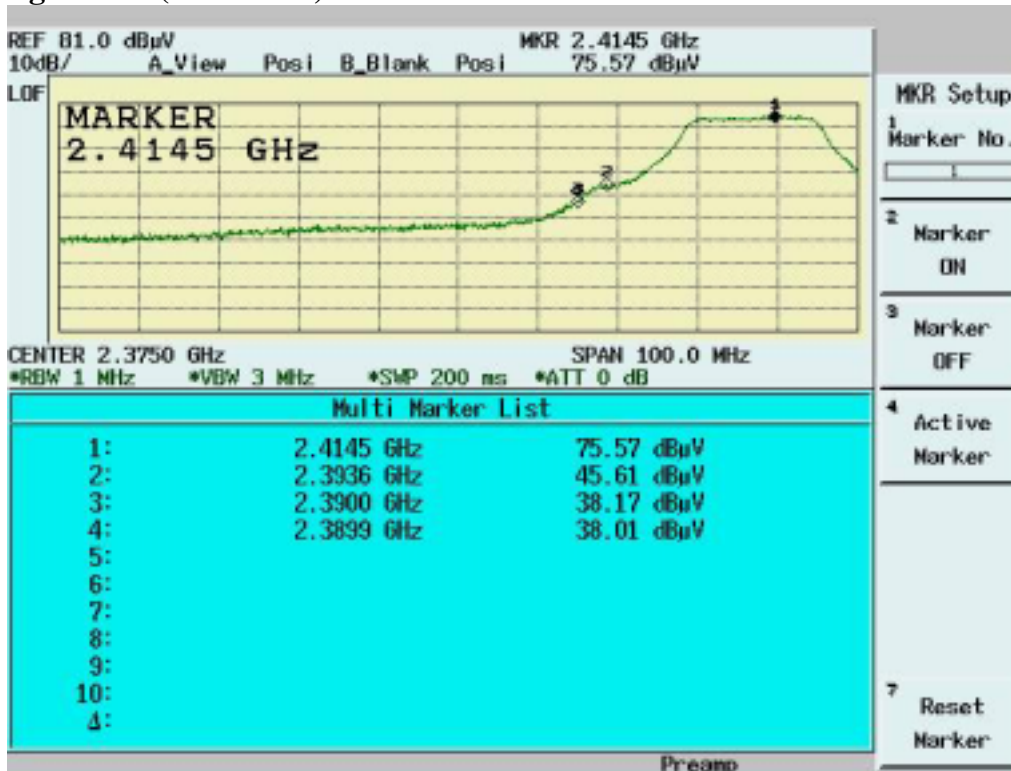

Band Edge measurement for radiated emission in Restricted Band(Radiated) Peak Mode (Channel 11)

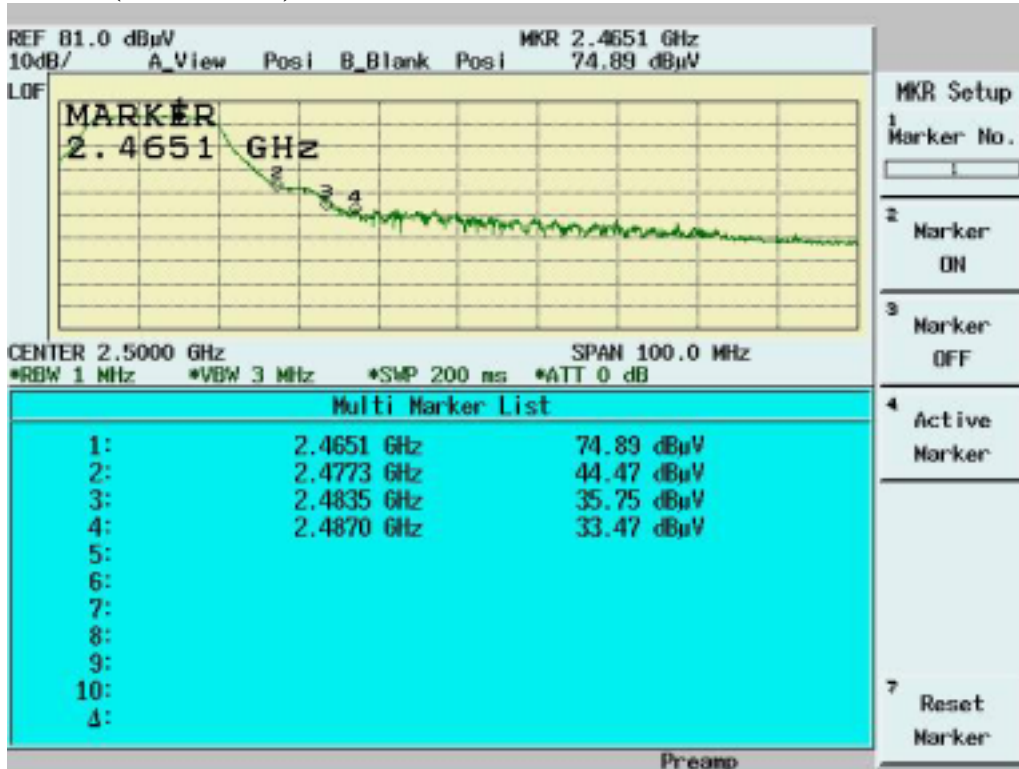

Band Edge measurement for radiated emission in Restricted Band(Radiated) Average Mode (Channel 11)

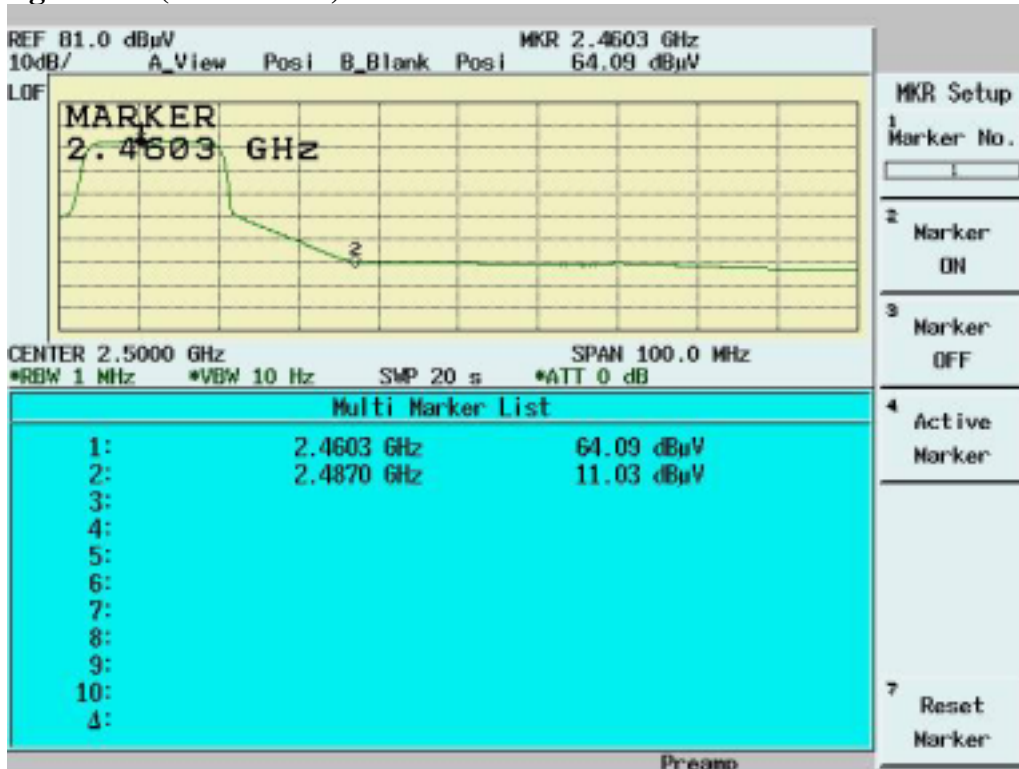



6.6 RF Exposure Measurement [Section 15.247(b)(4) & 1.1307(b)]

See MPE report

6.7 DSSS Peak Power Spectral Density [Section 15.247(d)]

6.7.1 Test Procedure

1. The Transmitter output of EUT was connected to the spectrum analyzer.
Equipment mode: Spectrum analyzer
Detector function: Peak mode
SPAN: 1.5MHz
RBW: 3KHz
VBW: 30KHz
Center frequency: fundamental frequency tested.
Sweep time= 500 sec.
2. Using Peak Search to read the peak power after Maximum Hold function is completed.

6.7.2 Test Setup



6.7.3 Test Data

Please refer to ISL report 04LR018FC

7. Appendix

7.1 Appendix A: Measurement Procedure for Power line Conducted Emissions

The measurements are performed in a 3.5m x 3.4m x 2.5m shielded room, which referred as Conduction 01 test site, or a 3m x 3m x 2.3m test site, which referred as Conduction 02 test site. The EUT was placed on non-conduction 1.0m x 1.5m table, which is 0.8 meters above an earth-grounded.

Power to the EUT was provided through the LISN which has the Impedance (50ohm/50uH) vs. Frequency Characteristic in accordance with the required standard. Power to the LISNs were filtered to eliminate ambient signal interference and these filters were bonded to the ground plane. Peripheral equipment required to provide a functional system (support equipment) for EUT testing was powered from the second LISN through a ganged, metal power outlet box which is bonded to the ground plane at the LISN.

If the EUT is supplied with a flexible power cord, the power cord length in excess of the distance separating the EUT from the LISN shall be folded back and forth at the center of the lead so as to form a bundle not exceeding 40cm in length. If the EUT is provided with a permanently coiled power cord, bundling of the cord is not required. If the EUT is supplied without a power cord, the EUT shall be connected to the LISN by a power cord of the type specified by the manufacturer which shall not be longer than 1 meter. The excess power cord shall be bundled as described above. If a non-flexible power cord is provided with the EUT, it shall be cut to the length necessary to attach the EUT to the LISN and shall not be bundled.

The interconnecting cables were arranged and moved to get the maximum emission. Both the line of power cord, hot and neutral, were measured.

The highest emissions were analyzed in details by operating the spectrum analyzer in fixed tuned mode to determine the nature of the emissions and to provide information which could be useful in reducing their amplitude.

7.2 Appendix B: Test Procedure for Radiated Emissions

Preliminary Measurements in the Anechoic Chamber

The radiated emissions are initially measured in the anechoic chamber at a measurement distance of 3 meters. Desktop EUT are placed on a wooden stand 0.8 meter in height. The measurement antenna is 3 meters from the EUT. The test setup in anechoic chamber is the same as open site. The turntable rotated 360°C. The antenna height is varied from 1-2.5m. The primary objective of the radiated measurements in the anechoic chamber is to identify the frequency spectrum in the absence of the electromagnetic environment existing on the open test site. The frequencies can then be pre-selected on the open test site to obtain the corresponding amplitude. The initial scan is made with the spectrum analyzer in automatic sweep mode. The spectrum peaks are then measured manually to determine the exact frequencies.

Measurements on the Open Site or 10m EMC Chamber

The radiated emissions test will then be repeated on the open site or 10m EMC chamber to measure the amplitudes accurately and without the multiple reflections existing in the shielded room. The EUT and support equipment are set up on the turntable of one of the 3 or 10 meter open field sites. Desktop EUT are set up on a wooden stand 0.8 meter above the ground.

For the initial measurements, the receiving antenna is varied from 1-4 meter height and is changed in the vertical plane from vertical to horizontal polarization at each frequency. Both reading are recorded with the quasi-peak detector with 120KHz bandwidth. For frequency between 30 MHz and 1000MHz, the reading is recorded with peak detector or quasi-peak detector. For frequency above 1 GHz, the reading is recorded with peak detector or average detector with 1 MHz bandwidth.

At the highest amplitudes observed, the EUT is rotated in the horizontal plane while changing the antenna polarization in the vertical plane to maximize the reading. The interconnecting cables were arranged and moved to get the maximum emission. Once the maximum reading is obtained, the antenna elevation and polarization will be varied between specified limits to maximize the readings.

7.3 Appendix C: Test Equipment

7.3.1 Test Equipment List

Location	Equipment Name	Brand	Model	S/N	Last Cal. Date	Next Cal. Date
Conduction	Coaxial Cable 1F-C2	Harbourindustries	RG400	1F-C2	05/20/2005	05/20/2006
Conduction	Digital Hygro-Thermometer Conduct	MicroLife	HT-2126G	ISL-Conduction02	11/30/2004	11/30/2006
Conduction	EMI Receiver 02	HP	85460A	3448A00183	10/01/2005	10/01/2006
Conduction	LISN 01	R&S	ESH2-Z5	890485/013	05/05/2005	05/05/2006
Conduction	LISN 06	R&S	ESH3-Z5	828874/009	12/13/2005	12/13/2006
Radiation	BILOG Antenna 08	Schaffner	CBL6112B	2756	06/07/2005	06/07/2006
Radiation	Coaxial Cable Chmb 02-10M	Belden	RG-8/U	Chmb 02-10M	11/16/2004	11/16/2005
Radiation	Digital Hygro-Thermometer Chmb 02	MicroLife	HT-2126G	Chmb 02	11/30/2004	12/30/2006
Radiation	EMI Receiver 03	HP	85460A	3448A00209	03/24/2005	03/24/2006
Radiation	Spectrum Analyzer 13	Advantest	R3132	121200411	02/17/2006	02/17/2007
Radiation	Horn Antenna 02	Com-Power	AH-118	10088	07/22/2005	07/22/2006
Radiation	Horn Antenna 04	Com-Power	AH-826	081-001	01/13/2006	01/13/2007
Radiation	Horn Antenna 05	Com-Power	AH-640	100A	09/30/2005	09/30/2006
Radiation	Microwave Cable RF SK-01	HUBER+SUHNERAG.	Sucoflex 102	22139 /2	07/07/2005	07/07/2006
Chamber 05	Peak Power Analyzer	HP	8990A	3621A01269	02/15/2006	02/15/2007
Chamber 05	Power Sensor Radar	HP	84815A	3318A01828	02/15/2006	02/15/2007
Radiation	Preamplifier 02	MITEQ	AFS44-00102 650-40-10P-44	728229	11/28/2005	11/28/2006
Radiation	Preamplifier 10	MITEQ	JS-26004000-2 7-5A	818471	11/22/2005	11/22/2006
Radiation	High Pass Filter 01	HEWLETT-PACKARD	84300-80038	001	N/A	N/A
Radiation	High Pass Filter 02	HEWLETT-PACKARD	84300-80039	005	N/A	N/A
Radiation	Spectrum Analyzer 07	Advantest	R3182	110600649	04/21/2005	04/21/2006

Note: Calibration is traceable to NIST or national or international standards.

7.3.2 Software for Controlling Spectrum/Receiver and Calculating Test Data

Radiation/Conduction	Filename	Version	Issued Date
Conduction	Tile.exe	1.12E	7/7/2000
Radiation	Tile.exe	1.12C	6/16/2000

7.4 Appendix D: Layout of EUT and Support Equipment

7.4.1 General Conducted Test Configuration

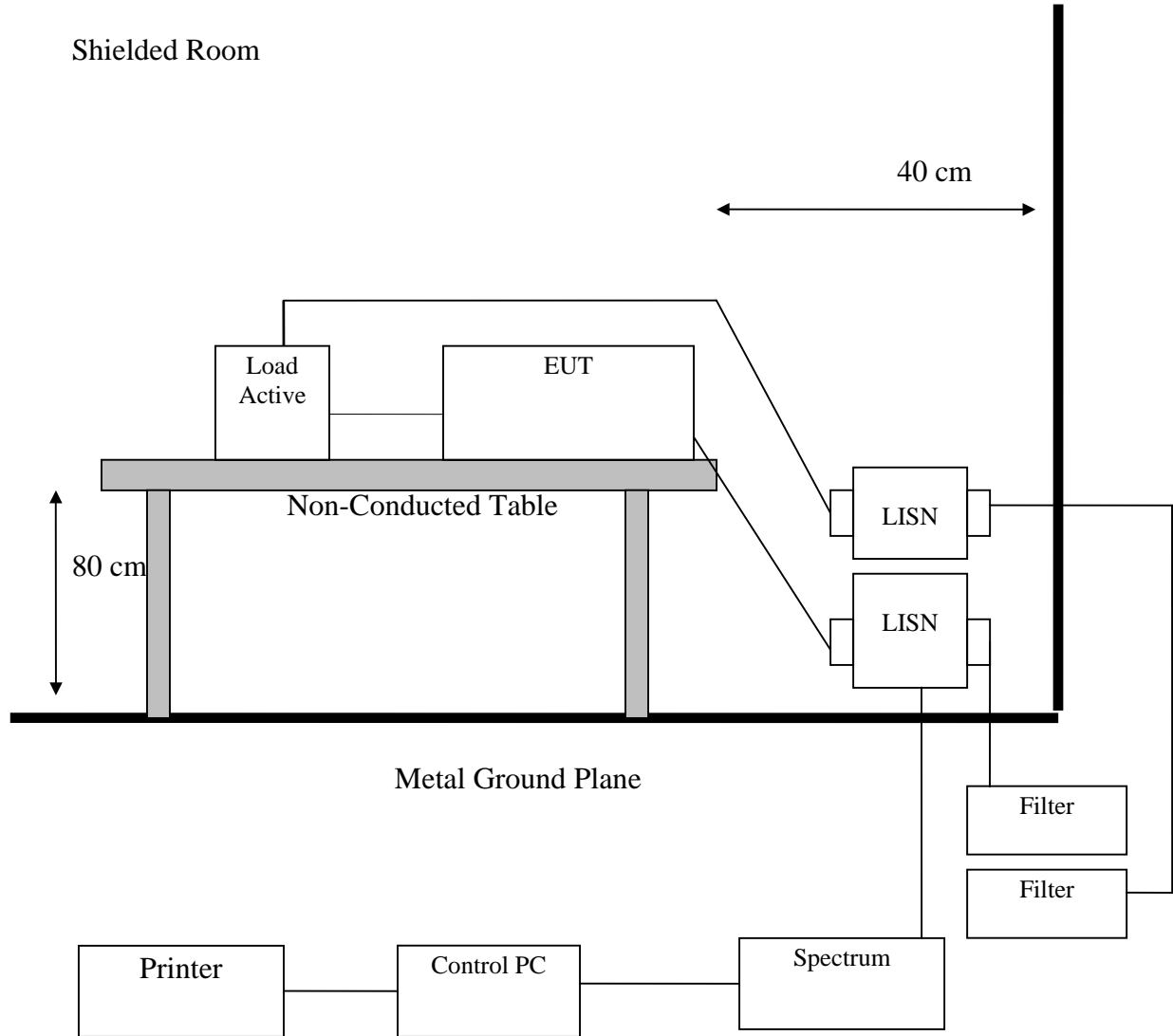

7.4.2 General Radiation Test Configuration

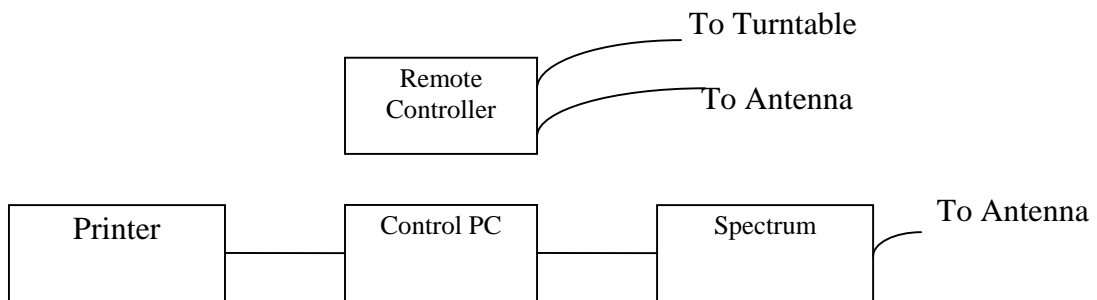
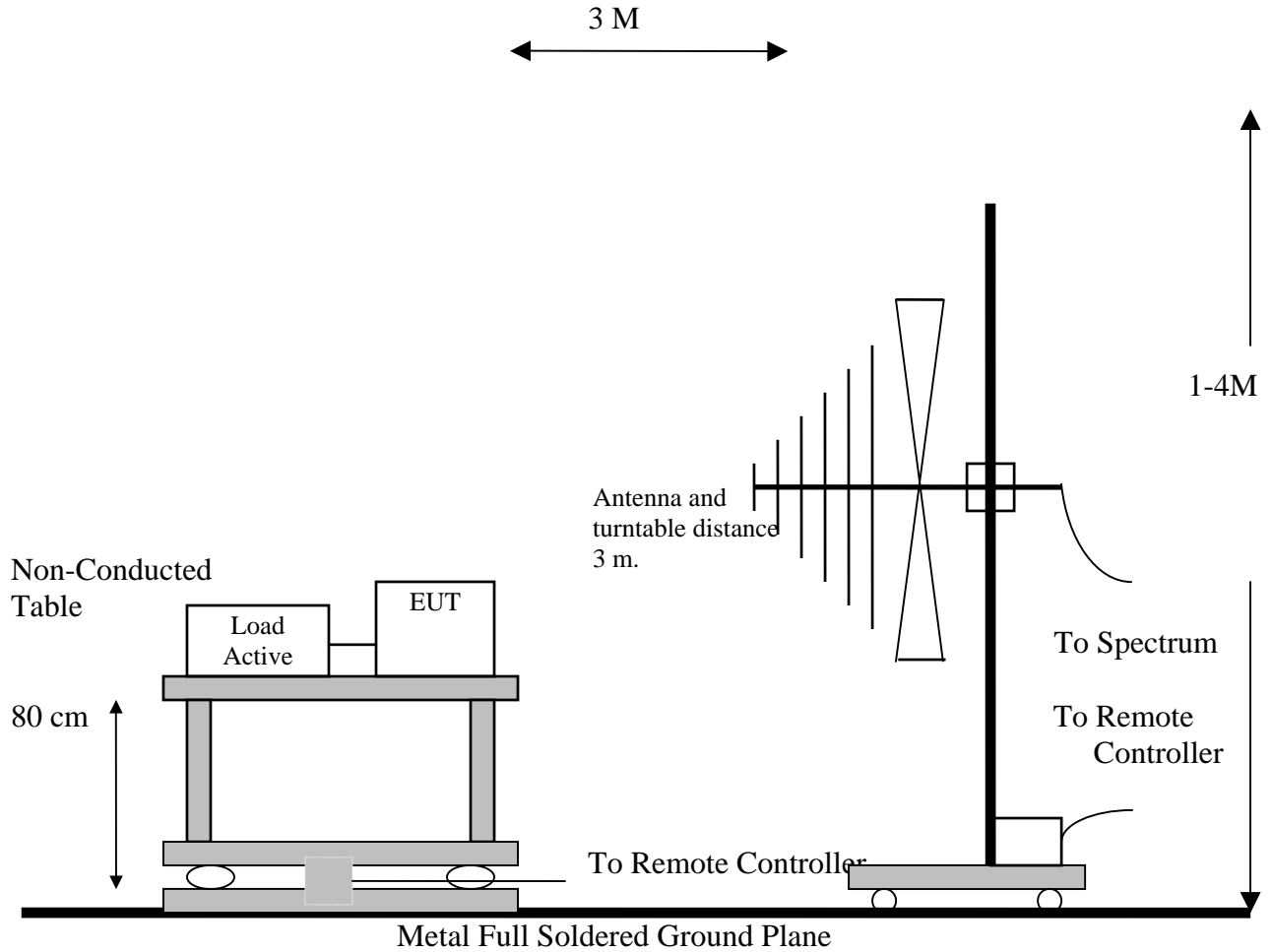

7.5 Appendix E: Description of Support Equipment

7.5.1 Description of Support Equipment

Support Unit 1.

Description:	Notebook Personal Computer
Model No.:	Aspire1510,ZP2,ZP2A
Brand:	acer
AC Power Adapter Manufacturer:	LSE(Model:ADP-90FB REV:F) LSE(Model:0202C1990) LSE(Model:0317A19135) Delta(Model:ADP-90FB REV:F) LiteOn(Model:ADP-135DBB)
HDD:	HGST (Model: IC25N030ATMR04-0)
Modem Card:	Ambit (Model: T60M283.10)
FDD:	Panasonic (Model:UJ-266A343FC)
SDRAM:	Infineon (Model:HYS64D32020GDL-6-B)
1394 Connector:	one 4 Pins
USB Connector:	four 4 Pins
RJ11 Connector:	one 2 Pins
RJ45 Connector:	one 8 Pins
VGA Connector:	one 15 Pins
PCMCIA Slot	one
Line out Port:	one
Line-in Port:	one
Parallel Port	one 25pins
DC IN Port:	one
Battery:	Li-ION DC14.8V 4400mAh
LCD:	QSI (Model:QD150XL06-01)
CPU	AMD Athlon 64 2800+, 3000+, 4000+

Support Unit 2.

Description:	USB 2.0 Card Reader/Writer
Model Number:	UID12W
Serial Number:	N/A
Power Supply Type:	From USB Port
USB 2.0 Port:	one 4-pin
SD/MMC Card Slot:	one
SecureDigital Card (Option):	SD (Model: SD-M16B1) 16MB
USB Cable:	Shielded, Detachable (With Cord)
FCC ID:	(Comply with FCC DOC)

Support Unit 3.

Description:	USB 2.0 Card Reader/Writer
Model Number:	UID12W
Serial Number:	N/A
Power Supply Type:	From USB Port
USB 2.0 Port:	one 4-pin
SD/MMC Card Slot:	one
SecureDigital Card (Option):	SD (Model: SD-M16B1) 16MB
USB Cable:	Shielded, Detachable (With Cord)
FCC ID:	(Comply with FCC DOC)

Support Unit 4.

Description:	Digital Video Camera
Model:	DCR-PC100
Serial Number:	173009
Power Supply Type:	AC Power Adaptor (SONY, Model: AC-L10A)
Power Cord:	Nonshielded, Detachable
FCC ID:	(Comply with FCC DOC)

Support Unit 5.

Description:	DELL USB Mouse
Model Number:	M-UR69
Serial Number:	LNA24412741
Power Supply Type:	N/A
Power Cord:	N/A
FCC ID:	N/A (Comply with FCC DOC)

Support Unit 6.

Description:	DELL USB Keyboard
Model Number:	RT7D10
Serial Number:	TH-05695W-37171-2B7-1021
Power Supply Type:	N/A
Power Cord:	N/A
FCC ID:	AQ6-7D10

Support Unit 7.

Description:	KOKA Headphone
Model Number:	ST-304
Serial Number:	N/A
Power Supply Type:	N/A
Power Cord:	N/A
FCC ID:	N/A

Support Unit 8.

Description:	KOKA Microphone
Model Number:	DM-510
Serial Number:	N/A
Power Supply Type:	N/A
Power Cord:	N/A
FCC ID:	N/A

Support Unit 9.

Description:	HP Printer (for parallel interface port)
Model Number:	C2642A
Serial Number:	TH84T1N3J3
Power Supply Type:	AC Adaptor (HP Model: C2175A)
Power Cord:	Non-shielded, Detachable
Data Cable:	Shielded, Detachable, With Metal Hood
FCC ID:	B94C2642X

Support Unit 10.

Description:	DELL 19" LCD Monitor
Model:	2000FP
AC Adapter:	DELL(ADP-70EB)
Serial Number:	N/A
DSUB In:	One 15 Pins
DVI In:	One Pins
S-Video In:	One7 Pins
Power Cord:	Non-shielded, Detachable
FCC ID:	(Comply with FCC DOC)

7.5.2 Software for Controlling Support Unit

A test program which generates a complete line of continuously repeating "H" pattern is used as the software test program. The program was executed as follows:

- A. Read and write to the disk drives.
- B. R/W memory card form EUT USB Port through Card Reader/Writer
- C. R/W memory card form EUT USB Port through Card Reader/Writer
- D. Capture the image from digital video camera then transfer to display.(CCD).
- E. Send audio signal to the headphone.
- F. Receive audio signal from the microphone.
- G. Send H pattern to the parallel port device (Printer).
- H. Send H pattern to the video port device (LCD Monitor).
- I. The RF software makes the transmitter contiunely sending RF signals
- J. Repeat the above steps.

	Filename	Issued Date
Monitor	HH.bat	8/20/1991
Printer1	Wordpad.exe	11/11/1999
Digital Video Camera	Divpcam.exe	12/10/1998
Winthrax	Winthrax.exe	5/21/1996
Winthrax	Winthrax.exe	5/21/1996
Atheros_1.6.2002	ART.exe	2003/12/17

7.5.3 I/O Cable Condition of EUT and Support Units

Description	Path	Cable Length	Cable Type	Connector Type
AC Power Cord	110V (~240V) to AC Power Cord Inlet (3-pin)	1.8M	Nonshielded, Detachable	Plastic Head
Printer Data Cable	Printer to PC Parallel port	1.5M	Shielded, Detachable	Metal Head
Microphone Data Cable	Microphone to PC Line In Port	1.5M	Nonshielded, Undetachable	Plastic Head
Headphone Data Cable	Headphone to PC Line Out Port	1.2M	Nonshielded, Undetachable	Plastic Head
Keyboard Data Cable	Keyboard to PC Keyboard port	1.8M	Shielded, Undetachable	Metal Head
Mouse Data Cable	Mouse to PC Mouse port	1.8M	Shielded, Un-detachable	Metal Head
Digital Video Camera 1394 Data Cable	Digital Video Camera to 1394 port of PC	1.0M	Shielded, Detachable	Metal Head
USB Data Cable	EUT USB Port to Card Reader/Writer	1.0 M	Shielded, detachable (with cord)	Metal Head
USB Data Cable	EUT USB Port to Card Reader/Writer	1.0 M	Shielded, detachable (with cord)	Metal Head
LCD Monitor D-SUB Data Cable	LCD Monitor to EUT D-SUB Port	1.6M	Shielded, Detachable	Metal Head
LCD Monitor S Data Cable	LCD Monitor to EUT S Port	1.6M	Shielded, Detachable	Metal Head

7.6 Appendix F: Accuracy of Measurement

Test Site: Conduction 02

Item	Source of Uncertainty	Probability Distribution	Total Uncertainties (dB)		Standard Uncertainty (dB)	
			k	Value	k	Value
1	Systematic Effects: (Assessment from 20 repeat observation; 1 reading on EUT)	Normal	k=2	0.104	k=1	0.052
2	Random Effects: (Assessment from 20 random observations; 1 reading on EUT)	Normal	k=2	0.330	k=1	0.165
3	Receiver Calibration	Rectangular	k=1.73	1.000	k=1	0.577
4	LISN Factor Calibration	Normal	k=2	1.200	k=1	0.600
5	Cable Loss Calibration	Normal	k=2	1.000	k=1	0.500
6	Combined Standard Uncertainty $U_c(y)$	Normal			k=1	0.850
7	Total Uncertainty @95% min. Confidence Level	Normal	k=2	1.701		

Measurement Uncertainty Calculations:

$$U_c(y) = \text{square root} (u_1(y)^2 + u_2(y)^2 + \dots + u_n(y)^2)$$

$$U = 2 * U_c(y)$$

Note: The measurement Uncertainties mentioned above also refer to NIS 81-1994 of NAMAS :
The treatment of Uncertainty in EMC Measurement.

Test Site: Chamber 02-3M

Item	Source of Uncertainty	Probability Distribution	Total Uncertainties (dB)		Standard Uncertainty (dB)	
			k	Value	k	Value
1	Systematic Effects: (Assessment from 20 repeat observation; 1 reading on EUT)	Normal	k=2	0.067	k=1	0.034
2	Random Effects: (Assessment from 20 random observations; 1 reading on EUT)	Normal	k=2	0.103	k=1	0.052
3	Receiver Calibration	Rectangular	k=1.73	1.000	k=1	0.577
4	Antenna Factor Calibration	Normal	k=2	1.700	k=1	0.850
5	Cable Loss Calibration	Normal	k=2	1.000	k=1	0.500
6	Combined Standard Uncertainty Uc(y)	Normal			k=1	1.029
7	Total Uncertainty @95% mim. Confidence Level	Normal	k=2	2.059		

Measurement Uncertainty Calculations:

$$U_c(y) = \text{square root} (u_1(y)^2 + u_2(y)^2 + \dots + u_n(y)^2)$$

$$U = 2 * U_c(y)$$

Note: The measurement Uncertainties mentioned above also refer to NIS 81-1994 of NAMAS :
The treatment of Uncertainty in EMC Measurement.

7.7 Appendix G: Photographs of EUT Configuration Test Set Up

The Front View of Highest Conducted Set-up For EUT



The Back View of Highest Conducted Set-up For EUT



The Front View of Highest Radiated Set-up For EUT



The Back View of Highest Radiated Set-up For EUT



7.8 Appendix H: Antenna Spec.

Please refer to the attached file.