

Normal Mode (Channel 12) Peak data

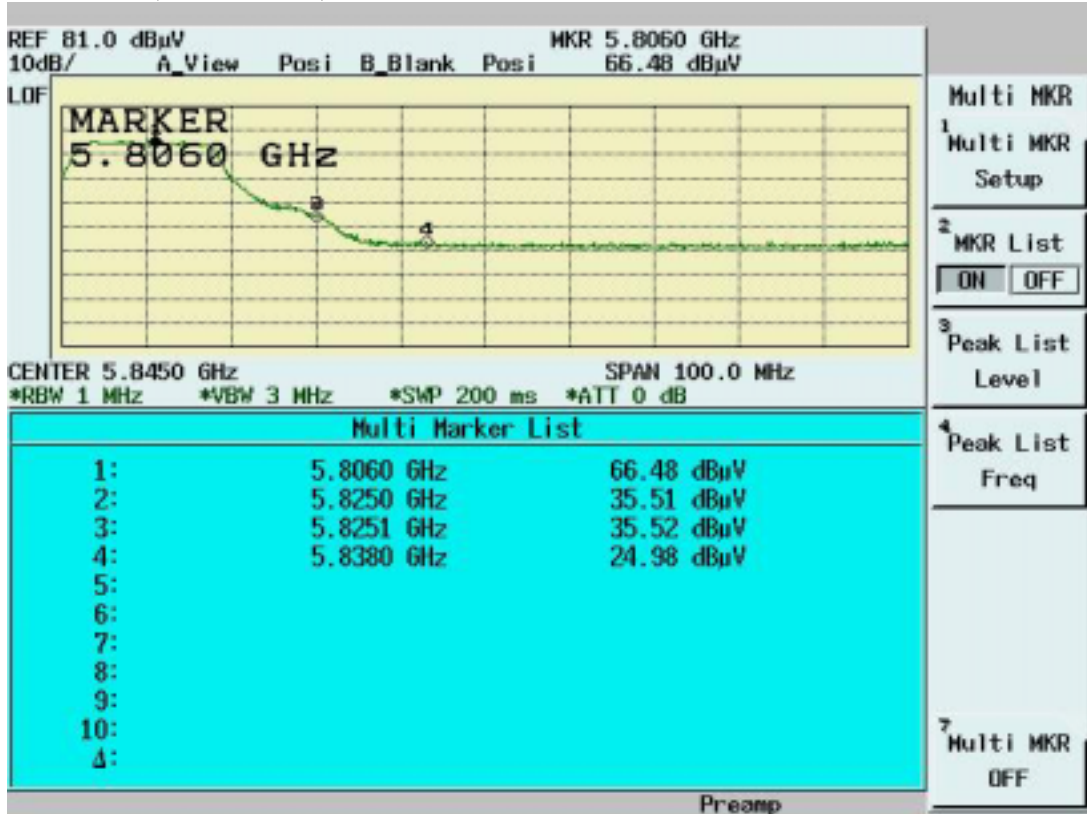

Normal Mode (Channel 12) Average Data

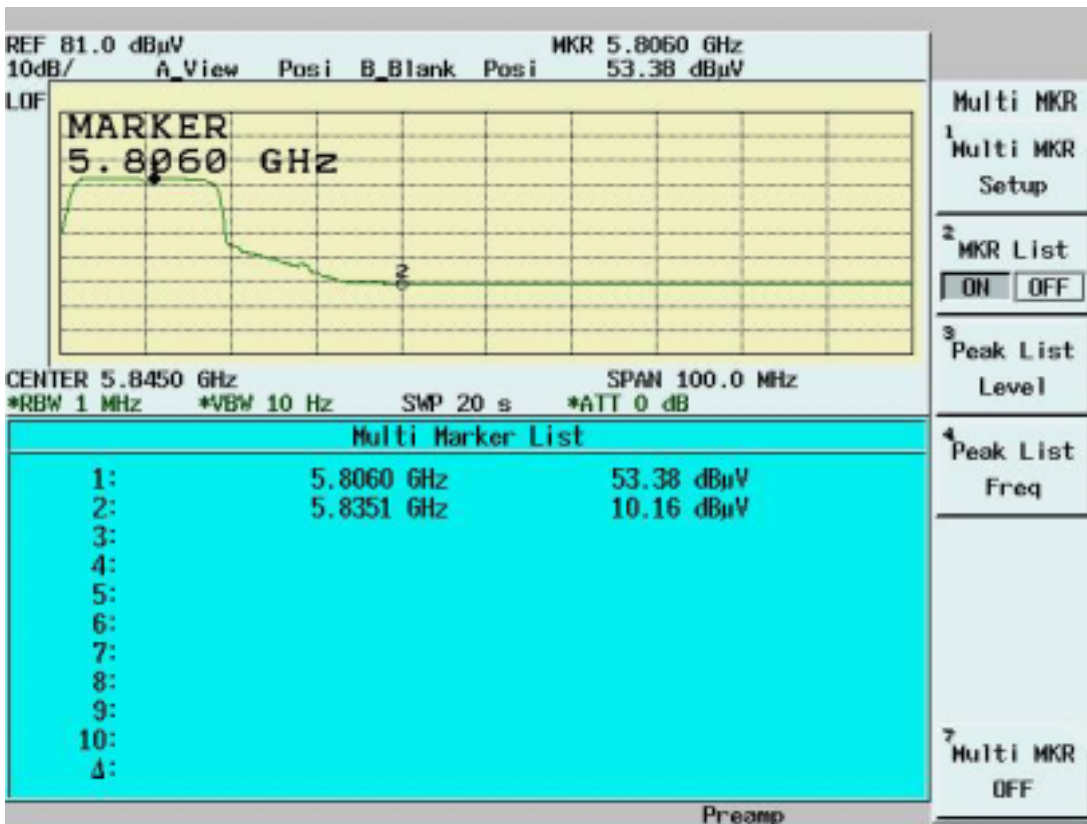

Band Edge measurement for radiated emission in Restricted Band(Radiated) Turbo Mode (Channel 1) Peak data

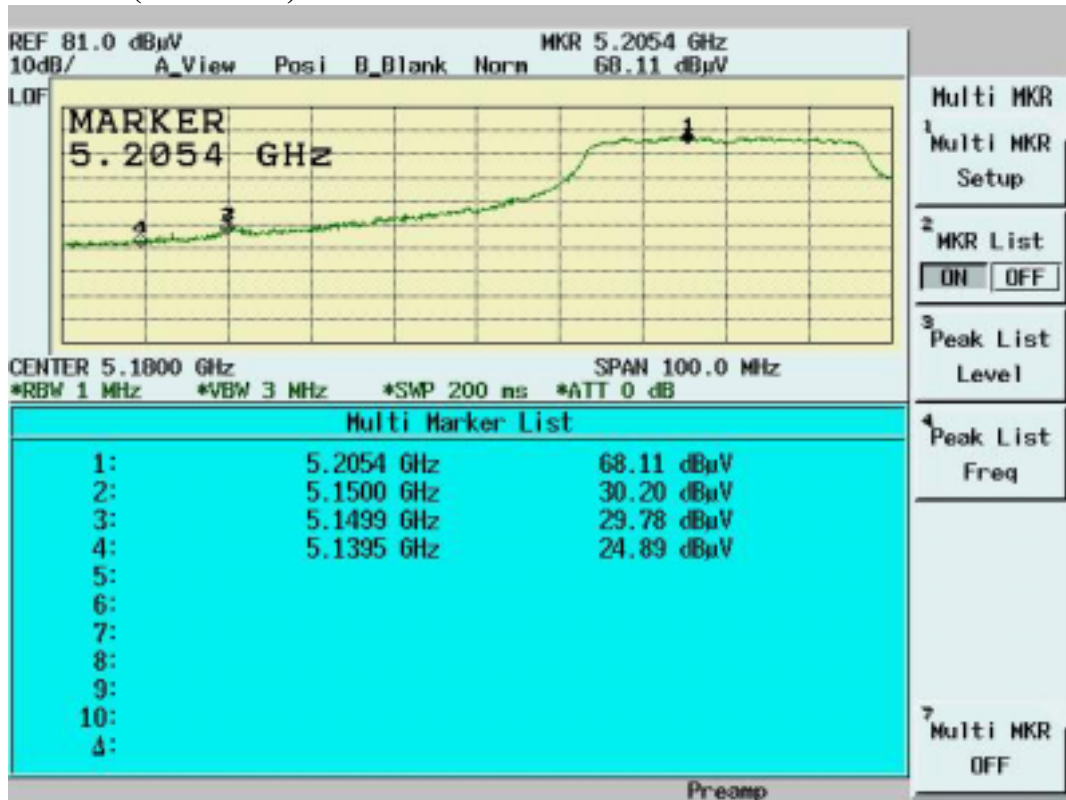

Turbo Mode (Channel 1) Average data

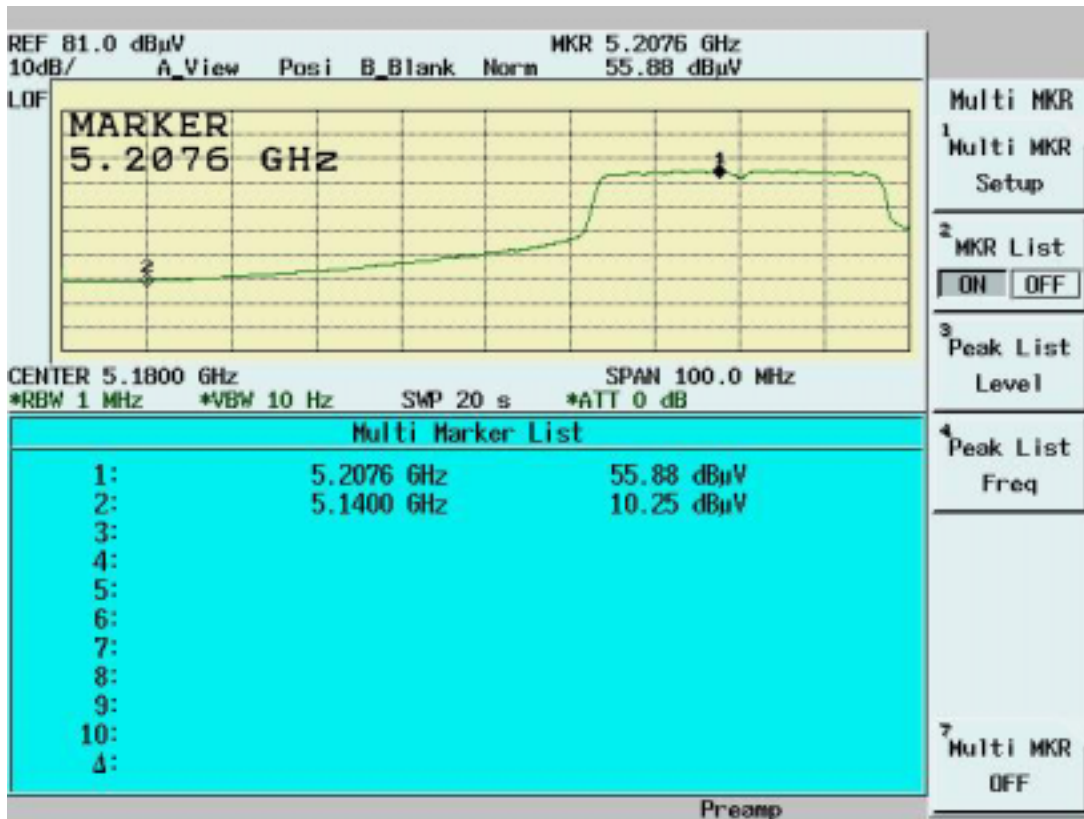

Turbo Mode (Channel 3) Peak data

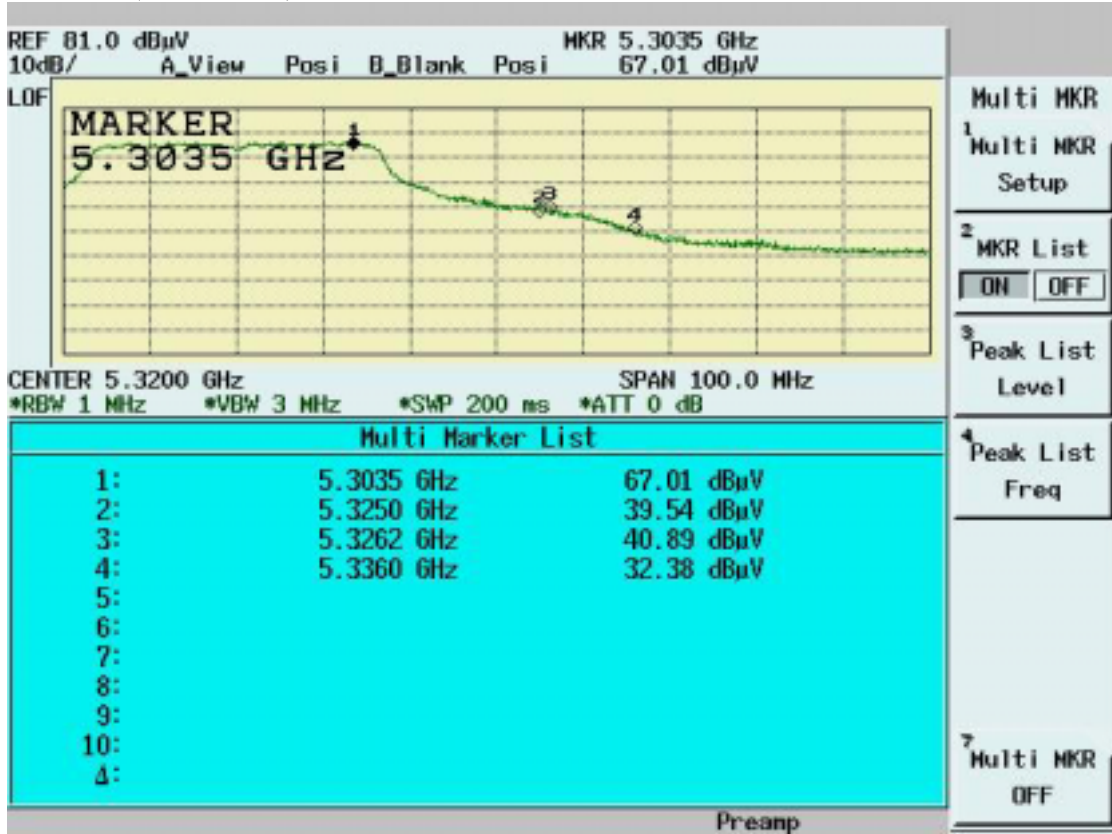

Turbo Mode (Channel 3) Average Data

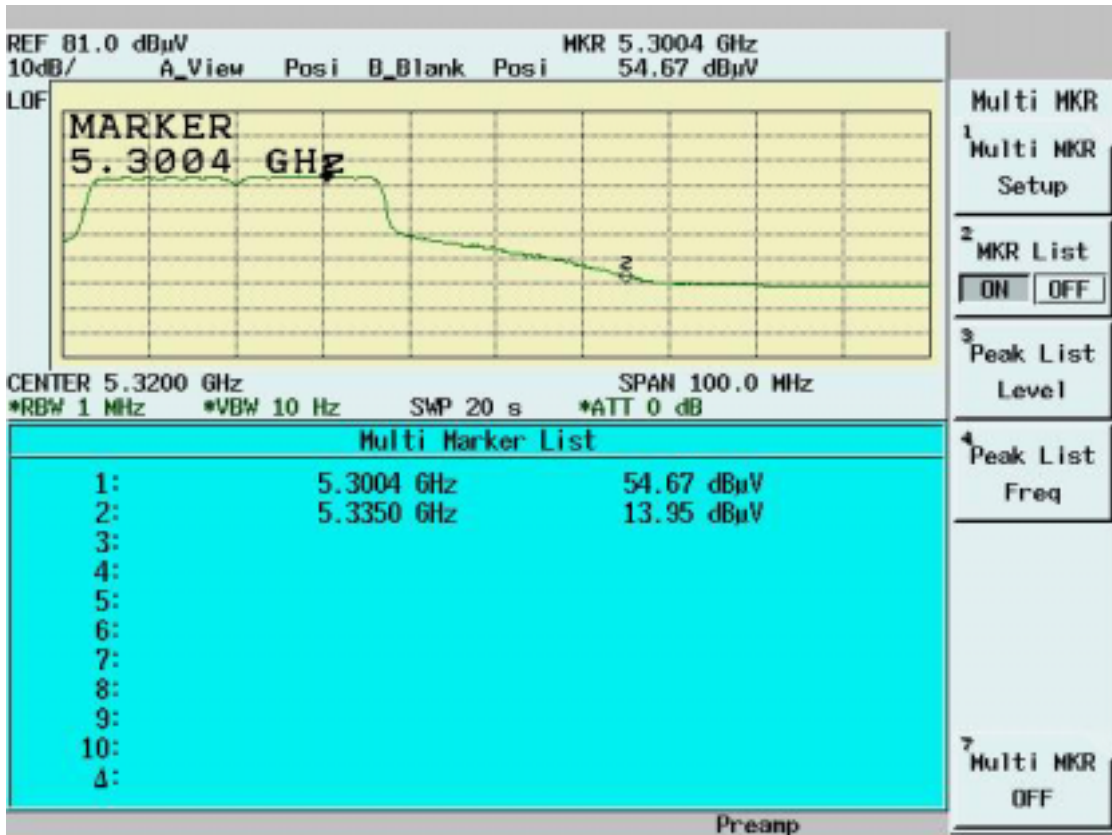

Turbo Mode (Channel 4) Peak data

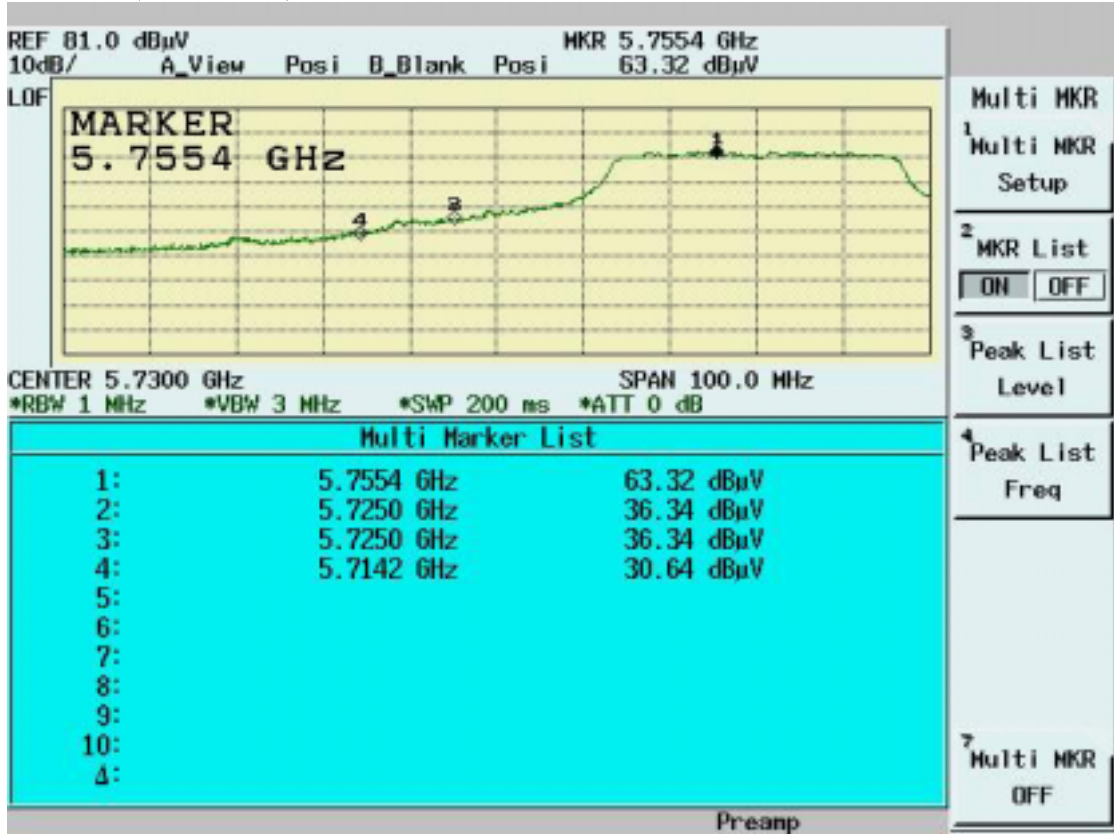

Turbo Mode (Channel 4) Average data

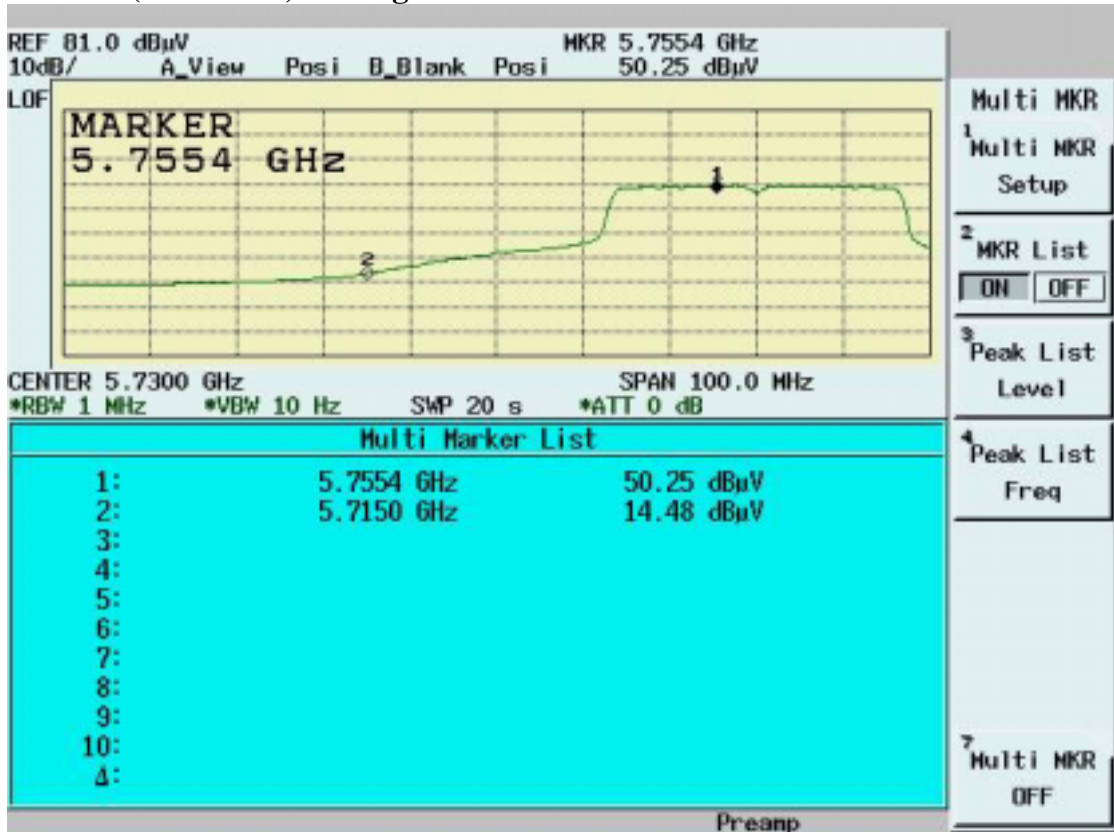

Turbo Mode (Channel 5) Peak data

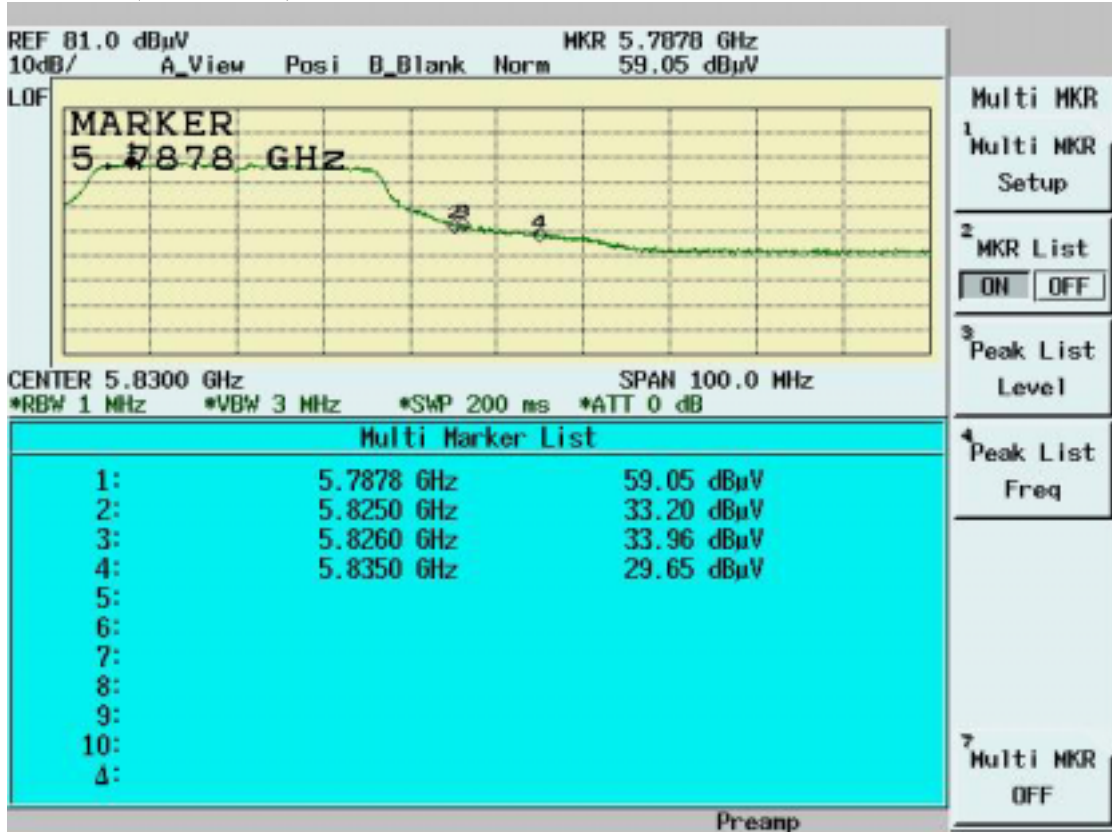

Turbo Mode (Channel 5) Average Data

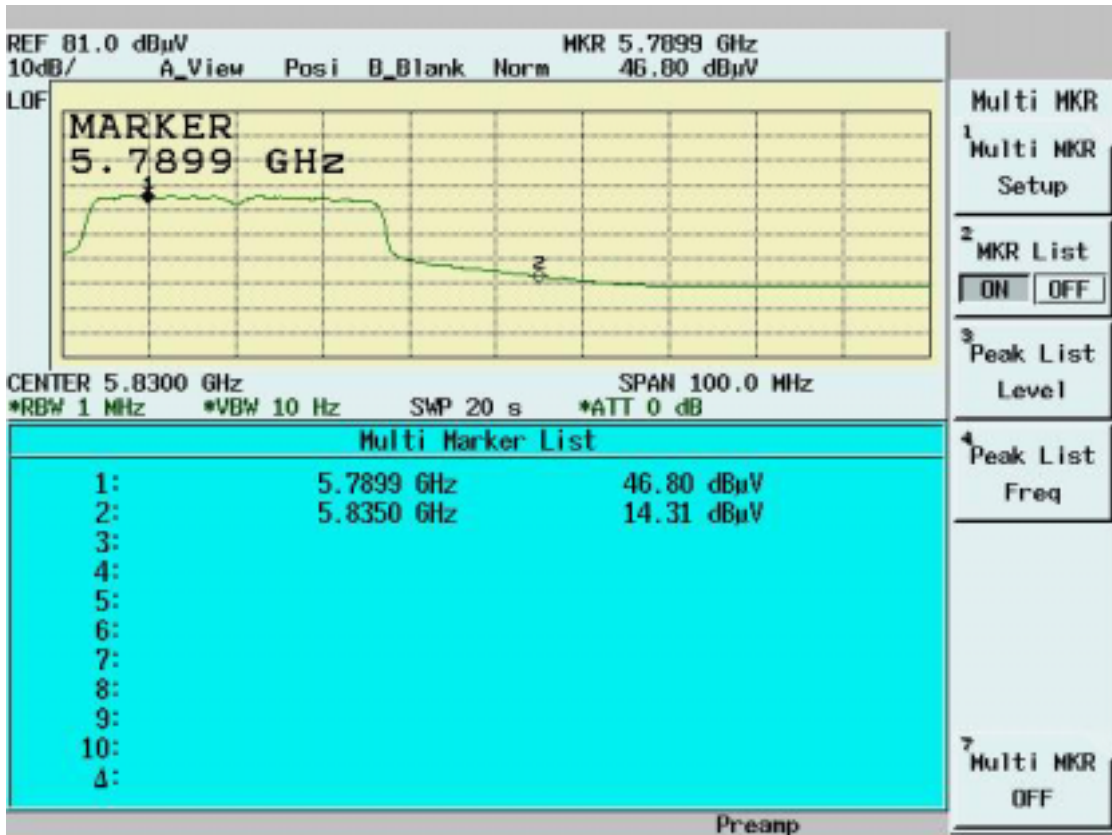

4.7 RF Exposure Measurement [Section 15.407(f)(4) & 1.1307(b)]

Refer to SAR Test Report

4.8 Frequency Stability [Section 15.407(g)]

4.8.1 Limits of Frequency Stability Measurement

The frequency tolerance of the carrier sing shall be maintained within +/- 0.02% of the operating frequency over the operation temperature range of EUT (0⁰C~35⁰C), and variation in the primary supply voltage from 85% to 115% of the rated supply voltage (115V AC) at 20⁰C.

4.8.2 Test Procedure

1. The EUT was placed in the Temperature/Humidity Chamber and powered by a Voltage/Frequency Power converter.
2. Connect the RF output of EUT to Spectrum. Turn on the EUT.
3. Turn the EUT off and set the chamber to the highest temperature specified.
4. Allow sufficient time (approximately 30 min) for the chamber temperature to stabilize. Turn the EUT on and measure the operating frequency after 2, 5, 10 minutes.
5. Set the Voltage/Frequency Power Converter to 85% and 115% of supply voltage, then repeat step 2, 3, 4 respectively.
6. Repeat step 2, 3, 4, 5 with the temperature of chamber set to the lowest temperature.
7. Repeat step 2, 3, 4, 5 with the temperature of chamber set to 20⁰C.

4.8.3 Test Setup

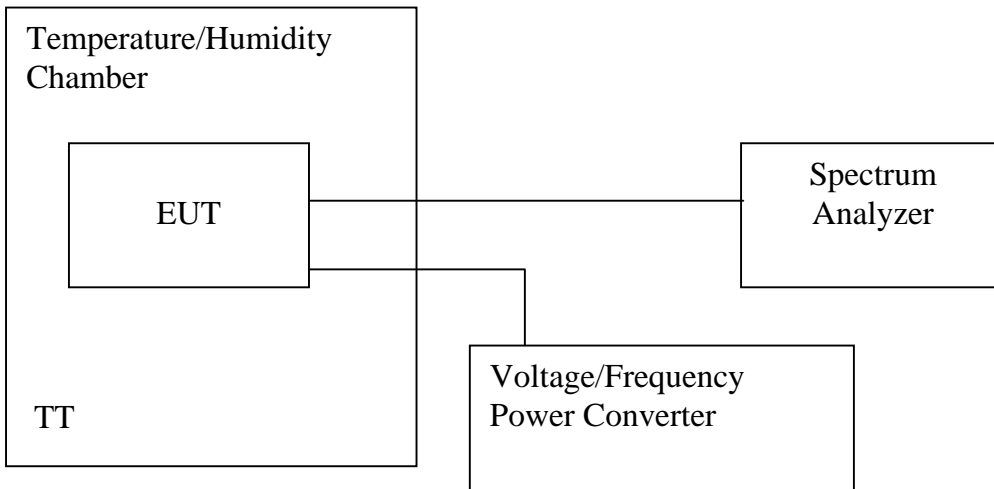

4.8.4 Test Data

Test Engineer: Jerry
Chiou

Operating 5180(Mhz)
Frequency:

Limit: +/- 0.02%

Temp.	Power Supply	2 minutes		5 minutes		10 minutes	
(°C)	(V AC)	(MHz)	(%)	(MHz)	(%)	(MHz)	
35	132	5180.0018	0.0000	5180.0050	0.0001	5180.0208	0.0004
	115	5180.0050	0.0001	5180.0122	0.0002	5180.0212	0.0004
	97	5180.0036	0.0001	5180.0120	0.0002	5180.0013	0.0000
0	132	5180.0050	0.0001	5180.0155	0.0003	5180.0094	0.0002
	115	5180.0111	0.0002	5180.0233	0.0004	5180.0200	0.0004
	97	5180.0307	0.0006	5180.0193	0.0004	5180.0202	0.0004
20	132	5180.0043	0.0001	5180.0124	0.0002	5180.0087	0.0002
	115	5180.0108	0.0002	5180.0172	0.0003	5180.0121	0.0002
	97	5179.9932	-0.0001	5180.0249	0.0005	5179.9960	-0.0001

5. TEST RESULTS (802.11b)

5.1 Powerline Conducted Emissions [Section 15.207]

5.1.1 EUT Configuration

The EUT was set up on the non-conductive table that is 1.0 by 1.5 meter, 80cm above ground. The wall of the shielded room was located 40cm to the rear of the EUT.

Power to the EUT was provided through the LISN. The impedance vs. frequency characteristic of the LISN is complied with the limit used.

Both lines (neutral and hot) were connected to the LISN in series at testing. A coaxial-type connector which provides one 50 ohms terminating impedance was provided for connecting the test instrument. The excess length of the power cord was folded back and forth at the center of the lead so as to form a bundle not exceeding 40cm in length.

Any changes made to the configuration, or modifications made to the EUT, during testing are noted in the following test record.

If the EUT is a Personal Computer or a peripheral of personal computer, and the personal computer has an auxiliary AC outlet which can be used for providing power to an external monitor, then all measurements will be made with the monitor power from first the computer-mounted AC outlet and then a floor-mounted AC outlet.

5.1.2 Test Procedure

The system was set up as described above, with the EMI diagnostic software running. The main power line conducted EMI tests were run on the hot and neutral conductors of the power cord and the results were recorded. The effect of varying the position of the interface cables has been investigated to find the configuration that produces maximum emission.

At the frequencies where the peak values of the emissions were higher than 6dB below the applicable limits, the emissions were also measured with the quasi-peak detectors. At the frequencies where the quasi-peak values of the emissions were higher than 6dB below the applicable average limits, the emissions were also measured with the average detectors.

The highest emissions were analyzed in details by operating the spectrum analyzer in fixed tuned mode to determine the nature of the emissions and to provide information which could be useful in reducing their amplitude.

5.1.3 EMI Receiver/Spectrum Analyzer Configuration (for the frequencies tested)

Frequency Range	150 KHz--30MHz
Detector Function	Quasi-Peak/Average
Bandwidth (RBW)	9KHz

5.1.4 Test Data:

Power Line Conducted Emissions (Hot) Channel 1, 6, 11

Operator: Jerry Chiou

Temperature (C): 27

04:47:57 PM, Sunday, August 21, 2005

Humidity (%): 62

Frequency	LISN Loss	Cable Loss	QP Correc.	QP Limit	QP Margin
MHz	(dB)	(dB)	Amp.(dBuV)	(dBuV)	(dB)
0.6285	0.14	0.07	28.18	47.96	-19.78
1.6615	0.23	0.08	30.85	47.96	-17.11
1.8991	0.21	0.09	29.31	47.96	-18.65
1.9789	0.20	0.09	29.83	47.96	-18.13
7.5769	0.27	0.18	34.93	47.96	-13.03
7.9184	0.27	0.19	35.72	47.96	-12.24
8.2200	0.28	0.19	34.65	47.96	-13.31
8.6377	0.28	0.19	32.17	47.96	-15.79
12.807	0.36	0.26	28.59	47.96	-19.37

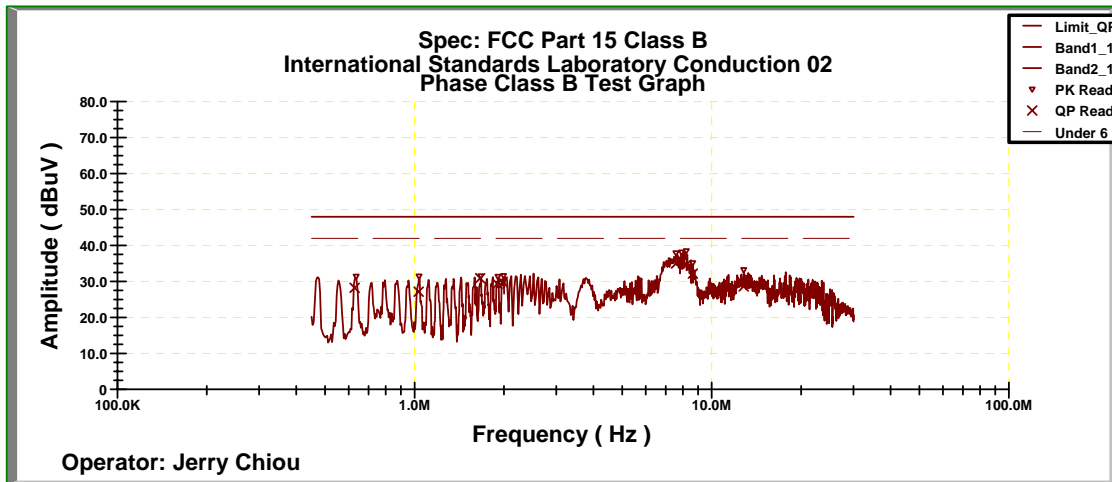

Power Line Conducted Emissions (Neutral) Channel 1, 6, 11

Operator: Jerry Chiou

Temperature (C): 27

04:55:50 PM, Sunday, August 21, 2005

Humidity (%): 62

Frequency	LISN Loss	Cable Loss	QP Corrcr.	QP Limit	QP Margin
MHz	(dB)	(dB)	Amp.(dBuV)	(dBuV)	(dB)
0.7945	0.17	0.07	25.68	47.96	-22.28
1.5025	0.20	0.08	24.98	47.96	-22.98
1.6646	0.20	0.08	25.70	47.96	-22.26
1.8249	0.20	0.09	25.91	47.96	-22.05
7.4651	0.17	0.18	32.55	47.96	-15.41
7.9562	0.16	0.19	34.54	47.96	-13.42
8.4100	0.16	0.19	32.44	47.96	-15.52
17.745	0.21	0.32	21.39	47.96	-26.57
18.305	0.23	0.33	29.94	47.96	-18.02

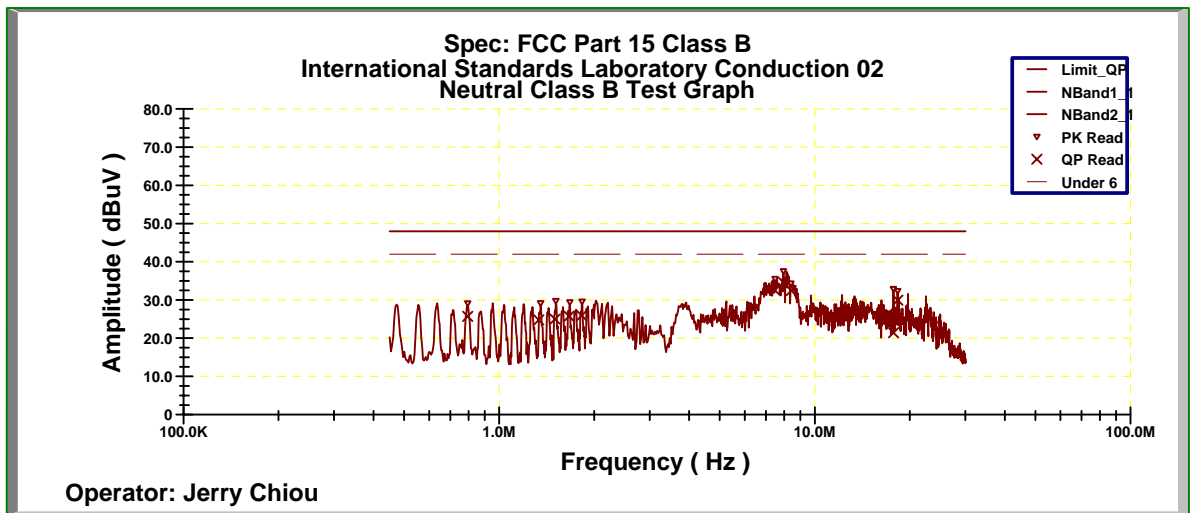

* NOTE: During the test, the EMI receiver was set to Max. Hold then switch the EUT Channel between 1 , 6, 11 to get the maximum reading of all these channels.
 Margin = Amplitude + Insertion Loss- Limit
 A margin of -8dB means that the emission is 8dB below the limit

5.2 Bandwidth for DSSS [Section 15.247 (a)(2)]

5.2.1 Test Procedure

The Transmitter output of EUT was connected to the spectrum analyzer. The 6 dB bandwidth of the fundamental frequency was measured. The setting of spectrum analyzer is as follows

Equipment mode	Spectrum analyzer
Detector function	Peak mode
RBW	100KHz
VBW	100KHz

5.2.2 Test Setup

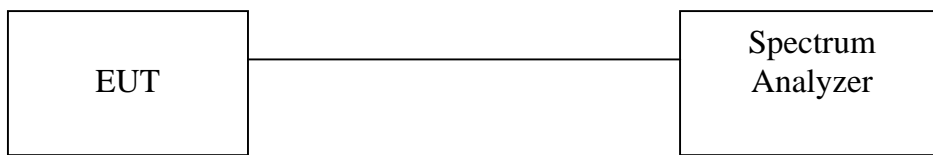

5.2.3 Test Data:

6dB Bandwidth

Temperature ():25

Test Engineer:Jerry Chiou

Humidity (%):50

Channel	Frequency (MHz)	6dB Bandwidth (MHz)	Limit (MHz)	Pass/Fail
1	2412	11.52	0.5	Pass
6	2437	12.00	0.5	Pass
11	2462	11.96	0.5	Pass

Channel 1:

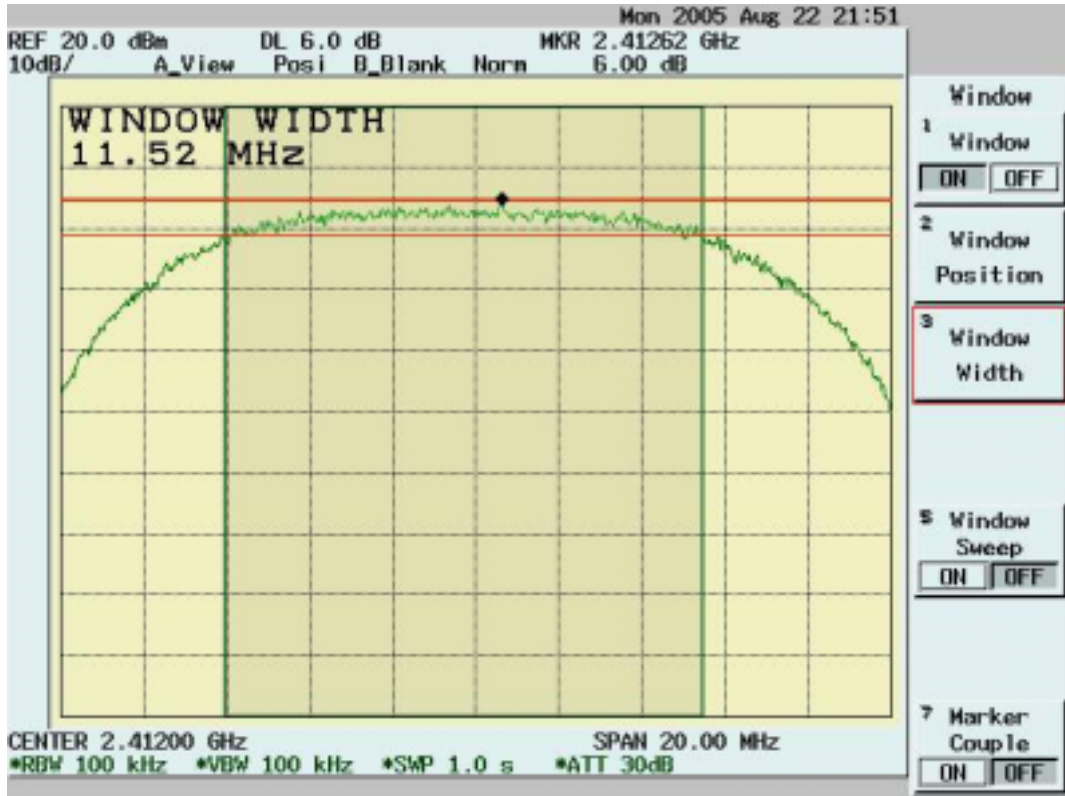

Channel 6:

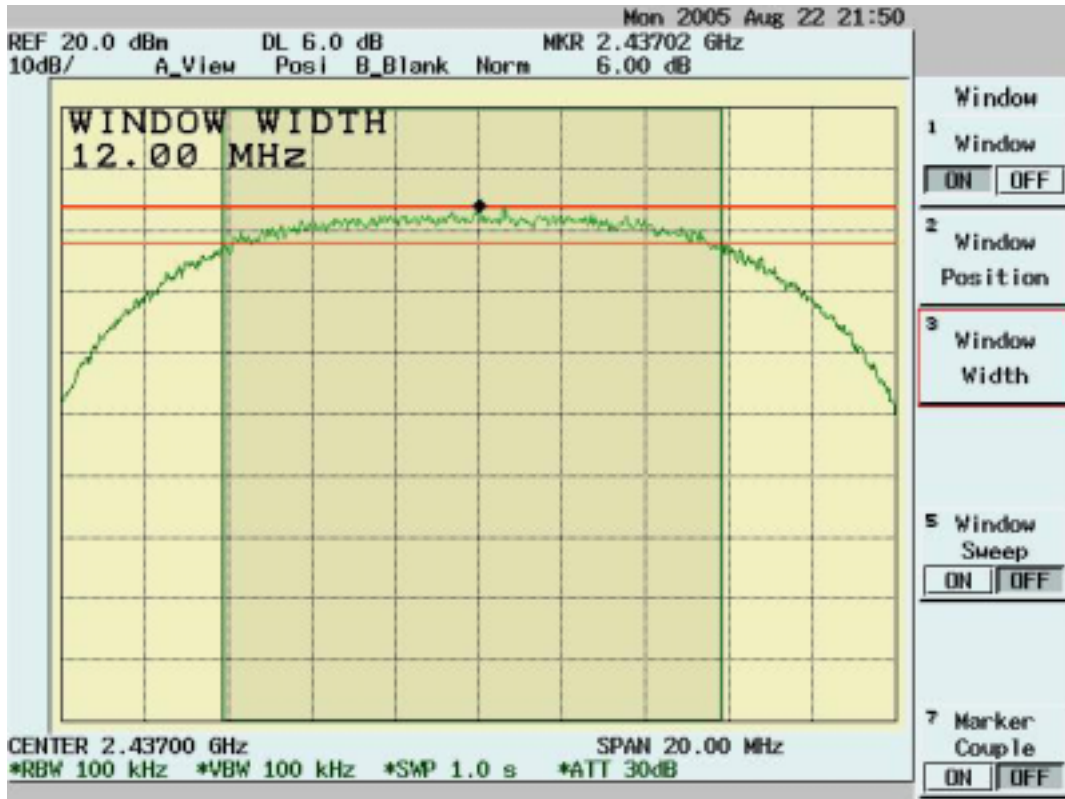

Channel 11:

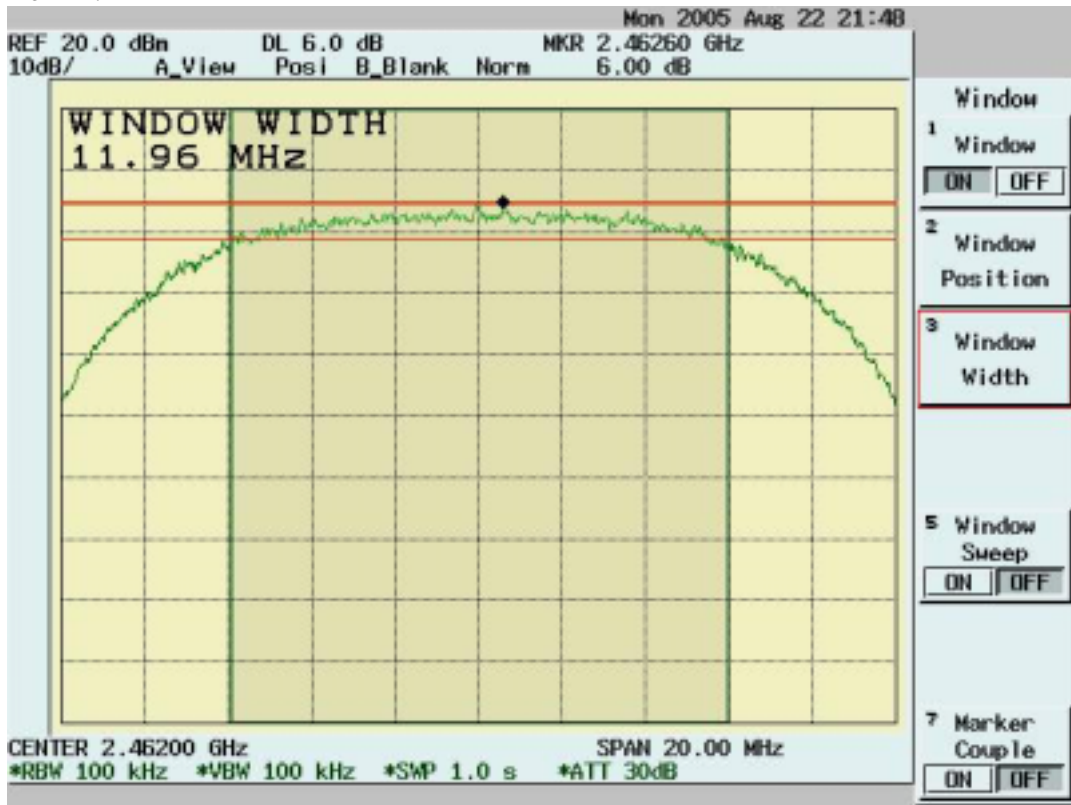

5.3 DSSS Maximum Peak Output Power [Section 15.247 (b)(1)]

5.3.1 Test Procedure

The Transmitter output of EUT was connected to the peak power analyzer.

5.3.2 Test Setup

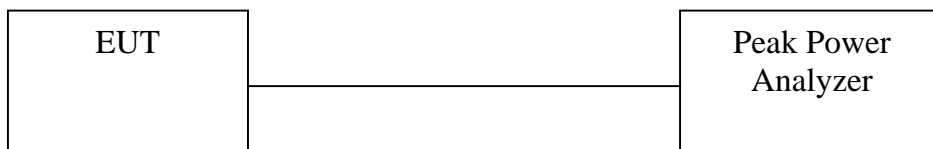

5.3.3 Test Data

Maximum Peak Output Power

Temperature ():25

Test Engineer:Jerry Chiou

Humidity (%):50

Channel	Frequency (Mhz)	Analyzer Reading (dBm)	Cable Loss (dB)	Peak Power Output (mW)	Peak Power Output (dBm)	Limit (dBm)	Pass/Fail
1	2412	16.41	1.30	59.02	17.71	30	Pass
6	2437	15.91	1.30	52.60	17.21	30	Pass
11	2462	16.40	1.30	58.88	17.70	30	Pass

Note: Two RF output(MAIN & AUX) have been test,the worse data shown above.

5.4 Radiated Emission Measurement [Section [15.247(c)(4)]

5.4.1 EUT Configuration

The equipment under test was set up on the 10 meter chamber with measurement distance of 3 meters. The EUT was placed on a non-conductive table 80cm above ground.

Any changes made to the configuration, or modifications made to the EUT, during testing are noted in the following test record.

5.4.2 Test Procedure

The system was set up as described above, with the EMI diagnostic software running. We found the maximum readings by varying the height of antenna and then rotating the turntable. Both polarization of antenna, horizontal and vertical, are measured.

30M to 1GHz: The highest emissions between 30 MHz to 1000 MHz were also analyzed in details by operating the spectrum analyzer and/or EMI receiver in quasi-peak mode to determine the precise amplitude of the emissions. While doing so, the interconnecting cables and major parts of the system were moved around, the antenna height was varied between one and four meters, its polarization was varied between vertical and horizontal, and the turntable was slowly rotated, to maximize the emission.

1GHz – 25GHz: The highest emissions were also analyzed in details by operating the spectrum analyzer and/or EMI receiver in peak mode to determine the precise amplitude of the emission. While doing so, the interconnecting cables and major parts of the system were moved around, the antenna height was varied between one and four meters, its polarization was varied between vertical and horizontal, and the turntable was slowly rotated, to maximize the emission. During test the EMI receiver and spectrum was setup according to *EMI Receiver/Spectrum Analyzer Configuration*.

For the test of 2nd to 10th harmonics frequencies , the equipment setup was also refer to *EMI Receiver/Spectrum Analyzer Configuration*. The frequencies were tested using Peak mode first, if the test data is higher than the emissions limit, an additional measurement using Average mode will be performed and the average reading will be compared to the limit and record in test report.

5.4.3 EMI Receiver/Spectrum Analyzer Configuration (for the frequencies tested)

Frequency Range Tested:	30MHz~1000MHz
Detector Function:	Quasi-Peak Mode
Resolution Bandwidth (RBW):	120KHz
Video Bandwidth (VBW)	1MHz

Frequency Range Tested:	1GHz – 25 GHz
Detector Function:	Peak Mode
Resolution Bandwidth (RBW):	1MHz
Video Bandwidth (VBW)	3MHz

Frequency Range Tested:	1GHz – 25 GHz
Detector Function:	Average Mode
Resolution Bandwidth (RBW):	1MHz
Video Bandwidth (VBW)	10 Hz

5.4.4 Test Data (30MHz – 1GHz):

30M – 1GHz Open Field Radiated Emissions (Horizontal) Channel 1, 6, 11

Operator: Jerry Chiou

Temperature (C): 23

04:30:07 PM, Saturday, August 20, 2005

Humidity (%): 54

Frequency	Rx Amp.	Ant Fact	CableLoss	PreAmpGain	Corrct. Emi.	Limit	Margin	Ant. Pos.	Table Pos.
MHz	(dBuV)	(dB/m)	(dB)	(dB)	(dBuV/m)	(dBuV/m)	(dB)	(cm)	(deg)
37.76	8.44	13.54	1.10	0.00	23.08	40.00	-16.92	102.00	89.00
132.82	16.42	11.02	2.18	0.00	29.62	43.50	-13.88	102.00	23.00
215.27	14.66	8.40	2.82	0.00	25.88	43.50	-17.62	102.00	269.00
258.92	17.39	12.86	3.18	0.00	33.43	46.00	-12.57	196.00	41.00
299.66	11.30	15.85	3.60	0.00	30.75	46.00	-15.25	102.00	335.00
321.97	10.37	16.03	3.85	0.00	30.25	46.00	-15.75	196.00	122.00
366.59	7.87	16.10	4.22	0.00	28.19	46.00	-17.81	102.00	7.00
379.2	8.71	16.02	4.30	0.00	29.03	46.00	-16.97	102.00	7.00
386.96	13.11	15.98	4.35	0.00	33.44	46.00	-12.56	196.00	122.00
452.92	8.24	16.27	4.89	0.00	29.40	46.00	-16.60	102.00	23.00
515.97	8.55	17.78	5.32	0.00	31.65	46.00	-14.35	102.00	39.00
882.63	0.82	20.60	8.09	0.00	29.51	46.00	-16.49	196.00	254.00

30M – 1GHz Open Field Radiated Emissions (Vertical) Channel 1, 6, 11

Operator: Jerry Chiou

Temperature (C): 23

04:30:07 PM, Saturday, August 20, 2005

Humidity (%): 54

Frequency	Rx Amp.	Ant Fact	CableLoss	PreAmpGain	Corrct. Emi.	Limit	Margin	Ant. Pos.	Table Pos.
MHz	(dBuV)	(dB/m)	(dB)	(dB)	(dBuV/m)	(dBuV/m)	(dB)	(cm)	(deg)
37.76	8.89	13.54	1.10	0.00	23.53	40.00	-16.47	102.00	89.00
131.85	17.56	11.11	2.17	0.00	30.85	43.50	-12.65	102.00	39.00
215.27	13.41	8.40	2.82	0.00	24.63	43.50	-18.87	102.00	269.00
258.92	13.32	12.86	3.18	0.00	29.36	46.00	-16.64	196.00	41.00
323.91	10.41	16.04	3.87	0.00	30.33	46.00	-15.67	196.00	7.00
354.95	9.20	16.17	4.14	0.00	29.52	46.00	-16.48	102.00	23.00
386.96	13.08	15.98	4.35	0.00	33.41	46.00	-12.59	196.00	122.00
450.98	8.99	16.22	4.88	0.00	30.09	46.00	-15.91	102.00	39.00
515	7.68	17.76	5.32	0.00	30.76	46.00	-15.24	102.00	23.00
545.07	3.79	18.48	5.49	0.00	27.76	46.00	-18.24	102.00	137.00
644.98	4.59	18.97	6.27	0.00	29.84	46.00	-16.16	102.00	186.00
779.81	0.45	20.14	7.17	0.00	27.76	46.00	-18.24	102.00	318.00

NOTE:

- During the Pre-test, the EUT has been tested for Channel 1, 6, 11 transmit from Left and Right antenna respectively to get all the critical emission frequencies. In the final test all the critical emission frequencies has been tested and the test data are listed above.
- Margin = Corrected Amplitude – Limit
Corrected Amplitude = Radiated Amplitude + Antenna Correction Factor + Cable Loss - Pre-Amplifier Gain
A margin of -8dB means that the emission is 8dB below the limit

All frequencies from 30MHz to 1GHz have been tested

5.4.5 Test Data (1GHz – 25 GHz) .

1GHz~ 25 GHz (Horizontal), Channel 1: 2412 MHz

Operator: Jerry Chiou

RBW: 1MHz
Humidity (%): 41
Temperature (C): 27

Frequency	Rx_R.	Ant_F.	Cab_L.	PreAmpl	Emission	Average Limit	Average Margin	Peak Limit	Peak Margin	Ant. Tower	Turn Table
MHz	dBuV	dB/m	dB	dB	dBuV/m	dBuV/m	dB	dBuV/m	dB	cm	deg
1781.72	53.68 pk	29.17	2.44	34.75	50.53 pk	54.00	-3.47	74.00	--	100	58
2116.38	49.43 pk	30.98	2.24	35.18	47.47 pk	54.00	-6.53	74.00	--	100	80
2333.67	54.82 pk	30.93	1.58	35.19	52.14 pk	54.00	-1.86	74.00	--	101	148
2608.39	50.50 pk	30.94	1.38	35.10	47.72 pk	54.00	-6.28	74.00	--	102	234
2948.05	49.48 pk	31.08	1.44	34.80	47.21 pk	54.00	-6.79	74.00	--	103	341
2958.04	49.45 pk	31.08	1.44	34.79	47.19 pk	54.00	-6.81	74.00	--	103	344
4823.79	54.94 pk	34.93	2.12	37.72	54.28 pk	54.00	--	74.00	-19.72	100.00	50.00
4823.79	40.12 av	34.93	2.12	37.72	39.45 av	54.00	-14.55	74.00	--	100.00	50.00
9648.25	46.83 pk	40.57	3.25	34.33	56.32 pk	54.00	--	74.00	-17.68	100.00	33.00
9648.25	33.38 av	40.57	3.25	34.33	42.87 av	54.00	-11.13	74.00	--	100.00	33.00

1GHz~ 25 GHz (Vertical), Channel 1: 2412 MHz

Operator: Jerry Chiou

RBW: 1MHz
Humidity (%): 41
Temperature (C): 27

Frequency	Rx_R.	Ant_F.	Cab_L.	PreAmpl	Emission	Average Limit	Average Margin	Peak Limit	Peak Margin	Ant. Tower	Turn Table
MHz	dBuV	dB/m	dB	dB	dBuV/m	dBuV/m	dB	dBuV/m	dB	cm	deg
1796.7	55.70 pk	29.29	2.45	34.78	52.66 pk	54.00	-1.34	74.00	--	100	57
2121.38	49.34 pk	30.98	2.23	35.18	47.36 pk	54.00	-6.64	74.00	--	100	81
2386.11	58.97 pk	30.92	1.42	35.20	56.12 pk	54.00	-17.88	74.00	--	101	164
2386.11	45.18 av	30.92	1.42	35.20	42.32 pk	54.00	-11.68	74.00	--	101	164
2985.51	51.14 pk	31.09	1.45	34.76	48.92 pk	54.00	-5.08	74.00	--	103	352
3100.4	51.15 pk	31.18	1.50	34.97	48.86 pk	54.00	-5.14	74.00	--	103	331
3260.24	50.05 pk	31.31	1.59	35.32	47.63 pk	54.00	-6.37	74.00	--	103	290
4824	51.11 pk	34.93	2.12	37.72	50.45 pk	54.00	-3.55	74.00	--	100	303
9647.79	52.61 pk	40.57	3.25	34.33	62.10 pk	54.00	--	74.00	-11.90	100	355
9647.79	37.02 av	40.57	3.25	34.33	46.51 av	54.00	-7.49	74.00	--	100	355

Note:

- According to the standards used, Where limits are specified by agencies for both average and peak (or quasi-peak) detection , if the peak (or quasi-peak) measured value complies with the average limit , it is unnecessary to perform an average measurement.
- “ * ”: Fundamental Frequency
- “***”: Not in the restricted band, Limit level=Fundamental Emission-20dB
- “ pk”: peak mode
- “av”: average mode
- “---“: No meter reading data due to the emission level is smaller than spectrum noise level.
- The Spectrum noise level+Correction Factor < Limit - 6 dB
- Margin=Corrected Amplitude – Limit
- Corrected Amplitude=Radiated Amplitude+Antenna Correction Factor+Cable Loss-Pre-Amplifier Gain
- A margin of -8dB means that the emission is 8dB below the limit.

All frequencies from 1GHz to 25 GHz have been tested.

1GHz~ 25 GHz (Horizontal) , Channel 6 : 2437 MHz

Operator: Jerry Chiou

RBW: 1MHz
Humidity (%): 41
Temperature (C): 27

Frequency	Rx_R.	Ant_F.	Cab_L.	PreAmpl	Emission	Average Limit	Average Margin	Peak Limit	Peak Margin	Ant. Tower	Turn Table
MHz	dBuV	dB/m	dB	dB	dBuV/m	dBuV/m	dB	dBuV/m	dB	cm	deg
1794.21	53.36 pk	29.27	2.45	34.78	50.30 pk	54.00	-3.70	74.00	--	100	57
2106.39	49.10 pk	30.98	2.28	35.18	47.17 pk	54.00	-6.83	74.00	--	100	76
2311.19	50.59 pk	30.94	1.65	35.19	47.99 pk	54.00	-6.01	74.00	--	101	141
2333.67	53.53 pk	30.93	1.58	35.19	50.85 pk	54.00	-3.15	74.00	--	101	148
2366.13	58.32 pk	30.93	1.48	35.19	55.54 pk	54.00	--	74.00	-18.46	101	158
2366.13	43.42 av	30.93	1.48	35.19	40.64 av	54.00	-13.36	74.00	--	101	158
2378.62	59.98 pk	30.92	1.44	35.20	57.16 pk	54.00	--	74.00	-16.84	101	162
2378.62	44.01 av	30.92	1.44	35.20	41.17 av	54.00	-12.83	74.00	--	101	162
2483.52	54.98 pk	30.90	1.45	35.20	52.14 pk	54.00	-1.86	74.00	--	101	195
4873.78	56.58 pk	35.12	2.14	37.77	56.07 pk	54.00	--	74.00	-17.93	100.00	61.00
4873.78	41.80 av	35.12	2.14	37.77	41.29 av	54.00	-12.71	74.00	--	100.00	61.00
9747.89	47.20 pk	40.35	3.30	34.37	56.48 pk	54.00	--	74.00	-17.52	100.00	355
9747.89	34.66 av	40.35	3.30	34.37	43.94 av	54.00	-10.06	74.00	--	100.00	355

1GHz~ 25 GHz (Vertical), Channel 6 : 2437 MHz

Operator: Jerry Chiou

RBW: 1MHz
Humidity (%): 41
Temperature (C): 27

Frequency	Rx_R.	Ant_F.	Cab_L.	PreAmpl	Emission	Average Limit	Average Margin	Peak Limit	Peak Margin	Ant. Tower	Turn Table
MHz	dBuV	dB/m	dB	dB	dBuV/m	dBuV/m	dB	dBuV/m	dB	cm	deg
1794.21	55.20 pk	29.27	2.45	34.78	52.15 pk	54.00	-1.85	74.00	--	100	57
2361.14	54.17 pk	30.93	1.50	35.19	51.40 pk	54.00	-2.60	74.00	--	101	156
2371.13	56.16 pk	30.93	1.47	35.19	53.36 pk	54.00	-0.64	74.00	--	101	160
2388.61	55.89 pk	30.92	1.41	35.20	53.03 pk	54.00	-0.97	74.00	--	101	165
2773.23	51.15 pk	31.01	1.41	34.95	48.61 pk	54.00	-5.39	74.00	--	102	286
2995.5	50.48 pk	31.10	1.45	34.75	48.27 pk	54.00	-5.73	74.00	--	103	356
3092.91	50.84 pk	31.17	1.50	34.95	48.56 pk	54.00	-5.44	74.00	--	103	333
4873.94	55.58 pk	35.12	2.14	37.77	55.07 pk	54.00	--	74.00	-18.93	100.00	307
4873.94	42.03 av	35.12	2.14	37.77	41.52 av	54.00	-12.48	74.00	--	100.00	307
9747.96	52.42 pk	40.35	3.30	34.37	61.70 pk	54.00	--	74.00	-12.30	100.00	8.00
9747.96	39.68 av	40.35	3.30	34.37	48.96 av	54.00	-5.04	74.00	--	100.00	8.00

Note:

- According to the standards used, Where limits are specified by agencies for both average and peak (or quasi-peak) detection , if the peak (or quasi-peak) measured value complies with the average limit , it is unnecessary to perform an average measurement.
- “ * ”: Fundamental Frequency
- “***”: Not in the restricted band, Limit level=Fundamental Emission-20dB
- “ pk”: peak mode
- “av”: average mode
- “---“: No meter reading data due to the emission level is smaller than spectrum noise level.
- The Spectrum noise level+Correction Factor < Limit - 6 dB
- Margin=Corrected Amplitude – Limit
- Corrected Amplitude=Radiated Amplitude+Antenna Correction Factor+Cable Loss-Pre-Amplifier Gain
- A margin of -8dB means that the emission is 8dB below the limit.

All frequencies from 1GHz to 25 GHz have been tested.

1GHz~ 25 GHz (Horizontal), Channel 11: 2462 MHz

Operator: Jerry Chiou

RBW: 1MHz
Humidity (%): 41
Temperature (C): 27

Frequency	Rx_R.	Ant_F.	Cab_L.	PreAmpl	Emission	Average Limit	Average Margin	Peak Limit	Peak Margin	Ant. Tower	Turn Table
MHz	dBuV	dB/m	dB	dB	dBuV/m	dBuV/m	dB	dBuV/m	dB	cm	deg
1794.21	54.73 pk	29.27	2.45	34.78	51.67 pk	54.00	-2.33	74.00	--	100	57
2121.38	50.92 pk	30.98	2.23	35.18	48.94 pk	54.00	-5.06	74.00	--	100	81
2378.62	58.02 pk	30.92	1.44	35.20	55.20 pk	54.00	--	74.00	-18.80	101	162
2378.62	44.41 av	30.92	1.44	35.20	41.57 av	54.00	-12.43	74.00	--	101	162
2391.11	57.48 pk	30.92	1.42	35.20	54.62 pk	54.00	--	74.00	-19.38	101	166
2391.11	43.70 av	30.92	1.42	35.20	40.84 av	54.00	-13.16	74.00	--	101	166
2530.97	52.32 pk	30.91	1.37	35.17	49.43 pk	54.00	-4.57	74.00	--	102	210
2550.95	51.06 pk	30.92	1.37	35.15	48.20 pk	54.00	-5.80	74.00	--	102	216
4924.17	55.53 pk	35.31	2.15	37.83	55.16 pk	54.00	--	74.00	-18.84	100.00	74.00
4924.17	40.32 av	35.31	2.15	37.83	39.95 av	54.00	-14.05	74.00	--	100.00	74.00
9848.38	47.30 pk	40.13	3.35	34.41	56.38 pk	54.00	--	74.00	-17.62	100.00	13.00
9848.38	33.38 av	40.13	3.35	34.41	42.45 av	54.00	-11.55	74.00	--	100.00	13.00

1GHz~ 25 GHz (Vertical), Channel 11 : 2462 MHz

Operator: Jerry Chiou

RBW: 1MHz
Humidity (%): 41
Temperature (C): 27

Frequency	Rx_R.	Ant_F.	Cab_L.	PreAmpl	Emission	Average Limit	Average Margin	Peak Limit	Peak Margin	Ant. Tower	Turn Table
MHz	dBuV	dB/m	dB	dB	dBuV/m	dBuV/m	dB	dBuV/m	dB	cm	deg
1791.71	53.04 pk	29.25	2.45	34.77	49.96 pk	54.00	-4.04	74.00	--	100	57
2358.64	52.07 pk	30.93	1.51	35.19	49.31 pk	54.00	-4.69	74.00	--	101	156
2493.51	53.65 pk	30.90	1.40	35.20	50.75 pk	54.00	-3.25	74.00	--	101	198
3095.4	50.78 pk	31.18	1.50	34.96	48.50 pk	54.00	-5.50	74.00	--	103	332
3427.57	50.46 pk	31.44	1.67	35.68	47.89 pk	54.00	-6.11	74.00	--	103	247
4924.1	54.10 pk	35.31	2.15	37.83	53.74 pk	54.00	-0.26	74.00	--	100.00	138
9848.03	49.88 pk	40.13	3.35	34.41	58.96 pk	54.00	--	74.00	-15.04	100.00	339
9848.03	37.48 av	40.13	3.35	34.41	46.55 av	54.00	-7.45	74.00	--	100.00	339

Note:

- According to the standards used, Where limits are specified by agencies for both average and peak (or quasi-peak) detection , if the peak (or quasi-peak) measured value complies with the average limit , it is unnecessary to perform an average measurement.
- “ * ”: Fundamental Frequency
- “***”: Not in the restricted band, Limit level=Fundamental Emission-20dB
- “ pk” : peak mode
- “av”: average mode
- “---“: No meter reading data due to the emission level is smaller than spectrum noise level.
- The Spectrum noise level+Correction Factor < Limit - 6 dB
- Margin=Corrected Amplitude – Limit
- Corrected Amplitude=Radiated Amplitude+Antenna Correction Factor+Cable Loss-Pre-Amplifier Gain
- A margin of -8dB means that the emission is 8dB below the limit.

All frequencies from 1GHz to 25 GHz have been tested.

5.5 Band Edge Measurement

5.5.1 Test Procedure (Conducted)

1. The transmitter output of EUT was connected to the spectrum analyzer.
 Equipment mode: Spectrum analyzer
 Detector function: Peak mode
 SPAN: 100MHz
 RBW: 100KHz
 VBW: 100KHz
 Center frequency: 2.4GHz, 2.4835GHz.
2. Using Peak Search to read the peak power of Carrier frequencies after Maximum Hold function is completed
3. Find the next peak frequency outside the operation frequency band

5.5.2 Test Setup (Conducted)

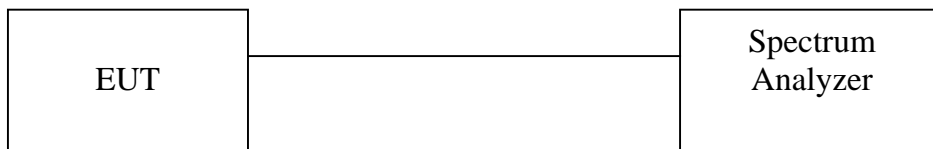

5.5.3 Test Data:

Table: Band Edge measurement (Conducted)

Temperature ():25

Test Engineer:Jerry Chiou

Humidity (%):50

Channel	Frequency (MHz)	Spectrum Reading (dBuV)	Carrier - Outsideband Limit: >20dB (dB)	Pass/Fail
1	2411.3	110.56	---	---
Outside band	2397.4	72.14	38.42	Pass
11	2462.6	111.85	---	---
Outside band	2474.5	69.95	41.90	Pass

Note: Two RF output(MAIN & AUX) have been test,the worse data shown above.

Band Edge Conducted measurement

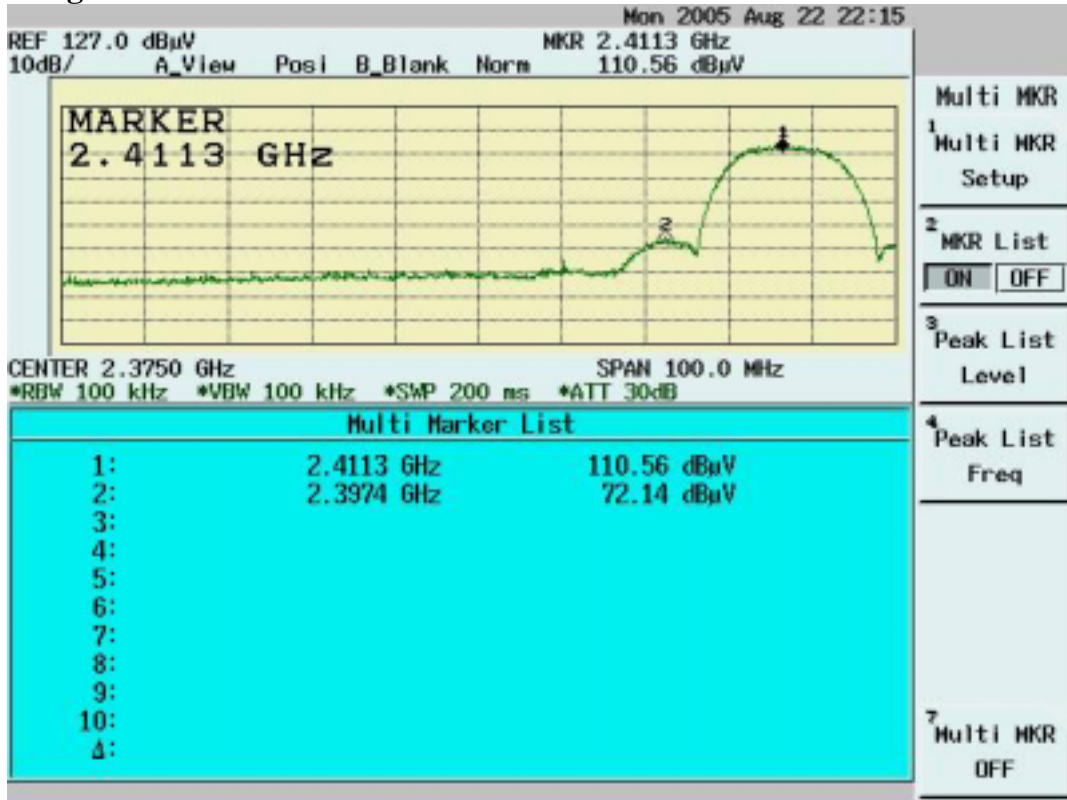

Band Edge Conducted Measurement

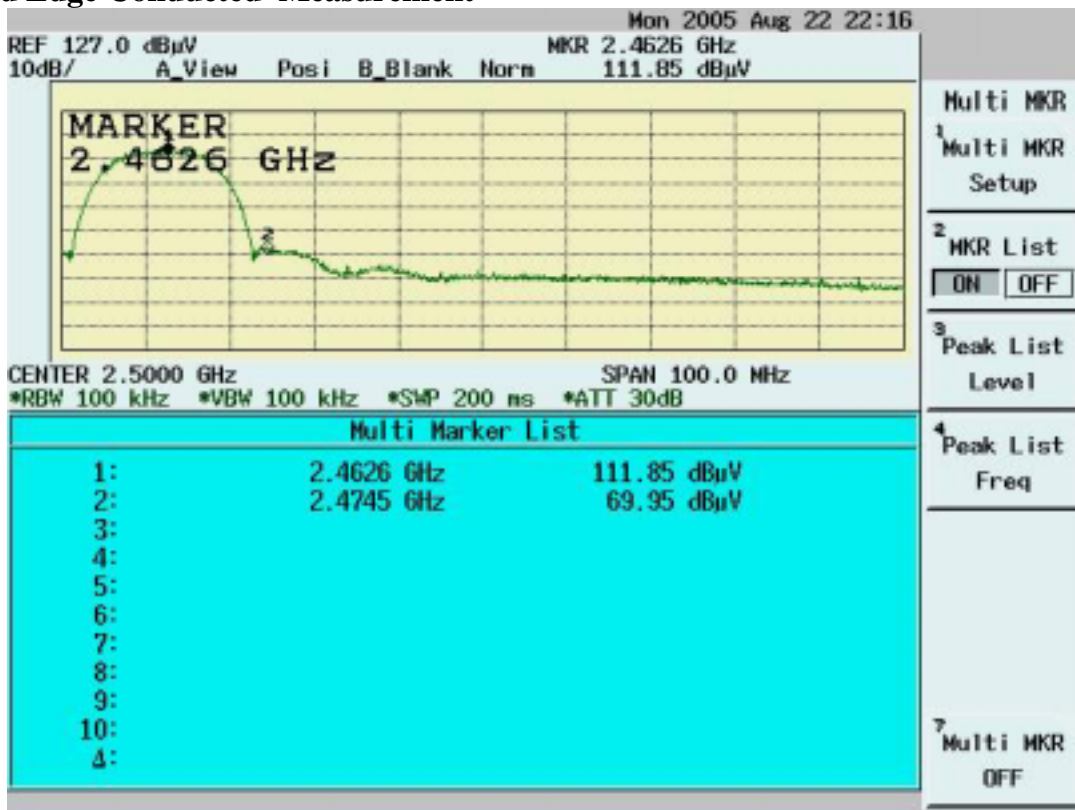

5.5.4 Test Procedure (Radiated)

1. Antenna and Turntable test procedure same as Radiated Emission Measurement.
Equipment mode: Spectrum analyzer
Detector function: Peak mode
SPAN: 100MHz
RBW: 1MHz
VBW: 3MHz
Center frequency: 2.395GHz, 2.48GHz.
2. Using Peak Search to read the peak power of Carrier frequencies after Maximum Hold function is completed.
3. Find the next peak frequency outside the operation frequency band
4. For peak frequency emission level measurement in Restricted Band
Change RBW: 1MHz
VBW: 10Hz
Span: 100MHz.
5. Get the spectrum reading after Maximum Hold function is completed.

5.5.5 Test Setup (Radiated)

Same as *Radiated Emission Measurement*

5.5.6 Test Data

Table Band Edge measurement (Radiated)

Temperature ():27

Test Engineer:Jerry Chiou

Humidity (%):45

Description	Frequency (MHz)	Spectrum Reading (dBuV)	Correction Factor (dB/m)	Emission Level (dBuV/m)	dBc (Limit: > 20dBc)	Limit (dBuV/m)	Equip. Setup VBW	Pass or Fail
Channel_1 (average mode)	2409.7	61.63	35.48	97.11	---	---	10Hz	---
Channel_1 (peak mode)	2410.5	70.76	35.48	106.24	---	---	3MHz	---
Outside band (peak mode)	2398.5	32.82	35.48	68.30	37.94	---	3MHz	Pass
Channel_11 (average mode)	2461.3	59.84	35.50	95.34	---	---	10Hz	---
Channel_11 (peak mode)	2460.4	68.70	35.50	104.20	---	---	3MHz	---
Outside band (peak mode)	2476.7	33.85	35.51	69.36	34.84	---	3MHz	Pass
Channel_1 Restricted band (peak mode)	2386.3	28.57	35.47	64.04	---	74	3MHz	Pass
Restricted band (average mode)	2386.2	10.51	35.47	45.98	---	54	10Hz	Pass
Channel_11 Restricted band (peak mode)	2483.8	31.14	35.51	66.65	---	74	3MHz	Pass
Restricted band (average mode)	2487.5	8.70	35.51	44.21	---	54	10Hz	Pass

Note:

- The Spectrum plot of emission level measurement in Restricted band is attached.
- Emission Level=Spectrum Reading+Correction Factor
- Correction Factor=Antenna Factor+cable loss–amplifier gain
- Both Horizontal and Vertical polarizaion have been tested and the worst data is listed above.

Band Edge measurement for radiated emission in Restricted Band(Radiated) Peak Mode (Channel 1)

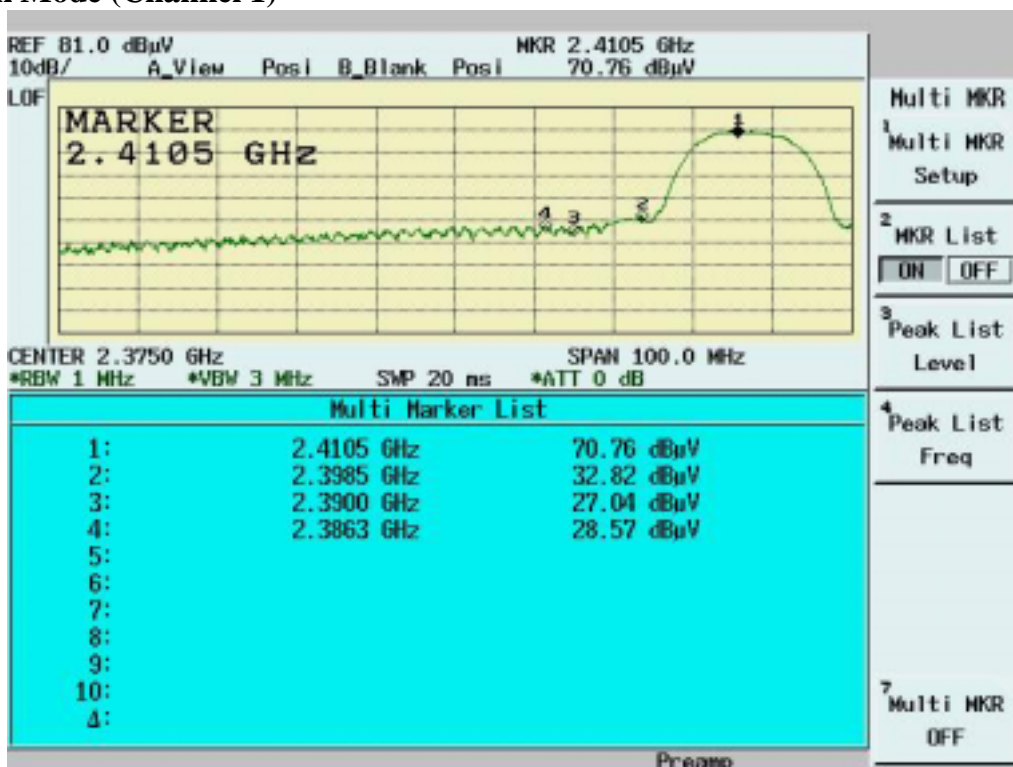

Band Edge measurement for radiated emission in Restricted Band(Radiated) Average Mode (Channel 1)

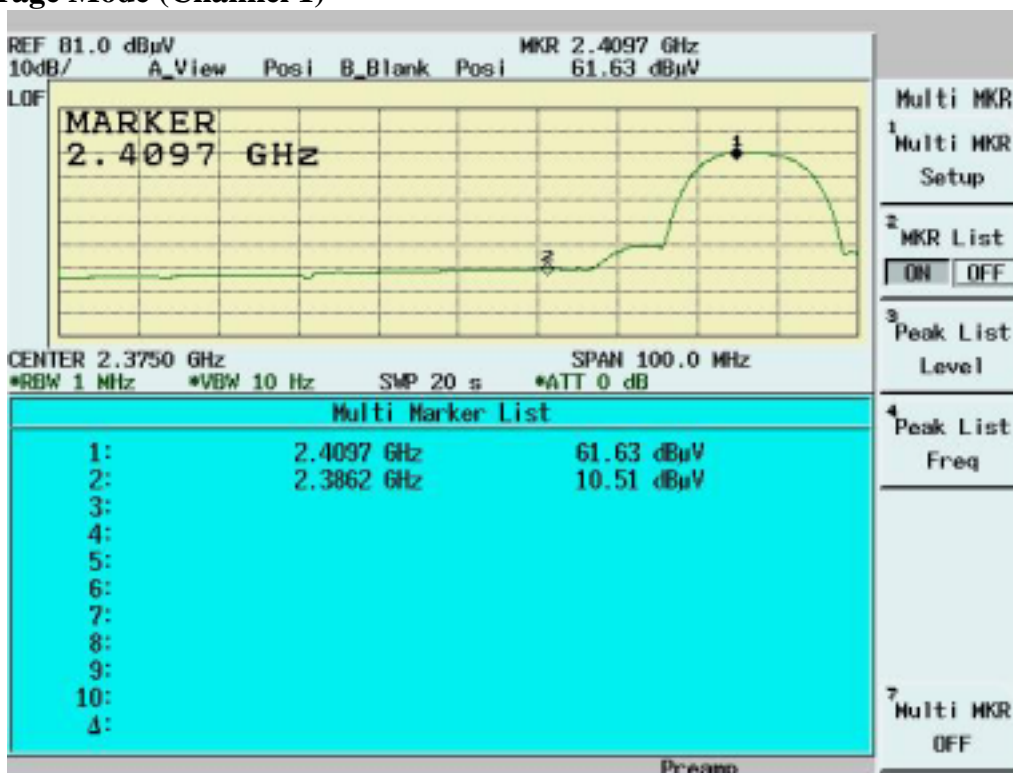

Band Edge measurement for radiated emission in Restricted Band(Radiated) Peak Mode (Channel 11)

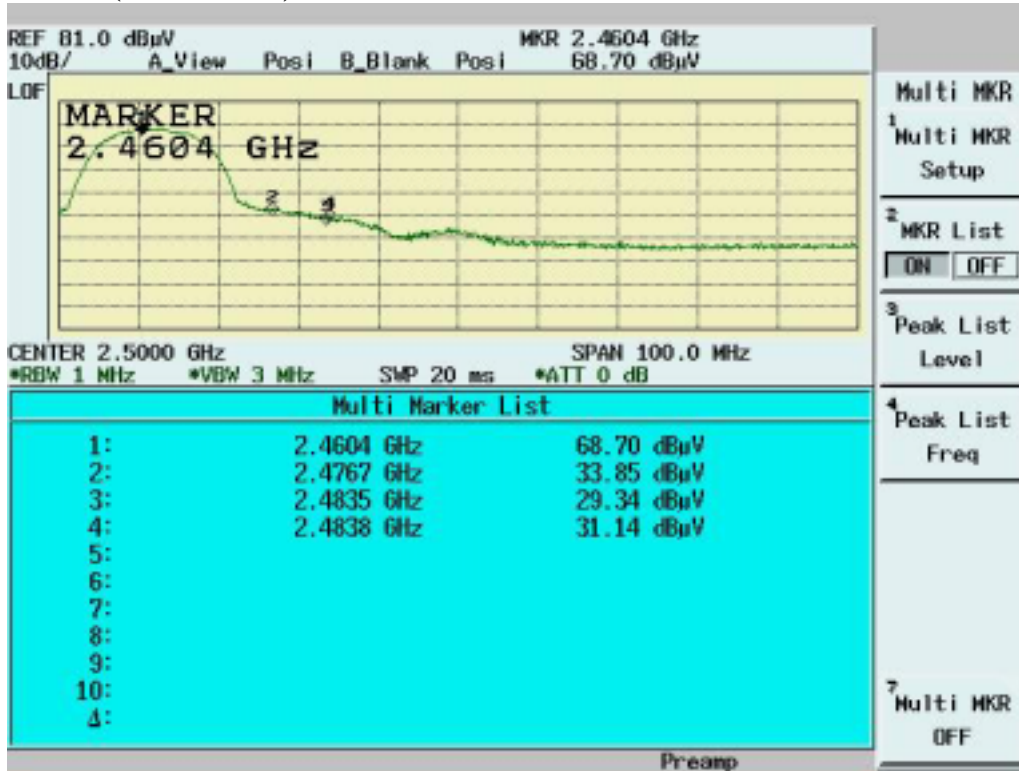

Band Edge measurement for radiated emission in Restricted Band(Radiated) Average Mode (Channel 11)

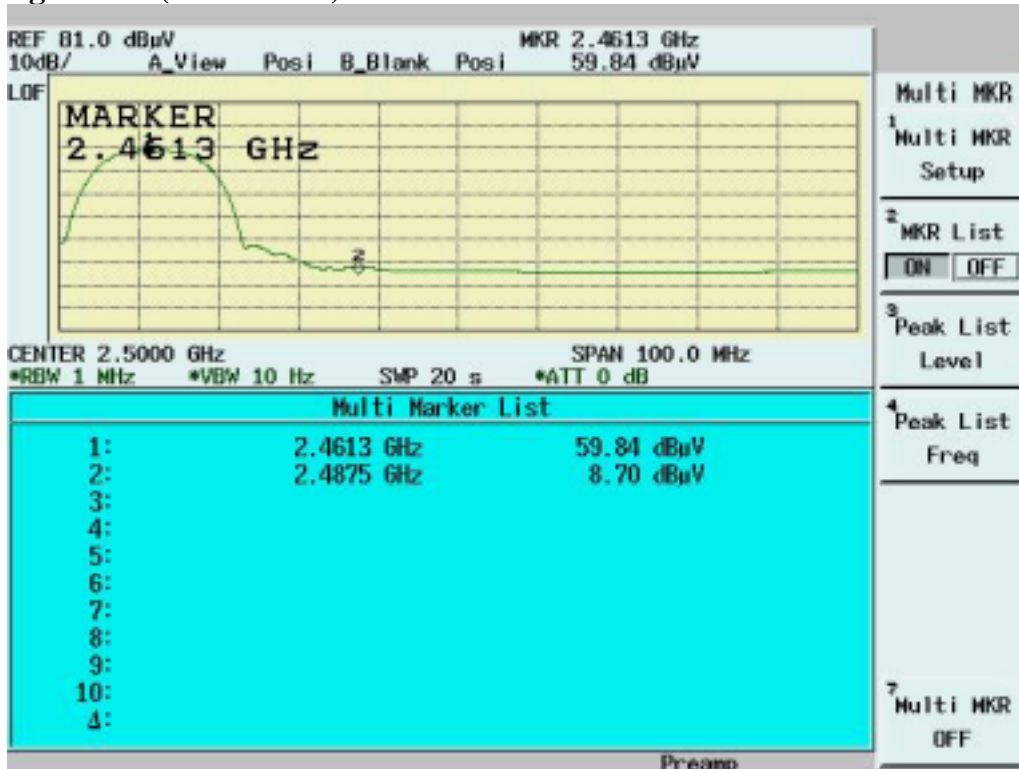

5.6 RF Exposure Measurement [Section 15.247(b)(4) & 1.1307(b)]

See SAR report

5.7 DSSS Peak Power Spectral Density [Section 15.247(d)]

5.7.1 Test Procedure

1. The Transmitter output of EUT was connected to the spectrum analyzer.
 Equipment mode: Spectrum analyzer
 Detector function: Peak mode
 SPAN:1.5MHz
 RBW: 3KHz
 VBW: 30KHz
 Center frequency: fundamental frequency tested.
 Sweep time= 500 sec.
2. Using Peak Search to read the peak power after Maximum Hold function is completed.

5.7.2 Test Setup



5.7.3 Test Data

Maximum Peak Output Power Density

Temperature ():25

Test Engineer:Jerry Chiou

Humidity (%):50

Channel	Frequency (MHz)	Spectrum Reading (dBm/3KHz)	Cable Loss (dB)	Peak Power Output (dBm/3KHz)	Limit (dBm/3KHz)	Pass/Fail
1	2412	-5.86	1.30	-4.56	8	Pass
6	2437	-4.39	1.30	-3.09	8	Pass
11	2462	-3.52	1.30	-2.22	8	Pass

Note: Two RF output(MAIN & AUX) have been test,the worse data shown above.

Channel 1

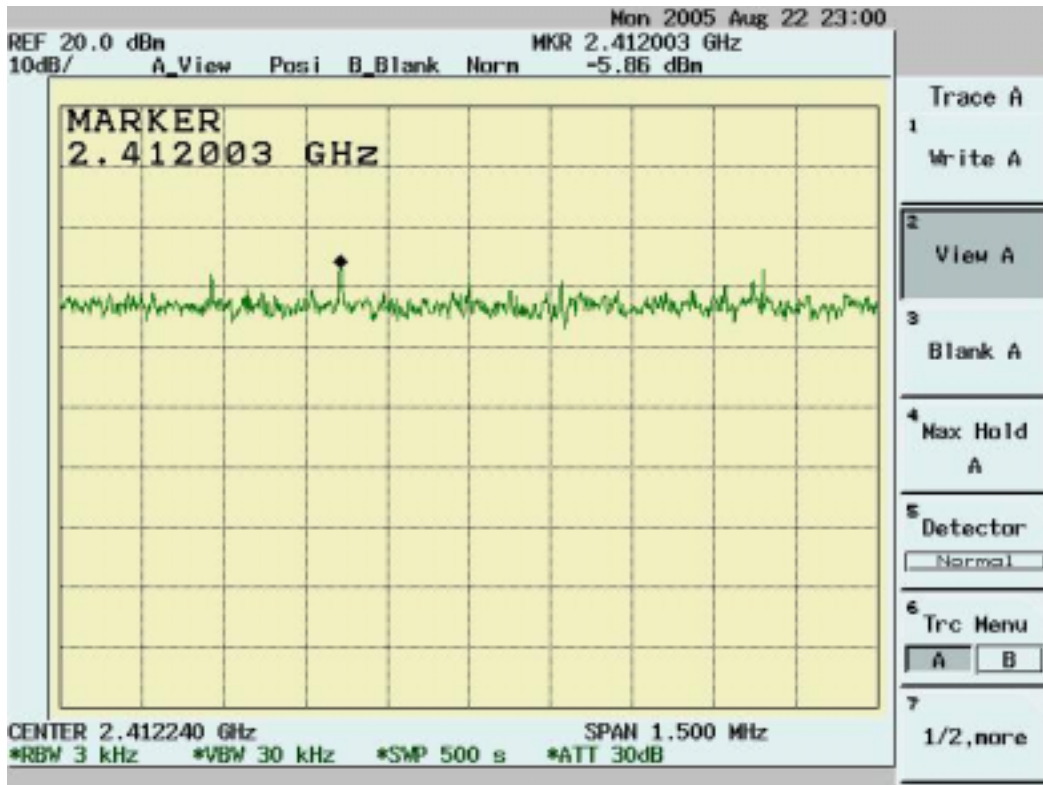

Channel 6

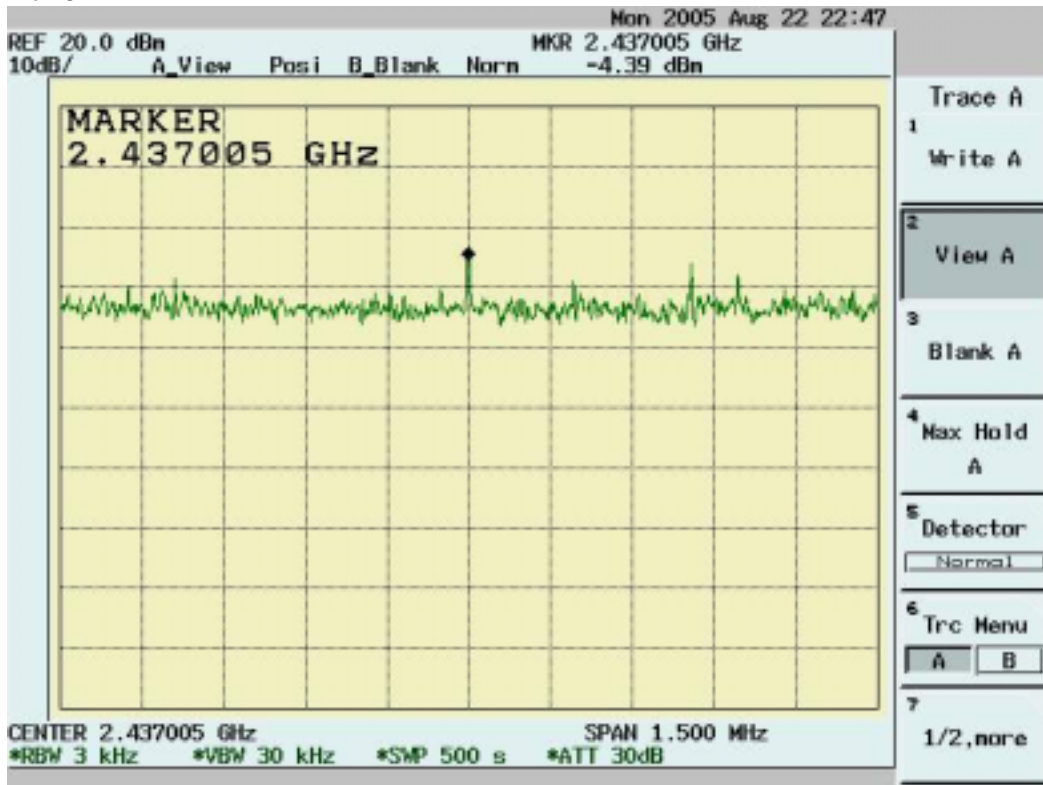

Channel 11

