

## FCC Test Report (WLAN)

**Report No.:** RFBCKS-WTW-P21100666-1

**FCC ID:** NKR-XIONEWN

**Test Model:** WNXI11AEIBCO

**Series Model:** WNXIxxAEIxCO (The fifth and sixth character "xx" can be 0 to 9, A to Z, a to z ; the tenth character "x" can be B=Black, G=Gray and W=White for external body color for product)

**Received Date:** 2021/10/21

**Test Date:** 2021/10/25 ~ 2021/11/16

**Issued Date:** 2021/12/14

**Applicant:** Wistron NeWeb Corp.

**Address:** 20 Park Avenue II, Hsinchu Science Park, Hsinchu 308, Taiwan, R.O.C.

**Issued By:** Bureau Veritas Consumer Products Services (H.K.) Ltd., Taoyuan Branch  
Hsin Chu Laboratory

**Lab Address:** E-2, No.1, Li Hsin 1st Road, Hsinchu Science Park, Hsinchu City 300,  
Taiwan

**Test Location:** E-2, No.1, Li Hsin 1st Road, Hsinchu Science Park, Hsinchu City 300,  
Taiwan

**FCC Registration /  
Designation Number:** 723255 / TW2022



This report is for your exclusive use. Any copying or replication of this report to or for any other person or entity, or use of our name or trademark, is permitted only with our prior written permission. This report sets forth our findings solely with respect to the test samples identified herein. The results set forth in this report are not indicative or representative of the quality or characteristics of the lot from which a test sample was taken or any similar or identical product unless specifically and expressly noted. Our report includes all of the tests requested by you and the results thereof based upon the information that you provided to us. You have 60 days from date of issuance of this report to notify us of any material error or omission caused by our negligence, provided, however, that such notice shall be in writing and shall specifically address the issue you wish to raise. A failure to raise such issue within the prescribed time shall constitute your unqualified acceptance of the completeness of this report, the tests conducted and the correctness of the report contents. Unless specific mention, the uncertainty of measurement has been explicitly taken into account to declare the compliance or non-compliance to the specification.

## Table of Contents

<b>Release Control Record .....</b>	<b>4</b>
<b>1 Certificate of Conformity .....</b>	<b>5</b>
<b>2 Summary of Test Results .....</b>	<b>6</b>
2.1 Measurement Uncertainty .....	6
2.2 Modification Record .....	6
<b>3 General Information .....</b>	<b>7</b>
3.1 General Description of EUT .....	7
3.2 Description of Test Modes .....	10
3.2.1 Test Mode Applicability and Tested Channel Detail .....	12
3.3 Duty Cycle of Test Signal .....	15
3.4 Description of Support Units .....	16
3.4.1 Configuration of System under Test .....	16
3.5 General Description of Applied Standard and References .....	17
<b>4 Test Types and Results .....</b>	<b>18</b>
4.1 Radiated Emission and Bandedge Measurement .....	18
4.1.1 Limits of Radiated Emission and Bandedge Measurement .....	18
4.1.2 Test Instruments .....	19
4.1.3 Test Procedure .....	22
4.1.4 Deviation from Test Standard .....	23
4.1.5 Test Setup .....	23
4.1.6 EUT Operating Condition .....	24
4.1.7 Test Results .....	25
4.2 Conducted Emission Measurement .....	69
4.2.1 Limits of Conducted Emission Measurement .....	69
4.2.2 Test Instruments .....	69
4.2.3 Test Procedure .....	70
4.2.4 Deviation from Test Standard .....	70
4.2.5 Test Setup .....	70
4.2.6 EUT Operating Condition .....	70
4.2.7 Test Results .....	71
4.3 Transmit Power Measurement .....	73
4.3.1 Limits of Transmit Power Measurement .....	73
4.3.2 Test Setup .....	73
4.3.3 Test Instruments .....	74
4.3.4 Test Procedure .....	74
4.3.5 Deviation from Test Standard .....	74
4.3.6 EUT Operating Condition .....	74
4.3.7 Test Results .....	75
4.4 Occupied Bandwidth Measurement .....	102
4.4.1 Test Setup .....	102
4.4.2 Test Instruments .....	102
4.4.3 Test Procedure .....	102
4.4.4 Test Results .....	103
4.5 Peak Power Spectral Density Measurement .....	110
4.5.1 Limits of Peak Power Spectral Density Measurement .....	110
4.5.2 Test Setup .....	110
4.5.3 Test Instruments .....	110
4.5.4 Test Procedure .....	110
4.5.5 Deviation from Test Standard .....	111
4.5.6 EUT Operating Condition .....	111
4.5.7 Test Results .....	112

4.6	Frequency Stability Measurement.....	117
4.6.1	Limits of Frequency Stability Measurement .....	117
4.6.2	Test Setup.....	117
4.6.3	Test Instruments .....	117
4.6.4	Test Procedure .....	117
4.6.5	Deviation from Test Standard .....	117
4.6.6	EUT Operating Condition .....	117
4.6.7	Test Results .....	118
4.7	6dB Bandwidth Measurement.....	119
4.7.1	Limits of 6dB Bandwidth Measurement.....	119
4.7.2	Test Setup.....	119
4.7.3	Test Instruments .....	119
4.7.4	Test Procedure .....	119
4.7.5	Deviation from Test Standard .....	119
4.7.6	EUT Operating Condition .....	119
4.7.7	Test Results .....	120
<b>5</b>	<b>Pictures of Test Arrangements.....</b>	<b>122</b>
	<b>Annex A - Radiated Out of Band Emission (OOBE) Measurement (For U-NII-3 band) .....</b>	<b>123</b>
	<b>Annex B - Band-Edge Measurement (For U-NII-1, U-NII-2A, U-NII-2C band) .....</b>	<b>126</b>
	<b>Appendix – Information of the Testing Laboratories .....</b>	<b>134</b>

### Release Control Record

Issue No.	Description	Date Issued
RFBCKS-WTW-P21100666-1	Original release.	2021/12/14

## 1 Certificate of Conformity

**Product:** STB (Set Top Box), XiOne-WN

**Brand:** Xfinity

**Test Model:** WNXI11AEIBCO

**Series Model:** WNXIxxAEIxCO (The fifth and sixth character "xx" can be 0 to 9, A to Z, a to z ; the tenth character "x" can be B=Black, G=Gray and W=White for external body color for product)

**Sample Status:** Engineering sample

**Applicant:** Wistron NeWeb Corp.

**Test Date:** 2021/10/25 ~ 2021/11/16

**Standard:** 47 CFR FCC Part 15, Subpart E (Section 15.407)  
ANSI C63.10: 2013

The above equipment has been tested by **Bureau Veritas Consumer Products Services (H.K.) Ltd., Taoyuan Branch**, and found compliance with the requirement of the above standards. The test record, data evaluation & Equipment Under Test (EUT) configurations represented herein are true and accurate accounts of the measurements of the sample's EMC characteristics under the conditions specified in this report.

**Prepared by :** Vivian Huang , **Date:** 2021/12/14  
Vivian Huang / Specialist

**Approved by :** Clark Lin , **Date:** 2021/12/14  
Clark Lin / Technical Manager

## 2 Summary of Test Results

47 CFR FCC Part 15, Subpart E (Section 15.407)			
FCC Clause	Test Item	Result	Remarks
15.407(b)(6)	AC Power Conducted Emissions	Pass	Meet the requirement of limit. Minimum passing margin is -6.51dB at 4.56641 MHz.
15.407(b) (1/2/3/4(i/ii)/6)	Radiated Emissions & Band Edge Measurement*	Pass	Meet the requirement of limit. Minimum passing margin is -0.1 dB at 5350.00 MHz, 5150.00 MHz and 5455.40 MHz.
15.407(a)(1/2/3)	Max Average Transmit Power	Pass	Meet the requirement of limit.
---	Occupied Bandwidth Measurement	-	Reference only.
15.407(a)(1/2/3)	Peak Power Spectral Density	Pass	Meet the requirement of limit.
15.407(e)	6dB bandwidth	Pass	Meet the requirement of limit. (U-NII-3 Band only)
15.407(g)	Frequency Stability	Pass	Meet the requirement of limit.
15.203	Antenna Requirement	Pass	No antenna connector is used.

### Note:

- For U-NII-3 band compliance with rule part 15.407(b)(4)(i), the OOB test plots were recorded in Annex A.
- For U-NII-1, U-NII-2A, U-NII-2C band compliance with rule 15.407(b) of the band-edge items, the test plots were recorded in Annex B. Test Procedures refer to report 4.1.3.
- Determining compliance based on the results of the compliance measurement, not taking into account measurement instrumentation uncertainty.

### 2.1 Measurement Uncertainty

Where relevant, the following measurement uncertainty levels have been estimated for tests performed on the EUT as specified in CISPR 16-4-2:

Measurement	Frequency	Expanded Uncertainty (k=2) ( $\pm$ )
Conducted Emissions at mains ports	150kHz ~ 30MHz	1.9 dB
Radiated Emissions up to 1 GHz	9kHz ~ 30MHz	3.1 dB
	30MHz ~ 1GHz	5.5 dB
Radiated Emissions above 1 GHz	1GHz ~ 18GHz	5.1 dB
	18GHz ~ 40GHz	5.3 dB

### 2.2 Modification Record

There were no modifications required for compliance.

### 3 General Information

#### 3.1 General Description of EUT

Product	STB (Set Top Box), XiOne-WN
Brand	Xfinity
Test Model	WNXI11AEIBCO
Series Model	WNXIxxAEIxCO (The fifth and sixth character “xx” can be 0 to 9, A to Z, a to z ; the tenth character “x” can be B=Black, G=Gray and W=White for external body color for product)
Status of EUT	Engineering sample
Power Supply Rating	Refer to Note
Modulation Type	64QAM, 16QAM, QPSK, BPSK for OFDM 256QAM for OFDM in 11ac mode 1024QAM for OFDMA in 11ax HE mode
Modulation Technology	OFDM, OFDMA
Transfer Rate	802.11a: up to 54 Mbps 802.11n: up to 300 Mbps 802.11ac: up to 866.7 Mbps 802.11ax: up to 1201.0 Mbps
Operating Frequency	5.18~5.32GHz, 5.50~5.72GHz, 5.745 ~ 5.825GHz
Number of Channel	802.11a, 802.11n (HT20), 802.11ac (VHT20), 802.11ax (HE20): 25 802.11n (HT40), 802.11ac (VHT40), 802.11ax (HE40): 12 802.11ac (VHT80), 802.11ax (HE80): 6
Output Power	<b>CDD Mode</b> <b>5.18 ~ 5.24 GHz:</b> 212.843 mW <b>5.26 ~ 5.32GHz:</b> 197.055 mW <b>5.5 ~ 5.72GHz:</b> 197.319 mW <b>5.745 ~ 5.825 GHz:</b> 419.819 mW <b>Beamforming Mode</b> <b>5.18 ~ 5.24 GHz:</b> 199.082 mW <b>5.26 ~ 5.32GHz:</b> 98.957 mW <b>5.5 ~ 5.72GHz:</b> 99.794 mW <b>5.745 ~ 5.825 GHz:</b> 419.819 mW
Antenna Type	Refer to Note
Antenna Connector	Refer to Note
Accessory Device	Adapter x1
Cable Supplied	NA

Note:

- The EUT has below model names, which are identical to each other in all aspects except for the following table:

Brand	Model No.	Description
Xfinity	WNXI11AEIBCO	For marketing purposes.
	WNXIxxAEIxCO (The fifth and sixth character “xx” can be 0 to 9, A to Z, a to z ; the tenth character “x” can be B=Black, G=Gray and W=White for external body color for product)	

From the above models, model: **WNXI11AEIBCO** was selected as representative model for the test and its data was recorded in this report.

- There are WLAN, Bluetooth and Zigbee technology used for the EUT

3. Simultaneously transmission condition.

Condition	Technology	
1	WLAN 2.4GHz	Bluetooth
2	WLAN 5GHz	Bluetooth
3	WLAN 2.4GHz	Zigbee
4	WLAN 5GHz	Zigbee

Note: The emission of the simultaneous operation has been evaluated and no non-compliance was found.

4. The antennas provided to the EUT, please refer to the following table:

Antenna NO.	RF Chain NO.	Antenna Net Gain(dBi)	Frequency range	Antenna Type	Connector Type
1	0	2.93	2.4~2.4835GHz	Printed	NA
		3.84	5.15~5.85GHz		
2	1	2.7	2.4~2.4835GHz	Printed	NA
		4.03	5.15~5.85GHz		
3 (For BT/Zigbee)	2	1.17	2.4~2.4835GHz	Printed	NA

5. The EUT must be supplied with a power adapter and the following different models could be chosen:

No	Brand	Model No.	Spec.
1	AcBel	WAK010	Input: 100-120 Vac, 0.25 A, -60 Hz Output: 5 Vdc, 1.5 A DC output cable (Unshielded, 1.5 m)
2	Leader	ML08-7050150-A1	Input: 100-120 Vac, 0.25 A, ~50/60 Hz Output: 5 Vdc, 1.5 A DC output cable (Unshielded, 1.5 m)

Note: From the above adapters, the AC Power Conducted Emissions and Radiated Emissions test worst case was found in **Adapter No.: 1**. Therefore only the test data of the mode was recorded in this report.

6. The EUT incorporates a MIMO function:

5GHz Band		
MODULATION MODE	TX & RX CONFIGURATION	
802.11a	2TX	2RX
802.11n (HT20)	2TX	2RX
802.11n (HT40)	2TX	2RX
802.11ac (VHT20)	2TX	2RX
802.11ac (VHT40)	2TX	2RX
802.11ac (VHT80)	2TX	2RX
802.11ax (HE20)	2TX	2RX
802.11ax (HE40)	2TX	2RX
802.11ax (HE80)	2TX	2RX

Note:

- All of modulation mode support beamforming function except 802.11a modulation mode.
- The EUT support Beamforming and CDD mode, therefore both mode were investigated and the worst case scenario was identified. The worst case data were presented in test report.
- The modulation and bandwidth are similar for 802.11n mode for 20MHz (40MHz), 802.11ac mode for 20MHz (40MHz, 80MHz) and 802.11ax mode for 20MHz (40MHz, 80MHz), therefore the manufacturer will control the power for 802.11n/ac mode is the same as the 802.11ax mode or more lower than it and investigated worst case to representative mode in test report. (Final test mode refer to section 3.2.1)



7. The above EUT information is declared by manufacturer and for more detailed features description, please refer to the manufacturer's specifications or user's manual.
8. The above Antenna information is declared by manufacturer and for more detailed features description, please refer to the manufacturer's specifications, the laboratory shall not be held responsible.

### 3.2 Description of Test Modes

#### FOR 5180 ~ 5320MHz

8 channels are provided for 802.11a, 802.11n (HT20), 802.11ac (VHT20) and 802.11ax (HE20):

Channel	Frequency	Channel	Frequency
36	5180 MHz	52	5260 MHz
40	5200 MHz	56	5280 MHz
44	5220 MHz	60	5300 MHz
48	5240 MHz	64	5320 MHz

4 channels are provided for 802.11n (HT40), 802.11ac (VHT40) and 802.11ax (HE40):

Channel	Frequency	Channel	Frequency
38	5190 MHz	54	5270 MHz
46	5230 MHz	62	5310 MHz

2 channel is provided for 802.11ac (VHT80), 802.11ax (HE80):

Channel	Frequency	Channel	Frequency
42	5210 MHz	58	5290 MHz

### FOR 5500 ~ 5720MHz

12 channels are provided for 802.11a, 802.11n (HT20), 802.11ac (VHT20) and 802.11ax (HE20):

Channel	Frequency	Channel	Frequency
100	5500 MHz	124	5620 MHz
104	5520 MHz	128	5640 MHz
108	5540 MHz	132	5660 MHz
112	5560 MHz	136	5680 MHz
116	5580 MHz	140	5700 MHz
120	5600 MHz	144	5720 MHz

6 channels are provided for 802.11n (HT40), 802.11ac (VHT40) and 802.11ax (HE40):

Channel	Frequency	Channel	Frequency
102	5510 MHz	126	5630 MHz
110	5550 MHz	134	5670 MHz
118	5590 MHz	142	5710 MHz

3 channels are provided for 802.11ac (VHT80), 802.11ax (HE80):

Channel	Frequency	Channel	Frequency
106	5530 MHz	138	5690 MHz
122	5610 MHz		

### FOR 5745 ~ 5825MHz:

5 channels are provided for 802.11a, 802.11n (HT20), 802.11ac (VHT20) and 802.11ax (HE20):

Channel	Frequency	Channel	Frequency
149	5745 MHz	161	5805 MHz
153	5765 MHz	165	5825 MHz
157	5785 MHz		

2 channels are provided for 802.11n (HT40), 802.11ac (VHT40) and 802.11ax (HE40):

Channel	Frequency	Channel	Frequency
151	5755 MHz	159	5795 MHz

1 channel is provided for 802.11ac (VHT80), 802.11ax (HE80):

Channel	Frequency
155	5775 MHz

### 3.2.1 Test Mode Applicability and Tested Channel Detail

EUT Configure Mode	Applicable To				Description
	RE $\geq$ 1G	RE<1G	PLC	APCM	
-	√	√	√	√	-

Where **RE $\geq$ 1G**: Radiated Emission above 1GHz  
**RE<1G**: Radiated Emission below 1GHz  
**PLC**: Power Line Conducted Emission  
**APCM**: Antenna Port Conducted Measurement

#### **Radiated Emission Test (Above 1GHz):**

- Pre-Scan has been conducted to determine the worst-case mode from all possible combinations between available modulations, data rates and antenna ports (if EUT with antenna diversity architecture).
- Following channel(s) was (were) selected for the final test as listed below.

CDD Mode						
Mode	FREQ. Band (MHz)	Available Channel	Tested Channel	Modulation Technology	Modulation Type	Data Rate Parameter
802.11a	5180-5320	36 to 64	36, 40, 48, 52, 60, 64	OFDM	BPSK	6Mb/s
802.11ax (HE20)		36 to 64	36, 40, 48, 52, 60, 64	OFDMA	BPSK	MCS0
802.11ax (HE40)		38 to 62	38, 46, 54, 62	OFDMA	BPSK	MCS0
802.11ax (HE80)		42, 58	42, 58	OFDMA	BPSK	MCS0
802.11a	5500-5720	100 to 144	100, 116, 140, 144	OFDM	BPSK	6Mb/s
802.11ax (HE20)		100 to 144	100, 116, 140, 144	OFDMA	BPSK	MCS0
802.11ax (HE40)		102 to 142	102, 110, 134, 142	OFDMA	BPSK	MCS0
802.11ax (HE80)		106 to 138	106, 122, 138	OFDMA	BPSK	MCS0
802.11a	5745-5825	149 to 165	149, 157, 165	OFDM	BPSK	6Mb/s
802.11ax (HE20)		149 to 165	149, 157, 165	OFDMA	BPSK	MCS0
802.11ax (HE40)		151 to 159	151, 159	OFDMA	BPSK	MCS0
802.11ax (HE80)		155	155	OFDMA	BPSK	MCS0

#### **Radiated Emission Test (Below 1GHz):**

- Pre-Scan has been conducted to determine the worst-case mode from all possible combinations between available modulations, data rates and antenna ports (if EUT with antenna diversity architecture).
- Following channel(s) was (were) selected for the final test as listed below.

CDD Mode						
Mode	FREQ. Band (MHz)	Available Channel	Tested Channel	Modulation Technology	Modulation Type	Data Rate Parameter
802.11ax (HE40)	5180-5320 5500-5720 5745-5825	38 to 62 102 to 142 151 to 159	159	OFDMA	BPSK	MCS0

### Power Line Conducted Emission Test:

- Pre-Scan has been conducted to determine the worst-case mode from all possible combinations between available modulations, data rates and antenna ports (if EUT with antenna diversity architecture).
- Following channel(s) was (were) selected for the final test as listed below.

CDD Mode						
Mode	FREQ. Band (MHz)	Available Channel	Tested Channel	Modulation Technology	Modulation Type	Data Rate Parameter
802.11ax (HE40)	5180-5320	38 to 62	159	OFDMA	BPSK	MCS0
	5500-5720	102 to 142				
	5745-5825	151 to 159				

### Antenna Port Conducted Measurement:

- This item includes all test value of each mode, but only includes spectrum plot of worst value of each mode.
- Pre-Scan has been conducted to determine the worst-case mode from all possible combinations between available modulations, data rates and antenna ports (if EUT with antenna diversity architecture).
- Following channel(s) was (were) selected for the final test as listed below.

CDD Mode						
Mode	FREQ. Band (MHz)	Available Channel	Tested Channel	Modulation Technology	Modulation Type	Data Rate Parameter
802.11a	5180-5320	36 to 64	36, 40, 48, 52, 60, 64	OFDM	BPSK	6Mb/s
802.11ac (VHT20) (Output power only)		36 to 64	36, 40, 48, 52, 60, 64	OFDM	BPSK	MCS0
802.11ac (VHT40) (Output power only)		38 to 62	38, 46, 54, 62	OFDM	BPSK	MCS0
802.11ac (VHT80) (Output power only)		42, 58	42, 58	OFDM	BPSK	MCS0
802.11ax (HE20)		36 to 64	36, 40, 48, 52, 60, 64	OFDMA	BPSK	MCS0
802.11ax (HE40)		38 to 62	38, 46, 54, 62	OFDMA	BPSK	MCS0
802.11ax (HE80)		42, 58	42, 58	OFDMA	BPSK	MCS0
802.11a		5500-5720	100 to 144	100, 116, 140, 144	OFDM	BPSK
802.11ac (VHT20) (Output power only)	100 to 144		100, 116, 140, 144	OFDM	BPSK	MCS0
802.11ac (VHT40) (Output power only)	102 to 142		102, 110, 134, 142	OFDM	BPSK	MCS0
802.11ac (VHT80) (Output power only)	106 to 138		106, 122, 138	OFDM	BPSK	MCS0
802.11ax (HE20)	100 to 144		100, 116, 140, 144	OFDMA	BPSK	MCS0
802.11ax (HE40)	102 to 142		102, 110, 134, 142	OFDMA	BPSK	MCS0
802.11ax (HE80)	106 to 138		106, 122, 138	OFDMA	BPSK	MCS0

802.11a	5745-5825	149 to 165	149, 157, 165	OFDM	BPSK	6Mb/s
802.11ac (VHT20) (Output power only)		149 to 165	149, 157, 165	OFDM	BPSK	MCS0
802.11ac (VHT40) (Output power only)		151 to 159	151, 159	OFDM	BPSK	MCS0
802.11ac (VHT80) (Output power only)		155	155	OFDM	BPSK	MCS0
802.11ax (HE20)		149 to 165	149, 157, 165	OFDMA	BPSK	MCS0
802.11ax (HE40)		151 to 159	151, 159	OFDMA	BPSK	MCS0
802.11ax (HE80)		155	155	OFDMA	BPSK	MCS0

**Beamforming Mode (output power only)**

Mode	FREQ. Band (MHz)	Available Channel	Tested Channel	Modulation Technology	Modulation Type	Data Rate Parameter
802.11ac (VHT20)	5180-5320	36 to 64	36, 40, 48, 52, 60, 64	OFDM	BPSK	MCS0
802.11ac (VHT40)		38 to 62	38, 46, 54, 62	OFDM	BPSK	MCS0
802.11ac (VHT80)		42, 58	42, 58	OFDM	BPSK	MCS0
802.11ax (HE20)		36 to 64	36, 40, 48, 52, 60, 64	OFDMA	BPSK	MCS0
802.11ax (HE40)		38 to 62	38, 46, 54, 62	OFDMA	BPSK	MCS0
802.11ax (HE80)		42, 58	42, 58	OFDMA	BPSK	MCS0
802.11ac (VHT20)	5500-5720	100 to 144	100, 116, 140, 144	OFDM	BPSK	MCS0
802.11ac (VHT40)		102 to 142	102, 110, 134, 142	OFDM	BPSK	MCS0
802.11ac (VHT80)		106 to 138	106, 122, 138	OFDM	BPSK	MCS0
802.11ax (HE20)		100 to 144	100, 116, 140, 144	OFDMA	BPSK	MCS0
802.11ax (HE40)		102 to 142	102, 110, 134, 142	OFDMA	BPSK	MCS0
802.11ax (HE80)		106 to 138	106, 122, 138	OFDMA	BPSK	MCS0
802.11ac (VHT20)	5745-5825	149 to 165	149, 157, 165	OFDM	BPSK	MCS0
802.11ac (VHT40)		151 to 159	151, 159	OFDM	BPSK	MCS0
802.11ac (VHT80)		155	155	OFDM	BPSK	MCS0
802.11ax (HE20)		149 to 165	149, 157, 165	OFDMA	BPSK	MCS0
802.11ax (HE40)		151 to 159	151, 159	OFDMA	BPSK	MCS0
802.11ax (HE80)		155	155	OFDMA	BPSK	MCS0

**Test Condition:**

Applicable To	Environmental Conditions	Input Power	Tested By
<b>RE<sub>≥</sub>1G</b>	25deg. C, 66%RH	120Vac, 60Hz	Tom Yang, Carter Lin
<b>RE<sub>&lt;</sub>1G</b>	25deg. C, 66%RH	120Vac, 60Hz	Tom Yang
<b>PLC</b>	25deg. C, 66%RH	120Vac, 60Hz	Tom Yang
<b>APCM</b>	25deg. C, 60%RH	120Vac, 60Hz	Jim Hung

### 3.3 Duty Cycle of Test Signal

Duty cycle of test signal is 100 %, duty factor is not required.

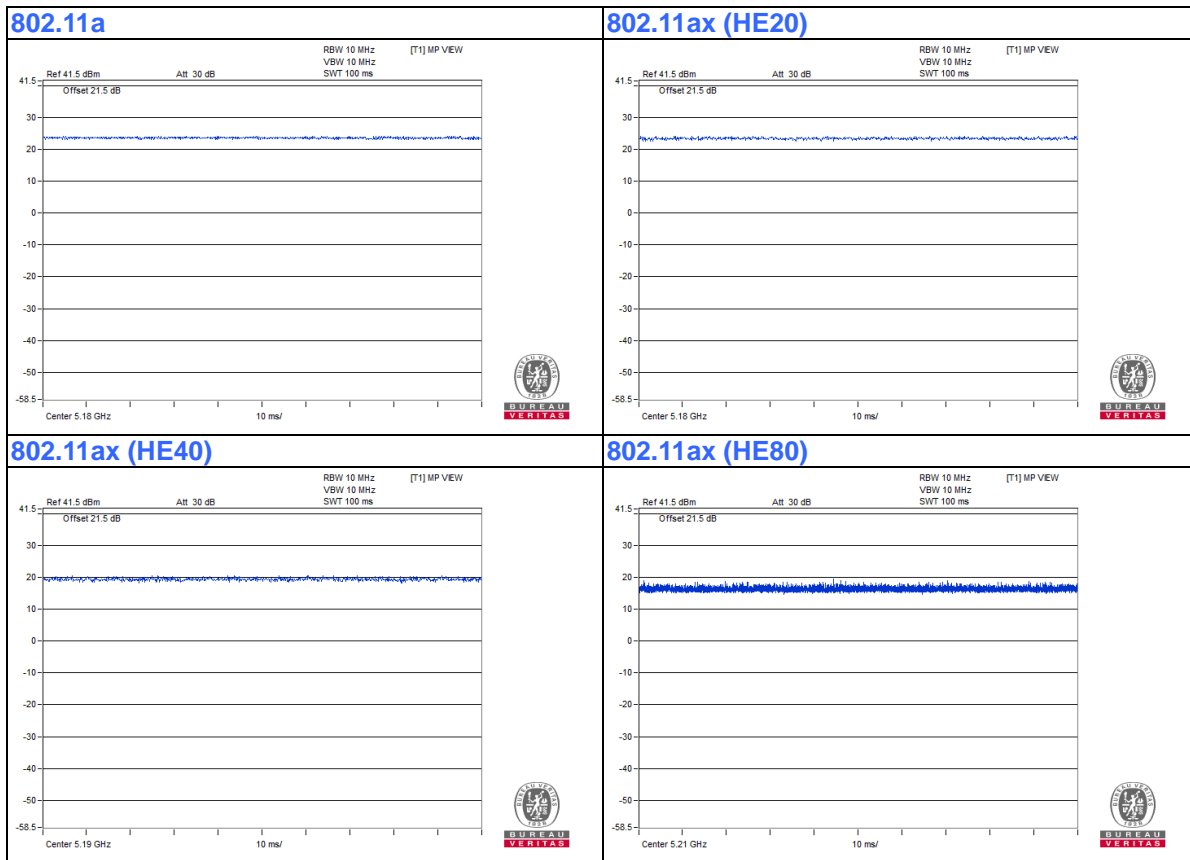

### 3.4 Description of Support Units

The EUT has been tested as an independent unit together with other necessary accessories or support units. The following support units or accessories were used to form a representative test configuration during the tests.

ID	Product	Brand	Model No.	Serial No.	FCC ID	Remarks
A.	Laptop	DELL	E5430	HYV4VY1	FCC DoC	Provided by Lab
B.	Monitor	DELL	P2415Q	CN-0J1P7F-QDC0 0-85L-13GB-A09	FCC DoC	Provided by Lab

Note:

- All power cords of the above support units are non-shielded (1.8m).

ID	Descriptions	Qty.	Length (m)	Shielding (Yes/No)	Cores (Qty.)	Remarks
1.	RJ-45 Cable	1	10	No	0	Provided by Lab
2.	HDMI Cable	1	1.8	Yes	0	Provided by Lab
3.	DC Cable	1	1.5	No	0	Supplied by applicant

#### 3.4.1 Configuration of System under Test

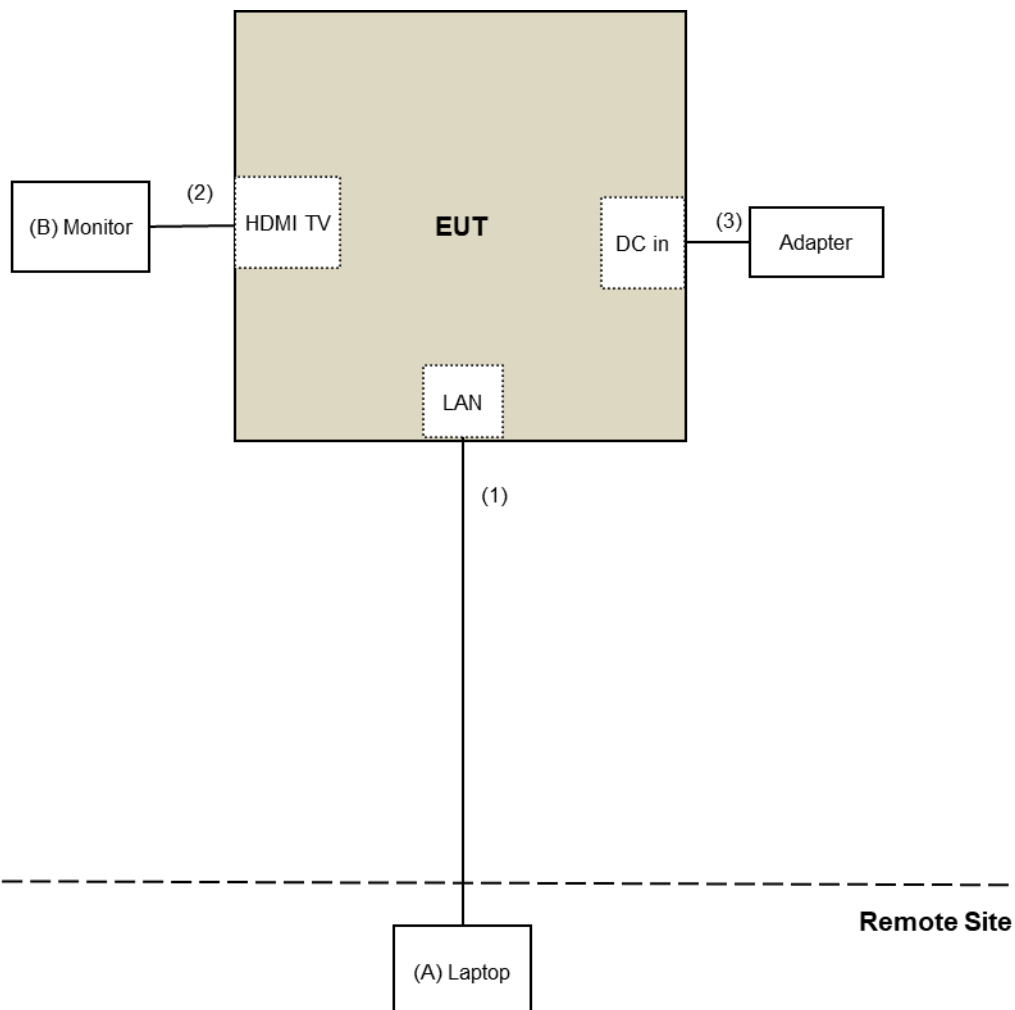



### 3.5 General Description of Applied Standard and References

The EUT is a RF Product. According to the specifications of the manufacturer, it must comply with the requirements of the following standards and references:

**Test Standard:**

**FCC Part 15, Subpart E (15.407)**

**ANSI C63.10-2013**

All test items have been performed and recorded as per the above standards.

**References Test Guidance:**

**KDB 789033 D02 General UNII Test Procedure New Rules v02r01**

**KDB 662911 D01 Multiple Transmitter Output v02r01**

All test items have been performed as a reference to the above KDB test guidance.

## 4 Test Types and Results

### 4.1 Radiated Emission and Bandedge Measurement

#### 4.1.1 Limits of Radiated Emission and Bandedge Measurement

Radiated emissions which fall in the restricted bands must comply with the radiated emission limits specified as below table.

Frequencies (MHz)	Field Strength (microvolts/meter)	Measurement Distance (meters)
0.009 ~ 0.490	2400/F(kHz)	300
0.490 ~ 1.705	24000/F(kHz)	30
1.705 ~ 30.0	30	30
30 ~ 88	100	3
88 ~ 216	150	3
216 ~ 960	200	3
Above 960	500	3

#### NOTE:

1. The lower limit shall apply at the transition frequencies.
2. Emission level (dBuV/m) = 20 log Emission level (uV/m).
3. For frequencies above 1000MHz, the field strength limits are based on average detector, however, the peak field strength of any emission shall not exceed the maximum permitted average limits, specified above by more than 20dB under any condition of modulation.

Limits of unwanted emission out of the restricted bands

Applicable To		Limit	
789033 D02 General UNII Test Procedure New Rules v02r01		Field Strength at 3m	
		PK:74 (dBuV/m)	AV:54 (dBuV/m)
Frequency Band	Applicable To	EIRP Limit	Equivalent Field Strength at 3m
5150~5250 MHz	15.407(b)(1)	PK:-27 (dBm/MHz)	PK:68.2(dBuV/m)
5250~5350 MHz	15.407(b)(2)		
5470~5725 MHz	15.407(b)(3)		
5725~5850 MHz	15.407(b)(4)(i)	PK:-27 (dBm/MHz) <sup>*1</sup> PK:10 (dBm/MHz) <sup>*2</sup> PK:15.6 (dBm/MHz) <sup>*3</sup> PK:27 (dBm/MHz) <sup>*4</sup>	PK: 68.2(dBuV/m) <sup>*1</sup> PK:105.2 (dBuV/m) <sup>*2</sup> PK: 110.8(dBuV/m) <sup>*3</sup> PK:122.2 (dBuV/m) <sup>*4</sup>
*1 beyond 75 MHz or more above of the band edge.		*2 below the band edge increasing linearly to 10 dBm/MHz at 25 MHz above.	
*3 below the band edge increasing linearly to a level of 15.6 dBm/MHz at 5 MHz above.		*4 from 5 MHz above or below the band edge increasing linearly to a level of 27 dBm/MHz at the band edge.	

#### Note:

The following formula is used to convert the equipment isotropic radiated power (eirp) to field strength:

$$E = \frac{1000000\sqrt{30P}}{3} \mu\text{V/m, where P is the eirp (Watts).}$$

## 4.1.2 Test Instruments

**For Radiated emission (below 1GHz) & Bandedge & OOB test:**

DESCRIPTION & MANUFACTURER	MODEL NO.	SERIAL NO.	CALIBRATED DATE	CALIBRATED UNTIL
Test Receiver Agilent	N9038A	MY51210202	2020/12/1	2021/11/30
Software	ADT_Radiated_V8.7.08	NA	NA	NA
Boresight Antenna Tower & Turn Table Max-Full	MF-7802BS	MF780208530	NA	NA
Pre_Amplifier EMCI	EMC001340	980142	2021/5/24	2022/5/23
LOOP ANTENNA Electro-Metrics	EM-6879	264	2021/3/5	2022/3/4
RF Coaxial Cable JYEBO	5D-FB	LOOPCAB-001	2021/1/7	2022/1/6
RF Coaxial Cable JYEBO	5D-FB	LOOPCAB-002	2021/1/7	2022/1/6
Pre_Amplifier EMCI	EMC330N	980701	2021/3/10	2022/3/9
Trilog Broadband Antenna Schwarzbeck	VULB 9168	9168-406	2020/11/6	2021/11/5
RF Coaxial Cable COMMATE/PEWC	8D	966-4-1	2021/3/17	2022/3/16
RF Coaxial Cable COMMATE/PEWC	8D	966-4-2	2021/3/17	2022/3/16
RF Coaxial Cable COMMATE/PEWC	8D	966-4-3	2021/3/17	2022/3/16
Fixed attenuator Mini-Circuits	UNAT-5+	PAD-ATT5-03	2021/1/11	2022/1/10
Horn Antenna SCHWARZBECK	BBHA 9120D	9120D-783	2020/11/22	2021/11/21
Pre_Amplifier EMCI	EMC 12630 SE	980638	2021/4/7	2022/4/6
RF Cable-Frequency Range : 1-26.5GHz EMCI	EMC104-SM-SM-1200	160922	2020/12/25	2021/12/24
RF Coaxial Cable EMCI	EMC104-SM-SM-2000	180502	2021/4/26	2022/4/25
RF Coaxial Cable EMCI	EMC104-SM-SM-6000	180418	2021/4/26	2022/4/25
Pre_Amplifier EMCI	EMC184045SE	980387	2021/1/11	2022/1/10
Horn Antenna Schwarzbeck	BBHA 9170	BBHA9170519	2020/11/22	2021/11/21
RF Cable-Frequency range: 1-40GHz EMCI	EMC102-KM-KM-1200	160924	2021/1/11	2022/1/10
RF cable (40GHz) EMCI	EMC-KM-KM-4000	200214	2021/3/10	2022/3/9

**Note:**

1. The calibration interval of the above test instruments is 12 months and the calibrations are traceable to NML/ROC and NIST/USA.
2. The test was performed in 966 Chamber No. 4.
3. Tested Date: 2021/10/25 ~ 2021/10/28

**For Radiated emission (above 1GHz) test:**

DESCRIPTION & MANUFACTURER	MODEL NO.	SERIAL NO.	CALIBRATED DATE	CALIBRATED UNTIL
Signal Analyzer Keysight	N9010A	MY56070348	2021/9/15	2022/9/14
Software	ADT_Radiated_V8.7.08	NA	NA	NA
Boresight Antenna Tower & Turn Table Max-Full	MF-7802BS	MF780208530	NA	NA
Horn Antenna Schwarzbeck	BBHA 9120D	9120D-783	2021/11/14	2022/11/13
Pre_Amplifier EMCI	EMC 12630 SE	980638	2021/4/7	2022/4/6
RF Cable-Frequency Range : 1-26.5GHz EMCI	EMC104-SM-SM-1200	160922	2020/12/25	2021/12/24
RF Coaxial Cable EMCI	EMC104-SM-SM-2000	180502	2021/4/26	2022/4/25
RF Coaxial Cable EMCI	EMC104-SM-SM-6000	180418	2021/4/26	2022/4/25
Pre_Amplifier EMCI	EMC184045SE	980387	2021/1/11	2022/1/10
Horn Antenna Schwarzbeck	BBHA 9170	BBHA9170519	2021/11/14	2022/11/13
RF Cable-Frequency range: 1-40GHz EMCI	EMC102-KM-KM-1200	160924	2021/1/11	2022/1/10
RF cable (40GHz) EMCI	EMC-KM-KM-4000	200214	2021/3/10	2022/3/9

**Note:**

1. The calibration interval of the above test instruments is 12 months and the calibrations are traceable to NML/ROC and NIST/USA.
2. The test was performed in 966 Chamber No. 4.
3. Tested Date: 2021/11/15 ~ 2021/11/16

**For other test items:**

DESCRIPTION & MANUFACTURER	MODEL NO.	SERIAL NO.	CALIBRATED DATE	CALIBRATED UNTIL
Spectrum Analyzer R&S	FSV40	101516	2021/3/8	2022/3/7
Power Meter Anritsu	ML2495A	1529002	2021/6/21	2022/6/20
Pulse Power Sensor Anritsu	MA2411B	1339443	2021/5/31	2022/5/30
Attenuator WOKEN	MDCS18N-10	MDCS18N-10-01	2021/4/13	2022/4/12
Software	ADT_RF Test Software V6.6.5.4	NA	NA	NA
AC Power Source GOOD WILL	6905S	1991551	NA	NA
Temperature & Humidity Chamber Giant Force	GTH-150-40-SP-AR	MAA0812-008	2021/1/14	2022/1/13
True RMS Clamp Meter Fluke	325	31130711WS	2021/6/2	2022/6/1

- NOTE:**
1. The test was performed in Oven room 2.
  2. The calibration interval of the above test instruments is 12 months and the calibrations are traceable to NML/ROC and NIST/USA.
  3. Tested Date: 2021/11/11 ~ 2021/11/16

#### 4.1.3 Test Procedure

##### **For Radiated emission below 30MHz**

- a. The EUT was placed on the top of a rotating table 0.8 meters above the ground at a 3 meter chamber room. The table was rotated 360 degrees to determine the position of the highest radiation.
- b. The EUT was set 3 meters away from the interference-receiving antenna, which was mounted on the top of a variable-height antenna tower.
- c. Parallel, perpendicular, and ground-parallel orientations of the antenna are set to make the measurement.
- d. For each suspected emission, the EUT was arranged to its worst case and the rotatable table was turned from 0 degrees to 360 degrees to find the maximum reading.
- e. The test-receiver system was set to Quasi-Peak Detect Function and Specified Bandwidth with Maximum Hold Mode.

##### **Note:**

1. The resolution bandwidth and video bandwidth of test receiver/spectrum analyzer is 9kHz at frequency below 30MHz.

##### **For Radiated emission above 30MHz**

- a. The EUT was placed on the top of a rotating table 0.8 meters (for 30MHz ~ 1GHz) / 1.5 meters (for above 1GHz) above the ground at 3 meter chamber room for test. The table was rotated 360 degrees to determine the position of the highest radiation.
- b. The EUT was set 3 meters away from the interference-receiving antenna, which was mounted on the top of a variable-height antenna tower.
- c. The height of antenna is varied from one meter to four meters above the ground to determine the maximum value of the field strength. Both horizontal and vertical polarizations of the antenna are set to make the measurement.
- d. For each suspected emission, the EUT was arranged to its worst case and then the antenna was tuned to heights from 1 meter to 4 meters and the rotatable table was turned from 0 degrees to 360 degrees to find the maximum reading.
- e. The test-receiver system was set to quasi-peak detect function and specified bandwidth with maximum hold mode when the test frequency is below 1 GHz.
- f. The test-receiver system was set to peak and average detects function and specified bandwidth with maximum hold mode when the test frequency is above 1 GHz. If the peak reading value also meets average limit, measurement with the average detector is unnecessary.

##### **Note:**

1. The resolution bandwidth and video bandwidth of test receiver/spectrum analyzer is 120kHz for Quasi-peak detection (QP) at frequency below 1GHz.
2. The resolution bandwidth of test receiver/spectrum analyzer is 1 MHz and the video bandwidth is 3 MHz for Peak detection (PK) at frequency above 1GHz.
3. The resolution bandwidth of test receiver/spectrum analyzer is 1MHz and the video bandwidth is  $\geq 1/T$  (Duty cycle < 98%) or 10Hz (Duty cycle  $\geq 98\%$ ) for Average detection (AV) at frequency above 1GHz.
4. All modes of operation were investigated and the worst-case emissions are reported.

4.1.4 Deviation from Test Standard

No deviation.

4.1.5 Test Setup

**For Radiated emission below 30MHz**

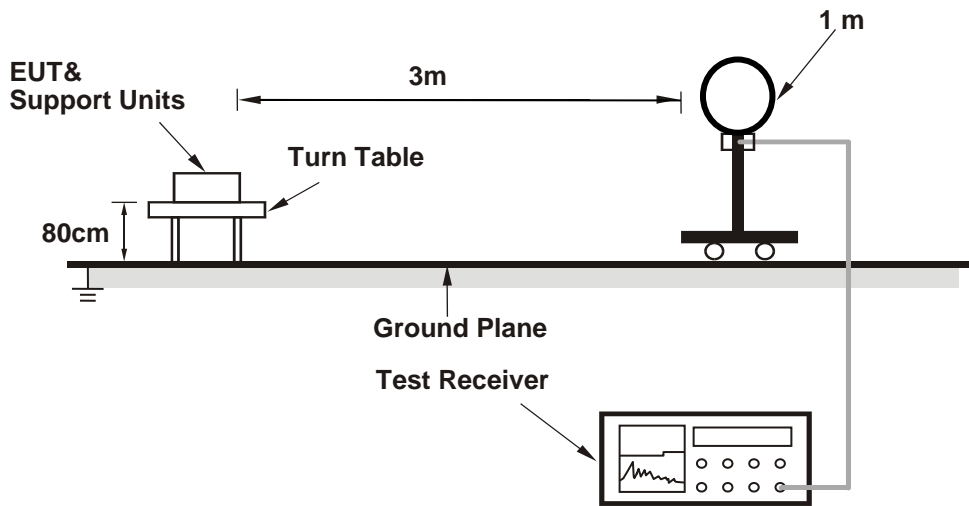

**For Radiated emission 30MHz to 1GHz**

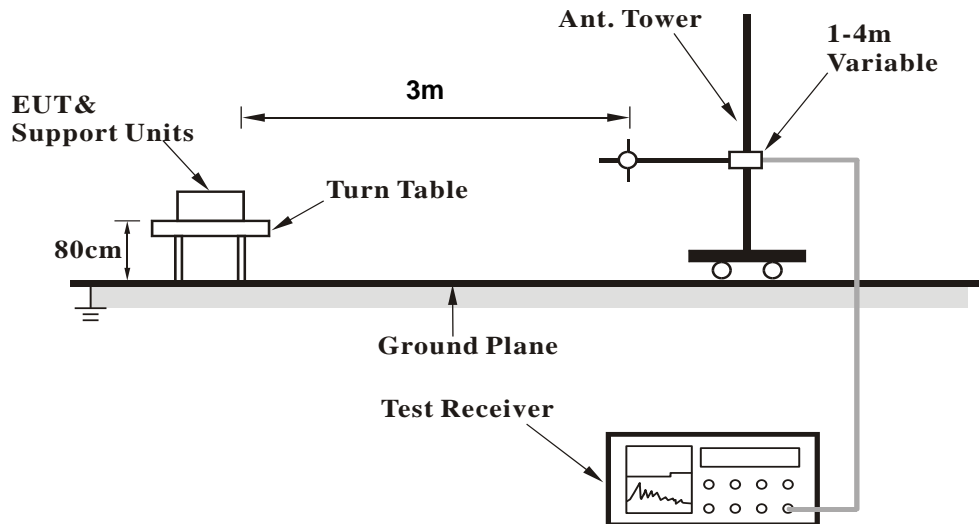

### For Radiated emission above 1GHz

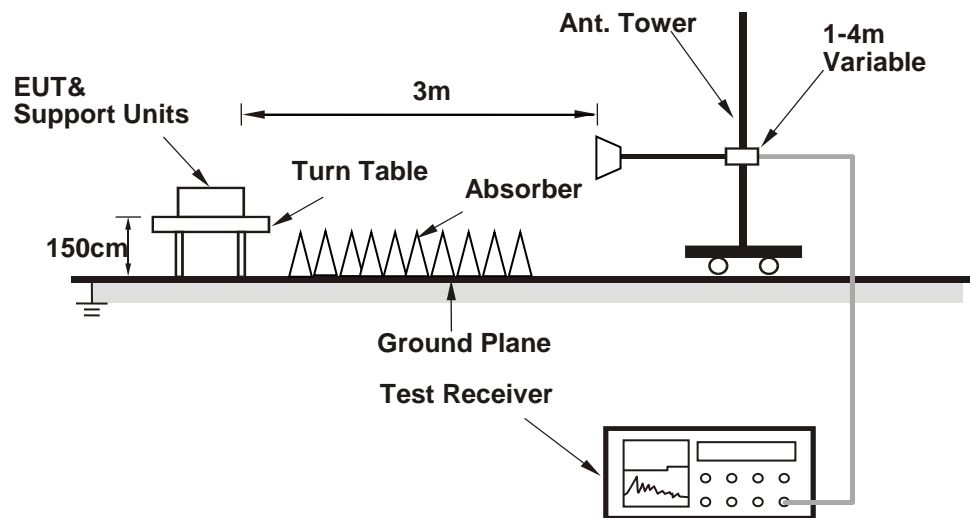

For the actual test configuration, please refer to the attached file (Test Setup Photo).

#### 4.1.6 EUT Operating Condition

- a. Connected the EUT with the Laptop which is placed on the testing table.
- b. Controlling software (qdart\_conn.win.1.0\_installer\_00089.1) has been activated to set the EUT under transmission condition continuously.



## 4.1.7 Test Results

## Above 1GHz Data:

<b>RF Mode</b>	TX 802.11a	<b>Channel</b>	CH 36 : 5.18 GHz
<b>Frequency Range</b>	1GHz ~ 40GHz	<b>Detector Function</b>	Peak (PK) Average (AV)
<b>Input Power</b>	120Vac, 60Hz	<b>Environmental Conditions</b>	25 °C, 66% RH
<b>Tested By</b>	Tom Yang		

**Antenna Polarity & Test Distance : Horizontal at 3 m**

No	Frequency (MHz)	Emission Level (dBuV/m)	Limit (dBuV/m)	Margin (dB)	Antenna Height (m)	Table Angle (Degree)	Raw Value (dBuV)	Correction Factor (dB/m)
1	5150.00	63.5 PK	74.0	-10.5	1.00 H	296	62.0	1.5
2	5150.00	53.8 AV	54.0	-0.2	1.00 H	296	52.3	1.5
3	*5180.00	117.1 PK			1.00 H	296	115.9	1.2
4	*5180.00	108.8 AV			1.00 H	296	107.6	1.2
5	#10360.00	41.2 PK	68.2	-27.0	1.03 H	320	30.3	10.9
6	15540.00	36.0 PK	74.0	-38.0	1.60 H	139	23.8	12.2
7	15540.00	25.6 AV	54.0	-28.4	1.60 H	139	13.4	12.2

**Antenna Polarity & Test Distance : Vertical at 3 m**

No	Frequency (MHz)	Emission Level (dBuV/m)	Limit (dBuV/m)	Margin (dB)	Antenna Height (m)	Table Angle (Degree)	Raw Value (dBuV)	Correction Factor (dB/m)
1	5150.00	58.4 PK	74.0	-15.6	3.63 V	248	56.9	1.5
2	5150.00	48.4 AV	54.0	-5.6	3.63 V	248	46.9	1.5
3	*5180.00	112.5 PK			3.63 V	248	111.3	1.2
4	*5180.00	104.5 AV			3.63 V	248	103.3	1.2
5	#10360.00	37.4 PK	68.2	-30.8	1.33 V	281	26.5	10.9
6	15540.00	35.6 PK	74.0	-38.4	2.00 V	258	23.4	12.2
7	15540.00	25.8 AV	54.0	-28.2	2.00 V	258	13.6	12.2

**Remarks:**

1. Emission Level(dBuV/m) = Raw Value(dBuV) + Correction Factor(dB/m)
2. Correction Factor(dB/m) = Antenna Factor(dB/m) + Cable Factor(dB) – Pre-Amplifier Factor(dB)
3. Margin value = Emission Level – Limit value
4. The other emission levels were very low against the limit.
5. " \* ": Fundamental frequency.
6. " # ": The radiated frequency is out of the restricted band.

<b>RF Mode</b>	TX 802.11a	<b>Channel</b>	CH 40 : 5.2 GHz
<b>Frequency Range</b>	1GHz ~ 40GHz	<b>Detector Function</b>	Peak (PK) Average (AV)
<b>Input Power</b>	120Vac, 60Hz	<b>Environmental Conditions</b>	25 °C, 66% RH
<b>Tested By</b>	Tom Yang		

**Antenna Polarity & Test Distance : Horizontal at 3 m**

No	Frequency (MHz)	Emission Level (dBuV/m)	Limit (dBuV/m)	Margin (dB)	Antenna Height (m)	Table Angle (Degree)	Raw Value (dBuV)	Correction Factor (dB/m)
1	5150.00	63.4 PK	74.0	-10.6	1.00 H	294	61.9	1.5
2	5150.00	53.5 AV	54.0	-0.5	1.00 H	294	52.0	1.5
3	*5200.00	118.2 PK			1.00 H	294	117.0	1.2
4	*5200.00	110.4 AV			1.00 H	294	109.2	1.2
5	#10400.00	41.2 PK	68.2	-27.0	1.00 H	360	30.1	11.1
6	15600.00	36.3 PK	74.0	-37.7	1.56 H	134	24.1	12.2
7	15600.00	25.7 AV	54.0	-28.3	1.56 H	134	13.5	12.2

**Antenna Polarity & Test Distance : Vertical at 3 m**

No	Frequency (MHz)	Emission Level (dBuV/m)	Limit (dBuV/m)	Margin (dB)	Antenna Height (m)	Table Angle (Degree)	Raw Value (dBuV)	Correction Factor (dB/m)
1	5150.00	48.8 PK	74.0	-25.2	3.66 V	257	47.3	1.5
2	5150.00	38.3 AV	54.0	-15.7	3.66 V	257	36.8	1.5
3	*5200.00	115.0 PK			3.66 V	257	113.8	1.2
4	*5200.00	106.7 AV			3.66 V	257	105.5	1.2
5	#10400.00	37.6 PK	68.2	-30.6	1.40 V	271	26.5	11.1
6	15600.00	35.4 PK	74.0	-38.6	2.03 V	247	23.2	12.2
7	15600.00	25.7 AV	54.0	-28.3	2.03 V	247	13.5	12.2

**Remarks:**

1. Emission Level(dBuV/m) = Raw Value(dBuV) + Correction Factor(dB/m)
2. Correction Factor(dB/m) = Antenna Factor(dB/m) + Cable Factor(dB) – Pre-Amplifier Factor(dB)
3. Margin value = Emission Level – Limit value
4. The other emission levels were very low against the limit.
5. " \* " : Fundamental frequency.
6. " # " : The radiated frequency is out of the restricted band.

<b>RF Mode</b>	TX 802.11a	<b>Channel</b>	CH 48 : 5.24 GHz
<b>Frequency Range</b>	1GHz ~ 40GHz	<b>Detector Function</b>	Peak (PK) Average (AV)
<b>Input Power</b>	120Vac, 60Hz	<b>Environmental Conditions</b>	25 °C, 66% RH
<b>Tested By</b>	Tom Yang		

**Antenna Polarity & Test Distance : Horizontal at 3 m**

No	Frequency (MHz)	Emission Level (dBuV/m)	Limit (dBuV/m)	Margin (dB)	Antenna Height (m)	Table Angle (Degree)	Raw Value (dBuV)	Correction Factor (dB/m)
1	*5240.00	118.2 PK			1.06 H	294	117.2	1.0
2	*5240.00	110.4 AV			1.06 H	294	109.4	1.0
3	5350.00	49.0 PK	74.0	-25.0	1.06 H	294	47.8	1.2
4	5350.00	38.5 AV	54.0	-15.5	1.06 H	294	37.3	1.2
5	#10480.00	41.9 PK	68.2	-26.3	1.08 H	350	30.8	11.1
6	15720.00	36.7 PK	74.0	-37.3	1.60 H	121	24.6	12.1
7	15720.00	26.0 AV	54.0	-28.0	1.60 H	121	13.9	12.1

**Antenna Polarity & Test Distance : Vertical at 3 m**

No	Frequency (MHz)	Emission Level (dBuV/m)	Limit (dBuV/m)	Margin (dB)	Antenna Height (m)	Table Angle (Degree)	Raw Value (dBuV)	Correction Factor (dB/m)
1	*5240.00	114.1 PK			3.69 V	234	113.1	1.0
2	*5240.00	105.9 AV			3.69 V	234	104.9	1.0
3	5350.00	49.4 PK	74.0	-24.6	3.69 V	234	48.2	1.2
4	5350.00	38.8 AV	54.0	-15.2	3.69 V	234	37.6	1.2
5	#10480.00	37.7 PK	68.2	-30.5	1.29 V	273	26.6	11.1
6	15720.00	35.5 PK	74.0	-38.5	2.07 V	250	23.4	12.1
7	15720.00	25.9 AV	54.0	-28.1	2.07 V	250	13.8	12.1

**Remarks:**

1. Emission Level(dBuV/m) = Raw Value(dBuV) + Correction Factor(dB/m)
2. Correction Factor(dB/m) = Antenna Factor(dB/m) + Cable Factor(dB) – Pre-Amplifier Factor(dB)
3. Margin value = Emission Level – Limit value
4. The other emission levels were very low against the limit.
5. " \* " : Fundamental frequency.
6. " # " : The radiated frequency is out of the restricted band.

<b>RF Mode</b>	TX 802.11a	<b>Channel</b>	CH 52 : 5.26 GHz
<b>Frequency Range</b>	1GHz ~ 40GHz	<b>Detector Function</b>	Peak (PK) Average (AV)
<b>Input Power</b>	120Vac, 60Hz	<b>Environmental Conditions</b>	25 °C, 66% RH
<b>Tested By</b>	Tom Yang		

**Antenna Polarity & Test Distance : Horizontal at 3 m**

No	Frequency (MHz)	Emission Level (dBuV/m)	Limit (dBuV/m)	Margin (dB)	Antenna Height (m)	Table Angle (Degree)	Raw Value (dBuV)	Correction Factor (dB/m)
1	5150.00	49.1 PK	74.0	-24.9	1.02 H	294	47.6	1.5
2	5150.00	38.8 AV	54.0	-15.2	1.02 H	294	37.3	1.5
3	*5260.00	118.3 PK			1.02 H	294	117.4	0.9
4	*5260.00	110.2 AV			1.02 H	294	109.3	0.9
5	#10520.00	42.2 PK	68.2	-26.0	1.04 H	338	31.2	11.0
6	15780.00	37.0 PK	74.0	-37.0	1.62 H	115	25.0	12.0
7	15780.00	26.1 AV	54.0	-27.9	1.62 H	115	14.1	12.0

**Antenna Polarity & Test Distance : Vertical at 3 m**

No	Frequency (MHz)	Emission Level (dBuV/m)	Limit (dBuV/m)	Margin (dB)	Antenna Height (m)	Table Angle (Degree)	Raw Value (dBuV)	Correction Factor (dB/m)
1	5150.00	48.9 PK	74.0	-25.1	3.65 V	241	47.4	1.5
2	5150.00	38.1 AV	54.0	-15.9	3.65 V	241	36.6	1.5
3	*5260.00	114.3 PK			3.65 V	241	113.4	0.9
4	*5260.00	106.2 AV			3.65 V	241	105.3	0.9
5	#10520.00	38.1 PK	68.2	-30.1	1.28 V	257	27.1	11.0
6	15780.00	35.5 PK	74.0	-38.5	2.07 V	256	23.5	12.0
7	15780.00	25.7 AV	54.0	-28.3	2.07 V	256	13.7	12.0

**Remarks:**

1. Emission Level(dBuV/m) = Raw Value(dBuV) + Correction Factor(dB/m)
2. Correction Factor(dB/m) = Antenna Factor(dB/m) + Cable Factor(dB) – Pre-Amplifier Factor(dB)
3. Margin value = Emission Level – Limit value
4. The other emission levels were very low against the limit.
5. " \* " : Fundamental frequency.
6. " # " : The radiated frequency is out of the restricted band.

<b>RF Mode</b>	TX 802.11a	<b>Channel</b>	CH 60 : 5.3 GHz
<b>Frequency Range</b>	1GHz ~ 40GHz	<b>Detector Function</b>	Peak (PK) Average (AV)
<b>Input Power</b>	120Vac, 60Hz	<b>Environmental Conditions</b>	25 °C, 66% RH
<b>Tested By</b>	Tom Yang		

**Antenna Polarity & Test Distance : Horizontal at 3 m**

No	Frequency (MHz)	Emission Level (dBuV/m)	Limit (dBuV/m)	Margin (dB)	Antenna Height (m)	Table Angle (Degree)	Raw Value (dBuV)	Correction Factor (dB/m)
1	*5300.00	118.8 PK			1.01 H	302	117.9	0.9
2	*5300.00	110.5 AV			1.01 H	302	109.6	0.9
3	10600.00	41.5 PK	74.0	-32.5	1.08 H	351	30.8	10.7
4	10600.00	30.5 AV	54.0	-23.5	1.08 H	351	19.8	10.7
5	15900.00	36.9 PK	74.0	-37.1	1.56 H	127	24.6	12.3
6	15900.00	26.1 AV	54.0	-27.9	1.56 H	127	13.8	12.3

**Antenna Polarity & Test Distance : Vertical at 3 m**

No	Frequency (MHz)	Emission Level (dBuV/m)	Limit (dBuV/m)	Margin (dB)	Antenna Height (m)	Table Angle (Degree)	Raw Value (dBuV)	Correction Factor (dB/m)
1	*5300.00	114.5 PK			3.65 V	240	113.6	0.9
2	*5300.00	106.2 AV			3.65 V	240	105.3	0.9
3	10600.00	37.9 PK	74.0	-36.1	1.25 V	277	27.2	10.7
4	10600.00	27.2 AV	54.0	-26.8	1.25 V	277	16.5	10.7
5	15900.00	34.7 PK	74.0	-39.3	2.08 V	255	22.4	12.3
6	15900.00	25.4 AV	54.0	-28.6	2.08 V	255	13.1	12.3

**Remarks:**

1. Emission Level(dBuV/m) = Raw Value(dBuV) + Correction Factor(dB/m)
2. Correction Factor(dB/m) = Antenna Factor(dB/m) + Cable Factor(dB) – Pre-Amplifier Factor(dB)
3. Margin value = Emission Level – Limit value
4. The other emission levels were very low against the limit.
5. " \* ": Fundamental frequency.

<b>RF Mode</b>	TX 802.11a	<b>Channel</b>	CH 64 : 5.32 GHz
<b>Frequency Range</b>	1GHz ~ 40GHz	<b>Detector Function</b>	Peak (PK) Average (AV)
<b>Input Power</b>	120Vac, 60Hz	<b>Environmental Conditions</b>	25 °C, 66% RH
<b>Tested By</b>	Tom Yang		

**Antenna Polarity & Test Distance : Horizontal at 3 m**

No	Frequency (MHz)	Emission Level (dBuV/m)	Limit (dBuV/m)	Margin (dB)	Antenna Height (m)	Table Angle (Degree)	Raw Value (dBuV)	Correction Factor (dB/m)
1	*5320.00	116.7 PK			1.01 H	294	115.7	1.0
2	*5320.00	108.1 AV			1.01 H	294	107.1	1.0
3	5350.00	64.4 PK	74.0	-9.6	1.01 H	294	63.2	1.2
<b>4</b>	<b>5350.00</b>	<b>53.9 AV</b>	<b>54.0</b>	<b>-0.1</b>	<b>1.01 H</b>	<b>294</b>	<b>52.7</b>	<b>1.2</b>
5	10640.00	41.7 PK	74.0	-32.3	1.02 H	333	30.7	11.0
6	10640.00	30.5 AV	54.0	-23.5	1.02 H	333	19.5	11.0
7	15960.00	36.8 PK	74.0	-37.2	1.56 H	129	24.5	12.3
8	15960.00	26.2 AV	54.0	-27.8	1.56 H	129	13.9	12.3

**Antenna Polarity & Test Distance : Vertical at 3 m**

No	Frequency (MHz)	Emission Level (dBuV/m)	Limit (dBuV/m)	Margin (dB)	Antenna Height (m)	Table Angle (Degree)	Raw Value (dBuV)	Correction Factor (dB/m)
1	*5320.00	112.1 PK			3.11 V	68	111.1	1.0
2	*5320.00	101.7 AV			3.11 V	68	100.7	1.0
3	5351.04	59.2 PK	74.0	-14.8	3.11 V	68	58.0	1.2
4	5351.04	46.1 AV	54.0	-7.9	3.11 V	68	44.9	1.2
5	10640.00	37.4 PK	74.0	-36.6	1.31 V	265	26.4	11.0
6	10640.00	27.0 AV	54.0	-27.0	1.31 V	265	16.0	11.0
7	15960.00	36.1 PK	74.0	-37.9	2.08 V	237	23.8	12.3
8	15960.00	26.4 AV	54.0	-27.6	2.08 V	237	14.1	12.3

**Remarks:**

1. Emission Level(dBuV/m) = Raw Value(dBuV) + Correction Factor(dB/m)
2. Correction Factor(dB/m) = Antenna Factor(dB/m) + Cable Factor(dB) – Pre-Amplifier Factor(dB)
3. Margin value = Emission Level – Limit value
4. The other emission levels were very low against the limit.
5. " \* " : Fundamental frequency.

<b>RF Mode</b>	TX 802.11a	<b>Channel</b>	CH 100 : 5.5 GHz
<b>Frequency Range</b>	1GHz ~ 40GHz	<b>Detector Function</b>	Peak (PK) Average (AV)
<b>Input Power</b>	120Vac, 60Hz	<b>Environmental Conditions</b>	25 °C, 66% RH
<b>Tested By</b>	Tom Yang		

**Antenna Polarity & Test Distance : Horizontal at 3 m**

No	Frequency (MHz)	Emission Level (dBuV/m)	Limit (dBuV/m)	Margin (dB)	Antenna Height (m)	Table Angle (Degree)	Raw Value (dBuV)	Correction Factor (dB/m)
1	5459.60	57.4 PK	74.0	-16.6	1.00 H	297	56.1	1.3
2	5459.60	45.2 AV	54.0	-8.8	1.00 H	297	43.9	1.3
3	#5470.00	67.7 PK	68.2	-0.5	1.00 H	297	66.4	1.3
4	*5500.00	116.4 PK			1.00 H	297	115.1	1.3
5	*5500.00	107.5 AV			1.00 H	297	106.2	1.3
6	11000.00	41.3 PK	74.0	-32.7	1.05 H	342	29.5	11.8
7	11000.00	30.2 AV	54.0	-23.8	1.05 H	342	18.4	11.8
8	#16500.00	37.1 PK	68.2	-31.1	1.52 H	113	22.8	14.3

**Antenna Polarity & Test Distance : Vertical at 3 m**

No	Frequency (MHz)	Emission Level (dBuV/m)	Limit (dBuV/m)	Margin (dB)	Antenna Height (m)	Table Angle (Degree)	Raw Value (dBuV)	Correction Factor (dB/m)
1	5460.00	54.2 PK	74.0	-19.8	3.91 V	58	52.9	1.3
2	5460.00	41.9 AV	54.0	-12.1	3.91 V	58	40.6	1.3
3	#5470.00	64.9 PK	68.2	-3.3	3.91 V	58	63.6	1.3
4	*5500.00	110.9 PK			3.91 V	58	109.6	1.3
5	*5500.00	101.1 AV			3.91 V	58	99.8	1.3
6	11000.00	37.8 PK	74.0	-36.2	1.24 V	277	26.0	11.8
7	11000.00	27.0 AV	54.0	-27.0	1.24 V	277	15.2	11.8
8	#16500.00	35.3 PK	68.2	-32.9	2.12 V	260	21.0	14.3

**Remarks:**

1. Emission Level(dBuV/m) = Raw Value(dBuV) + Correction Factor(dB/m)
2. Correction Factor(dB/m) = Antenna Factor(dB/m) + Cable Factor(dB) – Pre-Amplifier Factor(dB)
3. Margin value = Emission Level – Limit value
4. The other emission levels were very low against the limit.
5. " \* " : Fundamental frequency.
6. " # " : The radiated frequency is out of the restricted band.

<b>RF Mode</b>	TX 802.11a	<b>Channel</b>	CH 116 : 5.58 GHz
<b>Frequency Range</b>	1GHz ~ 40GHz	<b>Detector Function</b>	Peak (PK) Average (AV)
<b>Input Power</b>	120Vac, 60Hz	<b>Environmental Conditions</b>	25 °C, 66% RH
<b>Tested By</b>	Tom Yang		

**Antenna Polarity & Test Distance : Horizontal at 3 m**

No	Frequency (MHz)	Emission Level (dBuV/m)	Limit (dBuV/m)	Margin (dB)	Antenna Height (m)	Table Angle (Degree)	Raw Value (dBuV)	Correction Factor (dB/m)
1	*5580.00	117.8 PK			1.00 H	296	116.4	1.4
2	*5580.00	110.0 AV			1.00 H	296	108.6	1.4
3	11160.00	41.8 PK	74.0	-32.2	1.11 H	354	30.0	11.8
4	11160.00	30.9 AV	54.0	-23.1	1.11 H	354	19.1	11.8
5	#16740.00	36.9 PK	68.2	-31.3	1.55 H	142	21.1	15.8

**Antenna Polarity & Test Distance : Vertical at 3 m**

No	Frequency (MHz)	Emission Level (dBuV/m)	Limit (dBuV/m)	Margin (dB)	Antenna Height (m)	Table Angle (Degree)	Raw Value (dBuV)	Correction Factor (dB/m)
1	*5580.00	114.5 PK			3.68 V	241	113.1	1.4
2	*5580.00	106.1 AV			3.68 V	241	104.7	1.4
3	11160.00	38.0 PK	74.0	-36.0	1.35 V	260	26.2	11.8
4	11160.00	27.4 AV	54.0	-26.6	1.35 V	260	15.6	11.8
5	#16740.00	35.3 PK	68.2	-32.9	2.03 V	249	19.5	15.8

**Remarks:**

1. Emission Level(dBuV/m) = Raw Value(dBuV) + Correction Factor(dB/m)
2. Correction Factor(dB/m) = Antenna Factor(dB/m) + Cable Factor(dB) – Pre-Amplifier Factor(dB)
3. Margin value = Emission Level – Limit value
4. The other emission levels were very low against the limit.
5. " \* " : Fundamental frequency.
6. " # " : The radiated frequency is out of the restricted band.



<b>RF Mode</b>	TX 802.11a	<b>Channel</b>	CH 140 : 5.7 GHz
<b>Frequency Range</b>	1GHz ~ 40GHz	<b>Detector Function</b>	Peak (PK) Average (AV)
<b>Input Power</b>	120Vac, 60Hz	<b>Environmental Conditions</b>	25 °C, 66% RH
<b>Tested By</b>	Tom Yang		

**Antenna Polarity & Test Distance : Horizontal at 3 m**

No	Frequency (MHz)	Emission Level (dBuV/m)	Limit (dBuV/m)	Margin (dB)	Antenna Height (m)	Table Angle (Degree)	Raw Value (dBuV)	Correction Factor (dB/m)
1	*5700.00	115.9 PK			1.03 H	26	114.1	1.8
2	*5700.00	107.3 AV			1.03 H	26	105.5	1.8
3	#5725.00	67.6 PK	68.2	-0.6	1.03 H	26	65.7	1.9
4	11400.00	41.6 PK	74.0	-32.4	1.08 H	338	29.2	12.4
5	11400.00	30.8 AV	54.0	-23.2	1.08 H	338	18.4	12.4
6	#17100.00	36.3 PK	68.2	-31.9	1.57 H	143	19.6	16.7

**Antenna Polarity & Test Distance : Vertical at 3 m**

No	Frequency (MHz)	Emission Level (dBuV/m)	Limit (dBuV/m)	Margin (dB)	Antenna Height (m)	Table Angle (Degree)	Raw Value (dBuV)	Correction Factor (dB/m)
1	*5700.00	110.7 PK			3.63 V	260	108.9	1.8
2	*5700.00	100.8 AV			3.63 V	260	99.0	1.8
3	#5725.00	49.2 PK	68.2	-19.0	3.63 V	260	47.3	1.9
4	11400.00	37.5 PK	74.0	-36.5	1.30 V	282	25.1	12.4
5	11400.00	27.0 AV	54.0	-27.0	1.30 V	282	14.6	12.4
6	#17100.00	35.9 PK	68.2	-32.3	2.01 V	247	19.2	16.7

**Remarks:**

1. Emission Level(dBuV/m) = Raw Value(dBuV) + Correction Factor(dB/m)
2. Correction Factor(dB/m) = Antenna Factor(dB/m) + Cable Factor(dB) – Pre-Amplifier Factor(dB)
3. Margin value = Emission Level – Limit value
4. The other emission levels were very low against the limit.
5. " \* ": Fundamental frequency.
6. " # ": The radiated frequency is out of the restricted band.

<b>RF Mode</b>	TX 802.11a	<b>Channel</b>	CH 144 : 5.72 GHz
<b>Frequency Range</b>	1GHz ~ 40GHz	<b>Detector Function</b>	Peak (PK) Average (AV)
<b>Input Power</b>	120Vac, 60Hz	<b>Environmental Conditions</b>	25 °C, 66% RH
<b>Tested By</b>	Tom Yang		

**Antenna Polarity & Test Distance : Horizontal at 3 m**

No	Frequency (MHz)	Emission Level (dBuV/m)	Limit (dBuV/m)	Margin (dB)	Antenna Height (m)	Table Angle (Degree)	Raw Value (dBuV)	Correction Factor (dB/m)
1	5460.00	49.7 PK	74.0	-24.3	1.00 H	26	48.4	1.3
2	5460.00	38.0 AV	54.0	-16.0	1.00 H	26	36.7	1.3
3	#5470.00	49.4 PK	68.2	-18.8	1.00 H	26	48.1	1.3
4	*5720.00	117.0 PK			1.00 H	26	115.1	1.9
5	*5720.00	108.7 AV			1.00 H	26	106.8	1.9
6	#5850.00	49.3 PK	68.2	-18.9	1.00 H	26	47.4	1.9
7	11440.00	42.0 PK	74.0	-32.0	1.04 H	344	29.5	12.5
8	11440.00	30.8 AV	54.0	-23.2	1.04 H	344	18.3	12.5
9	#17160.00	37.0 PK	68.2	-31.2	1.53 H	121	20.3	16.7

**Antenna Polarity & Test Distance : Vertical at 3 m**

No	Frequency (MHz)	Emission Level (dBuV/m)	Limit (dBuV/m)	Margin (dB)	Antenna Height (m)	Table Angle (Degree)	Raw Value (dBuV)	Correction Factor (dB/m)
1	5460.00	48.5 PK	74.0	-25.5	3.68 V	235	47.2	1.3
2	5460.00	38.3 AV	54.0	-15.7	3.68 V	235	37.0	1.3
3	#5470.00	49.5 PK	68.2	-18.7	3.68 V	235	48.2	1.3
4	*5720.00	114.6 PK			3.68 V	235	112.7	1.9
5	*5720.00	106.3 AV			3.68 V	235	104.4	1.9
6	#5850.00	48.9 PK	68.2	-19.3	3.68 V	235	47.0	1.9
7	11440.00	37.8 PK	74.0	-36.2	1.25 V	287	25.3	12.5
8	11440.00	27.1 AV	54.0	-26.9	1.25 V	287	14.6	12.5
9	#17160.00	35.7 PK	68.2	-32.5	2.07 V	239	19.0	16.7

**Remarks:**

1. Emission Level(dBuV/m) = Raw Value(dBuV) + Correction Factor(dB/m)
2. Correction Factor(dB/m) = Antenna Factor(dB/m) + Cable Factor(dB) – Pre-Amplifier Factor(dB)
3. Margin value = Emission Level – Limit value
4. The other emission levels were very low against the limit.
5. " \* " : Fundamental frequency.
6. " # " : The radiated frequency is out of the restricted band.

<b>RF Mode</b>	TX 802.11a	<b>Channel</b>	CH 149 : 5.745 GHz
<b>Frequency Range</b>	1GHz ~ 40GHz	<b>Detector Function</b>	Peak (PK) Average (AV)
<b>Input Power</b>	120Vac, 60Hz	<b>Environmental Conditions</b>	25 °C, 66% RH
<b>Tested By</b>	Tom Yang		

**Antenna Polarity & Test Distance : Horizontal at 3 m**

No	Frequency (MHz)	Emission Level (dBuV/m)	Limit (dBuV/m)	Margin (dB)	Antenna Height (m)	Table Angle (Degree)	Raw Value (dBuV)	Correction Factor (dB/m)
1	#5646.06	53.6 PK	68.2	-14.6	1.00 H	26	51.8	1.8
2	*5745.00	119.7 PK			1.00 H	26	117.7	2.0
3	*5745.00	111.1 AV			1.00 H	26	109.1	2.0
4	#5988.25	50.4 PK	68.2	-17.8	1.00 H	26	48.1	2.3
5	11490.00	42.3 PK	74.0	-31.7	1.14 H	356	29.9	12.4
6	11490.00	31.0 AV	54.0	-23.0	1.14 H	356	18.6	12.4
7	#17235.00	36.7 PK	68.2	-31.5	1.52 H	140	20.0	16.7

**Antenna Polarity & Test Distance : Vertical at 3 m**

No	Frequency (MHz)	Emission Level (dBuV/m)	Limit (dBuV/m)	Margin (dB)	Antenna Height (m)	Table Angle (Degree)	Raw Value (dBuV)	Correction Factor (dB/m)
1	#5588.44	49.2 PK	68.2	-19.0	3.32 V	290	47.5	1.7
2	*5745.00	111.8 PK			3.32 V	290	109.8	2.0
3	*5745.00	104.1 AV			3.32 V	290	102.1	2.0
4	#5963.17	49.8 PK	68.2	-18.4	3.32 V	290	47.5	2.3
5	11490.00	37.5 PK	74.0	-36.5	1.28 V	272	25.1	12.4
6	11490.00	26.9 AV	54.0	-27.1	1.28 V	272	14.5	12.4
7	#17235.00	35.8 PK	68.2	-32.4	2.13 V	238	19.1	16.7

**Remarks:**

1. Emission Level(dBuV/m) = Raw Value(dBuV) + Correction Factor(dB/m)
2. Correction Factor(dB/m) = Antenna Factor(dB/m) + Cable Factor(dB) – Pre-Amplifier Factor(dB)
3. Margin value = Emission Level – Limit value
4. The other emission levels were very low against the limit.
5. " \* " : Fundamental frequency.
6. " # " : The radiated frequency is out of the restricted band.

<b>RF Mode</b>	TX 802.11a	<b>Channel</b>	CH 157 : 5.785 GHz
<b>Frequency Range</b>	1GHz ~ 40GHz	<b>Detector Function</b>	Peak (PK) Average (AV)
<b>Input Power</b>	120Vac, 60Hz	<b>Environmental Conditions</b>	25 °C, 66% RH
<b>Tested By</b>	Tom Yang		

**Antenna Polarity & Test Distance : Horizontal at 3 m**

No	Frequency (MHz)	Emission Level (dBuV/m)	Limit (dBuV/m)	Margin (dB)	Antenna Height (m)	Table Angle (Degree)	Raw Value (dBuV)	Correction Factor (dB/m)
1	#5633.56	50.1 PK	68.2	-18.1	1.03 H	26	48.3	1.8
2	*5785.00	119.4 PK			1.03 H	26	117.3	2.1
3	*5785.00	100.7 AV			1.03 H	26	98.6	2.1
4	#5958.43	51.4 PK	68.2	-16.8	1.03 H	26	49.1	2.3
5	11570.00	37.8 PK	74.0	-36.2	1.47 H	196	25.5	12.3
6	11570.00	27.1 AV	54.0	-26.9	1.47 H	196	14.8	12.3
7	#17355.00	33.9 PK	68.2	-34.3	1.61 H	137	16.4	17.5

**Antenna Polarity & Test Distance : Vertical at 3 m**

No	Frequency (MHz)	Emission Level (dBuV/m)	Limit (dBuV/m)	Margin (dB)	Antenna Height (m)	Table Angle (Degree)	Raw Value (dBuV)	Correction Factor (dB/m)
1	#5590.23	49.8 PK	68.2	-18.4	3.38 V	294	48.1	1.7
2	*5785.00	111.1 PK			3.38 V	294	109.0	2.1
3	*5785.00	103.7 AV			3.38 V	294	101.6	2.1
4	#6021.45	50.1 PK	68.2	-18.1	3.38 V	294	47.8	2.3
5	11570.00	38.4 PK	74.0	-35.6	1.37 V	174	26.1	12.3
6	11570.00	27.6 AV	54.0	-26.4	1.37 V	174	15.3	12.3
7	#17355.00	34.2 PK	68.2	-34.0	1.97 V	254	16.7	17.5

**Remarks:**

1. Emission Level(dBuV/m) = Raw Value(dBuV) + Correction Factor(dB/m)
2. Correction Factor(dB/m) = Antenna Factor(dB/m) + Cable Factor(dB) – Pre-Amplifier Factor(dB)
3. Margin value = Emission Level – Limit value
4. The other emission levels were very low against the limit.
5. " \* " : Fundamental frequency.
6. " # " : The radiated frequency is out of the restricted band.

<b>RF Mode</b>	TX 802.11a	<b>Channel</b>	CH 165 : 5.825 GHz
<b>Frequency Range</b>	1GHz ~ 40GHz	<b>Detector Function</b>	Peak (PK) Average (AV)
<b>Input Power</b>	120Vac, 60Hz	<b>Environmental Conditions</b>	25 °C, 66% RH
<b>Tested By</b>	Tom Yang		

**Antenna Polarity & Test Distance : Horizontal at 3 m**

No	Frequency (MHz)	Emission Level (dBuV/m)	Limit (dBuV/m)	Margin (dB)	Antenna Height (m)	Table Angle (Degree)	Raw Value (dBuV)	Correction Factor (dB/m)
1	#5602.83	50.6 PK	68.2	-17.6	1.02 H	27	48.9	1.7
2	*5825.00	119.9 PK			1.02 H	27	117.9	2.0
3	*5825.00	111.0 AV			1.02 H	27	109.0	2.0
4	#5926.38	53.3 PK	68.2	-14.9	1.02 H	27	51.1	2.2
5	11650.00	37.9 PK	74.0	-36.1	1.49 H	208	25.7	12.2
6	11650.00	27.0 AV	54.0	-27.0	1.49 H	208	14.8	12.2
7	#17475.00	34.3 PK	68.2	-33.9	1.61 H	123	16.1	18.2

**Antenna Polarity & Test Distance : Vertical at 3 m**

No	Frequency (MHz)	Emission Level (dBuV/m)	Limit (dBuV/m)	Margin (dB)	Antenna Height (m)	Table Angle (Degree)	Raw Value (dBuV)	Correction Factor (dB/m)
1	#5619.56	48.7 PK	68.2	-19.5	3.38 V	293	46.9	1.8
2	*5825.00	111.6 PK			3.38 V	293	109.6	2.0
3	*5825.00	103.7 AV			3.38 V	293	101.7	2.0
4	#6024.83	49.8 PK	68.2	-18.4	3.38 V	293	47.4	2.4
5	11650.00	38.1 PK	74.0	-35.9	1.25 V	277	25.9	12.2
6	11650.00	27.5 AV	54.0	-26.5	1.25 V	277	15.3	12.2
7	#17475.00	35.8 PK	68.2	-32.4	2.03 V	252	17.6	18.2

**Remarks:**

1. Emission Level(dBuV/m) = Raw Value(dBuV) + Correction Factor(dB/m)
2. Correction Factor(dB/m) = Antenna Factor(dB/m) + Cable Factor(dB) – Pre-Amplifier Factor(dB)
3. Margin value = Emission Level – Limit value
4. The other emission levels were very low against the limit.
5. " \* " : Fundamental frequency.
6. " # " : The radiated frequency is out of the restricted band.

<b>RF Mode</b>	TX 802.11ax (HE20)	<b>Channel</b>	CH 36 : 5.18 GHz
<b>Frequency Range</b>	1GHz ~ 40GHz	<b>Detector Function</b>	Peak (PK) Average (AV)
<b>Input Power</b>	120Vac, 60Hz	<b>Environmental Conditions</b>	25 °C, 66% RH
<b>Tested By</b>	Tom Yang		

**Antenna Polarity & Test Distance : Horizontal at 3 m**

No	Frequency (MHz)	Emission Level (dBuV/m)	Limit (dBuV/m)	Margin (dB)	Antenna Height (m)	Table Angle (Degree)	Raw Value (dBuV)	Correction Factor (dB/m)
1	5150.00	66.4 PK	74.0	-7.6	1.01 H	296	64.9	1.5
2	5150.00	53.5 AV	54.0	-0.5	1.01 H	296	52.0	1.5
3	*5180.00	118.7 PK			1.01 H	296	117.5	1.2
4	*5180.00	107.5 AV			1.01 H	296	106.3	1.2
5	#10360.00	38.2 PK	68.2	-30.0	1.50 H	212	27.3	10.9
6	15540.00	34.3 PK	74.0	-39.7	1.63 H	141	22.1	12.2
7	15540.00	24.1 AV	54.0	-29.9	1.63 H	141	11.9	12.2

**Antenna Polarity & Test Distance : Vertical at 3 m**

No	Frequency (MHz)	Emission Level (dBuV/m)	Limit (dBuV/m)	Margin (dB)	Antenna Height (m)	Table Angle (Degree)	Raw Value (dBuV)	Correction Factor (dB/m)
1	5150.00	58.3 PK	74.0	-15.7	3.45 V	67	56.8	1.5
2	5150.00	45.8 AV	54.0	-8.2	3.45 V	67	44.3	1.5
3	*5180.00	114.1 PK			3.45 V	67	112.9	1.2
4	*5180.00	101.5 AV			3.45 V	67	100.3	1.2
5	#10360.00	37.4 PK	68.2	-30.8	1.24 V	283	26.5	10.9
6	15540.00	35.8 PK	74.0	-38.2	2.12 V	240	23.6	12.2
7	15540.00	26.0 AV	54.0	-28.0	2.12 V	240	13.8	12.2

**Remarks:**

1. Emission Level(dBuV/m) = Raw Value(dBuV) + Correction Factor(dB/m)
2. Correction Factor(dB/m) = Antenna Factor(dB/m) + Cable Factor(dB) – Pre-Amplifier Factor(dB)
3. Margin value = Emission Level – Limit value
4. The other emission levels were very low against the limit.
5. " \* " : Fundamental frequency.
6. " # " : The radiated frequency is out of the restricted band.

<b>RF Mode</b>	TX 802.11ax (HE20)	<b>Channel</b>	CH 40 : 5.2 GHz
<b>Frequency Range</b>	1GHz ~ 40GHz	<b>Detector Function</b>	Peak (PK) Average (AV)
<b>Input Power</b>	120Vac, 60Hz	<b>Environmental Conditions</b>	25 °C, 66% RH
<b>Tested By</b>	Tom Yang		

**Antenna Polarity & Test Distance : Horizontal at 3 m**

No	Frequency (MHz)	Emission Level (dBuV/m)	Limit (dBuV/m)	Margin (dB)	Antenna Height (m)	Table Angle (Degree)	Raw Value (dBuV)	Correction Factor (dB/m)
1	5150.00	65.5 PK	74.0	-8.5	1.03 H	295	64.0	1.5
2	<b>5150.00</b>	<b>53.9 AV</b>	<b>54.0</b>	<b>-0.1</b>	<b>1.03 H</b>	<b>295</b>	<b>52.4</b>	<b>1.5</b>
3	*5200.00	120.0 PK			1.03 H	295	118.8	1.2
4	*5200.00	109.4 AV			1.03 H	295	108.2	1.2
5	#10400.00	37.7 PK	68.2	-30.5	1.42 H	202	26.6	11.1
6	15600.00	34.2 PK	74.0	-39.8	1.59 H	126	22.0	12.2
7	15600.00	24.1 AV	54.0	-29.9	1.59 H	126	11.9	12.2

**Antenna Polarity & Test Distance : Vertical at 3 m**

No	Frequency (MHz)	Emission Level (dBuV/m)	Limit (dBuV/m)	Margin (dB)	Antenna Height (m)	Table Angle (Degree)	Raw Value (dBuV)	Correction Factor (dB/m)
1	5150.00	48.8 PK	74.0	-25.2	3.47 V	61	47.3	1.5
2	5150.00	38.4 AV	54.0	-15.6	3.47 V	61	36.9	1.5
3	*5200.00	116.3 PK			3.47 V	61	115.1	1.2
4	*5200.00	103.7 AV			3.47 V	61	102.5	1.2
5	#10400.00	37.2 PK	68.2	-31.0	1.32 V	262	26.1	11.1
6	15600.00	35.5 PK	74.0	-38.5	2.10 V	262	23.3	12.2
7	15600.00	26.2 AV	54.0	-27.8	2.10 V	262	14.0	12.2

**Remarks:**

1. Emission Level(dBuV/m) = Raw Value(dBuV) + Correction Factor(dB/m)
2. Correction Factor(dB/m) = Antenna Factor(dB/m) + Cable Factor(dB) – Pre-Amplifier Factor(dB)
3. Margin value = Emission Level – Limit value
4. The other emission levels were very low against the limit.
5. " \* " : Fundamental frequency.
6. " # " : The radiated frequency is out of the restricted band.

<b>RF Mode</b>	TX 802.11ax (HE20)	<b>Channel</b>	CH 48 : 5.24 GHz
<b>Frequency Range</b>	1GHz ~ 40GHz	<b>Detector Function</b>	Peak (PK) Average (AV)
<b>Input Power</b>	120Vac, 60Hz	<b>Environmental Conditions</b>	25 °C, 66% RH
<b>Tested By</b>	Tom Yang		

**Antenna Polarity & Test Distance : Horizontal at 3 m**

No	Frequency (MHz)	Emission Level (dBuV/m)	Limit (dBuV/m)	Margin (dB)	Antenna Height (m)	Table Angle (Degree)	Raw Value (dBuV)	Correction Factor (dB/m)
1	*5240.00	119.9 PK			1.00 H	292	118.9	1.0
2	*5240.00	108.8 AV			1.00 H	292	107.8	1.0
3	5350.00	49.5 PK	74.0	-24.5	1.00 H	292	48.3	1.2
4	5350.00	38.2 AV	54.0	-15.8	1.00 H	292	37.0	1.2
5	#10480.00	37.9 PK	68.2	-30.3	1.48 H	212	26.8	11.1
6	15720.00	33.2 PK	74.0	-40.8	1.56 H	129	21.1	12.1
7	15720.00	23.4 AV	54.0	-30.6	1.56 H	129	11.3	12.1

**Antenna Polarity & Test Distance : Vertical at 3 m**

No	Frequency (MHz)	Emission Level (dBuV/m)	Limit (dBuV/m)	Margin (dB)	Antenna Height (m)	Table Angle (Degree)	Raw Value (dBuV)	Correction Factor (dB/m)
1	*5240.00	116.1 PK			3.45 V	72	115.1	1.0
2	*5240.00	103.3 AV			3.45 V	72	102.3	1.0
3	5350.00	48.6 PK	74.0	-25.4	3.45 V	72	47.4	1.2
4	5350.00	38.4 AV	54.0	-15.6	3.45 V	72	37.2	1.2
5	#10480.00	37.4 PK	68.2	-30.8	1.34 V	270	26.3	11.1
6	15720.00	35.7 PK	74.0	-38.3	2.05 V	245	23.6	12.1
7	15720.00	25.9 AV	54.0	-28.1	2.05 V	245	13.8	12.1

**Remarks:**

1. Emission Level(dBuV/m) = Raw Value(dBuV) + Correction Factor(dB/m)
2. Correction Factor(dB/m) = Antenna Factor(dB/m) + Cable Factor(dB) – Pre-Amplifier Factor(dB)
3. Margin value = Emission Level – Limit value
4. The other emission levels were very low against the limit.
5. " \* " : Fundamental frequency.
6. " # " : The radiated frequency is out of the restricted band.



<b>RF Mode</b>	TX 802.11ax (HE20)	<b>Channel</b>	CH 52 : 5.26 GHz
<b>Frequency Range</b>	1GHz ~ 40GHz	<b>Detector Function</b>	Peak (PK) Average (AV)
<b>Input Power</b>	120Vac, 60Hz	<b>Environmental Conditions</b>	25 °C, 66% RH
<b>Tested By</b>	Tom Yang		

**Antenna Polarity & Test Distance : Horizontal at 3 m**

No	Frequency (MHz)	Emission Level (dBuV/m)	Limit (dBuV/m)	Margin (dB)	Antenna Height (m)	Table Angle (Degree)	Raw Value (dBuV)	Correction Factor (dB/m)
1	5150.00	49.6 PK	74.0	-24.4	1.00 H	294	48.1	1.5
2	5150.00	38.3 AV	54.0	-15.7	1.00 H	294	36.8	1.5
3	*5260.00	120.1 PK			1.00 H	294	119.2	0.9
4	*5260.00	109.2 AV			1.00 H	294	108.3	0.9
5	#10520.00	38.0 PK	68.2	-30.2	1.49 H	207	27.0	11.0
6	15780.00	33.6 PK	74.0	-40.4	1.62 H	125	21.6	12.0
7	15780.00	23.6 AV	54.0	-30.4	1.62 H	125	11.6	12.0

**Antenna Polarity & Test Distance : Vertical at 3 m**

No	Frequency (MHz)	Emission Level (dBuV/m)	Limit (dBuV/m)	Margin (dB)	Antenna Height (m)	Table Angle (Degree)	Raw Value (dBuV)	Correction Factor (dB/m)
1	5150.00	49.1 PK	74.0	-24.9	3.49 V	77	47.6	1.5
2	5150.00	38.7 AV	54.0	-15.3	3.49 V	77	37.2	1.5
3	*5260.00	116.3 PK			3.49 V	77	115.4	0.9
4	*5260.00	103.7 AV			3.49 V	77	102.8	0.9
5	#10520.00	38.0 PK	68.2	-30.2	1.26 V	262	27.0	11.0
6	15780.00	35.8 PK	74.0	-38.2	2.08 V	239	23.8	12.0
7	15780.00	26.1 AV	54.0	-27.9	2.08 V	239	14.1	12.0

**Remarks:**

1. Emission Level(dBuV/m) = Raw Value(dBuV) + Correction Factor(dB/m)
2. Correction Factor(dB/m) = Antenna Factor(dB/m) + Cable Factor(dB) – Pre-Amplifier Factor(dB)
3. Margin value = Emission Level – Limit value
4. The other emission levels were very low against the limit.
5. " \* " : Fundamental frequency.
6. " # " : The radiated frequency is out of the restricted band.

<b>RF Mode</b>	TX 802.11ax (HE20)	<b>Channel</b>	CH 60 : 5.3 GHz
<b>Frequency Range</b>	1GHz ~ 40GHz	<b>Detector Function</b>	Peak (PK) Average (AV)
<b>Input Power</b>	120Vac, 60Hz	<b>Environmental Conditions</b>	25 °C, 66% RH
<b>Tested By</b>	Tom Yang		

**Antenna Polarity & Test Distance : Horizontal at 3 m**

No	Frequency (MHz)	Emission Level (dBuV/m)	Limit (dBuV/m)	Margin (dB)	Antenna Height (m)	Table Angle (Degree)	Raw Value (dBuV)	Correction Factor (dB/m)
1	*5300.00	119.9 PK			1.07 H	286	119.0	0.9
2	*5300.00	109.2 AV			1.07 H	286	108.3	0.9
3	10600.00	38.3 PK	74.0	-35.7	1.49 H	209	27.6	10.7
4	10600.00	27.4 AV	54.0	-26.6	1.49 H	209	16.7	10.7
5	15900.00	33.6 PK	74.0	-40.4	1.67 H	143	21.3	12.3
6	15900.00	23.6 AV	54.0	-30.4	1.67 H	143	11.3	12.3

**Antenna Polarity & Test Distance : Vertical at 3 m**

No	Frequency (MHz)	Emission Level (dBuV/m)	Limit (dBuV/m)	Margin (dB)	Antenna Height (m)	Table Angle (Degree)	Raw Value (dBuV)	Correction Factor (dB/m)
1	*5300.00	115.7 PK			3.45 V	67	114.8	0.9
2	*5300.00	103.1 AV			3.45 V	67	102.2	0.9
3	10600.00	38.2 PK	74.0	-35.8	1.28 V	257	27.5	10.7
4	10600.00	27.5 AV	54.0	-26.5	1.28 V	257	16.8	10.7
5	15900.00	35.0 PK	74.0	-39.0	2.06 V	245	22.7	12.3
6	15900.00	25.6 AV	54.0	-28.4	2.06 V	245	13.3	12.3

**Remarks:**

1. Emission Level(dBuV/m) = Raw Value(dBuV) + Correction Factor(dB/m)
2. Correction Factor(dB/m) = Antenna Factor(dB/m) + Cable Factor(dB) – Pre-Amplifier Factor(dB)
3. Margin value = Emission Level – Limit value
4. The other emission levels were very low against the limit.
5. " \* ": Fundamental frequency.

<b>RF Mode</b>	TX 802.11ax (HE20)	<b>Channel</b>	CH 64 : 5.32 GHz
<b>Frequency Range</b>	1GHz ~ 40GHz	<b>Detector Function</b>	Peak (PK) Average (AV)
<b>Input Power</b>	120Vac, 60Hz	<b>Environmental Conditions</b>	25 °C, 66% RH
<b>Tested By</b>	Tom Yang		

**Antenna Polarity & Test Distance : Horizontal at 3 m**

No	Frequency (MHz)	Emission Level (dBuV/m)	Limit (dBuV/m)	Margin (dB)	Antenna Height (m)	Table Angle (Degree)	Raw Value (dBuV)	Correction Factor (dB/m)
1	*5320.00	119.1 PK			1.02 H	295	118.1	1.0
2	*5320.00	107.2 AV			1.02 H	295	106.2	1.0
3	5350.00	65.4 PK	74.0	-8.6	1.02 H	295	64.2	1.2
<b>4</b>	<b>5350.00</b>	<b>53.9 AV</b>	<b>54.0</b>	<b>-0.1</b>	<b>1.02 H</b>	<b>295</b>	<b>52.7</b>	<b>1.2</b>
5	10640.00	37.6 PK	74.0	-36.4	1.41 H	211	26.6	11.0
6	10640.00	27.0 AV	54.0	-27.0	1.41 H	211	16.0	11.0
7	15960.00	33.8 PK	74.0	-40.2	1.60 H	151	21.5	12.3
8	15960.00	23.9 AV	54.0	-30.1	1.60 H	151	11.6	12.3

**Antenna Polarity & Test Distance : Vertical at 3 m**

No	Frequency (MHz)	Emission Level (dBuV/m)	Limit (dBuV/m)	Margin (dB)	Antenna Height (m)	Table Angle (Degree)	Raw Value (dBuV)	Correction Factor (dB/m)
1	*5320.00	114.6 PK			3.44 V	78	113.6	1.0
2	*5320.00	101.8 AV			3.44 V	78	100.8	1.0
3	5350.00	52.6 PK	74.0	-21.4	3.44 V	78	51.4	1.2
4	5350.00	42.1 AV	54.0	-11.9	3.44 V	78	40.9	1.2
5	10640.00	37.5 PK	74.0	-36.5	1.29 V	271	26.5	11.0
6	10640.00	26.9 AV	54.0	-27.1	1.29 V	271	15.9	11.0
7	15960.00	35.5 PK	74.0	-38.5	2.04 V	235	23.2	12.3
8	15960.00	26.2 AV	54.0	-27.8	2.04 V	235	13.9	12.3

**Remarks:**

1. Emission Level(dBuV/m) = Raw Value(dBuV) + Correction Factor(dB/m)
2. Correction Factor(dB/m) = Antenna Factor(dB/m) + Cable Factor(dB) – Pre-Amplifier Factor(dB)
3. Margin value = Emission Level – Limit value
4. The other emission levels were very low against the limit.
5. " \* " : Fundamental frequency.

<b>RF Mode</b>	TX 802.11ax (HE20)	<b>Channel</b>	CH 100 : 5.5 GHz
<b>Frequency Range</b>	1GHz ~ 40GHz	<b>Detector Function</b>	Peak (PK) Average (AV)
<b>Input Power</b>	120Vac, 60Hz	<b>Environmental Conditions</b>	25 °C, 66% RH
<b>Tested By</b>	Tom Yang		

**Antenna Polarity & Test Distance : Horizontal at 3 m**

No	Frequency (MHz)	Emission Level (dBuV/m)	Limit (dBuV/m)	Margin (dB)	Antenna Height (m)	Table Angle (Degree)	Raw Value (dBuV)	Correction Factor (dB/m)
1	5460.00	56.9 PK	74.0	-17.1	1.00 H	295	55.6	1.3
2	5460.00	45.1 AV	54.0	-8.9	1.00 H	295	43.8	1.3
3	#5470.00	68.0 PK	68.2	-0.2	1.00 H	295	66.7	1.3
4	*5500.00	117.3 PK			1.00 H	295	116.0	1.3
5	*5500.00	106.3 AV			1.00 H	295	105.0	1.3
6	11000.00	37.7 PK	74.0	-36.3	1.51 H	206	25.9	11.8
7	11000.00	27.2 AV	54.0	-26.8	1.51 H	206	15.4	11.8
8	#16500.00	33.8 PK	68.2	-34.4	1.63 H	138	19.5	14.3

**Antenna Polarity & Test Distance : Vertical at 3 m**

No	Frequency (MHz)	Emission Level (dBuV/m)	Limit (dBuV/m)	Margin (dB)	Antenna Height (m)	Table Angle (Degree)	Raw Value (dBuV)	Correction Factor (dB/m)
1	5460.00	50.7 PK	74.0	-23.3	3.50 V	71	49.4	1.3
2	5460.00	39.2 AV	54.0	-14.8	3.50 V	71	37.9	1.3
3	#5470.00	55.8 PK	68.2	-12.4	3.50 V	71	54.5	1.3
4	*5500.00	114.5 PK			3.50 V	71	113.2	1.3
5	*5500.00	101.6 AV			3.50 V	71	100.3	1.3
6	11000.00	38.0 PK	74.0	-36.0	1.32 V	286	26.2	11.8
7	11000.00	27.3 AV	54.0	-26.7	1.32 V	286	15.5	11.8
8	#16500.00	35.5 PK	68.2	-32.7	2.05 V	236	21.2	14.3

**Remarks:**

1. Emission Level(dBuV/m) = Raw Value(dBuV) + Correction Factor(dB/m)
2. Correction Factor(dB/m) = Antenna Factor(dB/m) + Cable Factor(dB) – Pre-Amplifier Factor(dB)
3. Margin value = Emission Level – Limit value
4. The other emission levels were very low against the limit.
5. " \* " : Fundamental frequency.
6. " # " : The radiated frequency is out of the restricted band.

<b>RF Mode</b>	TX 802.11ax (HE20)	<b>Channel</b>	CH 116 : 5.58 GHz
<b>Frequency Range</b>	1GHz ~ 40GHz	<b>Detector Function</b>	Peak (PK) Average (AV)
<b>Input Power</b>	120Vac, 60Hz	<b>Environmental Conditions</b>	25 °C, 66% RH
<b>Tested By</b>	Tom Yang		

**Antenna Polarity & Test Distance : Horizontal at 3 m**

No	Frequency (MHz)	Emission Level (dBuV/m)	Limit (dBuV/m)	Margin (dB)	Antenna Height (m)	Table Angle (Degree)	Raw Value (dBuV)	Correction Factor (dB/m)
1	*5580.00	120.3 PK			1.07 H	277	118.9	1.4
2	*5580.00	109.7 AV			1.07 H	277	108.3	1.4
3	11160.00	38.3 PK	74.0	-35.7	1.52 H	208	26.5	11.8
4	11160.00	27.4 AV	54.0	-26.6	1.52 H	208	15.6	11.8
5	#16740.00	34.3 PK	68.2	-33.9	1.57 H	122	18.5	15.8

**Antenna Polarity & Test Distance : Vertical at 3 m**

No	Frequency (MHz)	Emission Level (dBuV/m)	Limit (dBuV/m)	Margin (dB)	Antenna Height (m)	Table Angle (Degree)	Raw Value (dBuV)	Correction Factor (dB/m)
1	*5580.00	116.0 PK			3.49 V	76	114.6	1.4
2	*5580.00	103.4 AV			3.49 V	76	102.0	1.4
3	11160.00	38.0 PK	74.0	-36.0	1.31 V	264	26.2	11.8
4	11160.00	27.6 AV	54.0	-26.4	1.31 V	264	15.8	11.8
5	#16740.00	35.6 PK	68.2	-32.6	2.08 V	249	19.8	15.8

**Remarks:**

1. Emission Level(dBuV/m) = Raw Value(dBuV) + Correction Factor(dB/m)
2. Correction Factor(dB/m) = Antenna Factor(dB/m) + Cable Factor(dB) – Pre-Amplifier Factor(dB)
3. Margin value = Emission Level – Limit value
4. The other emission levels were very low against the limit.
5. " \* " : Fundamental frequency.
6. " # " : The radiated frequency is out of the restricted band.

<b>RF Mode</b>	TX 802.11ax (HE20)	<b>Channel</b>	CH 140 : 5.7 GHz
<b>Frequency Range</b>	1GHz ~ 40GHz	<b>Detector Function</b>	Peak (PK) Average (AV)
<b>Input Power</b>	120Vac, 60Hz	<b>Environmental Conditions</b>	25 °C, 66% RH
<b>Tested By</b>	Tom Yang		

**Antenna Polarity & Test Distance : Horizontal at 3 m**

No	Frequency (MHz)	Emission Level (dBuV/m)	Limit (dBuV/m)	Margin (dB)	Antenna Height (m)	Table Angle (Degree)	Raw Value (dBuV)	Correction Factor (dB/m)
1	*5700.00	117.6 PK			1.00 H	29	115.8	1.8
2	*5700.00	107.0 AV			1.00 H	29	105.2	1.8
3	#5725.00	67.6 PK	68.2	-0.6	1.00 H	29	65.7	1.9
4	11400.00	38.2 PK	74.0	-35.8	1.52 H	185	25.8	12.4
5	11400.00	27.3 AV	54.0	-26.7	1.52 H	185	14.9	12.4
6	#17100.00	33.7 PK	68.2	-34.5	1.65 H	145	17.0	16.7

**Antenna Polarity & Test Distance : Vertical at 3 m**

No	Frequency (MHz)	Emission Level (dBuV/m)	Limit (dBuV/m)	Margin (dB)	Antenna Height (m)	Table Angle (Degree)	Raw Value (dBuV)	Correction Factor (dB/m)
1	*5700.00	114.2 PK			3.42 V	60	112.4	1.8
2	*5700.00	101.6 AV			3.42 V	60	99.8	1.8
3	#5725.00	49.2 PK	68.2	-19.0	3.42 V	60	47.3	1.9
4	11400.00	38.0 PK	74.0	-36.0	1.29 V	277	25.6	12.4
5	11400.00	27.7 AV	54.0	-26.3	1.29 V	277	15.3	12.4
6	#17100.00	35.6 PK	68.2	-32.6	2.05 V	256	18.9	16.7

**Remarks:**

1. Emission Level(dBuV/m) = Raw Value(dBuV) + Correction Factor(dB/m)
2. Correction Factor(dB/m) = Antenna Factor(dB/m) + Cable Factor(dB) – Pre-Amplifier Factor(dB)
3. Margin value = Emission Level – Limit value
4. The other emission levels were very low against the limit.
5. " \* ": Fundamental frequency.
6. " # ": The radiated frequency is out of the restricted band.

<b>RF Mode</b>	TX 802.11ax (HE20)	<b>Channel</b>	CH 144 : 5.72 GHz
<b>Frequency Range</b>	1GHz ~ 40GHz	<b>Detector Function</b>	Peak (PK) Average (AV)
<b>Input Power</b>	120Vac, 60Hz	<b>Environmental Conditions</b>	25 °C, 66% RH
<b>Tested By</b>	Tom Yang		

**Antenna Polarity & Test Distance : Horizontal at 3 m**

No	Frequency (MHz)	Emission Level (dBuV/m)	Limit (dBuV/m)	Margin (dB)	Antenna Height (m)	Table Angle (Degree)	Raw Value (dBuV)	Correction Factor (dB/m)
1	5460.00	48.6 PK	74.0	-25.4	1.13 H	290	47.3	1.3
2	5460.00	38.3 AV	54.0	-15.7	1.13 H	290	37.0	1.3
3	#5470.00	49.4 PK	68.2	-18.8	1.13 H	290	48.1	1.3
4	*5720.00	120.2 PK			1.13 H	290	118.3	1.9
5	*5720.00	109.3 AV			1.13 H	290	107.4	1.9
6	#5850.00	48.4 PK	68.2	-19.8	1.13 H	290	46.5	1.9
7	11440.00	38.3 PK	74.0	-35.7	1.46 H	198	25.8	12.5
8	11440.00	27.6 AV	54.0	-26.4	1.46 H	198	15.1	12.5
9	#17160.00	34.0 PK	68.2	-34.2	1.61 H	137	17.3	16.7

**Antenna Polarity & Test Distance : Vertical at 3 m**

No	Frequency (MHz)	Emission Level (dBuV/m)	Limit (dBuV/m)	Margin (dB)	Antenna Height (m)	Table Angle (Degree)	Raw Value (dBuV)	Correction Factor (dB/m)
1	5460.00	48.9 PK	74.0	-25.1	3.40 V	64	47.6	1.3
2	5460.00	38.6 AV	54.0	-15.4	3.40 V	64	37.3	1.3
3	#5470.00	49.3 PK	68.2	-18.9	3.40 V	64	48.0	1.3
4	*5720.00	115.9 PK			3.40 V	64	114.0	1.9
5	*5720.00	103.4 AV			3.40 V	64	101.5	1.9
6	#5850.00	49.3 PK	68.2	-18.9	3.40 V	64	47.4	1.9
7	11440.00	38.2 PK	74.0	-35.8	1.33 V	284	25.7	12.5
8	11440.00	27.6 AV	54.0	-26.4	1.33 V	284	15.1	12.5
9	#17160.00	35.3 PK	68.2	-32.9	2.05 V	254	18.6	16.7

**Remarks:**

1. Emission Level(dBuV/m) = Raw Value(dBuV) + Correction Factor(dB/m)
2. Correction Factor(dB/m) = Antenna Factor(dB/m) + Cable Factor(dB) – Pre-Amplifier Factor(dB)
3. Margin value = Emission Level – Limit value
4. The other emission levels were very low against the limit.
5. " \* " : Fundamental frequency.
6. " # " : The radiated frequency is out of the restricted band.

<b>RF Mode</b>	TX 802.11ax (HE20)	<b>Channel</b>	CH 149 : 5.745 GHz
<b>Frequency Range</b>	1GHz ~ 40GHz	<b>Detector Function</b>	Peak (PK) Average (AV)
<b>Input Power</b>	120Vac, 60Hz	<b>Environmental Conditions</b>	25 °C, 66% RH
<b>Tested By</b>	Tom Yang		

**Antenna Polarity & Test Distance : Horizontal at 3 m**

No	Frequency (MHz)	Emission Level (dBuV/m)	Limit (dBuV/m)	Margin (dB)	Antenna Height (m)	Table Angle (Degree)	Raw Value (dBuV)	Correction Factor (dB/m)
1	#5644.05	55.2 PK	68.2	-13.0	1.01 H	32	53.4	1.8
2	*5745.00	121.1 PK			1.01 H	32	119.1	2.0
3	*5745.00	110.8 AV			1.01 H	32	108.8	2.0
4	#5945.39	49.2 PK	68.2	-19.0	1.01 H	32	46.9	2.3
5	11490.00	37.7 PK	74.0	-36.3	1.52 H	205	25.3	12.4
6	11490.00	26.9 AV	54.0	-27.1	1.52 H	205	14.5	12.4
7	#17235.00	33.2 PK	68.2	-35.0	1.67 H	130	16.5	16.7

**Antenna Polarity & Test Distance : Vertical at 3 m**

No	Frequency (MHz)	Emission Level (dBuV/m)	Limit (dBuV/m)	Margin (dB)	Antenna Height (m)	Table Angle (Degree)	Raw Value (dBuV)	Correction Factor (dB/m)
1	#5649.68	50.7 PK	68.2	-17.5	3.32 V	289	48.9	1.8
2	*5745.00	114.1 PK			3.32 V	289	112.1	2.0
3	*5745.00	103.6 AV			3.32 V	289	101.6	2.0
4	#6021.83	49.4 PK	68.2	-18.8	3.32 V	289	47.1	2.3
5	11490.00	38.0 PK	74.0	-36.0	1.24 V	279	25.6	12.4
6	11490.00	27.4 AV	54.0	-26.6	1.24 V	279	15.0	12.4
7	#17235.00	35.2 PK	68.2	-33.0	2.12 V	246	18.5	16.7

**Remarks:**

1. Emission Level(dBuV/m) = Raw Value(dBuV) + Correction Factor(dB/m)
2. Correction Factor(dB/m) = Antenna Factor(dB/m) + Cable Factor(dB) – Pre-Amplifier Factor(dB)
3. Margin value = Emission Level – Limit value
4. The other emission levels were very low against the limit.
5. " \* " : Fundamental frequency.
6. " # " : The radiated frequency is out of the restricted band.



<b>RF Mode</b>	TX 802.11ax (HE20)	<b>Channel</b>	CH 157 : 5.785 GHz
<b>Frequency Range</b>	1GHz ~ 40GHz	<b>Detector Function</b>	Peak (PK) Average (AV)
<b>Input Power</b>	120Vac, 60Hz	<b>Environmental Conditions</b>	25 °C, 66% RH
<b>Tested By</b>	Tom Yang		

**Antenna Polarity & Test Distance : Horizontal at 3 m**

No	Frequency (MHz)	Emission Level (dBuV/m)	Limit (dBuV/m)	Margin (dB)	Antenna Height (m)	Table Angle (Degree)	Raw Value (dBuV)	Correction Factor (dB/m)
1	#5630.11	50.2 PK	68.2	-18.0	1.02 H	28	48.4	1.8
2	*5785.00	120.2 PK			1.02 H	28	118.1	2.1
3	*5785.00	109.7 AV			1.02 H	28	107.6	2.1
4	#5938.60	49.4 PK	68.2	-18.8	1.02 H	28	47.1	2.3
5	11570.00	38.3 PK	74.0	-35.7	1.50 H	193	26.0	12.3
6	11570.00	27.5 AV	54.0	-26.5	1.50 H	193	15.2	12.3
7	#17355.00	34.5 PK	68.2	-33.7	1.56 H	134	17.0	17.5

**Antenna Polarity & Test Distance : Vertical at 3 m**

No	Frequency (MHz)	Emission Level (dBuV/m)	Limit (dBuV/m)	Margin (dB)	Antenna Height (m)	Table Angle (Degree)	Raw Value (dBuV)	Correction Factor (dB/m)
1	#5638.77	49.8 PK	68.2	-18.4	3.30 V	295	48.0	1.8
2	*5785.00	114.0 PK			3.30 V	295	111.9	2.1
3	*5785.00	103.6 AV			3.30 V	295	101.5	2.1
4	#5933.49	49.8 PK	68.2	-18.4	3.30 V	295	47.6	2.2
5	11570.00	37.9 PK	74.0	-36.1	1.23 V	269	25.6	12.3
6	11570.00	27.2 AV	54.0	-26.8	1.23 V	269	14.9	12.3
7	#17355.00	35.5 PK	68.2	-32.7	2.05 V	241	18.0	17.5

**Remarks:**

1. Emission Level(dBuV/m) = Raw Value(dBuV) + Correction Factor(dB/m)
2. Correction Factor(dB/m) = Antenna Factor(dB/m) + Cable Factor(dB) – Pre-Amplifier Factor(dB)
3. Margin value = Emission Level – Limit value
4. The other emission levels were very low against the limit.
5. " \* " : Fundamental frequency.
6. " # " : The radiated frequency is out of the restricted band.

<b>RF Mode</b>	TX 802.11ax (HE20)	<b>Channel</b>	CH 165 : 5.825 GHz
<b>Frequency Range</b>	1GHz ~ 40GHz	<b>Detector Function</b>	Peak (PK) Average (AV)
<b>Input Power</b>	120Vac, 60Hz	<b>Environmental Conditions</b>	25 °C, 66% RH
<b>Tested By</b>	Tom Yang		

**Antenna Polarity & Test Distance : Horizontal at 3 m**

No	Frequency (MHz)	Emission Level (dBuV/m)	Limit (dBuV/m)	Margin (dB)	Antenna Height (m)	Table Angle (Degree)	Raw Value (dBuV)	Correction Factor (dB/m)
1	#5617.84	49.6 PK	68.2	-18.6	1.05 H	24	47.8	1.8
2	*5825.00	120.5 PK			1.05 H	24	118.5	2.0
3	*5825.00	110.2 AV			1.05 H	24	108.2	2.0
4	#5931.73	53.9 PK	68.2	-14.3	1.05 H	24	51.7	2.2
5	11650.00	37.5 PK	74.0	-36.5	1.49 H	180	25.3	12.2
6	11650.00	26.8 AV	54.0	-27.2	1.49 H	180	14.6	12.2
7	#17475.00	33.9 PK	68.2	-34.3	1.63 H	141	15.7	18.2

**Antenna Polarity & Test Distance : Vertical at 3 m**

No	Frequency (MHz)	Emission Level (dBuV/m)	Limit (dBuV/m)	Margin (dB)	Antenna Height (m)	Table Angle (Degree)	Raw Value (dBuV)	Correction Factor (dB/m)
1	#5593.94	48.8 PK	68.2	-19.4	3.34 V	286	47.1	1.7
2	*5825.00	114.3 PK			3.34 V	286	112.3	2.0
3	*5825.00	103.6 AV			3.34 V	286	101.6	2.0
4	#5937.27	49.8 PK	68.2	-18.4	3.34 V	286	47.6	2.2
5	11650.00	38.3 PK	74.0	-35.7	1.24 V	278	26.1	12.2
6	11650.00	27.6 AV	54.0	-26.4	1.24 V	278	15.4	12.2
7	#17475.00	35.1 PK	68.2	-33.1	2.12 V	255	16.9	18.2

**Remarks:**

1. Emission Level(dBuV/m) = Raw Value(dBuV) + Correction Factor(dB/m)
2. Correction Factor(dB/m) = Antenna Factor(dB/m) + Cable Factor(dB) – Pre-Amplifier Factor(dB)
3. Margin value = Emission Level – Limit value
4. The other emission levels were very low against the limit.
5. " \* " : Fundamental frequency.
6. " # " : The radiated frequency is out of the restricted band.

<b>RF Mode</b>	TX 802.11ax (HE40)	<b>Channel</b>	CH 38 : 5.19 GHz
<b>Frequency Range</b>	1GHz ~ 40GHz	<b>Detector Function</b>	Peak (PK) Average (AV)
<b>Input Power</b>	120Vac, 60Hz	<b>Environmental Conditions</b>	25 °C, 66% RH
<b>Tested By</b>	Tom Yang		

**Antenna Polarity & Test Distance : Horizontal at 3 m**

No	Frequency (MHz)	Emission Level (dBuV/m)	Limit (dBuV/m)	Margin (dB)	Antenna Height (m)	Table Angle (Degree)	Raw Value (dBuV)	Correction Factor (dB/m)
1	5145.80	68.1 PK	74.0	-5.9	1.00 H	292	66.6	1.5
2	5145.80	53.5 AV	54.0	-0.5	1.00 H	292	52.0	1.5
3	*5190.00	113.8 PK			1.00 H	292	112.7	1.1
4	*5190.00	103.1 AV			1.00 H	292	102.0	1.1
5	#10380.00	37.9 PK	68.2	-30.3	1.47 H	205	26.9	11.0
6	15570.00	33.5 PK	74.0	-40.5	1.63 H	141	21.3	12.2
7	15570.00	23.8 AV	54.0	-30.2	1.63 H	141	11.6	12.2

**Antenna Polarity & Test Distance : Vertical at 3 m**

No	Frequency (MHz)	Emission Level (dBuV/m)	Limit (dBuV/m)	Margin (dB)	Antenna Height (m)	Table Angle (Degree)	Raw Value (dBuV)	Correction Factor (dB/m)
1	5150.00	57.3 PK	74.0	-16.7	3.54 V	285	55.8	1.5
2	5150.00	44.0 AV	54.0	-10.0	3.54 V	285	42.5	1.5
3	*5190.00	107.7 PK			3.54 V	285	106.6	1.1
4	*5190.00	96.6 AV			3.54 V	285	95.5	1.1
5	#10380.00	37.5 PK	68.2	-30.7	1.27 V	269	26.5	11.0
6	15570.00	35.3 PK	74.0	-38.7	2.12 V	260	23.1	12.2
7	15570.00	25.9 AV	54.0	-28.1	2.12 V	260	13.7	12.2

**Remarks:**

1. Emission Level(dBuV/m) = Raw Value(dBuV) + Correction Factor(dB/m)
2. Correction Factor(dB/m) = Antenna Factor(dB/m) + Cable Factor(dB) – Pre-Amplifier Factor(dB)
3. Margin value = Emission Level – Limit value
4. The other emission levels were very low against the limit.
5. " \* " : Fundamental frequency.
6. " # " : The radiated frequency is out of the restricted band.

<b>RF Mode</b>	TX 802.11ax (HE40)	<b>Channel</b>	CH 46 : 5.23 GHz
<b>Frequency Range</b>	1GHz ~ 40GHz	<b>Detector Function</b>	Peak (PK) Average (AV)
<b>Input Power</b>	120Vac, 60Hz	<b>Environmental Conditions</b>	25 °C, 66% RH
<b>Tested By</b>	Tom Yang		

**Antenna Polarity & Test Distance : Horizontal at 3 m**

No	Frequency (MHz)	Emission Level (dBuV/m)	Limit (dBuV/m)	Margin (dB)	Antenna Height (m)	Table Angle (Degree)	Raw Value (dBuV)	Correction Factor (dB/m)
1	5150.00	65.6 PK	74.0	-8.4	1.00 H	113	64.1	1.5
2	5150.00	53.5 AV	54.0	-0.5	1.00 H	113	52.0	1.5
3	*5230.00	117.9 PK			1.00 H	113	116.9	1.0
4	*5230.00	106.9 AV			1.00 H	113	105.9	1.0
5	#10460.00	37.7 PK	68.2	-30.5	1.45 H	186	26.6	11.1
6	15690.00	33.2 PK	74.0	-40.8	1.67 H	139	21.1	12.1
7	15690.00	23.5 AV	54.0	-30.5	1.67 H	139	11.4	12.1

**Antenna Polarity & Test Distance : Vertical at 3 m**

No	Frequency (MHz)	Emission Level (dBuV/m)	Limit (dBuV/m)	Margin (dB)	Antenna Height (m)	Table Angle (Degree)	Raw Value (dBuV)	Correction Factor (dB/m)
1	5150.00	49.0 PK	74.0	-25.0	3.58 V	293	47.5	1.5
2	5150.00	38.2 AV	54.0	-15.8	3.58 V	293	36.7	1.5
3	*5230.00	110.2 PK			3.58 V	293	109.2	1.0
4	*5230.00	99.1 AV			3.58 V	293	98.1	1.0
5	#10460.00	37.6 PK	68.2	-30.6	1.33 V	283	26.5	11.1
6	15690.00	35.3 PK	74.0	-38.7	2.10 V	248	23.2	12.1
7	15690.00	25.9 AV	54.0	-28.1	2.10 V	248	13.8	12.1

**Remarks:**

1. Emission Level(dBuV/m) = Raw Value(dBuV) + Correction Factor(dB/m)
2. Correction Factor(dB/m) = Antenna Factor(dB/m) + Cable Factor(dB) – Pre-Amplifier Factor(dB)
3. Margin value = Emission Level – Limit value
4. The other emission levels were very low against the limit.
5. " \* " : Fundamental frequency.
6. " # " : The radiated frequency is out of the restricted band.

<b>RF Mode</b>	TX 802.11ax (HE40)	<b>Channel</b>	CH 54 : 5.27 GHz
<b>Frequency Range</b>	1GHz ~ 40GHz	<b>Detector Function</b>	Peak (PK) Average (AV)
<b>Input Power</b>	120Vac, 60Hz	<b>Environmental Conditions</b>	25 °C, 66% RH
<b>Tested By</b>	Tom Yang		

**Antenna Polarity & Test Distance : Horizontal at 3 m**

No	Frequency (MHz)	Emission Level (dBuV/m)	Limit (dBuV/m)	Margin (dB)	Antenna Height (m)	Table Angle (Degree)	Raw Value (dBuV)	Correction Factor (dB/m)
1	*5270.00	117.5 PK			1.00 H	112	116.6	0.9
2	*5270.00	107.2 AV			1.00 H	112	106.3	0.9
3	5350.00	65.8 PK	74.0	-8.2	1.00 H	112	64.6	1.2
4	5350.00	53.5 AV	54.0	-0.5	1.00 H	112	52.3	1.2
5	#10540.00	38.3 PK	68.2	-29.9	1.42 H	209	27.3	11.0
6	15810.00	34.1 PK	74.0	-39.9	1.61 H	130	22.1	12.0
7	15810.00	23.9 AV	54.0	-30.1	1.61 H	130	11.9	12.0

**Antenna Polarity & Test Distance : Vertical at 3 m**

No	Frequency (MHz)	Emission Level (dBuV/m)	Limit (dBuV/m)	Margin (dB)	Antenna Height (m)	Table Angle (Degree)	Raw Value (dBuV)	Correction Factor (dB/m)
1	*5270.00	110.4 PK			3.49 V	270	109.5	0.9
2	*5270.00	99.2 AV			3.49 V	270	98.3	0.9
3	5350.00	48.9 PK	74.0	-25.1	3.49 V	270	47.7	1.2
4	5350.00	38.6 AV	54.0	-15.4	3.49 V	270	37.4	1.2
5	#10540.00	38.0 PK	68.2	-30.2	1.33 V	273	27.0	11.0
6	15810.00	36.0 PK	74.0	-38.0	2.02 V	242	24.0	12.0
7	15810.00	26.3 AV	54.0	-27.7	2.02 V	242	14.3	12.0

**Remarks:**

1. Emission Level(dBuV/m) = Raw Value(dBuV) + Correction Factor(dB/m)
2. Correction Factor(dB/m) = Antenna Factor(dB/m) + Cable Factor(dB) – Pre-Amplifier Factor(dB)
3. Margin value = Emission Level – Limit value
4. The other emission levels were very low against the limit.
5. " \* " : Fundamental frequency.
6. " # " : The radiated frequency is out of the restricted band.

<b>RF Mode</b>	TX 802.11ax (HE40)	<b>Channel</b>	CH 62 : 5.31 GHz
<b>Frequency Range</b>	1GHz ~ 40GHz	<b>Detector Function</b>	Peak (PK) Average (AV)
<b>Input Power</b>	120Vac, 60Hz	<b>Environmental Conditions</b>	25 °C, 66% RH
<b>Tested By</b>	Tom Yang		

**Antenna Polarity & Test Distance : Horizontal at 3 m**

No	Frequency (MHz)	Emission Level (dBuV/m)	Limit (dBuV/m)	Margin (dB)	Antenna Height (m)	Table Angle (Degree)	Raw Value (dBuV)	Correction Factor (dB/m)
1	*5310.00	113.8 PK			1.00 H	116	112.8	1.0
2	*5310.00	103.4 AV			1.00 H	116	102.4	1.0
3	5350.00	65.7 PK	74.0	-8.3	1.00 H	116	64.5	1.2
4	5350.00	53.5 AV	54.0	-0.5	1.00 H	116	52.3	1.2
5	10620.00	38.2 PK	74.0	-35.8	1.47 H	185	27.3	10.9
6	10620.00	27.3 AV	54.0	-26.7	1.47 H	185	16.4	10.9
7	15930.00	34.2 PK	74.0	-39.8	1.59 H	125	21.9	12.3
8	15930.00	24.1 AV	54.0	-29.9	1.59 H	125	11.8	12.3

**Antenna Polarity & Test Distance : Vertical at 3 m**

No	Frequency (MHz)	Emission Level (dBuV/m)	Limit (dBuV/m)	Margin (dB)	Antenna Height (m)	Table Angle (Degree)	Raw Value (dBuV)	Correction Factor (dB/m)
1	*5310.00	107.3 PK			3.49 V	288	106.3	1.0
2	*5310.00	96.1 AV			3.49 V	288	95.1	1.0
3	5350.00	58.4 PK	74.0	-15.6	3.49 V	288	57.2	1.2
4	5350.00	47.4 AV	54.0	-6.6	3.49 V	288	46.2	1.2
5	10620.00	38.3 PK	74.0	-35.7	1.32 V	269	27.4	10.9
6	10620.00	27.7 AV	54.0	-26.3	1.32 V	269	16.8	10.9
7	15930.00	35.5 PK	74.0	-38.5	2.11 V	265	23.2	12.3
8	15930.00	25.9 AV	54.0	-28.1	2.11 V	265	13.6	12.3

**Remarks:**

1. Emission Level(dBuV/m) = Raw Value(dBuV) + Correction Factor(dB/m)
2. Correction Factor(dB/m) = Antenna Factor(dB/m) + Cable Factor(dB) – Pre-Amplifier Factor(dB)
3. Margin value = Emission Level – Limit value
4. The other emission levels were very low against the limit.
5. " \* " : Fundamental frequency.

<b>RF Mode</b>	TX 802.11ax (HE40)	<b>Channel</b>	CH 102 : 5.51 GHz
<b>Frequency Range</b>	1GHz ~ 40GHz	<b>Detector Function</b>	Peak (PK) Average (AV)
<b>Input Power</b>	120Vac, 60Hz	<b>Environmental Conditions</b>	25 °C, 66% RH
<b>Tested By</b>	Tom Yang		

**Antenna Polarity & Test Distance : Horizontal at 3 m**

No	Frequency (MHz)	Emission Level (dBuV/m)	Limit (dBuV/m)	Margin (dB)	Antenna Height (m)	Table Angle (Degree)	Raw Value (dBuV)	Correction Factor (dB/m)
1	5460.00	61.4 PK	74.0	-12.6	1.00 H	100	60.1	1.3
2	5460.00	45.3 AV	54.0	-8.7	1.00 H	100	44.0	1.3
3	#5467.15	67.4 PK	68.2	-0.8	1.00 H	100	66.1	1.3
4	*5510.00	113.9 PK			1.00 H	100	112.6	1.3
5	*5510.00	103.1 AV			1.00 H	100	101.8	1.3
6	11020.00	38.0 PK	74.0	-36.0	1.48 H	203	26.2	11.8
7	11020.00	27.3 AV	54.0	-26.7	1.48 H	203	15.5	11.8
8	#16530.00	33.6 PK	68.2	-34.6	1.66 H	152	19.2	14.4

**Antenna Polarity & Test Distance : Vertical at 3 m**

No	Frequency (MHz)	Emission Level (dBuV/m)	Limit (dBuV/m)	Margin (dB)	Antenna Height (m)	Table Angle (Degree)	Raw Value (dBuV)	Correction Factor (dB/m)
1	5460.00	56.8 PK	74.0	-17.2	3.49 V	298	55.5	1.3
2	5460.00	42.6 AV	54.0	-11.4	3.49 V	298	41.3	1.3
3	#5468.48	59.3 PK	68.2	-8.9	3.49 V	298	58.0	1.3
4	*5510.00	107.3 PK			3.49 V	298	106.0	1.3
5	*5510.00	96.0 AV			3.49 V	298	94.7	1.3
6	11020.00	37.6 PK	74.0	-36.4	1.28 V	268	25.8	11.8
7	11020.00	26.9 AV	54.0	-27.1	1.28 V	268	15.1	11.8
8	#16530.00	35.4 PK	68.2	-32.8	2.08 V	253	21.0	14.4

**Remarks:**

1. Emission Level(dBuV/m) = Raw Value(dBuV) + Correction Factor(dB/m)
2. Correction Factor(dB/m) = Antenna Factor(dB/m) + Cable Factor(dB) – Pre-Amplifier Factor(dB)
3. Margin value = Emission Level – Limit value
4. The other emission levels were very low against the limit.
5. " \* " : Fundamental frequency.
6. " # " : The radiated frequency is out of the restricted band.

<b>RF Mode</b>	TX 802.11ax (HE40)	<b>Channel</b>	CH 110 : 5.55 GHz
<b>Frequency Range</b>	1GHz ~ 40GHz	<b>Detector Function</b>	Peak (PK) Average (AV)
<b>Input Power</b>	120Vac, 60Hz	<b>Environmental Conditions</b>	25 °C, 66% RH
<b>Tested By</b>	Tom Yang		

**Antenna Polarity & Test Distance : Horizontal at 3 m**

No	Frequency (MHz)	Emission Level (dBuV/m)	Limit (dBuV/m)	Margin (dB)	Antenna Height (m)	Table Angle (Degree)	Raw Value (dBuV)	Correction Factor (dB/m)
1	5460.00	64.2 PK	74.0	-9.8	1.00 H	0	62.9	1.3
2	5460.00	51.0 AV	54.0	-3.0	1.00 H	0	49.7	1.3
3	#5470.00	68.0 PK	68.2	-0.2	1.00 H	0	66.7	1.3
4	*5550.00	116.9 PK			1.03 H	203	115.6	1.3
5	*5550.00	116.1 AV			1.03 H	203	114.8	1.3
6	11100.00	37.9 PK	74.0	-36.1	1.43 H	186	26.2	11.7
7	11100.00	27.0 AV	54.0	-27.0	1.43 H	186	15.3	11.7
8	#16650.00	33.9 PK	68.2	-34.3	1.57 H	140	18.6	15.3

**Antenna Polarity & Test Distance : Vertical at 3 m**

No	Frequency (MHz)	Emission Level (dBuV/m)	Limit (dBuV/m)	Margin (dB)	Antenna Height (m)	Table Angle (Degree)	Raw Value (dBuV)	Correction Factor (dB/m)
1	*5550.00	111.0 PK			3.58 V	295	109.7	1.3
2	*5550.00	99.4 AV			3.58 V	295	98.1	1.3
3	11100.00	37.7 PK	74.0	-36.3	1.26 V	281	26.0	11.7
4	11100.00	27.0 AV	54.0	-27.0	1.26 V	281	15.3	11.7
5	#16650.00	35.4 PK	68.2	-32.8	2.02 V	266	20.1	15.3

**Remarks:**

1. Emission Level(dBuV/m) = Raw Value(dBuV) + Correction Factor(dB/m)
2. Correction Factor(dB/m) = Antenna Factor(dB/m) + Cable Factor(dB) – Pre-Amplifier Factor(dB)
3. Margin value = Emission Level – Limit value
4. The other emission levels were very low against the limit.
5. " \* " : Fundamental frequency.
6. " # " : The radiated frequency is out of the restricted band.



<b>RF Mode</b>	TX 802.11ax (HE40)	<b>Channel</b>	CH 134 : 5.67 GHz
<b>Frequency Range</b>	1GHz ~ 40GHz	<b>Detector Function</b>	Peak (PK) Average (AV)
<b>Input Power</b>	120Vac, 60Hz	<b>Environmental Conditions</b>	25 °C, 66% RH
<b>Tested By</b>	Tom Yang		

**Antenna Polarity & Test Distance : Horizontal at 3 m**

No	Frequency (MHz)	Emission Level (dBuV/m)	Limit (dBuV/m)	Margin (dB)	Antenna Height (m)	Table Angle (Degree)	Raw Value (dBuV)	Correction Factor (dB/m)
1	*5670.00	114.9 PK			1.02 H	208	113.2	1.7
2	*5670.00	105.0 AV			1.02 H	208	103.3	1.7
3	#5725.00	67.9 PK	68.2	-0.3	1.02 H	208	66.0	1.9
4	11340.00	37.7 PK	74.0	-36.3	1.51 H	193	25.3	12.4
5	11340.00	26.9 AV	54.0	-27.1	1.51 H	193	14.5	12.4
6	#17010.00	34.5 PK	68.2	-33.7	1.64 H	148	17.9	16.6

**Antenna Polarity & Test Distance : Vertical at 3 m**

No	Frequency (MHz)	Emission Level (dBuV/m)	Limit (dBuV/m)	Margin (dB)	Antenna Height (m)	Table Angle (Degree)	Raw Value (dBuV)	Correction Factor (dB/m)
1	*5670.00	110.1 PK			3.58 V	278	108.4	1.7
2	*5670.00	98.3 AV			3.58 V	278	96.6	1.7
3	#5725.00	49.3 PK	68.2	-18.9	3.58 V	278	47.4	1.9
4	11340.00	37.0 PK	74.0	-37.0	1.27 V	260	24.6	12.4
5	11340.00	26.8 AV	54.0	-27.2	1.27 V	260	14.4	12.4
6	#17010.00	36.0 PK	68.2	-32.2	2.08 V	258	19.4	16.6

**Remarks:**

1. Emission Level(dBuV/m) = Raw Value(dBuV) + Correction Factor(dB/m)
2. Correction Factor(dB/m) = Antenna Factor(dB/m) + Cable Factor(dB) – Pre-Amplifier Factor(dB)
3. Margin value = Emission Level – Limit value
4. The other emission levels were very low against the limit.
5. " \* ": Fundamental frequency.
6. " # ": The radiated frequency is out of the restricted band.

<b>RF Mode</b>	TX 802.11ax (HE40)	<b>Channel</b>	CH 142 : 5.71 GHz
<b>Frequency Range</b>	1GHz ~ 40GHz	<b>Detector Function</b>	Peak (PK) Average (AV)
<b>Input Power</b>	120Vac, 60Hz	<b>Environmental Conditions</b>	25 °C, 66% RH
<b>Tested By</b>	Tom Yang		

**Antenna Polarity & Test Distance : Horizontal at 3 m**

No	Frequency (MHz)	Emission Level (dBuV/m)	Limit (dBuV/m)	Margin (dB)	Antenna Height (m)	Table Angle (Degree)	Raw Value (dBuV)	Correction Factor (dB/m)
1	5460.00	48.8 PK	74.0	-25.2	1.02 H	212	47.5	1.3
2	5460.00	37.6 AV	54.0	-16.4	1.02 H	212	36.3	1.3
3	#5470.00	49.2 PK	68.2	-19.0	1.02 H	212	47.9	1.3
4	*5710.00	116.6 PK			1.02 H	212	114.8	1.8
5	*5710.00	106.3 AV			1.02 H	212	104.5	1.8
6	#5850.00	49.8 PK	68.2	-18.4	1.02 H	212	47.9	1.9
7	11420.00	37.8 PK	74.0	-36.2	1.42 H	186	25.4	12.4
8	11420.00	27.2 AV	54.0	-26.8	1.42 H	186	14.8	12.4
9	#17130.00	33.7 PK	68.2	-34.5	1.59 H	127	17.0	16.7

**Antenna Polarity & Test Distance : Vertical at 3 m**

No	Frequency (MHz)	Emission Level (dBuV/m)	Limit (dBuV/m)	Margin (dB)	Antenna Height (m)	Table Angle (Degree)	Raw Value (dBuV)	Correction Factor (dB/m)
1	5460.00	48.9 PK	74.0	-25.1	3.50 V	277	47.6	1.3
2	5460.00	38.7 AV	54.0	-15.3	3.50 V	277	37.4	1.3
3	#5470.00	48.7 PK	68.2	-19.5	3.50 V	277	47.4	1.3
4	*5710.00	111.4 PK			3.50 V	277	109.6	1.8
5	*5710.00	99.3 AV			3.50 V	277	97.5	1.8
6	#5850.00	49.2 PK	68.2	-19.0	3.50 V	277	47.3	1.9
7	11420.00	37.8 PK	74.0	-36.2	1.27 V	282	25.4	12.4
8	11420.00	27.2 AV	54.0	-26.8	1.27 V	282	14.8	12.4
9	#17130.00	35.9 PK	68.2	-32.3	2.12 V	262	19.2	16.7

**Remarks:**

1. Emission Level(dBuV/m) = Raw Value(dBuV) + Correction Factor(dB/m)
2. Correction Factor(dB/m) = Antenna Factor(dB/m) + Cable Factor(dB) – Pre-Amplifier Factor(dB)
3. Margin value = Emission Level – Limit value
4. The other emission levels were very low against the limit.
5. " \* " : Fundamental frequency.
6. " # " : The radiated frequency is out of the restricted band.

<b>RF Mode</b>	TX 802.11ax (HE40)	<b>Channel</b>	CH 151 : 5.755 GHz
<b>Frequency Range</b>	1GHz ~ 40GHz	<b>Detector Function</b>	Peak (PK) Average (AV)
<b>Input Power</b>	120Vac, 60Hz	<b>Environmental Conditions</b>	25 °C, 66% RH
<b>Tested By</b>	Tom Yang		

**Antenna Polarity & Test Distance : Horizontal at 3 m**

No	Frequency (MHz)	Emission Level (dBuV/m)	Limit (dBuV/m)	Margin (dB)	Antenna Height (m)	Table Angle (Degree)	Raw Value (dBuV)	Correction Factor (dB/m)
1	#5645.12	63.6 PK	68.2	-4.6	1.01 H	31	61.8	1.8
2	*5755.00	117.6 PK			1.01 H	31	115.5	2.1
3	*5755.00	107.1 AV			1.01 H	31	105.0	2.1
4	#5959.69	50.8 PK	68.2	-17.4	1.01 H	31	48.5	2.3
5	11510.00	37.2 PK	74.0	-36.8	1.50 H	184	24.8	12.4
6	11510.00	26.6 AV	54.0	-27.4	1.50 H	184	14.2	12.4
7	#17265.00	34.0 PK	68.2	-34.2	1.66 H	130	17.2	16.8

**Antenna Polarity & Test Distance : Vertical at 3 m**

No	Frequency (MHz)	Emission Level (dBuV/m)	Limit (dBuV/m)	Margin (dB)	Antenna Height (m)	Table Angle (Degree)	Raw Value (dBuV)	Correction Factor (dB/m)
1	#5649.32	58.8 PK	68.2	-9.4	3.29 V	289	57.0	1.8
2	*5755.00	111.5 PK			3.29 V	289	109.4	2.1
3	*5755.00	100.2 AV			3.29 V	289	98.1	2.1
4	#5993.26	49.7 PK	68.2	-18.5	3.29 V	289	47.4	2.3
5	11510.00	37.9 PK	74.0	-36.1	1.24 V	272	25.5	12.4
6	11510.00	27.3 AV	54.0	-26.7	1.24 V	272	14.9	12.4
7	#17265.00	35.7 PK	68.2	-32.5	2.11 V	258	18.9	16.8

**Remarks:**

1. Emission Level(dBuV/m) = Raw Value(dBuV) + Correction Factor(dB/m)
2. Correction Factor(dB/m) = Antenna Factor(dB/m) + Cable Factor(dB) – Pre-Amplifier Factor(dB)
3. Margin value = Emission Level – Limit value
4. The other emission levels were very low against the limit.
5. " \* " : Fundamental frequency.
6. " # " : The radiated frequency is out of the restricted band.

<b>RF Mode</b>	TX 802.11ax (HE40)	<b>Channel</b>	CH 159 : 5.795 GHz
<b>Frequency Range</b>	1GHz ~ 40GHz	<b>Detector Function</b>	Peak (PK) Average (AV)
<b>Input Power</b>	120Vac, 60Hz	<b>Environmental Conditions</b>	25 °C, 66% RH
<b>Tested By</b>	Tom Yang		

**Antenna Polarity & Test Distance : Horizontal at 3 m**

No	Frequency (MHz)	Emission Level (dBuV/m)	Limit (dBuV/m)	Margin (dB)	Antenna Height (m)	Table Angle (Degree)	Raw Value (dBuV)	Correction Factor (dB/m)
1	#5648.42	61.8 PK	68.2	-6.4	1.01 H	28	60.0	1.8
2	*5795.00	118.6 PK			1.01 H	28	116.6	2.0
3	*5795.00	108.0 AV			1.01 H	28	106.0	2.0
4	#5925.26	62.9 PK	68.2	-5.3	1.01 H	28	60.7	2.2
5	11590.00	38.0 PK	74.0	-36.0	1.46 H	197	25.8	12.2
6	11590.00	27.0 AV	54.0	-27.0	1.46 H	197	14.8	12.2
7	#17385.00	33.2 PK	68.2	-35.0	1.57 H	144	15.4	17.8

**Antenna Polarity & Test Distance : Vertical at 3 m**

No	Frequency (MHz)	Emission Level (dBuV/m)	Limit (dBuV/m)	Margin (dB)	Antenna Height (m)	Table Angle (Degree)	Raw Value (dBuV)	Correction Factor (dB/m)
1	#5648.52	55.8 PK	68.2	-12.4	3.28 V	300	54.0	1.8
2	*5795.00	113.7 PK			3.28 V	300	111.7	2.0
3	*5795.00	102.5 AV			3.28 V	300	100.5	2.0
4	#5935.91	52.0 PK	68.2	-16.2	3.28 V	300	49.8	2.2
5	11590.00	38.4 PK	74.0	-35.6	1.30 V	265	26.2	12.2
6	11590.00	27.6 AV	54.0	-26.4	1.30 V	265	15.4	12.2
7	#17385.00	36.1 PK	68.2	-32.1	2.03 V	261	18.3	17.8

**Remarks:**

1. Emission Level(dBuV/m) = Raw Value(dBuV) + Correction Factor(dB/m)
2. Correction Factor(dB/m) = Antenna Factor(dB/m) + Cable Factor(dB) – Pre-Amplifier Factor(dB)
3. Margin value = Emission Level – Limit value
4. The other emission levels were very low against the limit.
5. " \* " : Fundamental frequency.
6. " # " : The radiated frequency is out of the restricted band.

<b>RF Mode</b>	TX 802.11ax (HE80)	<b>Channel</b>	CH 42 : 5.21 GHz
<b>Frequency Range</b>	1GHz ~ 40GHz	<b>Detector Function</b>	Peak (PK) Average (AV)
<b>Input Power</b>	120Vac, 60Hz	<b>Environmental Conditions</b>	25 °C, 66% RH
<b>Tested By</b>	Tom Yang		

**Antenna Polarity & Test Distance : Horizontal at 3 m**

No	Frequency (MHz)	Emission Level (dBuV/m)	Limit (dBuV/m)	Margin (dB)	Antenna Height (m)	Table Angle (Degree)	Raw Value (dBuV)	Correction Factor (dB/m)
1	5150.00	65.9 PK	74.0	-8.1	1.02 H	293	64.4	1.5
2	5150.00	53.8 AV	54.0	-0.2	1.02 H	293	52.3	1.5
3	*5210.00	110.1 PK			1.02 H	293	109.0	1.1
4	*5210.00	99.8 AV			1.02 H	293	98.7	1.1
5	5350.00	50.5 PK	74.0	-23.5	1.02 H	293	49.3	1.2
6	5350.00	39.5 AV	54.0	-14.5	1.02 H	293	38.3	1.2
7	#10420.00	37.7 PK	68.2	-30.5	1.52 H	201	26.6	11.1
8	15630.00	34.3 PK	74.0	-39.7	1.61 H	143	22.2	12.1
9	15630.00	24.2 AV	54.0	-29.8	1.61 H	143	12.1	12.1

**Antenna Polarity & Test Distance : Vertical at 3 m**

No	Frequency (MHz)	Emission Level (dBuV/m)	Limit (dBuV/m)	Margin (dB)	Antenna Height (m)	Table Angle (Degree)	Raw Value (dBuV)	Correction Factor (dB/m)
1	5150.00	54.3 PK	74.0	-19.7	3.29 V	286	52.8	1.5
2	5150.00	45.5 AV	54.0	-8.5	3.29 V	286	44.0	1.5
3	*5210.00	104.1 PK			3.29 V	286	103.0	1.1
4	*5210.00	92.9 AV			3.29 V	286	91.8	1.1
5	5350.00	48.7 PK	74.0	-25.3	3.29 V	286	47.5	1.2
6	5350.00	38.8 AV	54.0	-15.2	3.29 V	286	37.6	1.2
7	#10420.00	37.2 PK	68.2	-31.0	1.28 V	268	26.1	11.1
8	15630.00	35.5 PK	74.0	-38.5	2.01 V	239	23.4	12.1
9	15630.00	25.8 AV	54.0	-28.2	2.01 V	239	13.7	12.1

**Remarks:**

1. Emission Level(dBuV/m) = Raw Value(dBuV) + Correction Factor(dB/m)
2. Correction Factor(dB/m) = Antenna Factor(dB/m) + Cable Factor(dB) – Pre-Amplifier Factor(dB)
3. Margin value = Emission Level – Limit value
4. The other emission levels were very low against the limit.
5. " \* ": Fundamental frequency.
6. " # ": The radiated frequency is out of the restricted band.

<b>RF Mode</b>	TX 802.11ax (HE80)	<b>Channel</b>	CH 58 : 5.29 GHz
<b>Frequency Range</b>	1GHz ~ 40GHz	<b>Detector Function</b>	Peak (PK) Average (AV)
<b>Input Power</b>	120Vac, 60Hz	<b>Environmental Conditions</b>	25 °C, 66% RH
<b>Tested By</b>	Tom Yang		

**Antenna Polarity & Test Distance : Horizontal at 3 m**

No	Frequency (MHz)	Emission Level (dBuV/m)	Limit (dBuV/m)	Margin (dB)	Antenna Height (m)	Table Angle (Degree)	Raw Value (dBuV)	Correction Factor (dB/m)
1	5150.00	50.0 PK	74.0	-24.0	1.00 H	298	48.5	1.5
2	5150.00	39.5 AV	54.0	-14.5	1.00 H	298	38.0	1.5
3	*5290.00	108.3 PK			1.00 H	298	107.4	0.9
4	*5290.00	98.2 AV			1.00 H	298	97.3	0.9
5	5350.00	63.4 PK	74.0	-10.6	1.00 H	298	62.2	1.2
<b>6</b>	<b>5350.00</b>	<b>53.9 AV</b>	<b>54.0</b>	<b>-0.1</b>	<b>1.00 H</b>	<b>298</b>	<b>52.7</b>	<b>1.2</b>
7	#10580.00	37.5 PK	68.2	-30.7	1.44 H	183	26.7	10.8
8	15870.00	33.8 PK	74.0	-40.2	1.61 H	149	21.5	12.3
9	15870.00	24.1 AV	54.0	-29.9	1.61 H	149	11.8	12.3

**Antenna Polarity & Test Distance : Vertical at 3 m**

No	Frequency (MHz)	Emission Level (dBuV/m)	Limit (dBuV/m)	Margin (dB)	Antenna Height (m)	Table Angle (Degree)	Raw Value (dBuV)	Correction Factor (dB/m)
1	5150.00	50.0 PK	74.0	-24.0	3.31 V	295	48.5	1.5
2	5150.00	39.2 AV	54.0	-14.8	3.31 V	295	37.7	1.5
3	*5290.00	101.2 PK			3.31 V	295	100.3	0.9
4	*5290.00	91.2 AV			3.31 V	295	90.3	0.9
5	5350.00	55.4 PK	74.0	-18.6	3.31 V	295	54.2	1.2
6	5350.00	45.2 AV	54.0	-8.8	3.31 V	295	44.0	1.2
7	#10580.00	37.2 PK	68.2	-31.0	1.35 V	272	26.4	10.8
8	15870.00	36.1 PK	74.0	-37.9	2.06 V	247	23.8	12.3
9	15870.00	26.4 AV	54.0	-27.6	2.06 V	247	14.1	12.3

**Remarks:**

1. Emission Level(dBuV/m) = Raw Value(dBuV) + Correction Factor(dB/m)
2. Correction Factor(dB/m) = Antenna Factor(dB/m) + Cable Factor(dB) – Pre-Amplifier Factor(dB)
3. Margin value = Emission Level – Limit value
4. The other emission levels were very low against the limit.
5. " \* " : Fundamental frequency.
6. " # " : The radiated frequency is out of the restricted band.

<b>RF Mode</b>	TX 802.11ax (HE80)	<b>Channel</b>	CH 106 : 5.53 GHz
<b>Frequency Range</b>	1GHz ~ 40GHz	<b>Detector Function</b>	Peak (PK) Average (AV)
<b>Input Power</b>	120Vac, 60Hz	<b>Environmental Conditions</b>	25 °C, 66% RH
<b>Tested By</b>	Tom Yang		

**Antenna Polarity & Test Distance : Horizontal at 3 m**

No	Frequency (MHz)	Emission Level (dBuV/m)	Limit (dBuV/m)	Margin (dB)	Antenna Height (m)	Table Angle (Degree)	Raw Value (dBuV)	Correction Factor (dB/m)
1	5455.40	66.9 PK	74.0	-7.1	1.00 H	29	65.6	1.3
2	<b>5455.40</b>	<b>53.9 AV</b>	<b>54.0</b>	<b>-0.1</b>	<b>1.00 H</b>	<b>29</b>	<b>52.6</b>	<b>1.3</b>
3	#5465.70	68.0 PK	68.2	-0.2	1.00 H	29	66.7	1.3
4	*5530.00	109.2 PK			1.00 H	29	107.9	1.3
5	*5530.00	99.0 AV			1.00 H	29	97.7	1.3
6	#5759.75	53.3 PK	68.2	-14.9	1.00 H	29	51.2	2.1
7	11060.00	38.1 PK	74.0	-35.9	1.46 H	187	26.3	11.8
8	11060.00	27.2 AV	54.0	-26.8	1.46 H	187	15.4	11.8
9	#16590.00	33.4 PK	68.2	-34.8	1.60 H	133	18.6	14.8

**Antenna Polarity & Test Distance : Vertical at 3 m**

No	Frequency (MHz)	Emission Level (dBuV/m)	Limit (dBuV/m)	Margin (dB)	Antenna Height (m)	Table Angle (Degree)	Raw Value (dBuV)	Correction Factor (dB/m)
1	5460.00	54.4 PK	74.0	-19.6	3.25 V	272	53.1	1.3
2	5460.00	43.0 AV	54.0	-11.0	3.25 V	272	41.7	1.3
3	#5462.29	56.0 PK	68.2	-12.2	3.25 V	272	54.7	1.3
4	*5530.00	104.3 PK			3.25 V	272	103.0	1.3
5	*5530.00	93.1 AV			3.25 V	272	91.8	1.3
6	#5826.21	50.0 PK	68.2	-18.2	3.25 V	272	48.1	1.9
7	11060.00	38.0 PK	74.0	-36.0	1.32 V	273	26.2	11.8
8	11060.00	27.5 AV	54.0	-26.5	1.32 V	273	15.7	11.8
9	#16590.00	36.0 PK	68.2	-32.2	2.01 V	258	21.2	14.8

**Remarks:**

1. Emission Level(dBuV/m) = Raw Value(dBuV) + Correction Factor(dB/m)
2. Correction Factor(dB/m) = Antenna Factor(dB/m) + Cable Factor(dB) – Pre-Amplifier Factor(dB)
3. Margin value = Emission Level – Limit value
4. The other emission levels were very low against the limit.
5. " \* " : Fundamental frequency.
6. " # " : The radiated frequency is out of the restricted band.

<b>RF Mode</b>	TX 802.11ax (HE80)	<b>Channel</b>	CH 122 : 5.61 GHz
<b>Frequency Range</b>	1GHz ~ 40GHz	<b>Detector Function</b>	Peak (PK) Average (AV)
<b>Input Power</b>	120Vac, 60Hz	<b>Environmental Conditions</b>	25 °C, 66% RH
<b>Tested By</b>	Tom Yang		

**Antenna Polarity & Test Distance : Horizontal at 3 m**

No	Frequency (MHz)	Emission Level (dBuV/m)	Limit (dBuV/m)	Margin (dB)	Antenna Height (m)	Table Angle (Degree)	Raw Value (dBuV)	Correction Factor (dB/m)
1	5460.00	64.4 PK	74.0	-9.6	1.01 H	33	63.1	1.3
2	5460.00	53.8 AV	54.0	-0.2	1.01 H	33	52.5	1.3
3	#5470.00	67.7 PK	68.2	-0.5	1.01 H	33	66.4	1.3
4	*5610.00	112.1 PK			1.01 H	33	110.6	1.5
5	*5610.00	100.9 AV			1.01 H	33	99.4	1.5
6	#5725.00	67.7 PK	68.2	-0.5	1.01 H	33	65.8	1.9
7	11220.00	38.1 PK	74.0	-35.9	1.43 H	193	26.2	11.9
8	11220.00	27.6 AV	54.0	-26.4	1.43 H	193	15.7	11.9
9	#16830.00	34.0 PK	68.2	-34.2	1.62 H	131	17.9	16.1

**Antenna Polarity & Test Distance : Vertical at 3 m**

No	Frequency (MHz)	Emission Level (dBuV/m)	Limit (dBuV/m)	Margin (dB)	Antenna Height (m)	Table Angle (Degree)	Raw Value (dBuV)	Correction Factor (dB/m)
1	*5610.00	109.1 PK			3.60 V	282	107.6	1.5
2	*5610.00	98.6 AV			3.60 V	282	97.1	1.5
3	#5725.00	49.5 PK	68.2	-18.7	3.60 V	282	47.6	1.9
4	11220.00	37.1 PK	74.0	-36.9	1.32 V	262	25.2	11.9
5	11220.00	26.8 AV	54.0	-27.2	1.32 V	262	14.9	11.9
6	#16830.00	35.6 PK	68.2	-32.6	2.09 V	250	19.5	16.1

**Remarks:**

1. Emission Level(dBuV/m) = Raw Value(dBuV) + Correction Factor(dB/m)
2. Correction Factor(dB/m) = Antenna Factor(dB/m) + Cable Factor(dB) – Pre-Amplifier Factor(dB)
3. Margin value = Emission Level – Limit value
4. The other emission levels were very low against the limit.
5. " \* " : Fundamental frequency.
6. " # " : The radiated frequency is out of the restricted band.



<b>RF Mode</b>	TX 802.11ax (HE80)	<b>Channel</b>	CH 138 : 5.69 GHz
<b>Frequency Range</b>	1GHz ~ 40GHz	<b>Detector Function</b>	Peak (PK) Average (AV)
<b>Input Power</b>	120Vac, 60Hz	<b>Environmental Conditions</b>	25 °C, 66% RH
<b>Tested By</b>	Tom Yang		

**Antenna Polarity & Test Distance : Horizontal at 3 m**

No	Frequency (MHz)	Emission Level (dBuV/m)	Limit (dBuV/m)	Margin (dB)	Antenna Height (m)	Table Angle (Degree)	Raw Value (dBuV)	Correction Factor (dB/m)
1	5460.00	58.8 PK	74.0	-15.2	1.02 H	31	57.5	1.3
2	5460.00	48.1 AV	54.0	-5.9	1.02 H	31	46.8	1.3
3	#5470.00	62.2 PK	68.2	-6.0	1.02 H	31	60.9	1.3
4	*5690.00	113.8 PK			1.02 H	31	112.1	1.7
5	*5690.00	103.4 AV			1.02 H	31	101.7	1.7
6	#5850.00	64.6 PK	68.2	-3.6	1.02 H	31	62.7	1.9
7	11380.00	37.4 PK	74.0	-36.6	1.49 H	208	25.0	12.4
8	11380.00	26.8 AV	54.0	-27.2	1.49 H	208	14.4	12.4
9	#17070.00	34.1 PK	68.2	-34.1	1.59 H	150	17.5	16.6

**Antenna Polarity & Test Distance : Vertical at 3 m**

No	Frequency (MHz)	Emission Level (dBuV/m)	Limit (dBuV/m)	Margin (dB)	Antenna Height (m)	Table Angle (Degree)	Raw Value (dBuV)	Correction Factor (dB/m)
1	5460.00	49.6 PK	74.0	-24.4	3.59 V	289	48.3	1.3
2	5460.00	39.0 AV	54.0	-15.0	3.59 V	289	37.7	1.3
3	#5470.00	48.7 PK	68.2	-19.5	3.59 V	289	47.4	1.3
4	*5690.00	109.5 PK			3.59 V	289	107.8	1.7
5	*5690.00	99.0 AV			3.59 V	289	97.3	1.7
6	#5850.00	48.8 PK	68.2	-19.4	3.59 V	289	46.9	1.9
7	11380.00	37.8 PK	74.0	-36.2	1.31 V	284	25.4	12.4
8	11380.00	27.5 AV	54.0	-26.5	1.31 V	284	15.1	12.4
9	#17070.00	35.4 PK	68.2	-32.8	2.07 V	259	18.8	16.6

**Remarks:**

1. Emission Level(dBuV/m) = Raw Value(dBuV) + Correction Factor(dB/m)
2. Correction Factor(dB/m) = Antenna Factor(dB/m) + Cable Factor(dB) – Pre-Amplifier Factor(dB)
3. Margin value = Emission Level – Limit value
4. The other emission levels were very low against the limit.
5. " \* " : Fundamental frequency.
6. " # " : The radiated frequency is out of the restricted band.

<b>RF Mode</b>	TX 802.11ax (HE80)	<b>Channel</b>	CH 155 : 5.775 GHz
<b>Frequency Range</b>	1GHz ~ 40GHz	<b>Detector Function</b>	Peak (PK) Average (AV)
<b>Input Power</b>	120Vac, 60Hz	<b>Environmental Conditions</b>	25 °C, 66% RH
<b>Tested By</b>	Tom Yang		

**Antenna Polarity & Test Distance : Horizontal at 3 m**

No	Frequency (MHz)	Emission Level (dBuV/m)	Limit (dBuV/m)	Margin (dB)	Antenna Height (m)	Table Angle (Degree)	Raw Value (dBuV)	Correction Factor (dB/m)
1	#5644.93	67.7 PK	68.2	-0.5	1.00 H	28	65.9	1.8
2	*5775.00	112.9 PK			1.00 H	28	110.8	2.1
3	*5775.00	102.6 AV			1.00 H	28	100.5	2.1
4	#5926.62	60.7 PK	68.2	-7.5	1.00 H	28	58.5	2.2
5	11550.00	38.2 PK	74.0	-35.8	1.48 H	202	26.0	12.2
6	11550.00	27.5 AV	54.0	-26.5	1.48 H	202	15.3	12.2
7	#17325.00	34.1 PK	68.2	-34.1	1.59 H	122	16.9	17.2

**Antenna Polarity & Test Distance : Vertical at 3 m**

No	Frequency (MHz)	Emission Level (dBuV/m)	Limit (dBuV/m)	Margin (dB)	Antenna Height (m)	Table Angle (Degree)	Raw Value (dBuV)	Correction Factor (dB/m)
1	#5649.18	63.2 PK	68.2	-5.0	3.26 V	289	61.4	1.8
2	*5775.00	108.4 PK			3.26 V	289	106.3	2.1
3	*5775.00	98.1 AV			3.26 V	289	96.0	2.1
4	#5928.66	55.3 PK	68.2	-12.9	3.26 V	289	53.1	2.2
5	11550.00	37.5 PK	74.0	-36.5	1.25 V	279	25.3	12.2
6	11550.00	26.8 AV	54.0	-27.2	1.25 V	279	14.6	12.2
7	#17325.00	35.6 PK	68.2	-32.6	2.08 V	261	18.4	17.2

**Remarks:**

1. Emission Level(dBuV/m) = Raw Value(dBuV) + Correction Factor(dB/m)
2. Correction Factor(dB/m) = Antenna Factor(dB/m) + Cable Factor(dB) – Pre-Amplifier Factor(dB)
3. Margin value = Emission Level – Limit value
4. The other emission levels were very low against the limit.
5. " \* " : Fundamental frequency.
6. " # " : The radiated frequency is out of the restricted band.

### Below 1GHz Data:

<b>RF Mode</b>	TX 802.11ax (HE40)	<b>Channel</b>	CH 159 : 5.795 GHz
<b>Frequency Range</b>	9kHz ~ 1GHz	<b>Detector Function</b>	Quasi-Peak (QP)
<b>Input Power</b>	120Vac, 60Hz	<b>Environmental Conditions</b>	25 °C, 66% RH
<b>Tested By</b>	Tom Yang		

### Antenna Polarity & Test Distance : Horizontal at 3 m

No	Frequency (MHz)	Emission Level (dBuV/m)	Limit (dBuV/m)	Margin (dB)	Antenna Height (m)	Table Angle (Degree)	Raw Value (dBuV)	Correction Factor (dB/m)
1	31.41	27.7 QP	40.0	-12.3	1.00 H	79	41.4	-13.7
2	87.69	31.3 QP	40.0	-8.7	2.00 H	286	49.7	-18.4
3	152.22	37.6 QP	43.5	-5.9	1.50 H	324	49.6	-12.0
4	205.91	28.2 QP	43.5	-15.3	1.00 H	186	43.3	-15.1
5	334.97	35.5 QP	46.0	-10.5	1.00 H	140	45.2	-9.7
6	715.56	26.2 QP	46.0	-19.8	1.00 H	292	26.5	-0.3

#### Remarks:

1. Emission Level(dBuV/m) = Raw Value(dBuV) + Correction Factor(dB/m)
2. Correction Factor(dB/m) = Antenna Factor(dB/m) + Cable Factor(dB) – Pre-Amplifier Factor(dB)
3. Margin value = Emission Level – Limit value
4. The other emission levels were very low against the limit of frequency range 30MHz~1000MHz.
5. The emission levels were very low against the limit of frequency range 9kHz~30MHz: the amplitude of spurious emissions attenuated more than 20 dB below the permissible value to be report.

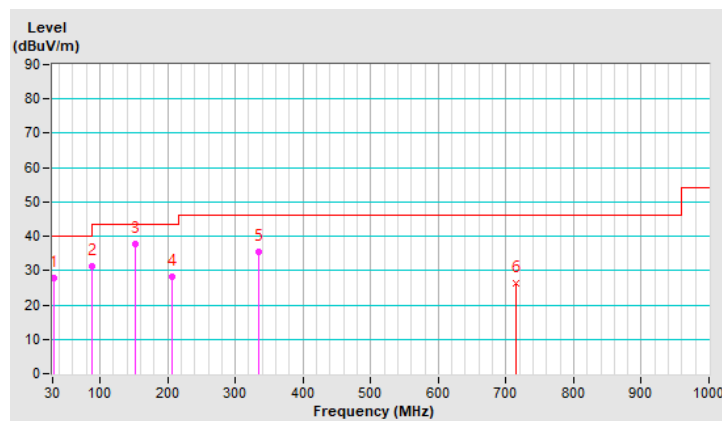

<b>RF Mode</b>	TX 802.11ax (HE40)	<b>Channel</b>	CH 159 : 5.795 GHz
<b>Frequency Range</b>	9kHz ~ 1GHz	<b>Detector Function</b>	Quasi-Peak (QP)
<b>Input Power</b>	120Vac, 60Hz	<b>Environmental Conditions</b>	25 °C, 66% RH
<b>Tested By</b>	Tom Yang		

Antenna Polarity & Test Distance : Vertical at 3 m								
No	Frequency (MHz)	Emission Level (dBuV/m)	Limit (dBuV/m)	Margin (dB)	Antenna Height (m)	Table Angle (Degree)	Raw Value (dBuV)	Correction Factor (dB/m)
1	30.17	33.3 QP	40.0	-6.7	1.00 V	81	46.8	-13.5
2	84.27	33.0 QP	40.0	-7.0	2.00 V	110	51.1	-18.1
3	155.47	37.0 QP	43.5	-6.5	1.00 V	275	48.9	-11.9
4	205.98	27.9 QP	43.5	-15.6	1.00 V	311	43.0	-15.1
5	337.34	28.8 QP	46.0	-17.2	1.50 V	252	38.5	-9.7
6	509.67	29.2 QP	46.0	-16.8	1.50 V	183	33.8	-4.6

**Remarks:**

1. Emission Level(dBuV/m) = Raw Value(dBuV) + Correction Factor(dB/m)
2. Correction Factor(dB/m) = Antenna Factor(dB/m) + Cable Factor(dB) – Pre-Amplifier Factor(dB)
3. Margin value = Emission Level – Limit value
4. The other emission levels were very low against the limit of frequency range 30MHz~1000MHz.
5. The emission levels were very low against the limit of frequency range 9kHz~30MHz: the amplitude of spurious emissions attenuated more than 20 dB below the permissible value to be report.

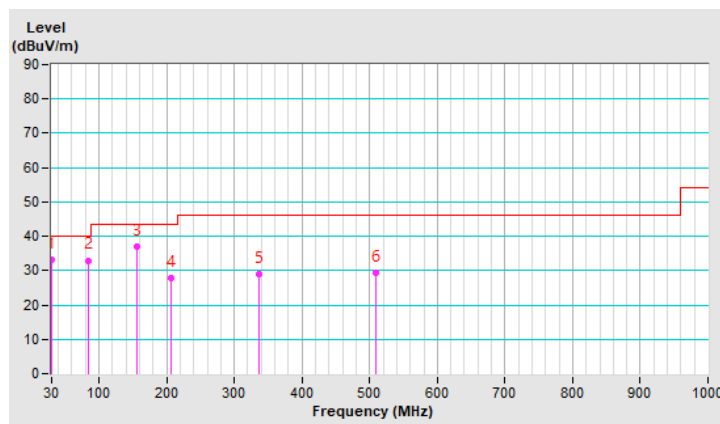

## 4.2 Conducted Emission Measurement

### 4.2.1 Limits of Conducted Emission Measurement

Frequency (MHz)	Conducted Limit (dBuV)	
	Quasi-peak	Average
0.15 - 0.5	66 - 56	56 - 46
0.50 - 5.0	56	46
5.0 - 30.0	60	50

Note: 1. The lower limit shall apply at the transition frequencies.

2. The limit decreases in line with the logarithm of the frequency in the range of 0.15 to 0.50MHz.

### 4.2.2 Test Instruments

DESCRIPTION & MANUFACTURER	MODEL NO.	SERIAL NO.	CALIBRATED DATE	CALIBRATED UNTIL
Test Receiver R&S	ESCS 30	847124/029	2021/10/13	2022/10/12
LISN R&S	ESH3-Z5	848773/004	2021/10/29	2022/10/28
LISN R & S	ESH3-Z5	835239/001	2021/3/26	2022/3/25
50 ohms Terminator	50	3	2021/10/27	2022/10/26
RF Coaxial Cable JYEBO	5D-FB	COCCAB-001	2021/9/25	2022/9/24
Fixed attenuator STI	STI02-2200-10	005	2021/8/27	2022/8/26
Software BVADT	BVADT_Cond_V7.3.7.4	NA	NA	NA

**Note:**

1. The calibration interval of the above test instruments are 12 months and the calibrations are traceable to NML/ROC and NIST/USA.
2. The test was performed in Conduction 1.
- 3 Tested Date: 2021/10/29

#### 4.2.3 Test Procedure

- The EUT was placed 0.4 meters from the conducting wall of the shielded room with EUT being connected to the power mains through a line impedance stabilization network (LISN). Other support units were connected to the power mains through another LISN. The two LISNs provide 50 ohm/ 50uH of coupling impedance for the measuring instrument.
- Both lines of the power mains connected to the EUT were checked for maximum conducted interference.
- The frequency range from 150kHz to 30MHz was searched. Emission levels under (Limit - 20dB) was not recorded.

**Note:** All modes of operation were investigated and the worst-case emissions are reported.

#### 4.2.4 Deviation from Test Standard

No deviation.

#### 4.2.5 Test Setup

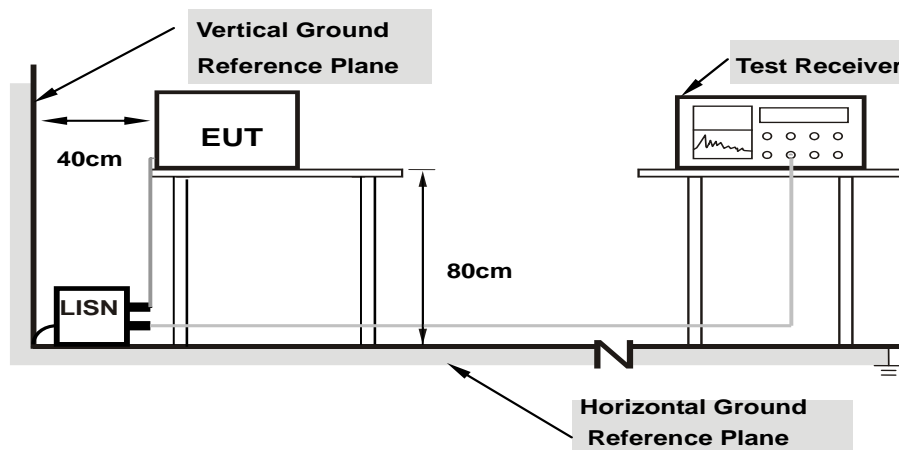

**Note: 1.Support units were connected to second LISN.**

For the actual test configuration, please refer to the attached file (Test Setup Photo).

#### 4.2.6 EUT Operating Condition

Same as 4.1.6.

#### 4.2.7 Test Results

<b>RF Mode</b>	TX 802.11ax (HE40)	<b>Channel</b>	CH 159 : 5.795 GHz
<b>Frequency Range</b>	150kHz ~ 30MHz	<b>Detector Function &amp; Resolution Bandwidth</b>	Quasi-Peak (QP) / Average (AV), 9kHz
<b>Input Power</b>	120Vac, 60Hz	<b>Environmental Conditions</b>	25 °C, 66% RH
<b>Tested By</b>	Tom Yang		

Phase Of Power : Line (L)										
No	Frequency (MHz)	Correction Factor (dB)	Reading Value (dBuV)		Emission Level (dBuV)		Limit (dBuV)		Margin (dB)	
			Q.P.	AV.	Q.P.	AV.	Q.P.	AV.	Q.P.	AV.
1	0.15781	10.07	29.78	19.06	39.85	29.13	65.58	55.58	-25.73	-26.45
2	0.56406	10.12	27.79	20.55	37.91	30.67	56.00	46.00	-18.09	-15.33
3	0.92734	10.14	20.79	11.76	30.93	21.90	56.00	46.00	-25.07	-24.10
4	3.54297	10.32	34.43	19.29	44.75	29.61	56.00	46.00	-11.25	-16.39
5	5.30469	10.44	26.89	12.48	37.33	22.92	60.00	50.00	-22.67	-27.08
6	26.94141	11.74	15.82	6.96	27.56	18.70	60.00	50.00	-32.44	-31.30

**Remarks:**

1. Q.P. and AV. are abbreviations of quasi-peak and average individually.
2. The emission levels of other frequencies were very low against the limit.
3. Margin value = Emission level – Limit value
4. Correction factor = Insertion loss + Cable loss
5. Emission Level = Correction Factor + Reading Value

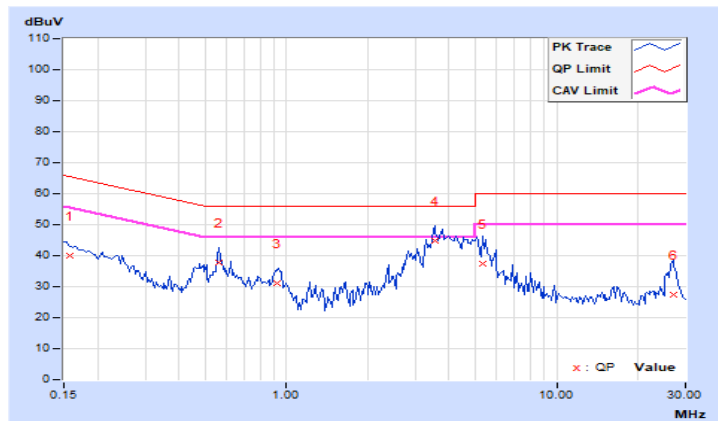

RF Mode	TX 802.11ax (HE40)	Channel	CH 159 : 5.795 GHz
Frequency Range	150kHz ~ 30MHz	Detector Function & Resolution Bandwidth	Quasi-Peak (QP) / Average (AV), 9kHz
Input Power	120Vac, 60Hz	Environmental Conditions	25 °C, 66% RH
Tested By	Tom Yang		

Phase Of Power : Neutral (N)										
No	Frequency (MHz)	Correction Factor (dB)	Reading Value (dBuV)		Emission Level (dBuV)		Limit (dBuV)		Margin (dB)	
			Q.P.	AV.	Q.P.	AV.	Q.P.	AV.	Q.P.	AV.
1	0.15781	10.05	29.39	20.71	39.44	30.76	65.58	55.58	-26.14	-24.82
2	0.56406	10.11	33.52	26.71	43.63	36.82	56.00	46.00	-12.37	-9.18
3	0.91953	10.13	26.37	17.57	36.50	27.70	56.00	46.00	-19.50	-18.30
4	3.51953	10.30	38.51	22.54	48.81	32.84	56.00	46.00	-7.19	-13.16
<b>5</b>	<b>4.56641</b>	<b>10.36</b>	<b>37.20</b>	<b>29.13</b>	<b>47.56</b>	<b>39.49</b>	<b>56.00</b>	<b>46.00</b>	<b>-8.44</b>	<b>-6.51</b>
6	26.80469	11.36	26.50	22.20	37.86	33.56	60.00	50.00	-22.14	-16.44

**Remarks:**

1. Q.P. and AV. are abbreviations of quasi-peak and average individually.
2. The emission levels of other frequencies were very low against the limit.
3. Margin value = Emission level – Limit value
4. Correction factor = Insertion loss + Cable loss
5. Emission Level = Correction Factor + Reading Value

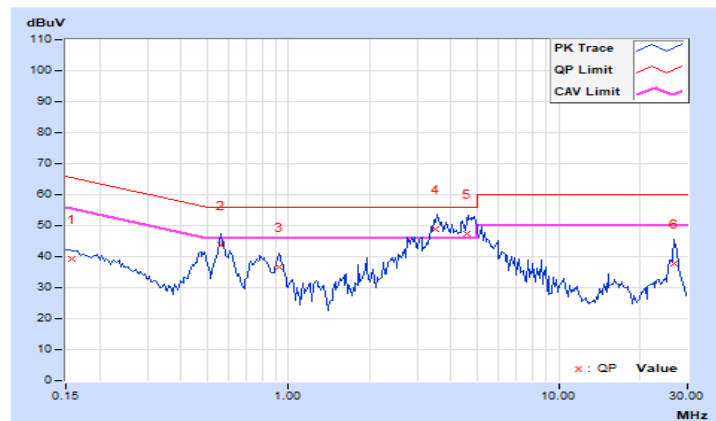



### 4.3 Transmit Power Measurement

#### 4.3.1 Limits of Transmit Power Measurement

Operation Band	EUT Category		Limit
U-NII-1		Outdoor Access Point	1 Watt (30 dBm) (Max. e.i.r.p $\leq$ 125mW(21 dBm) at any elevation angle above 30 degrees as measured from the horizon)
		Fixed point-to-point Access Point	1 Watt (30 dBm)
		Indoor Access Point	1 Watt (30 dBm)
	√	Client device	250mW (24 dBm)
U-NII-2A		√	250mW (24 dBm) or 11 dBm+10 log B*
U-NII-2C		√	250mW (24dBm) or 11 dBm+10 log B*
U-NII-3		√	1 Watt (30 dBm)

\*B is the 26 dB emission bandwidth in megahertz

Per KDB 662911 Method of conducted output power measurement on IEEE 802.11 devices,

Array Gain = 0 dB (i.e., no array gain) for  $N_{ANT} \leq 4$ ;

Array Gain = 0 dB (i.e., no array gain) for channel widths  $\geq 40$  MHz for any  $N_{ANT}$ ;

Array Gain =  $5 \log(N_{ANT}/N_{SS})$  dB or 3 dB, whichever is less for 20-MHz channel widths with  $N_{ANT} \geq 5$ .

For power measurements on all other devices: Array Gain =  $10 \log(N_{ANT}/N_{SS})$  dB.

#### 4.3.2 Test Setup

##### FOR POWER OUTPUT MEASUREMENT

For channel straddling 5725MHz:

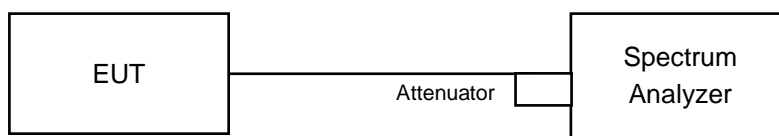

For other channels:

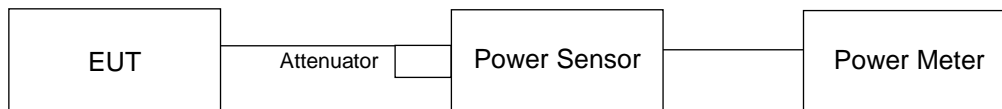

##### FOR 26dB OCCUPIED BANDWIDTH

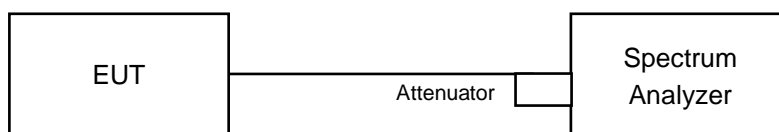

#### 4.3.3 Test Instruments

Refer to section 4.1.2 to get information of above instrument.

#### 4.3.4 Test Procedure

##### **FOR POWER OUTPUT MEASUREMENT**

##### **For channel straddling 5725MHz:**

Follow FCC KDB 789033 UNII test procedure:

##### Method SA-1

1. Set span to encompass the entire emission bandwidth (EBW) of the signal.
2. Set RBW = 1MHz.
3. Set the VBW  $\geq 3 \times$  RBW.
4. Number of points in sweep  $\geq 2$  Span / RBW.
5. Sweep time = auto.
6. Set trigger to free run (duty cycle  $\geq 98$  percent)
7. Detector = RMS.
8. Trace average at least 100 traces in power averaging mode
9. Compute power by integrating the spectrum across the 26 dB EBW of the signal.

##### **For other channels:**

Method PM is used to perform output power measurement, trigger and gating function of wide band power meter is enabled to measure max output power of TX on burst. Duty factor is not added to measured value.

##### **FOR 26dB OCCUPIED BANDWIDTH**

1. Set RBW = approximately 1% of the emission bandwidth.
2. Set the VBW  $>$  RBW.
3. Detector = Peak.
4. Trace mode = max hold.
5. Measure the maximum width of the emission that is 26 dB down from the peak of the emission. Compare this with the RBW setting of the analyzer. Readjust RBW and repeat measurement as needed until the RBW/EBW ratio is approximately 1%.

#### 4.3.5 Deviation from Test Standard

No deviation.

#### 4.3.6 EUT Operating Condition

The software provided by client to enable the EUT under transmission condition continuously at lowest, middle and highest channel frequencies individually.

## 4.3.7 Test Results

**POWER OUTPUT**
**CDD Mode**
**802.11a**

Chan.	Chan. Freq. (MHz)	Average Power (dBm)		Total Power (mW)	Total Power (dBm)	Limit (dBm)	Pass / Fail
		Chain 0	Chain 1				
36	5180	19.59	19.54	180.941	22.58	24	Pass
40	5200	19.88	20.02	197.736	22.96	24	Pass
48	5240	19.73	19.63	185.806	22.69	24	Pass
52	5260	19.95	19.80	194.355	22.89	24	Pass
60	5300	19.68	19.90	190.62	22.80	24	Pass
64	5320	19.85	19.55	186.762	22.71	24	Pass
100	5500	20.05	19.83	197.319	22.95	24	Pass
116	5580	19.97	19.65	191.569	22.82	24	Pass
140	5700	19.20	19.00	162.609	22.11	24	Pass
*144 (U-NII-2C Band)	5720	19.25	20.04	185.065	22.67	22.97	Pass
*144 (U-NII-3 Band)	5720	12.72	13.37	40.434	16.07	30	Pass
149	5745	23.26	22.80	402.382	26.05	30	Pass
157	5785	22.85	22.20	358.711	25.55	30	Pass
165	5825	23.35	22.95	413.514	26.16	30	Pass

Note: \* Test was performed in accordance with Measurement follow FCC KDB 789033 UNII test procedure Method SA-1 and use spectrum analyzer test.

1. For U-NII-1: The maximum gain is 4.03 dBi < 6dBi, so the output power limit shall not be reduced.
2. For U-NII-2A: The maximum gain is 4.03 dBi < 6dBi, so the output power limit shall not be reduced.
3. For U-NII-2C: The maximum gain is 4.03 dBi < 6dBi, so the output power limit shall not be reduced.
4. For U-NII-3: The maximum gain is 4.03 dBi < 6dBi, so the output power limit shall not be reduced.

**Note: For U-NII-2A, U-NII-2C Band output power limitation is determined based on 26dBc bandwidth**

Power Limit = 11dBm + 10logB < U-NII-2A, U-NII-2C >			
Channel Number	Freq.(MHz)	Min. B(MHz)	Determined Conducted Limit (dBm)
52	5260	21.26	24.27 > 24
60	5300	20.85	24.19 > 24
64	5320	20.48	24.11 > 24
100	5500	20.77	24.17 > 24
116	5580	20.62	24.14 > 24
140	5700	20.51	24.11 > 24
144 (U-NII-2C Band)	5720	15.74	22.97 < 24

**802.11ac (VHT20)**

Chan.	Chan. Freq. (MHz)	Average Power (dBm)		Total Power (mW)	Total Power (dBm)	Limit (dBm)	Pass / Fail
		Chain 0	Chain 1				
36	5180	18.50	18.75	145.784	21.64	24	Pass
40	5200	19.97	19.99	199.082	22.99	24	Pass
48	5240	19.92	20.02	198.636	22.98	24	Pass
52	5260	19.74	19.67	186.872	22.72	24	Pass
60	5300	19.76	19.83	190.785	22.81	24	Pass
64	5320	18.77	18.70	149.467	21.75	24	Pass
100	5500	19.56	19.14	172.4	22.37	24	Pass
116	5580	20.01	19.69	193.341	22.86	24	Pass
140	5700	18.91	18.74	152.621	21.84	24	Pass
*144 (U-NII-2C Band)	5720	19.49	19.42	176.418	22.47	22.96	Pass
*144 (U-NII-3 Band)	5720	13.48	13.65	45.458	16.58	30	Pass
149	5745	23.00	22.59	381.078	25.81	30	Pass
157	5785	22.64	21.92	339.25	25.31	30	Pass
165	5825	23.10	22.77	393.408	25.95	30	Pass

Note: \* Test was performed in accordance with Measurement follow FCC KDB 789033 UNII test procedure Method SA-1 and use spectrum analyzer test.

1. For U-NII-1: The maximum gain is 4.03 dBi < 6dBi, so the output power limit shall not be reduced.
2. For U-NII-2A: The maximum gain is 4.03 dBi < 6dBi, so the output power limit shall not be reduced.
3. For U-NII-2C: The maximum gain is 4.03 dBi < 6dBi, so the output power limit shall not be reduced.
4. For U-NII-3: The maximum gain is 4.03 dBi < 6dBi, so the output power limit shall not be reduced.

**Note: For U-NII-2A, U-NII-2C Band output power limitation is determined based on 26dBc bandwidth**

Power Limit = 11dBm + 10logB < U-NII-2A, U-NII-2C >			
Channel Number	Freq.(MHz)	Min. B(MHz)	Determined Conducted Limit (dBm)
52	5260	22.7	24.56 > 24
60	5300	23.46	24.7 > 24
64	5320	21.5	24.32 > 24
100	5500	21.57	24.33 > 24
116	5580	21.51	24.32 > 24
140	5700	21.05	24.23 > 24
144 (U-NII-2C Band)	5720	15.72	22.96 < 24

**802.11ac (VHT40)**

Chan.	Chan. Freq. (MHz)	Average Power (dBm)		Total Power (mW)	Total Power (dBm)	Limit (dBm)	Pass / Fail
		Chain 0	Chain 1				
38	5190	16.98	16.95	99.433	19.98	24	Pass
46	5230	20.20	20.14	207.989	23.18	24	Pass
54	5270	20.08	19.63	193.692	22.87	24	Pass
62	5310	16.75	16.88	96.068	19.83	24	Pass
102	5510	17.48	17.34	110.176	20.42	24	Pass
110	5550	19.79	19.70	188.605	22.76	24	Pass
134	5670	19.37	19.51	175.827	22.45	24	Pass
*142 (U-NII-2C Band)	5710	19.02	19.25	163.939	22.15	24	Pass
*142 (U-NII-3 Band)	5710	8.27	8.18	13.291	11.24	30	Pass
151	5755	21.59	21.55	287.101	24.58	30	Pass
159	5795	23.38	22.93	414.107	26.17	30	Pass

Note: \* Test was performed in accordance with Measurement follow FCC KDB 789033 UNII test procedure Method SA-1 and use spectrum analyzer test.

1. For U-NII-1: The maximum gain is 4.03 dBi < 6dBi, so the output power limit shall not be reduced.
2. For U-NII-2A: The maximum gain is 4.03 dBi < 6dBi, so the output power limit shall not be reduced.
3. For U-NII-2C: The maximum gain is 4.03 dBi < 6dBi, so the output power limit shall not be reduced.
4. For U-NII-3: The maximum gain is 4.03 dBi < 6dBi, so the output power limit shall not be reduced.

**Note: For U-NII-2A, U-NII-2C Band output power limitation is determined based on 26dBc bandwidth**

Power Limit = 11dBm + 10logB < U-NII-2A, U-NII-2C >			
Channel Number	Freq.(MHz)	Min. B(MHz)	Determined Conducted Limit (dBm)
54	5270	47.57	27.77 > 24
62	5310	41.81	27.21 > 24
102	5510	41.59	27.18 > 24
110	5550	41.83	27.21 > 24
134	5670	41.89	27.22 > 24
142 (U-NII-2C Band)	5710	35.95	26.55 > 24

**802.11ac (VHT80)**

Chan.	Chan. Freq. (MHz)	Average Power (dBm)		Total Power (mW)	Total Power (dBm)	Limit (dBm)	Pass / Fail
		Chain 0	Chain 1				
42	5210	16.40	16.45	87.809	19.44	24	Pass
58	5290	15.60	15.37	70.743	18.50	24	Pass
106	5530	16.97	16.73	96.871	19.86	24	Pass
122	5610	19.99	19.72	193.526	22.87	24	Pass
*138 (U-NII-2C Band)	5690	19.44	19.73	181.875	22.60	24	Pass
*138 (U-NII-3 Band)	5690	5.13	5.40	6.726	8.28	30	Pass
155	5775	20.72	20.39	227.428	23.57	30	Pass

Note: \* Test was performed in accordance with Measurement follow FCC KDB 789033 UNII test procedure Method SA-1 and use spectrum analyzer test.

1. For U-NII-1: The maximum gain is 4.03 dBi < 6dBi, so the output power limit shall not be reduced.
2. For U-NII-2A: The maximum gain is 4.03 dBi < 6dBi, so the output power limit shall not be reduced.
3. For U-NII-2C: The maximum gain is 4.03 dBi < 6dBi, so the output power limit shall not be reduced.
4. For U-NII-3: The maximum gain is 4.03 dBi < 6dBi, so the output power limit shall not be reduced.

**Note: For U-NII-2A, U-NII-2C Band output power limitation is determined based on 26dBc bandwidth**

Power Limit = 11dBm + 10logB < U-NII-2A, U-NII-2C >			
Channel Number	Freq.(MHz)	Min. B(MHz)	Determined Conducted Limit (dBm)
58	5290	83.23	30.2 > 24
106	5530	83.16	30.19 > 24
122	5610	83.37	30.21 > 24
138 (U-NII-2C Band)	5690	76.61	29.84 > 24



**802.11ax (HE20)**

Chan.	Chan. Freq. (MHz)	Average Power (dBm)		Total Power (mW)	Total Power (dBm)	Limit (dBm)	Pass / Fail
		Chain 0	Chain 1				
36	5180	18.55	18.81	147.647	21.69	24	Pass
40	5200	20.32	20.22	212.843	23.28	24	Pass
48	5240	20.22	20.30	212.348	23.27	24	Pass
52	5260	19.80	19.73	189.472	22.78	24	Pass
60	5300	19.90	19.91	195.673	22.92	24	Pass
64	5320	18.84	18.77	151.895	21.82	24	Pass
100	5500	19.62	19.20	174.798	22.43	24	Pass
116	5580	20.06	19.75	195.797	22.92	24	Pass
140	5700	18.97	18.80	154.744	21.90	24	Pass
*144 (U-NII-2C Band)	5720	19.92	19.75	192.581	22.85	22.96	Pass
*144 (U-NII-3 Band)	5720	13.93	14.03	50.01	16.99	30	Pass
149	5745	23.06	22.65	386.379	25.87	30	Pass
157	5785	22.70	22.00	344.698	25.37	30	Pass
165	5825	23.17	22.83	399.358	26.01	30	Pass

Note: \* Test was performed in accordance with Measurement follow FCC KDB 789033 UNII test procedure Method SA-1 and use spectrum analyzer test.

1. For U-NII-1: The maximum gain is 4.03 dBi < 6dBi, so the output power limit shall not be reduced.
2. For U-NII-2A: The maximum gain is 4.03 dBi < 6dBi, so the output power limit shall not be reduced.
3. For U-NII-2C: The maximum gain is 4.03 dBi < 6dBi, so the output power limit shall not be reduced.
4. For U-NII-3: The maximum gain is 4.03 dBi < 6dBi, so the output power limit shall not be reduced.

**Note: For U-NII-2A, U-NII-2C Band output power limitation is determined based on 26dBc bandwidth**

Power Limit = 11dBm + 10logB < U-NII-2A, U-NII-2C >			
Channel Number	Freq.(MHz)	Min. B(MHz)	Determined Conducted Limit (dBm)
52	5260	22.7	24.56 > 24
60	5300	23.46	24.7 > 24
64	5320	21.5	24.32 > 24
100	5500	21.57	24.33 > 24
116	5580	21.51	24.32 > 24
140	5700	21.05	24.23 > 24
144 (U-NII-2C Band)	5720	15.72	22.96 < 24

**802.11ax (HE40)**

Chan.	Chan. Freq. (MHz)	Average Power (dBm)		Total Power (mW)	Total Power (dBm)	Limit (dBm)	Pass / Fail
		Chain 0	Chain 1				
38	5190	16.95	17.00	99.664	19.99	24	Pass
46	5230	20.28	20.22	211.856	23.26	24	Pass
54	5270	20.15	19.71	197.055	22.95	24	Pass
62	5310	16.83	16.95	97.74	19.90	24	Pass
102	5510	17.55	17.40	111.839	20.49	24	Pass
110	5550	19.85	19.75	191.011	22.81	24	Pass
134	5670	19.42	19.58	178.28	22.51	24	Pass
*142 (U-NII-2C Band)	5710	19.47	19.27	173.039	22.38	24	Pass
*142 (U-NII-3 Band)	5710	8.76	8.64	14.828	11.71	30	Pass
151	5755	21.65	21.60	290.762	24.64	30	Pass
159	5795	23.43	23.00	419.819	26.23	30	Pass

Note: \* Test was performed in accordance with Measurement follow FCC KDB 789033 UNII test procedure Method SA-1 and use spectrum analyzer test.

1. For U-NII-1: The maximum gain is 4.03 dBi < 6dBi, so the output power limit shall not be reduced.
2. For U-NII-2A: The maximum gain is 4.03 dBi < 6dBi, so the output power limit shall not be reduced.
3. For U-NII-2C: The maximum gain is 4.03 dBi < 6dBi, so the output power limit shall not be reduced.
4. For U-NII-3: The maximum gain is 4.03 dBi < 6dBi, so the output power limit shall not be reduced.

**Note: For U-NII-2A, U-NII-2C Band output power limitation is determined based on 26dBc bandwidth**

Power Limit = 11dBm + 10logB < U-NII-2A, U-NII-2C >			
Channel Number	Freq.(MHz)	Min. B(MHz)	Determined Conducted Limit (dBm)
54	5270	47.57	27.77 > 24
62	5310	41.81	27.21 > 24
102	5510	41.59	27.18 > 24
110	5550	41.83	27.21 > 24
134	5670	41.89	27.22 > 24
142 (U-NII-2C Band)	5710	35.95	26.55 > 24

**802.11ax (HE80)**

Chan.	Chan. Freq. (MHz)	Average Power (dBm)		Total Power (mW)	Total Power (dBm)	Limit (dBm)	Pass / Fail
		Chain 0	Chain 1				
42	5210	16.46	16.49	88.824	19.49	24	Pass
58	5290	15.67	15.40	71.571	18.55	24	Pass
106	5530	17.05	16.77	98.233	19.92	24	Pass
122	5610	20.05	19.80	196.657	22.94	24	Pass
*138 (U-NII-2C Band)	5690	19.80	19.77	190.341	22.80	24	Pass
*138 (U-NII-3 Band)	5690	5.50	5.48	7.08	8.50	30	Pass
155	5775	20.82	20.45	231.699	23.65	30	Pass

Note: \* Test was performed in accordance with Measurement follow FCC KDB 789033 UNII test procedure Method SA-1 and use spectrum analyzer test.

1. For U-NII-1: The maximum gain is 4.03 dBi < 6dBi, so the output power limit shall not be reduced.
2. For U-NII-2A: The maximum gain is 4.03 dBi < 6dBi, so the output power limit shall not be reduced.
3. For U-NII-2C: The maximum gain is 4.03 dBi < 6dBi, so the output power limit shall not be reduced.
4. For U-NII-3: The maximum gain is 4.03 dBi < 6dBi, so the output power limit shall not be reduced.

**Note: For U-NII-2A, U-NII-2C Band output power limitation is determined based on 26dBc bandwidth**

Power Limit = 11dBm + 10logB < U-NII-2A, U-NII-2C >			
Channel Number	Freq.(MHz)	Min. B(MHz)	Determined Conducted Limit (dBm)
58	5290	83.23	30.2 > 24
106	5530	83.16	30.19 > 24
122	5610	83.37	30.21 > 24
138 (U-NII-2C Band)	5690	76.61	29.84 > 24

## Beamforming Mode

### 802.11ac (VHT20)

Chan.	Chan. Freq. (MHz)	Average Power (dBm)		Total Power (mW)	Total Power (dBm)	Limit (dBm)	Pass / Fail
		Chain 0	Chain 1				
36	5180	18.50	18.75	145.784	21.64	23.05	Pass
40	5200	19.97	19.99	199.082	22.99	23.05	Pass
48	5240	19.92	20.02	198.636	22.98	23.05	Pass
52	5260	16.80	16.69	94.529	19.76	23.05	Pass
60	5300	16.74	16.80	95.069	19.78	23.05	Pass
64	5320	16.72	16.70	93.763	19.72	23.05	Pass
100	5500	16.99	16.58	95.502	19.80	23.05	Pass
116	5580	17.02	16.67	96.802	19.86	23.05	Pass
140	5700	16.88	16.71	95.634	19.81	23.05	Pass
*144 (U-NII-2C Band)	5720	16.65	16.52	91.113	19.60	22.01	Pass
*144 (U-NII-3 Band)	5720	10.70	10.72	23.552	13.72	29.05	Pass
149	5745	23.00	22.59	381.078	25.81	29.05	Pass
157	5785	22.64	21.92	339.25	25.31	29.05	Pass
165	5825	23.10	22.77	393.408	25.95	29.05	Pass

Note: \* Test was performed in accordance with Measurement follow FCC KDB 789033 UNII test procedure Method SA-1 and use spectrum analyzer test.

1. For U-NII-1: The directional gain =  $10 \log[(10^{G0/20} + 10^{G1/20})^2 / 2]$  = 6.95 dBi > 6dBi, so the output power limit shall be reduced to  $24 - (6.95 - 6) = 23.05$  dBm..
2. For U-NII-2A: The directional gain is 6.95dBi > 6dBi, therefore the limit needs to reduce, so the power limit shall be reduced to "Determined Conducted Limit-(6.95-6)".
3. For U-NII-2C: The directional gain is 6.95dBi > 6dBi, therefore the limit needs to reduce, so the power limit shall be reduced to "Determined Conducted Limit-(6.95-6)".
4. For U-NII-3: The directional gain =  $10 \log[(10^{G0/20} + 10^{G1/20})^2 / 2]$  = 6.95 dBi > 6dBi, so the output power limit shall be reduced to  $30 - (6.95 - 6) = 29.05$  dBm..

**Note: For U-NII-2A, U-NII-2C Band output power limitation is determined based on 26dBc bandwidth**

Power Limit = 11dBm + 10logB < U-NII-2A, U-NII-2C >			
Channel Number	Freq.(MHz)	Min. B(MHz)	Determined Conducted Limit (dBm)
52	5260	22.7	24.56 > 24
60	5300	23.46	24.7 > 24
64	5320	21.5	24.32 > 24
100	5500	21.57	24.33 > 24
116	5580	21.51	24.32 > 24
140	5700	21.05	24.23 > 24
144 (U-NII-2C Band)	5720	15.72	22.96 < 24

**802.11ac (VHT40)**

Chan.	Chan. Freq. (MHz)	Average Power (dBm)		Total Power (mW)	Total Power (dBm)	Limit (dBm)	Pass / Fail
		Chain 0	Chain 1				
38	5190	16.98	16.95	99.433	19.98	23.05	Pass
46	5230	19.82	19.76	190.564	22.80	23.05	Pass
54	5270	17.02	16.69	97.016	19.87	23.05	Pass
62	5310	16.75	16.88	96.068	19.83	23.05	Pass
102	5510	16.98	16.81	97.862	19.91	23.05	Pass
110	5550	16.80	16.72	94.852	19.77	23.05	Pass
134	5670	16.82	16.97	97.858	19.91	23.05	Pass
*142 (U-NII-2C Band)	5710	16.30	16.07	83.116	19.20	23.05	Pass
*142 (U-NII-3 Band)	5710	5.30	5.33	6.8	8.33	29.05	Pass
151	5755	21.59	21.55	287.101	24.58	29.05	Pass
159	5795	23.38	22.93	414.107	26.17	29.05	Pass

Note: \* Test was performed in accordance with Measurement follow FCC KDB 789033 UNII test procedure Method SA-1 and use spectrum analyzer test.

1. For U-NII-1: The directional gain =  $10 \log[(10^{G0/20} + 10^{G1/20})^2 / 2] = 6.95 \text{ dBi} > 6\text{dBi}$ , so the output power limit shall be reduced to  $24 - (6.95 - 6) = 23.05 \text{ dBm}$ .
2. For U-NII-2A: The directional gain is  $6.95\text{dBi} > 6\text{dBi}$ , therefore the limit needs to reduce, so the power limit shall be reduced to "Determined Conducted Limit-(6.95-6)".
3. For U-NII-2C: The directional gain is  $6.95\text{dBi} > 6\text{dBi}$ , therefore the limit needs to reduce, so the power limit shall be reduced to "Determined Conducted Limit-(6.95-6)".
4. For U-NII-3: The directional gain =  $10 \log[(10^{G0/20} + 10^{G1/20})^2 / 2] = 6.95 \text{ dBi} > 6\text{dBi}$ , so the output power limit shall be reduced to  $30 - (6.95 - 6) = 29.05 \text{ dBm}$ .

**Note: For U-NII-2A, U-NII-2C Band output power limitation is determined based on 26dBc bandwidth**

Power Limit = 11dBm + 10logB < U-NII-2A, U-NII-2C >			
Channel Number	Freq.(MHz)	Min. B(MHz)	Determined Conducted Limit (dBm)
54	5270	47.57	27.77 > 24
62	5310	41.81	27.21 > 24
102	5510	41.59	27.18 > 24
110	5550	41.83	27.21 > 24
134	5670	41.89	27.22 > 24
142 (U-NII-2C Band)	5710	35.95	26.55 > 24

**802.11ac (VHT80)**

Chan.	Chan. Freq. (MHz)	Average Power (dBm)		Total Power (mW)	Total Power (dBm)	Limit (dBm)	Pass / Fail
		Chain 0	Chain 1				
42	5210	16.40	16.45	87.809	19.44	23.05	Pass
58	5290	15.60	15.37	70.743	18.50	23.05	Pass
106	5530	16.97	16.73	96.871	19.86	23.05	Pass
122	5610	16.98	16.77	97.422	19.89	23.05	Pass
*138 (U-NII-2C Band)	5690	16.64	16.55	91.317	19.61	23.05	Pass
*138 (U-NII-3 Band)	5690	2.44	2.60	3.574	5.53	29.05	Pass
155	5775	20.72	20.39	227.428	23.57	29.05	Pass

Note: \* Test was performed in accordance with Measurement follow FCC KDB 789033 UNII test procedure Method SA-1 and use spectrum analyzer test.

1. For U-NII-1: The directional gain =  $10 \log[(10^{G0/20} + 10^{G1/20})^2 / 2]$  = 6.95 dBi > 6dBi, so the output power limit shall be reduced to  $24-(6.95-6) = 23.05$  dBm..
2. For U-NII-2A: The directional gain is 6.95dBi > 6dBi, therefore the limit needs to reduce, so the power limit shall be reduced to "Determined Conducted Limit-(6.95-6)".
3. For U-NII-2C: The directional gain is 6.95dBi > 6dBi, therefore the limit needs to reduce, so the power limit shall be reduced to "Determined Conducted Limit-(6.95-6)".
4. For U-NII-3: The directional gain =  $10 \log[(10^{G0/20} + 10^{G1/20})^2 / 2]$  = 6.95 dBi > 6dBi, so the output power limit shall be reduced to  $30-(6.95-6) = 29.05$  dBm..

**Note: For U-NII-2A, U-NII-2C Band output power limitation is determined based on 26dBc bandwidth**

Power Limit = 11dBm + 10logB < U-NII-2A, U-NII-2C >			
Channel Number	Freq.(MHz)	Min. B(MHz)	Determined Conducted Limit (dBm)
58	5290	83.23	30.2 > 24
106	5530	83.16	30.19 > 24
122	5610	83.37	30.21 > 24
138 (U-NII-2C Band)	5690	76.61	29.84 > 24



**802.11ax (HE20)**

Chan.	Chan. Freq. (MHz)	Average Power (dBm)		Total Power (mW)	Total Power (dBm)	Limit (dBm)	Pass / Fail
		Chain 0	Chain 1				
36	5180	18.55	18.81	147.647	21.69	23.05	Pass
40	5200	19.85	19.74	190.794	22.81	23.05	Pass
48	5240	19.77	19.86	191.67	22.83	23.05	Pass
52	5260	16.85	16.76	95.841	19.82	23.05	Pass
60	5300	16.86	16.89	97.394	19.89	23.05	Pass
64	5320	16.81	16.81	95.947	19.82	23.05	Pass
100	5500	17.09	16.67	97.62	19.90	23.05	Pass
116	5580	17.11	16.79	99.157	19.96	23.05	Pass
140	5700	16.94	16.82	97.515	19.89	23.05	Pass
*144 (U-NII-2C Band)	5720	16.72	16.58	92.488	19.66	22.01	Pass
*144 (U-NII-3 Band)	5720	10.72	10.80	23.826	13.77	29.05	Pass
149	5745	23.06	22.65	386.379	25.87	29.05	Pass
157	5785	22.70	22.00	344.698	25.37	29.05	Pass
165	5825	23.17	22.83	399.358	26.01	29.05	Pass

Note: \* Test was performed in accordance with Measurement follow FCC KDB 789033 UNII test procedure Method SA-1 and use spectrum analyzer test.

1. For U-NII-1: The directional gain =  $10 \log[(10^{G0/20} + 10^{G1/20})^2 / 2]$  = 6.95 dBi > 6dBi, so the output power limit shall be reduced to  $24 - (6.95 - 6) = 23.05$  dBm..
2. For U-NII-2A: The directional gain is 6.95dBi > 6dBi, therefore the limit needs to reduce, so the power limit shall be reduced to "Determined Conducted Limit-(6.95-6)".
3. For U-NII-2C: The directional gain is 6.95dBi > 6dBi, therefore the limit needs to reduce, so the power limit shall be reduced to "Determined Conducted Limit-(6.95-6)".
4. For U-NII-3: The directional gain =  $10 \log[(10^{G0/20} + 10^{G1/20})^2 / 2]$  = 6.95 dBi > 6dBi, so the output power limit shall be reduced to  $30 - (6.95 - 6) = 29.05$  dBm..

**Note: For U-NII-2A, U-NII-2C Band output power limitation is determined based on 26dBc bandwidth**

Power Limit = 11dBm + 10logB < U-NII-2A, U-NII-2C >			
Channel Number	Freq.(MHz)	Min. B(MHz)	Determined Conducted Limit (dBm)
52	5260	22.7	24.56 > 24
60	5300	23.46	24.7 > 24
64	5320	21.5	24.32 > 24
100	5500	21.57	24.33 > 24
116	5580	21.51	24.32 > 24
140	5700	21.05	24.23 > 24
144 (U-NII-2C Band)	5720	15.72	22.96 < 24

**802.11ax (HE40)**

Chan.	Chan. Freq. (MHz)	Average Power (dBm)		Total Power (mW)	Total Power (dBm)	Limit (dBm)	Pass / Fail
		Chain 0	Chain 1				
38	5190	16.95	17.00	99.664	19.99	23.05	Pass
46	5230	19.82	19.76	190.564	22.80	23.05	Pass
54	5270	17.13	16.75	98.957	19.95	23.05	Pass
62	5310	16.83	16.95	97.74	19.90	23.05	Pass
102	5510	17.02	16.88	99.103	19.96	23.05	Pass
110	5550	16.89	16.80	96.728	19.86	23.05	Pass
134	5670	16.90	17.06	99.794	19.99	23.05	Pass
*142 (U-NII-2C Band)	5710	16.49	16.35	87.718	19.43	23.05	Pass
*142 (U-NII-3 Band)	5710	5.76	5.81	7.578	8.80	29.05	Pass
151	5755	21.65	21.60	290.762	24.64	29.05	Pass
159	5795	23.43	23.00	419.819	26.23	29.05	Pass

Note: \* Test was performed in accordance with Measurement follow FCC KDB 789033 UNII test procedure Method SA-1 and use spectrum analyzer test.

1. For U-NII-1: The directional gain =  $10 \log[(10^{G0/20} + 10^{G1/20})^2 / 2] = 6.95 \text{ dBi} > 6\text{dBi}$ , so the output power limit shall be reduced to  $24 - (6.95 - 6) = 23.05 \text{ dBm}$ .
2. For U-NII-2A: The directional gain is  $6.95\text{dBi} > 6\text{dBi}$ , therefore the limit needs to reduce, so the power limit shall be reduced to "Determined Conducted Limit-(6.95-6)".
3. For U-NII-2C: The directional gain is  $6.95\text{dBi} > 6\text{dBi}$ , therefore the limit needs to reduce, so the power limit shall be reduced to "Determined Conducted Limit-(6.95-6)".
4. For U-NII-3: The directional gain =  $10 \log[(10^{G0/20} + 10^{G1/20})^2 / 2] = 6.95 \text{ dBi} > 6\text{dBi}$ , so the output power limit shall be reduced to  $30 - (6.95 - 6) = 29.05 \text{ dBm}$ .

**Note: For U-NII-2A, U-NII-2C Band output power limitation is determined based on 26dBc bandwidth**

Power Limit = 11dBm + 10logB < U-NII-2A, U-NII-2C >			
Channel Number	Freq.(MHz)	Min. B(MHz)	Determined Conducted Limit (dBm)
54	5270	47.57	27.77 > 24
62	5310	41.81	27.21 > 24
102	5510	41.59	27.18 > 24
110	5550	41.83	27.21 > 24
134	5670	41.89	27.22 > 24
142 (U-NII-2C Band)	5710	35.95	26.55 > 24

**802.11ax (HE80)**

Chan.	Chan. Freq. (MHz)	Average Power (dBm)		Total Power (mW)	Total Power (dBm)	Limit (dBm)	Pass / Fail
		Chain 0	Chain 1				
42	5210	16.46	16.49	88.824	19.49	23.05	Pass
58	5290	15.67	15.40	71.571	18.55	23.05	Pass
106	5530	17.05	16.77	98.233	19.92	23.05	Pass
122	5610	17.02	16.81	98.323	19.93	23.05	Pass
*138 (U-NII-2C Band)	5690	16.90	16.92	98.182	19.92	23.05	Pass
*138 (U-NII-3 Band)	5690	2.62	2.62	3.656	5.63	29.05	Pass
155	5775	20.82	20.45	231.699	23.65	29.05	Pass

Note: \* Test was performed in accordance with Measurement follow FCC KDB 789033 UNII test procedure Method SA-1 and use spectrum analyzer test.

1. For U-NII-1: The directional gain =  $10 \log[(10^{G0/20} + 10^{G1/20})^2 / 2]$  = 6.95 dBi > 6dBi, so the output power limit shall be reduced to  $24 - (6.95 - 6) = 23.05$  dBm..
2. For U-NII-2A: The directional gain is 6.95dBi > 6dBi, therefore the limit needs to reduce, so the power limit shall be reduced to "Determined Conducted Limit-(6.95-6)".
3. For U-NII-2C: The directional gain is 6.95dBi > 6dBi, therefore the limit needs to reduce, so the power limit shall be reduced to "Determined Conducted Limit-(6.95-6)".
4. For U-NII-3: The directional gain =  $10 \log[(10^{G0/20} + 10^{G1/20})^2 / 2]$  = 6.95 dBi > 6dBi, so the output power limit shall be reduced to  $30 - (6.95 - 6) = 29.05$  dBm..

**Note: For U-NII-2A, U-NII-2C Band output power limitation is determined based on 26dBc bandwidth**

Power Limit = 11dBm + 10logB < U-NII-2A, U-NII-2C >			
Channel Number	Freq.(MHz)	Min. B(MHz)	Determined Conducted Limit (dBm)
58	5290	83.23	30.2 > 24
106	5530	83.16	30.19 > 24
122	5610	83.37	30.21 > 24
138 (U-NII-2C Band)	5690	76.61	29.84 > 24

**For channel straddling 5725MHz of Power  
CDD Mode**

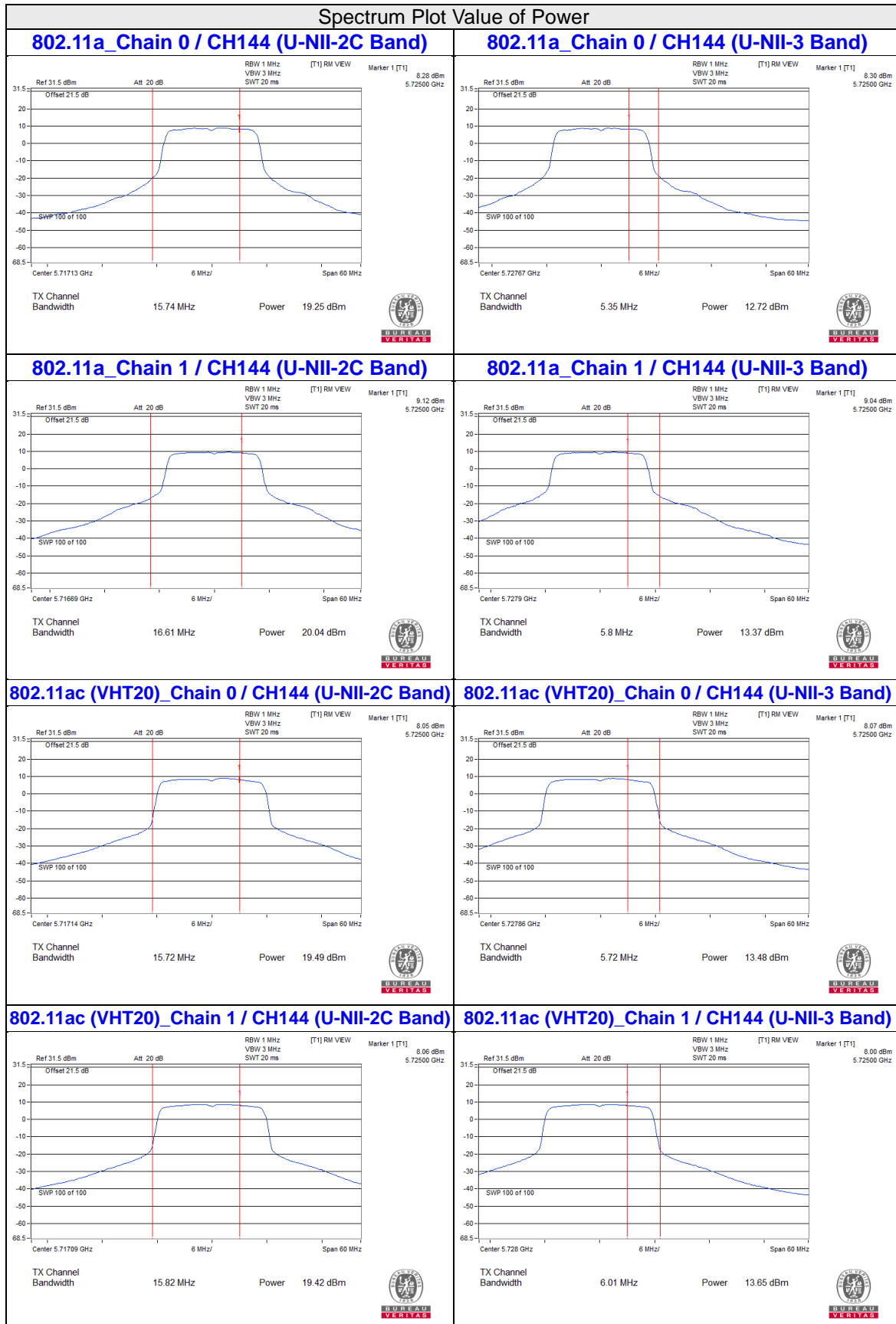

### Spectrum Plot Value of Power

**802.11ac (VHT40)\_Chain 0 / CH142 (U-NII-2C Band)**

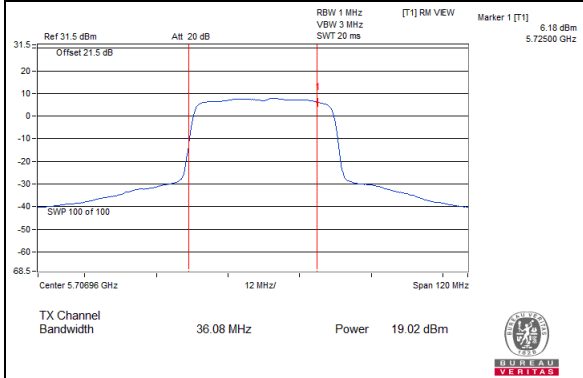

**802.11ac (VHT40)\_Chain 0 / CH142 (U-NII-3 Band)**

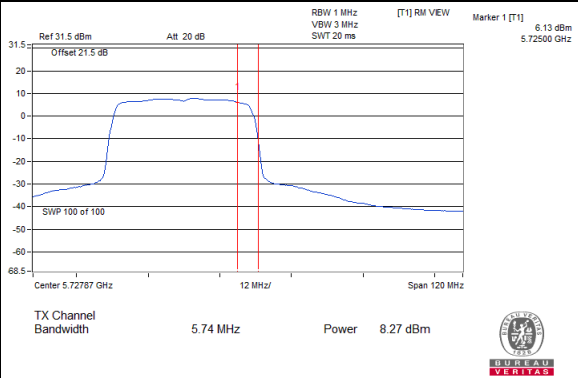

**802.11ac (VHT40)\_Chain 1 / CH142 (U-NII-2C Band)**

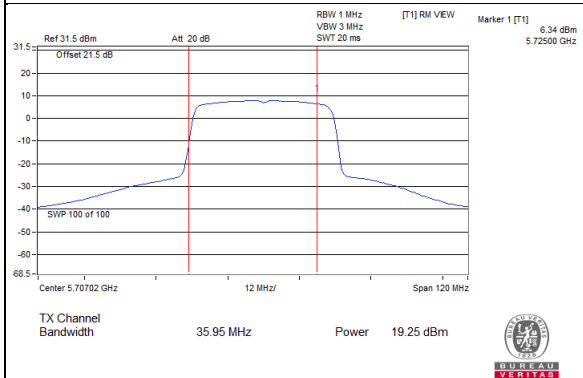

**802.11ac (VHT40)\_Chain 1 / CH142 (U-NII-3 Band)**

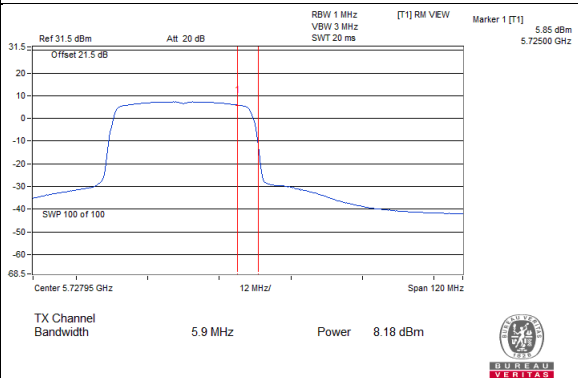

**802.11ac (VHT80)\_Chain 0 / CH138 (U-NII-2C Band)**

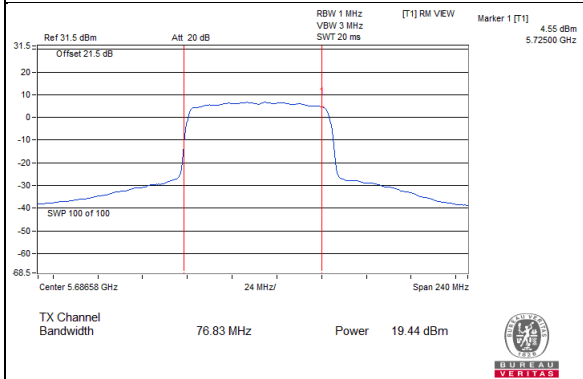

**802.11ac (VHT80)\_Chain 0 / CH138 (U-NII-3 Band)**

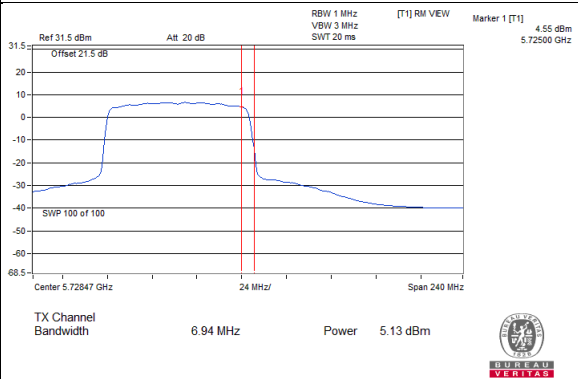

**802.11ac (VHT80)\_Chain 1 / CH138 (U-NII-2C Band)**

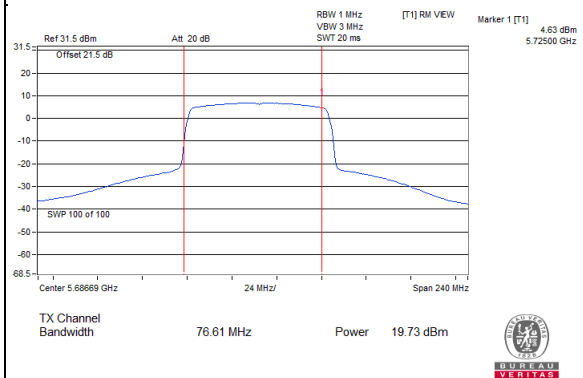

**802.11ac (VHT80)\_Chain 1 / CH138 (U-NII-3 Band)**

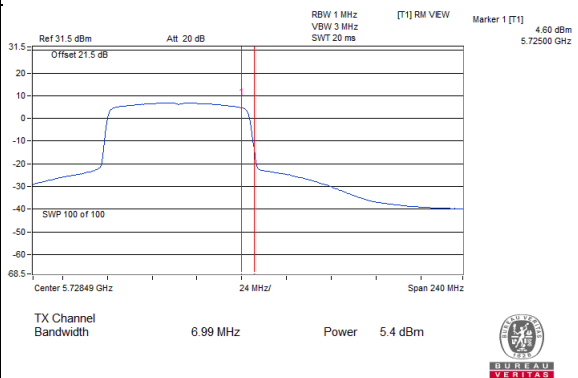

### Spectrum Plot Value of Power

**802.11ax (HE20)\_Chain 0 / CH144 (U-NII-2C Band)**

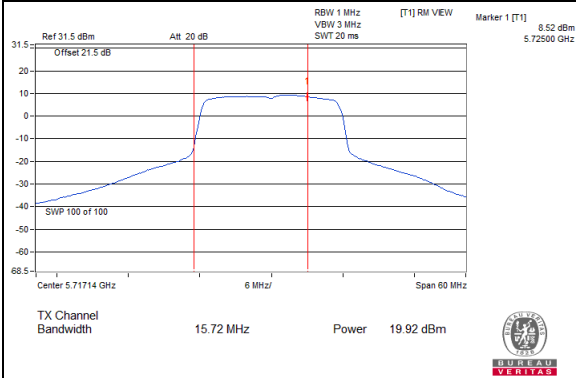

**802.11ax (HE20)\_Chain 0 / CH144 (U-NII-3 Band)**

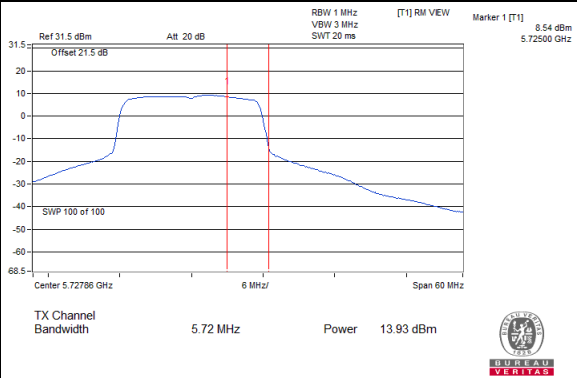

**802.11ax (HE20)\_Chain 1 / CH144 (U-NII-2C Band)**

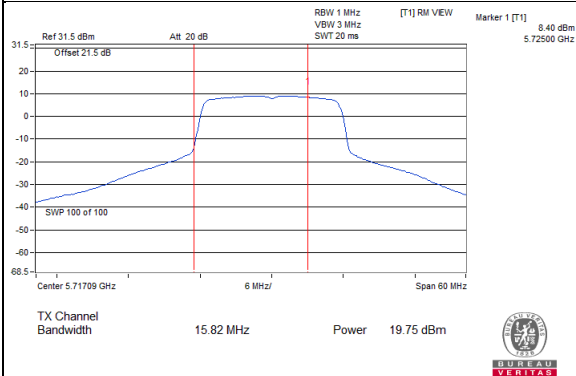

**802.11ax (HE20)\_Chain 1 / CH144 (U-NII-3 Band)**

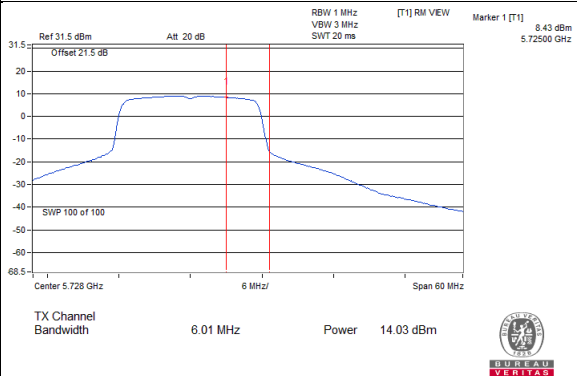

**802.11ax (HE40)\_Chain 0 / CH142 (U-NII-2C Band)**

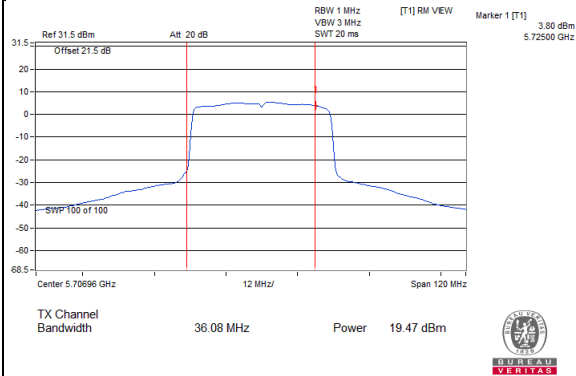

**802.11ax (HE40)\_Chain 0 / CH142 (U-NII-3 Band)**

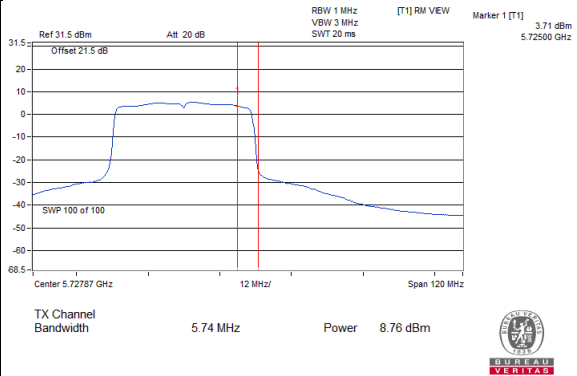

**802.11ax (HE40)\_Chain 1 / CH142 (U-NII-2C Band)**

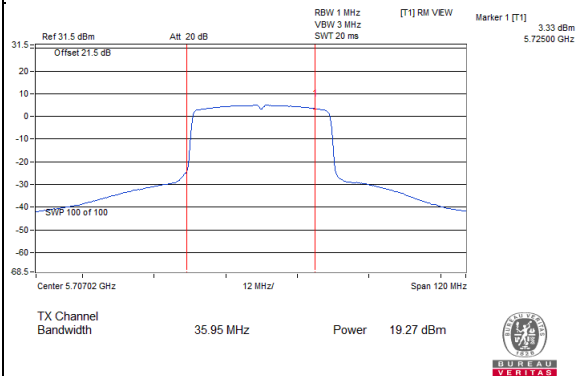

**802.11ax (HE40)\_Chain 1 / CH142 (U-NII-3 Band)**

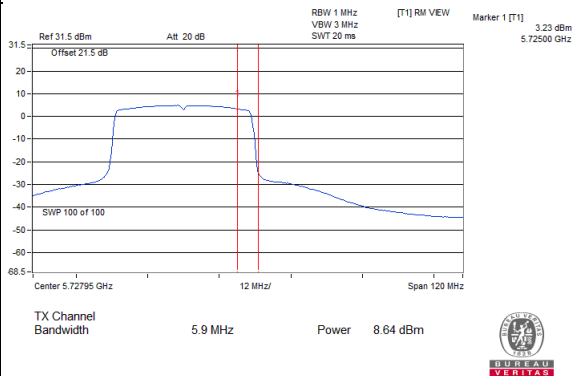

### Spectrum Plot Value of Power

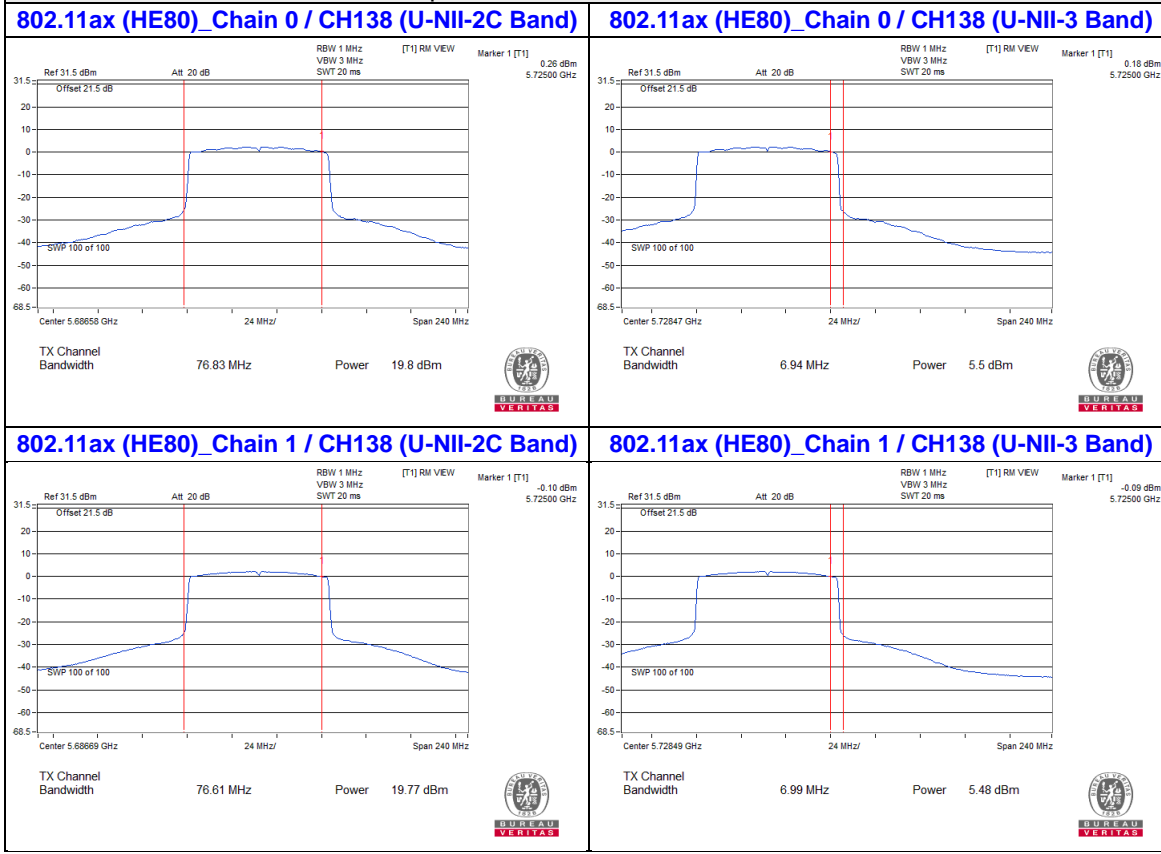



## Beamforming Mode

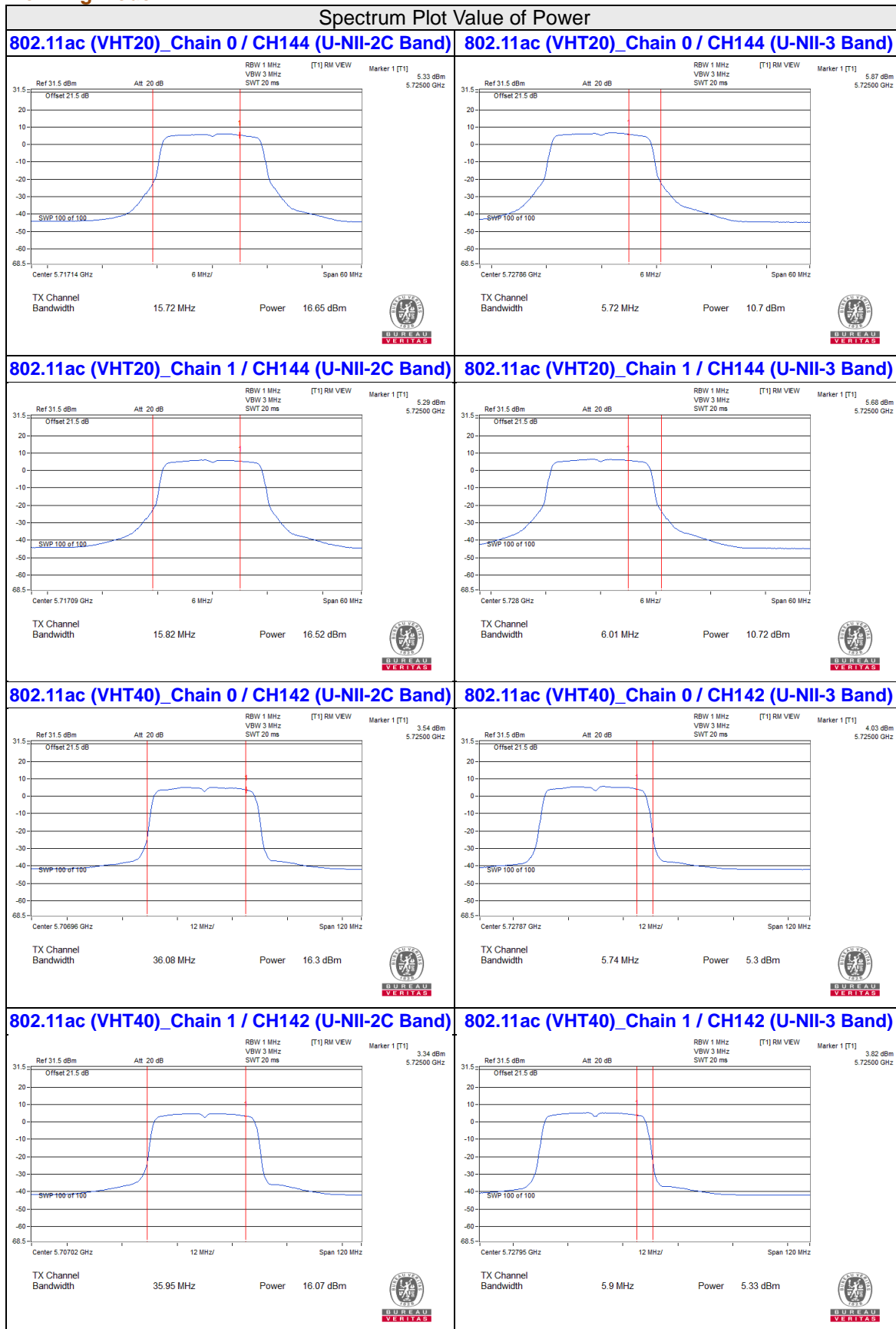

### Spectrum Plot Value of Power

**802.11ac (VHT80)\_Chain 0 / CH138 (U-NII-2C Band)**

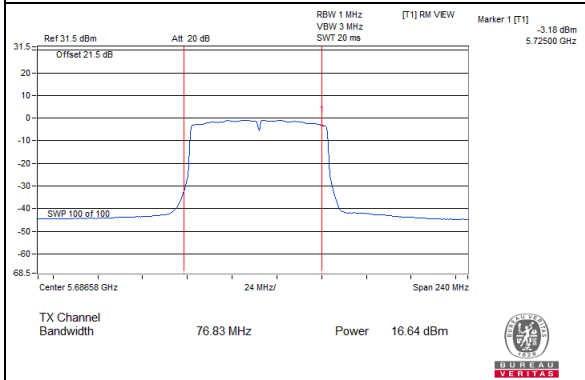

**802.11ac (VHT80)\_Chain 0 / CH138 (U-NII-3 Band)**

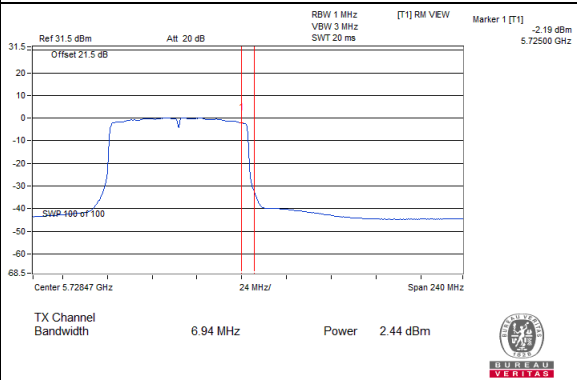

**802.11ac (VHT80)\_Chain 1 / CH138 (U-NII-2C Band)**

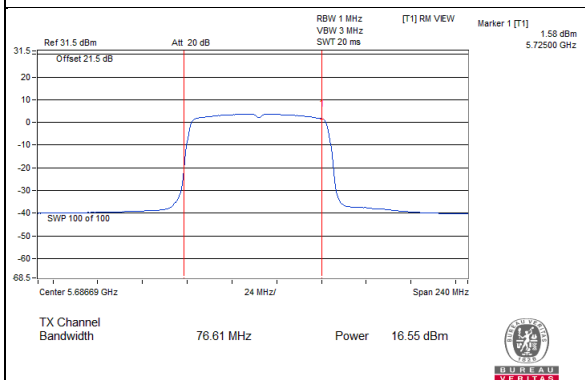

**802.11ac (VHT80)\_Chain 1 / CH138 (U-NII-3 Band)**

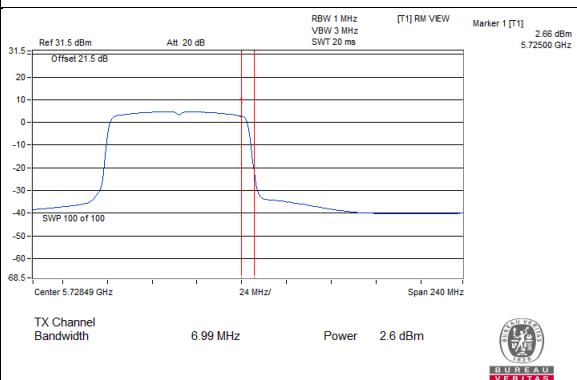

### Spectrum Plot Value of Power

**802.11ax (HE20)\_Chain 0 / CH144 (U-NII-2C Band)**

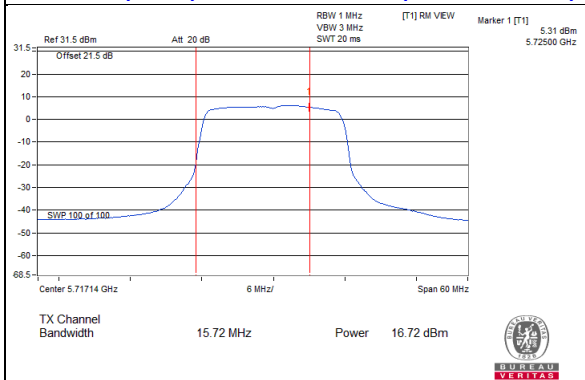

**802.11ax (HE20)\_Chain 0 / CH144 (U-NII-3 Band)**

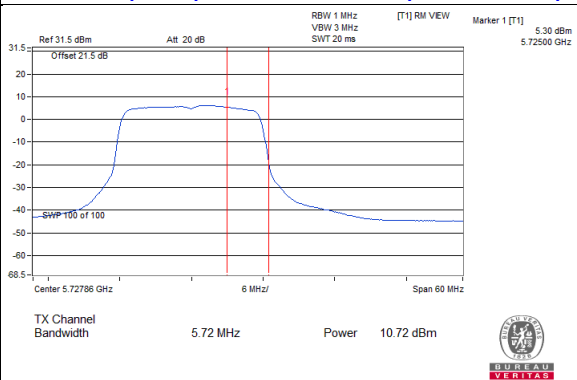

**802.11ax (HE20)\_Chain 1 / CH144 (U-NII-2C Band)**

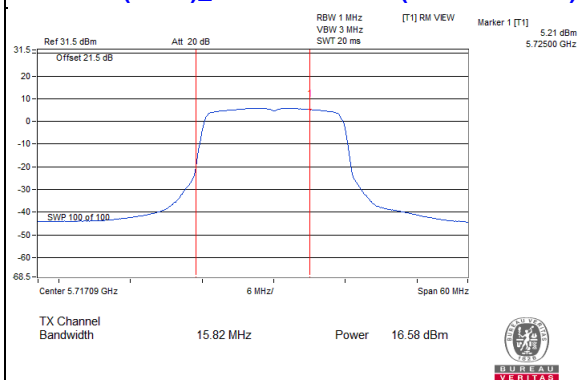

**802.11ax (HE20)\_Chain 1 / CH144 (U-NII-3 Band)**

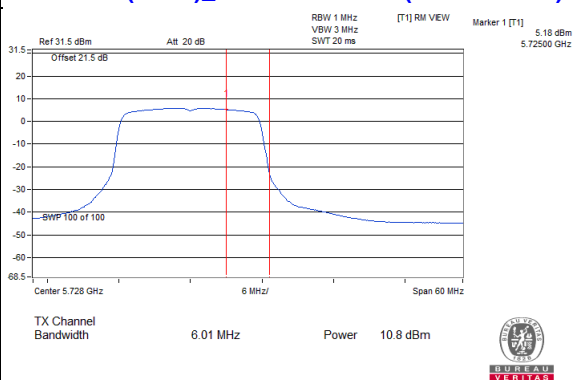

### Spectrum Plot Value of Power

**802.11ax (HE40)\_Chain 0 / CH142 (U-NII-2C Band)**

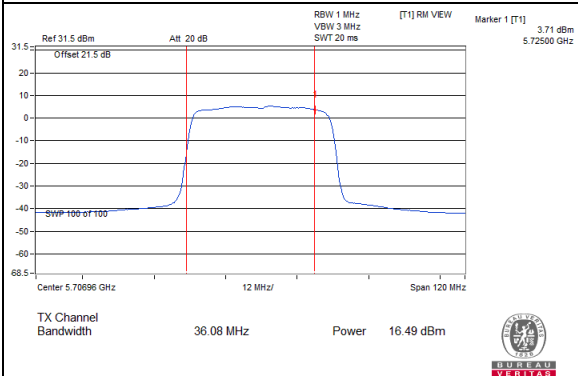

**802.11ax (HE40)\_Chain 0 / CH142 (U-NII-3 Band)**

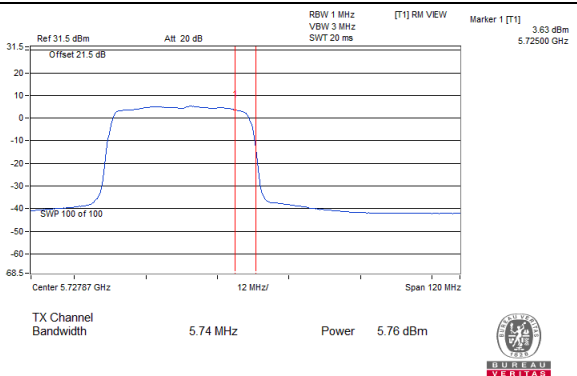

**802.11ax (HE40)\_Chain 1 / CH142 (U-NII-2C Band)**

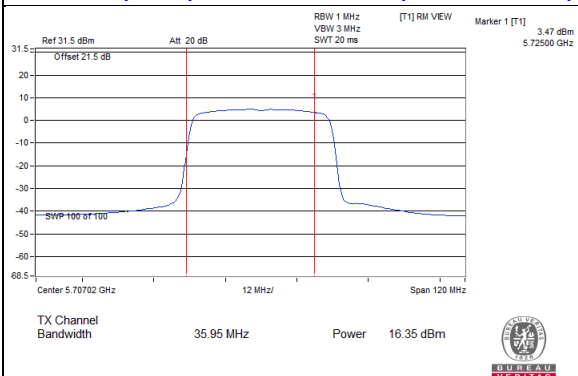

**802.11ax (HE40)\_Chain 1 / CH142 (U-NII-3 Band)**

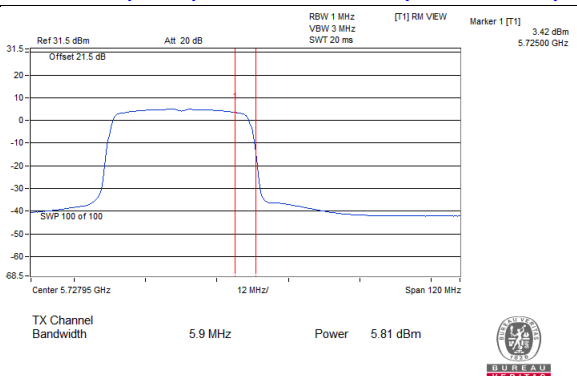

**802.11ax (HE80)\_Chain 0 / CH138 (U-NII-2C Band)**

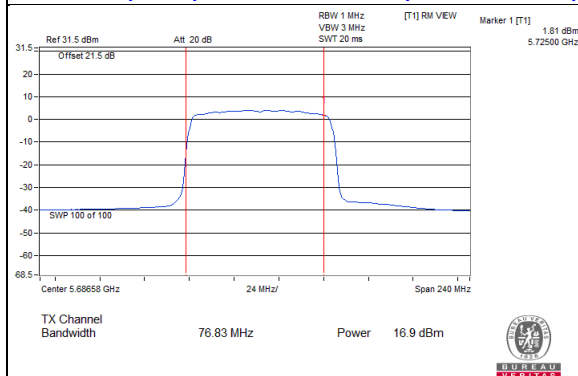

**802.11ax (HE80)\_Chain 0 / CH138 (U-NII-3 Band)**

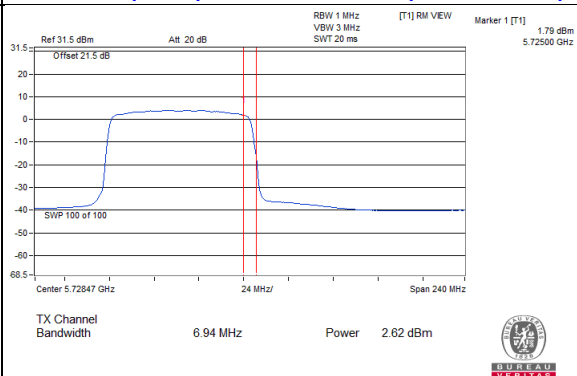

**802.11ax (HE80)\_Chain 1 / CH138 (U-NII-2C Band)**

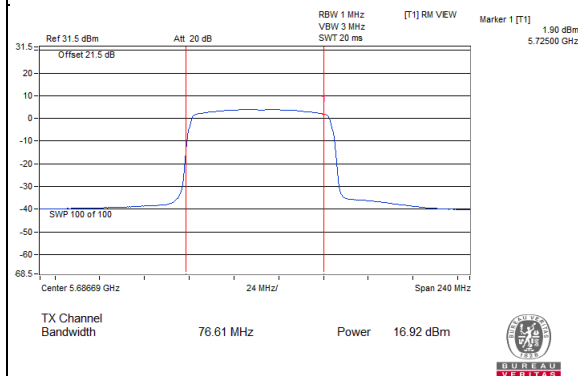

**802.11ax (HE80)\_Chain 1 / CH138 (U-NII-3 Band)**

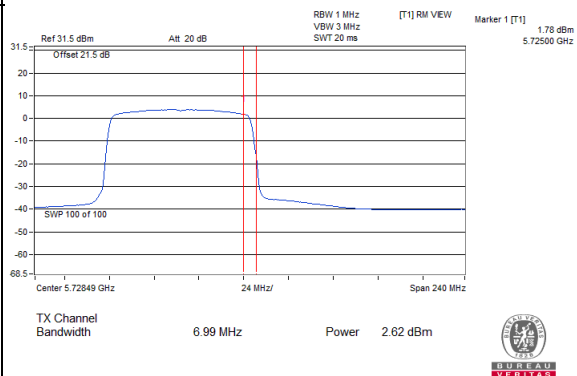

## 26dB OCCUPIED BANDWIDTH

### 802.11a

Channel	Frequency (MHz)	26dB Bandwidth (MHz)	
		Chain0	Chain1
52	5260	22.71	21.26
60	5300	21.94	20.85
64	5320	21.39	20.48
100	5500	20.98	20.77
116	5580	20.86	20.62
140	5700	20.7	20.51
144 (U-NII-2C Band)	5720	15.74	16.61

### 802.11ax (HE20)

Channel	Frequency (MHz)	26dB Bandwidth (MHz)	
		Chain0	Chain1
52	5260	23.72	22.7
60	5300	23.49	23.46
64	5320	21.5	21.82
100	5500	21.58	21.57
116	5580	22.23	21.51
140	5700	21.05	21.31
144 (U-NII-2C Band)	5720	15.72	15.82

### 802.11ax (HE40)

Channel	Frequency (MHz)	26dB Bandwidth (MHz)	
		Chain0	Chain1
54	5270	61.94	47.57
62	5310	41.81	41.81
102	5510	41.59	41.81
110	5550	41.91	41.83
134	5670	41.89	42
142 (U-NII-2C Band)	5710	36.08	35.95

### 802.11ax (HE80)

Channel	Frequency (MHz)	26dB Bandwidth (MHz)	
		Chain0	Chain1
58	5290	83.45	83.23
106	5530	83.16	83.29
122	5610	83.37	83.65
138 (U-NII-2C Band)	5690	76.83	76.61

### Spectrum Plot of Min. Value

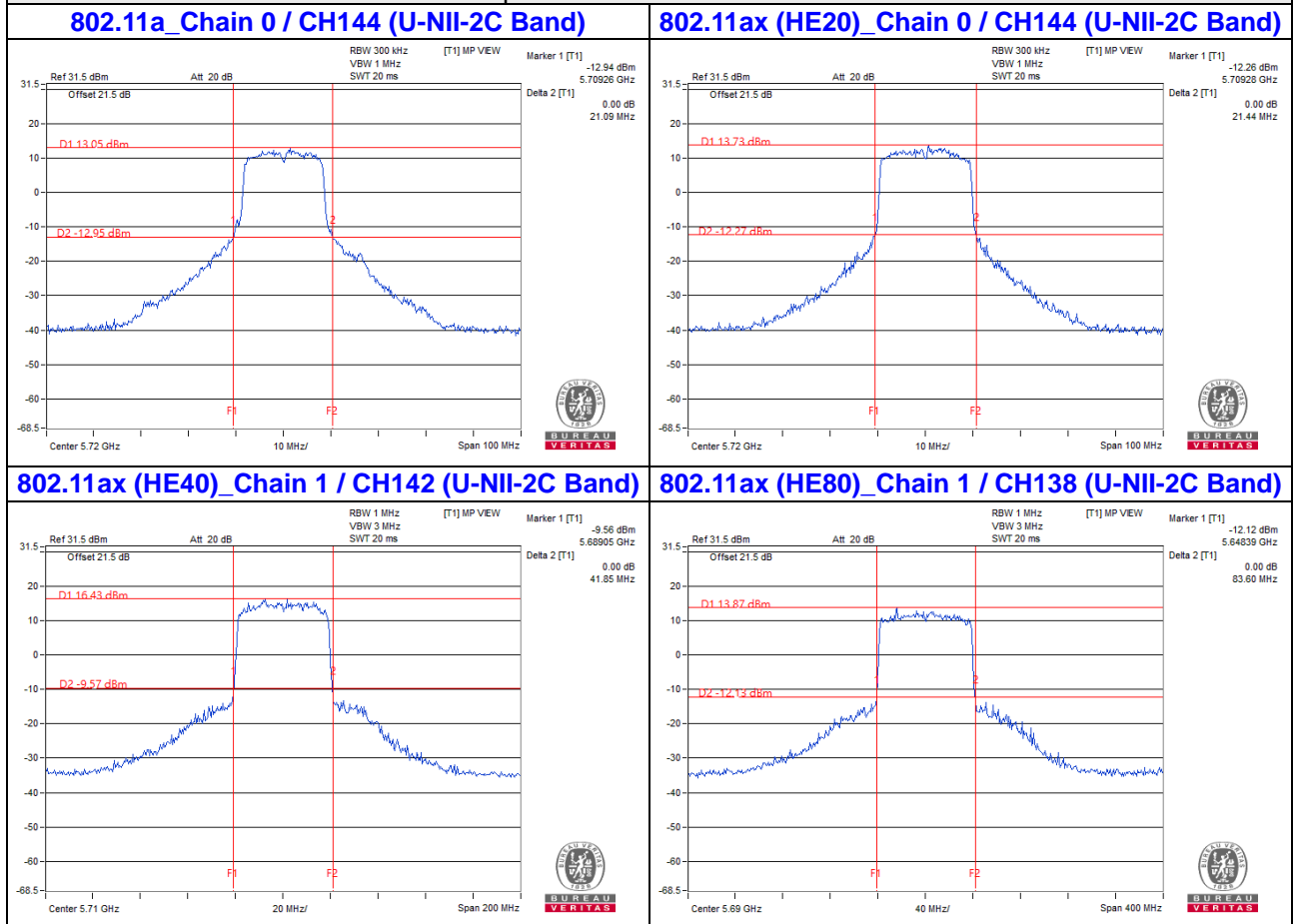

**Note:**

- For CH144 (U-NII-2C) = Delta 2 - (5725MHz - Marker 1)
- For CH142 (U-NII-2C) = Delta 2 - (5725MHz - Marker 1)
- For CH138 (U-NII-2C) = Delta 2 - (5725MHz - Marker 1)

## 4.4 Occupied Bandwidth Measurement

### 4.4.1 Test Setup

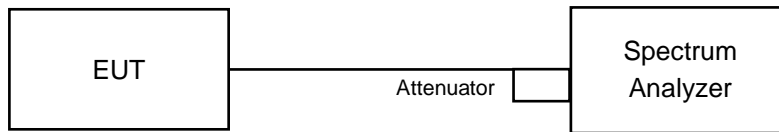

### 4.4.2 Test Instruments

Refer to section 4.1.2 to get information of above instrument.

### 4.4.3 Test Procedure

The transmitter output was connected to the spectrum analyzer through an attenuator. The bandwidth of the fundamental frequency was measured by spectrum analyzer with resolution bandwidth in the range of 1% to 5% of the anticipated emission bandwidth, and a video bandwidth at least 3x the resolution bandwidth and set the detector to SAMPLE. The width of a frequency band such that, below the lower and above the upper frequency limits, the mean powers emitted are each equal to a specified percentage 0.5% of the total mean power of a given emission.

#### 4.4.4 Test Results

##### 802.11a

Channel	Frequency (MHz)	Occupied Bandwidth (MHz)	
		Chain 0	Chain 1
36	5180	16.44	16.44
40	5200	16.56	16.44
48	5240	16.44	16.44
52	5260	16.44	16.44
60	5300	16.44	16.44
64	5320	16.44	16.44
100	5500	16.44	16.44
116	5580	16.44	16.44
140	5700	16.44	16.44
144 (U-NII-2C Band)	5720	13.4	13.28
144 (U-NII-3 Band)	5720	3.16	3.16
149	5745	28.69	26.35
157	5785	27.72	26.88
165	5825	29.52	30.36

##### 802.11ax (HE20)

Channel	Frequency (MHz)	Occupied Bandwidth (MHz)	
		Chain 0	Chain 1
36	5180	18.96	18.84
40	5200	19.2	19.2
48	5240	19.08	19.08
52	5260	19.08	18.96
60	5300	18.96	19.08
64	5320	18.84	18.84
100	5500	18.84	18.84
116	5580	19.08	18.84
140	5700	18.84	18.84
144 (U-NII-2C Band)	5720	14.48	14.6
144 (U-NII-3 Band)	5720	4.36	4.36
149	5745	25.68	25.56
157	5785	24.6	20.76
165	5825	28	26.09

**802.11ax (HE40)**

Channel	Frequency (MHz)	Occupied Bandwidth (MHz)	
		Chain 0	Chain 1
38	5190	38.64	38.64
46	5230	38.4	38.16
54	5270	38.09	38.16
62	5310	37.92	38.64
102	5510	37.92	37.92
110	5550	38.16	37.92
134	5670	38.43	37.92
142 (U-NII-2C Band)	5710	34.2	34.2
142 (U-NII-3 Band)	5710	3.72	3.72
151	5755	38.64	38.64
159	5795	60.96	58.56

**802.11ax (HE80)**

Channel	Frequency (MHz)	Occupied Bandwidth (MHz)	
		Chain 0	Chain 1
42	5210	78.24	78.24
58	5290	77.92	78.24
106	5530	77.92	77.92
122	5610	78.26	78.26
138 (U-NII-2C Band)	5690	74.3	74.3
138 (U-NII-3 Band)	5690	3.96	3.96
155	5775	77.76	77.76



Spectrum Plot of Max. Value

802.11a\_Chain 1 / CH165

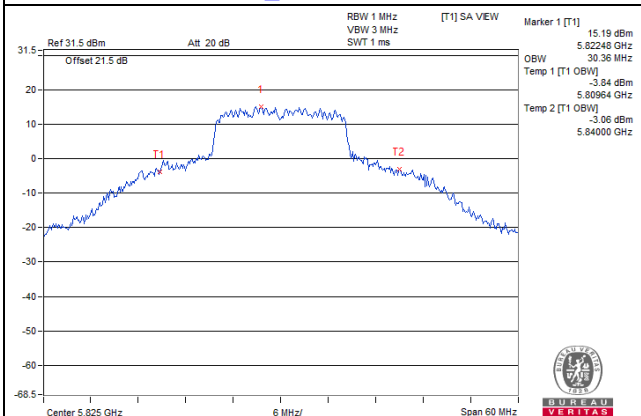

802.11ax (HE20)\_Chain 0 / CH165

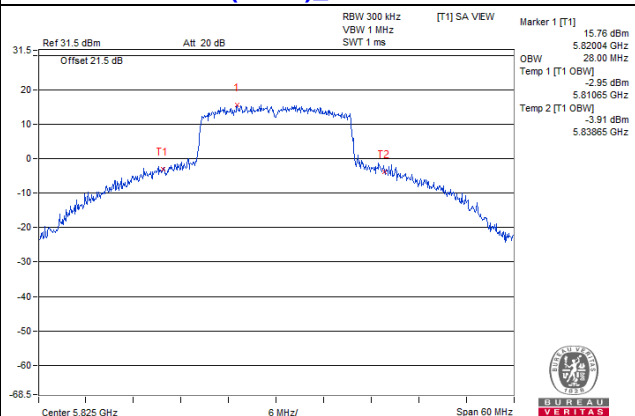

802.11ax (HE40)\_Chain 0 / CH159

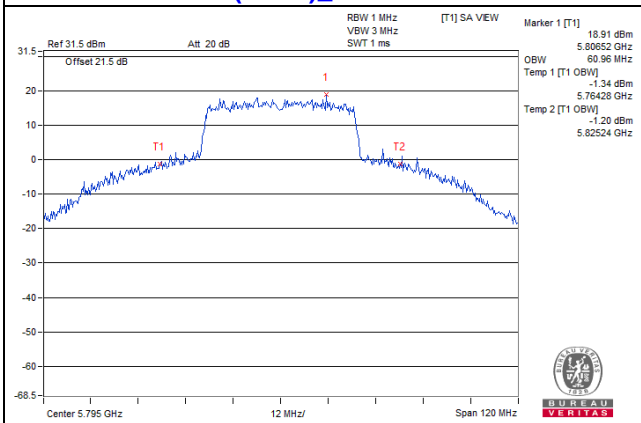

802.11ax (HE80)\_Chain 0 / CH122

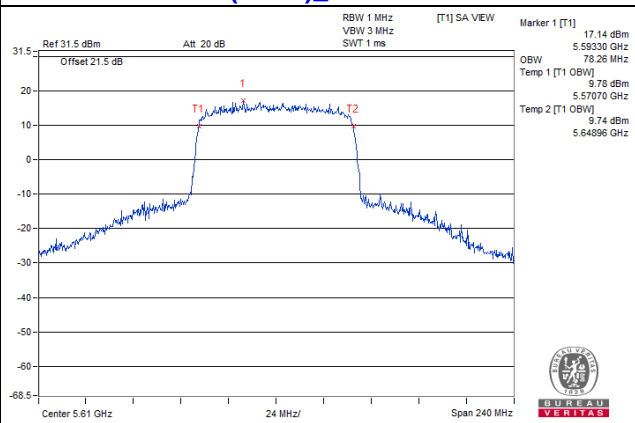

For channel straddling 5725MHz of OCP99% BW

Spectrum Plot Value of OCP99% BW

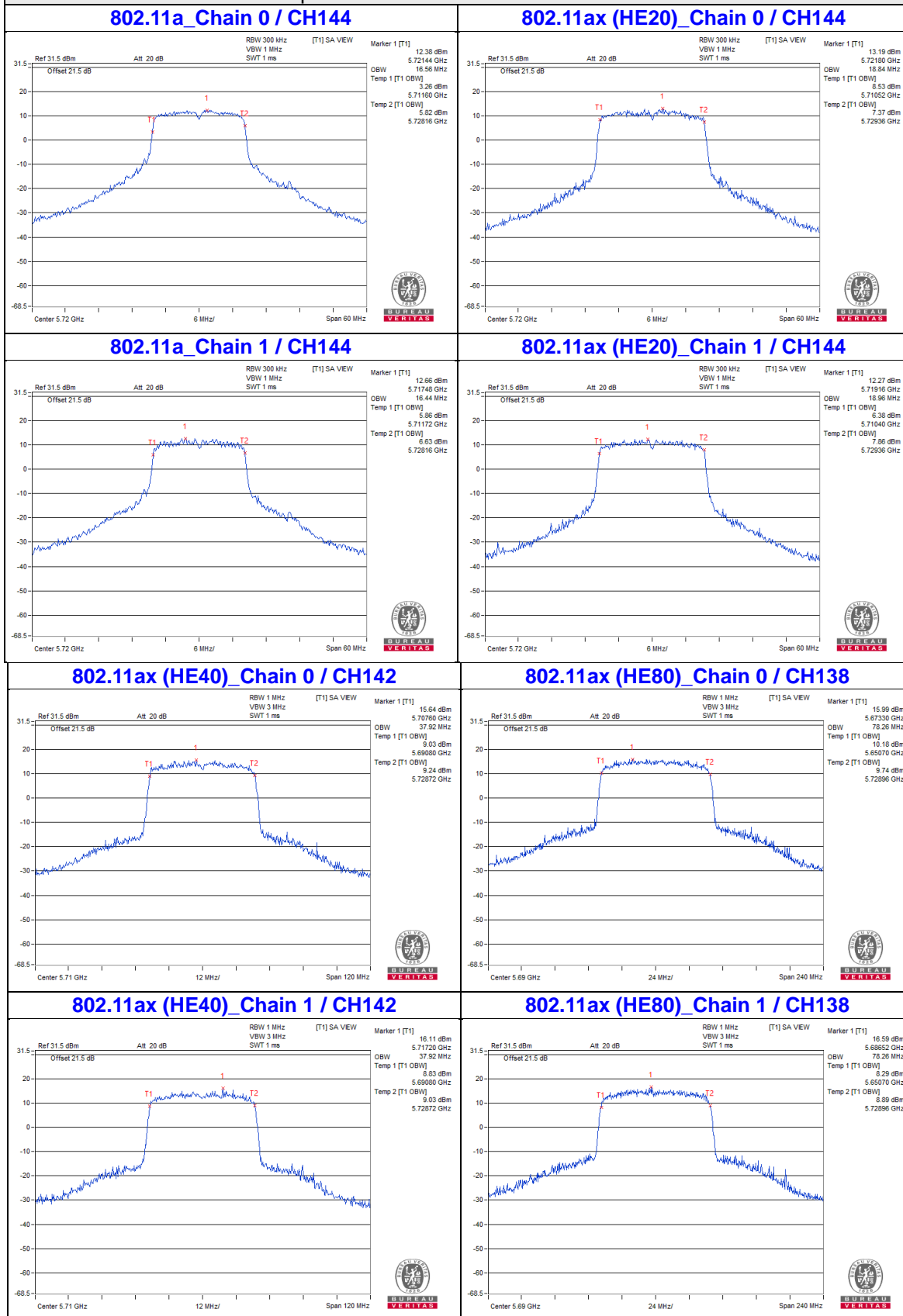

**Note:**

For CH144 (U-NII-2C) = 5725MHz - Temp 1  
For CH142 (U-NII-2C) = 5725MHz - Temp 1  
For CH138 (U-NII-2C) = 5725MHz - Temp 1  
For CH144 (U-NII-3) = Temp 2 - 5725MHz  
For CH142 (U-NII-3) = Temp 2 - 5725MHz  
For CH138 (U-NII-3) = Temp 2 - 5725MHz

**Spectrum Plot for near by DFS band  
(DFS is required, if 99% OCP straddle into U-NII-2A band)**

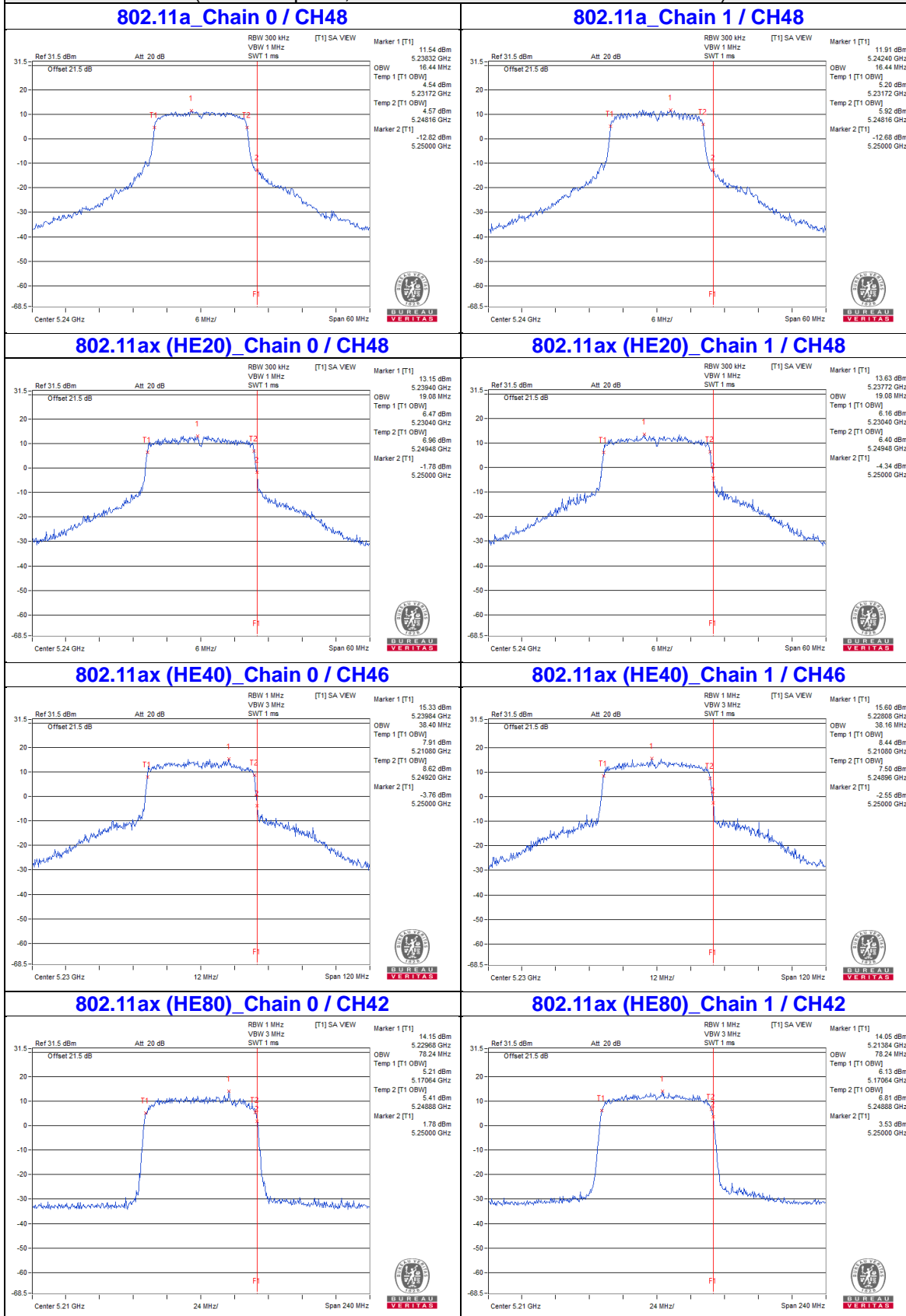

**Spectrum Plot for near by DFS band  
(DFS is required, if 99% OCP straddle into U-NII-2C band)**

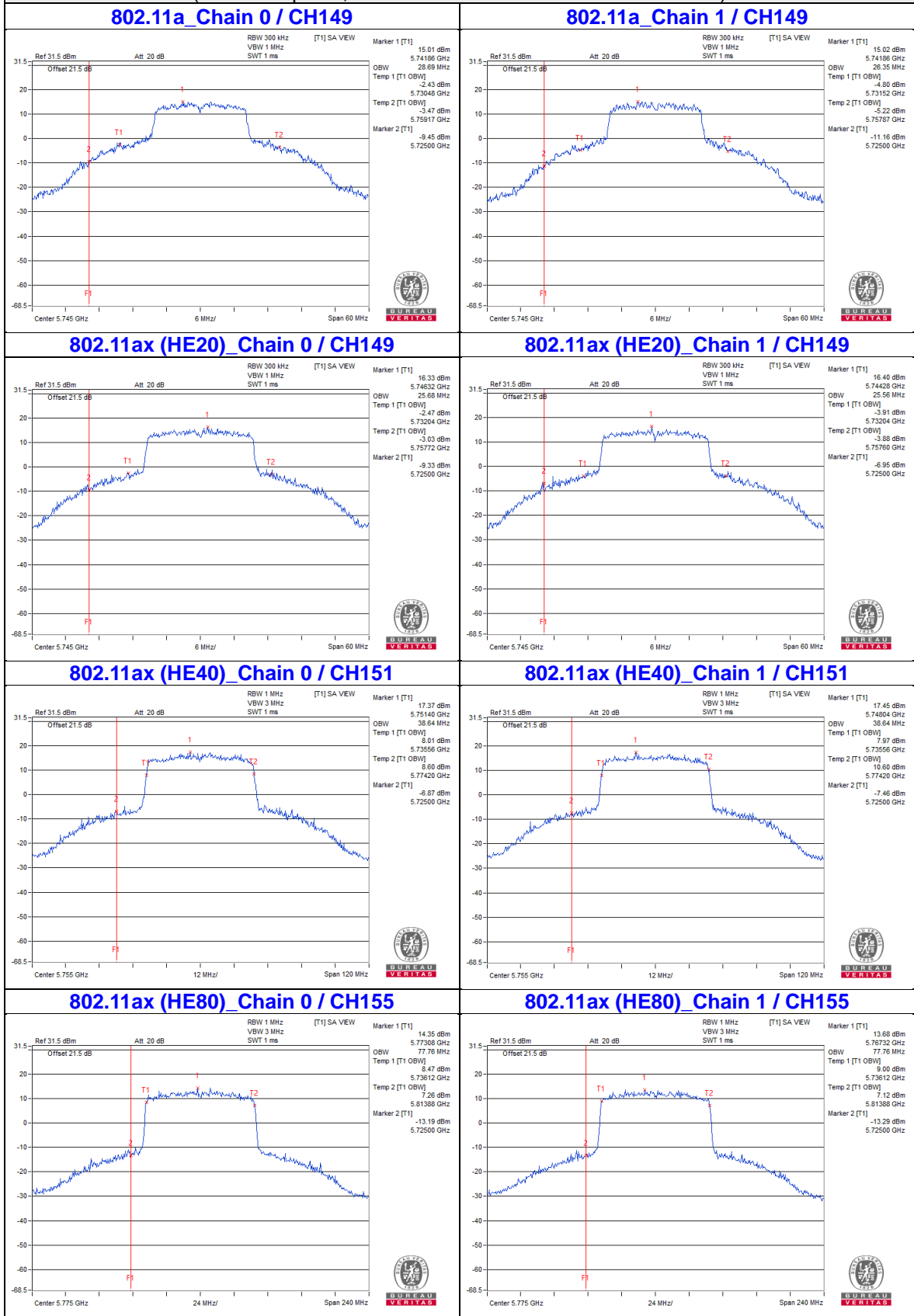

## 4.5 Peak Power Spectral Density Measurement

### 4.5.1 Limits of Peak Power Spectral Density Measurement

Operation Band	EUT Category		Limit
U-NII-1		Outdoor Access Point	17dBm/ MHz
		Fixed point-to-point Access Point	
		Indoor Access Point	
	√	Client device	11dBm/ MHz
U-NII-2A		√	11dBm/ MHz
U-NII-2C		√	11dBm/ MHz
U-NII-3		√	30dBm/ 500kHz

### 4.5.2 Test Setup

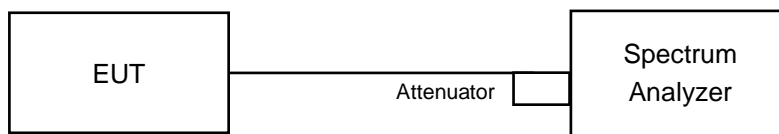

### 4.5.3 Test Instruments

Refer to section 4.1.2 to get information of above instrument.

### 4.5.4 Test Procedure

#### For U-NII-1, U-NII-2A, U-NII-2C band:

Using method SA-1

1. Set span to encompass the entire emission bandwidth (EBW) of the signal.
2. Set RBW = 1 MHz, Set VBW  $\geq$  3 MHz, Detector = RMS
3. Sweep time = auto, trigger set to "free run".
4. Trace average at least 100 traces in power averaging mode.
5. Record the max value.

#### For U-NII-3 band:

1. Set span to encompass the entire emission bandwidth (EBW) of the signal.
2. Set RBW = 300 kHz, Set VBW  $\geq$  1 MHz, Detector = RMS
3. Use the peak marker function to determine the maximum power level in any 300 kHz band segment within the fundamental EBW.
4. Scale the observed power level to an equivalent value in 500 kHz by adjusting (increasing) the measured power by a bandwidth correction factor (BWCF) where  $BWCF = 10\log(500\text{kHz}/300\text{kHz})$
5. Sweep time = auto, trigger set to "free run".
6. Trace average at least 100 traces in power averaging mode.
7. Record the max value.

#### 4.5.5 Deviation from Test Standard

No deviation.

#### 4.5.6 EUT Operating Condition

Same as Item 4.3.6.

#### 4.5.7 Test Results

For U-NII-1, U-NII-2A, U-NII-2C band:

##### 802.11a

Chan.	Chan. Freq. (MHz)	PSD (dBm/MHz)		Total PSD (dBm/MHz)	Max. PSD Limit (dBm/MHz)	Pass / Fail
		Chain 0	Chain 1			
36	5180	7.05	6.62	9.85	10.05	Pass
40	5200	7.16	6.02	9.64	10.05	Pass
48	5240	7.27	6.26	9.80	10.05	Pass
52	5260	7.54	6.33	9.99	10.05	Pass
60	5300	7.31	6.15	9.78	10.05	Pass
64	5320	7.20	5.91	9.61	10.05	Pass
100	5500	7.08	6.18	9.66	10.05	Pass
116	5580	7.21	6.24	9.76	10.05	Pass
140	5700	7.02	6.39	9.73	10.05	Pass
144 (U-NII-2C Band)	5720	7.09	6.35	9.75	10.05	Pass

Note: 1. Method a) of power density measurement of KDB 662911 is using for calculating total power density. Total power density is summing entire spectra across corresponding frequency bins on the various outputs by computer.

2. For U-NII-1&2A&2C: The directional gain =  $10 \log[(10^{G0/20} + 10^{G1/20})^2 / 2] = 6.95\text{dBi} > 6\text{dBi}$ , so the power density limit shall be reduced to  $11 - (6.95 - 6) = 10.05 \text{ dBm/MHz}$ .

##### 802.11ax (HE20)

Chan.	Chan. Freq. (MHz)	PSD (dBm/MHz)		Total PSD (dBm/MHz)	Max. PSD Limit (dBm/MHz)	Pass / Fail
		Chain 0	Chain 1			
36	5180	7.18	6.67	9.94	10.05	Pass
40	5200	7.59	6.26	9.99	10.05	Pass
48	5240	6.48	6.76	9.63	10.05	Pass
52	5260	7.41	6.06	9.80	10.05	Pass
60	5300	7.08	6.35	9.74	10.05	Pass
64	5320	7.15	5.82	9.55	10.05	Pass
100	5500	7.57	5.52	9.68	10.05	Pass
116	5580	7.73	5.84	9.90	10.05	Pass
140	5700	7.06	5.86	9.51	10.05	Pass
144 (U-NII-2C Band)	5720	6.27	6.81	9.56	10.05	Pass

Note: 1. Method a) of power density measurement of KDB 662911 is using for calculating total power density. Total power density is summing entire spectra across corresponding frequency bins on the various outputs by computer.

2. For U-NII-1&2A&2C: The directional gain =  $10 \log[(10^{G0/20} + 10^{G1/20})^2 / 2] = 6.95\text{dBi} > 6\text{dBi}$ , so the power density limit shall be reduced to  $11 - (6.95 - 6) = 10.05 \text{ dBm/MHz}$ .



### 802.11ax (HE40)

Chan.	Chan. Freq. (MHz)	PSD (dBm/MHz)		Total PSD (dBm/MHz)	Max. PSD Limit (dBm/MHz)	Pass / Fail
		Chain 0	Chain 1			
38	5190	2.39	2.10	5.26	10.05	Pass
46	5230	5.89	5.50	8.71	10.05	Pass
54	5270	5.41	4.90	8.17	10.05	Pass
62	5310	2.55	2.24	5.41	10.05	Pass
102	5510	2.99	2.51	5.77	10.05	Pass
110	5550	5.23	4.70	7.98	10.05	Pass
134	5670	4.91	4.86	7.90	10.05	Pass
142 (U-NII-2C Band)	5710	5.32	4.80	8.08	10.05	Pass

Note: 1. Method a) of power density measurement of KDB 662911 is using for calculating total power density. Total power density is summing entire spectra across corresponding frequency bins on the various outputs by computer.

2. For U-NII-1&2A&2C: The directional gain =  $10 \log[(10^{G0/20} + 10^{G1/20})^2 / 2] = 6.95\text{dBi} > 6\text{dBi}$ , so the power density limit shall be reduced to  $11 - (6.95 - 6) = 10.05 \text{ dBm/MHz}$ .

### 802.11ax (HE80)

Chan.	Chan. Freq. (MHz)	PSD (dBm/MHz)		Total PSD (dBm/MHz)	Max. PSD Limit (dBm/MHz)	Pass / Fail
		Chain 0	Chain 1			
42	5210	-1.01	-1.58	1.72	10.05	Pass
58	5290	-2.22	-2.61	0.60	10.05	Pass
106	5530	-0.74	-1.18	2.06	10.05	Pass
122	5610	2.53	2.14	5.35	10.05	Pass
138 (U-NII-2C Band)	5690	2.31	2.01	5.17	10.05	Pass

Note: 1. Method a) of power density measurement of KDB 662911 is using for calculating total power density. Total power density is summing entire spectra across corresponding frequency bins on the various outputs by computer.

2. For U-NII-1&2A&2C: The directional gain =  $10 \log[(10^{G0/20} + 10^{G1/20})^2 / 2] = 6.95\text{dBi} > 6\text{dBi}$ , so the power density limit shall be reduced to  $11 - (6.95 - 6) = 10.05 \text{ dBm/MHz}$ .

### Spectrum Plot of Worst Value

#### 802.11a\_Chain 0 / CH52

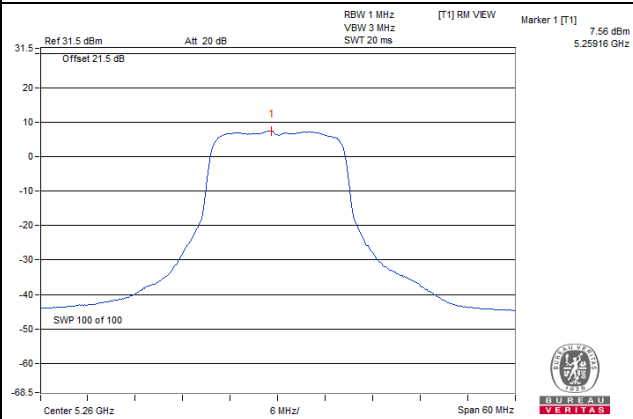

#### 802.11ax (HE20)\_Chain 0 / CH116

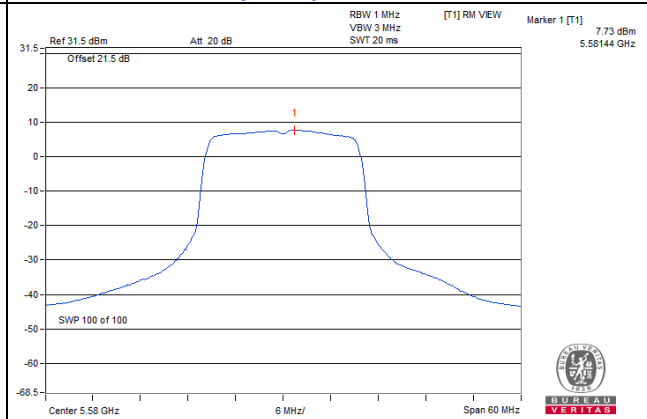

#### 802.11ax (HE40)\_Chain 0 / CH46

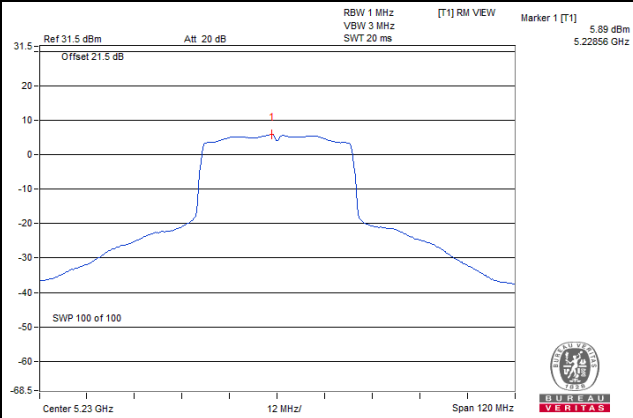

#### 802.11ax (HE80)\_Chain 0 / CH122

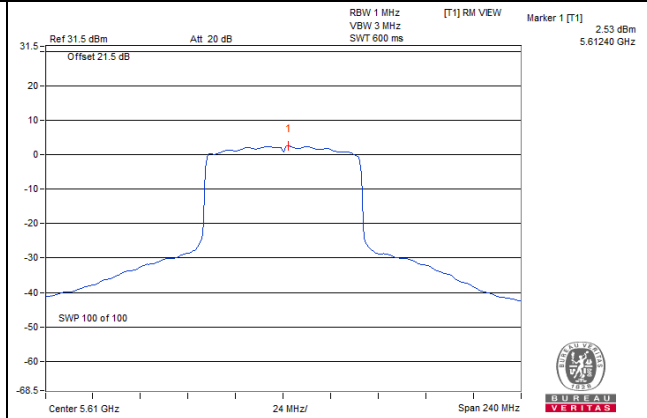

**For U-NII-3 band:**

**802.11a**

Chan.	Chan. Freq. (MHz)	PSD (dBm/300kHz)		Total PSD (dBm/300kHz)	Total PSD (dBm/500kHz)	PSD Limit (dBm/500kHz)	Pass / Fail
		Chain 0	Chain 1				
144 (U-NII-3 Band)	5720	3.65	3.40	6.54	8.76	29.05	Pass
149	5745	6.74	6.41	9.59	11.81	29.05	Pass
157	5785	6.40	5.76	9.1	11.32	29.05	Pass
165	5825	6.46	6.56	9.52	11.74	29.05	Pass

- Note: 1. Method b) Measure and sum spectral maxima across the outputs of KDB 662911 is using for calculating total power density.  
 2. The directional gain =  $10 \log[(10^{G0/20} + 10^{G1/20})^2 / 2]$  = 6.95dBi > 6dBi, so the power density limit shall be reduced to  $30 - (6.95 - 6) = 29.05$  dBm/MHz.

**802.11ax (HE20)**

Chan.	Chan. Freq. (MHz)	PSD (dBm/300kHz)		Total PSD (dBm/300kHz)	Total PSD (dBm/500kHz)	PSD Limit (dBm/500kHz)	Pass / Fail
		Chain 0	Chain 1				
144 (U-NII-3 Band)	5720	2.24	2.00	5.13	7.35	29.05	Pass
149	5745	5.96	5.35	8.68	10.90	29.05	Pass
157	5785	5.54	4.68	8.14	10.36	29.05	Pass
165	5825	5.81	5.53	8.68	10.90	29.05	Pass

- Note: 1. Method b) Measure and sum spectral maxima across the outputs of KDB 662911 is using for calculating total power density.  
 2. The directional gain =  $10 \log[(10^{G0/20} + 10^{G1/20})^2 / 2]$  = 6.95dBi > 6dBi, so the power density limit shall be reduced to  $30 - (6.95 - 6) = 29.05$  dBm/MHz.

**802.11ax (HE40)**

Chan.	Chan. Freq. (MHz)	PSD (dBm/300kHz)		Total PSD (dBm/300kHz)	Total PSD (dBm/500kHz)	PSD Limit (dBm/500kHz)	Pass / Fail
		Chain 0	Chain 1				
142 (U-NII-3 Band)	5710	-1.47	-1.95	1.31	3.53	29.05	Pass
151	5755	1.72	1.54	4.64	6.86	29.05	Pass
159	5795	3.19	2.60	5.92	8.14	29.05	Pass

- Note: 1. Method b) Measure and sum spectral maxima across the outputs of KDB 662911 is using for calculating total power density.  
 2. The directional gain =  $10 \log[(10^{G0/20} + 10^{G1/20})^2 / 2]$  = 6.95dBi > 6dBi, so the power density limit shall be reduced to  $30 - (6.95 - 6) = 29.05$  dBm/MHz.

### 802.11ax (HE80)

Chan.	Chan. Freq. (MHz)	PSD (dBm/300kHz)		Total PSD (dBm/300kHz)	Total PSD (dBm/500kHz)	PSD Limit (dBm/500kHz)	Pass / Fail
		Chain 0	Chain 1				
138 (U-NII-3 Band)	5710	-5.03	-5.34	-2.17	0.05	29.05	Pass
155	5755	-2.25	-2.67	0.56	2.78	29.05	Pass

Note: 1. Method b) Measure and sum spectral maxima across the outputs of KDB 662911 is using for calculating total power density.

2. The directional gain =  $10 \log[(10^{G0/20} + 10^{G1/20})^2 / 2] = 6.95\text{dBi} > 6\text{dBi}$ , so the power density limit shall be reduced to  $30 - (6.95 - 6) = 29.05 \text{ dBm/MHz}$ .

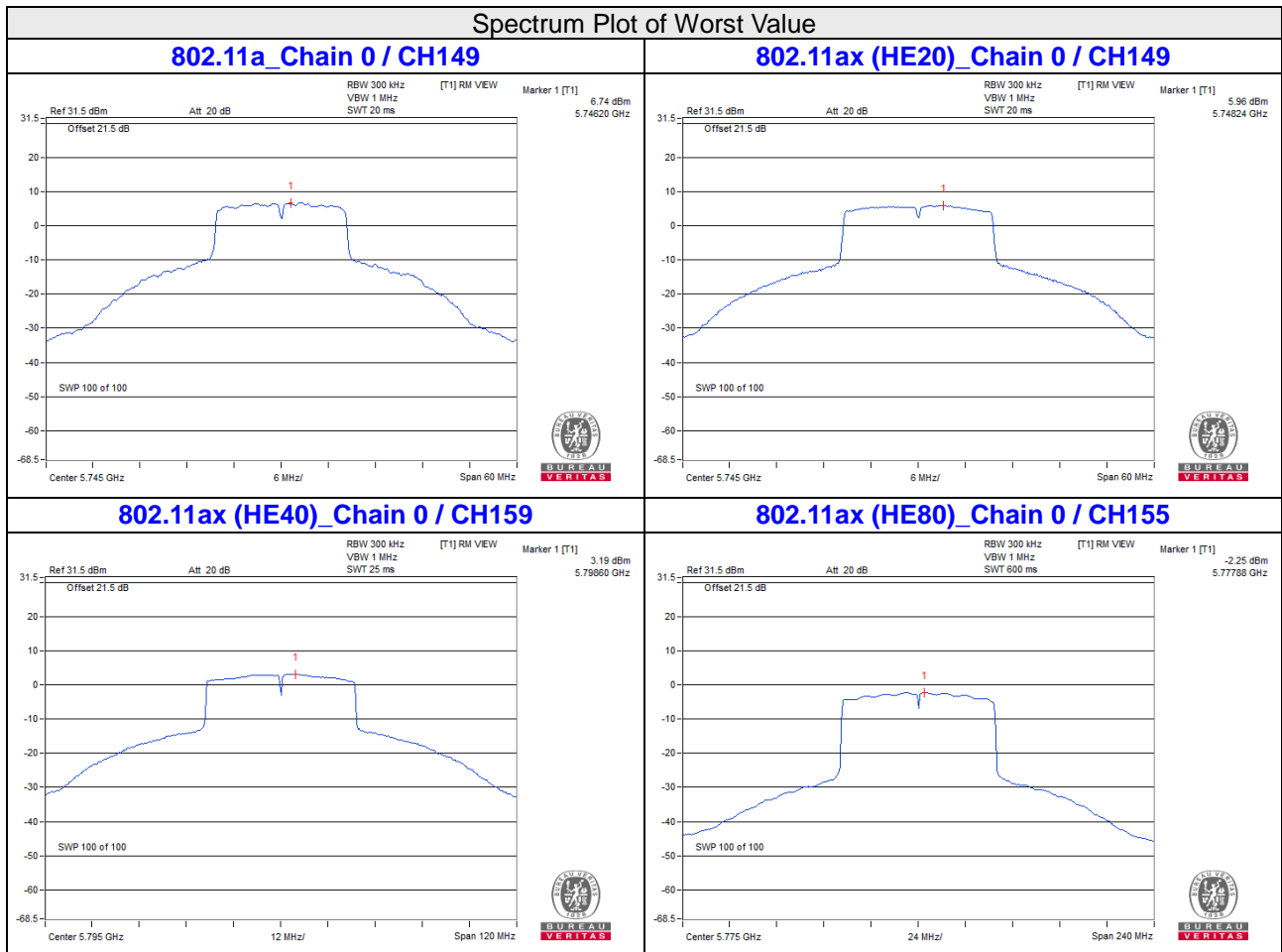

## 4.6 Frequency Stability Measurement

### 4.6.1 Limits of Frequency Stability Measurement

The frequency of the carrier signal shall be maintained within band of operation

### 4.6.2 Test Setup

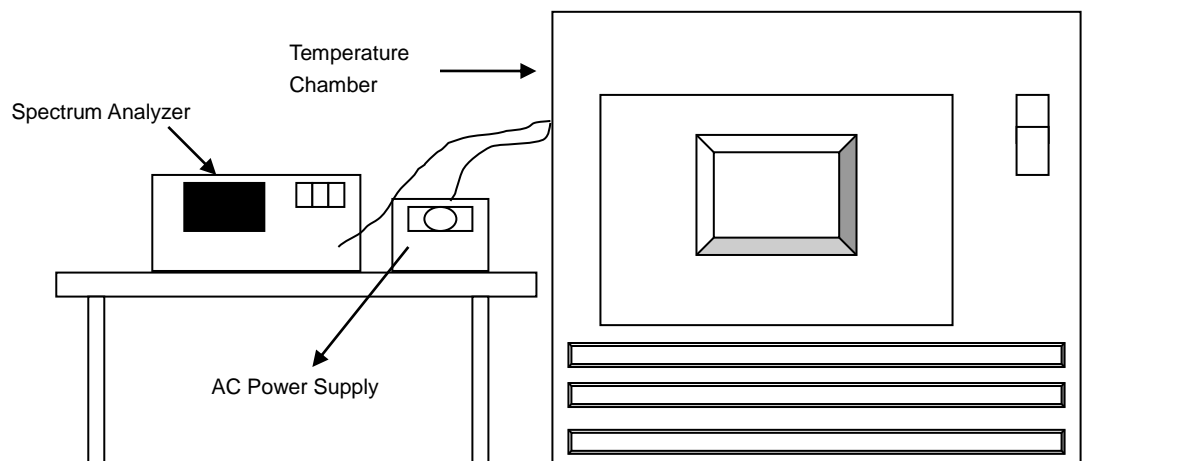

### 4.6.3 Test Instruments

Refer to section 4.1.2 to get information of above instrument.

### 4.6.4 Test Procedure

- The EUT was placed inside the environmental test chamber and powered by nominal AC voltage.
- Turn the EUT on and couple its output to a spectrum analyzer.
- Turn the EUT off and set the chamber to the highest temperature specified.
- Allow sufficient time (approximately 30 min) for the temperature of the chamber to stabilize, turn the EUT on and measure the operating frequency after 2, 5, and 10 Minutes.
- Repeat step (d) with the temperature chamber set to the next desired temperature until measurements down to the lowest specified temperature have been completed.
- The test chamber was allowed to stabilize at +20 degree C for a minimum of 30 Minutes. The supply voltage was then adjusted on the EUT from 85% to 115% and the frequency record.

### 4.6.5 Deviation from Test Standard

No deviation.

### 4.6.6 EUT Operating Condition

Set the EUT transmit at un-modulation mode to test frequency stability.

## 4.6.7 Test Results

Frequency Stability Versus Temp.									
Operating Frequency: 5180 MHz									
TEMP. (°C)	Power Supply (Vac)	0 Minute		2 Minutes		5 Minutes		10 Minutes	
		Measured Frequency (MHz)	Pass/Fail	Measured Frequency (MHz)	Pass/Fail	Measured Frequency (MHz)	Pass/Fail	Measured Frequency (MHz)	Pass/Fail
50	120	5179.9815	Pass	5179.9801	Pass	5179.9781	Pass	5179.9807	Pass
40	120	5179.9834	Pass	5179.9848	Pass	5179.9829	Pass	5179.9861	Pass
30	120	5180.0061	Pass	5180.0092	Pass	5180.0089	Pass	5180.0048	Pass
20	120	5180.0142	Pass	5180.0132	Pass	5180.0117	Pass	5180.0112	Pass
10	120	5180.0211	Pass	5180.022	Pass	5180.0212	Pass	5180.0218	Pass
0	120	5179.9819	Pass	5179.9785	Pass	5179.9778	Pass	5179.9815	Pass
-10	120	5179.9733	Pass	5179.9745	Pass	5179.9766	Pass	5179.9746	Pass
-20	120	5180.0094	Pass	5180.0074	Pass	5180.0072	Pass	5180.0079	Pass
-30	120	5180.0115	Pass	5180.0114	Pass	5180.0133	Pass	5180.0115	Pass

Frequency Stability Versus Voltage									
Operating Frequency: 5180 MHz									
TEMP. (°C)	Power Supply (Vac)	0 Minute		2 Minutes		5 Minutes		10 Minutes	
		Measured Frequency (MHz)	Pass/Fail	Measured Frequency (MHz)	Pass/Fail	Measured Frequency (MHz)	Pass/Fail	Measured Frequency (MHz)	Pass/Fail
20	138	5180.0179	Pass	5180.0222	Pass	5180.0184	Pass	5180.0178	Pass
	120	5180.0142	Pass	5180.0132	Pass	5180.0117	Pass	5180.0112	Pass
	102	5180.0172	Pass	5180.0191	Pass	5180.0179	Pass	5180.0143	Pass

## 4.7 6dB Bandwidth Measurement

### 4.7.1 Limits of 6dB Bandwidth Measurement

The minimum of 6dB Bandwidth Measurement is 0.5MHz.

### 4.7.2 Test Setup

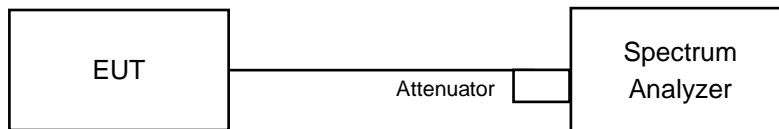

### 4.7.3 Test Instruments

Refer to section 4.1.2 to get information of above instrument.

### 4.7.4 Test Procedure

#### MEASUREMENT PROCEDURE REF

- Set resolution bandwidth (RBW) = 100kHz
- Set the video bandwidth (VBW)  $\geq 3 \times$  RBW, Detector = Peak.
- Trace mode = max hold.
- Sweep = auto couple.
- Measure the maximum width of the emission that is constrained by the frequencies associated with the two amplitude points (upper and lower) that are attenuated by 6 dB relative to the maximum level measured in the fundamental emission

### 4.7.5 Deviation from Test Standard

No deviation.

### 4.7.6 EUT Operating Condition

The software provided by client to enable the EUT under transmission condition continuously at lowest, middle and highest channel frequencies individually.

#### 4.7.7 Test Results

##### 802.11a

Channel	Frequency (MHz)	6dB Bandwidth (MHz)		Limit (MHz)	Pass / Fail
		Chain 0	Chain 1		
144 (U-NII-3 Band)	5720	2.58	2.85	0.5	Pass
149	5745	16.33	16.31	0.5	Pass
157	5785	16.37	15.66	0.5	Pass
165	5825	16.38	15.8	0.5	Pass

##### 802.11ax (HE20)

Channel	Frequency (MHz)	6dB Bandwidth (MHz)		Limit (MHz)	Pass / Fail
		Chain 0	Chain 1		
144 (U-NII-3 Band)	5720	3.91	3.98	0.5	Pass
149	5745	18.59	18.25	0.5	Pass
157	5785	18.77	18.27	0.5	Pass
165	5825	18.73	18.66	0.5	Pass

##### 802.11ax (HE40)

Channel	Frequency (MHz)	6dB Bandwidth (MHz)		Limit (MHz)	Pass / Fail
		Chain 0	Chain 1		
142 (U-NII-3 Band)	5710	3.49	3.62	0.5	Pass
151	5755	37.93	37.48	0.5	Pass
159	5795	37.95	37.46	0.5	Pass

##### 802.11ax (HE80)

Channel	Frequency (MHz)	6dB Bandwidth (MHz)		Limit (MHz)	Pass / Fail
		Chain 0	Chain 1		
138 (U-NII-3 Band)	5690	2.78	1.33	0.5	Pass
155	5775	76.76	75.45	0.5	Pass



### Spectrum Plot of Worst Value

#### 802.11a\_Chain 0 / CH144 (U-NII-3 Band)

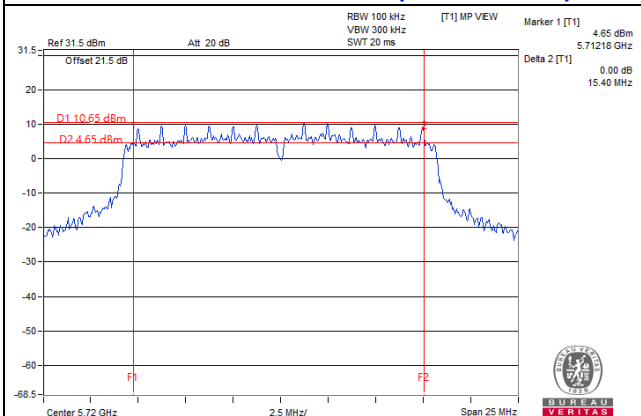

#### 802.11ax (HE20)\_Chain 0 / CH144 (U-NII-3 Band)

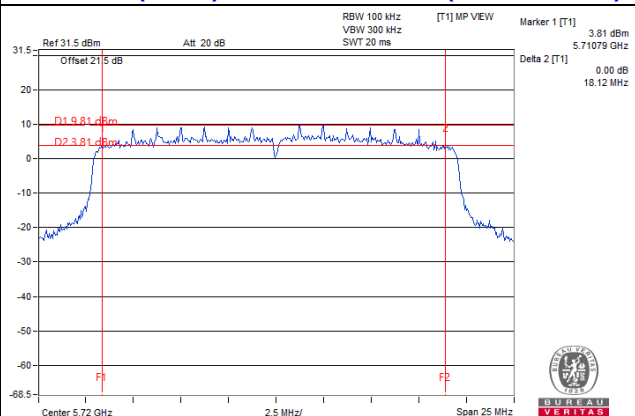

#### 802.11ax (HE40)\_Chain 0 / CH142 (U-NII-3 Band)

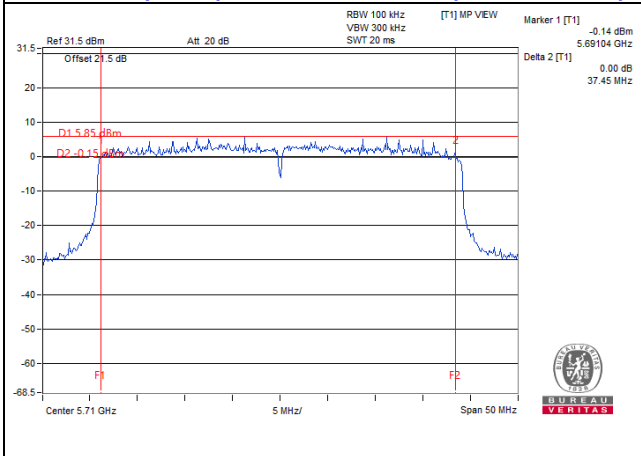

#### 802.11ax (HE80)\_Chain 1 / CH138 (U-NII-3 Band)

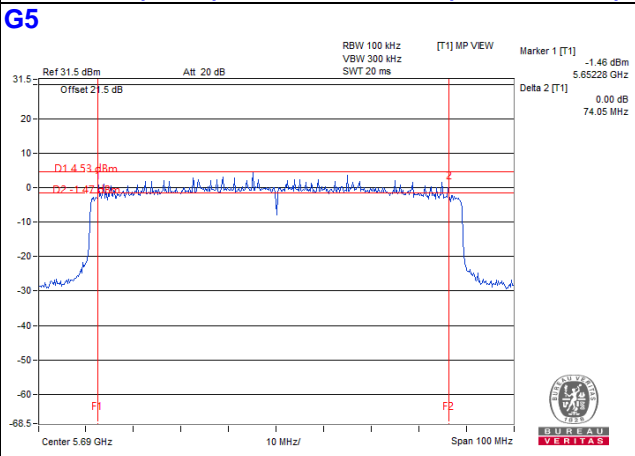

Note: The 6dB bandwidth above 5725MHz = Marker 1 + Delta 2 - 5725MHz

## 5 Pictures of Test Arrangements

Please refer to the attached file (Test Setup Photo).

### Annex A - Radiated Out of Band Emission (OOBE) Measurement (For U-NII-3 band)

#### 802.11a CH 149 : 5.745 GHz

Horizontal

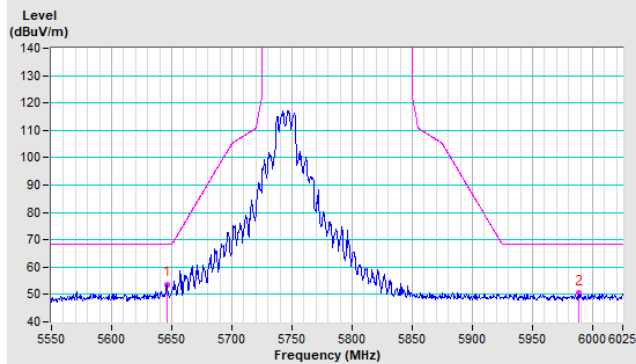

Vertical

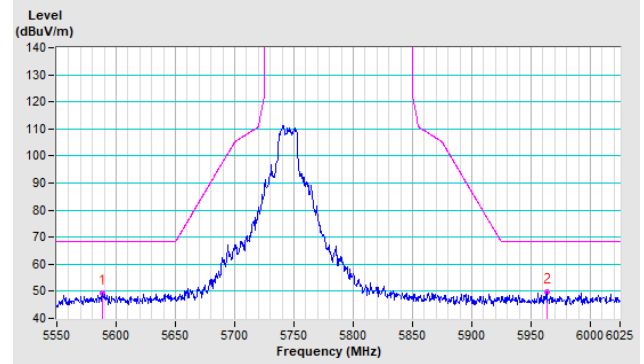

#### 802.11a CH 157 : 5.785 GHz

Horizontal

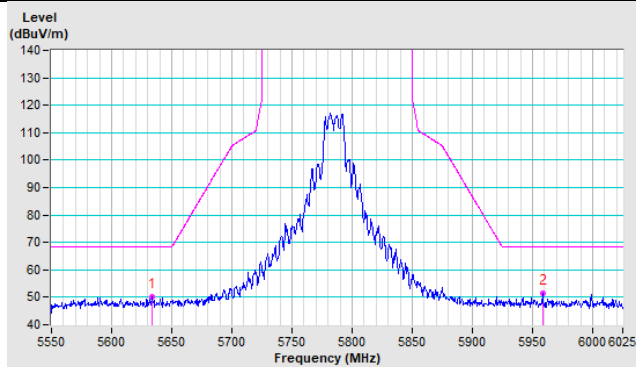

Vertical

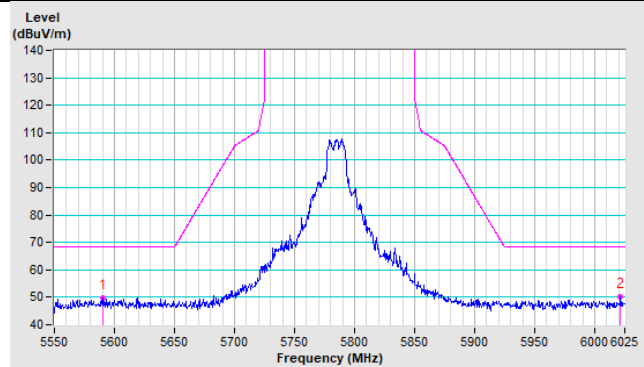

#### 802.11a CH 165 : 5.825 GHz

Horizontal

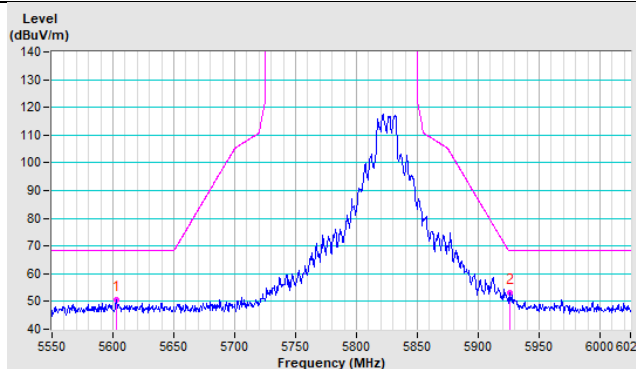

Vertical

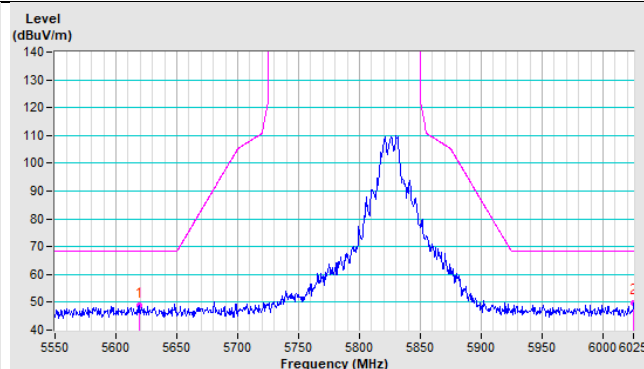

### 802.11ax (HE20) CH 149 : 5.745 GHz

Horizontal

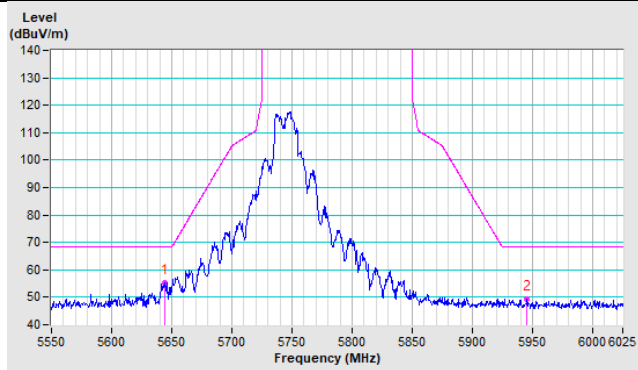

Vertical

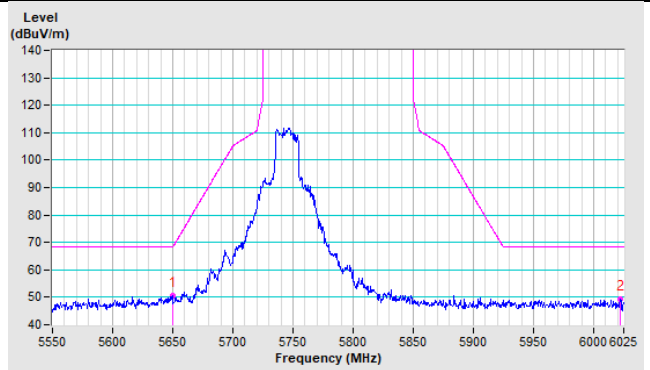

### 802.11ax (HE20) CH 157 : 5.785 GHz

Horizontal

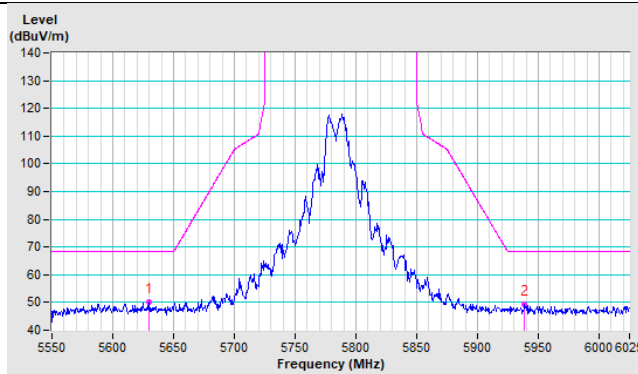

Vertical

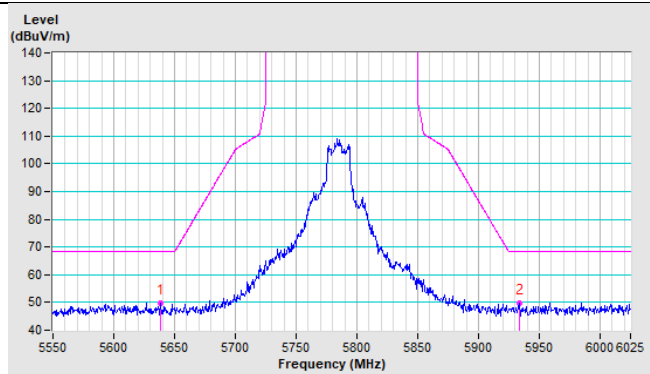

### 802.11ax (HE20) CH 165 : 5.825 GHz

Horizontal

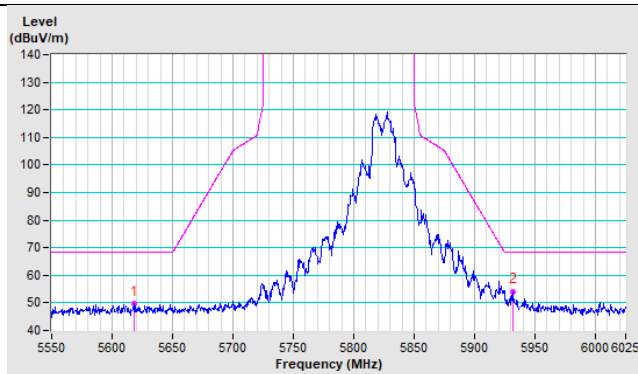

Vertical

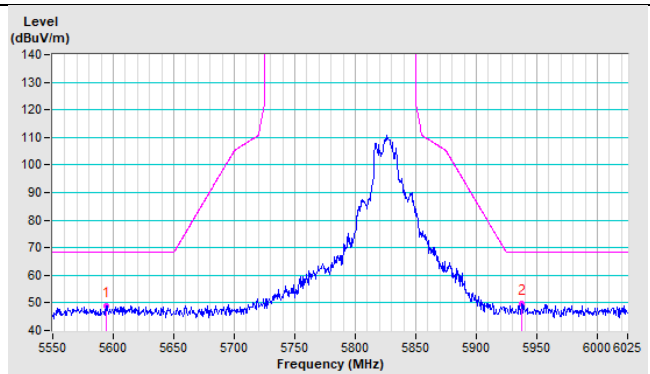

### 802.11ax (HE40) CH 151 : 5.755 GHz

Horizontal

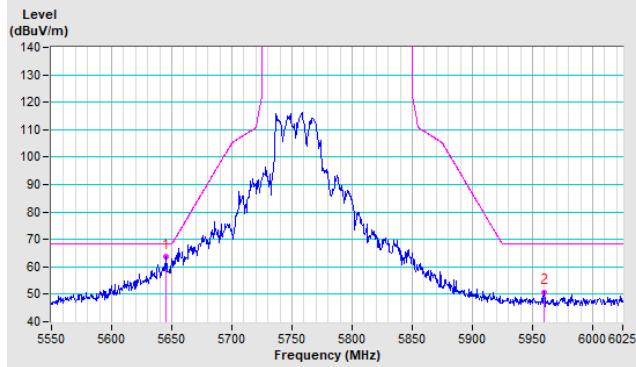

Vertical

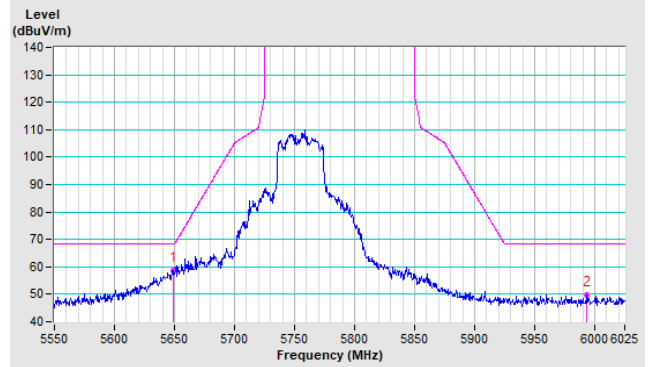

### 802.11ax (HE40) CH 159 : 5.795 GHz

Horizontal

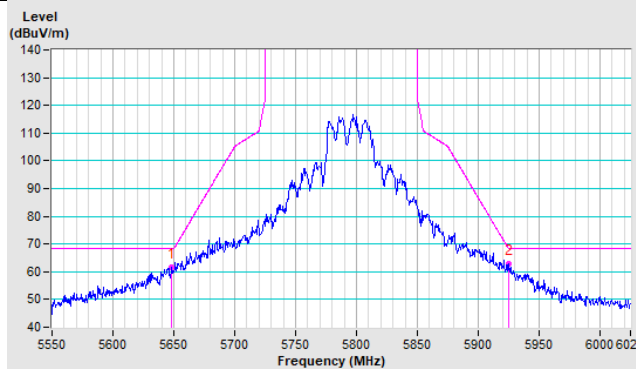

Vertical

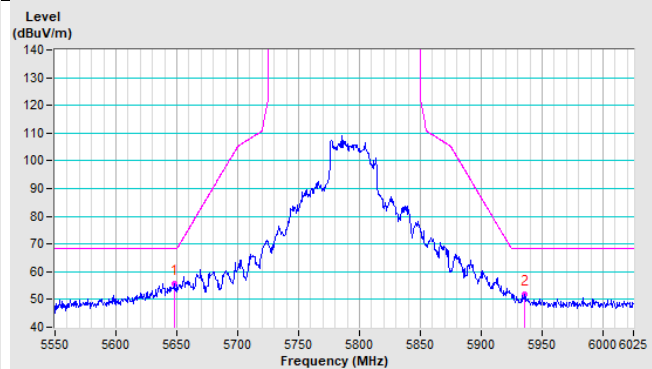

### 802.11ax (HE80) CH 155 : 5.775 GHz

Horizontal

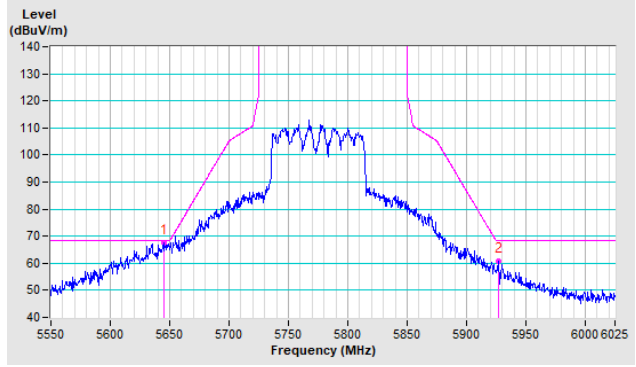

Vertical

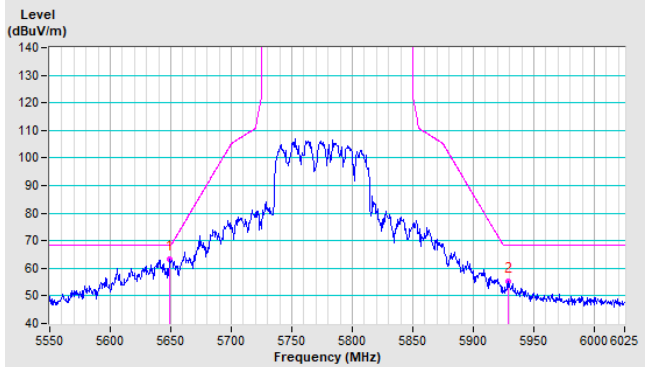

### Annex B - Band-Edge Measurement (For U-NII-1, U-NII-2A, U-NII-2C band)

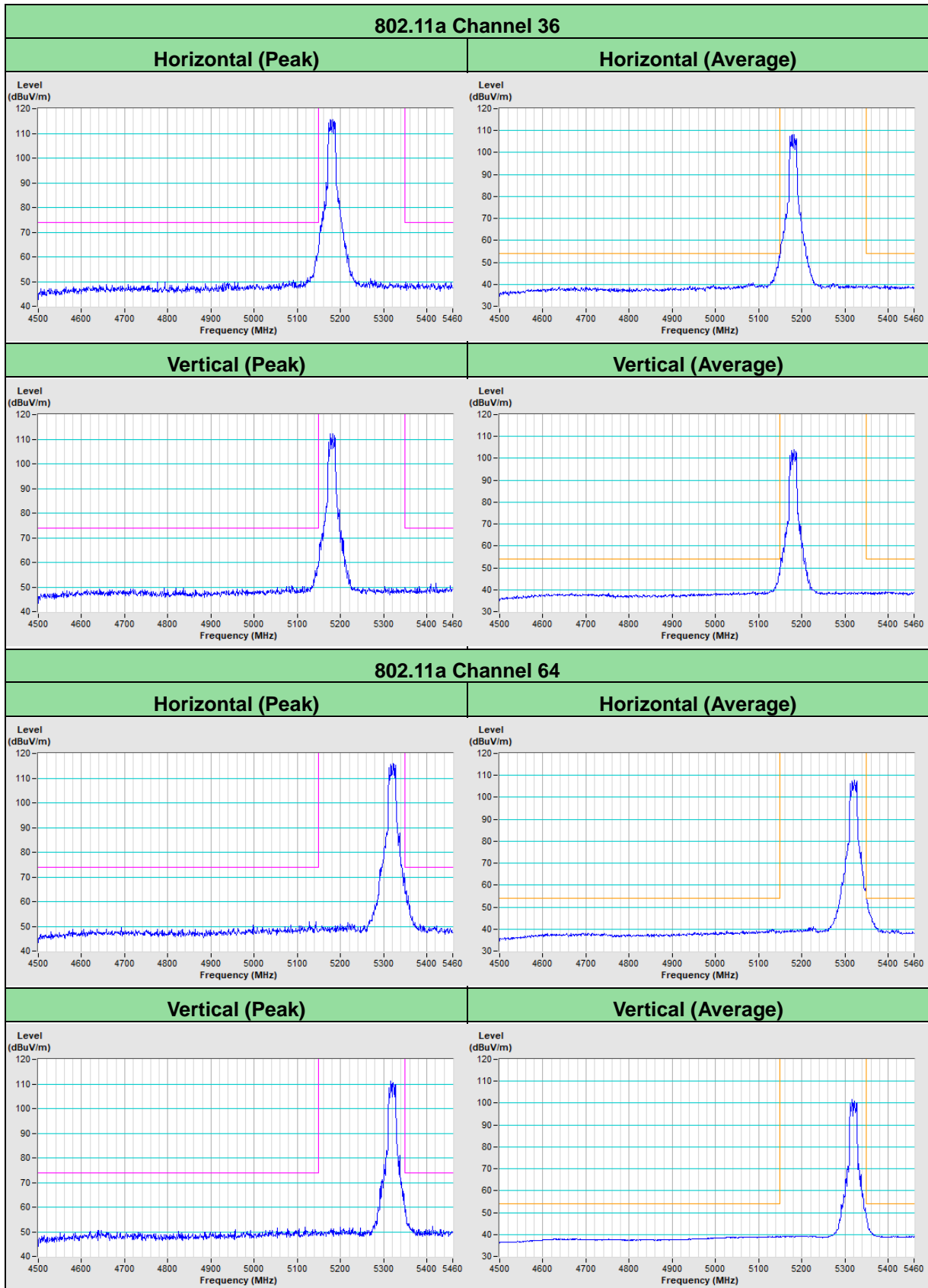

### 802.11a Channel 100

#### Horizontal (Peak)

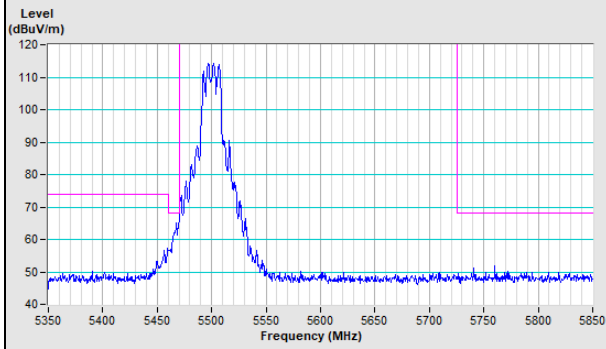

#### Horizontal (Average)

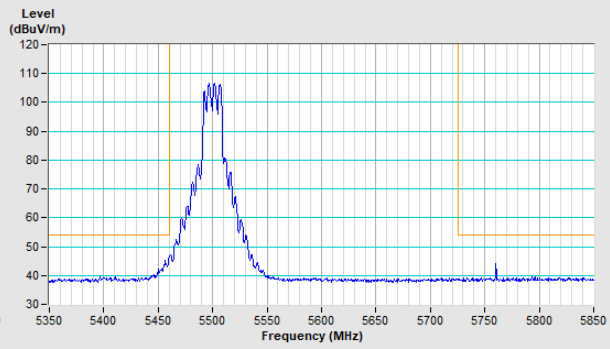

#### Vertical (Peak)

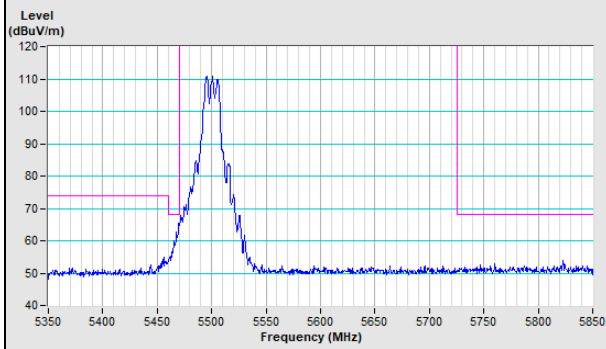

#### Vertical (Average)

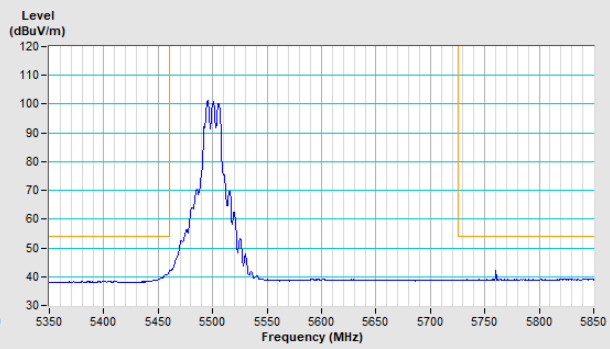

### 802.11ax (HE20) Channel 36

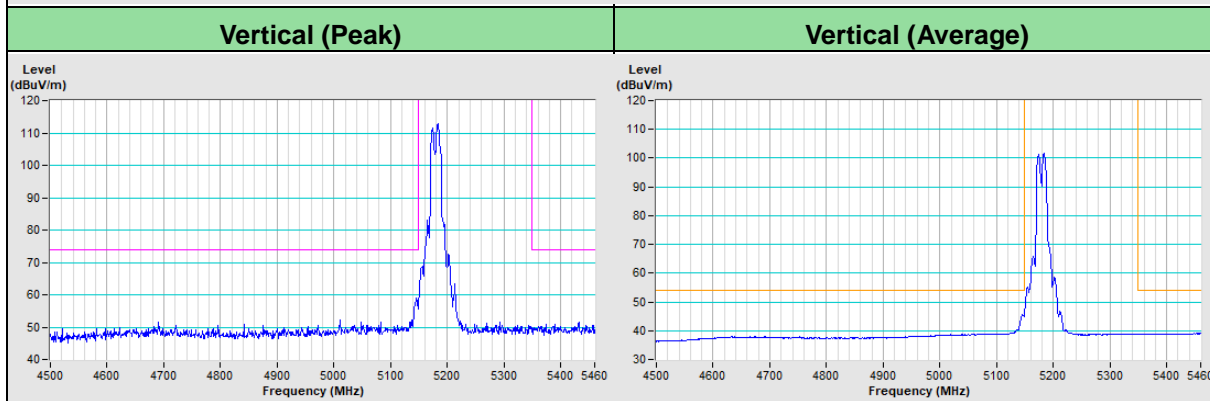
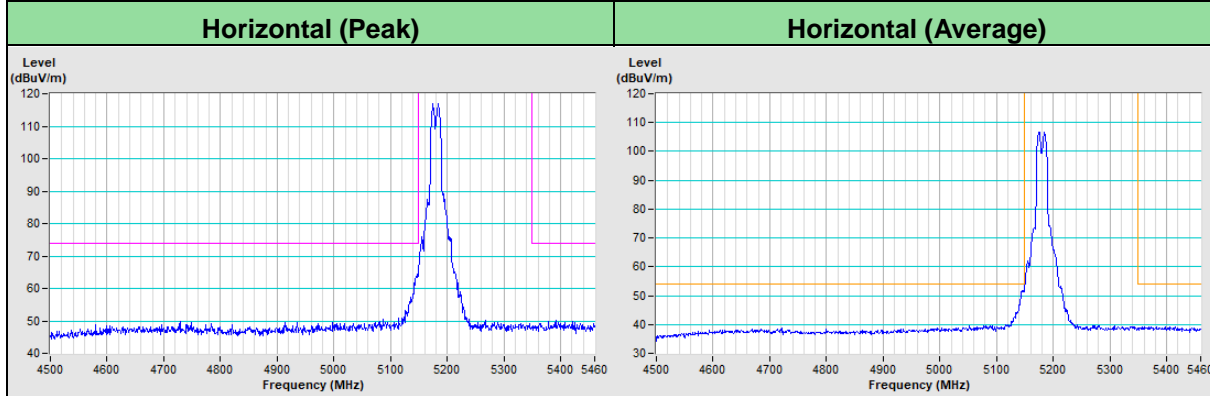

### 802.11ax (HE20) Channel 64

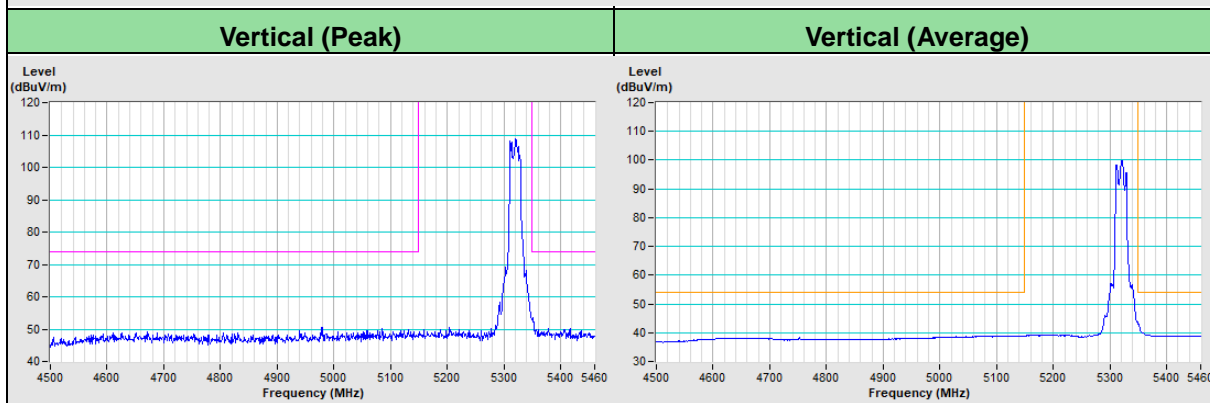
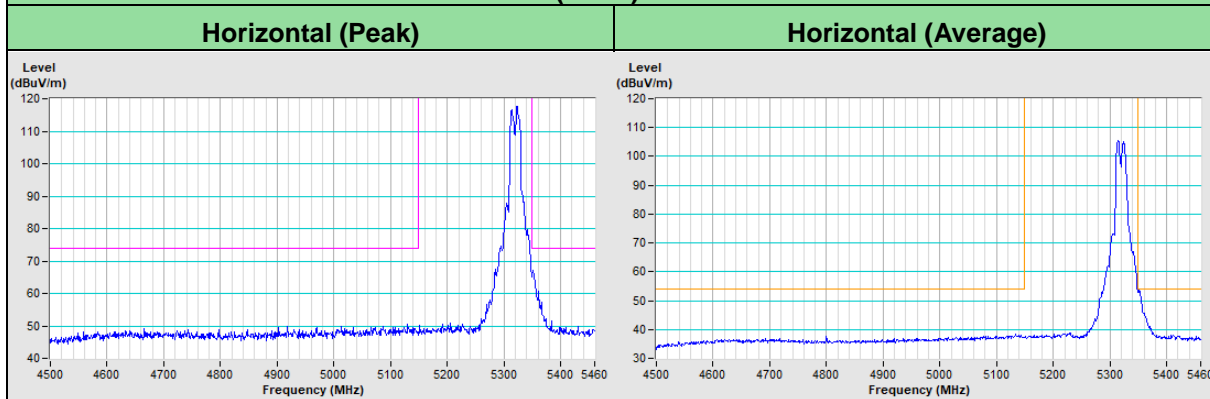



### 802.11ax (HE20) Channel 100

**Horizontal (Peak)**

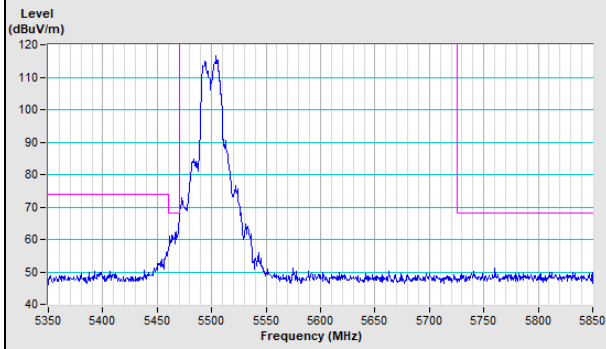

**Horizontal (Average)**

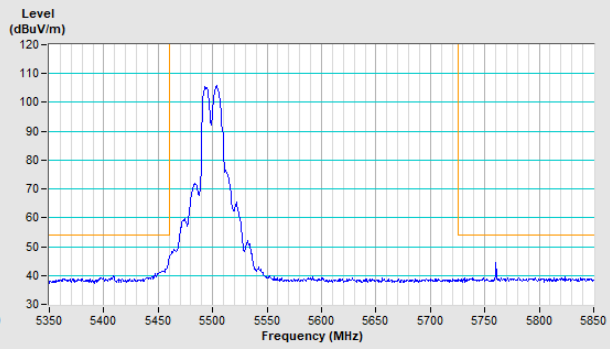

**Vertical (Peak)**

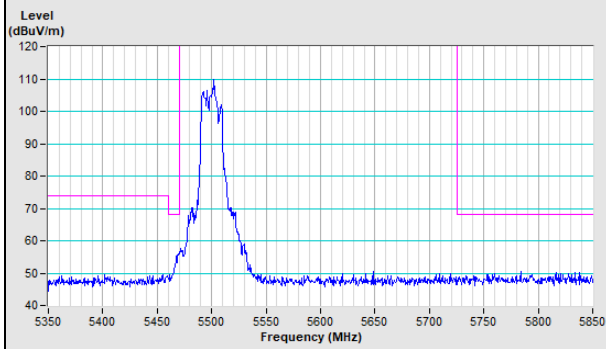

**Vertical (Average)**

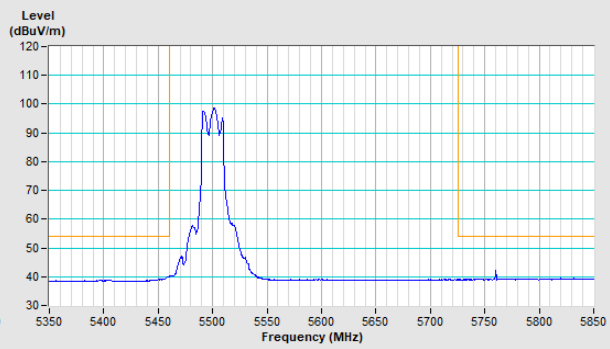

### 802.11ax (HE40) Channel 38

Horizontal (Peak)	Horizontal (Average)
-------------------	----------------------

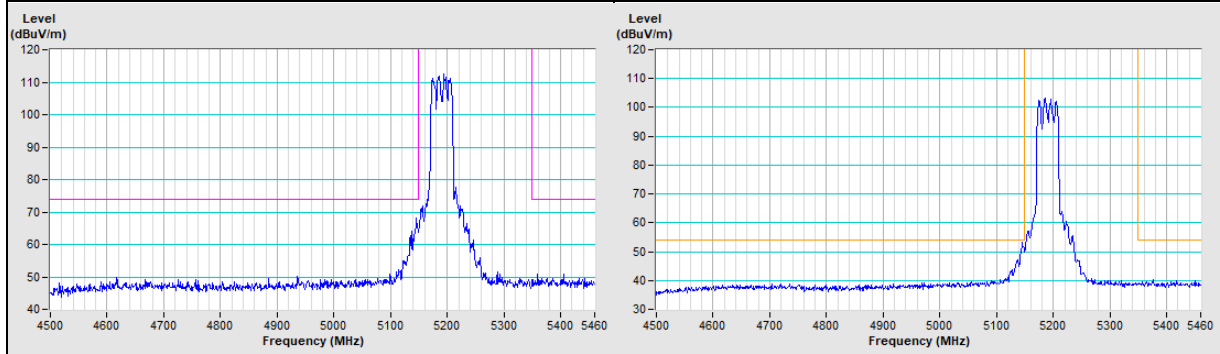

Vertical (Peak)	Vertical (Average)
-----------------	--------------------

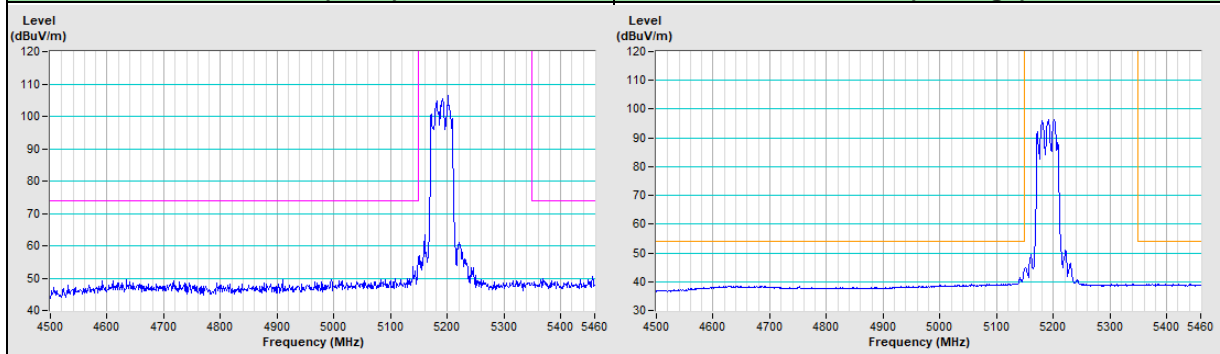

### 802.11ax (HE40) Channel 62

Horizontal (Peak)	Horizontal (Average)
-------------------	----------------------

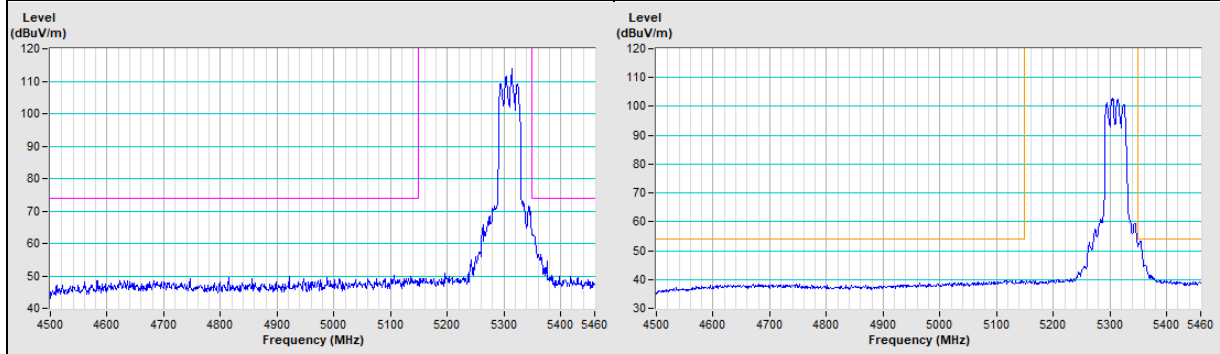

Vertical (Peak)	Vertical (Average)
-----------------	--------------------

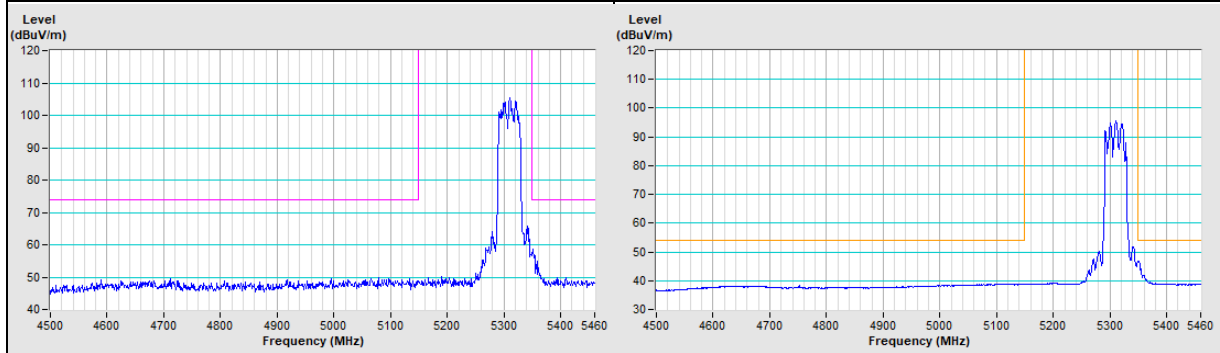

### 802.11ax (HE40) Channel 102

#### Horizontal (Peak)

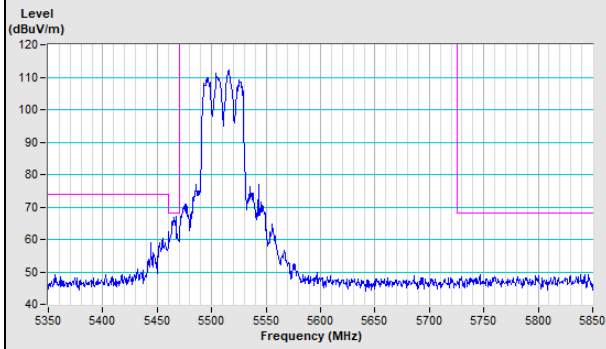

#### Horizontal (Average)

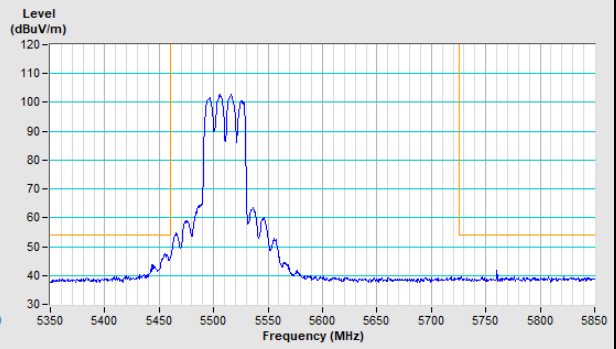

#### Vertical (Peak)

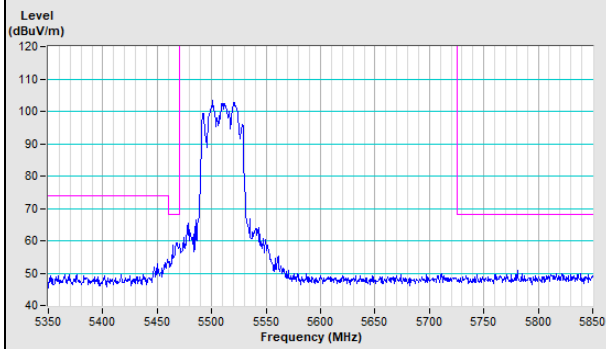

#### Vertical (Average)

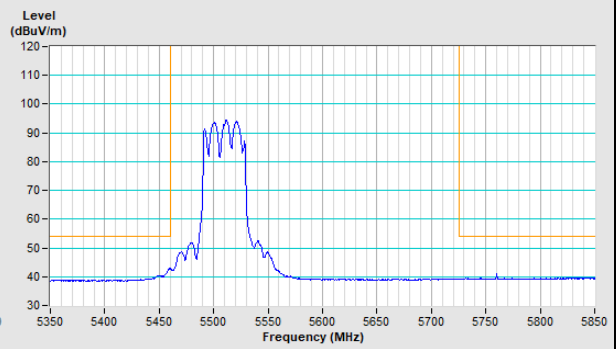

### 802.11ax (HE80) Channel 42

Horizontal (Peak)	Horizontal (Average)
-------------------	----------------------

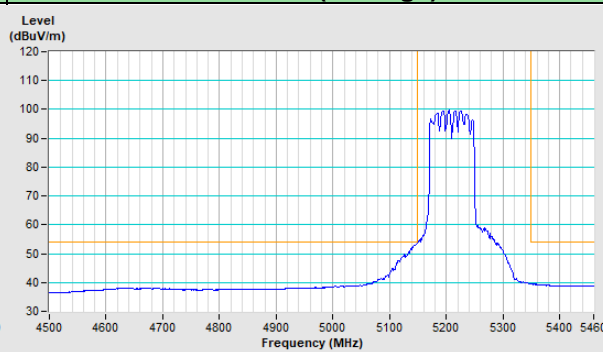
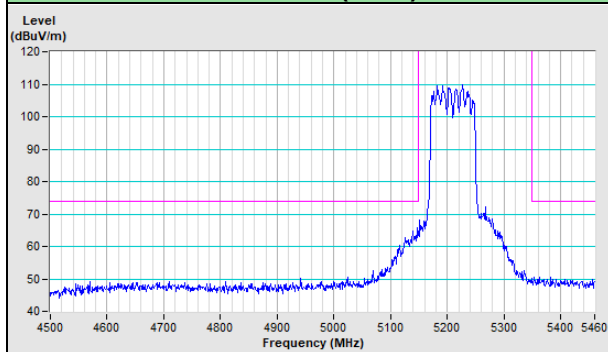

Vertical (Peak)	Vertical (Average)
-----------------	--------------------

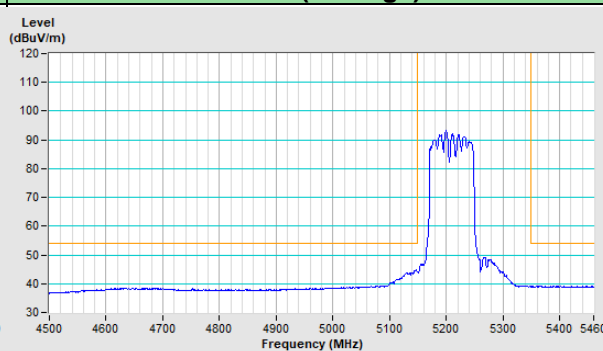
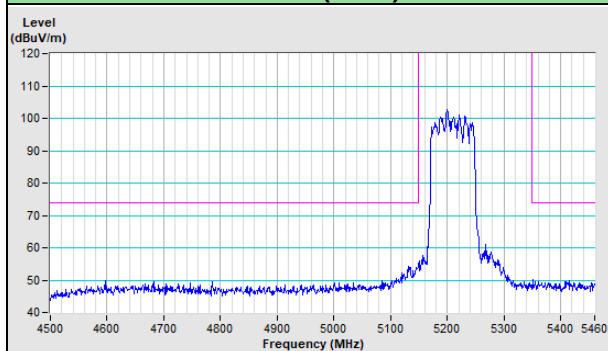

### 802.11ax (HE80) Channel 58

Horizontal (Peak)	Horizontal (Average)
-------------------	----------------------

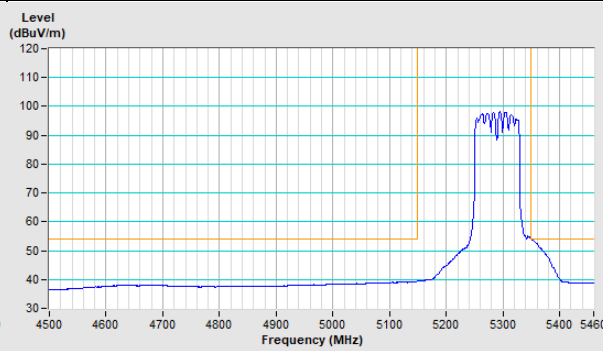
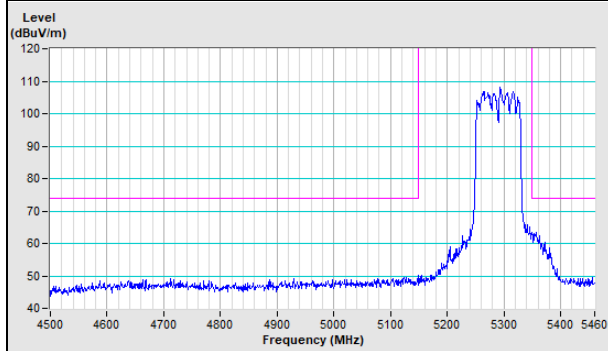

Vertical (Peak)	Vertical (Average)
-----------------	--------------------

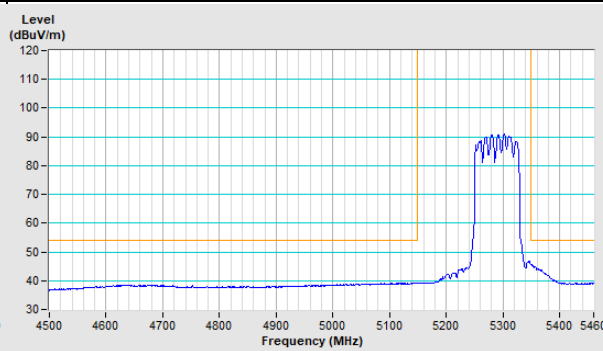
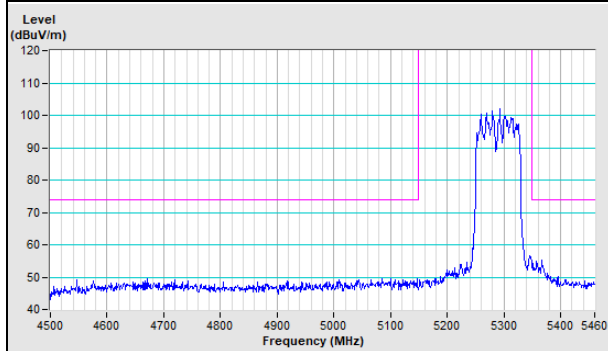

### 802.11ax (HE80) Channel 106

**Horizontal (Peak)**

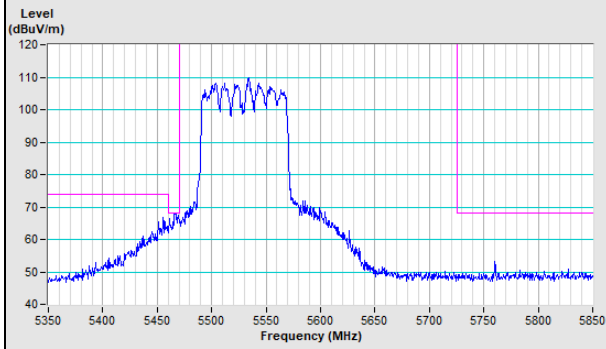

**Horizontal (Average)**

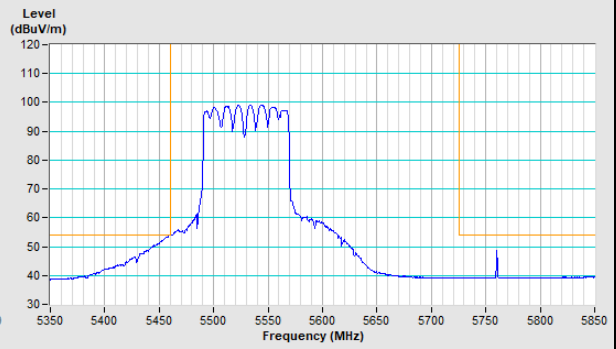

**Vertical (Peak)**

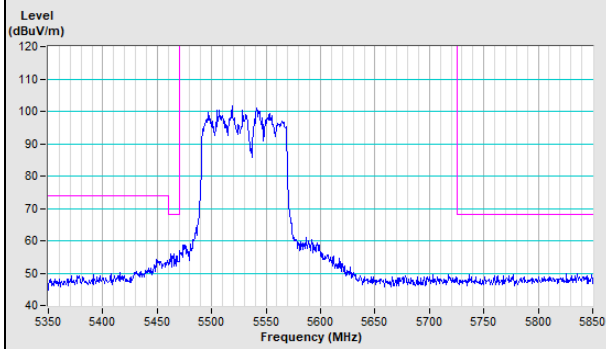

**Vertical (Average)**

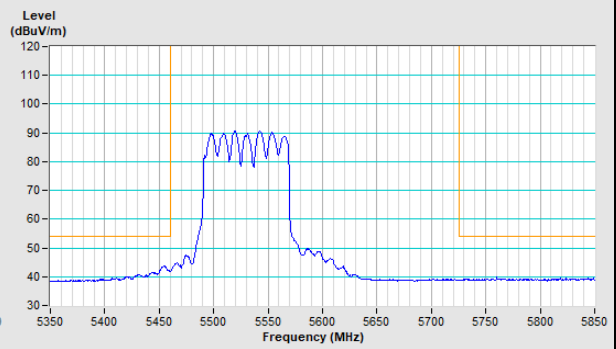

## Appendix – Information of the Testing Laboratories

We, Bureau Veritas Consumer Products Services (H.K.) Ltd., Taoyuan Branch, were founded in 1988 to provide our best service in EMC, Radio, Telecom and Safety consultation. Our laboratories are FCC recognized accredited test firms and accredited according to ISO/IEC 17025.

If you have any comments, please feel free to contact us at the following:

**Lin Kou EMC/RF Lab**

Tel: 886-2-26052180

Fax: 886-2-26051924

**Hsin Chu EMC/RF/Telecom Lab**

Tel: 886-3-6668565

Fax: 886-3-6668323

**Hwa Ya EMC/RF/Safety Lab**

Tel: 886-3-3183232

Fax: 886-3-3270892

**Email:** [service.adt@tw.bureauveritas.com](mailto:service.adt@tw.bureauveritas.com)

**Web Site:** [www.bureauveritas-adt.com](http://www.bureauveritas-adt.com)

The address and road map of all our labs can be found in our web site also.

--- END ---