

FCC Test Report (WLAN)

Report No.: RF190603E08A-1

FCC ID: NKR-VZJS8V

Test Model: JS8V

Received Date: June 12, 2019

Test Date: June 21 to July 02, 2019

Issued Date: July 19, 2019

Applicant: Wistron NeWeb Corp.

Address: 20 Park Avenue II, Hsinchu Science Park, Hsinchu 308, Taiwan, R.O.C.

Issued By: Bureau Veritas Consumer Products Services (H.K.) Ltd., Taoyuan Branch
Hsin Chu Laboratory

Lab Address: E-2, No.1, Li Hsin 1st Road, Hsinchu Science Park, Hsinchu City 300,
Taiwan R.O.C.

Test Location: E-2, No.1, Li Hsin 1st Road, Hsinchu Science Park, Hsinchu City 300,
Taiwan R.O.C.

**FCC Registration /
Designation Number:** 723255 / TW2022



This report is for your exclusive use. Any copying or replication of this report to or for any other person or entity, or use of our name or trademark, is permitted only with our prior written permission. This report sets forth our findings solely with respect to the test samples identified herein. The results set forth in this report are not indicative or representative of the quality or characteristics of the lot from which a test sample was taken or any similar or identical product unless specifically and expressly noted. Our report includes all of the tests requested by you and the results thereof based upon the information that you provided to us. You have 60 days from date of issuance of this report to notify us of any material error or omission caused by our negligence, provided, however, that such notice shall be in writing and shall specifically address the issue you wish to raise. A failure to raise such issue within the prescribed time shall constitute your unqualified acceptance of the completeness of this report, the tests conducted and the correctness of the report contents. Unless specific mention, the uncertainty of measurement has been explicitly taken into account to declare the compliance or non-compliance to the specification. The report must not be used by the client to claim product certification, approval, or endorsement by TAF or any government agencies.

Table of Contents

Release Control Record	4
1 Certificate of Conformity	5
2 Summary of Test Results	6
2.1 Measurement Uncertainty	6
2.2 Modification Record	6
3 General Information	7
3.1 General Description of EUT	7
3.2 Description of Test Modes	9
3.2.1 Test Mode Applicability and Tested Channel Detail	11
3.3 Duty Cycle of Test Signal	13
3.4 Description of Support Units	14
3.4.1 Configuration of System under Test	14
3.5 General Description of Applied Standard	15
4 Test Types and Results	16
4.1 Radiated Emission and Bandedge Measurement	16
4.1.1 Limits of Radiated Emission and Bandedge Measurement	16
4.1.2 Test Instruments	17
4.1.3 Test Procedure	19
4.1.4 Deviation from Test Standard	19
4.1.5 Test Setup	20
4.1.6 EUT Operating Condition	21
4.1.7 Test Results	22
4.2 Conducted Emission Measurement	66
4.2.1 Limits of Conducted Emission Measurement	66
4.2.2 Test Instruments	66
4.2.3 Test Procedure	67
4.2.4 Deviation from Test Standard	67
4.2.5 Test Setup	67
4.2.6 EUT Operating Condition	67
4.2.7 Test Results	68
4.3 Transmit Power Measurement	70
4.3.1 Limits of Transmit Power Measurement	70
4.3.2 Test Setup	70
4.3.3 Test Instruments	71
4.3.4 Test Procedure	71
4.3.5 Deviation from Test Standard	71
4.3.6 EUT Operating Condition	71
4.3.7 Test Results	72
4.4 Occupied Bandwidth Measurement	80
4.4.1 Test Setup	80
4.4.2 Test Instruments	80
4.4.3 Test Procedure	80
4.4.4 Test Results	81
4.5 Peak Power Spectral Density Measurement	86
4.5.1 Limits of Peak Power Spectral Density Measurement	86
4.5.2 Test Setup	86
4.5.3 Test Instruments	86
4.5.4 Test Procedure	86
4.5.5 Deviation from Test Standard	87
4.5.6 EUT Operating Condition	87
4.5.7 Test Results	88
4.6 Frequency Stability Measurement	95
4.6.1 Limits of Frequency Stability Measurement	95

4.6.2	Test Setup.....	95
4.6.3	Test Instruments	95
4.6.4	Test Procedure	95
4.6.5	Deviation from Test Standard	95
4.6.6	EUT Operating Condition	95
4.6.7	Test Results	96
4.7	6dB Bandwidth Measurement	97
4.7.1	Limits of 6dB Bandwidth Measurement.....	97
4.7.2	Test Setup.....	97
4.7.3	Test Instruments	97
4.7.4	Test Procedure	97
4.7.5	Deviation from Test Standard	97
4.7.6	EUT Operating Condition	97
4.7.7	Test Results	98
5	Pictures of Test Arrangements.....	100
	Annex A- Radiated Out of Band Emission (OOBE) Measurement (For U-NII-3 band).....	101
	Appendix – Information of the Testing Laboratories	104

Release Control Record

Issue No.	Description	Date Issued
RF190603E08A-1	Original release.	July 19, 2019

1 Certificate of Conformity

Product: Stream TV

Brand: Verizon

Test Model: JS8V

Sample Status: ENGINEERING SAMPLE

Applicant: Wistron NeWeb Corp.

Test Date: June 21 to July 02, 2019

Standard: 47 CFR FCC Part 15, Subpart E (Section 15.407)
ANSI C63.10: 2013

The above equipment has been tested by **Bureau Veritas Consumer Products Services (H.K.) Ltd., Taoyuan Branch**, and found compliance with the requirement of the above standards. The test record, data evaluation & Equipment Under Test (EUT) configurations represented herein are true and accurate accounts of the measurements of the sample's EMC characteristics under the conditions specified in this report.

Prepared by : Wendy Wu , **Date:** July 19, 2019
Wendy Wu / Specialist

Approved by : Mzy Chen , **Date:** July 19, 2019
Mzy Chen / Manager

2 Summary of Test Results

47 CFR FCC Part 15, Subpart E (Section 15.407)			
FCC Clause	Test Item	Result	Remarks
15.407(b)(6)	AC Power Conducted Emissions	Pass	Meet the requirement of limit. Minimum passing margin is -17.85dB at 0.44297MHz.
15.407(b) (1/2/3/4(i/ii)/6)	Radiated Emissions & Band Edge Measurement*	Pass	Meet the requirement of limit. Minimum passing margin is -0.1dB at 5150.00MHz.
15.407(a)(1/2/3)	Max Average Transmit Power	Pass	Meet the requirement of limit.
---	Occupied Bandwidth Measurement	-	Reference only.
15.407(a)(1/2/3)	Peak Power Spectral Density	Pass	Meet the requirement of limit.
15.407(e)	6dB bandwidth	Pass	Meet the requirement of limit. (U-NII-3 Band only)
15.407(g)	Frequency Stability	Pass	Meet the requirement of limit.
15.203	Antenna Requirement	Pass	No antenna connector is used.

*For U-NII-3 band compliance with rule part 15.407(b)(4)(i), the OOB test plots were recorded in Annex A.

Note:

Determining compliance based on the results of the compliance measurement, not taking into account measurement instrumentation uncertainty.

2.1 Measurement Uncertainty

Where relevant, the following measurement uncertainty levels have been estimated for tests performed on the EUT as specified in CISPR 16-4-2:

Measurement	Frequency	Expanded Uncertainty (k=2) (±)
Conducted Emissions at mains ports	150kHz ~ 30MHz	1.8 dB
Radiated Emissions up to 1 GHz	30MHz ~ 1GHz	5.1 dB
Radiated Emissions above 1 GHz	1GHz ~ 6GHz	5.1 dB
	6GHz ~ 18GHz	5.0 dB
	18GHz ~ 40GHz	5.2 dB

2.2 Modification Record

There were no modifications required for compliance.

3 General Information

3.1 General Description of EUT

Product	Stream TV
Brand	Verizon
Test Model	JS8V
Status of EUT	ENGINEERING SAMPLE
Power Supply Rating	12Vdc from power adapter
Modulation Type	CCK, DQPSK, DBPSK for DSSS 64QAM, 16QAM, QPSK, BPSK for OFDM 256QAM for OFDM in 11ac mode and VHT (20/40) mode in 2.4GHz
Modulation Technology	DSSS, OFDM
Transfer Rate	802.11b: up to 11Mbps 802.11a/g: up to 54Mbps 802.11n: up to 300Mbps 802.11ac: up to 866.7Mbps
Operating Frequency	2.4GHz: 2.412 ~ 2.462GHz 5GHz: 5.18~ 5.24GHz, 5.26GHz ~ 5.32GHz, 5.50GHz ~ 5.72GHz, 5.745 ~ 5.825GHz
Number of Channel	2.4GHz: 802.11b, 802.11g, 802.11n (HT20), VHT20: 11 802.11n (HT40), VHT40: 7 5GHz: 802.11a, 802.11n (HT20), 802.11ac (VHT20): 25 802.11n (HT40), 802.11ac (VHT40): 12 802.11ac (VHT80): 6
Output Power	2.4GHz: 662.658 mW 5.18 ~ 5.24GHz: 247.256 mW 5.26 ~ 5.32GHz: 216.553 mW 5.5 ~ 5.72GHz: 210.929 mW 5.745 ~ 5.825GHz: 424.896 mW
Antenna Type	Refer to Note
Antenna Connector	Refer to Note
Accessory Device	Adapter x1 Remote controller x 1 (Brand: Verizon, Model: RC3441530/01BR)
Cable Supplied	HDMI cable x 1 (Shielded, 1.2m)

Note:

1. Simultaneously transmission condition.

Condition	Technology	
1	WLAN 2.4GHz	Bluetooth
2	WLAN 5GHz	Bluetooth

Note: The emission of the simultaneous operation has been evaluated and no non-compliance was found.

2. The EUT needs to be supplied from power adapter, the information is as below table:

Brand	Model No.	Spec.
Frecom	F12L33-120100SPAU	Input: 100-240Vac, 0.3A, 50/60Hz Output: 12V, 1A DC Output cable: Unshielded, 1.5m

3. The antennas provided to the EUT, please refer to the following table:

WLAN				
Chain No.	Antenna Net Gain (dBi)	Frequency range (GHz)	Antenna type	Connector type
Chain 0	3.62	2.4~2.4835	On board printed antenna	none
	3.57	5.15~5.25		
	3.63	5.25~5.35		
	2.50	5.47~5.725		
	2.88	5.725~5.85		
Chain 1	5.36	2.4~2.4835	On board printed antenna	none
	3.26	5.15~5.25		
	3.26	5.25~5.35		
	3.75	5.47~5.725		
	4.22	5.725~5.85		
Bluetooth				
Antenna Net Gain (dBi)	Frequency range (GHz)	Antenna type	Connector type	
2.39	2.4~2.4835	On board printed antenna	none	

4. The EUT incorporates a MIMO function.

2.4GHz Band		
MODULATION MODE	TX & RX CONFIGURATION	
802.11b	2TX	2RX
802.11g	2TX	2RX
802.11n (HT20)	2TX	2RX
802.11n (HT40)	2TX	2RX
VHT20	2TX	2RX
VHT40	2TX	2RX
5GHz Band		
MODULATION MODE	TX & RX CONFIGURATION	
802.11a	2TX	2RX
802.11n (HT20)	2TX	2RX
802.11n (HT40)	2TX	2RX
802.11ac (VHT20)	2TX	2RX
802.11ac (VHT40)	2TX	2RX
802.11ac (VHT80)	2TX	2RX

Note: The modulation and bandwidth are similar for 802.11n mode for 20MHz (40MHz) and 802.11ac mode for 20MHz (40MHz), therefore investigated worst case to representative mode in test report.

5. The above EUT information is declared by manufacturer and for more detailed features description, please refers to the manufacturer's specifications or user's manual.

3.2 Description of Test Modes

FOR 5180 ~ 5240MHz

4 channels are provided for 802.11a, 802.11n (HT20), 802.11ac (VHT20):

Channel	Frequency	Channel	Frequency
36	5180 MHz	44	5220 MHz
40	5200 MHz	48	5240 MHz

2 channels are provided for 802.11n (HT40), 802.11ac (VHT40):

Channel	Frequency	Channel	Frequency
38	5190 MHz	46	5230 MHz

1 channel is provided for 802.11ac (VHT80):

Channel	Frequency
42	5210 MHz

FOR 5260 ~ 5320MHz

4 channels are provided for 802.11a, 802.11n (HT20), 802.11ac (VHT20):

Channel	Frequency	Channel	Frequency
52	5260 MHz	60	5300 MHz
56	5280 MHz	64	5320 MHz

2 channels are provided for 802.11n (HT40), 802.11ac (VHT40):

Channel	Frequency	Channel	Frequency
54	5270 MHz	62	5310 MHz

1 channel is provided for 802.11ac (VHT80):

Channel	Frequency
58	5290 MHz

FOR 5500 ~ 5720MHz

12 channels are provided for 802.11a, 802.11n (HT20), 802.11ac (VHT20):

Channel	Frequency	Channel	Frequency
100	5500 MHz	124	5620 MHz
104	5520 MHz	128	5640 MHz
108	5540 MHz	132	5660 MHz
112	5560 MHz	136	5680 MHz
116	5580 MHz	140	5700 MHz
120	5600 MHz	144	5720 MHz

6 channels are provided for 802.11n (HT40), 802.11ac (VHT40):

Channel	Frequency	Channel	Frequency
102	5510 MHz	126	5630 MHz
110	5550 MHz	134	5670 MHz
118	5590 MHz	142	5710 MHz

3 channels are provided for 802.11ac (VHT80):

Channel	Frequency	Channel	Frequency
106	5530 MHz	138	5690 MHz
122	5610 MHz		

FOR 5745 ~ 5825MHz:

5 channels are provided for 802.11a, 802.11n (HT20), 802.11ac (VHT20):

Channel	Frequency	Channel	Frequency
149	5745 MHz	161	5805 MHz
153	5765 MHz	165	5825 MHz
157	5785 MHz		

2 channels are provided for 802.11n (HT40), 802.11ac (VHT40):

Channel	Frequency	Channel	Frequency
151	5755 MHz	159	5795 MHz

1 channel is provided for 802.11ac (VHT80):

Channel	Frequency
155	5775 MHz

3.2.1 Test Mode Applicability and Tested Channel Detail

EUT Configure Mode	Applicable To				Description
	RE≥1G	RE<1G	PLC	APCM	
-	√	√	√	√	-

Where **RE≥1G**: Radiated Emission above 1GHz
RE<1G: Radiated Emission below 1GHz
PLC: Power Line Conducted Emission
APCM: Antenna Port Conducted Measurement

Radiated Emission Test (Above 1GHz):

- Pre-Scan has been conducted to determine the worst-case mode from all possible combinations between available modulations, data rates and antenna ports (if EUT with antenna diversity architecture).
- Following channel(s) was (were) selected for the final test as listed below.

Mode	FREQ. Band (MHz)	Available Channel	Tested Channel	Modulation Technology	Modulation Type	Data Rate (Mbps)
802.11a	5180-5240	36 to 48	36, 40, 48	OFDM	BPSK	6
802.11ac (VHT20)		36 to 48	36, 40, 48	OFDM	BPSK	6.5
802.11ac (VHT40)		38 to 46	38, 46	OFDM	BPSK	13.5
802.11ac (VHT80)		42	42	OFDM	BPSK	29.3
802.11a	5260-5320	52 to 64	52, 60, 64	OFDM	BPSK	6
802.11ac (VHT20)		52 to 64	52, 60, 64	OFDM	BPSK	6.5
802.11ac (VHT40)		54 to 62	54, 62	OFDM	BPSK	13.5
802.11ac (VHT80)		58	58	OFDM	BPSK	29.3
802.11a	5500-5720	100 to 144	100, 116, 140, 144	OFDM	BPSK	6
802.11ac (VHT20)		100 to 144	100, 116, 140, 144	OFDM	BPSK	6.5
802.11ac (VHT40)		102 to 142	102, 110, 134, 142	OFDM	BPSK	13.5
802.11ac (VHT80)		106 to 138	106, 122, 138	OFDM	BPSK	29.3
802.11a	5745-5825	149 to 165	149, 157, 165	OFDM	BPSK	6
802.11ac (VHT20)		149 to 165	149, 157, 165	OFDM	BPSK	6.5
802.11ac (VHT40)		151 to 159	151, 159	OFDM	BPSK	13.5
802.11ac (VHT80)		155	155	OFDM	BPSK	29.3

Radiated Emission Test (Below 1GHz):

- Pre-Scan has been conducted to determine the worst-case mode from all possible combinations between available modulations, data rates and antenna ports (if EUT with antenna diversity architecture).
- Following channel(s) was (were) selected for the final test as listed below.

Mode	FREQ. Band (MHz)	Available Channel	Tested Channel	Modulation Technology	Modulation Type	Data Rate (Mbps)
802.11ac (VHT20)	5180-5320, 5500-5720, 5745-5825	36 to 64, 100 to 144, 149 to 165	165	OFDM	BPSK	6.5

Power Line Conducted Emission Test:

- Pre-Scan has been conducted to determine the worst-case mode from all possible combinations between available modulations, data rates and antenna ports (if EUT with antenna diversity architecture).
- Following channel(s) was (were) selected for the final test as listed below.

Mode	FREQ. Band (MHz)	Available Channel	Tested Channel	Modulation Technology	Modulation Type	Data Rate (Mbps)
802.11ac (VHT20)	5180-5320, 5500-5720, 5745-5825	36 to 64, 100 to 144, 149 to 165	165	OFDM	BPSK	6.5

Antenna Port Conducted Measurement:

- This item includes all test value of each mode, but only includes spectrum plot of worst value of each mode.
- Pre-Scan has been conducted to determine the worst-case mode from all possible combinations between available modulations, data rates and antenna ports (if EUT with antenna diversity architecture).
- Following channel(s) was (were) selected for the final test as listed below.

Mode	FREQ. Band (MHz)	Available Channel	Tested Channel	Modulation Technology	Modulation Type	Data Rate (Mbps)
802.11a	5180-5240	36 to 48	36, 40, 48	OFDM	BPSK	6
802.11ac (VHT20)		36 to 48	36, 40, 48	OFDM	BPSK	6.5
802.11ac (VHT40)		38 to 46	38, 46	OFDM	BPSK	13.5
802.11ac (VHT80)		42	42	OFDM	BPSK	29.3
802.11a	5260-5320	52 to 64	52, 60, 64	OFDM	BPSK	6
802.11ac (VHT20)		52 to 64	52, 60, 64	OFDM	BPSK	6.5
802.11ac (VHT40)		54 to 62	54, 62	OFDM	BPSK	13.5
802.11ac (VHT80)		58	58	OFDM	BPSK	29.3
802.11a	5500-5720	100 to 144	100, 116, 140, 144	OFDM	BPSK	6
802.11ac (VHT20)		100 to 144	100, 116, 140, 144	OFDM	BPSK	6.5
802.11ac (VHT40)		102 to 142	102, 110, 134, 142	OFDM	BPSK	13.5
802.11ac (VHT80)		106 to 138	106, 122, 138	OFDM	BPSK	29.3
802.11a	5745-5825	149 to 165	149, 157, 165	OFDM	BPSK	6
802.11ac (VHT20)		149 to 165	149, 157, 165	OFDM	BPSK	6.5
802.11ac (VHT40)		151 to 159	151, 159	OFDM	BPSK	13.5
802.11ac (VHT80)		155	155	OFDM	BPSK	29.3

Test Condition:

Applicable To	Environmental Conditions	Input Power	Tested By
RE \geq 1G	17deg. C, 67%RH	120Vac, 60Hz	Chris Lin
RE $<$ 1G	22deg. C, 66%RH	120Vac, 60Hz	Robert Cheng
PLC	25deg. C, 75%RH	120Vac, 60Hz	Andy Ho
APCM	25deg. C, 60%RH	120Vac, 60Hz	Jyunchun Lin

3.3 Duty Cycle of Test Signal

Duty cycle of test signal is 100 %, duty factor is not required.

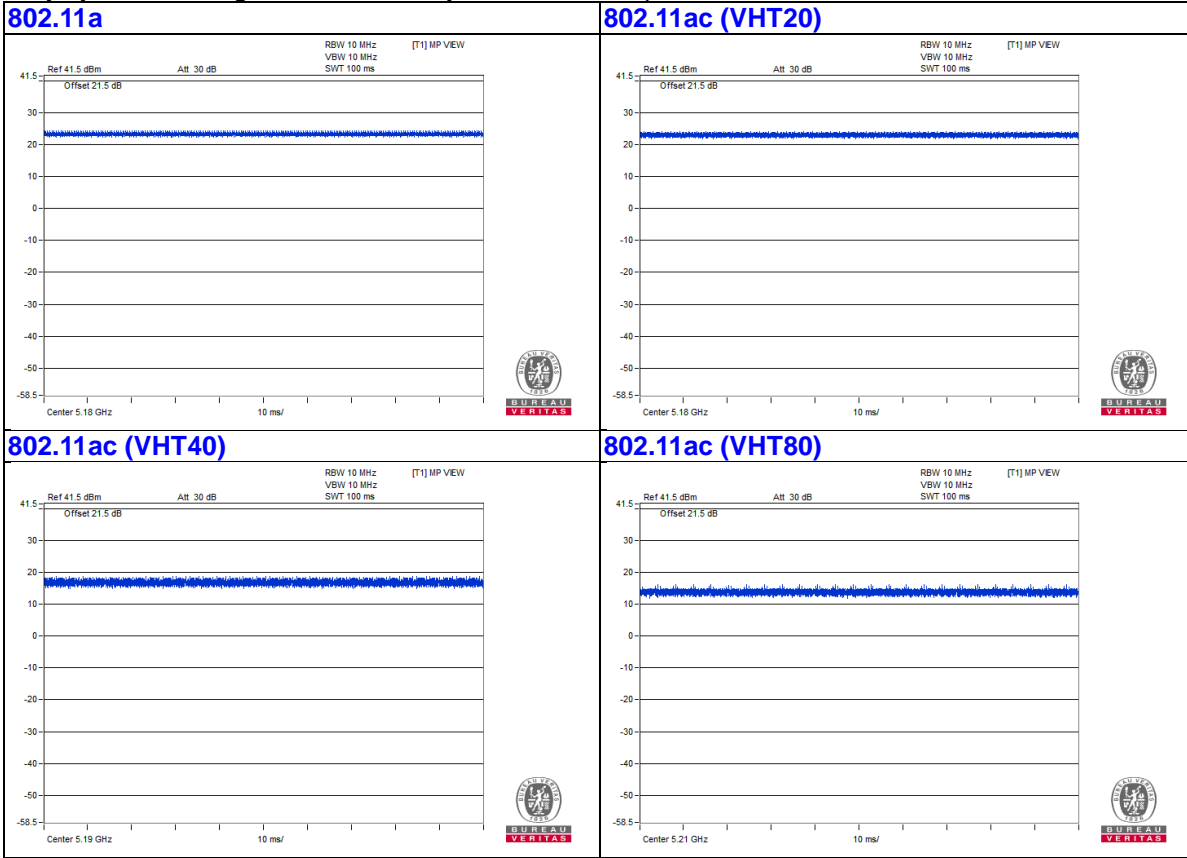

3.4 Description of Support Units

The EUT has been tested as an independent unit together with other necessary accessories or support units. The following support units or accessories were used to form a representative test configuration during the tests.

ID	Product	Brand	Model No.	Serial No.	FCC ID	Remarks
A.	Laptop	DELL	E5430	HYV4VY1	FCC DoC	Provided by Lab
B.	Monitor	ASUS	VN248	NA	NA	Provided by Lab

Note:

- All power cords of the above support units are non-shielded (1.8m).

ID	Descriptions	Qty.	Length (m)	Shielding (Yes/No)	Cores (Qty.)	Remarks
1.	RJ-45 Cable	1	10	No	0	Provided by Lab
2.	DC Cable	1	1.5	No	0	Supplied by client
3.	HDMI Cable	1	1.2	Yes	0	Supplied by client

3.4.1 Configuration of System under Test

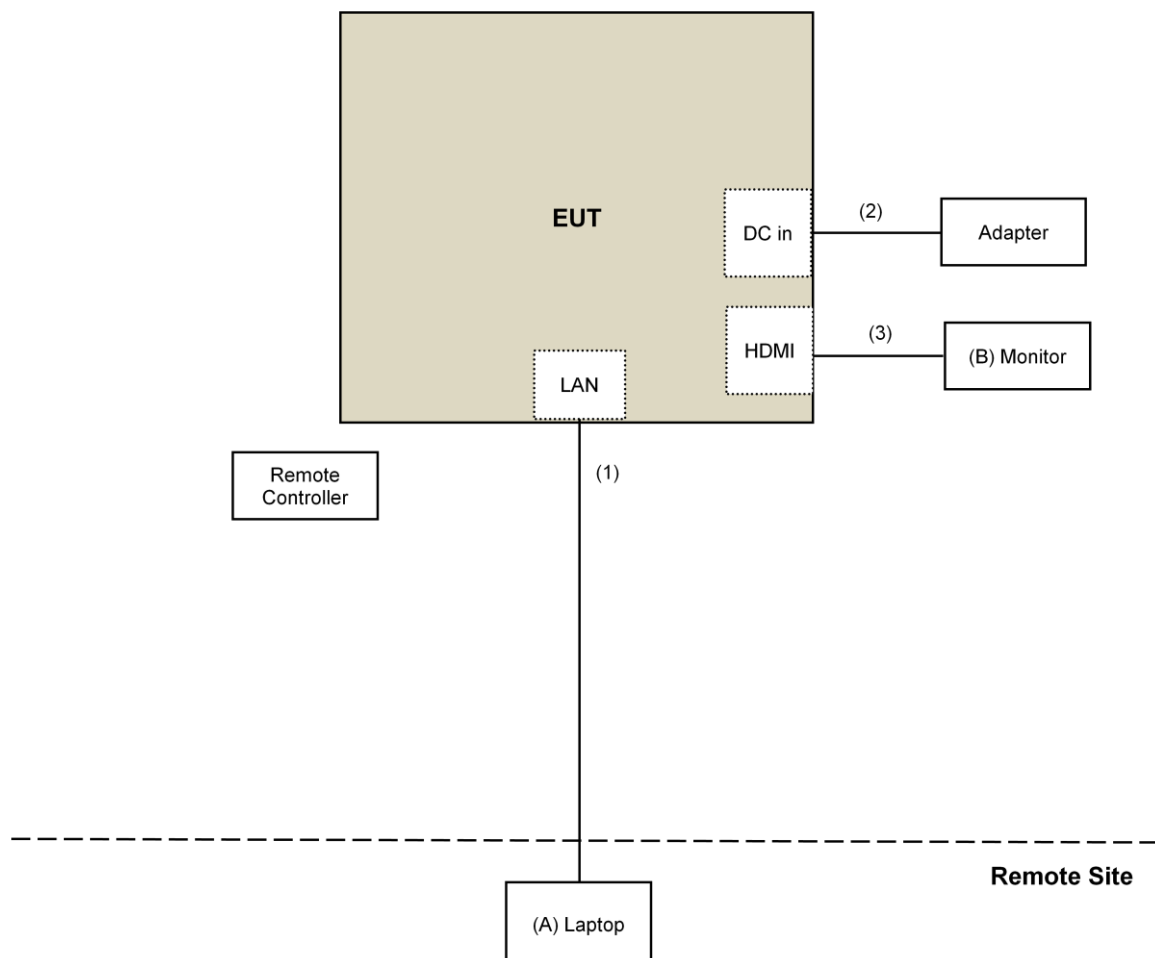

3.5 General Description of Applied Standard

The EUT is a RF Product. According to the specifications of the manufacturer, it must comply with the requirements of the following standards:

FCC Part 15, Subpart E (15.407)

KDB 789033 D02 General UNII Test Procedure New Rules v02r01

KDB 662911 D01 Multiple Transmitter Output v02r01

ANSI C63.10-2013

All test items have been performed and recorded as per the above standards.

4 Test Types and Results

4.1 Radiated Emission and Bandedge Measurement

4.1.1 Limits of Radiated Emission and Bandedge Measurement

Radiated emissions which fall in the restricted bands must comply with the radiated emission limits specified as below table.

Frequencies (MHz)	Field Strength (microvolts/meter)	Measurement Distance (meters)
0.009 ~ 0.490	2400/F(kHz)	300
0.490 ~ 1.705	24000/F(kHz)	30
1.705 ~ 30.0	30	30
30 ~ 88	100	3
88 ~ 216	150	3
216 ~ 960	200	3
Above 960	500	3

NOTE:

- The lower limit shall apply at the transition frequencies.
- Emission level (dBuV/m) = 20 log Emission level (uV/m).
- For frequencies above 1000MHz, the field strength limits are based on average detector, however, the peak field strength of any emission shall not exceed the maximum permitted average limits, specified above by more than 20dB under any condition of modulation.

Limits of unwanted emission out of the restricted bands

Applicable To		Limit	
789033 D02 General UNII Test Procedure New Rules v02r01		Field Strength at 3m	
		PK:74 (dBuV/m)	AV:54 (dBuV/m)
Frequency Band	Applicable To	EIRP Limit	Equivalent Field Strength at 3m
5150~5250 MHz	15.407(b)(1)	PK:-27 (dBm/MHz)	PK:68.2(dBuV/m)
5250~5350 MHz	15.407(b)(2)		
5470~5725 MHz	15.407(b)(3)		
5725~5850 MHz	<input checked="" type="checkbox"/> 15.407(b)(4)(i)	PK:-27 (dBm/MHz) ^{*1} PK:10 (dBm/MHz) ^{*2} PK:15.6 (dBm/MHz) ^{*3} PK:27 (dBm/MHz) ^{*4}	PK: 68.2(dBuV/m) ^{*1} PK:105.2 (dBuV/m) ^{*2} PK: 110.8(dBuV/m) ^{*3} PK:122.2 (dBuV/m) ^{*4}
	<input type="checkbox"/> 15.407(b)(4)(ii)	Emission limits in section 15.247(d)	
^{*1} beyond 75 MHz or more above of the band edge.		^{*2} below the band edge increasing linearly to 10 dBm/MHz at 25 MHz above.	
^{*3} below the band edge increasing linearly to a level of 15.6 dBm/MHz at 5 MHz above.		^{*4} from 5 MHz above or below the band edge increasing linearly to a level of 27 dBm/MHz at the band edge.	

Note:

The following formula is used to convert the equipment isotropic radiated power (eirp) to field strength:

$$E = \frac{1000000\sqrt{30P}}{3} \mu\text{V/m, where P is the eirp (Watts).}$$

4.1.2 Test Instruments

DESCRIPTION & MANUFACTURER	MODEL NO.	SERIAL NO.	CALIBRATED DATE	CALIBRATED UNTIL
Test Receiver Agilent	N9038A	MY50010156	July 12, 2018	July 11, 2019
Pre-Amplifier EMCI	EMC001340	980142	Jan. 25, 2019	Jan. 24, 2020
Loop Antenna Electro-Metrics	EM-6879	269	Sep. 07, 2018	Sep. 06, 2019
RF Cable	NA	LOOPCAB-001	Jan. 14, 2019	Jan. 13, 2020
RF Cable	NA	LOOPCAB-002	Jan. 14, 2019	Jan. 13, 2020
Pre-Amplifier Mini-Circuits	ZFL-1000VH2B	AMP-ZFL-05	Apr. 30, 2019	Apr. 29, 2020
Trilog Broadband Antenna SCHWARZBECK	VULB 9168	9168-361	Nov. 22, 2018	Nov. 21, 2019
RF Cable	8D	966-3-1	Mar. 18, 2019	Mar. 17, 2020
RF Cable	8D	966-3-2	Mar. 18, 2019	Mar. 17, 2020
RF Cable	8D	966-3-3	Mar. 18, 2019	Mar. 17, 2020
Fixed attenuator Mini-Circuits	UNAT-5+	PAD-3m-3-01	Sep. 27, 2018	Sep. 26, 2019
Horn_Antenna SCHWARZBECK	BBHA9120-D	9120D-406	Nov. 25, 2018	Nov. 24, 2019
Pre-Amplifier EMCI	EMC12630SE	980384	Jan. 28, 2019	Jan. 27, 2020
RF Cable	EMC104-SM-SM-1200	160922	Jan. 28, 2019	Jan. 27, 2020
RF Cable	EMC104-SM-SM-2000	180601	June 10, 2019	June 09, 2020
RF Cable	EMC104-SM-SM-6000	180602	June 10, 2019	June 09, 2020
Spectrum Analyzer Keysight	N9030A	MY54490679	July 23, 2018	July 22, 2019
Pre-Amplifier EMCI	EMC184045SE	980387	Jan. 28, 2019	Jan. 27, 2020
Horn_Antenna SCHWARZBECK	BBHA 9170	BBHA9170519	Nov. 25, 2018	Nov. 24, 2019
RF Cable	EMC102-KM-KM-1200	160924	Jan. 28, 2019	Jan. 27, 2020
RF Cable	EMC102-KM-KM-1200	160925	Jan. 28, 2019	Jan. 27, 2020
Software	ADT_Radiated_V8.7.08	NA	NA	NA
Antenna Tower & Turn Table Max-Full	MF-7802	MF780208406	NA	NA
Boresight Antenna Fixture	FBA-01	FBA-SIP01	NA	NA
Spectrum Analyzer R&S	FSV40	100964	June 04, 2019	June 03, 2020
Power meter Anritsu	ML2495A	1014008	May 13, 2019	May 12, 2020
Power sensor Anritsu	MA2411B	0917122	May 13, 2019	May 12, 2020
Fixed Attenuator Mini-Circuits	MDCS18N-10	MDCS18N-10-01	Apr. 15, 2019	Apr. 14, 2020
AC Power Source Extech Electronics	6205	1440452	NA	NA
Temperature & Humidity Chamber Giant Force	GTH-150-40-SP-AR	MAA0812-008	Jan. 09, 2019	Jan. 08, 2020
True RMS Clamp Meter FLUKE	325	31130711WS	May 21, 2019	May 20, 2020

Note:

1. The calibration interval of the above test instruments is 12 months and the calibrations are traceable to NML/ROC and NIST/USA.
2. The test was performed in 966 Chamber No. 3.
3. Loop antenna was used for all emissions below 30 MHz.
4. Tested Date: June 21 to July 02, 2019

4.1.3 Test Procedure

For Radiated emission below 30MHz

- a. The EUT was placed on the top of a rotating table 0.8 meters above the ground at a 3 meter chamber room. The table was rotated 360 degrees to determine the position of the highest radiation.
- b. The EUT was set 3 meters away from the interference-receiving antenna, which was mounted on the top of a variable-height antenna tower.
- c. Parallel, perpendicular, and ground-parallel orientations of the antenna are set to make the measurement.
- d. For each suspected emission, the EUT was arranged to its worst case and the rotatable table was turned from 0 degrees to 360 degrees to find the maximum reading.
- e. The test-receiver system was set to Quasi-Peak Detect Function and Specified Bandwidth with Maximum Hold Mode.

Note:

1. The resolution bandwidth and video bandwidth of test receiver/spectrum analyzer is 9kHz at frequency below 30MHz.

For Radiated emission above 30MHz

- a. The EUT was placed on the top of a rotating table 0.8 meters (for 30MHz ~ 1GHz) / 1.5 meters (for above 1GHz) above the ground at 3 meter chamber room for test. The table was rotated 360 degrees to determine the position of the highest radiation.
- b. The EUT was set 3 meters away from the interference-receiving antenna, which was mounted on the top of a variable-height antenna tower.
- c. The height of antenna is varied from one meter to four meters above the ground to determine the maximum value of the field strength. Both horizontal and vertical polarizations of the antenna are set to make the measurement.
- d. For each suspected emission, the EUT was arranged to its worst case and then the antenna was tuned to heights from 1 meter to 4 meters and the rotatable table was turned from 0 degrees to 360 degrees to find the maximum reading.
- e. The test-receiver system was set to quasi-peak detect function and specified bandwidth with maximum hold mode when the test frequency is below 1 GHz.
- f. The test-receiver system was set to peak and average detects function and specified bandwidth with maximum hold mode when the test frequency is above 1 GHz. If the peak reading value also meets average limit, measurement with the average detector is unnecessary.

Note:

1. The resolution bandwidth and video bandwidth of test receiver/spectrum analyzer is 120kHz for Quasi-peak detection (QP) at frequency below 1GHz.
2. The resolution bandwidth of test receiver/spectrum analyzer is 1 MHz and the video bandwidth is 3 MHz for Peak detection (PK) at frequency above 1GHz.
3. The resolution bandwidth of test receiver/spectrum analyzer is 1MHz and the video bandwidth is $\geq 1/T$ (Duty cycle $< 98\%$) or 10Hz (Duty cycle $\geq 98\%$) for Average detection (AV) at frequency above 1GHz.
4. All modes of operation were investigated and the worst-case emissions are reported.

4.1.4 Deviation from Test Standard

No deviation.

4.1.5 Test Setup

For Radiated emission below 30MHz

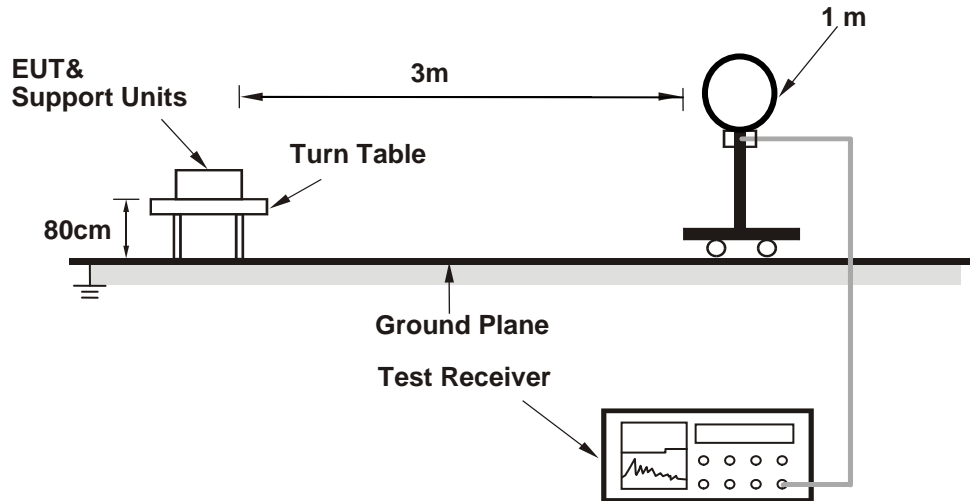

For Radiated emission 30MHz to 1GHz

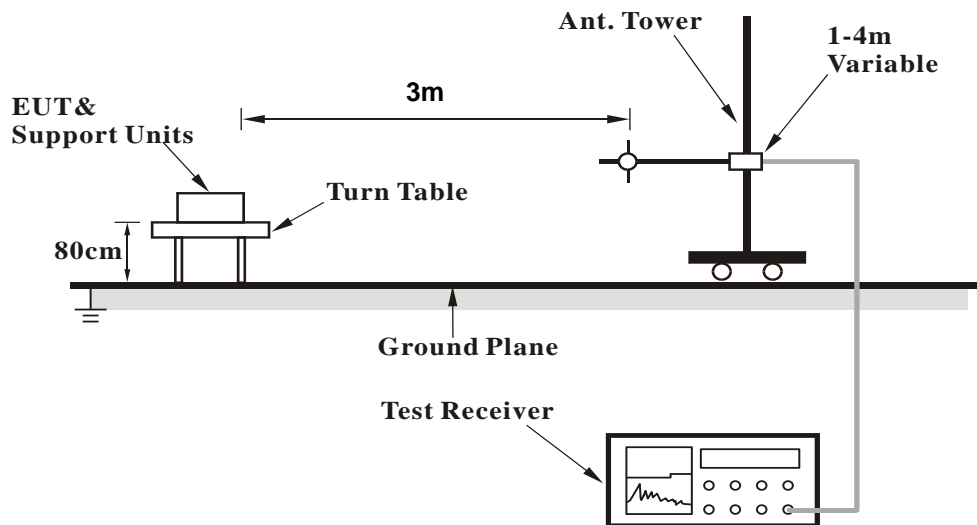

For Radiated emission above 1GHz

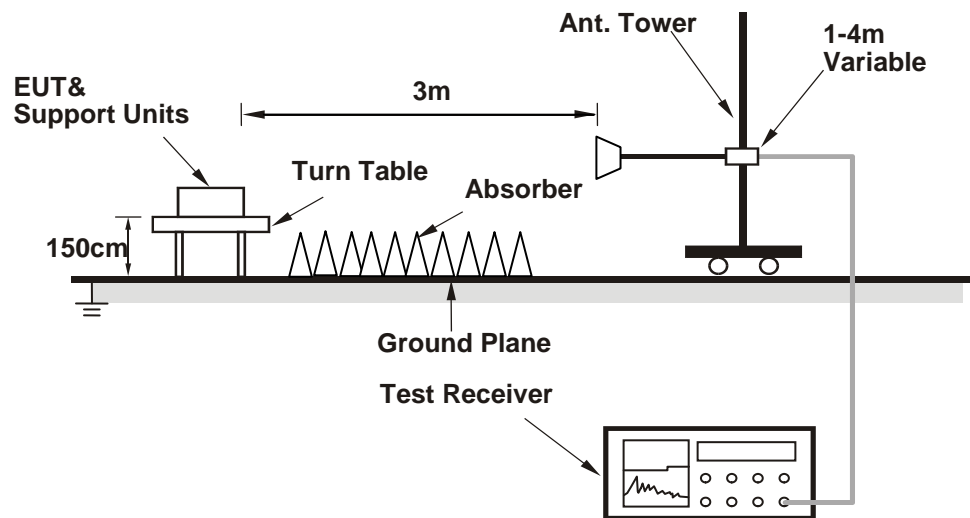

For the actual test configuration, please refer to the attached file (Test Setup Photo).

4.1.6 EUT Operating Condition

- Placed the EUT on the testing table.
- Controlling software (Tera Term paste "WiFi-CMD_JC support_190606" command) has been activated to set the EUT under transmission condition continuously at specific channel frequency.

4.1.7 Test Results

Above 1GHz Data:

802.11a

CHANNEL	TX Channel 36	DETECTOR FUNCTION	Peak (PK)
FREQUENCY RANGE	1GHz ~ 40GHz		Average (AV)

ANTENNA POLARITY & TEST DISTANCE: HORIZONTAL AT 3 M								
NO.	FREQ. (MHz)	EMISSION LEVEL (dBuV/m)	LIMIT (dBuV/m)	MARGIN (dB)	ANTENNA HEIGHT (m)	TABLE ANGLE (Degree)	RAW VALUE (dBuV)	CORRECTION FACTOR (dB/m)
1	5150.00	69.0 PK	74.0	-5.0	1.53 H	12	65.7	3.3
2	5150.00	53.1 AV	54.0	-0.9	1.53 H	12	49.8	3.3
3	*5180.00	113.2 PK			1.53 H	12	109.9	3.3
4	*5180.00	104.5 AV			1.53 H	12	101.2	3.3
5	#10360.00	48.6 PK	68.2	-19.6	1.52 H	305	36.4	12.2
6	15540.00	50.0 PK	74.0	-24.0	1.33 H	206	36.8	13.2
7	15540.00	40.2 AV	54.0	-13.8	1.33 H	206	27.0	13.2

ANTENNA POLARITY & TEST DISTANCE: VERTICAL AT 3 M								
NO.	FREQ. (MHz)	EMISSION LEVEL (dBuV/m)	LIMIT (dBuV/m)	MARGIN (dB)	ANTENNA HEIGHT (m)	TABLE ANGLE (Degree)	RAW VALUE (dBuV)	CORRECTION FACTOR (dB/m)
1	5150.00	64.0 PK	74.0	-10.0	2.89 V	87	60.7	3.3
2	5150.00	49.3 AV	54.0	-4.7	2.89 V	87	46.0	3.3
3	*5180.00	108.5 PK			2.89 V	87	105.2	3.3
4	*5180.00	99.8 AV			2.89 V	87	96.5	3.3
5	#10360.00	47.7 PK	68.2	-20.5	2.25 V	101	35.5	12.2
6	15540.00	51.1 PK	74.0	-22.9	1.79 V	307	37.9	13.2
7	15540.00	41.0 AV	54.0	-13.0	1.79 V	307	27.8	13.2

REMARKS:

1. Emission Level(dBuV/m) = Raw Value(dBuV) + Correction Factor(dB/m)
2. Correction Factor(dB/m) = Antenna Factor(dB/m) + Cable Factor(dB) – Pre-Amplifier Factor(dB)
3. Margin value = Emission Level – Limit value
4. The other emission levels were very low against the limit.
5. " * ": Fundamental frequency.
6. " # ": The radiated frequency is out of the restricted band.

CHANNEL	TX Channel 40	DETECTOR FUNCTION	Peak (PK)
FREQUENCY RANGE	1GHz ~ 40GHz		Average (AV)

ANTENNA POLARITY & TEST DISTANCE: HORIZONTAL AT 3 M

NO.	FREQ. (MHz)	EMISSION LEVEL (dBuV/m)	LIMIT (dBuV/m)	MARGIN (dB)	ANTENNA HEIGHT (m)	TABLE ANGLE (Degree)	RAW VALUE (dBuV)	CORRECTION FACTOR (dB/m)
1	*5200.00	113.3 PK			1.56 H	9	110.2	3.1
2	*5200.00	104.5 AV			1.56 H	9	101.4	3.1
3	#10400.00	48.4 PK	68.2	-19.8	1.54 H	291	36.0	12.4
4	15600.00	49.9 PK	74.0	-24.1	1.33 H	212	36.7	13.2
5	15600.00	40.0 AV	54.0	-14.0	1.33 H	212	26.8	13.2

ANTENNA POLARITY & TEST DISTANCE: VERTICAL AT 3 M

NO.	FREQ. (MHz)	EMISSION LEVEL (dBuV/m)	LIMIT (dBuV/m)	MARGIN (dB)	ANTENNA HEIGHT (m)	TABLE ANGLE (Degree)	RAW VALUE (dBuV)	CORRECTION FACTOR (dB/m)
1	*5200.00	109.1 PK			2.82 V	91	106.0	3.1
2	*5200.00	100.3 AV			2.82 V	91	97.2	3.1
3	#10400.00	48.2 PK	68.2	-20.0	2.23 V	115	35.8	12.4
4	15600.00	51.3 PK	74.0	-22.7	1.76 V	313	38.1	13.2
5	15600.00	41.2 AV	54.0	-12.8	1.76 V	313	28.0	13.2

REMARKS:

1. Emission Level(dBuV/m) = Raw Value(dBuV) + Correction Factor(dB/m)
2. Correction Factor(dB/m) = Antenna Factor(dB/m) + Cable Factor(dB) – Pre-Amplifier Factor(dB)
3. Margin value = Emission Level – Limit value
4. The other emission levels were very low against the limit.
5. " * ": Fundamental frequency.
6. " # ": The radiated frequency is out of the restricted band.

CHANNEL	TX Channel 48	DETECTOR FUNCTION	Peak (PK)
FREQUENCY RANGE	1GHz ~ 40GHz		Average (AV)

ANTENNA POLARITY & TEST DISTANCE: HORIZONTAL AT 3 M

NO.	FREQ. (MHz)	EMISSION LEVEL (dBuV/m)	LIMIT (dBuV/m)	MARGIN (dB)	ANTENNA HEIGHT (m)	TABLE ANGLE (Degree)	RAW VALUE (dBuV)	CORRECTION FACTOR (dB/m)
1	*5240.00	114.0 PK			1.57 H	16	111.2	2.8
2	*5240.00	105.0 AV			1.57 H	16	102.2	2.8
3	5350.00	52.7 PK	74.0	-21.3	1.57 H	16	49.7	3.0
4	5350.00	40.6 AV	54.0	-13.4	1.57 H	16	37.6	3.0
5	#10480.00	48.8 PK	68.2	-19.4	1.63 H	155	36.3	12.5
6	15720.00	49.8 PK	74.0	-24.2	1.17 H	230	37.5	12.3
7	15720.00	39.8 AV	54.0	-14.2	1.17 H	230	27.5	12.3

ANTENNA POLARITY & TEST DISTANCE: VERTICAL AT 3 M

NO.	FREQ. (MHz)	EMISSION LEVEL (dBuV/m)	LIMIT (dBuV/m)	MARGIN (dB)	ANTENNA HEIGHT (m)	TABLE ANGLE (Degree)	RAW VALUE (dBuV)	CORRECTION FACTOR (dB/m)
1	*5240.00	108.5 PK			2.79 V	106	105.7	2.8
2	*5240.00	99.9 AV			2.79 V	106	97.1	2.8
3	5350.00	50.2 PK	74.0	-23.8	2.79 V	106	47.2	3.0
4	5350.00	39.4 AV	54.0	-14.6	2.79 V	106	36.4	3.0
5	#10480.00	47.1 PK	68.2	-21.1	2.18 V	109	34.6	12.5
6	15720.00	51.5 PK	74.0	-22.5	1.79 V	336	39.2	12.3
7	15720.00	41.2 AV	54.0	-12.8	1.79 V	336	28.9	12.3

REMARKS:

1. Emission Level(dBuV/m) = Raw Value(dBuV) + Correction Factor(dB/m)
2. Correction Factor(dB/m) = Antenna Factor(dB/m) + Cable Factor(dB) – Pre-Amplifier Factor(dB)
3. Margin value = Emission Level – Limit value
4. The other emission levels were very low against the limit.
5. " * ": Fundamental frequency.
6. " # ": The radiated frequency is out of the restricted band.

CHANNEL	TX Channel 52	DETECTOR FUNCTION	Peak (PK)
FREQUENCY RANGE	1GHz ~ 40GHz		Average (AV)

ANTENNA POLARITY & TEST DISTANCE: HORIZONTAL AT 3 M

NO.	FREQ. (MHz)	EMISSION LEVEL (dBuV/m)	LIMIT (dBuV/m)	MARGIN (dB)	ANTENNA HEIGHT (m)	TABLE ANGLE (Degree)	RAW VALUE (dBuV)	CORRECTION FACTOR (dB/m)
1	5150.00	50.8 PK	74.0	-23.2	1.56 H	8	47.5	3.3
2	5150.00	40.6 AV	54.0	-13.4	1.56 H	8	37.3	3.3
3	*5260.00	113.9 PK			1.56 H	8	111.2	2.7
4	*5260.00	104.6 AV			1.56 H	8	101.9	2.7
5	#10520.00	48.7 PK	68.2	-19.5	1.36 H	228	36.1	12.6
6	15780.00	50.0 PK	74.0	-24.0	1.57 H	306	38.0	12.0
7	15780.00	40.2 AV	54.0	-13.8	1.57 H	306	28.2	12.0

ANTENNA POLARITY & TEST DISTANCE: VERTICAL AT 3 M

NO.	FREQ. (MHz)	EMISSION LEVEL (dBuV/m)	LIMIT (dBuV/m)	MARGIN (dB)	ANTENNA HEIGHT (m)	TABLE ANGLE (Degree)	RAW VALUE (dBuV)	CORRECTION FACTOR (dB/m)
1	5150.00	50.2 PK	74.0	-23.8	2.87 V	81	46.9	3.3
2	5150.00	39.4 AV	54.0	-14.6	2.87 V	81	36.1	3.3
3	*5260.00	108.5 PK			2.87 V	81	105.8	2.7
4	*5260.00	100.1 AV			2.87 V	81	97.4	2.7
5	#10520.00	47.6 PK	68.2	-20.6	2.25 V	89	35.0	12.6
6	15780.00	51.3 PK	74.0	-22.7	1.74 V	307	39.3	12.0
7	15780.00	40.9 AV	54.0	-13.1	1.74 V	307	28.9	12.0

REMARKS:

1. Emission Level(dBuV/m) = Raw Value(dBuV) + Correction Factor(dB/m)
2. Correction Factor(dB/m) = Antenna Factor(dB/m) + Cable Factor(dB) – Pre-Amplifier Factor(dB)
3. Margin value = Emission Level – Limit value
4. The other emission levels were very low against the limit.
5. " * ": Fundamental frequency.
6. " # ": The radiated frequency is out of the restricted band.

CHANNEL	TX Channel 60	DETECTOR FUNCTION	Peak (PK)
FREQUENCY RANGE	1GHz ~ 40GHz		Average (AV)

ANTENNA POLARITY & TEST DISTANCE: HORIZONTAL AT 3 M

NO.	FREQ. (MHz)	EMISSION LEVEL (dBuV/m)	LIMIT (dBuV/m)	MARGIN (dB)	ANTENNA HEIGHT (m)	TABLE ANGLE (Degree)	RAW VALUE (dBuV)	CORRECTION FACTOR (dB/m)
1	*5300.00	114.0 PK			1.74 H	15	111.2	2.8
2	*5300.00	104.8 AV			1.74 H	15	102.0	2.8
3	10600.00	48.1 PK	74.0	-25.9	1.65 H	331	35.6	12.5
4	10600.00	39.3 AV	54.0	-14.7	1.65 H	331	26.8	12.5
5	15900.00	50.6 PK	74.0	-23.4	1.47 H	314	38.3	12.3
6	15900.00	40.5 AV	54.0	-13.5	1.47 H	314	28.2	12.3

ANTENNA POLARITY & TEST DISTANCE: VERTICAL AT 3 M

NO.	FREQ. (MHz)	EMISSION LEVEL (dBuV/m)	LIMIT (dBuV/m)	MARGIN (dB)	ANTENNA HEIGHT (m)	TABLE ANGLE (Degree)	RAW VALUE (dBuV)	CORRECTION FACTOR (dB/m)
1	*5300.00	108.6 PK			2.91 V	99	105.8	2.8
2	*5300.00	100.1 AV			2.91 V	99	97.3	2.8
3	10600.00	47.6 PK	74.0	-26.4	2.22 V	100	35.1	12.5
4	10600.00	38.9 AV	54.0	-15.1	2.22 V	100	26.4	12.5
5	15900.00	51.1 PK	74.0	-22.9	1.78 V	321	38.8	12.3
6	15900.00	40.8 AV	54.0	-13.2	1.78 V	321	28.5	12.3

REMARKS:

1. Emission Level(dBuV/m) = Raw Value(dBuV) + Correction Factor(dB/m)
2. Correction Factor(dB/m) = Antenna Factor(dB/m) + Cable Factor(dB) – Pre-Amplifier Factor(dB)
3. Margin value = Emission Level – Limit value
4. The other emission levels were very low against the limit.
5. " * ": Fundamental frequency.

CHANNEL	TX Channel 64	DETECTOR FUNCTION	Peak (PK)
FREQUENCY RANGE	1GHz ~ 40GHz		Average (AV)

ANTENNA POLARITY & TEST DISTANCE: HORIZONTAL AT 3 M

NO.	FREQ. (MHz)	EMISSION LEVEL (dBuV/m)	LIMIT (dBuV/m)	MARGIN (dB)	ANTENNA HEIGHT (m)	TABLE ANGLE (Degree)	RAW VALUE (dBuV)	CORRECTION FACTOR (dB/m)
1	*5320.00	113.3 PK			1.71 H	22	110.5	2.8
2	*5320.00	104.6 AV			1.71 H	22	101.8	2.8
3	5350.00	65.8 PK	74.0	-8.2	1.71 H	22	62.8	3.0
4	5350.00	51.1 AV	54.0	-2.9	1.71 H	22	48.1	3.0
5	10640.00	47.9 PK	74.0	-26.1	1.36 H	221	35.4	12.5
6	10640.00	39.3 AV	54.0	-14.7	1.36 H	221	26.8	12.5
7	15960.00	50.7 PK	74.0	-23.3	1.57 H	178	38.0	12.7
8	15960.00	40.5 AV	54.0	-13.5	1.57 H	178	27.8	12.7

ANTENNA POLARITY & TEST DISTANCE: VERTICAL AT 3 M

NO.	FREQ. (MHz)	EMISSION LEVEL (dBuV/m)	LIMIT (dBuV/m)	MARGIN (dB)	ANTENNA HEIGHT (m)	TABLE ANGLE (Degree)	RAW VALUE (dBuV)	CORRECTION FACTOR (dB/m)
1	*5320.00	108.8 PK			2.88 V	99	106.0	2.8
2	*5320.00	100.2 AV			2.88 V	99	97.4	2.8
3	5350.00	62.2 PK	74.0	-11.8	2.88 V	99	59.2	3.0
4	5350.00	48.2 AV	54.0	-5.8	2.88 V	99	45.2	3.0
5	10640.00	47.1 PK	74.0	-26.9	2.28 V	107	34.6	12.5
6	10640.00	38.5 AV	54.0	-15.5	2.28 V	107	26.0	12.5
7	15960.00	50.4 PK	74.0	-23.6	1.72 V	325	37.7	12.7
8	15960.00	40.4 AV	54.0	-13.6	1.72 V	325	27.7	12.7

REMARKS:

1. Emission Level(dBuV/m) = Raw Value(dBuV) + Correction Factor(dB/m)
2. Correction Factor(dB/m) = Antenna Factor(dB/m) + Cable Factor(dB) – Pre-Amplifier Factor(dB)
3. Margin value = Emission Level – Limit value
4. The other emission levels were very low against the limit.
5. " * ": Fundamental frequency.

CHANNEL	TX Channel 100	DETECTOR FUNCTION	Peak (PK)
FREQUENCY RANGE	1GHz ~ 40GHz		Average (AV)

ANTENNA POLARITY & TEST DISTANCE: HORIZONTAL AT 3 M

NO.	FREQ. (MHz)	EMISSION LEVEL (dBuV/m)	LIMIT (dBuV/m)	MARGIN (dB)	ANTENNA HEIGHT (m)	TABLE ANGLE (Degree)	RAW VALUE (dBuV)	CORRECTION FACTOR (dB/m)
1	5460.00	63.2 PK	74.0	-10.8	1.76 H	16	59.9	3.3
2	5460.00	50.2 AV	54.0	-3.8	1.76 H	16	46.9	3.3
3	#5470.00	66.1 PK	68.2	-2.1	1.76 H	16	62.8	3.3
4	*5500.00	111.8 PK			1.76 H	16	108.5	3.3
5	*5500.00	103.0 AV			1.76 H	16	99.7	3.3
6	11000.00	48.0 PK	74.0	-26.0	1.12 H	231	34.9	13.1
7	11000.00	39.3 AV	54.0	-14.7	1.12 H	231	26.2	13.1
8	#16500.00	50.5 PK	68.2	-17.7	1.29 H	302	36.2	14.3

ANTENNA POLARITY & TEST DISTANCE: VERTICAL AT 3 M

NO.	FREQ. (MHz)	EMISSION LEVEL (dBuV/m)	LIMIT (dBuV/m)	MARGIN (dB)	ANTENNA HEIGHT (m)	TABLE ANGLE (Degree)	RAW VALUE (dBuV)	CORRECTION FACTOR (dB/m)
1	5460.00	59.3 PK	74.0	-14.7	2.81 V	81	56.0	3.3
2	5460.00	46.1 AV	54.0	-7.9	2.81 V	81	42.8	3.3
3	#5470.00	62.0 PK	68.2	-6.2	2.81 V	81	58.7	3.3
4	*5500.00	107.3 PK			2.81 V	81	104.0	3.3
5	*5500.00	99.2 AV			2.81 V	81	95.9	3.3
6	11000.00	47.7 PK	74.0	-26.3	2.26 V	101	34.6	13.1
7	11000.00	38.7 AV	54.0	-15.3	2.26 V	101	25.6	13.1
8	#16500.00	51.1 PK	68.2	-17.1	1.78 V	319	36.8	14.3

REMARKS:

- Emission Level(dBuV/m) = Raw Value(dBuV) + Correction Factor(dB/m)
- Correction Factor(dB/m) = Antenna Factor(dB/m) + Cable Factor(dB) – Pre-Amplifier Factor(dB)
- Margin value = Emission Level – Limit value
- The other emission levels were very low against the limit.
- " * ": Fundamental frequency.
- " # ": The radiated frequency is out of the restricted band.

CHANNEL	TX Channel 116	DETECTOR FUNCTION	Peak (PK)
FREQUENCY RANGE	1GHz ~ 40GHz		Average (AV)

ANTENNA POLARITY & TEST DISTANCE: HORIZONTAL AT 3 M

NO.	FREQ. (MHz)	EMISSION LEVEL (dBuV/m)	LIMIT (dBuV/m)	MARGIN (dB)	ANTENNA HEIGHT (m)	TABLE ANGLE (Degree)	RAW VALUE (dBuV)	CORRECTION FACTOR (dB/m)
1	*5580.00	111.7 PK			2.87 H	11	108.4	3.3
2	*5580.00	102.7 AV			2.87 H	11	99.4	3.3
3	11160.00	48.5 PK	74.0	-25.5	1.36 H	332	35.6	12.9
4	11160.00	39.7 AV	54.0	-14.3	1.36 H	332	26.8	12.9
5	#16740.00	50.9 PK	68.2	-17.3	1.24 H	305	35.5	15.4

ANTENNA POLARITY & TEST DISTANCE: VERTICAL AT 3 M

NO.	FREQ. (MHz)	EMISSION LEVEL (dBuV/m)	LIMIT (dBuV/m)	MARGIN (dB)	ANTENNA HEIGHT (m)	TABLE ANGLE (Degree)	RAW VALUE (dBuV)	CORRECTION FACTOR (dB/m)
1	*5580.00	107.5 PK			2.80 V	99	104.2	3.3
2	*5580.00	99.6 AV			2.80 V	99	96.3	3.3
3	11160.00	47.8 PK	74.0	-26.2	2.17 V	97	34.9	12.9
4	11160.00	39.2 AV	54.0	-14.8	2.17 V	97	26.3	12.9
5	#16740.00	50.4 PK	68.2	-17.8	1.82 V	328	35.0	15.4

REMARKS:

1. Emission Level(dBuV/m) = Raw Value(dBuV) + Correction Factor(dB/m)
2. Correction Factor(dB/m) = Antenna Factor(dB/m) + Cable Factor(dB) – Pre-Amplifier Factor(dB)
3. Margin value = Emission Level – Limit value
4. The other emission levels were very low against the limit.
5. " * ": Fundamental frequency.
6. " # ": The radiated frequency is out of the restricted band.

CHANNEL	TX Channel 140	DETECTOR FUNCTION	Peak (PK)
FREQUENCY RANGE	1GHz ~ 40GHz		Average (AV)

ANTENNA POLARITY & TEST DISTANCE: HORIZONTAL AT 3 M

NO.	FREQ. (MHz)	EMISSION LEVEL (dBuV/m)	LIMIT (dBuV/m)	MARGIN (dB)	ANTENNA HEIGHT (m)	TABLE ANGLE (Degree)	RAW VALUE (dBuV)	CORRECTION FACTOR (dB/m)
1	*5700.00	111.6 PK			1.40 H	357	108.2	3.4
2	*5700.00	102.8 AV			1.40 H	357	99.4	3.4
3	#5725.00	66.8 PK	68.2	-1.4	1.40 H	357	63.3	3.5
4	11400.00	48.8 PK	74.0	-25.2	1.06 H	302	35.5	13.3
5	11400.00	40.1 AV	54.0	-13.9	1.06 H	302	26.8	13.3
6	#17100.00	51.0 PK	68.2	-17.2	1.54 H	204	34.6	16.4

ANTENNA POLARITY & TEST DISTANCE: VERTICAL AT 3 M

NO.	FREQ. (MHz)	EMISSION LEVEL (dBuV/m)	LIMIT (dBuV/m)	MARGIN (dB)	ANTENNA HEIGHT (m)	TABLE ANGLE (Degree)	RAW VALUE (dBuV)	CORRECTION FACTOR (dB/m)
1	*5700.00	107.6 PK			2.82 V	78	104.2	3.4
2	*5700.00	99.7 AV			2.82 V	78	96.3	3.4
3	#5725.00	63.5 PK	68.2	-4.7	2.82 V	78	60.0	3.5
4	11400.00	47.5 PK	74.0	-26.5	2.17 V	102	34.2	13.3
5	11400.00	38.8 AV	54.0	-15.2	2.17 V	102	25.5	13.3
6	#17100.00	51.1 PK	68.2	-17.1	1.81 V	316	34.7	16.4

REMARKS:

1. Emission Level(dBuV/m) = Raw Value(dBuV) + Correction Factor(dB/m)
2. Correction Factor(dB/m) = Antenna Factor(dB/m) + Cable Factor(dB) – Pre-Amplifier Factor(dB)
3. Margin value = Emission Level – Limit value
4. The other emission levels were very low against the limit.
5. " * ": Fundamental frequency.
6. " # ": The radiated frequency is out of the restricted band.

CHANNEL	TX Channel 144	DETECTOR FUNCTION	Peak (PK)
FREQUENCY RANGE	1GHz ~ 40GHz		Average (AV)

ANTENNA POLARITY & TEST DISTANCE: HORIZONTAL AT 3 M

NO.	FREQ. (MHz)	EMISSION LEVEL (dBuV/m)	LIMIT (dBuV/m)	MARGIN (dB)	ANTENNA HEIGHT (m)	TABLE ANGLE (Degree)	RAW VALUE (dBuV)	CORRECTION FACTOR (dB/m)
1	*5720.00	112.1 PK			1.43 H	347	108.6	3.5
2	*5720.00	103.4 AV			1.43 H	347	99.9	3.5
3	#5850.00	51.4 PK	68.2	-16.8	1.43 H	347	47.4	4.0
4	11440.00	48.7 PK	74.0	-25.3	1.32 H	319	35.5	13.2
5	11440.00	39.9 AV	54.0	-14.1	1.32 H	319	26.7	13.2
6	#17160.00	51.6 PK	68.2	-16.6	1.27 H	313	34.8	16.8

ANTENNA POLARITY & TEST DISTANCE: VERTICAL AT 3 M

NO.	FREQ. (MHz)	EMISSION LEVEL (dBuV/m)	LIMIT (dBuV/m)	MARGIN (dB)	ANTENNA HEIGHT (m)	TABLE ANGLE (Degree)	RAW VALUE (dBuV)	CORRECTION FACTOR (dB/m)
1	*5720.00	107.0 PK			2.81 V	93	103.5	3.5
2	*5720.00	99.1 AV			2.81 V	93	95.6	3.5
3	#5850.00	49.6 PK	68.2	-18.6	2.81 V	93	45.6	4.0
4	11440.00	48.4 PK	74.0	-25.6	2.23 V	110	35.2	13.2
5	11440.00	39.5 AV	54.0	-14.5	2.23 V	110	26.3	13.2
6	#17160.00	51.1 PK	68.2	-17.1	1.88 V	327	34.3	16.8

REMARKS:

1. Emission Level(dBuV/m) = Raw Value(dBuV) + Correction Factor(dB/m)
2. Correction Factor(dB/m) = Antenna Factor(dB/m) + Cable Factor(dB) – Pre-Amplifier Factor(dB)
3. Margin value = Emission Level – Limit value
4. The other emission levels were very low against the limit.
5. " * ": Fundamental frequency.
6. " # ": The radiated frequency is out of the restricted band.

CHANNEL	TX Channel 149	DETECTOR FUNCTION	Peak (PK)
FREQUENCY RANGE	1GHz ~ 40GHz		Average (AV)

ANTENNA POLARITY & TEST DISTANCE: HORIZONTAL AT 3 M

NO.	FREQ. (MHz)	EMISSION LEVEL (dBuV/m)	LIMIT (dBuV/m)	MARGIN (dB)	ANTENNA HEIGHT (m)	TABLE ANGLE (Degree)	RAW VALUE (dBuV)	CORRECTION FACTOR (dB/m)
1	#5639.54	55.7 PK	68.2	-12.5	1.38 H	355	52.4	3.3
2	*5745.00	115.8 PK			1.38 H	355	112.2	3.6
3	*5745.00	109.0 AV			1.38 H	355	105.4	3.6
4	#5969.35	51.9 PK	68.2	-16.3	1.38 H	355	47.7	4.2
5	11490.00	48.5 PK	74.0	-25.5	1.65 H	305	35.4	13.1
6	11490.00	39.8 AV	54.0	-14.2	1.65 H	305	26.7	13.1
7	#17235.00	50.7 PK	68.2	-17.5	1.47 H	314	33.7	17.0

ANTENNA POLARITY & TEST DISTANCE: VERTICAL AT 3 M

NO.	FREQ. (MHz)	EMISSION LEVEL (dBuV/m)	LIMIT (dBuV/m)	MARGIN (dB)	ANTENNA HEIGHT (m)	TABLE ANGLE (Degree)	RAW VALUE (dBuV)	CORRECTION FACTOR (dB/m)
1	#5643.09	51.7 PK	68.2	-16.5	2.85 V	91	48.4	3.3
2	*5745.00	108.2 PK			2.85 V	91	104.6	3.6
3	*5745.00	102.4 AV			2.85 V	91	98.8	3.6
4	#5977.75	51.8 PK	68.2	-16.4	2.85 V	91	47.7	4.1
5	11490.00	47.4 PK	74.0	-26.6	2.22 V	103	34.3	13.1
6	11490.00	38.8 AV	54.0	-15.2	2.22 V	103	25.7	13.1
7	#17235.00	50.7 PK	68.2	-17.5	1.82 V	336	33.7	17.0

REMARKS:

- Emission Level(dBuV/m) = Raw Value(dBuV) + Correction Factor(dB/m)
- Correction Factor(dB/m) = Antenna Factor(dB/m) + Cable Factor(dB) – Pre-Amplifier Factor(dB)
- Margin value = Emission Level – Limit value
- The other emission levels were very low against the limit.
- " * ": Fundamental frequency.
- " # ": The radiated frequency is out of the restricted band.

CHANNEL	TX Channel 157	DETECTOR FUNCTION	Peak (PK)
FREQUENCY RANGE	1GHz ~ 40GHz		Average (AV)

ANTENNA POLARITY & TEST DISTANCE: HORIZONTAL AT 3 M

NO.	FREQ. (MHz)	EMISSION LEVEL (dBuV/m)	LIMIT (dBuV/m)	MARGIN (dB)	ANTENNA HEIGHT (m)	TABLE ANGLE (Degree)	RAW VALUE (dBuV)	CORRECTION FACTOR (dB/m)
1	#5617.11	53.1 PK	68.2	-15.1	1.48 H	342	49.8	3.3
2	*5785.00	115.5 PK			1.48 H	342	111.7	3.8
3	*5785.00	108.8 AV			1.48 H	342	105.0	3.8
4	#5941.03	52.3 PK	68.2	-15.9	1.48 H	342	48.1	4.2
5	11570.00	48.3 PK	74.0	-25.7	1.60 H	295	35.6	12.7
6	11570.00	39.3 AV	54.0	-14.7	1.60 H	295	26.6	12.7
7	#17355.00	51.4 PK	68.2	-16.8	1.51 H	311	34.5	16.9

ANTENNA POLARITY & TEST DISTANCE: VERTICAL AT 3 M

NO.	FREQ. (MHz)	EMISSION LEVEL (dBuV/m)	LIMIT (dBuV/m)	MARGIN (dB)	ANTENNA HEIGHT (m)	TABLE ANGLE (Degree)	RAW VALUE (dBuV)	CORRECTION FACTOR (dB/m)
1	#5624.80	50.5 PK	68.2	-17.7	3.02 V	70	47.2	3.3
2	*5785.00	107.9 PK			3.02 V	70	104.1	3.8
3	*5785.00	102.1 AV			3.02 V	70	98.3	3.8
4	#6012.53	51.4 PK	68.2	-16.8	3.02 V	70	47.3	4.1
5	11570.00	47.1 PK	74.0	-26.9	2.18 V	98	34.4	12.7
6	11570.00	38.7 AV	54.0	-15.3	2.18 V	98	26.0	12.7
7	#17355.00	51.0 PK	68.2	-17.2	1.82 V	317	34.1	16.9

REMARKS:

1. Emission Level(dBuV/m) = Raw Value(dBuV) + Correction Factor(dB/m)
2. Correction Factor(dB/m) = Antenna Factor(dB/m) + Cable Factor(dB) – Pre-Amplifier Factor(dB)
3. Margin value = Emission Level – Limit value
4. The other emission levels were very low against the limit.
5. " * ": Fundamental frequency.
6. " # ": The radiated frequency is out of the restricted band.

CHANNEL	TX Channel 165	DETECTOR FUNCTION	Peak (PK)
FREQUENCY RANGE	1GHz ~ 40GHz		Average (AV)

ANTENNA POLARITY & TEST DISTANCE: HORIZONTAL AT 3 M

NO.	FREQ. (MHz)	EMISSION LEVEL (dBuV/m)	LIMIT (dBuV/m)	MARGIN (dB)	ANTENNA HEIGHT (m)	TABLE ANGLE (Degree)	RAW VALUE (dBuV)	CORRECTION FACTOR (dB/m)
1	#5641.18	52.7 PK	68.2	-15.5	1.55 H	335	49.4	3.3
2	*5825.00	117.0 PK			1.55 H	355	113.1	3.9
3	*5825.00	107.6 AV			1.55 H	355	103.7	3.9
4	#5929.70	54.4 PK	68.2	-13.8	1.55 H	335	50.3	4.1
5	11650.00	48.6 PK	74.0	-25.4	1.22 H	306	35.8	12.8
6	11650.00	39.4 AV	54.0	-14.6	1.22 H	306	26.6	12.8
7	#17475.00	52.1 PK	68.2	-16.1	1.47 H	228	34.6	17.5

ANTENNA POLARITY & TEST DISTANCE: VERTICAL AT 3 M

NO.	FREQ. (MHz)	EMISSION LEVEL (dBuV/m)	LIMIT (dBuV/m)	MARGIN (dB)	ANTENNA HEIGHT (m)	TABLE ANGLE (Degree)	RAW VALUE (dBuV)	CORRECTION FACTOR (dB/m)
1	#5569.63	51.5 PK	68.2	-16.7	3.10 V	67	48.2	3.3
2	*5825.00	110.8 PK			3.10 V	67	106.9	3.9
3	*5825.00	102.6 AV			3.10 V	67	98.7	3.9
4	#6000.85	50.7 PK	68.2	-17.5	3.10 V	67	46.6	4.1
5	11650.00	47.9 PK	74.0	-26.1	2.18 V	99	35.1	12.8
6	11650.00	38.9 AV	54.0	-15.1	2.18 V	99	26.1	12.8
7	#17475.00	50.8 PK	68.2	-17.4	1.79 V	326	33.3	17.5

REMARKS:

1. Emission Level(dBuV/m) = Raw Value(dBuV) + Correction Factor(dB/m)
2. Correction Factor(dB/m) = Antenna Factor(dB/m) + Cable Factor(dB) – Pre-Amplifier Factor(dB)
3. Margin value = Emission Level – Limit value
4. The other emission levels were very low against the limit.
5. " * ": Fundamental frequency.
6. " # ": The radiated frequency is out of the restricted band.

802.11ac (VHT20)

CHANNEL	TX Channel 36	DETECTOR FUNCTION	Peak (PK)
FREQUENCY RANGE	1GHz ~ 40GHz		Average (AV)

ANTENNA POLARITY & TEST DISTANCE: HORIZONTAL AT 3 M								
NO.	FREQ. (MHz)	EMISSION LEVEL (dBuV/m)	LIMIT (dBuV/m)	MARGIN (dB)	ANTENNA HEIGHT (m)	TABLE ANGLE (Degree)	RAW VALUE (dBuV)	CORRECTION FACTOR (dB/m)
1	5150.00	67.9 PK	74.0	-6.1	1.04 H	15	64.6	3.3
2	5150.00	53.9 AV	54.0	-0.1	1.04 H	15	50.6	3.3
3	*5180.00	114.7 PK			1.04 H	15	111.4	3.3
4	*5180.00	106.1 AV			1.04 H	15	102.8	3.3
5	#10360.00	48.6 PK	68.2	-19.6	1.36 H	225	36.4	12.2
6	15540.00	52.8 PK	74.0	-21.2	1.47 H	205	39.6	13.2
7	15540.00	41.8 AV	54.0	-12.2	1.47 H	205	28.6	13.2

ANTENNA POLARITY & TEST DISTANCE: VERTICAL AT 3 M								
NO.	FREQ. (MHz)	EMISSION LEVEL (dBuV/m)	LIMIT (dBuV/m)	MARGIN (dB)	ANTENNA HEIGHT (m)	TABLE ANGLE (Degree)	RAW VALUE (dBuV)	CORRECTION FACTOR (dB/m)
1	5150.00	64.8 PK	74.0	-9.2	2.79 V	88	61.5	3.3
2	5150.00	50.2 AV	54.0	-3.8	2.79 V	88	46.9	3.3
3	*5180.00	109.3 PK			2.79 V	88	106.0	3.3
4	*5180.00	101.2 AV			2.79 V	88	97.9	3.3
5	#10360.00	48.4 PK	68.2	-19.8	2.25 V	115	36.2	12.2
6	15540.00	50.9 PK	74.0	-23.1	1.81 V	331	37.7	13.2
7	15540.00	40.8 AV	54.0	-13.2	1.81 V	331	27.6	13.2

REMARKS:

1. Emission Level(dBuV/m) = Raw Value(dBuV) + Correction Factor(dB/m)
2. Correction Factor(dB/m) = Antenna Factor(dB/m) + Cable Factor(dB) – Pre-Amplifier Factor(dB)
3. Margin value = Emission Level – Limit value
4. The other emission levels were very low against the limit.
5. " * ": Fundamental frequency.
6. " # ": The radiated frequency is out of the restricted band.

CHANNEL	TX Channel 40	DETECTOR FUNCTION	Peak (PK)
FREQUENCY RANGE	1GHz ~ 40GHz		Average (AV)

ANTENNA POLARITY & TEST DISTANCE: HORIZONTAL AT 3 M

NO.	FREQ. (MHz)	EMISSION LEVEL (dBuV/m)	LIMIT (dBuV/m)	MARGIN (dB)	ANTENNA HEIGHT (m)	TABLE ANGLE (Degree)	RAW VALUE (dBuV)	CORRECTION FACTOR (dB/m)
1	*5200.00	115.3 PK			1.57 H	4	112.2	3.1
2	*5200.00	106.5 AV			1.57 H	4	103.4	3.1
3	#10400.00	48.3 PK	68.2	-19.9	1.49 H	287	35.9	12.4
4	15600.00	50.2 PK	74.0	-23.8	1.38 H	205	37.0	13.2
5	15600.00	40.4 AV	54.0	-13.6	1.38 H	205	27.2	13.2

ANTENNA POLARITY & TEST DISTANCE: VERTICAL AT 3 M

NO.	FREQ. (MHz)	EMISSION LEVEL (dBuV/m)	LIMIT (dBuV/m)	MARGIN (dB)	ANTENNA HEIGHT (m)	TABLE ANGLE (Degree)	RAW VALUE (dBuV)	CORRECTION FACTOR (dB/m)
1	*5200.00	108.9 PK			2.88 V	84	105.8	3.1
2	*5200.00	100.8 AV			2.88 V	84	97.7	3.1
3	#10400.00	47.4 PK	68.2	-20.8	2.16 V	103	35.0	12.4
4	15600.00	51.4 PK	74.0	-22.6	1.82 V	310	38.2	13.2
5	15600.00	41.2 AV	54.0	-12.8	1.82 V	310	28.0	13.2

REMARKS:

1. Emission Level(dBuV/m) = Raw Value(dBuV) + Correction Factor(dB/m)
2. Correction Factor(dB/m) = Antenna Factor(dB/m) + Cable Factor(dB) – Pre-Amplifier Factor(dB)
3. Margin value = Emission Level – Limit value
4. The other emission levels were very low against the limit.
5. " * ": Fundamental frequency.
6. " # ": The radiated frequency is out of the restricted band.

CHANNEL	TX Channel 48	DETECTOR FUNCTION	Peak (PK)
FREQUENCY RANGE	1GHz ~ 40GHz		Average (AV)

ANTENNA POLARITY & TEST DISTANCE: HORIZONTAL AT 3 M

NO.	FREQ. (MHz)	EMISSION LEVEL (dBuV/m)	LIMIT (dBuV/m)	MARGIN (dB)	ANTENNA HEIGHT (m)	TABLE ANGLE (Degree)	RAW VALUE (dBuV)	CORRECTION FACTOR (dB/m)
1	*5240.00	115.8 PK			1.00 H	36	113.0	2.8
2	*5240.00	106.7 AV			1.00 H	36	103.9	2.8
3	5350.00	52.6 PK	74.0	-21.4	1.00 H	36	49.6	3.0
4	5350.00	40.6 AV	54.0	-13.4	1.00 H	36	37.6	3.0
5	#10480.00	48.5 PK	68.2	-19.7	1.36 H	205	36.0	12.5
6	15720.00	49.8 PK	74.0	-24.2	1.45 H	227	37.5	12.3
7	15720.00	40.0 AV	54.0	-14.0	1.45 H	227	27.7	12.3

ANTENNA POLARITY & TEST DISTANCE: VERTICAL AT 3 M

NO.	FREQ. (MHz)	EMISSION LEVEL (dBuV/m)	LIMIT (dBuV/m)	MARGIN (dB)	ANTENNA HEIGHT (m)	TABLE ANGLE (Degree)	RAW VALUE (dBuV)	CORRECTION FACTOR (dB/m)
1	*5240.00	109.2 PK			2.90 V	89	106.4	2.8
2	*5240.00	101.3 AV			2.90 V	89	98.5	2.8
3	5350.00	50.3 PK	74.0	-23.7	2.90 V	89	47.3	3.0
4	5350.00	39.2 AV	54.0	-14.8	2.90 V	89	36.2	3.0
5	#10480.00	47.6 PK	68.2	-20.6	2.17 V	115	35.1	12.5
6	15720.00	51.5 PK	74.0	-22.5	1.75 V	320	39.2	12.3
7	15720.00	41.1 AV	54.0	-12.9	1.75 V	320	28.8	12.3

REMARKS:

1. Emission Level(dBuV/m) = Raw Value(dBuV) + Correction Factor(dB/m)
2. Correction Factor(dB/m) = Antenna Factor(dB/m) + Cable Factor(dB) – Pre-Amplifier Factor(dB)
3. Margin value = Emission Level – Limit value
4. The other emission levels were very low against the limit.
5. " * ": Fundamental frequency.
6. " # ": The radiated frequency is out of the restricted band.

CHANNEL	TX Channel 52	DETECTOR FUNCTION	Peak (PK)
FREQUENCY RANGE	1GHz ~ 40GHz		Average (AV)

ANTENNA POLARITY & TEST DISTANCE: HORIZONTAL AT 3 M

NO.	FREQ. (MHz)	EMISSION LEVEL (dBuV/m)	LIMIT (dBuV/m)	MARGIN (dB)	ANTENNA HEIGHT (m)	TABLE ANGLE (Degree)	RAW VALUE (dBuV)	CORRECTION FACTOR (dB/m)
1	5150.00	53.3 PK	74.0	-20.7	1.00 H	46	50.0	3.3
2	5150.00	41.1 AV	54.0	-12.9	1.00 H	46	37.8	3.3
3	*5260.00	116.1 PK			1.01 H	23	113.4	2.7
4	*5260.00	106.8 AV			1.01 H	23	104.1	2.7
5	#10520.00	48.6 PK	68.2	-19.6	1.36 H	195	36.0	12.6
6	15780.00	50.2 PK	74.0	-23.8	1.45 H	232	38.2	12.0
7	15780.00	40.2 AV	54.0	-13.8	1.45 H	232	28.2	12.0

ANTENNA POLARITY & TEST DISTANCE: VERTICAL AT 3 M

NO.	FREQ. (MHz)	EMISSION LEVEL (dBuV/m)	LIMIT (dBuV/m)	MARGIN (dB)	ANTENNA HEIGHT (m)	TABLE ANGLE (Degree)	RAW VALUE (dBuV)	CORRECTION FACTOR (dB/m)
1	5150.00	49.5 PK	74.0	-24.5	2.80 V	102	46.2	3.3
2	5150.00	38.9 AV	54.0	-15.1	2.80 V	102	35.6	3.3
3	*5260.00	109.0 PK			2.80 V	102	106.3	2.7
4	*5260.00	100.9 AV			2.80 V	102	98.2	2.7
5	#10520.00	47.4 PK	68.2	-20.8	2.26 V	88	34.8	12.6
6	15780.00	51.4 PK	74.0	-22.6	1.82 V	336	39.4	12.0
7	15780.00	40.8 AV	54.0	-13.2	1.82 V	336	28.8	12.0

REMARKS:

- Emission Level(dBuV/m) = Raw Value(dBuV) + Correction Factor(dB/m)
- Correction Factor(dB/m) = Antenna Factor(dB/m) + Cable Factor(dB) – Pre-Amplifier Factor(dB)
- Margin value = Emission Level – Limit value
- The other emission levels were very low against the limit.
- " * ": Fundamental frequency.
- " # ": The radiated frequency is out of the restricted band.

CHANNEL	TX Channel 60	DETECTOR FUNCTION	Peak (PK)
FREQUENCY RANGE	1GHz ~ 40GHz		Average (AV)

ANTENNA POLARITY & TEST DISTANCE: HORIZONTAL AT 3 M

NO.	FREQ. (MHz)	EMISSION LEVEL (dBuV/m)	LIMIT (dBuV/m)	MARGIN (dB)	ANTENNA HEIGHT (m)	TABLE ANGLE (Degree)	RAW VALUE (dBuV)	CORRECTION FACTOR (dB/m)
1	*5300.00	116.3 PK			1.11 H	32	113.5	2.8
2	*5300.00	106.7 AV			1.11 H	32	103.9	2.8
3	10600.00	47.9 PK	74.0	-26.1	1.25 H	240	35.4	12.5
4	10600.00	39.2 AV	54.0	-14.8	1.25 H	240	26.7	12.5
5	15900.00	50.4 PK	74.0	-23.6	1.33 H	149	38.1	12.3
6	15900.00	40.6 AV	54.0	-13.4	1.33 H	149	28.3	12.3

ANTENNA POLARITY & TEST DISTANCE: VERTICAL AT 3 M

NO.	FREQ. (MHz)	EMISSION LEVEL (dBuV/m)	LIMIT (dBuV/m)	MARGIN (dB)	ANTENNA HEIGHT (m)	TABLE ANGLE (Degree)	RAW VALUE (dBuV)	CORRECTION FACTOR (dB/m)
1	*5300.00	109.4 PK			2.85 V	98	106.6	2.8
2	*5300.00	101.2 AV			2.85 V	98	98.4	2.8
3	10600.00	47.6 PK	74.0	-26.4	2.25 V	113	35.1	12.5
4	10600.00	38.7 AV	54.0	-15.3	2.25 V	113	26.2	12.5
5	15900.00	51.2 PK	74.0	-22.8	1.76 V	324	38.9	12.3
6	15900.00	40.9 AV	54.0	-13.1	1.76 V	324	28.6	12.3

REMARKS:

1. Emission Level(dBuV/m) = Raw Value(dBuV) + Correction Factor(dB/m)
2. Correction Factor(dB/m) = Antenna Factor(dB/m) + Cable Factor(dB) – Pre-Amplifier Factor(dB)
3. Margin value = Emission Level – Limit value
4. The other emission levels were very low against the limit.
5. " * ": Fundamental frequency.

CHANNEL	TX Channel 64	DETECTOR FUNCTION	Peak (PK)
FREQUENCY RANGE	1GHz ~ 40GHz		Average (AV)

ANTENNA POLARITY & TEST DISTANCE: HORIZONTAL AT 3 M

NO.	FREQ. (MHz)	EMISSION LEVEL (dBuV/m)	LIMIT (dBuV/m)	MARGIN (dB)	ANTENNA HEIGHT (m)	TABLE ANGLE (Degree)	RAW VALUE (dBuV)	CORRECTION FACTOR (dB/m)
1	*5320.00	116.3 PK			1.06 H	35	113.5	2.8
2	*5320.00	106.8 AV			1.06 H	35	104.0	2.8
3	5350.00	65.2 PK	74.0	-8.8	1.06 H	35	62.2	3.0
4	5350.00	51.3 AV	54.0	-2.7	1.06 H	35	48.3	3.0
5	10640.00	48.3 PK	74.0	-25.7	1.36 H	158	35.8	12.5
6	10640.00	39.5 AV	54.0	-14.5	1.36 H	158	27.0	12.5
7	15960.00	50.3 PK	74.0	-23.7	1.47 H	206	37.6	12.7
8	15960.00	40.4 AV	54.0	-13.6	1.47 H	206	27.7	12.7

ANTENNA POLARITY & TEST DISTANCE: VERTICAL AT 3 M

NO.	FREQ. (MHz)	EMISSION LEVEL (dBuV/m)	LIMIT (dBuV/m)	MARGIN (dB)	ANTENNA HEIGHT (m)	TABLE ANGLE (Degree)	RAW VALUE (dBuV)	CORRECTION FACTOR (dB/m)
1	*5320.00	108.9 PK			2.90 V	82	106.1	2.8
2	*5320.00	100.9 AV			2.90 V	82	98.1	2.8
3	5350.00	61.5 PK	74.0	-12.5	2.90 V	82	58.5	3.0
4	5350.00	48.3 AV	54.0	-5.7	2.90 V	82	45.3	3.0
5	10640.00	47.8 PK	74.0	-26.2	2.24 V	95	35.3	12.5
6	10640.00	39.0 AV	54.0	-15.0	2.24 V	95	26.5	12.5
7	15960.00	50.8 PK	74.0	-23.2	1.82 V	320	38.1	12.7
8	15960.00	40.7 AV	54.0	-13.3	1.82 V	320	28.0	12.7

REMARKS:

1. Emission Level(dBuV/m) = Raw Value(dBuV) + Correction Factor(dB/m)
2. Correction Factor(dB/m) = Antenna Factor(dB/m) + Cable Factor(dB) – Pre-Amplifier Factor(dB)
3. Margin value = Emission Level – Limit value
4. The other emission levels were very low against the limit.
5. " * ": Fundamental frequency.

CHANNEL	TX Channel 100	DETECTOR FUNCTION	Peak (PK)
FREQUENCY RANGE	1GHz ~ 40GHz		Average (AV)

ANTENNA POLARITY & TEST DISTANCE: HORIZONTAL AT 3 M

NO.	FREQ. (MHz)	EMISSION LEVEL (dBuV/m)	LIMIT (dBuV/m)	MARGIN (dB)	ANTENNA HEIGHT (m)	TABLE ANGLE (Degree)	RAW VALUE (dBuV)	CORRECTION FACTOR (dB/m)
1	5460.00	64.4 PK	74.0	-9.6	1.11 H	45	61.1	3.3
2	5460.00	51.4 AV	54.0	-2.6	1.11 H	45	48.1	3.3
3	#5470.00	66.9 PK	68.2	-1.3	1.11 H	45	63.6	3.3
4	*5500.00	112.0 PK			1.11 H	45	108.7	3.3
5	*5500.00	103.4 AV			1.11 H	45	100.1	3.3
6	11000.00	47.9 PK	74.0	-26.1	1.36 H	205	34.8	13.1
7	11000.00	39.0 AV	54.0	-15.0	1.36 H	205	25.9	13.1
8	#16500.00	50.4 PK	68.2	-17.8	2.04 H	174	36.1	14.3

ANTENNA POLARITY & TEST DISTANCE: VERTICAL AT 3 M

NO.	FREQ. (MHz)	EMISSION LEVEL (dBuV/m)	LIMIT (dBuV/m)	MARGIN (dB)	ANTENNA HEIGHT (m)	TABLE ANGLE (Degree)	RAW VALUE (dBuV)	CORRECTION FACTOR (dB/m)
1	5460.00	61.1 PK	74.0	-12.9	2.87 V	103	57.8	3.3
2	5460.00	48.3 AV	54.0	-5.7	2.87 V	103	45.0	3.3
3	#5470.00	63.8 PK	68.2	-4.4	2.87 V	103	60.5	3.3
4	*5500.00	108.7 PK			2.87 V	103	105.4	3.3
5	*5500.00	99.6 AV			2.87 V	103	96.3	3.3
6	11000.00	47.4 PK	74.0	-26.6	2.17 V	106	34.3	13.1
7	11000.00	38.8 AV	54.0	-15.2	2.17 V	106	25.7	13.1
8	#16500.00	51.4 PK	68.2	-16.8	1.76 V	325	37.1	14.3

REMARKS:

- Emission Level(dBuV/m) = Raw Value(dBuV) + Correction Factor(dB/m)
- Correction Factor(dB/m) = Antenna Factor(dB/m) + Cable Factor(dB) – Pre-Amplifier Factor(dB)
- Margin value = Emission Level – Limit value
- The other emission levels were very low against the limit.
- " * ": Fundamental frequency.
- " # ": The radiated frequency is out of the restricted band.

CHANNEL	TX Channel 116	DETECTOR FUNCTION	Peak (PK)
FREQUENCY RANGE	1GHz ~ 40GHz		Average (AV)

ANTENNA POLARITY & TEST DISTANCE: HORIZONTAL AT 3 M

NO.	FREQ. (MHz)	EMISSION LEVEL (dBuV/m)	LIMIT (dBuV/m)	MARGIN (dB)	ANTENNA HEIGHT (m)	TABLE ANGLE (Degree)	RAW VALUE (dBuV)	CORRECTION FACTOR (dB/m)
1	*5580.00	112.2 PK			1.07 H	41	108.9	3.3
2	*5580.00	103.8 AV			1.07 H	41	100.5	3.3
3	11160.00	47.7 PK	74.0	-26.3	1.38 H	218	34.8	12.9
4	11160.00	38.8 AV	54.0	-15.2	1.38 H	218	25.9	12.9
5	#16740.00	50.5 PK	68.2	-17.7	2.02 H	172	35.1	15.4

ANTENNA POLARITY & TEST DISTANCE: VERTICAL AT 3 M

NO.	FREQ. (MHz)	EMISSION LEVEL (dBuV/m)	LIMIT (dBuV/m)	MARGIN (dB)	ANTENNA HEIGHT (m)	TABLE ANGLE (Degree)	RAW VALUE (dBuV)	CORRECTION FACTOR (dB/m)
1	*5580.00	108.9 PK			2.82 V	101	105.6	3.3
2	*5580.00	99.8 AV			2.82 V	101	96.5	3.3
3	11160.00	47.9 PK	74.0	-26.1	2.26 V	97	35.0	12.9
4	11160.00	39.1 AV	54.0	-14.9	2.26 V	97	26.2	12.9
5	#16740.00	50.9 PK	68.2	-17.3	1.83 V	310	35.5	15.4

REMARKS:

1. Emission Level(dBuV/m) = Raw Value(dBuV) + Correction Factor(dB/m)
2. Correction Factor(dB/m) = Antenna Factor(dB/m) + Cable Factor(dB) – Pre-Amplifier Factor(dB)
3. Margin value = Emission Level – Limit value
4. The other emission levels were very low against the limit.
5. " * ": Fundamental frequency.
6. " # ": The radiated frequency is out of the restricted band.

CHANNEL	TX Channel 140	DETECTOR FUNCTION	Peak (PK)
FREQUENCY RANGE	1GHz ~ 40GHz		Average (AV)

ANTENNA POLARITY & TEST DISTANCE: HORIZONTAL AT 3 M

NO.	FREQ. (MHz)	EMISSION LEVEL (dBuV/m)	LIMIT (dBuV/m)	MARGIN (dB)	ANTENNA HEIGHT (m)	TABLE ANGLE (Degree)	RAW VALUE (dBuV)	CORRECTION FACTOR (dB/m)
1	*5700.00	113.3 PK			1.05 H	31	109.9	3.4
2	*5700.00	104.2 AV			1.05 H	31	100.8	3.4
3	#5725.00	66.7 PK	68.2	-1.5	1.05 H	31	63.2	3.5
4	11400.00	48.6 PK	74.0	-25.4	1.25 H	209	35.3	13.3
5	11400.00	40.1 AV	54.0	-13.9	1.25 H	209	26.8	13.3
6	#17100.00	50.4 PK	68.2	-17.8	1.47 H	236	34.0	16.4

ANTENNA POLARITY & TEST DISTANCE: VERTICAL AT 3 M

NO.	FREQ. (MHz)	EMISSION LEVEL (dBuV/m)	LIMIT (dBuV/m)	MARGIN (dB)	ANTENNA HEIGHT (m)	TABLE ANGLE (Degree)	RAW VALUE (dBuV)	CORRECTION FACTOR (dB/m)
1	*5700.00	108.2 PK			2.85 V	75	104.8	3.4
2	*5700.00	99.3 AV			2.85 V	75	95.9	3.4
3	#5725.00	63.2 PK	68.2	-5.0	2.85 V	75	59.7	3.5
4	11400.00	47.0 PK	74.0	-27.0	2.20 V	110	33.7	13.3
5	11400.00	38.6 AV	54.0	-15.4	2.20 V	110	25.3	13.3
6	#17100.00	51.6 PK	68.2	-16.6	1.72 V	336	35.2	16.4

REMARKS:

1. Emission Level(dBuV/m) = Raw Value(dBuV) + Correction Factor(dB/m)
2. Correction Factor(dB/m) = Antenna Factor(dB/m) + Cable Factor(dB) – Pre-Amplifier Factor(dB)
3. Margin value = Emission Level – Limit value
4. The other emission levels were very low against the limit.
5. " * ": Fundamental frequency.
6. " # ": The radiated frequency is out of the restricted band.

CHANNEL	TX Channel 144	DETECTOR FUNCTION	Peak (PK)
FREQUENCY RANGE	1GHz ~ 40GHz		Average (AV)

ANTENNA POLARITY & TEST DISTANCE: HORIZONTAL AT 3 M

NO.	FREQ. (MHz)	EMISSION LEVEL (dBuV/m)	LIMIT (dBuV/m)	MARGIN (dB)	ANTENNA HEIGHT (m)	TABLE ANGLE (Degree)	RAW VALUE (dBuV)	CORRECTION FACTOR (dB/m)
1	*5720.00	111.6 PK			1.43 H	360	108.1	3.5
2	*5720.00	103.2 AV			1.43 H	360	99.7	3.5
3	#5850.00	51.9 PK	68.2	-16.3	1.43 H	360	47.9	4.0
4	11440.00	49.0 PK	74.0	-25.0	1.41 H	331	35.8	13.2
5	11440.00	40.1 AV	54.0	-13.9	1.41 H	331	26.9	13.2
6	#17160.00	50.8 PK	68.2	-17.4	1.22 H	311	34.0	16.8

ANTENNA POLARITY & TEST DISTANCE: VERTICAL AT 3 M

NO.	FREQ. (MHz)	EMISSION LEVEL (dBuV/m)	LIMIT (dBuV/m)	MARGIN (dB)	ANTENNA HEIGHT (m)	TABLE ANGLE (Degree)	RAW VALUE (dBuV)	CORRECTION FACTOR (dB/m)
1	*5720.00	108.2 PK			2.76 V	111	104.7	3.5
2	*5720.00	99.3 AV			2.76 V	111	95.8	3.5
3	#5850.00	48.4 PK	68.2	-19.8	2.76 V	111	44.4	4.0
4	11440.00	47.9 PK	74.0	-26.1	2.16 V	102	34.7	13.2
5	11440.00	39.5 AV	54.0	-14.5	2.16 V	102	26.3	13.2
6	#17160.00	50.9 PK	68.2	-17.3	1.83 V	344	34.1	16.8

REMARKS:

1. Emission Level(dBuV/m) = Raw Value(dBuV) + Correction Factor(dB/m)
2. Correction Factor(dB/m) = Antenna Factor(dB/m) + Cable Factor(dB) – Pre-Amplifier Factor(dB)
3. Margin value = Emission Level – Limit value
4. The other emission levels were very low against the limit.
5. " * ": Fundamental frequency.
6. " # ": The radiated frequency is out of the restricted band.

CHANNEL	TX Channel 149	DETECTOR FUNCTION	Peak (PK)
FREQUENCY RANGE	1GHz ~ 40GHz		Average (AV)

ANTENNA POLARITY & TEST DISTANCE: HORIZONTAL AT 3 M

NO.	FREQ. (MHz)	EMISSION LEVEL (dBuV/m)	LIMIT (dBuV/m)	MARGIN (dB)	ANTENNA HEIGHT (m)	TABLE ANGLE (Degree)	RAW VALUE (dBuV)	CORRECTION FACTOR (dB/m)
1	#5644.55	58.3 PK	68.2	-9.9	1.05 H	41	55.0	3.3
2	*5745.00	116.7 PK			1.05 H	41	113.1	3.6
3	*5745.00	109.0 AV			1.05 H	41	105.4	3.6
4	#5930.25	52.7 PK	68.2	-15.5	1.05 H	41	48.6	4.1
5	11490.00	48.5 PK	74.0	-25.5	1.32 H	250	35.4	13.1
6	11490.00	39.8 AV	54.0	-14.2	1.32 H	250	26.7	13.1
7	#17235.00	50.7 PK	68.2	-17.5	1.34 H	302	33.7	17.0

ANTENNA POLARITY & TEST DISTANCE: VERTICAL AT 3 M

NO.	FREQ. (MHz)	EMISSION LEVEL (dBuV/m)	LIMIT (dBuV/m)	MARGIN (dB)	ANTENNA HEIGHT (m)	TABLE ANGLE (Degree)	RAW VALUE (dBuV)	CORRECTION FACTOR (dB/m)
1	#5644.95	54.4 PK	68.2	-13.8	3.14 V	296	51.1	3.3
2	*5745.00	113.8 PK			3.14 V	296	110.2	3.6
3	*5745.00	104.2 AV			3.14 V	296	100.6	3.6
4	#6013.08	51.9 PK	68.2	-16.3	3.14 V	296	47.8	4.1
5	11490.00	47.9 PK	74.0	-26.1	2.25 V	110	34.8	13.1
6	11490.00	39.1 AV	54.0	-14.9	2.25 V	110	26.0	13.1
7	#17235.00	50.6 PK	68.2	-17.6	1.81 V	314	33.6	17.0

REMARKS:

1. Emission Level(dBuV/m) = Raw Value(dBuV) + Correction Factor(dB/m)
2. Correction Factor(dB/m) = Antenna Factor(dB/m) + Cable Factor(dB) – Pre-Amplifier Factor(dB)
3. Margin value = Emission Level – Limit value
4. The other emission levels were very low against the limit.
5. " * ": Fundamental frequency.
6. " # ": The radiated frequency is out of the restricted band.

CHANNEL	TX Channel 157	DETECTOR FUNCTION	Peak (PK)
FREQUENCY RANGE	1GHz ~ 40GHz		Average (AV)

ANTENNA POLARITY & TEST DISTANCE: HORIZONTAL AT 3 M

NO.	FREQ. (MHz)	EMISSION LEVEL (dBuV/m)	LIMIT (dBuV/m)	MARGIN (dB)	ANTENNA HEIGHT (m)	TABLE ANGLE (Degree)	RAW VALUE (dBuV)	CORRECTION FACTOR (dB/m)
1	#5631.28	52.8 PK	68.2	-15.4	1.16 H	42	49.5	3.3
2	*5785.00	116.6 PK			1.16 H	42	112.8	3.8
3	*5785.00	109.4 AV			1.16 H	42	105.6	3.8
4	#5935.43	53.1 PK	68.2	-15.1	1.16 H	42	48.9	4.2
5	11570.00	48.5 PK	74.0	-25.5	1.55 H	206	35.8	12.7
6	11570.00	39.8 AV	54.0	-14.2	1.55 H	206	27.1	12.7
7	#17355.00	50.0 PK	68.2	-18.2	1.47 H	236	33.1	16.9

ANTENNA POLARITY & TEST DISTANCE: VERTICAL AT 3 M

NO.	FREQ. (MHz)	EMISSION LEVEL (dBuV/m)	LIMIT (dBuV/m)	MARGIN (dB)	ANTENNA HEIGHT (m)	TABLE ANGLE (Degree)	RAW VALUE (dBuV)	CORRECTION FACTOR (dB/m)
1	#5641.34	52.3 PK	68.2	-15.9	3.30 V	290	49.0	3.3
2	*5785.00	108.5 PK			3.30 V	290	104.7	3.8
3	*5785.00	104.3 AV			3.30 V	290	100.5	3.8
4	#5966.79	52.1 PK	68.2	-16.1	3.30 V	290	47.9	4.2
5	11570.00	47.5 PK	74.0	-26.5	2.22 V	102	34.8	12.7
6	11570.00	38.8 AV	54.0	-15.2	2.22 V	102	26.1	12.7
7	#17355.00	50.8 PK	68.2	-17.4	1.76 V	335	33.9	16.9

REMARKS:

1. Emission Level(dBuV/m) = Raw Value(dBuV) + Correction Factor(dB/m)
2. Correction Factor(dB/m) = Antenna Factor(dB/m) + Cable Factor(dB) – Pre-Amplifier Factor(dB)
3. Margin value = Emission Level – Limit value
4. The other emission levels were very low against the limit.
5. " * ": Fundamental frequency.
6. " # ": The radiated frequency is out of the restricted band.

CHANNEL	TX Channel 165	DETECTOR FUNCTION	Peak (PK)
FREQUENCY RANGE	1GHz ~ 40GHz		Average (AV)

ANTENNA POLARITY & TEST DISTANCE: HORIZONTAL AT 3 M

NO.	FREQ. (MHz)	EMISSION LEVEL (dBuV/m)	LIMIT (dBuV/m)	MARGIN (dB)	ANTENNA HEIGHT (m)	TABLE ANGLE (Degree)	RAW VALUE (dBuV)	CORRECTION FACTOR (dB/m)
1	#5588.76	52.1 PK	68.2	-16.1	1.26 H	52	48.8	3.3
2	*5825.00	112.3 PK			1.26 H	52	108.4	3.9
3	*5825.00	109.0 AV			1.26 H	52	105.1	3.9
4	#5932.60	53.6 PK	68.2	-14.6	1.26 H	52	49.5	4.1
5	11650.00	48.6 PK	74.0	-25.4	1.33 H	305	35.8	12.8
6	11650.00	39.8 AV	54.0	-14.2	1.33 H	305	27.0	12.8
7	#17475.00	49.8 PK	68.2	-18.4	1.45 H	258	32.3	17.5

ANTENNA POLARITY & TEST DISTANCE: VERTICAL AT 3 M

NO.	FREQ. (MHz)	EMISSION LEVEL (dBuV/m)	LIMIT (dBuV/m)	MARGIN (dB)	ANTENNA HEIGHT (m)	TABLE ANGLE (Degree)	RAW VALUE (dBuV)	CORRECTION FACTOR (dB/m)
1	#5587.16	50.8 PK	68.2	-17.4	3.40 V	283	47.5	3.3
2	*5825.00	109.6 PK			3.40 V	283	105.7	3.9
3	*5825.00	104.1 AV			3.40 V	283	100.2	3.9
4	#5934.80	51.9 PK	68.2	-16.3	3.40 V	283	47.7	4.2
5	11650.00	48.0 PK	74.0	-26.0	2.26 V	103	35.2	12.8
6	11650.00	39.2 AV	54.0	-14.8	2.26 V	103	26.4	12.8
7	#17475.00	51.3 PK	68.2	-16.9	1.79 V	337	33.8	17.5

REMARKS:

1. Emission Level(dBuV/m) = Raw Value(dBuV) + Correction Factor(dB/m)
2. Correction Factor(dB/m) = Antenna Factor(dB/m) + Cable Factor(dB) – Pre-Amplifier Factor(dB)
3. Margin value = Emission Level – Limit value
4. The other emission levels were very low against the limit.
5. " * ": Fundamental frequency.
6. " # ": The radiated frequency is out of the restricted band.

802.11ac (VHT40)

CHANNEL	TX Channel 38	DETECTOR FUNCTION	Peak (PK)
FREQUENCY RANGE	1GHz ~ 40GHz		Average (AV)

ANTENNA POLARITY & TEST DISTANCE: HORIZONTAL AT 3 M

NO.	FREQ. (MHz)	EMISSION LEVEL (dBuV/m)	LIMIT (dBuV/m)	MARGIN (dB)	ANTENNA HEIGHT (m)	TABLE ANGLE (Degree)	RAW VALUE (dBuV)	CORRECTION FACTOR (dB/m)
1	5150.00	66.8 PK	74.0	-7.2	1.66 H	33	63.5	3.3
2	5150.00	53.7 AV	54.0	-0.3	1.66 H	33	50.4	3.3
3	*5190.00	106.5 PK			1.66 H	33	103.3	3.2
4	*5190.00	96.9 AV			1.66 H	33	93.7	3.2
5	#10380.00	48.5 PK	68.2	-19.7	1.36 H	225	36.1	12.4
6	15570.00	49.9 PK	74.0	-24.1	1.54 H	248	36.6	13.3
7	15570.00	40.0 AV	54.0	-14.0	1.54 H	248	26.7	13.3

ANTENNA POLARITY & TEST DISTANCE: VERTICAL AT 3 M

NO.	FREQ. (MHz)	EMISSION LEVEL (dBuV/m)	LIMIT (dBuV/m)	MARGIN (dB)	ANTENNA HEIGHT (m)	TABLE ANGLE (Degree)	RAW VALUE (dBuV)	CORRECTION FACTOR (dB/m)
1	5150.00	62.1 PK	74.0	-11.9	2.90 V	100	58.8	3.3
2	5150.00	49.3 AV	54.0	-4.7	2.90 V	100	46.0	3.3
3	*5190.00	102.1 PK			2.90 V	100	98.9	3.2
4	*5190.00	92.2 AV			2.90 V	100	89.0	3.2
5	#10380.00	47.5 PK	68.2	-20.7	2.21 V	116	35.1	12.4
6	15570.00	51.2 PK	74.0	-22.8	1.82 V	307	37.9	13.3
7	15570.00	40.6 AV	54.0	-13.4	1.82 V	307	27.3	13.3

REMARKS:

- Emission Level(dBuV/m) = Raw Value(dBuV) + Correction Factor(dB/m)
- Correction Factor(dB/m) = Antenna Factor(dB/m) + Cable Factor(dB) – Pre-Amplifier Factor(dB)
- Margin value = Emission Level – Limit value
- The other emission levels were very low against the limit.
- " * ": Fundamental frequency.
- " # ": The radiated frequency is out of the restricted band.

CHANNEL	TX Channel 46	DETECTOR FUNCTION	Peak (PK)
FREQUENCY RANGE	1GHz ~ 40GHz		Average (AV)

ANTENNA POLARITY & TEST DISTANCE: HORIZONTAL AT 3 M

NO.	FREQ. (MHz)	EMISSION LEVEL (dBuV/m)	LIMIT (dBuV/m)	MARGIN (dB)	ANTENNA HEIGHT (m)	TABLE ANGLE (Degree)	RAW VALUE (dBuV)	CORRECTION FACTOR (dB/m)
1	*5230.00	113.2 PK			1.33 H	25	110.3	2.9
2	*5230.00	103.1 AV			1.33 H	25	100.2	2.9
3	5350.00	65.3 PK	74.0	-8.7	1.33 H	25	62.3	3.0
4	5350.00	46.2 AV	54.0	-7.8	1.33 H	25	43.2	3.0
5	#10460.00	49.1 PK	68.2	-19.1	1.47 H	305	36.6	12.5
6	15690.00	50.1 PK	74.0	-23.9	1.28 H	258	37.6	12.5
7	15690.00	40.3 AV	54.0	-13.7	1.28 H	258	27.8	12.5

ANTENNA POLARITY & TEST DISTANCE: VERTICAL AT 3 M

NO.	FREQ. (MHz)	EMISSION LEVEL (dBuV/m)	LIMIT (dBuV/m)	MARGIN (dB)	ANTENNA HEIGHT (m)	TABLE ANGLE (Degree)	RAW VALUE (dBuV)	CORRECTION FACTOR (dB/m)
1	*5230.00	109.1 PK			2.90 V	86	106.2	2.9
2	*5230.00	99.2 AV			2.90 V	86	96.3	2.9
3	5350.00	61.2 PK	74.0	-12.8	2.90 V	86	58.2	3.0
4	5350.00	42.1 AV	54.0	-11.9	2.90 V	86	39.1	3.0
5	#10460.00	47.8 PK	68.2	-20.4	2.21 V	108	35.3	12.5
6	15690.00	51.4 PK	74.0	-22.6	1.78 V	312	38.9	12.5
7	15690.00	41.3 AV	54.0	-12.7	1.78 V	312	28.8	12.5

REMARKS:

1. Emission Level(dBuV/m) = Raw Value(dBuV) + Correction Factor(dB/m)
2. Correction Factor(dB/m) = Antenna Factor(dB/m) + Cable Factor(dB) – Pre-Amplifier Factor(dB)
3. Margin value = Emission Level – Limit value
4. The other emission levels were very low against the limit.
5. " * ": Fundamental frequency.
6. " # ": The radiated frequency is out of the restricted band.

CHANNEL	TX Channel 54	DETECTOR FUNCTION	Peak (PK)
FREQUENCY RANGE	1GHz ~ 40GHz		Average (AV)

ANTENNA POLARITY & TEST DISTANCE: HORIZONTAL AT 3 M

NO.	FREQ. (MHz)	EMISSION LEVEL (dBuV/m)	LIMIT (dBuV/m)	MARGIN (dB)	ANTENNA HEIGHT (m)	TABLE ANGLE (Degree)	RAW VALUE (dBuV)	CORRECTION FACTOR (dB/m)
1	5150.00	62.8 PK	74.0	-11.2	1.31 H	35	59.5	3.3
2	5150.00	49.2 AV	54.0	-4.8	1.31 H	35	45.9	3.3
3	*5270.00	112.7 PK			1.31 H	35	110.0	2.7
4	*5270.00	102.9 AV			1.31 H	35	100.2	2.7
5	#10540.00	49.1 PK	68.2	-19.1	1.36 H	204	36.5	12.6
6	15810.00	50.6 PK	74.0	-23.4	1.47 H	304	38.6	12.0
7	15810.00	40.5 AV	54.0	-13.5	1.47 H	304	28.5	12.0

ANTENNA POLARITY & TEST DISTANCE: VERTICAL AT 3 M

NO.	FREQ. (MHz)	EMISSION LEVEL (dBuV/m)	LIMIT (dBuV/m)	MARGIN (dB)	ANTENNA HEIGHT (m)	TABLE ANGLE (Degree)	RAW VALUE (dBuV)	CORRECTION FACTOR (dB/m)
1	5150.00	59.2 PK	74.0	-14.8	2.88 V	86	55.9	3.3
2	5150.00	46.1 AV	54.0	-7.9	2.88 V	86	42.8	3.3
3	*5270.00	109.2 PK			2.88 V	86	106.5	2.7
4	*5270.00	99.4 AV			2.88 V	86	96.7	2.7
5	#10540.00	47.2 PK	68.2	-21.0	2.23 V	107	34.6	12.6
6	15810.00	51.1 PK	74.0	-22.9	1.75 V	314	39.1	12.0
7	15810.00	40.5 AV	54.0	-13.5	1.75 V	314	28.5	12.0

REMARKS:

1. Emission Level(dBuV/m) = Raw Value(dBuV) + Correction Factor(dB/m)
2. Correction Factor(dB/m) = Antenna Factor(dB/m) + Cable Factor(dB) – Pre-Amplifier Factor(dB)
3. Margin value = Emission Level – Limit value
4. The other emission levels were very low against the limit.
5. " * ": Fundamental frequency.
6. " # ": The radiated frequency is out of the restricted band.

CHANNEL	TX Channel 62	DETECTOR FUNCTION	Peak (PK)
FREQUENCY RANGE	1GHz ~ 40GHz		Average (AV)

ANTENNA POLARITY & TEST DISTANCE: HORIZONTAL AT 3 M

NO.	FREQ. (MHz)	EMISSION LEVEL (dBuV/m)	LIMIT (dBuV/m)	MARGIN (dB)	ANTENNA HEIGHT (m)	TABLE ANGLE (Degree)	RAW VALUE (dBuV)	CORRECTION FACTOR (dB/m)
1	*5310.00	106.6 PK			1.31 H	35	103.8	2.8
2	*5310.00	97.4 AV			1.31 H	35	94.6	2.8
3	5350.00	70.8 PK	74.0	-3.2	1.31 H	35	67.8	3.0
4	5350.00	53.6 AV	54.0	-0.4	1.31 H	35	50.6	3.0
5	10620.00	48.5 PK	74.0	-25.5	1.36 H	205	36.0	12.5
6	10620.00	39.4 AV	54.0	-14.6	1.36 H	205	26.9	12.5
7	15930.00	50.1 PK	74.0	-23.9	1.47 H	315	37.7	12.4
8	15930.00	40.3 AV	54.0	-13.7	1.47 H	315	27.9	12.4

ANTENNA POLARITY & TEST DISTANCE: VERTICAL AT 3 M

NO.	FREQ. (MHz)	EMISSION LEVEL (dBuV/m)	LIMIT (dBuV/m)	MARGIN (dB)	ANTENNA HEIGHT (m)	TABLE ANGLE (Degree)	RAW VALUE (dBuV)	CORRECTION FACTOR (dB/m)
1	*5310.00	102.2 PK			2.85 V	98	99.4	2.8
2	*5310.00	93.2 AV			2.85 V	98	90.4	2.8
3	5350.00	68.2 PK	74.0	-5.8	2.85 V	98	65.2	3.0
4	5350.00	51.1 AV	54.0	-2.9	2.85 V	98	48.1	3.0
5	10620.00	47.8 PK	74.0	-26.2	2.17 V	92	35.3	12.5
6	10620.00	39.3 AV	54.0	-14.7	2.17 V	92	26.8	12.5
7	15930.00	51.3 PK	74.0	-22.7	1.80 V	322	38.9	12.4
8	15930.00	40.8 AV	54.0	-13.2	1.80 V	322	28.4	12.4

REMARKS:

1. Emission Level(dBuV/m) = Raw Value(dBuV) + Correction Factor(dB/m)
2. Correction Factor(dB/m) = Antenna Factor(dB/m) + Cable Factor(dB) – Pre-Amplifier Factor(dB)
3. Margin value = Emission Level – Limit value
4. The other emission levels were very low against the limit.
5. " * ": Fundamental frequency.

CHANNEL	TX Channel 102	DETECTOR FUNCTION	Peak (PK)
FREQUENCY RANGE	1GHz ~ 40GHz		Average (AV)

ANTENNA POLARITY & TEST DISTANCE: HORIZONTAL AT 3 M

NO.	FREQ. (MHz)	EMISSION LEVEL (dBuV/m)	LIMIT (dBuV/m)	MARGIN (dB)	ANTENNA HEIGHT (m)	TABLE ANGLE (Degree)	RAW VALUE (dBuV)	CORRECTION FACTOR (dB/m)
1	5460.00	63.5 PK	74.0	-10.5	1.67 H	0	60.2	3.3
2	5460.00	51.2 AV	54.0	-2.8	1.67 H	0	47.9	3.3
3	#5470.00	67.8 PK	68.2	-0.4	1.67 H	0	64.5	3.3
4	*5510.00	106.2 PK			1.67 H	0	102.9	3.3
5	*5510.00	97.7 AV			1.67 H	0	94.4	3.3
6	11020.00	47.9 PK	74.0	-26.1	1.36 H	222	34.9	13.0
7	11020.00	39.0 AV	54.0	-15.0	1.36 H	222	26.0	13.0
8	#16530.00	49.6 PK	68.2	-18.6	1.63 H	314	35.0	14.6

ANTENNA POLARITY & TEST DISTANCE: VERTICAL AT 3 M

NO.	FREQ. (MHz)	EMISSION LEVEL (dBuV/m)	LIMIT (dBuV/m)	MARGIN (dB)	ANTENNA HEIGHT (m)	TABLE ANGLE (Degree)	RAW VALUE (dBuV)	CORRECTION FACTOR (dB/m)
1	5460.00	60.1 PK	74.0	-13.9	2.86 V	80	56.8	3.3
2	5460.00	48.2 AV	54.0	-5.8	2.86 V	80	44.9	3.3
3	#5470.00	64.5 PK	68.2	-3.7	2.86 V	80	61.2	3.3
4	*5510.00	101.8 PK			2.86 V	80	98.5	3.3
5	*5510.00	92.8 AV			2.86 V	80	89.5	3.3
6	11020.00	47.6 PK	74.0	-26.4	2.25 V	114	34.6	13.0
7	11020.00	39.0 AV	54.0	-15.0	2.25 V	114	26.0	13.0
8	#16530.00	51.2 PK	68.2	-17.0	1.73 V	317	36.6	14.6

REMARKS:

1. Emission Level(dBuV/m) = Raw Value(dBuV) + Correction Factor(dB/m)
2. Correction Factor(dB/m) = Antenna Factor(dB/m) + Cable Factor(dB) – Pre-Amplifier Factor(dB)
3. Margin value = Emission Level – Limit value
4. The other emission levels were very low against the limit.
5. " * ": Fundamental frequency.
6. " # ": The radiated frequency is out of the restricted band.

CHANNEL	TX Channel 110	DETECTOR FUNCTION	Peak (PK)
FREQUENCY RANGE	1GHz ~ 40GHz		Average (AV)

ANTENNA POLARITY & TEST DISTANCE: HORIZONTAL AT 3 M

NO.	FREQ. (MHz)	EMISSION LEVEL (dBuV/m)	LIMIT (dBuV/m)	MARGIN (dB)	ANTENNA HEIGHT (m)	TABLE ANGLE (Degree)	RAW VALUE (dBuV)	CORRECTION FACTOR (dB/m)
1	*5550.00	110.9 PK			1.54 H	2	107.6	3.3
2	*5550.00	102.5 AV			1.54 H	2	99.2	3.3
3	11100.00	48.4 PK	74.0	-25.6	1.36 H	205	35.7	12.7
4	11100.00	39.3 AV	54.0	-14.7	1.36 H	205	26.6	12.7
5	#16650.00	49.7 PK	68.2	-18.5	1.47 H	311	34.5	15.2

ANTENNA POLARITY & TEST DISTANCE: VERTICAL AT 3 M

NO.	FREQ. (MHz)	EMISSION LEVEL (dBuV/m)	LIMIT (dBuV/m)	MARGIN (dB)	ANTENNA HEIGHT (m)	TABLE ANGLE (Degree)	RAW VALUE (dBuV)	CORRECTION FACTOR (dB/m)
1	*5550.00	106.4 PK			2.85 V	100	103.1	3.3
2	*5550.00	97.5 AV			2.85 V	100	94.2	3.3
3	11100.00	47.1 PK	74.0	-26.9	2.19 V	98	34.4	12.7
4	11100.00	38.5 AV	54.0	-15.5	2.19 V	98	25.8	12.7
5	#16650.00	50.9 PK	68.2	-17.3	1.83 V	312	35.7	15.2

REMARKS:

1. Emission Level(dBuV/m) = Raw Value(dBuV) + Correction Factor(dB/m)
2. Correction Factor(dB/m) = Antenna Factor(dB/m) + Cable Factor(dB) – Pre-Amplifier Factor(dB)
3. Margin value = Emission Level – Limit value
4. The other emission levels were very low against the limit.
5. " * ": Fundamental frequency.
6. " # ": The radiated frequency is out of the restricted band.

CHANNEL	TX Channel 134	DETECTOR FUNCTION	Peak (PK)
FREQUENCY RANGE	1GHz ~ 40GHz		Average (AV)

ANTENNA POLARITY & TEST DISTANCE: HORIZONTAL AT 3 M

NO.	FREQ. (MHz)	EMISSION LEVEL (dBuV/m)	LIMIT (dBuV/m)	MARGIN (dB)	ANTENNA HEIGHT (m)	TABLE ANGLE (Degree)	RAW VALUE (dBuV)	CORRECTION FACTOR (dB/m)
1	*5670.00	110.4 PK			1.56 H	6	107.0	3.4
2	*5670.00	101.2 AV			1.56 H	6	97.8	3.4
3	#5725.00	67.7 PK	68.2	-0.5	1.56 H	6	64.2	3.5
4	11340.00	48.0 PK	74.0	-26.0	1.36 H	205	34.6	13.4
5	11340.00	38.9 AV	54.0	-15.1	1.36 H	205	25.5	13.4
6	#17010.00	50.0 PK	68.2	-18.2	1.44 H	305	33.8	16.2

ANTENNA POLARITY & TEST DISTANCE: VERTICAL AT 3 M

NO.	FREQ. (MHz)	EMISSION LEVEL (dBuV/m)	LIMIT (dBuV/m)	MARGIN (dB)	ANTENNA HEIGHT (m)	TABLE ANGLE (Degree)	RAW VALUE (dBuV)	CORRECTION FACTOR (dB/m)
1	*5670.00	105.1 PK			2.80 V	102	101.7	3.4
2	*5670.00	96.4 AV			2.80 V	102	93.0	3.4
3	#5725.00	64.5 PK	68.2	-3.7	2.80 V	102	61.0	3.5
4	11340.00	47.5 PK	74.0	-26.5	2.17 V	100	34.1	13.4
5	11340.00	39.1 AV	54.0	-14.9	2.17 V	100	25.7	13.4
6	#17010.00	50.5 PK	68.2	-17.7	1.77 V	319	34.3	16.2

REMARKS:

1. Emission Level(dBuV/m) = Raw Value(dBuV) + Correction Factor(dB/m)
2. Correction Factor(dB/m) = Antenna Factor(dB/m) + Cable Factor(dB) – Pre-Amplifier Factor(dB)
3. Margin value = Emission Level – Limit value
4. The other emission levels were very low against the limit.
5. " * ": Fundamental frequency.
6. " # ": The radiated frequency is out of the restricted band.

CHANNEL	TX Channel 142	DETECTOR FUNCTION	Peak (PK)
FREQUENCY RANGE	1GHz ~ 40GHz		Average (AV)

ANTENNA POLARITY & TEST DISTANCE: HORIZONTAL AT 3 M

NO.	FREQ. (MHz)	EMISSION LEVEL (dBuV/m)	LIMIT (dBuV/m)	MARGIN (dB)	ANTENNA HEIGHT (m)	TABLE ANGLE (Degree)	RAW VALUE (dBuV)	CORRECTION FACTOR (dB/m)
1	*5710.00	110.5 PK			1.45 H	356	107.0	3.5
2	*5710.00	101.6 AV			1.45 H	356	98.1	3.5
3	#5850.00	52.4 PK	68.2	-15.8	1.45 H	356	48.4	4.0
4	11420.00	49.1 PK	74.0	-24.9	1.34 H	319	35.9	13.2
5	11420.00	40.2 AV	54.0	-13.8	1.34 H	319	27.0	13.2
6	#17130.00	51.1 PK	68.2	-17.1	1.20 H	307	34.5	16.6

ANTENNA POLARITY & TEST DISTANCE: VERTICAL AT 3 M

NO.	FREQ. (MHz)	EMISSION LEVEL (dBuV/m)	LIMIT (dBuV/m)	MARGIN (dB)	ANTENNA HEIGHT (m)	TABLE ANGLE (Degree)	RAW VALUE (dBuV)	CORRECTION FACTOR (dB/m)
1	*5710.00	105.7 PK			2.81 V	94	102.2	3.5
2	*5710.00	96.8 AV			2.81 V	94	93.3	3.5
3	#5850.00	47.9 PK	68.2	-20.3	2.81 V	94	43.9	4.0
4	11420.00	47.7 PK	74.0	-26.3	2.20 V	108	34.5	13.2
5	11420.00	38.9 AV	54.0	-15.1	2.20 V	108	25.7	13.2
6	#17130.00	50.3 PK	68.2	-17.9	1.78 V	320	33.7	16.6

REMARKS:

1. Emission Level(dBuV/m) = Raw Value(dBuV) + Correction Factor(dB/m)
2. Correction Factor(dB/m) = Antenna Factor(dB/m) + Cable Factor(dB) – Pre-Amplifier Factor(dB)
3. Margin value = Emission Level – Limit value
4. The other emission levels were very low against the limit.
5. " * ": Fundamental frequency.
6. " # ": The radiated frequency is out of the restricted band.

CHANNEL	TX Channel 151	DETECTOR FUNCTION	Peak (PK)
FREQUENCY RANGE	1GHz ~ 40GHz		Average (AV)

ANTENNA POLARITY & TEST DISTANCE: HORIZONTAL AT 3 M

NO.	FREQ. (MHz)	EMISSION LEVEL (dBuV/m)	LIMIT (dBuV/m)	MARGIN (dB)	ANTENNA HEIGHT (m)	TABLE ANGLE (Degree)	RAW VALUE (dBuV)	CORRECTION FACTOR (dB/m)
1	#5645.80	66.8 PK	68.2	-1.4	1.59 H	10	63.5	3.3
2	*5755.00	113.1 PK			1.59 H	10	109.4	3.7
3	*5755.00	104.1 AV			1.59 H	10	100.4	3.7
4	#5935.57	53.7 PK	68.2	-14.5	1.59 H	10	49.5	4.2
5	11510.00	47.9 PK	74.0	-26.1	3.05 H	125	34.9	13.0
6	11510.00	39.1 AV	54.0	-14.9	3.05 H	125	26.1	13.0
7	#17265.00	50.1 PK	68.2	-18.1	2.24 H	154	33.2	16.9

ANTENNA POLARITY & TEST DISTANCE: VERTICAL AT 3 M

NO.	FREQ. (MHz)	EMISSION LEVEL (dBuV/m)	LIMIT (dBuV/m)	MARGIN (dB)	ANTENNA HEIGHT (m)	TABLE ANGLE (Degree)	RAW VALUE (dBuV)	CORRECTION FACTOR (dB/m)
1	#5642.55	61.4 PK	68.2	-6.8	3.48 V	298	58.1	3.3
2	*5755.00	109.4 PK			3.48 V	298	105.7	3.7
3	*5755.00	99.2 AV			3.48 V	298	95.5	3.7
4	#5947.50	52.9 PK	68.2	-15.3	3.48 V	298	48.7	4.2
5	11510.00	47.2 PK	74.0	-26.8	2.26 V	96	34.2	13.0
6	11510.00	38.4 AV	54.0	-15.6	2.26 V	96	25.4	13.0
7	#17265.00	51.2 PK	68.2	-17.0	1.75 V	331	34.3	16.9

REMARKS:

1. Emission Level(dBuV/m) = Raw Value(dBuV) + Correction Factor(dB/m)
2. Correction Factor(dB/m) = Antenna Factor(dB/m) + Cable Factor(dB) – Pre-Amplifier Factor(dB)
3. Margin value = Emission Level – Limit value
4. The other emission levels were very low against the limit.
5. " * ": Fundamental frequency.
6. " # ": The radiated frequency is out of the restricted band.

CHANNEL	TX Channel 159	DETECTOR FUNCTION	Peak (PK)
FREQUENCY RANGE	1GHz ~ 40GHz		Average (AV)

ANTENNA POLARITY & TEST DISTANCE: HORIZONTAL AT 3 M

NO.	FREQ. (MHz)	EMISSION LEVEL (dBuV/m)	LIMIT (dBuV/m)	MARGIN (dB)	ANTENNA HEIGHT (m)	TABLE ANGLE (Degree)	RAW VALUE (dBuV)	CORRECTION FACTOR (dB/m)
1	#5645.43	63.8 PK	68.2	-4.4	1.54 H	12	60.5	3.3
2	*5795.00	114.2 PK			1.54 H	12	110.4	3.8
3	*5795.00	106.3 AV			1.54 H	12	102.5	3.8
4	#5938.29	62.3 PK	68.2	-5.9	1.54 H	12	58.1	4.2
5	11590.00	48.0 PK	74.0	-26.0	2.06 H	301	35.2	12.8
6	11590.00	39.1 AV	54.0	-14.9	2.06 H	301	26.3	12.8
7	#17385.00	49.4 PK	68.2	-18.8	2.11 H	285	32.6	16.8

ANTENNA POLARITY & TEST DISTANCE: VERTICAL AT 3 M

NO.	FREQ. (MHz)	EMISSION LEVEL (dBuV/m)	LIMIT (dBuV/m)	MARGIN (dB)	ANTENNA HEIGHT (m)	TABLE ANGLE (Degree)	RAW VALUE (dBuV)	CORRECTION FACTOR (dB/m)
1	#5644.58	61.0 PK	68.2	-7.2	3.86 V	167	57.7	3.3
2	*5795.00	109.5 PK			3.86 V	167	105.7	3.8
3	*5795.00	100.7 AV			3.86 V	167	96.9	3.8
4	#5934.56	60.1 PK	68.2	-8.1	3.86 V	167	55.9	4.2
5	11590.00	48.0 PK	74.0	-26.0	2.24 V	86	35.2	12.8
6	11590.00	39.1 AV	54.0	-14.9	2.24 V	86	26.3	12.8
7	#17385.00	51.1 PK	68.2	-17.1	1.78 V	332	34.3	16.8

REMARKS:

1. Emission Level(dBuV/m) = Raw Value(dBuV) + Correction Factor(dB/m)
2. Correction Factor(dB/m) = Antenna Factor(dB/m) + Cable Factor(dB) – Pre-Amplifier Factor(dB)
3. Margin value = Emission Level – Limit value
4. The other emission levels were very low against the limit.
5. " * ": Fundamental frequency.
6. " # ": The radiated frequency is out of the restricted band.

802.11ac (VHT80)

CHANNEL	TX Channel 42	DETECTOR FUNCTION	Peak (PK)
FREQUENCY RANGE	1GHz ~ 40GHz		Average (AV)

ANTENNA POLARITY & TEST DISTANCE: HORIZONTAL AT 3 M

NO.	FREQ. (MHz)	EMISSION LEVEL (dBuV/m)	LIMIT (dBuV/m)	MARGIN (dB)	ANTENNA HEIGHT (m)	TABLE ANGLE (Degree)	RAW VALUE (dBuV)	CORRECTION FACTOR (dB/m)
1	5150.00	66.2 PK	74.0	-7.8	1.42 H	31	62.9	3.3
2	5150.00	53.5 AV	54.0	-0.5	1.42 H	31	50.2	3.3
3	*5210.00	103.9 PK			1.42 H	31	100.9	3.0
4	*5210.00	94.8 AV			1.42 H	31	91.8	3.0
5	5350.00	52.5 PK	74.0	-21.5	1.42 H	31	49.5	3.0
6	5350.00	40.3 AV	54.0	-13.7	1.42 H	31	37.3	3.0
7	#10420.00	47.7 PK	68.2	-20.5	1.55 H	302	35.2	12.5
8	15630.00	49.0 PK	74.0	-25.0	1.47 H	311	36.1	12.9
9	15630.00	39.6 AV	54.0	-14.4	1.47 H	311	26.7	12.9

ANTENNA POLARITY & TEST DISTANCE: VERTICAL AT 3 M

NO.	FREQ. (MHz)	EMISSION LEVEL (dBuV/m)	LIMIT (dBuV/m)	MARGIN (dB)	ANTENNA HEIGHT (m)	TABLE ANGLE (Degree)	RAW VALUE (dBuV)	CORRECTION FACTOR (dB/m)
1	5150.00	62.8 PK	74.0	-11.2	2.84 V	96	59.5	3.3
2	5150.00	50.6 AV	54.0	-3.4	2.84 V	96	47.3	3.3
3	*5210.00	99.4 PK			2.84 V	96	96.4	3.0
4	*5210.00	89.6 AV			2.84 V	96	86.6	3.0
5	5350.00	50.9 PK	74.0	-23.1	2.84 V	96	47.9	3.0
6	5350.00	39.1 AV	54.0	-14.9	2.84 V	96	36.1	3.0
7	#10420.00	48.1 PK	68.2	-20.1	2.21 V	108	35.6	12.5
8	15630.00	51.2 PK	74.0	-22.8	1.78 V	329	38.3	12.9
9	15630.00	40.8 AV	54.0	-13.2	1.78 V	329	27.9	12.9

REMARKS:

- Emission Level(dBuV/m) = Raw Value(dBuV) + Correction Factor(dB/m)
- Correction Factor(dB/m) = Antenna Factor(dB/m) + Cable Factor(dB) – Pre-Amplifier Factor(dB)
- Margin value = Emission Level – Limit value
- The other emission levels were very low against the limit.
- " * ": Fundamental frequency.
- " # ": The radiated frequency is out of the restricted band.

CHANNEL	TX Channel 58	DETECTOR FUNCTION	Peak (PK)
FREQUENCY RANGE	1GHz ~ 40GHz		Average (AV)

ANTENNA POLARITY & TEST DISTANCE: HORIZONTAL AT 3 M

NO.	FREQ. (MHz)	EMISSION LEVEL (dBuV/m)	LIMIT (dBuV/m)	MARGIN (dB)	ANTENNA HEIGHT (m)	TABLE ANGLE (Degree)	RAW VALUE (dBuV)	CORRECTION FACTOR (dB/m)
1	5150.00	50.6 PK	74.0	-23.4	1.34 H	10	47.3	3.3
2	5150.00	38.4 AV	54.0	-15.6	1.34 H	10	35.1	3.3
3	*5290.00	105.6 PK			1.34 H	10	102.9	2.7
4	*5290.00	94.8 AV			1.34 H	10	92.1	2.7
5	5350.00	66.3 PK	74.0	-7.7	1.34 H	10	63.3	3.0
6	5350.00	53.8 AV	54.0	-0.2	1.34 H	10	50.8	3.0
7	#10580.00	47.7 PK	68.2	-20.5	1.36 H	222	35.1	12.6
8	15870.00	49.3 PK	74.0	-24.7	1.54 H	304	37.2	12.1
9	15870.00	40.0 AV	54.0	-14.0	1.54 H	304	27.9	12.1

ANTENNA POLARITY & TEST DISTANCE: VERTICAL AT 3 M

NO.	FREQ. (MHz)	EMISSION LEVEL (dBuV/m)	LIMIT (dBuV/m)	MARGIN (dB)	ANTENNA HEIGHT (m)	TABLE ANGLE (Degree)	RAW VALUE (dBuV)	CORRECTION FACTOR (dB/m)
1	5150.00	51.3 PK	74.0	-22.7	2.91 V	93	48.0	3.3
2	5150.00	38.9 AV	54.0	-15.1	2.91 V	93	35.6	3.3
3	*5290.00	99.3 PK			2.91 V	93	96.6	2.7
4	*5290.00	89.7 AV			2.91 V	93	87.0	2.7
5	5350.00	62.4 PK	74.0	-11.6	2.91 V	93	59.4	3.0
6	5350.00	50.5 AV	54.0	-3.5	2.91 V	93	47.5	3.0
7	#10580.00	47.9 PK	68.2	-20.3	2.28 V	94	35.3	12.6
8	15870.00	50.9 PK	74.0	-23.1	1.82 V	335	38.8	12.1
9	15870.00	40.7 AV	54.0	-13.3	1.82 V	335	28.6	12.1

REMARKS:

1. Emission Level(dBuV/m) = Raw Value(dBuV) + Correction Factor(dB/m)
2. Correction Factor(dB/m) = Antenna Factor(dB/m) + Cable Factor(dB) – Pre-Amplifier Factor(dB)
3. Margin value = Emission Level – Limit value
4. The other emission levels were very low against the limit.
5. " * ": Fundamental frequency.
6. " # ": The radiated frequency is out of the restricted band.

CHANNEL	TX Channel 106	DETECTOR FUNCTION	Peak (PK)
FREQUENCY RANGE	1GHz ~ 40GHz		Average (AV)

ANTENNA POLARITY & TEST DISTANCE: HORIZONTAL AT 3 M

NO.	FREQ. (MHz)	EMISSION LEVEL (dBuV/m)	LIMIT (dBuV/m)	MARGIN (dB)	ANTENNA HEIGHT (m)	TABLE ANGLE (Degree)	RAW VALUE (dBuV)	CORRECTION FACTOR (dB/m)
1	5460.00	64.3 PK	74.0	-9.7	1.38 H	15	61.0	3.3
2	5460.00	51.6 AV	54.0	-2.4	1.38 H	15	48.3	3.3
3	#5470.00	67.8 PK	68.2	-0.4	1.38 H	15	64.5	3.3
4	*5530.00	103.9 PK			1.38 H	15	100.6	3.3
5	*5530.00	94.4 AV			1.38 H	15	91.1	3.3
6	11060.00	47.6 PK	74.0	-26.4	1.65 H	214	34.7	12.9
7	11060.00	39.1 AV	54.0	-14.9	1.65 H	214	26.2	12.9
8	#16590.00	49.1 PK	68.2	-19.1	1.52 H	211	34.2	14.9

ANTENNA POLARITY & TEST DISTANCE: VERTICAL AT 3 M

NO.	FREQ. (MHz)	EMISSION LEVEL (dBuV/m)	LIMIT (dBuV/m)	MARGIN (dB)	ANTENNA HEIGHT (m)	TABLE ANGLE (Degree)	RAW VALUE (dBuV)	CORRECTION FACTOR (dB/m)
1	5460.00	61.1 PK	74.0	-12.9	2.89 V	76	57.8	3.3
2	5460.00	48.2 AV	54.0	-5.8	2.89 V	76	44.9	3.3
3	#5470.00	64.5 PK	68.2	-3.7	2.89 V	76	61.2	3.3
4	*5530.00	99.7 PK			2.89 V	76	96.4	3.3
5	*5530.00	89.9 AV			2.89 V	76	86.6	3.3
6	11060.00	48.5 PK	74.0	-25.5	2.23 V	99	35.6	12.9
7	11060.00	39.6 AV	54.0	-14.4	2.23 V	99	26.7	12.9
8	#16590.00	50.9 PK	68.2	-17.3	1.86 V	351	36.0	14.9

REMARKS:

1. Emission Level(dBuV/m) = Raw Value(dBuV) + Correction Factor(dB/m)
2. Correction Factor(dB/m) = Antenna Factor(dB/m) + Cable Factor(dB) – Pre-Amplifier Factor(dB)
3. Margin value = Emission Level – Limit value
4. The other emission levels were very low against the limit.
5. " * ": Fundamental frequency.
6. " # ": The radiated frequency is out of the restricted band.

CHANNEL	TX Channel 122	DETECTOR FUNCTION	Peak (PK)
FREQUENCY RANGE	1GHz ~ 40GHz		Average (AV)

ANTENNA POLARITY & TEST DISTANCE: HORIZONTAL AT 3 M

NO.	FREQ. (MHz)	EMISSION LEVEL (dBuV/m)	LIMIT (dBuV/m)	MARGIN (dB)	ANTENNA HEIGHT (m)	TABLE ANGLE (Degree)	RAW VALUE (dBuV)	CORRECTION FACTOR (dB/m)
1	*5610.00	108.2 PK			1.40 H	26	104.9	3.3
2	*5610.00	99.0 AV			1.40 H	26	95.7	3.3
3	#5725.00	67.8 PK	68.2	-0.4	1.40 H	26	64.3	3.5
4	11220.00	47.7 PK	74.0	-26.3	1.36 H	22	34.7	13.0
5	11220.00	39.4 AV	54.0	-14.6	1.36 H	22	26.4	13.0
6	#16830.00	48.5 PK	68.2	-19.7	1.45 H	98	33.2	15.3

ANTENNA POLARITY & TEST DISTANCE: VERTICAL AT 3 M

NO.	FREQ. (MHz)	EMISSION LEVEL (dBuV/m)	LIMIT (dBuV/m)	MARGIN (dB)	ANTENNA HEIGHT (m)	TABLE ANGLE (Degree)	RAW VALUE (dBuV)	CORRECTION FACTOR (dB/m)
1	*5610.00	104.1 PK			2.90 V	97	100.8	3.3
2	*5610.00	94.2 AV			2.90 V	97	90.9	3.3
3	#5725.00	64.2 PK	68.2	-4.0	2.90 V	97	60.7	3.5
4	11220.00	48.0 PK	74.0	-26.0	2.32 V	102	35.0	13.0
5	11220.00	39.2 AV	54.0	-14.8	2.32 V	102	26.2	13.0
6	#16830.00	50.9 PK	68.2	-17.3	1.77 V	335	35.6	15.3

REMARKS:

1. Emission Level(dBuV/m) = Raw Value(dBuV) + Correction Factor(dB/m)
2. Correction Factor(dB/m) = Antenna Factor(dB/m) + Cable Factor(dB) – Pre-Amplifier Factor(dB)
3. Margin value = Emission Level – Limit value
4. The other emission levels were very low against the limit.
5. " * ": Fundamental frequency.
6. " # ": The radiated frequency is out of the restricted band.

CHANNEL	TX Channel 138	DETECTOR FUNCTION	Peak (PK)
FREQUENCY RANGE	1GHz ~ 40GHz		Average (AV)

ANTENNA POLARITY & TEST DISTANCE: HORIZONTAL AT 3 M

NO.	FREQ. (MHz)	EMISSION LEVEL (dBuV/m)	LIMIT (dBuV/m)	MARGIN (dB)	ANTENNA HEIGHT (m)	TABLE ANGLE (Degree)	RAW VALUE (dBuV)	CORRECTION FACTOR (dB/m)
1	*5690.00	107.5 PK			1.39 H	345	104.1	3.4
2	*5690.00	98.5 AV			1.39 H	345	95.1	3.4
3	#5850.00	52.0 PK	68.2	-16.2	1.39 H	345	48.0	4.0
4	11380.00	47.9 PK	74.0	-26.1	1.38 H	320	34.6	13.3
5	11380.00	39.3 AV	54.0	-14.7	1.38 H	320	26.0	13.3
6	#17070.00	51.1 PK	68.2	-17.1	1.27 H	315	34.8	16.3

ANTENNA POLARITY & TEST DISTANCE: VERTICAL AT 3 M

NO.	FREQ. (MHz)	EMISSION LEVEL (dBuV/m)	LIMIT (dBuV/m)	MARGIN (dB)	ANTENNA HEIGHT (m)	TABLE ANGLE (Degree)	RAW VALUE (dBuV)	CORRECTION FACTOR (dB/m)
1	*5690.00	104.7 PK			2.82 V	90	101.3	3.4
2	*5690.00	94.5 AV			2.82 V	90	91.1	3.4
3	#5850.00	48.7 PK	68.2	-19.5	2.82 V	90	44.7	4.0
4	11380.00	47.5 PK	74.0	-26.5	2.20 V	94	34.2	13.3
5	11380.00	38.8 AV	54.0	-15.2	2.20 V	94	25.5	13.3
6	#17070.00	50.6 PK	68.2	-17.6	1.87 V	313	34.3	16.3

REMARKS:

1. Emission Level(dBuV/m) = Raw Value(dBuV) + Correction Factor(dB/m)
2. Correction Factor(dB/m) = Antenna Factor(dB/m) + Cable Factor(dB) – Pre-Amplifier Factor(dB)
3. Margin value = Emission Level – Limit value
4. The other emission levels were very low against the limit.
5. " * ": Fundamental frequency.
6. " # ": The radiated frequency is out of the restricted band.

CHANNEL	TX Channel 155	DETECTOR FUNCTION	Peak (PK)
FREQUENCY RANGE	1GHz ~ 40GHz		Average (AV)

ANTENNA POLARITY & TEST DISTANCE: HORIZONTAL AT 3 M

NO.	FREQ. (MHz)	EMISSION LEVEL (dBuV/m)	LIMIT (dBuV/m)	MARGIN (dB)	ANTENNA HEIGHT (m)	TABLE ANGLE (Degree)	RAW VALUE (dBuV)	CORRECTION FACTOR (dB/m)
1	#5645.94	67.8 PK	68.2	-0.4	1.00 H	32	64.5	3.3
2	*5775.00	108.3 PK			1.01 H	32	104.6	3.7
3	*5775.00	100.1 AV			1.01 H	32	96.4	3.7
4	#5929.50	62.8 PK	68.2	-5.4	1.01 H	32	58.7	4.1
5	11550.00	48.3 PK	74.0	-25.7	1.36 H	222	35.4	12.9
6	11550.00	39.8 AV	54.0	-14.2	1.36 H	222	26.9	12.9
7	#17325.00	48.9 PK	68.2	-19.3	1.45 H	302	31.9	17.0

ANTENNA POLARITY & TEST DISTANCE: VERTICAL AT 3 M

NO.	FREQ. (MHz)	EMISSION LEVEL (dBuV/m)	LIMIT (dBuV/m)	MARGIN (dB)	ANTENNA HEIGHT (m)	TABLE ANGLE (Degree)	RAW VALUE (dBuV)	CORRECTION FACTOR (dB/m)
1	#5630.95	55.2 PK	68.2	-13.0	2.32 V	220	51.9	3.3
2	*5775.00	100.4 PK			2.32 V	220	96.7	3.7
3	*5775.00	95.2 AV			2.32 V	220	91.5	3.7
4	#5930.13	56.8 PK	68.2	-11.4	2.32 V	220	52.7	4.1
5	11550.00	48.2 PK	74.0	-25.8	2.32 V	97	35.3	12.9
6	11550.00	39.4 AV	54.0	-14.6	2.32 V	97	26.5	12.9
7	#17325.00	50.7 PK	68.2	-17.5	1.79 V	334	33.7	17.0

REMARKS:

1. Emission Level(dBuV/m) = Raw Value(dBuV) + Correction Factor(dB/m)
2. Correction Factor(dB/m) = Antenna Factor(dB/m) + Cable Factor(dB) – Pre-Amplifier Factor(dB)
3. Margin value = Emission Level – Limit value
4. The other emission levels were very low against the limit.
5. " * ": Fundamental frequency.
6. " # ": The radiated frequency is out of the restricted band.

Below 1GHz Data:

802.11ac (VHT20)

CHANNEL	TX Channel 165	DETECTOR FUNCTION	Quasi-Peak (QP)
FREQUENCY RANGE	9kHz ~ 1GHz		

ANTENNA POLARITY & TEST DISTANCE: HORIZONTAL AT 3 M

NO.	FREQ. (MHz)	EMISSION LEVEL (dBuV/m)	LIMIT (dBuV/m)	MARGIN (dB)	ANTENNA HEIGHT (m)	TABLE ANGLE (Degree)	RAW VALUE (dBuV)	CORRECTION FACTOR (dB/m)
1	56.52	28.0 QP	40.0	-12.0	1.11 H	99	41.6	-13.6
2	90.15	30.3 QP	43.5	-13.2	1.42 H	80	48.6	-18.3
3	104.20	35.5 QP	43.5	-8.0	1.71 H	35	51.9	-16.4
4	210.01	32.3 QP	43.5	-11.2	1.41 H	60	47.3	-15.0
5	304.30	38.3 QP	46.0	-7.7	1.24 H	311	49.8	-11.5
6	592.65	39.2 QP	46.0	-6.8	1.32 H	244	43.8	-4.6

REMARKS:

1. Emission Level(dBuV/m) = Raw Value(dBuV) + Correction Factor(dB/m)
2. Correction Factor(dB/m) = Antenna Factor(dB/m) + Cable Factor(dB) – Pre-Amplifier Factor(dB)
3. Margin value = Emission Level – Limit value
4. The other emission levels were very low against the limit of frequency range 30MHz~1000MHz.
5. The emission levels were very low against the limit of frequency range 9kHz~30MHz: the amplitude of spurious emissions attenuated more than 20 dB below the permissible value to be report.

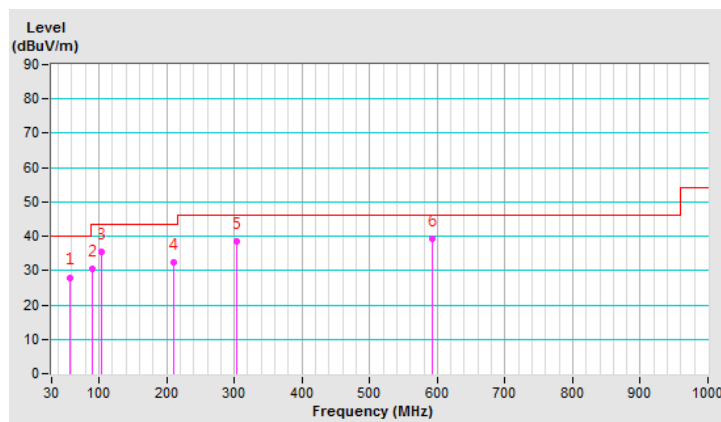

CHANNEL	TX Channel 165	DETECTOR FUNCTION	Quasi-Peak (QP)
FREQUENCY RANGE	9kHz ~ 1GHz		

ANTENNA POLARITY & TEST DISTANCE: VERTICAL AT 3 M

NO.	FREQ. (MHz)	EMISSION LEVEL (dBuV/m)	LIMIT (dBuV/m)	MARGIN (dB)	ANTENNA HEIGHT (m)	TABLE ANGLE (Degree)	RAW VALUE (dBuV)	CORRECTION FACTOR (dB/m)
1	89.75	36.9 QP	43.5	-6.6	1.32 V	88	55.2	-18.3
2	104.11	36.8 QP	43.5	-6.7	1.45 V	278	53.3	-16.5
3	444.61	40.1 QP	46.0	-5.9	1.24 V	88	48.1	-8.0
4	593.02	39.1 QP	46.0	-6.9	1.24 V	177	43.7	-4.6
5	738.02	32.1 QP	46.0	-13.9	1.85 V	277	34.0	-1.9
6	840.01	38.4 QP	46.0	-7.6	1.99 V	277	38.4	0.0

REMARKS:

1. Emission Level(dBuV/m) = Raw Value(dBuV) + Correction Factor(dB/m)
2. Correction Factor(dB/m) = Antenna Factor(dB/m) + Cable Factor(dB) – Pre-Amplifier Factor(dB)
3. Margin value = Emission Level – Limit value
4. The other emission levels were very low against the limit of frequency range 30MHz~1000MHz.
5. The emission levels were very low against the limit of frequency range 9kHz~30MHz: the amplitude of spurious emissions attenuated more than 20 dB below the permissible value to be report.

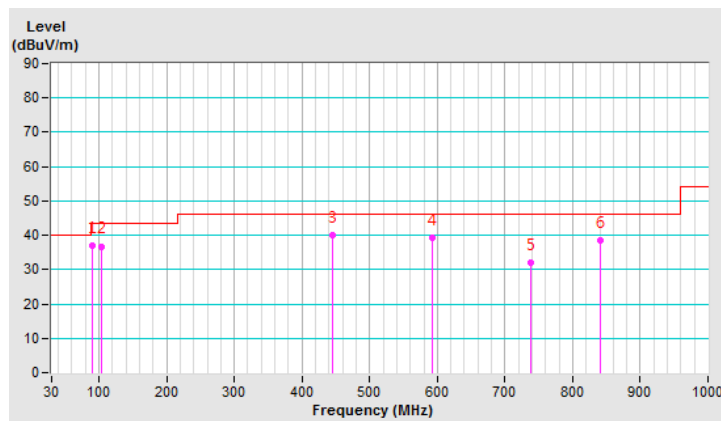

4.2 Conducted Emission Measurement

4.2.1 Limits of Conducted Emission Measurement

Frequency (MHz)	Conducted Limit (dBuV)	
	Quasi-peak	Average
0.15 - 0.5	66 - 56	56 - 46
0.50 - 5.0	56	46
5.0 - 30.0	60	50

Note: 1. The lower limit shall apply at the transition frequencies.

2. The limit decreases in line with the logarithm of the frequency in the range of 0.15 to 0.50MHz.

4.2.2 Test Instruments

DESCRIPTION & MANUFACTURER	MODEL NO.	SERIAL NO.	CALIBRATED DATE	CALIBRATED UNTIL
Test Receiver R&S	ESCS 30	847124/029	Oct. 24, 2018	Oct. 23, 2019
Line-Impedance Stabilization Network (for EUT) R&S	ESH3-Z5	848773/004	Oct. 22, 2018	Oct. 21, 2019
Line-Impedance Stabilization Network (for Peripheral) R&S	ESH3-Z5	835239/001	Mar. 17, 2019	Mar. 16, 2020
50 ohms Terminator	N/A	3	Oct. 22, 2018	Oct. 21, 2019
RF Cable	5D-FB	COCCAB-001	Sep. 28, 2018	Sep. 27, 2019
Fixed attenuator EMCI	STI02-2200-10	003	Mar. 14, 2019	Mar. 13, 2020
Software BVADT	BVADT_Cond_ V7.3.7.4	NA	NA	NA

Note:

1. The calibration interval of the above test instruments are 12 months and the calibrations are traceable to NML/ROC and NIST/USA.
2. The test was performed in Conduction 1.
3. Tested Date: July 02, 2019

4.2.3 Test Procedure

- The EUT was placed 0.4 meters from the conducting wall of the shielded room with EUT being connected to the power mains through a line impedance stabilization network (LISN). Other support units were connected to the power mains through another LISN. The two LISNs provide 50 ohm/ 50uH of coupling impedance for the measuring instrument.
- Both lines of the power mains connected to the EUT were checked for maximum conducted interference.
- The frequency range from 150kHz to 30MHz was searched. Emission levels under (Limit - 20dB) was not recorded.

NOTE: All modes of operation were investigated and the worst-case emissions are reported.

4.2.4 Deviation from Test Standard

No deviation.

4.2.5 Test Setup

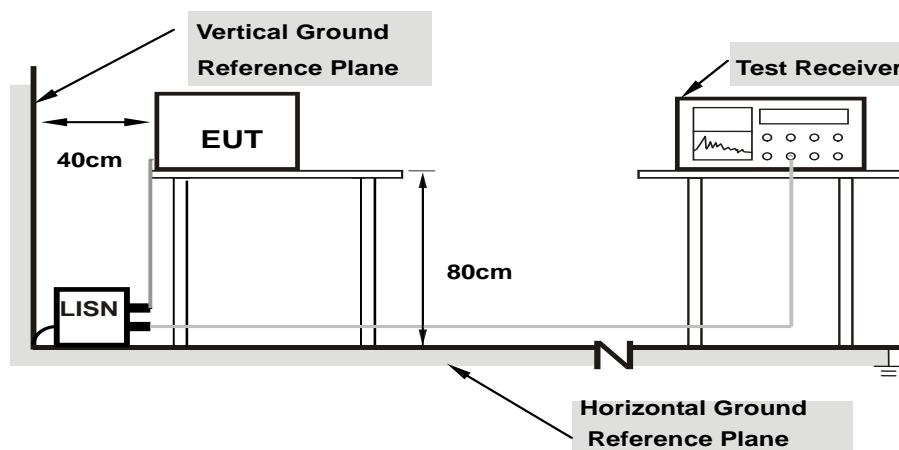

Note: 1.Support units were connected to second LISN.

For the actual test configuration, please refer to the attached file (Test Setup Photo).

4.2.6 EUT Operating Condition

Same as 4.1.6.

4.2.7 Test Results

Phase	Line (L)	Detector Function	Quasi-Peak (QP) / Average (AV)
-------	----------	-------------------	--------------------------------

No	Freq. [MHz]	Corr.	Reading Value		Emission Level		Limit		Margin	
		Factor (dB)	[dB (uV)]		[dB (uV)]		[dB (uV)]		(dB)	
			Q.P.	AV.	Q.P.	AV.	Q.P.	AV.	Q.P.	AV.
1	0.15000	10.03	30.87	19.09	40.90	29.12	66.00	56.00	-25.10	-26.88
2	0.20859	10.05	24.25	12.22	34.30	22.27	63.26	53.26	-28.96	-30.99
3	0.44297	10.08	23.69	19.08	33.77	29.16	57.01	47.01	-23.24	-17.85
4	4.23828	10.34	8.93	-0.33	19.27	10.01	56.00	46.00	-36.73	-35.99
5	13.05859	10.90	19.86	11.65	30.76	22.55	60.00	50.00	-29.24	-27.45
6	26.47656	11.51	24.02	17.02	35.53	28.53	60.00	50.00	-24.47	-21.47

REMARKS:

1. Q.P. and AV. are abbreviations of quasi-peak and average individually.
2. The emission levels of other frequencies were very low against the limit.
3. Margin value = Emission level - Limit value
4. Correction factor = Insertion loss + Cable loss
5. Emission Level = Correction Factor + Reading Value.

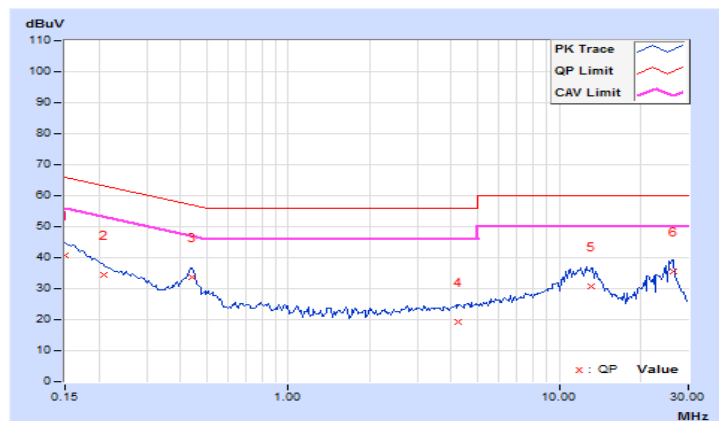

Phase	Neutral (N)	Detector Function	Quasi-Peak (QP) / Average (AV)
-------	-------------	-------------------	--------------------------------

No	Freq.	Corr.	Reading Value		Emission Level		Limit		Margin	
	[MHz]	Factor	[dB (uV)]		[dB (uV)]		[dB (uV)]		(dB)	
		(dB)	Q.P.	AV.	Q.P.	AV.	Q.P.	AV.	Q.P.	AV.
1	0.15000	9.94	32.12	17.09	42.06	27.03	66.00	56.00	-23.94	-28.97
2	0.20469	9.95	25.09	12.54	35.04	22.49	63.42	53.42	-28.38	-30.93
3	0.45078	9.98	22.77	15.98	32.75	25.96	56.86	46.86	-24.11	-20.90
4	0.94688	10.00	8.68	-4.19	18.68	5.81	56.00	46.00	-37.32	-40.19
5	13.13281	10.72	19.70	10.17	30.42	20.89	60.00	50.00	-29.58	-29.11
6	25.86328	11.24	21.35	10.10	32.59	21.34	60.00	50.00	-27.41	-28.66

REMARKS:

1. Q.P. and AV. are abbreviations of quasi-peak and average individually.
2. The emission levels of other frequencies were very low against the limit.
3. Margin value = Emission level - Limit value
4. Correction factor = Insertion loss + Cable loss
5. Emission Level = Correction Factor + Reading Value.

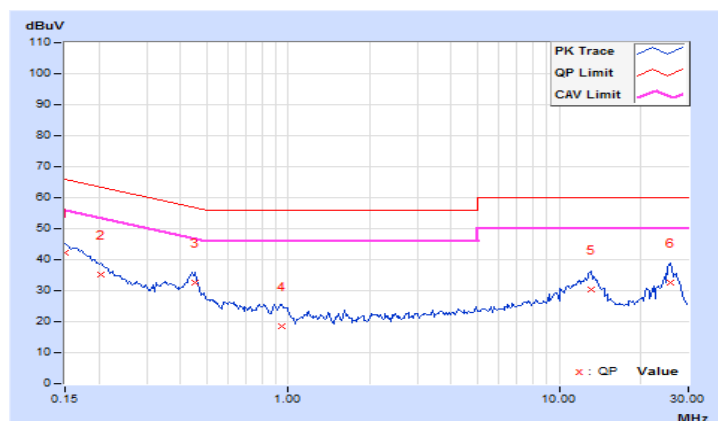

4.3 Transmit Power Measurement

4.3.1 Limits of Transmit Power Measurement

Operation Band	EUT Category		Limit
U-NII-1		Outdoor Access Point	1 Watt (30 dBm) (Max. e.i.r.p \leq 125mW(21 dBm) at any elevation angle above 30 degrees as measured from the horizon)
		Fixed point-to-point Access Point	1 Watt (30 dBm)
		Indoor Access Point	1 Watt (30 dBm)
	√	Client device	250mW (24 dBm)
U-NII-2A	√		250mW (24 dBm) or 11 dBm+10 log B*
U-NII-2C	√		250mW (24 dBm) or 11 dBm+10 log B*
U-NII-3	√		1 Watt (30 dBm)

*B is the 26 dB emission bandwidth in megahertz

Per KDB 662911 Method of conducted output power measurement on IEEE 802.11 devices,

Array Gain = 0 dB (i.e., no array gain) for $N_{ANT} \leq 4$;

Array Gain = 0 dB (i.e., no array gain) for channel widths ≥ 40 MHz for any N_{ANT} ;

Array Gain = $5 \log(N_{ANT}/N_{SS})$ dB or 3 dB, whichever is less for 20-MHz channel widths with $N_{ANT} \geq 5$.

For power measurements on all other devices: Array Gain = $10 \log(N_{ANT}/N_{SS})$ dB.

4.3.2 Test Setup

FOR POWER OUTPUT MEASUREMENT

For channel straddling 5725MHz:

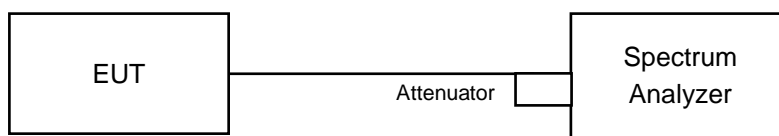

For other channels:

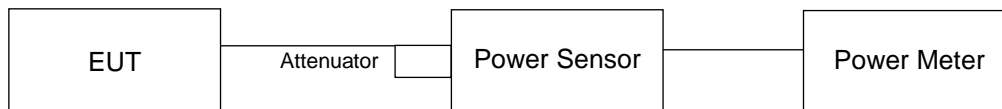

FOR 26dB OCCUPIED BANDWIDTH

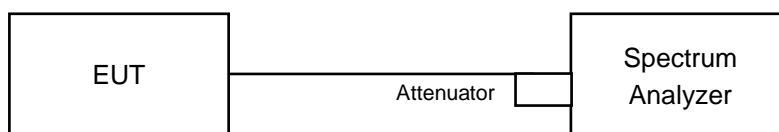

4.3.3 Test Instruments

Refer to section 4.1.2 to get information of above instrument.

4.3.4 Test Procedure

FOR POWER OUTPUT MEASUREMENT

For other channels:

Method PM is used to perform output power measurement, trigger and gating function of wide band power meter is enabled to measure max output power of TX on burst. Duty factor is not added to measured value.

For channel straddling 5725MHz:

Follow FCC KDB 789033 UNII test procedure:

Method SA-1

1. Set span to encompass the entire emission bandwidth (EBW) of the signal.
2. Set RBW = 1MHz.
3. Set the VBW $\geq 3 \times$ RBW.
4. Number of points in sweep ≥ 2 Span / RBW.
5. Sweep time = auto.
6. Set trigger to free run (duty cycle ≥ 98 percent)
7. Detector = RMS.
8. Trace average at least 100 traces in power averaging mode
9. Compute power by integrating the spectrum across the 26 dB EBW of the signal.

FOR 26dB OCCUPIED BANDWIDTH

1. Set RBW = approximately 1% of the emission bandwidth.
2. Set the VBW $>$ RBW.
3. Detector = Peak.
4. Trace mode = max hold.
5. Measure the maximum width of the emission that is 26 dB down from the peak of the emission. Compare this with the RBW setting of the analyzer. Readjust RBW and repeat measurement as needed until the RBW/EBW ratio is approximately 1%.

4.3.5 Deviation from Test Standard

No deviation.

4.3.6 EUT Operating Condition

The software provided by client to enable the EUT under transmission condition continuously at lowest, middle and highest channel frequencies individually.

4.3.7 Test Results

802.11a

POWER OUTPUT

Chan.	Chan. Freq. (MHz)	Maximum Conducted Power (dBm)		Total Power (mW)	Total Power (dBm)	Limit (dBm)	Pass / Fail
		Chain 0	Chain 1				
36	5180	20.67	20.23	222.12	23.47	24.00	Pass
40	5200	20.68	20.26	223.12	23.49	24.00	Pass
48	5240	20.64	20.45	226.795	23.56	24.00	Pass
52	5260	20.40	20.29	216.553	23.36	24.00	Pass
60	5300	20.39	20.28	216.056	23.35	24.00	Pass
64	5320	20.35	20.22	213.589	23.30	24.00	Pass
100	5500	20.21	20.16	208.707	23.20	24.00	Pass
116	5580	20.15	20.14	206.79	23.16	24.00	Pass
140	5700	19.97	20.22	204.508	23.11	24.00	Pass
*144 (U-NII-2C Band)	5720	18.46	18.58	142.257	21.53	24.00	Pass
*144 (U-NII-3 Band)	5720	13.09	12.28	37.274	15.71	30.00	Pass
149	5745	22.87	23.54	419.586	26.23	30.00	Pass
157	5785	22.92	23.56	422.87	26.26	30.00	Pass
165	5825	22.93	23.59	424.896	26.28	30.00	Pass

Note: * Test was performed in accordance with Measurement follow FCC KDB 789033 UNII test procedure Method SA-1 and use spectrum analyzer test.

The Total Power for the straddle channel:

Chan.	Chan. Freq. (MHz)	Average Power (mW)	Average Power (dBm)
144	5720	179.531	22.54

Note: The total power was calculated through formula and record the value for reference only.

26dB OCCUPIED BANDWIDTH

Channel	Frequency (MHz)	26dBc Bandwidth (MHz)	
		Chain 0	Chain 1
52	5260	39.63	38.76
60	5300	38.40	39.12
64	5320	38.85	38.37
100	5500	40.19	38.54
116	5580	39.27	38.48
140	5700	39.39	38.87
144 (U-NII-2C Band)	5720	24.92	23.55

Note: For U-NII-2A, U-NII-2C Band output power limitation is determined based on 26dBc bandwidth

Power Limit = 11dBm + 10logB < U-NII-2A, U-NII-2C >			
Channel Number	Freq.(MHz)	Min. B(MHz)	Determined Conducted Limit (dBm)
52	5260	38.76	26.88 > 24
60	5300	38.40	26.84 > 24
64	5320	38.37	26.83 > 24
100	5500	38.54	26.85 > 24
116	5580	38.48	26.85 > 24
140	5700	38.87	26.89 > 24
144 (U-NII-2C Band)	5720	23.55	24.71 > 24

802.11ac (VHT20)
POWER OUTPUT

Chan.	Chan. Freq. (MHz)	Maximum Conducted Power (dBm)		Total Power (mW)	Total Power (dBm)	Limit (dBm)	Pass / Fail
		Chain 0	Chain 1				
36	5180	20.17	19.83	200.153	23.01	24.00	Pass
40	5200	20.64	20.29	222.783	23.48	24.00	Pass
48	5240	20.57	20.31	221.424	23.45	24.00	Pass
52	5260	20.31	19.92	205.574	23.13	24.00	Pass
60	5300	20.63	19.98	215.152	23.33	24.00	Pass
64	5320	20.58	19.95	213.143	23.29	24.00	Pass
100	5500	20.43	19.85	207.013	23.16	24.00	Pass
116	5580	20.53	19.91	210.929	23.24	24.00	Pass
140	5700	20.52	19.75	207.126	23.16	24.00	Pass
*144 (U-NII-2C Band)	5720	18.50	17.94	133.025	21.24	24.00	Pass
*144 (U-NII-3 Band)	5720	12.97	12.34	36.955	15.68	30.00	Pass
149	5745	21.73	22.64	332.59	25.22	30.00	Pass
157	5785	21.76	22.68	335.321	25.25	30.00	Pass
165	5825	21.75	22.71	336.262	25.27	30.00	Pass

Note: * Test was performed in accordance with Measurement follow FCC KDB 789033 UNII test procedure Method SA-1 and use spectrum analyzer test.

The Total Power for the straddle channel:

Chan.	Chan. Freq. (MHz)	Average Power (mW)	Average Power (dBm)
144	5720	169.98	22.3

Note: The total power was calculated through formula and record the value for reference only.

26dB OCCUPIED BANDWIDTH

Channel	Frequency (MHz)	26dBc Bandwidth (MHz)	
		Chain 0	Chain 1
52	5260	44.19	43.83
60	5300	44.23	44.82
64	5320	44.48	45.57
100	5500	45.24	45.43
116	5580	45.58	44.20
140	5700	45.08	44.21
144 (U-NII-2C Band)	5720	27.25	23.28

Note: For U-NII-2A, U-NII-2C Band output power limitation is determined based on 26dBc bandwidth

Power Limit = 11dBm + 10logB < U-NII-2A, U-NII-2C >			
Channel Number	Freq.(MHz)	Min. B(MHz)	Determined Conducted Limit (dBm)
52	5260	43.83	27.41 > 24
60	5300	44.23	27.45 > 24
64	5320	44.48	27.48 > 24
100	5500	45.24	27.55 > 24
116	5580	44.20	27.45 > 24
140	5700	44.21	27.45 > 24
144 (U-NII-2C Band)	5720	23.28	24.66 > 24

802.11ac (VHT40)
POWER OUTPUT

Chan.	Chan. Freq. (MHz)	Maximum Conducted Power (dBm)		Total Power (mW)	Total Power (dBm)	Limit (dBm)	Pass / Fail
		Chain 0	Chain 1				
38	5190	15.43	13.81	58.958	17.71	24.00	Pass
46	5230	21.28	20.53	247.256	23.93	24.00	Pass
54	5270	20.73	19.92	216.479	23.35	24.00	Pass
62	5310	15.75	14.52	65.898	18.19	24.00	Pass
102	5510	15.96	15.08	71.657	18.55	24.00	Pass
110	5550	20.45	19.96	210	23.22	24.00	Pass
134	5670	19.47	19.21	171.88	22.35	24.00	Pass
*142 (U-NII-2C Band)	5710	19.19	18.97	161.871	22.09	24.00	Pass
*142 (U-NII-3 Band)	5710	9.07	8.55	15.233	11.83	30.00	Pass
151	5755	22.54	22.03	339.061	25.30	30.00	Pass
159	5795	22.86	22.73	380.696	25.81	30.00	Pass

Note: * Test was performed in accordance with Measurement follow FCC KDB 789033 UNII test procedure Method SA-1 and use spectrum analyzer test.

The Total Power for the straddle channel:

Chan.	Chan. Freq. (MHz)	Average Power (mW)	Average Power (dBm)
142	5710	177.104	22.48

Note: The total power was calculated through formula and record the value for reference only.

26dB OCCUPIED BANDWIDTH

Channel	Frequency (MHz)	26dBc Bandwidth (MHz)	
		Chain 0	Chain 1
54	5270	88.82	85.09
62	5310	45.19	45.03
102	5510	45.21	44.94
110	5550	85.41	78.83
134	5670	73.09	73.01
142 (U-NII-2C Band)	5710	63.54	55.57

Note: For U-NII-2A, U-NII-2C Band output power limitation is determined based on 26dBc bandwidth

Power Limit = 11dBm + 10logB < U-NII-2A, U-NII-2C >			
Channel Number	Freq.(MHz)	Min. B(MHz)	Determined Conducted Limit (dBm)
54	5270	85.09	30.29 > 24
62	5310	45.03	27.53 > 24
102	5510	44.94	27.52 > 24
110	5550	78.83	29.96 > 24
134	5670	73.01	29.63 > 24
142 (U-NII-2C Band)	5710	55.57	28.44 > 24

802.11ac (VHT80)

POWER OUTPUT

Chan.	Chan. Freq. (MHz)	Maximum Conducted Power (dBm)		Total Power (mW)	Total Power (dBm)	Limit (dBm)	Pass / Fail
		Chain 0	Chain 1				
42	5210	15.15	13.67	56.015	17.48	24.00	Pass
58	5290	14.67	13.14	49.915	16.98	24.00	Pass
106	5530	14.88	14.32	57.801	17.62	24.00	Pass
122	5610	19.42	18.37	156.205	21.94	24.00	Pass
*138 (U-NII-2C Band)	5690	17.81	18.32	128.315	21.08	24.00	Pass
*138 (U-NII-3 Band)	5690	4.30	4.05	5.233	7.19	30.00	Pass
155	5775	20.32	19.37	194.144	22.88	30.00	Pass

Note: * Test was performed in accordance with Measurement follow FCC KDB 789033 UNII test procedure Method SA-1 and use spectrum analyzer test.

The Total Power for the straddle channel:

Chan.	Chan. Freq. (MHz)	Average Power (mW)	Average Power (dBm)
138	5690	133.548	21.26

Note: The total power was calculated through formula and record the value for reference only.

26dB OCCUPIED BANDWIDTH

Channel	Frequency (MHz)	26dBc Bandwidth (MHz)	
		Chain 0	Chain 1
58	5290	83.91	83.34
106	5530	83.76	83.47
122	5610	157.99	121.73
138 (U-NII-2C Band)	5690	106.29	106.35

Note: For U-NII-2A, U-NII-2C Band output power limitation is determined based on 26dBc bandwidth

Power Limit = 11dBm + 10logB < U-NII-2A, U-NII-2C >			
Channel Number	Freq.(MHz)	Min. B(MHz)	Determined Conducted Limit (dBm)
58	5290	83.34	30.2 > 24
106	5530	83.47	30.21 > 24
122	5610	121.73	31.85 > 24
138 (U-NII-2C Band)	5690	106.29	31.26 > 24

Spectrum Plot of Worst Value

802.11a_Chain 1 / CH144 (U-NII-2C)

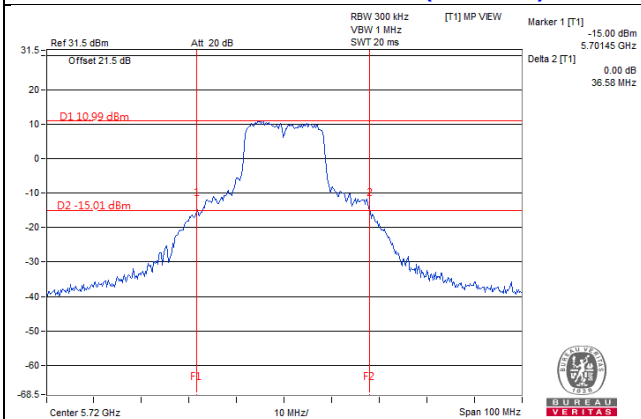

802.11ac (VHT20)_Chain 1 / CH144 (U-NII-2C)

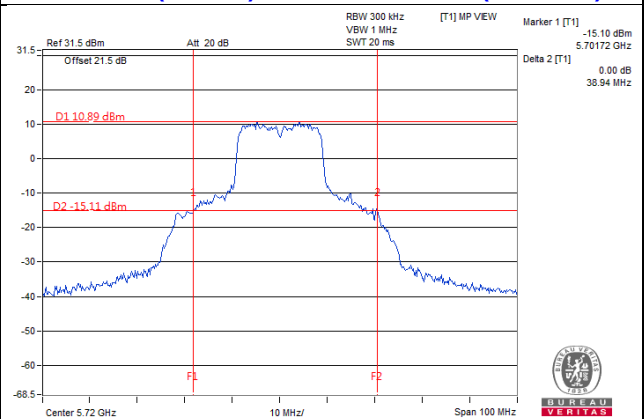

802.11ac (VHT40)_Chain 1 / CH102

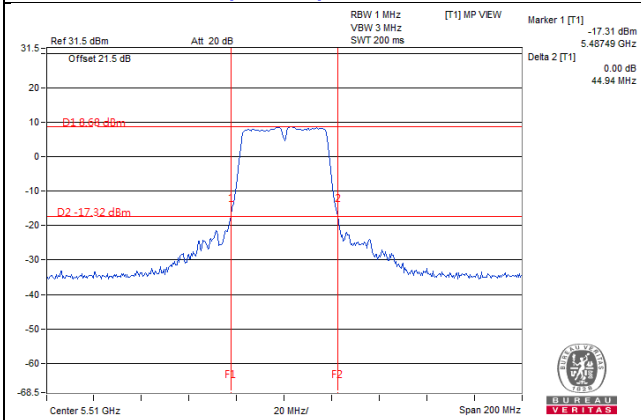

802.11ac (VHT80)_Chain 1 / CH58

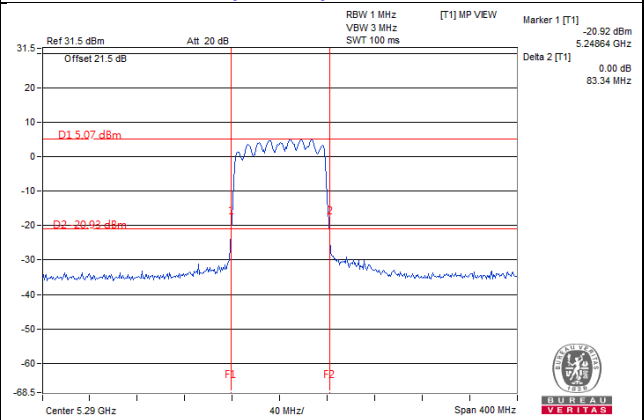

Note:

- For CH144 (U-NII-2C) = 5725MHz - Marker 1
- For CH142 (U-NII-2C) = 5725MHz - Marker 1
- For CH138 (U-NII-2C) = 5725MHz - Marker 1

4.4 Occupied Bandwidth Measurement

4.4.1 Test Setup

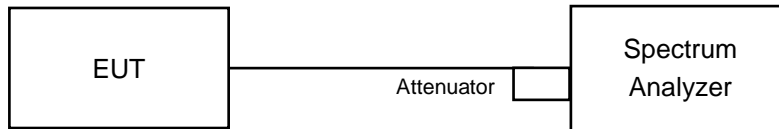

4.4.2 Test Instruments

Refer to section 4.1.2 to get information of above instrument.

4.4.3 Test Procedure

The transmitter output was connected to the spectrum analyzer through an attenuator. The bandwidth of the fundamental frequency was measured by spectrum analyzer with resolution bandwidth in the range of 1% to 5% of the anticipated emission bandwidth, and a video bandwidth at least 3x the resolution bandwidth and set the detector to SAMPLE. The width of a frequency band such that, below the lower and above the upper frequency limits, the mean powers emitted are each equal to a specified percentage 0.5% of the total mean power of a given emission.

4.4.4 Test Results

802.11a

Channel	Channel Frequency (MHz)	Occupied Bandwidth (MHz)	
		Chain 0	Chain 1
36	5180	21.60	17.52
40	5200	22.44	18.24
48	5240	17.88	20.16
52	5260	18.00	17.88
60	5300	17.76	18.00
64	5320	17.88	18.24
100	5500	19.32	17.76
116	5580	17.64	17.28
140	5700	18.24	17.76
144 (U-NII-2C Band)	5720	16.64	14.84
144 (U-NII-3 Band)	5720	6.64	4.24
149	5745	34.32	34.78
157	5785	34.68	36.84
165	5825	35.64	37.68

802.11ac (VHT20)

Channel	Channel Frequency (MHz)	Occupied Bandwidth (MHz)	
		Chain 0	Chain 1
36	5180	18.84	19.44
40	5200	20.40	25.08
48	5240	18.60	18.48
52	5260	19.32	18.24
60	5300	20.04	21.24
64	5320	20.04	22.08
100	5500	20.28	21.48
116	5580	21.96	19.32
140	5700	21.96	19.32
144 (U-NII-2C Band)	5720	17.96	14.60
144 (U-NII-3 Band)	5720	7.60	4.48
149	5745	31.32	35.04
157	5785	32.52	37.44
165	5825	34.68	38.52

802.11ac (VHT40)

Channel	Channel Frequency (MHz)	Occupied Bandwidth (MHz)	
		Chain 0	Chain 1
38	5190	36.96	36.96
46	5230	51.12	45.60
54	5270	46.08	40.08
62	5310	36.96	36.96
102	5510	36.96	36.96
110	5550	40.08	38.88
134	5670	39.36	38.88
142 (U-NII-2C Band)	5710	39.24	34.68
142 (U-NII-3 Band)	5710	7.80	4.20
151	5755	68.88	62.16
159	5795	77.52	71.52

802.11ac (VHT80)

Channel	Channel Frequency (MHz)	Occupied Bandwidth (MHz)	
		Chain 0	Chain 1
42	5210	75.84	75.36
58	5290	75.84	75.84
106	5530	75.84	75.84
122	5610	76.80	76.32
138 (U-NII-2C Band)	5690	73.40	73.40
138 (U-NII-3 Band)	5690	3.40	2.92
155	5775	93.60	77.28

Spectrum Plot of Max. Value

802.11a_Chain 1 / CH165

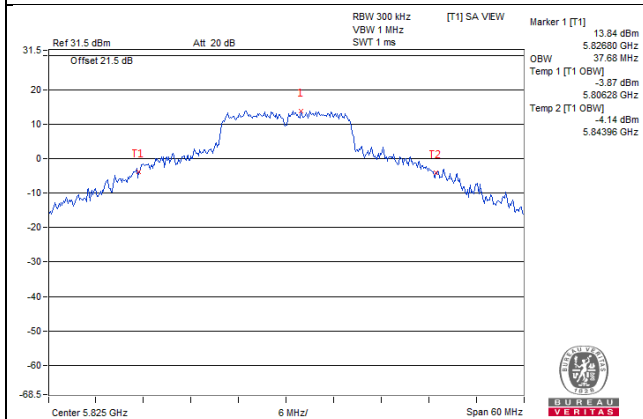

802.11ac (VHT20)_Chain 1 / CH165

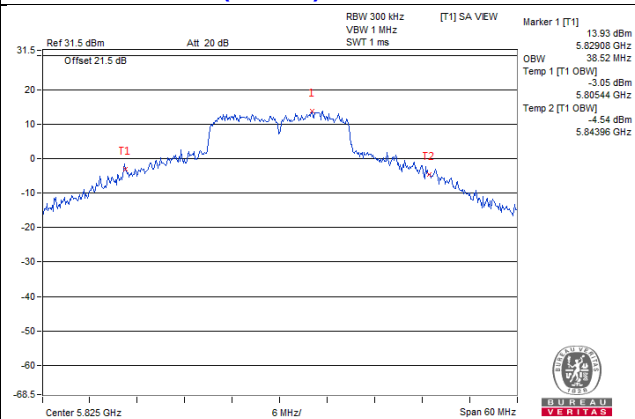

802.11ac (VHT40)_Chain 0 / CH159

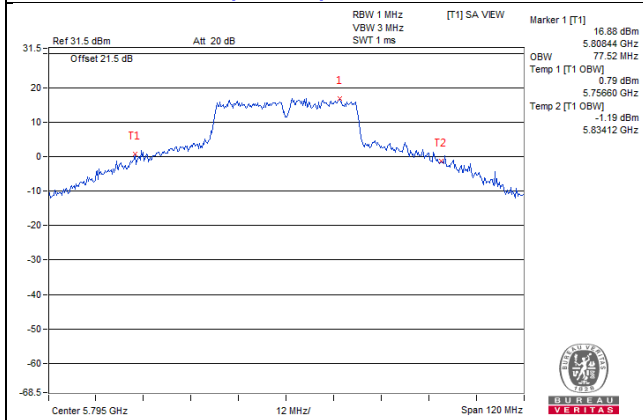

802.11ac (VHT80)_Chain 0 / CH155

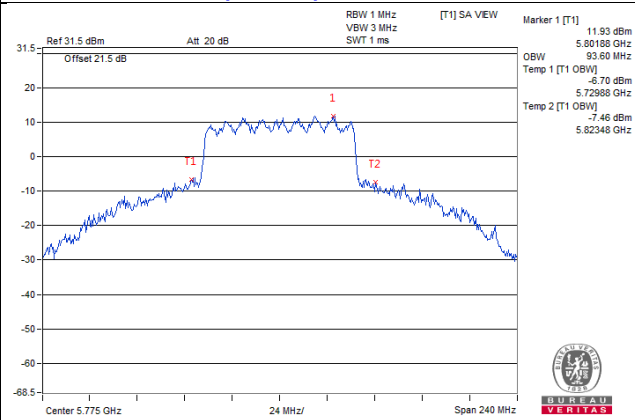

Spectrum Plot for near by DFS band
(DFS is required, if 99% OCP straddle into U-NII-2A band)

802.11a_Chain 0 / CH48

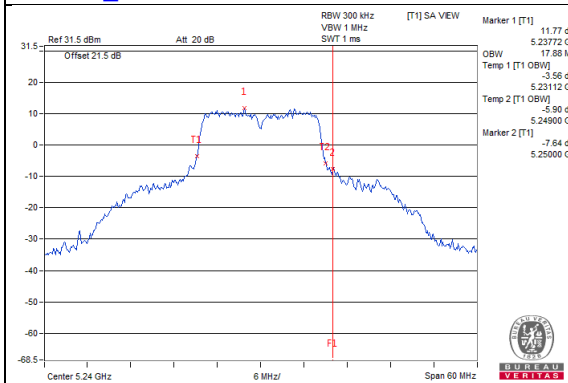

802.11a_Chain 1 / CH48

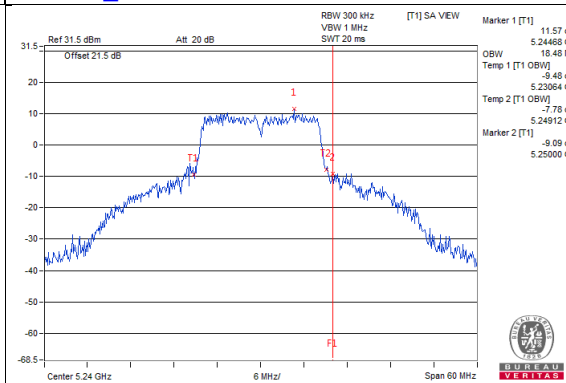

802.11ac (VHT20)_Chain 0 / CH48

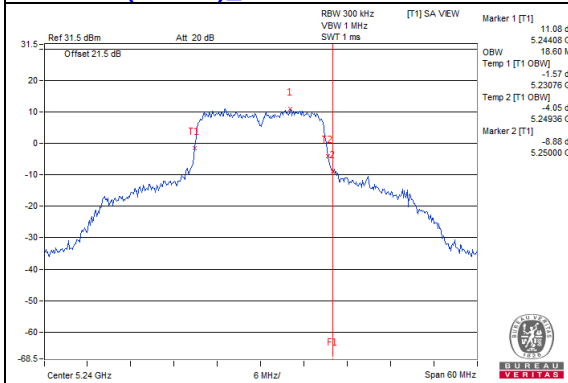

802.11ac (VHT20)_Chain 1 / CH48

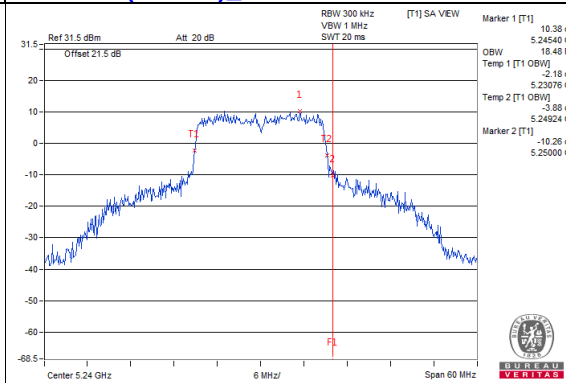

802.11ac (VHT40)_Chain 0 / CH46

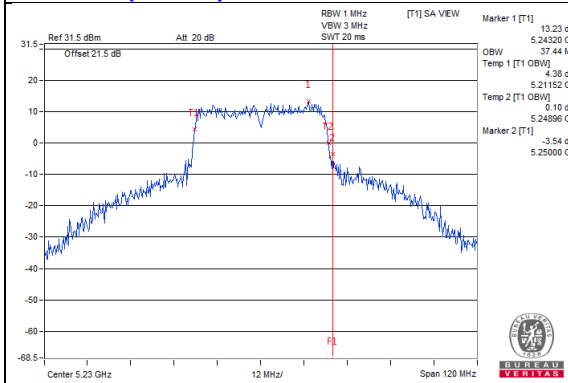

802.11ac (VHT40)_Chain 1 / CH46

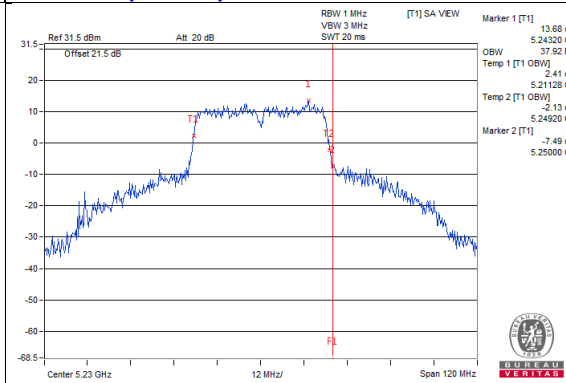

802.11ac (VHT80)_Chain 0 / CH42

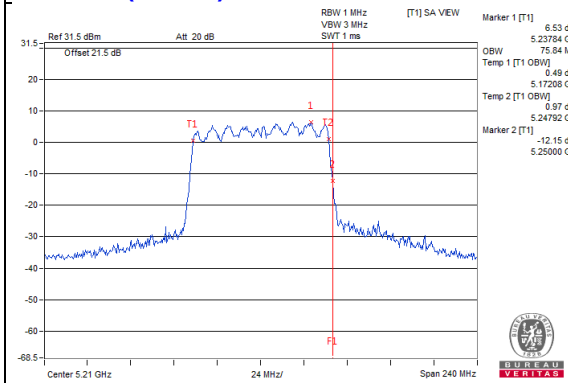

802.11ac (VHT80)_Chain 1 / CH42

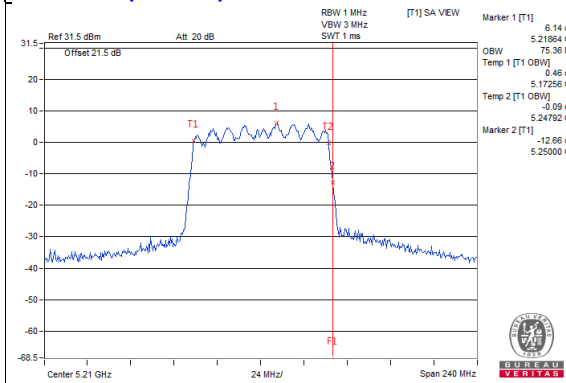

**Spectrum Plot for near by DFS band
(DFS is required, if 99% OCP straddle into U-NII-2C band)**

802.11a_Chain 0 / CH149

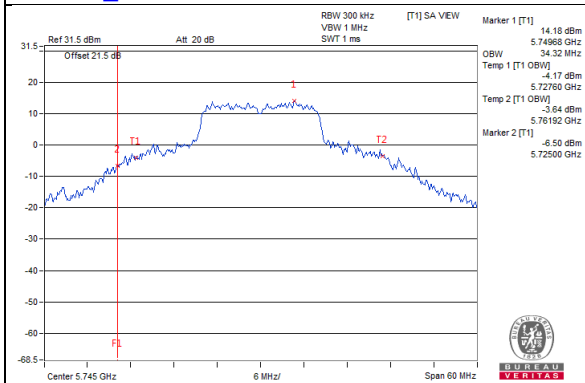

802.11a_Chain 1 / CH149

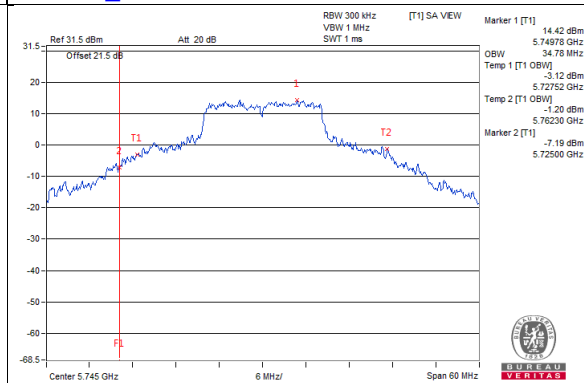

802.11ac (VHT20)_Chain 0 / CH149

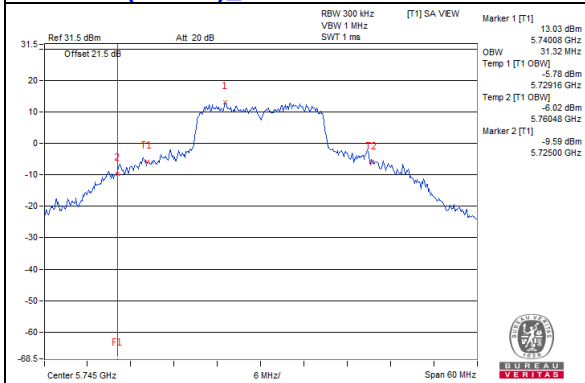

802.11ac (VHT20)_Chain 1 / CH149

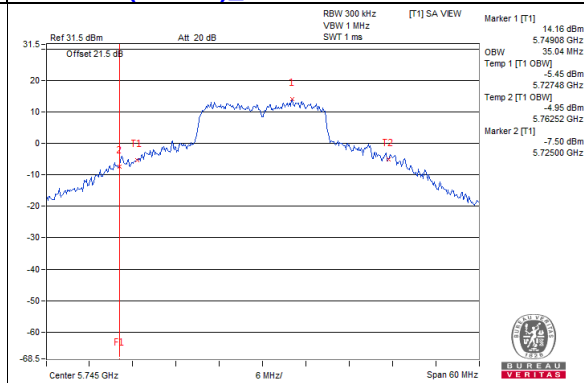

802.11ac (VHT40)_Chain 0 / CH151

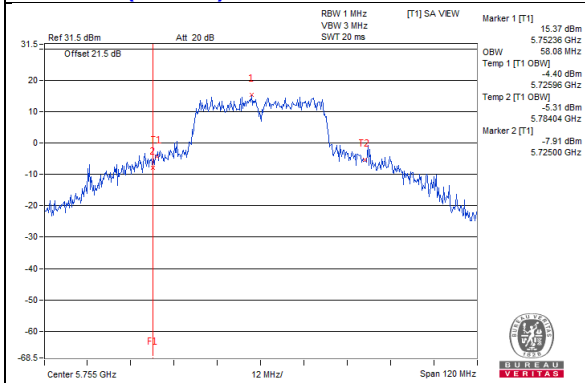

802.11ac (VHT40)_Chain 1 / CH151

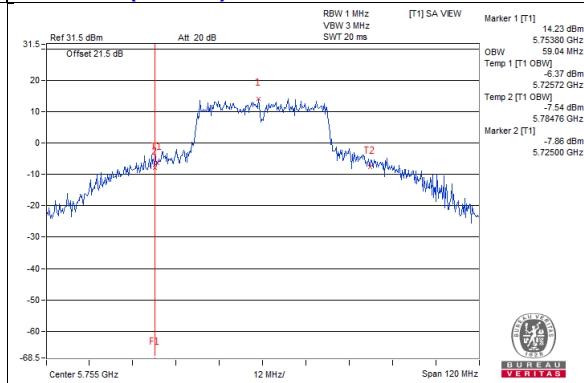

802.11ac (VHT80)_Chain 0 / CH155

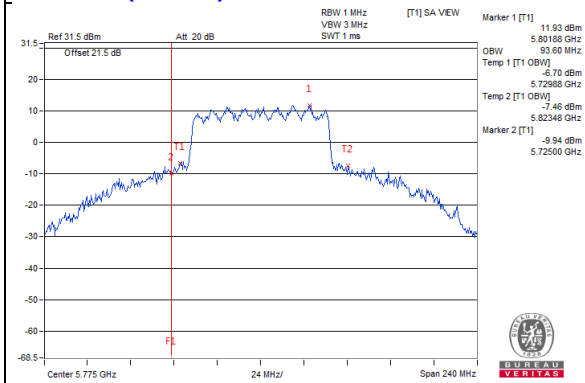

802.11ac (VHT80)_Chain 1 / CH155

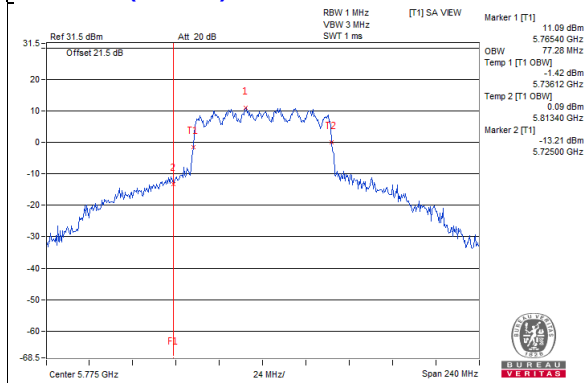

4.5 Peak Power Spectral Density Measurement

4.5.1 Limits of Peak Power Spectral Density Measurement

Operation Band	EUT Category		Limit
U-NII-1		Outdoor Access Point	17dBm/ MHz
		Fixed point-to-point Access Point	
		Indoor Access Point	
	√	Client device	11dBm/ MHz
U-NII-2A		√	11dBm/ MHz
U-NII-2C		√	11dBm/ MHz
U-NII-3		√	30dBm/ 500kHz

4.5.2 Test Setup

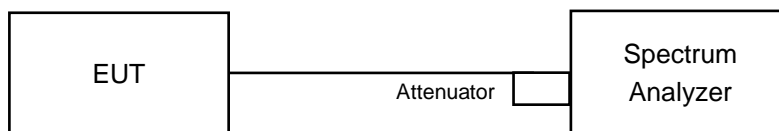

4.5.3 Test Instruments

Refer to section 4.1.2 to get information of above instrument.

4.5.4 Test Procedure

For U-NII-1, U-NII-2A, U-NII-2C band:

Using method SA-1

1. Set span to encompass the entire emission bandwidth (EBW) of the signal.
2. Set RBW = 1 MHz, Set VBW ≥ 3 MHz, Detector = RMS
3. Sweep time = auto, trigger set to “free run”.
4. Trace average at least 100 traces in power averaging mode.
5. Record the max value

For U-NII-3 band:

1. Set span to encompass the entire emission bandwidth (EBW) of the signal.
2. Set RBW = 300 kHz, Set VBW ≥ 1 MHz, Detector = RMS
3. Use the peak marker function to determine the maximum power level in any 300 kHz band segment within the fundamental EBW.
4. Scale the observed power level to an equivalent value in 500 kHz by adjusting (reducing) the measured power by a bandwidth correction factor (BWCF) where $BWCF = 10\log(500\text{ kHz}/300\text{ kHz})$
5. Sweep time = auto, trigger set to “free run”.
6. Trace average at least 100 traces in power averaging mode.
7. Record the max value

4.5.5 Deviation from Test Standard

No deviation.

4.5.6 EUT Operating Condition

Same as Item 4.3.6.

4.5.7 Test Results

For U-NII-1, U-NII-2A, U-NII-2C:

802.11a

Chan.	Chan. Freq. (MHz)	PSD (dBm/MHz)		Total Power Density (dBm/MHz)	MAX. Limit (dBm/MHz)	Pass / Fail
		Chain 0	Chain 1			
36	5180	7.49	7.25	10.38	10.57	Pass
40	5200	7.67	7.35	10.52	10.57	Pass
48	5240	7.43	7.67	10.56	10.57	Pass
52	5260	7.83	7.19	10.53	10.54	Pass
60	5300	7.34	7.09	10.23	10.54	Pass
64	5320	7.17	7.53	10.36	10.54	Pass
100	5500	7.69	7.40	10.56	10.84	Pass
116	5580	7.25	7.44	10.36	10.84	Pass
140	5700	7.48	7.64	10.57	10.84	Pass
144 (U-NII-2C Band)	5720	7.00	7.31	10.17	10.84	Pass

- Note: 1. Method a) of power density measurement of KDB 662911 is using for calculating total power density. Total power density is summing entire spectra across corresponding frequency bins on the various outputs by computer.
2. For U-NII-1: The directional gain = $10 \log[(10^{\text{Chain0}/20} + 10^{\text{Chain1}/20})^2 / 2] = 6.43\text{dBi} > 6\text{dBi}$, so the power density limit shall be reduced to $11 - (6.43 - 6) = 10.57\text{dBm}$.
3. For U-NII-2A: The directional gain = $10 \log[(10^{\text{Chain0}/20} + 10^{\text{Chain1}/20})^2 / 2] = 6.46\text{dBi} > 6\text{dBi}$, so the power density limit shall be reduced to $11 - (6.46 - 6) = 10.54\text{dBm}$.
4. For U-NII-2C: The directional gain = $10 \log[(10^{\text{Chain0}/20} + 10^{\text{Chain1}/20})^2 / 2] = 6.16\text{dBi} > 6\text{dBi}$, so the power density limit shall be reduced to $11 - (6.16 - 6) = 10.84\text{dBm}$.

802.11ac (VHT20)

Chan.	Chan. Freq. (MHz)	PSD (dBm/MHz)		Total Power Density (dBm/MHz)	MAX. Limit (dBm/MHz)	Pass / Fail
		Chain 0	Chain 1			
36	5180	7.24	6.38	9.84	10.57	Pass
40	5200	7.73	7.28	10.52	10.57	Pass
48	5240	7.07	7.55	10.33	10.57	Pass
52	5260	7.43	5.98	9.78	10.54	Pass
60	5300	7.62	7.03	10.35	10.54	Pass
64	5320	7.60	7.14	10.39	10.54	Pass
100	5500	7.54	7.18	10.37	10.84	Pass
116	5580	7.60	6.85	10.25	10.84	Pass
140	5700	7.33	6.69	10.03	10.84	Pass
144 (U-NII-2C Band)	5720	7.39	6.61	10.03	10.84	Pass

Note: 1. Method a) of power density measurement of KDB 662911 is using for calculating total power density. Total power density is summing entire spectra across corresponding frequency bins on the various outputs by computer.

2. For U-NII-1: The directional gain = $10 \log[(10^{\text{Chain0}/20} + 10^{\text{Chain1}/20})^2 / 2] = 6.43\text{dBi} > 6\text{dBi}$, so the power density limit shall be reduced to $11-(6.43-6)=10.57\text{dBm}$.
3. For U-NII-2A: The directional gain = $10 \log[(10^{\text{Chain0}/20} + 10^{\text{Chain1}/20})^2 / 2] = 6.46\text{dBi} > 6\text{dBi}$, so the power density limit shall be reduced to $11-(6.46-6)=10.54\text{dBm}$.
4. For U-NII-2C: The directional gain = $10 \log[(10^{\text{Chain0}/20} + 10^{\text{Chain1}/20})^2 / 2] = 6.16\text{dBi} > 6\text{dBi}$, so the power density limit shall be reduced to $11-(6.16-6)=10.84\text{dBm}$.

802.11ac (VHT40)

Chan.	Chan. Freq. (MHz)	PSD (dBm/MHz)		Total Power Density (dBm/MHz)	MAX. Limit (dBm/MHz)	Pass / Fail
		Chain 0	Chain 1			
38	5190	-0.56	-2.22	1.70	10.57	Pass
46	5230	5.24	4.30	7.81	10.57	Pass
54	5270	4.85	3.75	7.35	10.54	Pass
62	5310	-0.32	-1.41	2.18	10.54	Pass
102	5510	-0.03	-0.83	2.60	10.84	Pass
110	5550	4.05	3.95	7.01	10.84	Pass
134	5670	3.06	2.83	5.96	10.84	Pass
142 (U-NII-2C Band)	5710	3.91	3.81	6.87	10.84	Pass

- Note: 1. Method a) of power density measurement of KDB 662911 is using for calculating total power density. Total power density is summing entire spectra across corresponding frequency bins on the various outputs by computer.
2. For U-NII-1: The directional gain = $10 \log[(10^{\text{Chain0}/20} + 10^{\text{Chain1}/20})^2 / 2] = 6.43\text{dBi} > 6\text{dBi}$, so the power density limit shall be reduced to $11-(6.43-6)=10.57\text{dBm}$.
3. For U-NII-2A: The directional gain = $10 \log[(10^{\text{Chain0}/20} + 10^{\text{Chain1}/20})^2 / 2] = 6.46\text{dBi} > 6\text{dBi}$, so the power density limit shall be reduced to $11-(6.46-6)=10.54\text{dBm}$.
4. For U-NII-2C: The directional gain = $10 \log[(10^{\text{Chain0}/20} + 10^{\text{Chain1}/20})^2 / 2] = 6.16\text{dBi} > 6\text{dBi}$, so the power density limit shall be reduced to $11-(6.16-6)=10.84\text{dBm}$.

802.11ac (VHT80)

Chan.	Chan. Freq. (MHz)	PSD (dBm/MHz)		Total Power Density (dBm/MHz)	MAX. Limit (dBm/MHz)	Pass / Fail
		Chain 0	Chain 1			
42	5210	-2.57	-3.25	0.11	10.57	Pass
58	5290	-2.96	-4.35	-0.59	10.54	Pass
106	5530	-2.76	-3.05	0.11	10.84	Pass
122	5610	1.74	0.88	4.34	10.84	Pass
138 (U-NII-2C Band)	5690	0.53	1.03	3.80	10.84	Pass

- Note: 1. Method a) of power density measurement of KDB 662911 is using for calculating total power density. Total power density is summing entire spectra across corresponding frequency bins on the various outputs by computer.
2. For U-NII-1: The directional gain = $10 \log[(10^{\text{Chain0}/20} + 10^{\text{Chain1}/20})^2 / 2] = 6.43\text{dBi} > 6\text{dBi}$, so the power density limit shall be reduced to $11-(6.43-6)=10.57\text{dBm}$.
3. For U-NII-2A: The directional gain = $10 \log[(10^{\text{Chain0}/20} + 10^{\text{Chain1}/20})^2 / 2] = 6.46\text{dBi} > 6\text{dBi}$, so the power density limit shall be reduced to $11-(6.46-6)=10.54\text{dBm}$.
4. For U-NII-2C: The directional gain = $10 \log[(10^{\text{Chain0}/20} + 10^{\text{Chain1}/20})^2 / 2] = 6.16\text{dBi} > 6\text{dBi}$, so the power density limit shall be reduced to $11-(6.16-6)=10.84\text{dBm}$.

Spectrum Plot of Worst Value

802.11a_Chain 0 / CH52

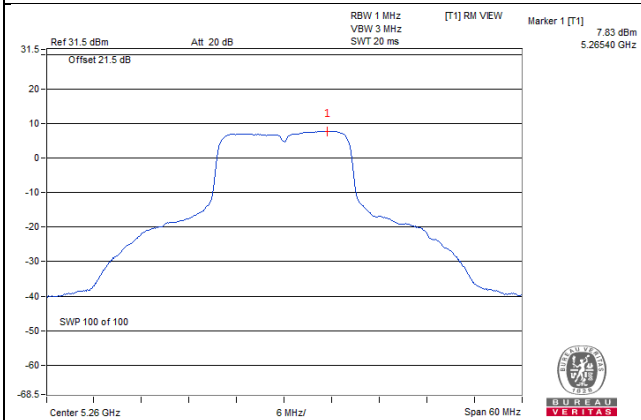

802.11ac (VHT20)_Chain 0 / CH40

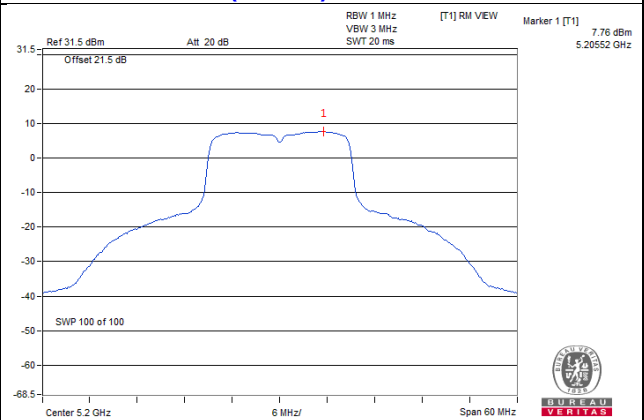

802.11ac (VHT40)_Chain 0 / CH46

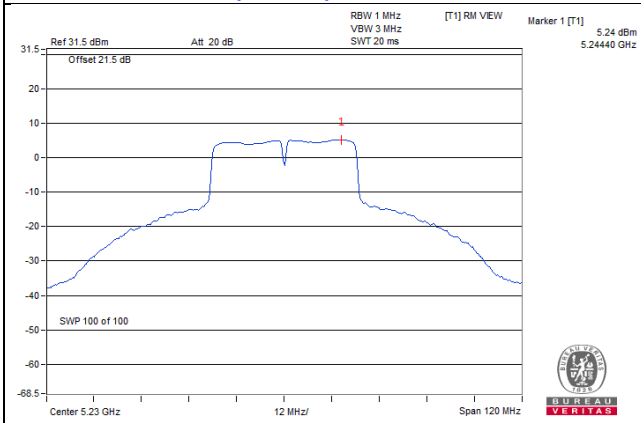

802.11ac (VHT80)_Chain 0 / CH122

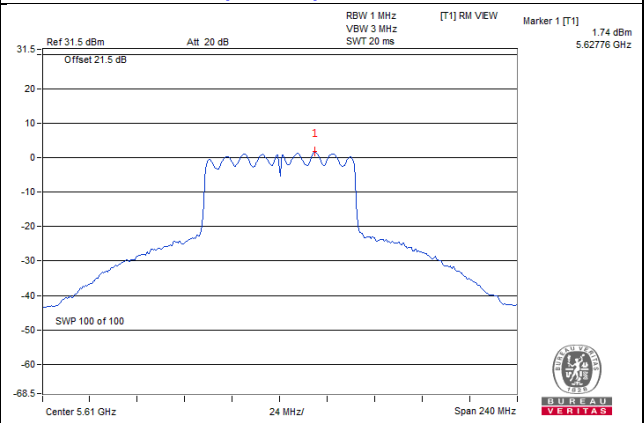

For U-NII-3:
802.11a

Chan.	Freq. (MHz)	PSD (dBm/300kHz)		Total PSD		Total PSD (dBm/500kHz)	Limit (dBm/500kHz)	Pass /Fail
		Chain 0	Chain 1	mW/300kHz	dBm/300kHz			
144 (U-NII-3 Band)	5720	-0.83	-1.68	1.5052	1.78	4.00	29.41	Pass
149	5745	1.47	1.87	2.941	4.68	6.90	29.41	Pass
157	5785	1.19	1.85	2.8463	4.54	6.76	29.41	Pass
165	5825	0.82	1.56	2.64	4.22	6.44	29.41	Pass

Note: 1. Method b) Measure and sum spectral maxima across the outputs of KDB 662911 is using for calculating total power density.
 2. The directional gain = $10 \log[(10^{\text{Chain0}/20} + 10^{\text{Chain1}/20})^2 / 2] = 6.59\text{dBi} > 6\text{dBi}$, so the power density limit shall be reduced to $30 - (6.59 - 6) = 29.41\text{dBm}$.

802.11ac (VHT20)

Chan.	Freq. (MHz)	PSD (dBm/300kHz)		Total PSD		Total PSD (dBm/500kHz)	Limit (dBm/500kHz)	Pass /Fail
		Chain 0	Chain 1	mW/300kHz	dBm/300kHz			
144 (U-NII-3 Band)	5720	-1.27	-2.19	1.3504	1.30	3.52	29.41	Pass
149	5745	-0.15	0.55	2.1011	3.22	5.44	29.41	Pass
157	5785	0.00	0.95	2.2445	3.51	5.73	29.41	Pass
165	5825	0.50	0.82	2.3298	3.67	5.89	29.41	Pass

Note: 1. Method b) Measure and sum spectral maxima across the outputs of KDB 662911 is using for calculating total power density.
 2. The directional gain = $10 \log[(10^{\text{Chain0}/20} + 10^{\text{Chain1}/20})^2 / 2] = 6.59\text{dBi} > 6\text{dBi}$, so the power density limit shall be reduced to $30 - (6.59 - 6) = 29.41\text{dBm}$.

802.11ac (VHT40)

Chan.	Freq. (MHz)	PSD (dBm/300kHz)		Total PSD		Total PSD (dBm/500kHz)	Limit (dBm/500kHz)	Pass /Fail
		Chain 0	Chain 1	mW/300kHz	dBm/300kHz			
142 (U-NII-3 Band)	5710	-5.54	-5.91	0.5357	-2.71	-0.49	29.41	Pass
151	5755	-3.21	-3.50	0.9242	-0.34	1.88	29.41	Pass
159	5795	-2.91	-2.60	1.0612	0.26	2.48	29.41	Pass

Note: 1. Method b) Measure and sum spectral maxima across the outputs of KDB 662911 is using for calculating total power density.
 2. The directional gain = $10 \log[(10^{\text{Chain0}/20} + 10^{\text{Chain1}/20})^2 / 2] = 6.59\text{dBi} > 6\text{dBi}$, so the power density limit shall be reduced to $30 - (6.59 - 6) = 29.41\text{dBm}$.

802.11ac (VHT80)

Chan.	Freq. (MHz)	PSD (dBm/300kHz)		Total PSD		Total PSD (dBm/500kHz)	Limit (dBm/500kHz)	Pass /Fail
		Chain 0	Chain 1	mW/300kHz	dBm/300kHz			
138 (U-NII-3 Band)	5690	-10.26	-10.14	0.19102	-7.19	-4.97	29.41	Pass
155	5775	-6.84	-7.50	0.3848	-4.15	-1.93	29.41	Pass

Note: 1. Method b) Measure and sum spectral maxima across the outputs of KDB 662911 is using for calculating total power density.
 2. The directional gain = $10 \log[(10^{\text{Chain0}/20} + 10^{\text{Chain1}/20})^2 / 2] = 6.59\text{dBi} > 6\text{dBi}$, so the power density limit shall be reduced to $30 - (6.59 - 6) = 29.41\text{dBm}$.

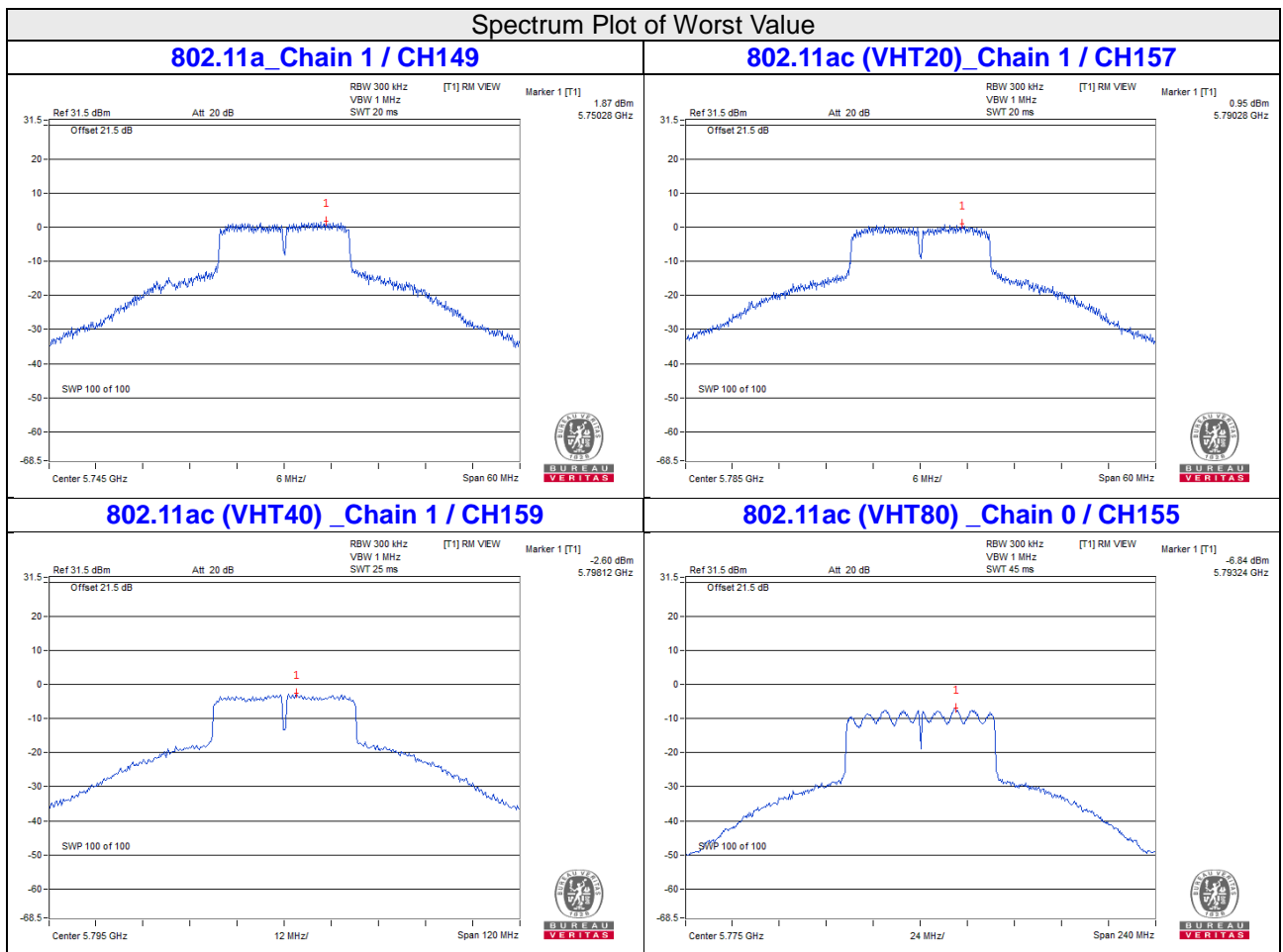

4.6 Frequency Stability Measurement

4.6.1 Limits of Frequency Stability Measurement

The frequency of the carrier signal shall be maintained within band of operation

4.6.2 Test Setup

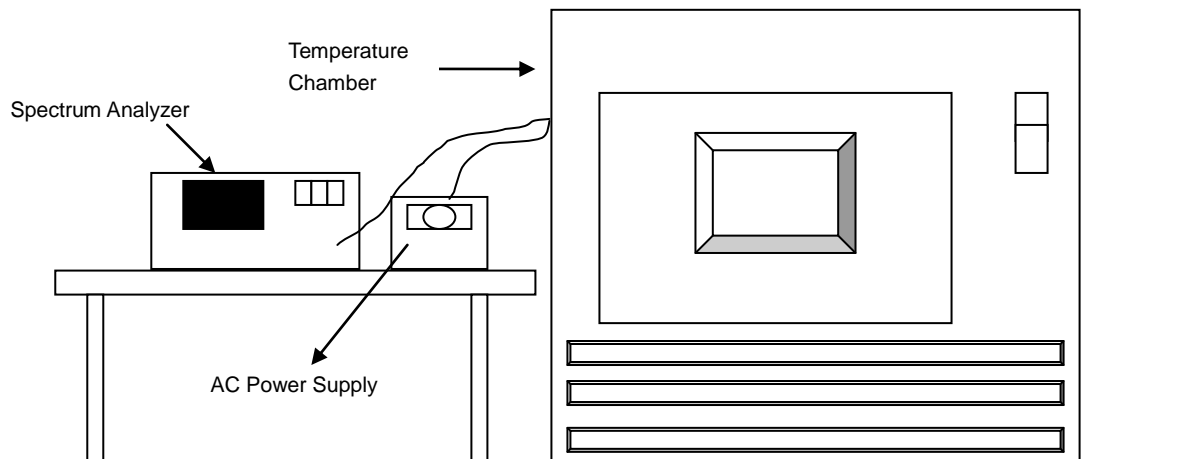

4.6.3 Test Instruments

Refer to section 4.1.2 to get information of above instrument.

4.6.4 Test Procedure

- The EUT was placed inside the environmental test chamber and powered by nominal AC voltage.
- Turn the EUT on and couple its output to a spectrum analyzer.
- Turn the EUT off and set the chamber to the highest temperature specified.
- Allow sufficient time (approximately 30 min) for the temperature of the chamber to stabilize, turn the EUT on and measure the operating frequency after 2, 5, and 10 Minutes.
- Repeat step (d) with the temperature chamber set to the next desired temperature until measurements down to the lowest specified temperature have been completed.
- The test chamber was allowed to stabilize at +20 degree C for a minimum of 30 Minutes. The supply voltage was then adjusted on the EUT from 85% to 115% and the frequency record.

4.6.5 Deviation from Test Standard

No deviation.

4.6.6 EUT Operating Condition

Set the EUT transmit at un-modulation mode to test frequency stability.

4.6.7 Test Results

Frequency Stability Versus Temp.									
Operating Frequency: 5180 MHz									
TEMP. (°C)	Power Supply (Vac)	0 Minute		2 Minutes		5 Minutes		10 Minutes	
		Measured Frequency (MHz)	Pass/Fail	Measured Frequency (MHz)	Pass/Fail	Measured Frequency (MHz)	Pass/Fail	Measured Frequency (MHz)	Pass/Fail
50	120	5179.9893	PASS	5179.99	PASS	5179.9868	PASS	5179.9878	PASS
40	120	5180.014	PASS	5180.0133	PASS	5180.0129	PASS	5180.0115	PASS
30	120	5180.0229	PASS	5180.0241	PASS	5180.0241	PASS	5180.0193	PASS
20	120	5179.9824	PASS	5179.9799	PASS	5179.9828	PASS	5179.9795	PASS
10	120	5180.0091	PASS	5180.0078	PASS	5180.0083	PASS	5180.0101	PASS
0	120	5179.9939	PASS	5179.9947	PASS	5179.997	PASS	5179.9968	PASS
-10	120	5179.9902	PASS	5179.9899	PASS	5179.9914	PASS	5179.991	PASS
-20	120	5179.9794	PASS	5179.9791	PASS	5179.979	PASS	5179.9794	PASS
-30	120	5179.9821	PASS	5179.9846	PASS	5179.9839	PASS	5179.9848	PASS

Frequency Stability Versus Voltage									
Operating Frequency: 5180 MHz									
TEMP. (°C)	Power Supply (Vac)	0 Minute		2 Minutes		5 Minutes		10 Minutes	
		Measured Frequency (MHz)	Pass/Fail	Measured Frequency (MHz)	Pass/Fail	Measured Frequency (MHz)	Pass/Fail	Measured Frequency (MHz)	Pass/Fail
20	138	5179.9827	PASS	5179.9795	PASS	5179.9821	PASS	5179.9791	PASS
	120	5179.9824	PASS	5179.9799	PASS	5179.9828	PASS	5179.9795	PASS
	102	5179.9828	PASS	5179.9793	PASS	5179.9827	PASS	5179.9788	PASS

4.7 6dB Bandwidth Measurement

4.7.1 Limits of 6dB Bandwidth Measurement

The minimum of 6dB Bandwidth Measurement is 0.5MHz.

4.7.2 Test Setup

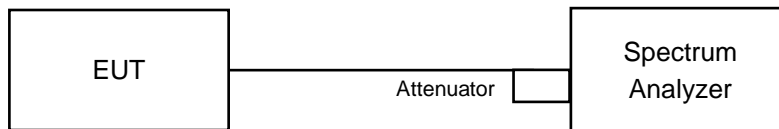

4.7.3 Test Instruments

Refer to section 4.1.2 to get information of above instrument.

4.7.4 Test Procedure

MEASUREMENT PROCEDURE REF

- Set resolution bandwidth (RBW) = 100kHz
- Set the video bandwidth (VBW) $\geq 3 \times$ RBW, Detector = Peak.
- Trace mode = max hold.
- Sweep = auto couple.
- Measure the maximum width of the emission that is constrained by the frequencies associated with the two amplitude points (upper and lower) that are attenuated by 6 dB relative to the maximum level measured in the fundamental emission.

4.7.5 Deviation from Test Standard

No deviation.

4.7.6 EUT Operating Condition

The software provided by client to enable the EUT under transmission condition continuously at lowest, middle and highest channel frequencies individually.

4.7.7 Test Results

802.11a

Channel	Frequency (MHz)	6dB Bandwidth (MHz)		Minimum Limit (MHz)	Pass / Fail
		Chain 0	Chain 1		
144 (U-NII-3 Band)	5720	3.22	3.20	0.5	Pass
149	5745	16.52	16.46	0.5	Pass
157	5785	16.52	16.53	0.5	Pass
165	5825	16.50	16.49	0.5	Pass

802.11ac (VHT20)

Channel	Frequency (MHz)	6dB Bandwidth (MHz)		Minimum Limit (MHz)	Pass / Fail
		Chain 0	Chain 1		
144 (U-NII-3 Band)	5720	3.81	3.81	0.5	Pass
149	5745	17.79	17.76	0.5	Pass
157	5785	17.79	17.79	0.5	Pass
165	5825	17.81	17.80	0.5	Pass

802.11ac (VHT40)

Channel	Frequency (MHz)	6dB Bandwidth (MHz)		Minimum Limit (MHz)	Pass / Fail
		Chain 0	Chain 1		
142 (U-NII-3 Band)	5710	3.29	3.27	0.5	Pass
151	5755	36.58	36.54	0.5	Pass
159	5795	36.57	36.53	0.5	Pass

802.11ac (VHT80)

Channel	Frequency (MHz)	6dB Bandwidth (MHz)		Minimum Limit (MHz)	Pass / Fail
		Chain 0	Chain 1		
138 (U-NII-3 Band)	5690	3.23	3.07	0.5	Pass
155	5775	76.39	76.27	0.5	Pass

Spectrum Plot of Worst Value

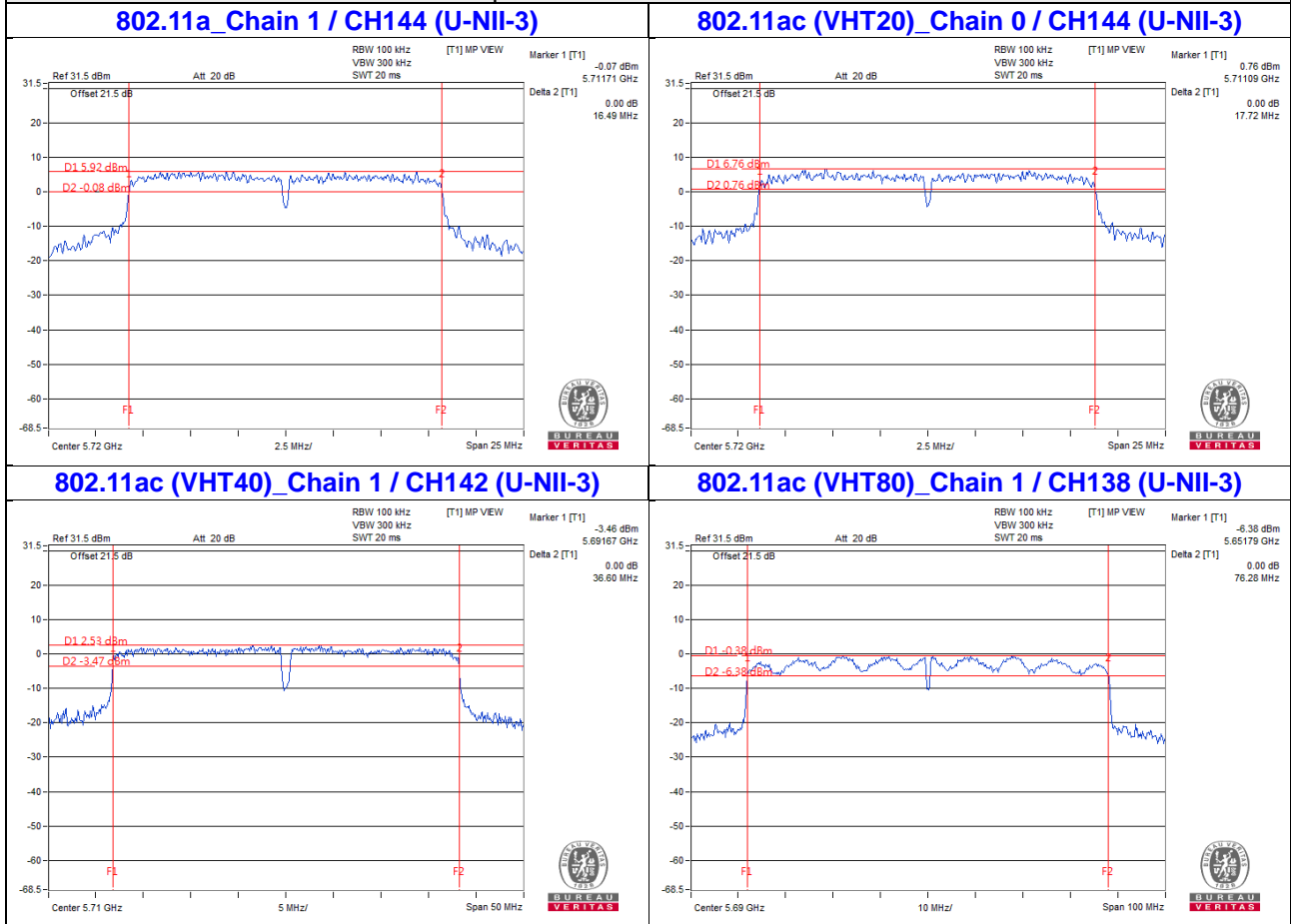

Note: The 6dB bandwidth above 5725MHz = Marker 1 + Delta 2 - 5725MHz

5 Pictures of Test Arrangements

Please refer to the attached file (Test Setup Photo).

Annex A- Radiated Out of Band Emission (OOBE) Measurement (For U-NII-3 band)

802.11a

CH 149 5745 MHz

Horizontal

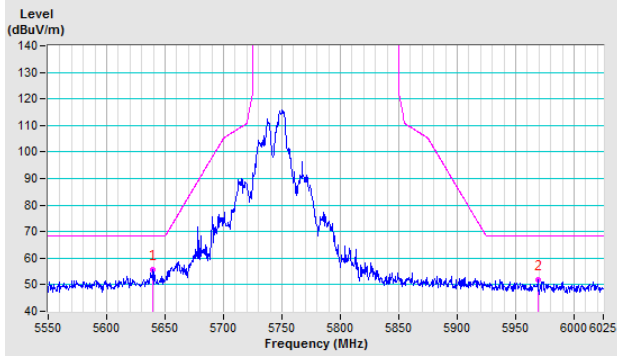

Vertical

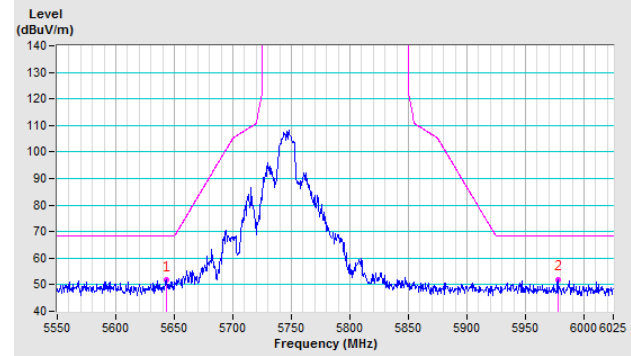

CH 157 5785 MHz

Horizontal

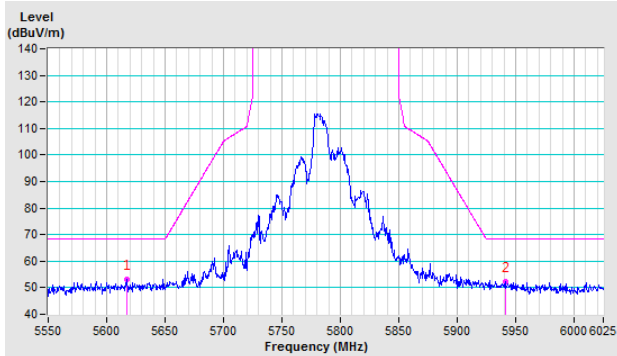

Vertical

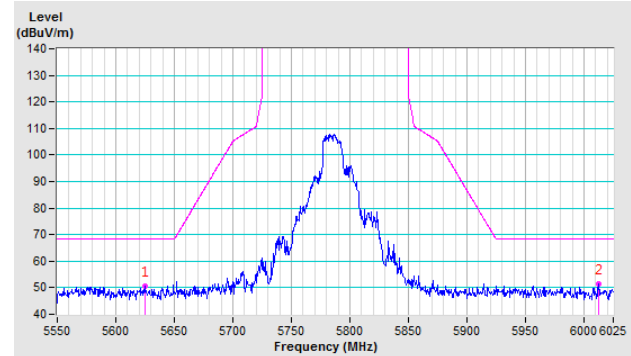

CH 165 5825 MHz

Horizontal

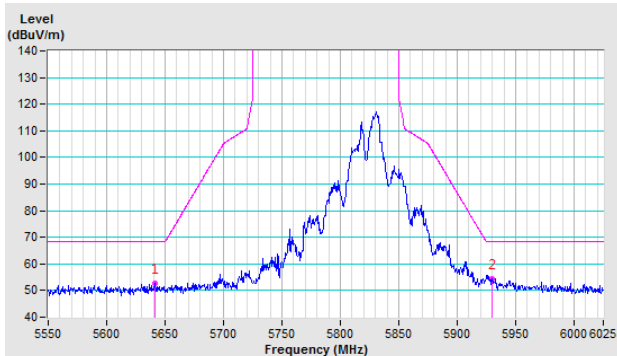

Vertical

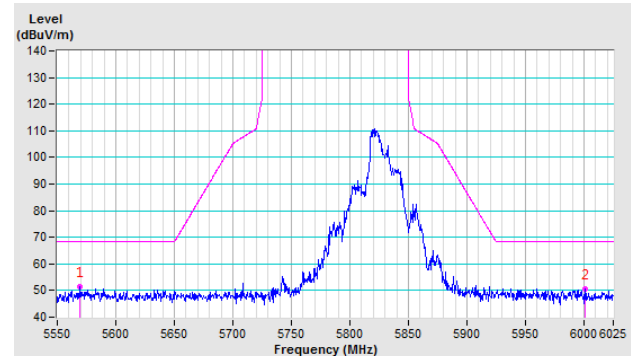

802.11ac (VHT20)

CH 149 5745 MHz

Horizontal

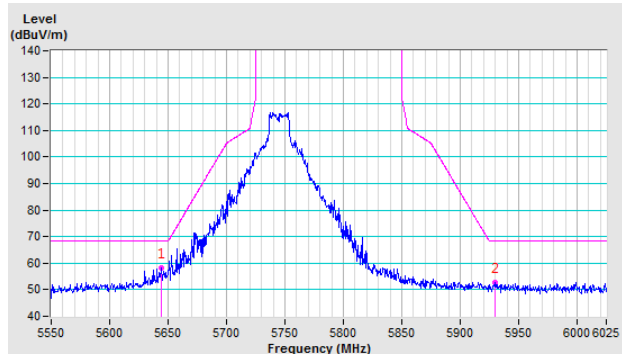

Vertical

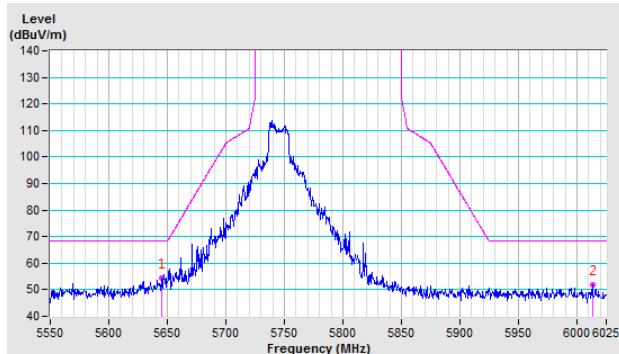

CH 157 5785 MHz

Horizontal

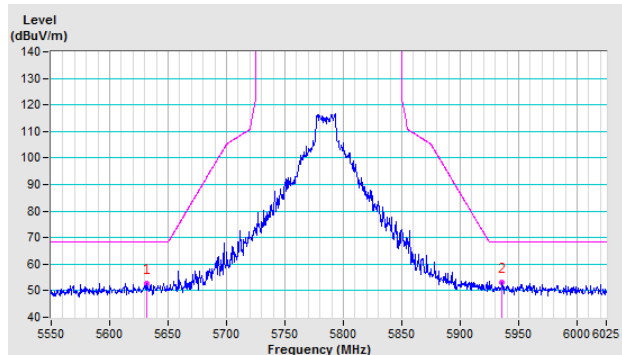

Vertical

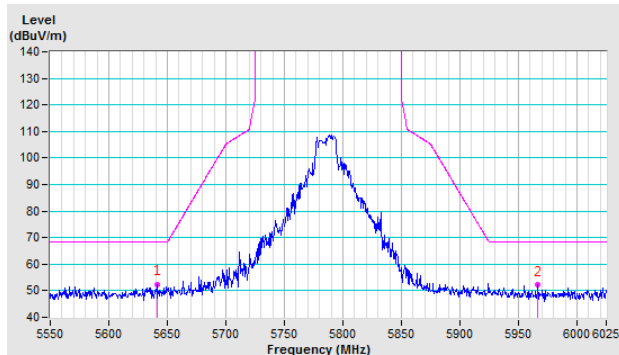

CH 165 5825 MHz

Horizontal

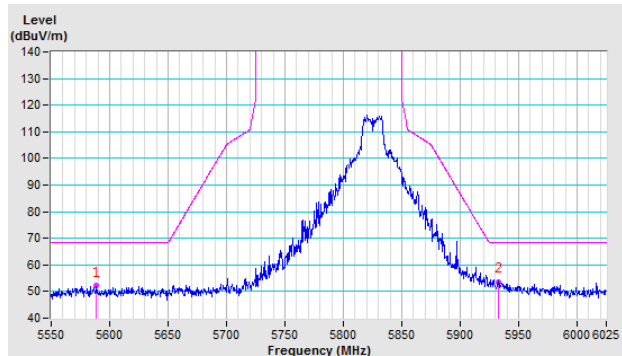

Vertical

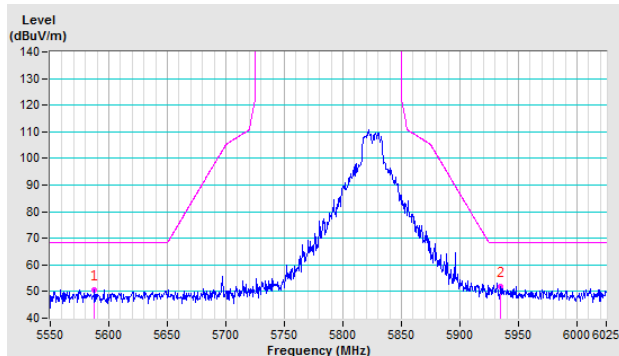

802.11ac (VHT40)

CH 151 5755 MHz

Horizontal

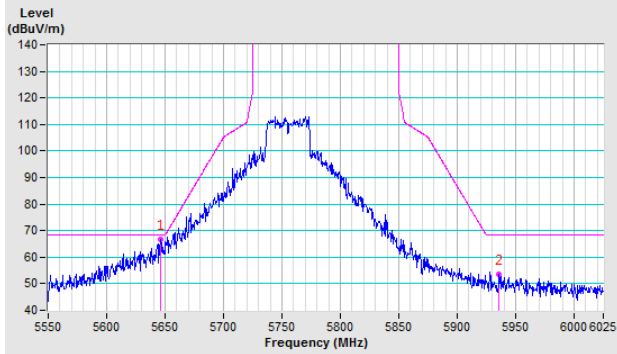

Vertical

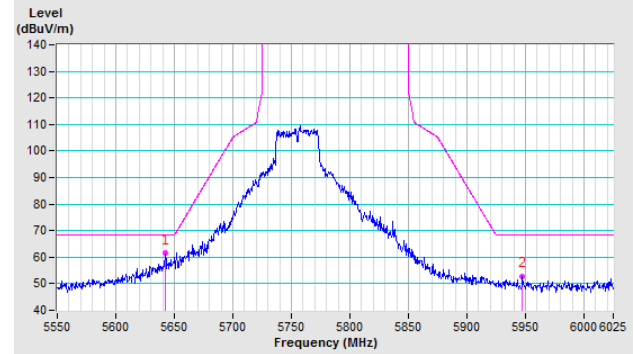

CH 159 5795 MHz

Horizontal

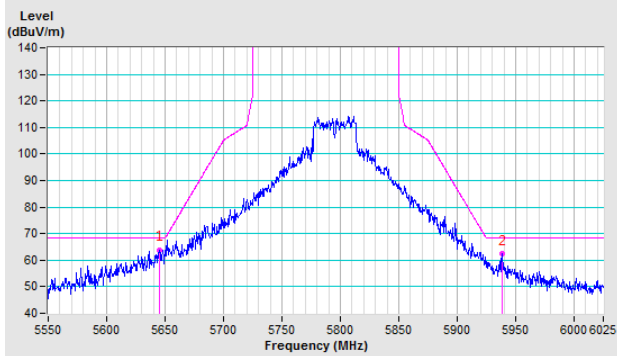

Vertical

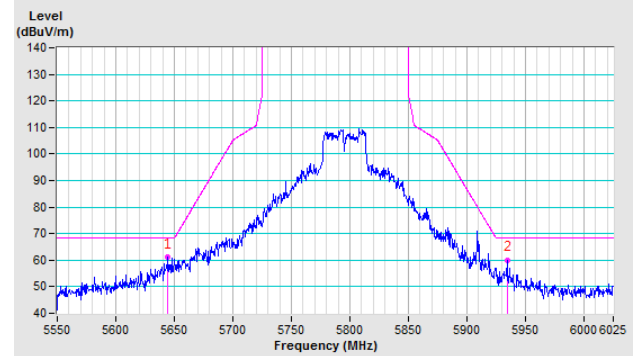

802.11ac (VHT80)

CH 155 5775 MHz

Horizontal

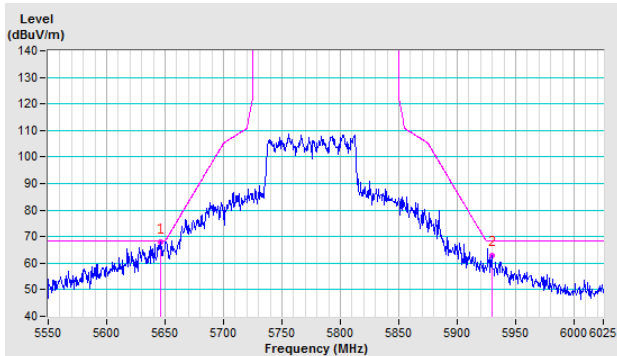

Vertical

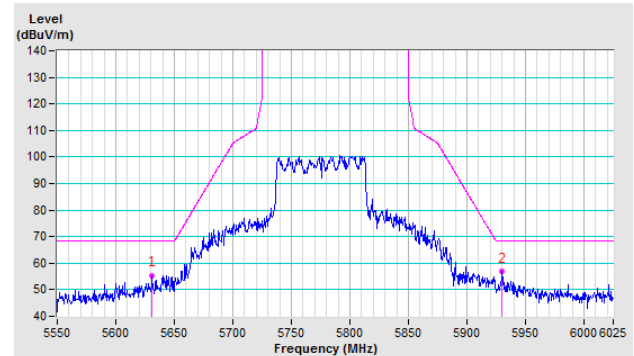

Appendix – Information of the Testing Laboratories

We, Bureau Veritas Consumer Products Services (H.K.) Ltd., Taoyuan Branch, were founded in 1988 to provide our best service in EMC, Radio, Telecom and Safety consultation. Our laboratories are FCC recognized accredited test firms and accredited according to ISO/IEC 17025.

If you have any comments, please feel free to contact us at the following:

Lin Kou EMC/RF Lab

Tel: 886-2-26052180

Fax: 886-2-26051924

Hsin Chu EMC/RF/Telecom Lab

Tel: 886-3-6668565

Fax: 886-3-6668323

Hwa Ya EMC/RF/Safety Lab

Tel: 886-3-3183232

Fax: 886-3-3270892

Email: service.adt@tw.bureauveritas.com

Web Site: www.bureauveritas-adt.com

The address and road map of all our labs can be found in our web site also.

--- END ---