

7. Frequency Stability Under Temperature & Voltage Variations

7.1. Test Specification

According to Part 2.1055, 24.235, 27.54

7.2. Test Setup

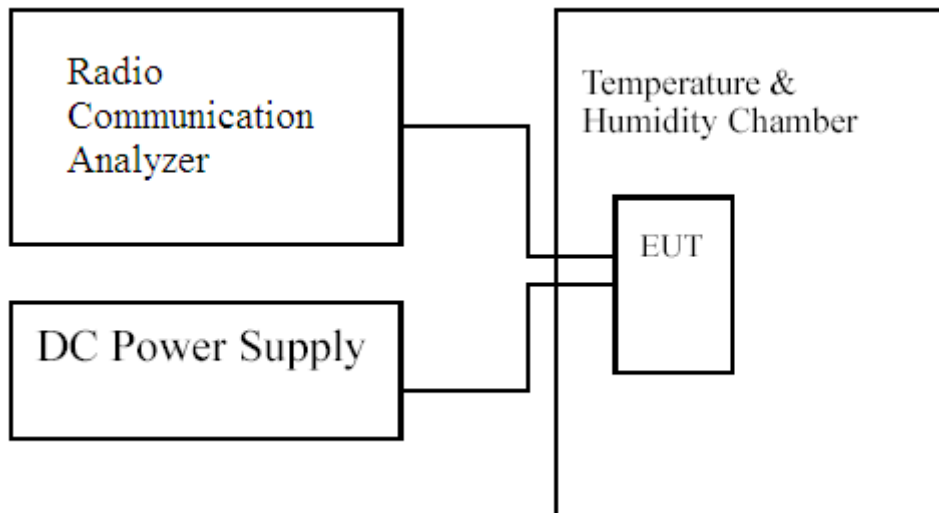

7.3. Limits

Limit	$<\pm 2.5\text{ppm}$
-------	----------------------

7.4. Test Procedure

The frequency stability of transmitter is measured by:

- (a) Temperature: The temperature is varied from -30°C to 50°C in 10°C increment using a standard temperature & Humidity chamber.
- (b) Primary Supply Voltage: The primary supply voltage is varied 85% to 115% of the nominal value for non hand-carried equipment. For hand-carried, battery-powered equipment, primary supply voltage is reduced to the battery operating endpoint which shall be specified by the manufacturer.

The EUT was connected via the base station simulator. Universal Radio Communication Tester, (MT8820C), was used to measure The Frequency Error. The maximum result of measurements was recorded.

7.5. Test Result of Frequency Stability Under Temperature Variations

Product	LTE Router		
Test Mode	Frequency Stability Under Temperature Variations & Voltage Variations		
Date of Test	2016/12/13	Test Site	CTR
Test Condition	Band 2 (1.4M) CH18900(1880MHz) –QPSK	Test Range	-20°C ~+50°C

Frequency Stability Under Temperature Variations

Temperature Interval(°C)	Test Frequency (GHz)	Deviation (kHz)	Limit (kHz)
-30	1.88	-0.0093	±4.70
-20	1.88	-0.0077	±4.70
-10	1.88	-0.0120	±4.70
0	1.88	-0.0081	±4.70
10	1.88	-0.0080	±4.70
20	1.88	-0.0094	±4.70
30	1.88	-0.0112	±4.70
40	1.88	-0.0079	±4.70
50	1.88	-0.0082	±4.70

Voltage Variations

AC Voltage (V)	Test Frequency (GHz)	Deviation (kHz)	Limit (kHz)
138	1.88	-0.0104	±4.70
120	1.88	-0.0094	±4.70
102	1.88	-0.0100	±4.70

Product	LTE Router		
Test Mode	Frequency Stability Under Temperature Variations & Voltage Variations		
Date of Test	2016/12/13	Test Site	CTR
Test Condition	Band 2 (1.4M) CH18900(1880MHz) –16QAM	Test Range	-20°C ~+50°C

Frequency Stability Under Temperature Variations

Temperature Interval(°C)	Test Frequency (GHz)	Deviation (kHz)	Limit (kHz)
-30	1.88	-0.0094	±4.70
-20	1.88	-0.0064	±4.70
-10	1.88	-0.0077	±4.70
0	1.88	-0.0075	±4.70
10	1.88	-0.0078	±4.70
20	1.88	-0.0098	±4.70
30	1.88	-0.0079	±4.70
40	1.88	-0.0067	±4.70
50	1.88	-0.0074	±4.70

Voltage Variations

AC Voltage (V)	Test Frequency (GHz)	Deviation (kHz)	Limit (kHz)
138	1.88	-0.0124	±4.70
120	1.88	-0.0098	±4.70
102	1.88	-0.0097	±4.70

Product	LTE Router		
Test Mode	Frequency Stability Under Temperature Variations & Voltage Variations		
Date of Test	2016/12/13	Test Site	CTR
Test Condition	Band 2 (3M) CH18900(1880MHz) –QPSK	Test Range	-30°C ~+50°C

Frequency Stability Under Temperature Variations

Temperature Interval(°C)	Test Frequency (GHz)	Deviation (kHz)	Limit (kHz)
-30	1.88	-0.0048	±4.70
-20	1.88	-0.0060	±4.70
-10	1.88	-0.0095	±4.70
0	1.88	-0.0096	±4.70
10	1.88	-0.0065	±4.70
20	1.88	-0.0103	±4.70
30	1.88	-0.0096	±4.70
40	1.88	-0.0116	±4.70
50	1.88	-0.0095	±4.70

Voltage Variations

AC Voltage (V)	Test Frequency (GHz)	Deviation (kHz)	Limit (kHz)
138	1.88	-0.0088	±4.70
120	1.88	-0.0103	±4.70
102	1.88	-0.0090	±4.70

Product	LTE Router		
Test Mode	Frequency Stability Under Temperature Variations & Voltage Variations		
Date of Test	2016/12/13	Test Site	CTR
Test Condition	Band 2 (3M) CH18900(1880MHz) -16QAM	Test Range	-30°C ~+50°C

Frequency Stability Under Temperature Variations

Temperature Interval(°C)	Test Frequency (GHz)	Deviation (kHz)	Limit (kHz)
-30	1.88	0.0055	±4.70
-20	1.88	-0.0054	±4.70
-10	1.88	-0.0068	±4.70
0	1.88	-0.0094	±4.70
10	1.88	-0.0072	±4.70
20	1.88	-0.0115	±4.70
30	1.88	-0.0124	±4.70
40	1.88	-0.0087	±4.70
50	1.88	-0.0081	±4.70

Voltage Variations

AC Voltage (V)	Test Frequency (GHz)	Deviation (kHz)	Limit (kHz)
138	1.88	-0.0085	±4.70
120	1.88	-0.0115	±4.70
102	1.88	-0.0106	±4.70

Product	LTE Router		
Test Mode	Frequency Stability Under Temperature Variations & Voltage Variations		
Date of Test	2016/12/13	Test Site	CTR
Test Condition	Band 2 (5M) CH18900(1880MHz) –QPSK	Test Range	-20°C ~+50°C

Frequency Stability Under Temperature Variations

Temperature Interval(°C)	Test Frequency (GHz)	Deviation (KHz)	Limit (KHz)
-30	1.88	-0.0084	±4.70
-20	1.88	-0.0078	±4.70
-10	1.88	-0.0076	±4.70
0	1.88	-0.0092	±4.70
10	1.88	-0.0079	±4.70
20	1.88	-0.0086	±4.70
30	1.88	-0.0094	±4.70
40	1.88	-0.0069	±4.70
50	1.88	-0.0084	±4.70

Voltage Variations

AC Voltage (V)	Test Frequency (GHz)	Deviation (Hz)	Limit (KHz)
138	1.88	-0.0062	±4.70
120	1.88	-0.0086	±4.70
102	1.88	-0.0070	±4.70

Product	LTE Router		
Test Mode	Frequency Stability Under Temperature Variations & Voltage Variations		
Date of Test	2016/12/13	Test Site	CTR
Test Condition	Band 2 (5M) CH18900(1880MHz) –16QAM	Test Range	-20°C ~+50°C

Frequency Stability Under Temperature Variations

Temperature Interval(°C)	Test Frequency (GHz)	Deviation (KHz)	Limit (KHz)
-30	1.88	-0.0065	±4.70
-20	1.88	-0.0049	±4.70
-10	1.88	0.0054	±4.70
0	1.88	-0.0092	±4.70
10	1.88	-0.0074	±4.70
20	1.88	-0.0102	±4.70
30	1.88	-0.0096	±4.70
40	1.88	-0.0064	±4.70
50	1.88	-0.0074	±4.70

Voltage Variations

AC Voltage (V)	Test Frequency (GHz)	Deviation (Hz)	Limit (KHz)
138	1.88	-0.0111	±4.70
120	1.88	-0.0102	±4.70
102	1.88	-0.0075	±4.70

Product	LTE Router		
Test Mode	Frequency Stability Under Temperature Variations & Voltage Variations		
Date of Test	2016/12/13	Test Site	CTR
Test Condition	Band 2 (10M) CH18900(1880MHz) -QPSK	Test Range	-30°C ~+50°C

Frequency Stability Under Temperature Variations

Temperature Interval(°C)	Test Frequency (GHz)	Deviation (KHz)	Limit (KHz)
-30	1.88	-0.0071	±4.70
-20	1.88	-0.0062	±4.70
-10	1.88	0.0060	±4.70
0	1.88	-0.0062	±4.70
10	1.88	-0.0090	±4.70
20	1.88	-0.0097	±4.70
30	1.88	-0.0081	±4.70
40	1.88	-0.0076	±4.70
50	1.88	-0.0054	±4.70

Voltage Variations

AC Voltage (V)	Test Frequency (GHz)	Deviation (KHz)	Limit (KHz)
138	1.88	-0.0098	±4.70
120	1.88	-0.0097	±4.70
102	1.88	-0.0104	±4.70

Product	LTE Router		
Test Mode	Frequency Stability Under Temperature Variations & Voltage Variations		
Date of Test	2016/12/13	Test Site	CTR
Test Condition	Band 2 (10M) CH18900(1880MHz) -16QAM	Test Range	-30°C ~+50°C

Frequency Stability Under Temperature Variations

Temperature Interval(°C)	Test Frequency (GHz)	Deviation (KHz)	Limit (KHz)
-30	1.88	-0.0083	±4.70
-20	1.88	-0.0091	±4.70
-10	1.88	-0.0071	±4.70
0	1.88	-0.0055	±4.70
10	1.88	-0.0061	±4.70
20	1.88	-0.0084	±4.70
30	1.88	-0.0091	±4.70
40	1.88	-0.0101	±4.70
50	1.88	-0.0083	±4.70

Voltage Variations

AC Voltage (V)	Test Frequency (GHz)	Deviation (KHz)	Limit (KHz)
138	1.88	-0.0058	±4.70
120	1.88	-0.0084	±4.70
102	1.88	-0.0053	±4.70

Product	LTE Router		
Test Mode	Frequency Stability Under Temperature Variations & Voltage Variations		
Date of Test	2016/12/13	Test Site	CTR
Test Condition	Band 2 (15M) CH18900(1880MHz) -QPSK	Test Range	-30°C ~+50°C

Frequency Stability Under Temperature Variations

Temperature Interval(°C)	Test Frequency (GHz)	Deviation (KHz)	Limit (KHz)
-30	1.88	-0.0075	±4.70
-20	1.88	-0.0077	±4.70
-10	1.88	-0.0072	±4.70
0	1.88	-0.0067	±4.70
10	1.88	-0.0075	±4.70
20	1.88	-0.0078	±4.70
30	1.88	-0.0092	±4.70
40	1.88	-0.0082	±4.70
50	1.88	-0.0119	±4.70

Voltage Variations

AC Voltage (V)	Test Frequency (GHz)	Deviation (KHz)	Limit (KHz)
138	1.88	-0.0108	±4.70
120	1.88	-0.0078	±4.70
102	1.88	-0.0083	±4.70

Product	LTE Router		
Test Mode	Frequency Stability Under Temperature Variations & Voltage Variations		
Date of Test	2016/12/13	Test Site	CTR
Test Condition	Band 2 (15M) CH18900(1880MHz) -16QAM	Test Range	-30°C ~+50°C

Frequency Stability Under Temperature Variations

Temperature Interval(°C)	Test Frequency (GHz)	Deviation (KHz)	Limit (KHz)
-30	1.88	-0.0072	±4.70
-20	1.88	-0.0091	±4.70
-10	1.88	-0.0083	±4.70
0	1.88	-0.0127	±4.70
10	1.88	-0.0063	±4.70
20	1.88	-0.0081	±4.70
30	1.88	-0.0085	±4.70
40	1.88	-0.0081	±4.70
50	1.88	-0.0050	±4.70

Voltage Variations

AC Voltage (V)	Test Frequency (GHz)	Deviation (KHz)	Limit (KHz)
138	1.88	-0.0113	±4.70
120	1.88	-0.0081	±4.70
102	1.88	-0.0085	±4.70

Product	LTE Router		
Test Mode	Frequency Stability Under Temperature Variations & Voltage Variations		
Date of Test	2016/12/13	Test Site	CTR
Test Condition	Band 2 (20M) CH18900(1880MHz) -QPSK	Test Range	-30°C ~+50°C

Frequency Stability Under Temperature Variations

Temperature Interval(°C)	Test Frequency (GHz)	Deviation (KHz)	Limit (KHz)
-30	1.88	-0.0054	±4.70
-20	1.88	-0.0074	±4.70
-10	1.88	-0.0054	±4.70
0	1.88	-0.0062	±4.70
10	1.88	-0.0061	±4.70
20	1.88	-0.0094	±4.70
30	1.88	-0.0124	±4.70
40	1.88	-0.0065	±4.70
50	1.88	-0.0052	±4.70

Voltage Variations

AC Voltage (V)	Test Frequency (GHz)	Deviation (KHz)	Limit (KHz)
138	1.88	-0.0102	±4.70
120	1.88	-0.0094	±4.70
102	1.88	-0.0088	±4.70

Product	LTE Router		
Test Mode	Frequency Stability Under Temperature Variations & Voltage Variations		
Date of Test	2016/12/13	Test Site	CTR
Test Condition	Band 2 (20M) CH18900(1880MHz) -16QAM	Test Range	-30°C ~+50°C

Frequency Stability Under Temperature Variations

Temperature Interval(°C)	Test Frequency (GHz)	Deviation (KHz)	Limit (KHz)
-30	1.88	-0.0075	±4.70
-20	1.88	-0.0077	±4.70
-10	1.88	-0.0072	±4.70
0	1.88	-0.0113	±4.70
10	1.88	-0.0059	±4.70
20	1.88	-0.0060	±4.70
30	1.88	-0.0068	±4.70
40	1.88	-0.0084	±4.70
50	1.88	-0.0078	±4.70

Voltage Variations

AC Voltage (V)	Test Frequency (GHz)	Deviation (KHz)	Limit (KHz)
138	1.88	-0.0068	±4.70
120	1.88	-0.0060	±4.70
102	1.88	-0.0063	±4.70

Product	LTE Router		
Test Mode	Frequency Stability Under Temperature Variations & Voltage Variations		
Date of Test	2016/12/13	Test Site	CTR
Test Condition	Band 4 (1.4M) CH20175(1732.5MHz) –QPSK	Test Range	-20°C ~+50°C

Frequency Stability Under Temperature Variations

Temperature Interval(°C)	Test Frequency (GHz)	Deviation (kHz)	Limit (kHz)
-30	1.73	0.0087	±4.33
-20	1.73	0.0082	±4.33
-10	1.73	-0.0065	±4.33
0	1.73	0.0104	±4.33
10	1.73	0.0069	±4.33
20	1.73	-0.0061	±4.33
30	1.73	-0.0073	±4.33
40	1.73	0.0076	±4.33
50	1.73	0.0093	±4.33

Voltage Variations

AC Voltage (V)	Test Frequency (GHz)	Deviation (kHz)	Limit (kHz)
138	1.73	-0.0075	±4.33
120	1.73	-0.0061	±4.33
102	1.73	-0.0069	±4.33

Product	LTE Router		
Test Mode	Frequency Stability Under Temperature Variations & Voltage Variations		
Date of Test	2016/12/13	Test Site	CTR
Test Condition	Band 4 (1.4M) CH20175(1732.5MHz) –16QAM	Test Range	-20°C ~+50°C

Frequency Stability Under Temperature Variations

Temperature Interval(°C)	Test Frequency (GHz)	Deviation (kHz)	Limit (kHz)
-30	1.73	0.0055	±4.33
-20	1.73	0.0068	±4.33
-10	1.73	0.0082	±4.33
0	1.73	-0.0096	±4.33
10	1.73	0.0052	±4.33
20	1.73	0.0063	±4.33
30	1.73	-0.0095	±4.33
40	1.73	0.0072	±4.33
50	1.73	0.0061	±4.33

Voltage Variations

AC Voltage (V)	Test Frequency (GHz)	Deviation (kHz)	Limit (kHz)
138	1.73	-0.0080	±4.33
120	1.73	0.0063	±4.33
102	1.73	0.0099	±4.33

Product	LTE Router		
Test Mode	Frequency Stability Under Temperature Variations & Voltage Variations		
Date of Test	2016/12/13	Test Site	CTR
Test Condition	Band 4 (3M) CH20175(1732.5MHz) –QPSK	Test Range	-30°C ~+50°C

Frequency Stability Under Temperature Variations

Temperature Interval(°C)	Test Frequency (GHz)	Deviation (kHz)	Limit (kHz)
-30	1.73	0.0094	±4.33
-20	1.73	-0.0072	±4.33
-10	1.73	0.0066	±4.33
0	1.73	0.0070	±4.33
10	1.73	-0.0067	±4.33
20	1.73	0.0066	±4.33
30	1.73	0.0064	±4.33
40	1.73	-0.0074	±4.33
50	1.73	0.0086	±4.33

Voltage Variations

AC Voltage (V)	Test Frequency (GHz)	Deviation (kHz)	Limit (kHz)
138	1.73	0.0102	±4.33
120	1.73	0.0066	±4.33
102	1.73	0.0107	±4.33

Product	LTE Router		
Test Mode	Frequency Stability Under Temperature Variations & Voltage Variations		
Date of Test	2016/12/13	Test Site	CTR
Test Condition	Band 4 (3M) CH20175(1732.5MHz) –16QAM	Test Range	-30°C ~+50°C

Frequency Stability Under Temperature Variations

Temperature Interval(°C)	Test Frequency (GHz)	Deviation (kHz)	Limit (kHz)
-30	1.73	0.0088	±4.33
-20	1.73	-0.0086	±4.33
-10	1.73	0.0055	±4.33
0	1.73	0.0062	±4.33
10	1.73	0.0080	±4.33
20	1.73	0.0070	±4.33
30	1.73	0.0078	±4.33
40	1.73	0.0052	±4.33
50	1.73	0.0088	±4.33

Voltage Variations

AC Voltage (V)	Test Frequency (GHz)	Deviation (kHz)	Limit (kHz)
138	1.73	0.0107	±4.33
120	1.73	0.0070	±4.33
102	1.73	-0.0089	±4.33

Product	LTE Router		
Test Mode	Frequency Stability Under Temperature Variations & Voltage Variations		
Date of Test	2016/12/13	Test Site	CTR
Test Condition	Band 4 (5M) CH20175(1732.5MHz) –QPSK	Test Range	-20°C ~+50°C

Frequency Stability Under Temperature Variations

Temperature Interval(°C)	Test Frequency (GHz)	Deviation (KHz)	Limit (KHz)
-30	1.73	0.0069	±4.33
-20	1.73	0.0050	±4.33
-10	1.73	0.0064	±4.33
0	1.73	0.0106	±4.33
10	1.73	0.0102	±4.33
20	1.73	0.0100	±4.33
30	1.73	-0.0081	±4.33
40	1.73	-0.0056	±4.33
50	1.73	0.0060	±4.33

Voltage Variations

AC Voltage (V)	Test Frequency (GHz)	Deviation (Hz)	Limit (KHz)
138	1.73	0.0063	±4.33
120	1.73	0.0100	±4.33
102	1.73	0.0084	±4.33

Product	LTE Router		
Test Mode	Frequency Stability Under Temperature Variations & Voltage Variations		
Date of Test	2016/12/13	Test Site	CTR
Test Condition	Band 4 (5M) CH20175(1732.5MHz) –16QAM	Test Range	-20°C ~+50°C

Frequency Stability Under Temperature Variations

Temperature Interval(°C)	Test Frequency (GHz)	Deviation (KHz)	Limit (KHz)
-30	1.73	0.0058	±4.33
-20	1.73	0.0059	±4.33
-10	1.73	0.0048	±4.33
0	1.73	-0.0064	±4.33
10	1.73	-0.0073	±4.33
20	1.73	-0.0066	±4.33
30	1.73	0.0081	±4.33
40	1.73	0.0060	±4.33
50	1.73	0.0068	±4.33

Voltage Variations

AC Voltage (V)	Test Frequency (GHz)	Deviation (Hz)	Limit (KHz)
138	1.73	0.0064	±4.33
120	1.73	-0.0066	±4.33
102	1.73	-0.0056	±4.33

Product	LTE Router		
Test Mode	Frequency Stability Under Temperature Variations & Voltage Variations		
Date of Test	2016/12/13	Test Site	CTR
Test Condition	Band 4 (10M) CH20175(1732.5MHz)-QPSK	Test Range	-30°C ~+50°C

Frequency Stability Under Temperature Variations

Temperature Interval(°C)	Test Frequency (GHz)	Deviation (KHz)	Limit (KHz)
-30	1.73	-0.0066	±4.33
-20	1.73	0.0091	±4.33
-10	1.73	0.0072	±4.33
0	1.73	0.0059	±4.33
10	1.73	0.0050	±4.33
20	1.73	0.0082	±4.33
30	1.73	0.0059	±4.33
40	1.73	0.0048	±4.33
50	1.73	0.0087	±4.33

Voltage Variations

AC Voltage (V)	Test Frequency (GHz)	Deviation (KHz)	Limit (KHz)
138	1.73	-0.0085	±4.33
120	1.73	0.0082	±4.33
102	1.73	0.0074	±4.33

Product	LTE Router		
Test Mode	Frequency Stability Under Temperature Variations & Voltage Variations		
Date of Test	2016/12/13	Test Site	CTR
Test Condition	Band 4 (10M) CH20175(1732.5MHz)-16QAM	Test Range	-30°C ~+50°C

Frequency Stability Under Temperature Variations

Temperature Interval(°C)	Test Frequency (GHz)	Deviation (KHz)	Limit (KHz)
-30	1.73	0.0050	±4.33
-20	1.73	0.0070	±4.33
-10	1.73	0.0053	±4.33
0	1.73	-0.0040	±4.33
10	1.73	-0.0048	±4.33
20	1.73	-0.0075	±4.33
30	1.73	0.0069	±4.33
40	1.73	0.0081	±4.33
50	1.73	-0.0069	±4.33

Voltage Variations

AC Voltage (V)	Test Frequency (GHz)	Deviation (KHz)	Limit (KHz)
138	1.73	0.0057	±4.33
120	1.73	-0.0075	±4.33
102	1.73	-0.0054	±4.33

Product	LTE Router		
Test Mode	Frequency Stability Under Temperature Variations & Voltage Variations		
Date of Test	2016/12/13	Test Site	CTR
Test Condition	Band 4 (15M) CH20175(1732.5MHz)-QPSK	Test Range	-30°C ~+50°C

Frequency Stability Under Temperature Variations

Temperature Interval(°C)	Test Frequency (GHz)	Deviation (KHz)	Limit (KHz)
-30	1.73	0.0058	±4.33
-20	1.73	0.0083	±4.33
-10	1.73	0.0057	±4.33
0	1.73	0.0054	±4.33
10	1.73	-0.0070	±4.33
20	1.73	0.0066	±4.33
30	1.73	-0.0074	±4.33
40	1.73	0.0077	±4.33
50	1.73	0.0061	±4.33

Voltage Variations

AC Voltage (V)	Test Frequency (GHz)	Deviation (KHz)	Limit (KHz)
138	1.73	0.0072	±4.33
120	1.73	0.0066	±4.33
102	1.73	-0.0079	±4.33

Product	LTE Router		
Test Mode	Frequency Stability Under Temperature Variations & Voltage Variations		
Date of Test	2016/12/13	Test Site	CTR
Test Condition	Band 4 (15M) CH20175(1732.5MHz)-16QAM	Test Range	-30°C ~+50°C

Frequency Stability Under Temperature Variations

Temperature Interval(°C)	Test Frequency (GHz)	Deviation (KHz)	Limit (KHz)
-30	1.73	0.0078	±4.33
-20	1.73	0.0085	±4.33
-10	1.73	-0.0049	±4.33
0	1.73	0.0060	±4.33
10	1.73	0.0096	±4.33
20	1.73	0.0086	±4.33
30	1.73	0.0052	±4.33
40	1.73	-0.0058	±4.33
50	1.73	0.0074	±4.33

Voltage Variations

AC Voltage (V)	Test Frequency (GHz)	Deviation (KHz)	Limit (KHz)
138	1.73	0.0070	±4.33
120	1.73	0.0086	±4.33
102	1.73	0.0054	±4.33

Product	LTE Router		
Test Mode	Frequency Stability Under Temperature Variations & Voltage Variations		
Date of Test	2016/12/13	Test Site	CTR
Test Condition	Band 4 (20M) CH20175(1732.5MHz)-QPSK	Test Range	-30°C ~+50°C

Frequency Stability Under Temperature Variations

Temperature Interval(°C)	Test Frequency (GHz)	Deviation (KHz)	Limit (KHz)
-30	1.73	0.0057	±4.33
-20	1.73	0.0052	±4.33
-10	1.73	0.0059	±4.33
0	1.73	0.0062	±4.33
10	1.73	0.0062	±4.33
20	1.73	0.0065	±4.33
30	1.73	0.0050	±4.33
40	1.73	-0.0051	±4.33
50	1.73	-0.0057	±4.33

Voltage Variations

AC Voltage (V)	Test Frequency (GHz)	Deviation (KHz)	Limit (KHz)
138	1.73	0.0053	±4.33
120	1.73	0.0065	±4.33
102	1.73	-0.0049	±4.33

Product	LTE Router		
Test Mode	Frequency Stability Under Temperature Variations & Voltage Variations		
Date of Test	2016/12/13	Test Site	CTR
Test Condition	Band 4 (20M) CH20175(1732.5MHz)-16QAM	Test Range	-30°C ~+50°C

Frequency Stability Under Temperature Variations

Temperature Interval(°C)	Test Frequency (GHz)	Deviation (KHz)	Limit (KHz)
-30	1.73	0.0100	±4.33
-20	1.73	-0.0059	±4.33
-10	1.73	-0.0056	±4.33
0	1.73	0.0061	±4.33
10	1.73	0.0073	±4.33
20	1.73	0.0057	±4.33
30	1.73	0.0041	±4.33
40	1.73	0.0069	±4.33
50	1.73	0.0067	±4.33

Voltage Variations

AC Voltage (V)	Test Frequency (GHz)	Deviation (KHz)	Limit (KHz)
138	1.73	-0.0061	±4.33
120	1.73	0.0057	±4.33
102	1.73	-0.0049	±4.33

8. Peak to Average Ratio

8.1 Test Specification

According to Part 27.50(a).

8.2 Test Setup

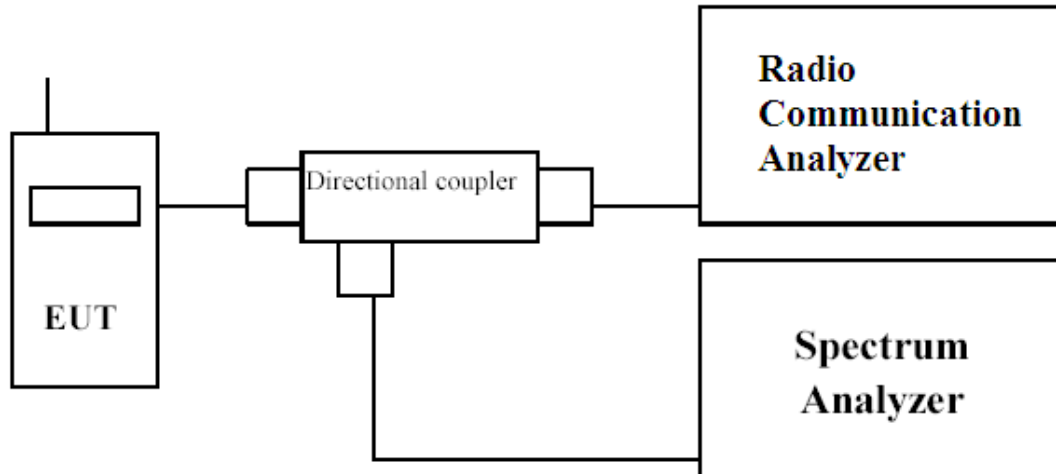

8.3 Limits

The peak-to-average power ratio (PAPR) of the transmitter output power must not exceed 13 dB. The PAPR measurements should be made using either an instrument with complementary cumulative distribution function (CCDF) capabilities to determine that PAPR will not exceed 13 dB for more than 0.1 percent of the time or other Commission approved procedure.

8.4 Test Procedure

- a) Refer to instrument's analyzer instruction manual for details on how to use the power statistics/CCDF function;
- b) Set resolution/measurement bandwidth \geq signal's occupied bandwidth;
- c) Set the number of counts to a value that stabilizes the measured CCDF curve;
- d) Set the measurement interval as follows:
 - 1) for continuous transmissions, set to 1 ms,
 - 2) for burst transmissions, employ an external trigger that is synchronized with the EUT burst timing sequence, or use the internal burst trigger with a trigger level that allows the burst to stabilize and set the measurement interval to a time that is less than or equal to the burst duration.
- e) Record the maximum PAPR level associated with a probability of 0.1%.

8.5 Test Result of Spurious Emission

Product	LTE Router		
Test Mode	Peak to Average Ratio		
Date of Test	2016/12/13	Test Site	CTR
Test Condition	LTE-Band 2		

Band 2 (1.4M) QPSK

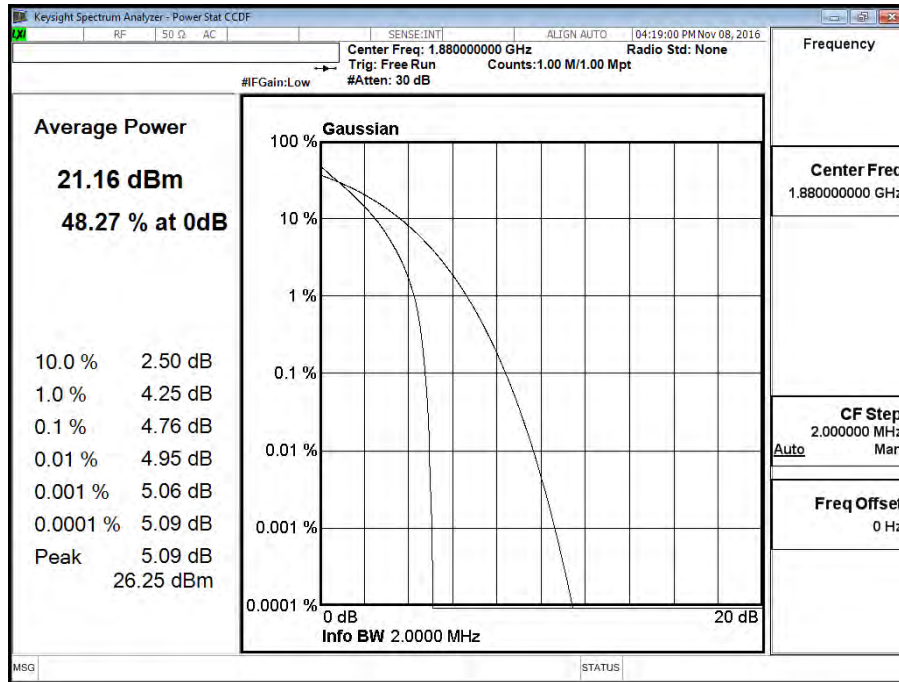

Band 2 (3M) QPSK

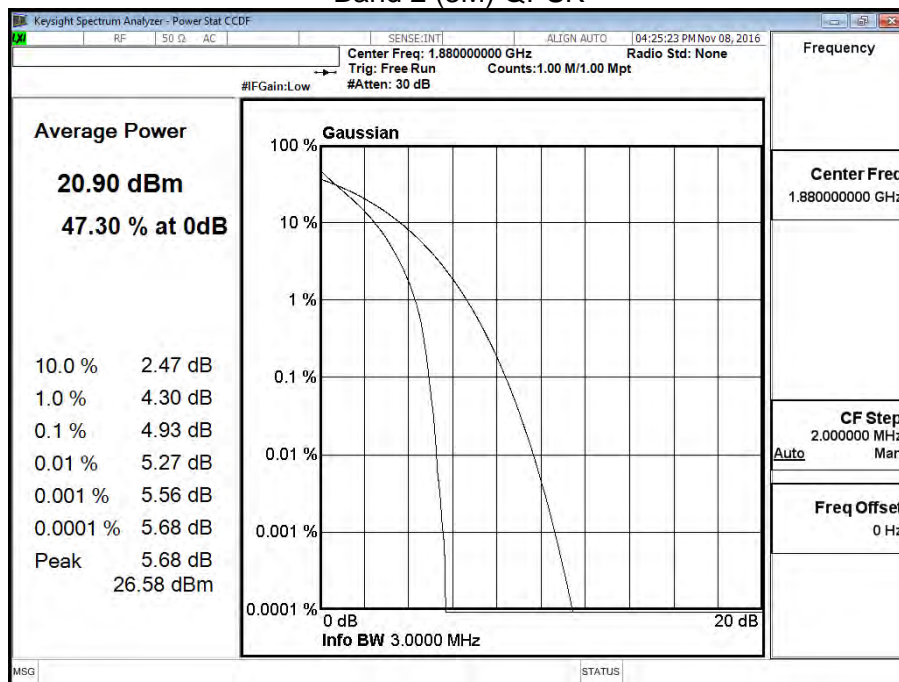

Band 2 (5M) QPSK

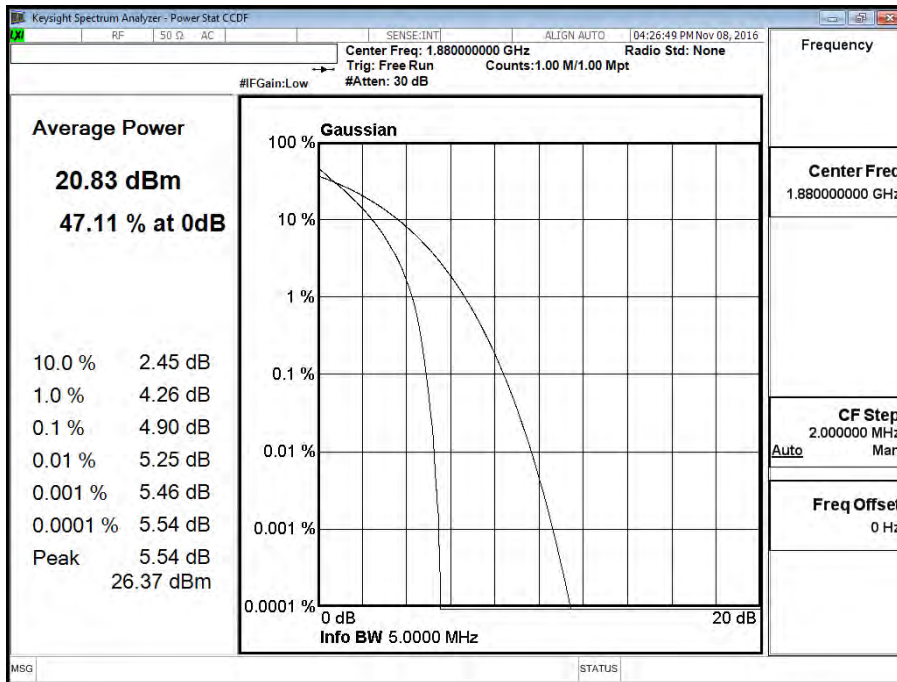

Band 2 (10M) QPSK

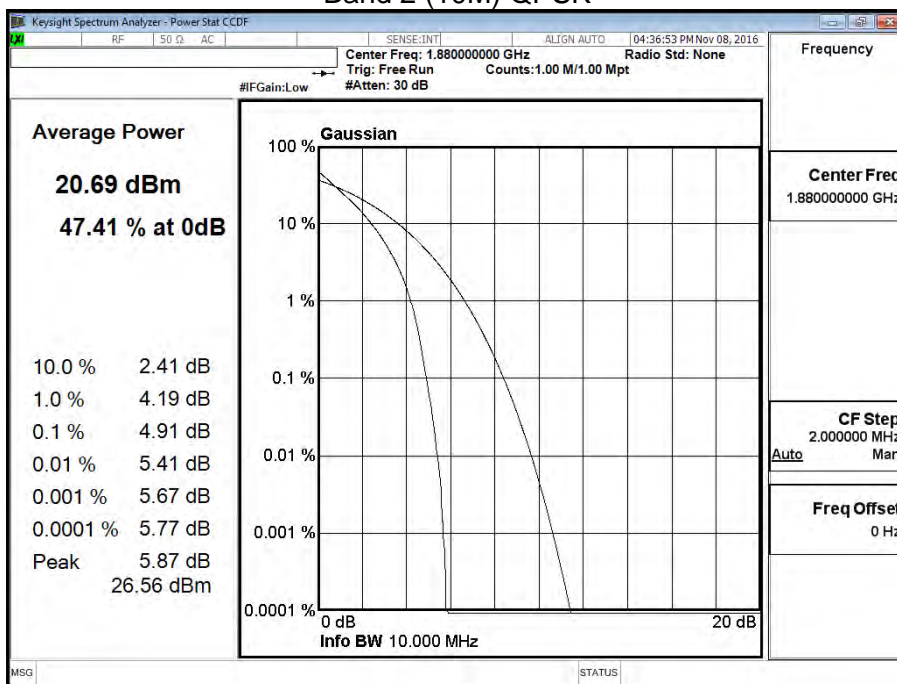

Band 2 (15M) QPSK

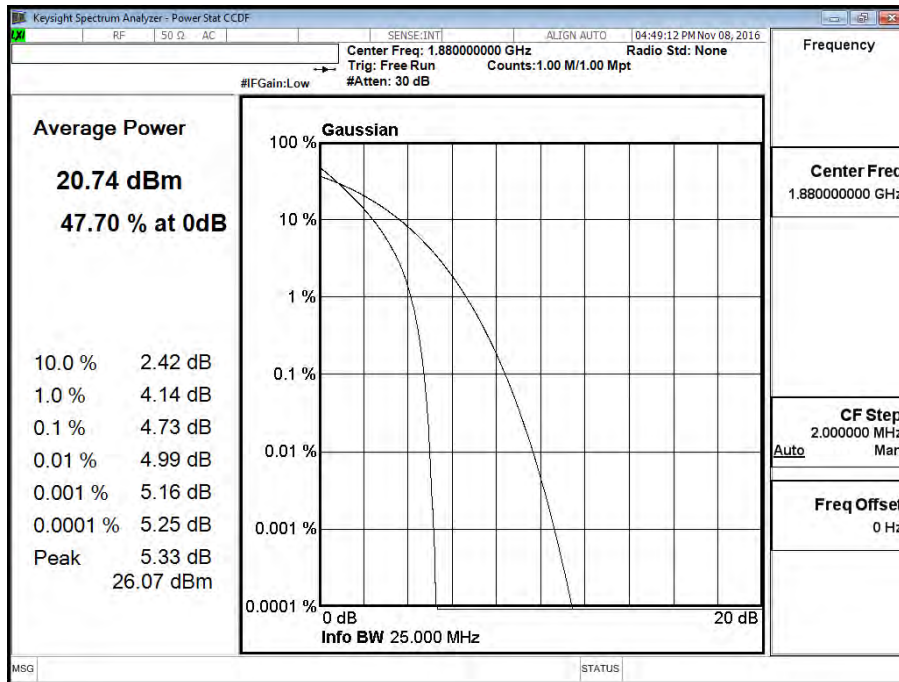

Band 2 (20M) QPSK

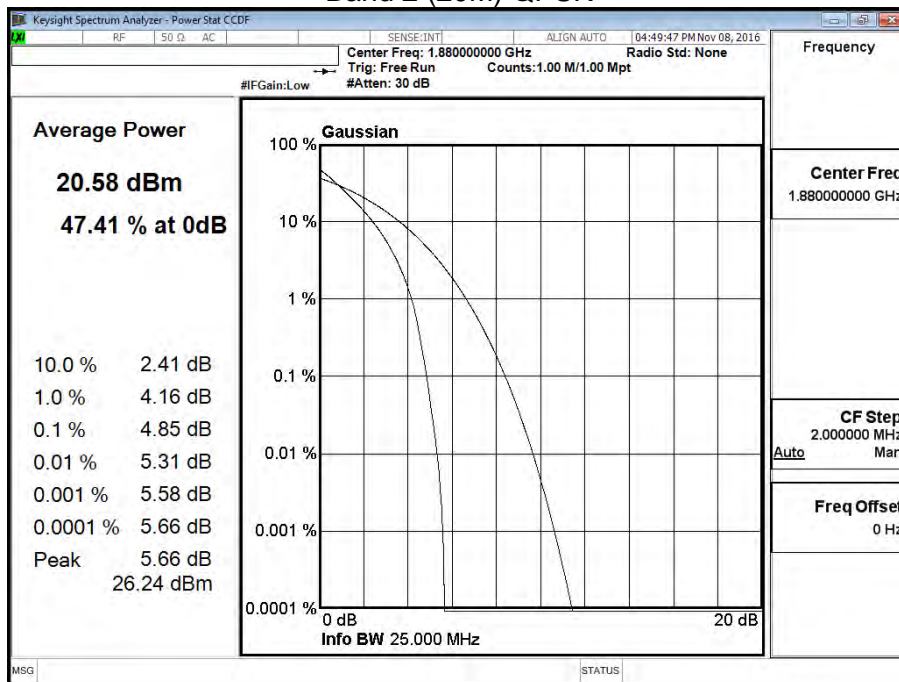

Band 2 (1.4M) 16QAM

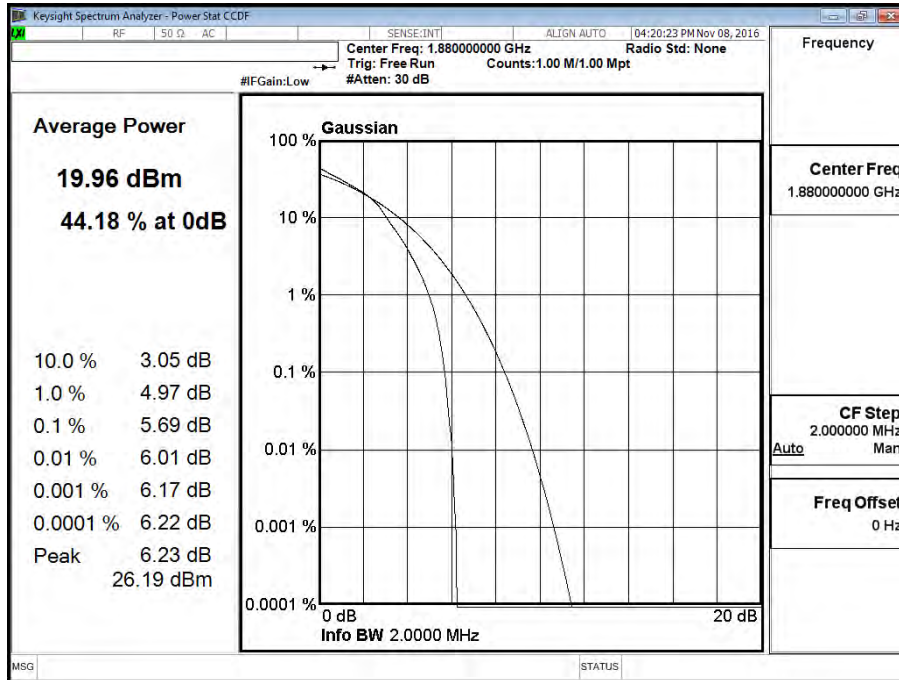

Band 2 (3M) 16QAM

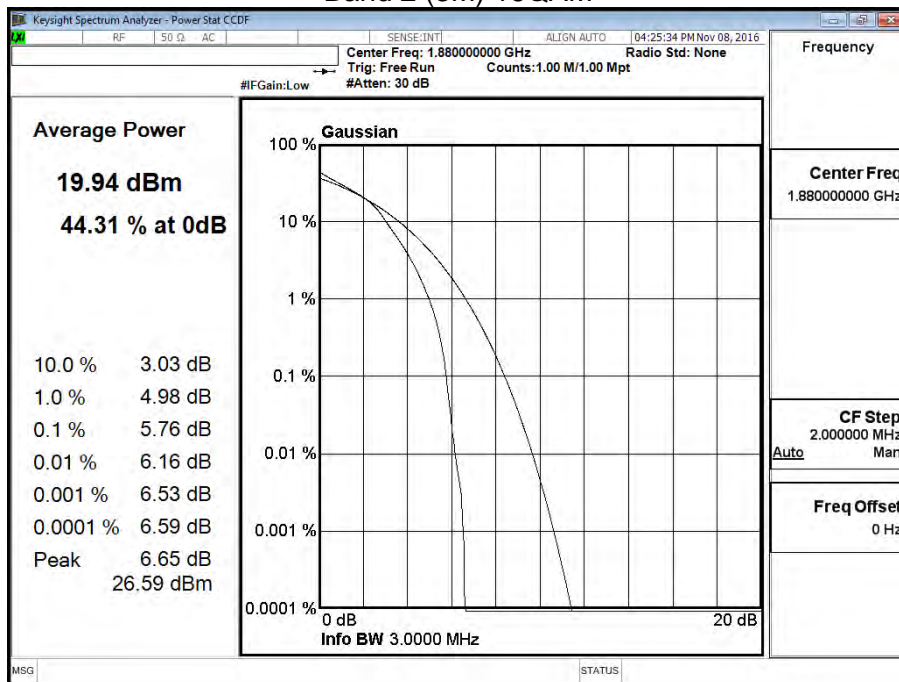

Band 2 (5M) 16QAM

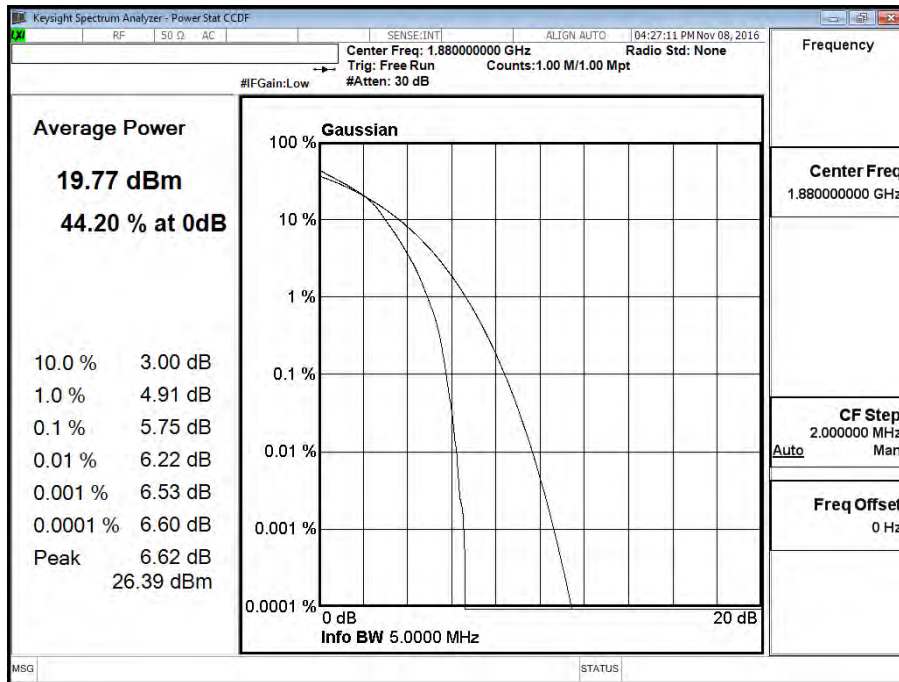

Band 2 (10M) 16QAM

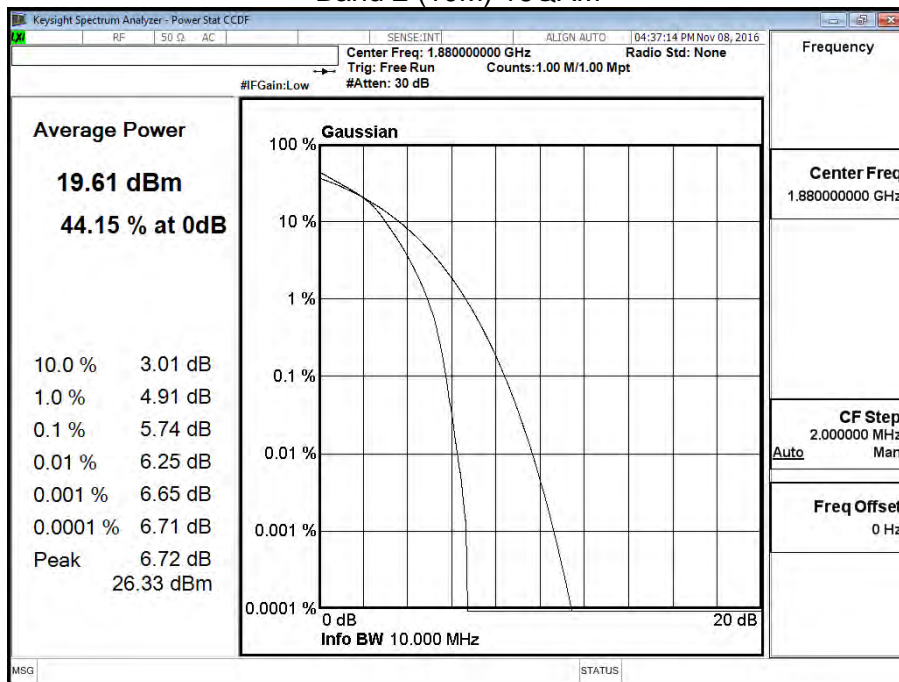

Band 2 (15M) 16QAM

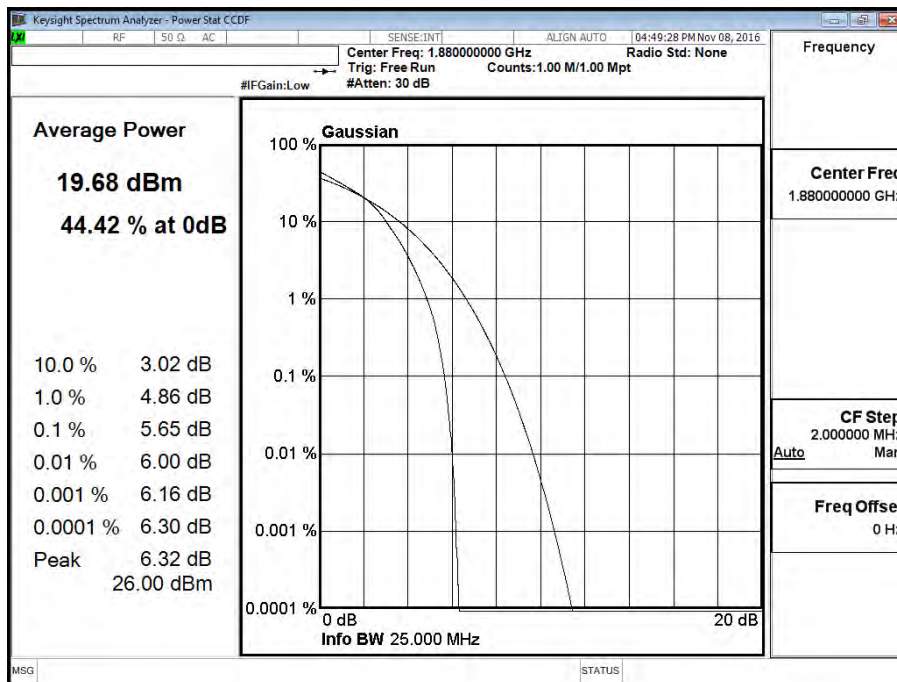

Band 2 (20M) 16QAM

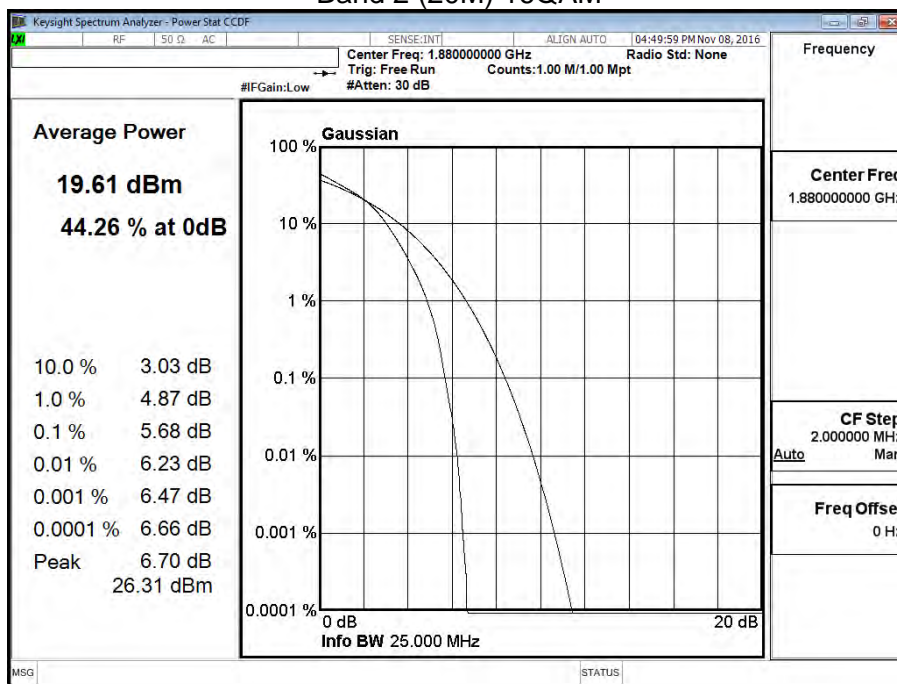

Product	LTE Router		
Test Mode	Peak to Average Ratio		
Date of Test	2016/12/13	Test Site	CTR
Test Condition	LTE-Band 4		

Band 4 (1.4M) QPSK

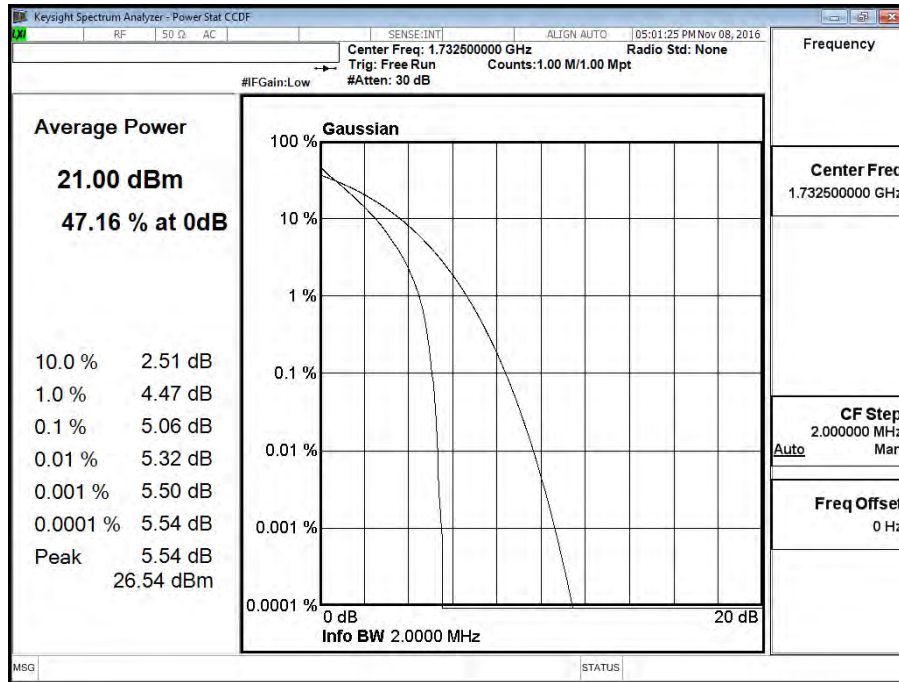

Band 4 (3M) QPSK

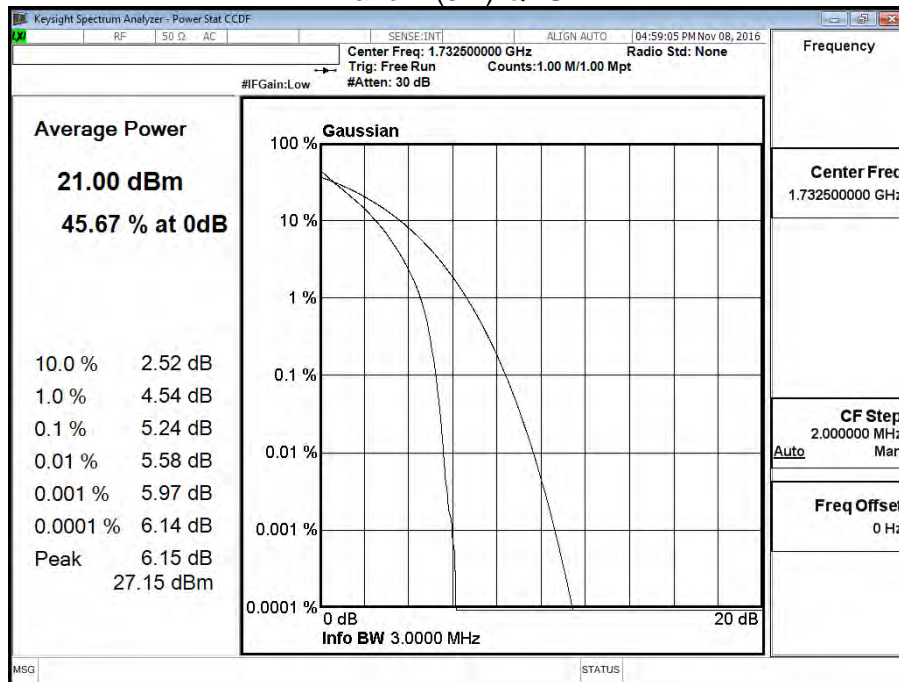

Band 4 (5M) QPSK

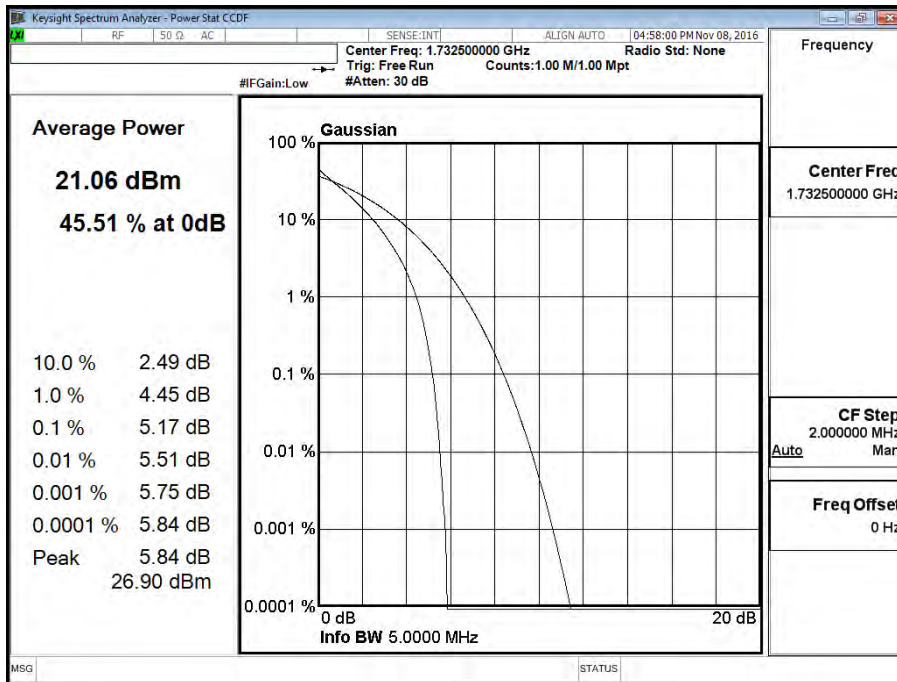

Band 4 (10M) QPSK

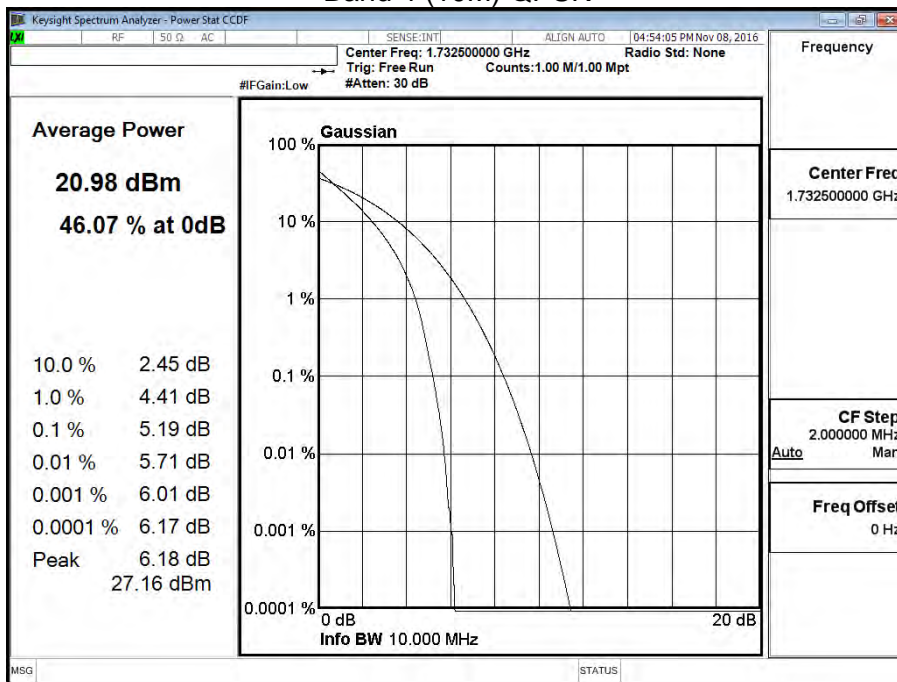

Band 4 (15M) QPSK

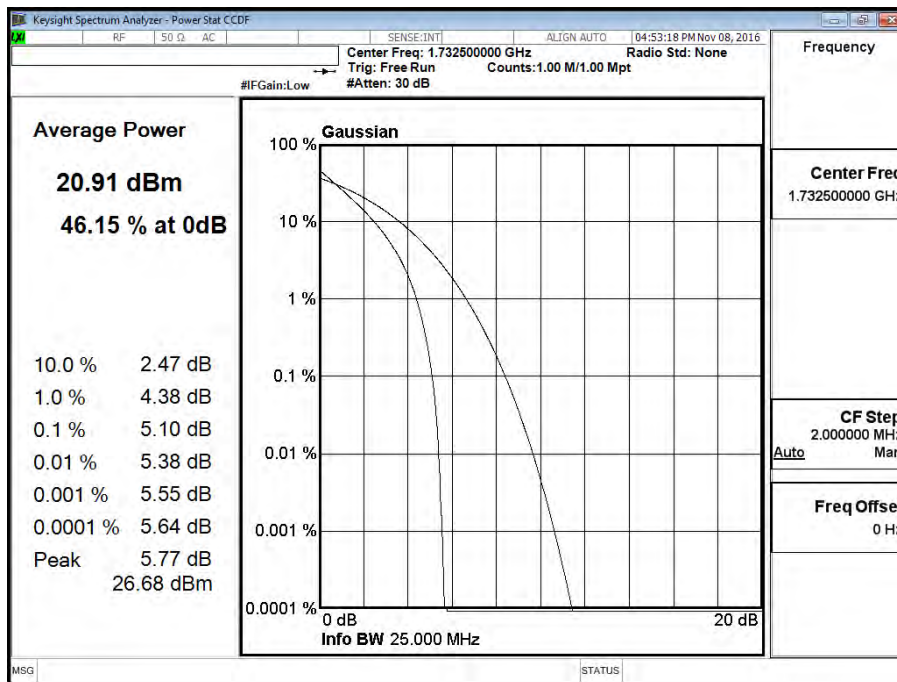

Band 4 (20M) QPSK

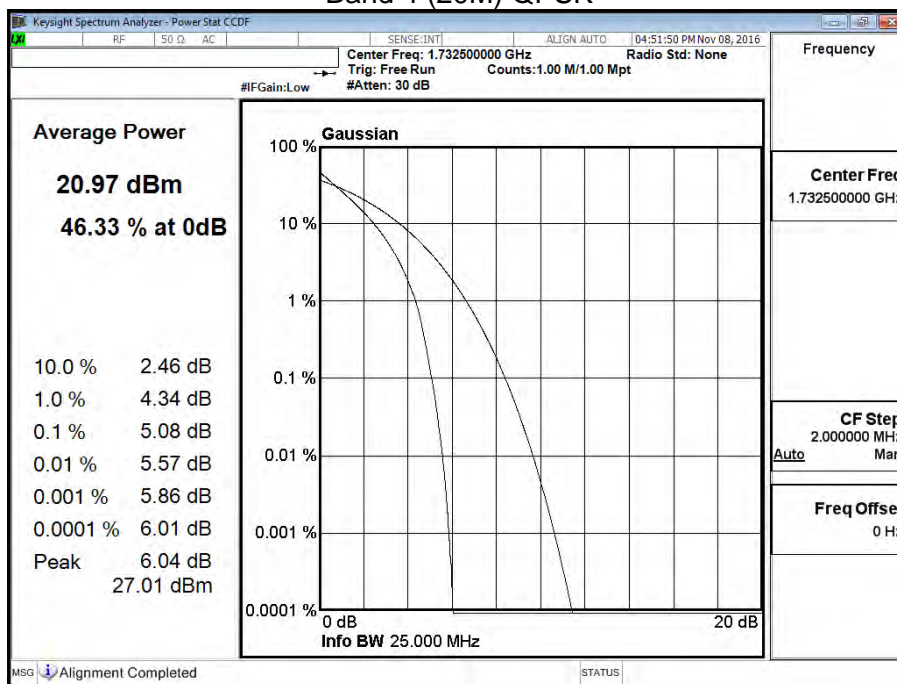

Band 4 (1.4M) 16QAM

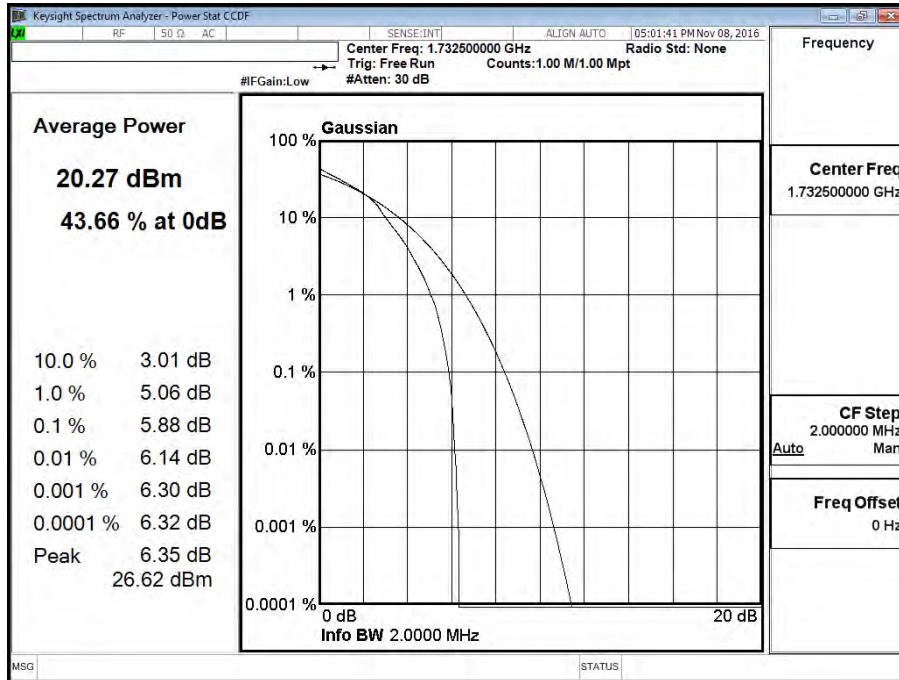

Band 4 (3M) 16QAM

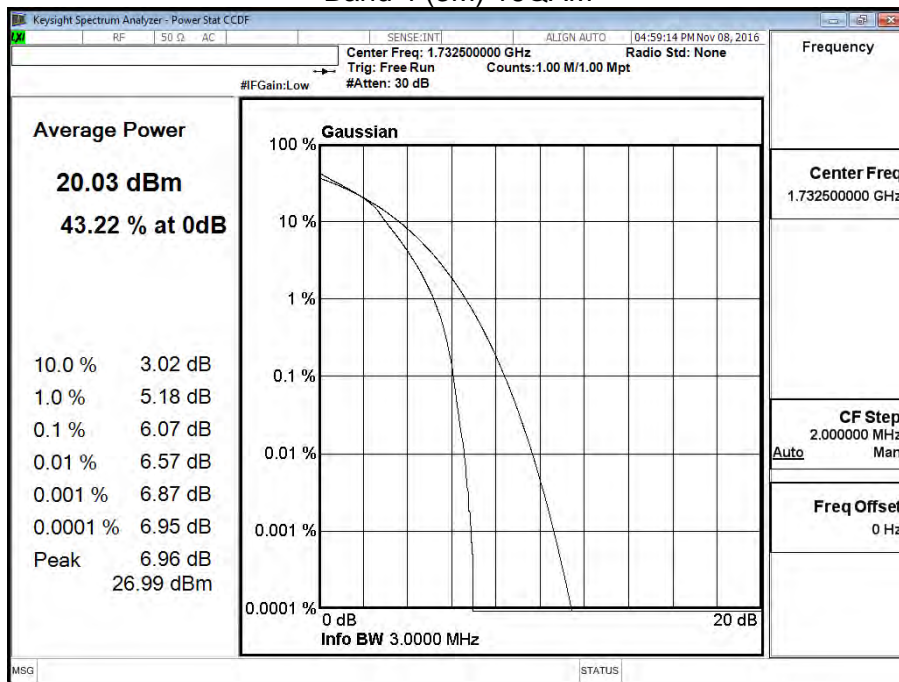

Band 4 (5M) 16QAM

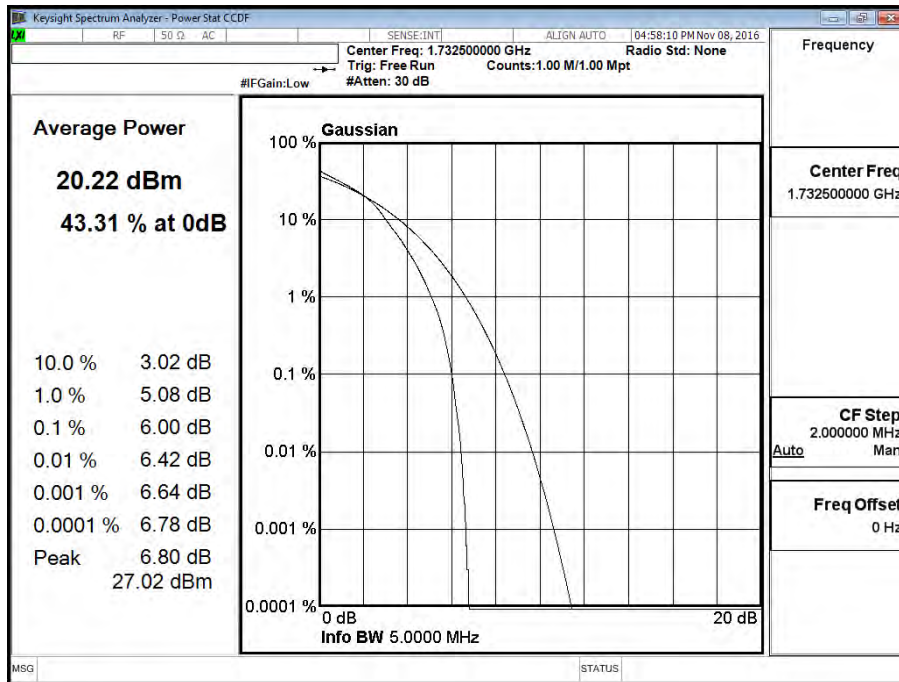

Band 4 (10M) 16QAM

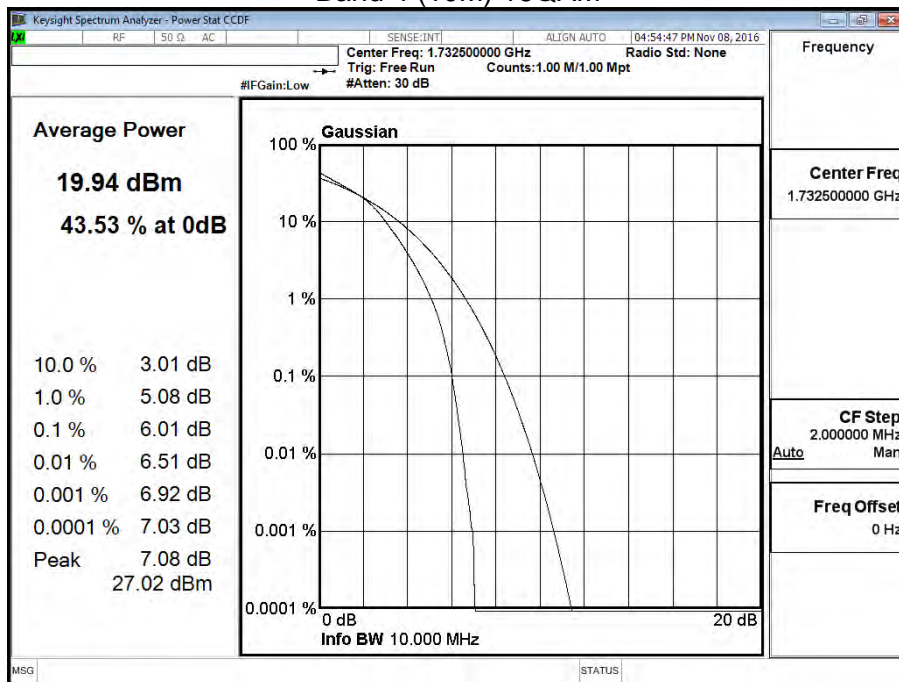

Band 4 (15M) 16QAM

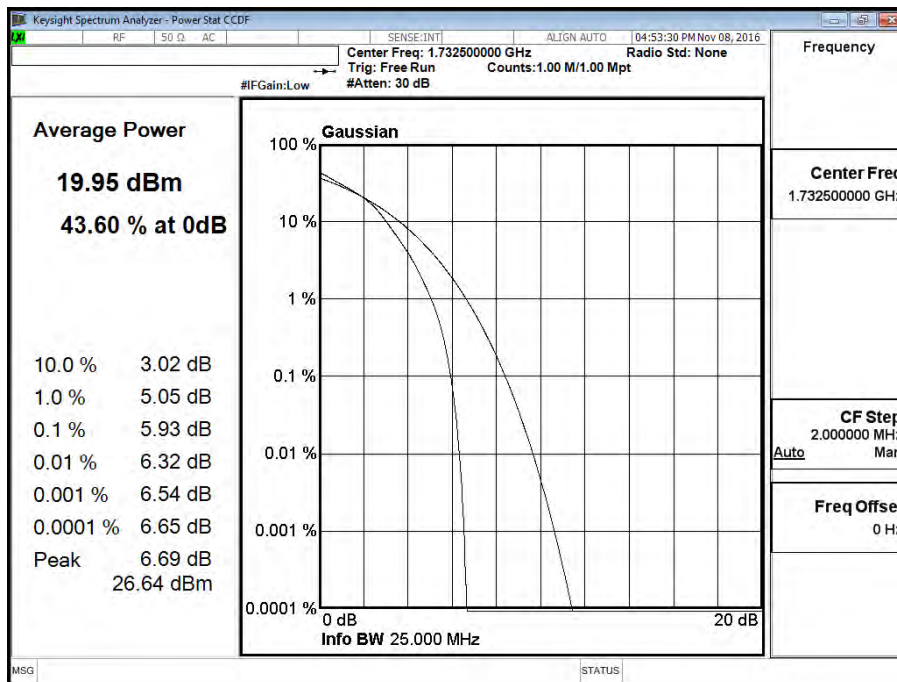

Band 4 (20M) 16QAM

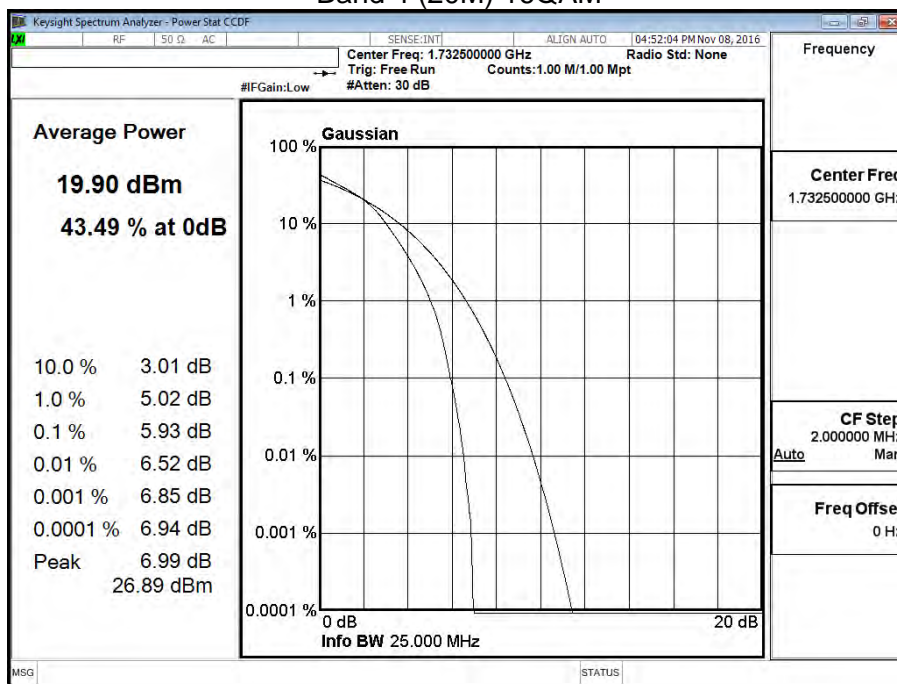

Attachment 1: EUT Test Photographs

Attachment 2: EUT Detailed Photographs