

TEST REPORT

CERTIFICATE OF CONFORMITY

Standard: 47 CFR FCC Part 22
47 CFR FCC Part 24
47 CFR FCC Part 27
47 CFR FCC Part 2

Report No.: RFBCKS-WTW-P23070373

FCC ID: NKR-VMC-9628NV1

Product: 2G/3G/4G Module

Brand: WNC

Model No.: 48VMC28UT1

Received Date: 2023/7/17

Test Date: 2023/7/24 ~ 2023/8/1

Issued Date: 2023/9/28

Applicant: Wistron NeWeb Corporation

Address: 20 Park Ave. II, Hsinchu Science Park, Hsinchu 308, Taiwan

Issued By: Bureau Veritas Consumer Products Services (H.K.) Ltd., Taoyuan Branch
Lin Kou Laboratories

Lab Address: No. 47-2, 14th Ling, Chia Pau Vil., Lin Kou Dist., New Taipei City, Taiwan

Test Location (1): No. 19, Hwa Ya 2nd Rd., Wen Hwa Vil., Kwei Shan Dist., Taoyuan City 33383, TAIWAN

FCC Registration / 788550 / TW0003

Designation Number:

Test Location (2): No. 70, Wenming Rd., Guishan Dist., Taoyuan City 333, Taiwan (R.O.C.)

FCC Registration / 281270 / TW0032

Designation Number:

Approved by: _____

Jeremy Lin

Date: _____

2023/9/28

Jeremy Lin / Project Engineer

This test report consists of 372 pages in total. It may be duplicated completely for legal use with the approval of the applicant. It should not be reproduced except in full, without the written approval of our laboratory. The test results in the report only apply to the tested sample. The test results in this report are traceable to the national or international standards.



Prepared by : Vera Huang / Specialist

This report is governed by, and incorporates by reference, the Conditions of Testing as posted at the date of issuance of this report at <http://www.bureauveritas.com/home/about-us/our-business/cps/about-us/terms-conditions/> and is intended for your exclusive use. Any copying or replication of this report to or for any other person or entity, or use of our name or trademark, is permitted only with our prior written permission. This report sets forth our findings solely with respect to the test samples identified herein. The results set forth in this report are not indicative or representative of the quality or characteristics of the lot from which a test sample was taken or any similar or identical product unless specifically and expressly noted. Our report includes all of the tests requested by you and the results thereof based upon the information that you provided to us. Measurement uncertainty is only provided upon request for accredited tests. Statements of conformity are based on simple acceptance criteria without taking measurement uncertainty into account, unless otherwise requested in writing. You have 60 days from date of issuance of this report to notify us of any material error or omission caused by our negligence or if you require measurement uncertainty; provided, however, that such notice shall be in writing and shall specifically address the issue you wish to raise. A failure to raise such issue within the prescribed time shall constitute your unqualified acceptance of the completeness of this report, the tests conducted and the correctness of the report contents.

Table of Contents

Release Control Record	5
1 Certificate	6
2 Summary of Test Results	7
2.1 Measurement Uncertainty	8
2.2 Supplementary Information	8
3 General Information	9
3.1 General Description of EUT	9
3.2 Antenna Description of EUT	12
3.3 Test Mode Applicability and Tested Channel Detail	13
3.4 Test Program Used and Operation Descriptions	29
3.5 Connection Diagram of EUT and Peripheral Devices	29
3.6 Configuration of Peripheral Devices and Cable Connections	29
4 Test Instruments	30
4.1 Effective Radiated Power and Equivalent Isotropically Radiated Power	30
4.2 Modulation Characteristics	30
4.3 Peak to Average Ratio	30
4.4 Bandwidth	30
4.5 Conducted Spurious Emissions	30
4.6 Radiated Spurious Emissions below 1GHz	31
4.7 Radiated Spurious Emissions above 1GHz	32
4.8 Frequency Stability	33
5 Limits of Test Items	34
5.1 Effective Radiated Power and Equivalent Isotropically Radiated Power	34
5.2 Modulation Characteristics	34
5.3 Peak to Average Ratio	34
5.4 Bandwidth	34
5.5 Conducted Spurious Emissions	35
5.6 Radiated Spurious Emissions below 1GHz	36
5.7 Radiated Spurious Emissions above 1GHz	36
5.8 Frequency Stability	37
6 Test Arrangements	38
6.1 Effective Radiated Power and Equivalent Isotropically Radiated Power	38
6.1.1 Test Setup	38
6.1.2 Test Procedure	38
6.2 Modulation Characteristics	39
6.2.1 Test Setup	39
6.2.2 Test Procedure	39
6.3 Peak to Average Ratio	39
6.3.1 Test Setup	39
6.3.2 Test Procedure	39
6.4 Bandwidth	40
6.4.1 Test Setup	40
6.4.2 Test Procedure	40
6.5 Conducted Spurious Emissions	42
6.5.1 Test Setup	42
6.5.2 Test Procedure	42
6.6 Radiated Spurious Emissions below 1GHz	43
6.6.1 Test Setup	43
6.6.2 Test Procedure	43
6.7 Radiated Spurious Emissions above 1GHz	44
6.7.1 Test Setup	44
6.7.2 Test Procedure	44
6.8 Frequency Stability	45
6.8.1 Test Setup	45



6.8.2	Test Procedure	45
7	Test Results of Test Item	46
7.1	Effective Radiated Power and Equivalent Isotropically Radiated Power	46
7.1.1	GSM850	46
7.1.2	GSM1900	46
7.1.3	WCDMA Band 2	47
7.1.4	WCDMA Band 4	47
7.1.5	WCDMA Band 5	48
7.1.6	LTE Band 2	49
7.1.7	LTE Band 4	55
7.1.8	LTE Band 5	61
7.1.9	LTE Band 7	65
7.1.10	LTE Band 12	69
7.1.11	LTE Band 13	73
7.1.12	LTE Band 17	75
7.2	Modulation Characteristics	77
7.2.1	GSM850	77
7.2.2	GSM1900	77
7.2.3	WCDMA Band 2	78
7.2.4	WCDMA Band 4	79
7.2.5	WCDMA Band 5	80
7.2.6	LTE Band 2	81
7.2.7	LTE Band 4	81
7.2.8	LTE Band 5	82
7.2.9	LTE Band 7	82
7.2.10	LTE Band 12	83
7.2.11	LTE Band 13	83
7.2.12	LTE Band 17	84
7.3	Peak to Average Ratio	85
7.3.1	GSM850	85
7.3.2	GSM1900	86
7.3.3	WCDMA Band 2	87
7.3.4	WCDMA Band 4	88
7.3.5	WCDMA Band 5	89
7.3.6	LTE Band 2	90
7.3.7	LTE Band 4	96
7.3.8	LTE Band 5	102
7.3.9	LTE Band 7	106
7.3.10	LTE Band 12	110
7.3.11	LTE Band 13	114
7.3.12	LTE Band 17	116
7.4	Bandwidth	118
7.4.1	GSM850	118
7.4.2	GSM1900	119
7.4.3	WCDMA Band 2	120
7.4.4	WCDMA Band 4	121
7.4.5	WCDMA Band 5	122
7.4.6	LTE Band 2	123
7.4.7	LTE Band 4	129
7.4.8	LTE Band 5	135
7.4.9	LTE Band 7	139
7.4.10	LTE Band 12	143
7.4.11	LTE Band 13	147
7.4.12	LTE Band 17	149
7.5	Conducted Spurious Emissions	151
7.5.1	GSM850	151
7.5.2	GSM1900	155
7.5.3	WCDMA Band 2	159
7.5.4	WCDMA Band 4	165
7.5.5	WCDMA Band 5	171



7.5.6	LTE Band 2	177
7.5.7	LTE Band 4	189
7.5.8	LTE Band 5	201
7.5.9	LTE Band 7	209
7.5.10	LTE Band 12	217
7.5.11	LTE Band 13	225
7.5.12	LTE Band 17	231
7.6	Radiated Spurious Emissions below 1GHz	235
7.6.1	GSM 850	235
7.6.2	EDGE 850	237
7.6.3	PCS 1900	239
7.6.4	EDGE 1900	241
7.6.5	WCDMA Band 2	243
7.6.6	WCDMA Band 4	245
7.6.7	WCDMA Band 5	247
7.6.8	LTE Band 2	249
7.6.9	LTE Band 4	251
7.6.10	LTE Band 5	253
7.6.11	LTE Band 7	255
7.6.12	LTE Band 12	257
7.6.13	LTE Band 13	259
7.6.14	LTE Band 17	261
7.7	Radiated Spurious Emissions above 1GHz	263
7.7.1	GSM 850	263
7.7.2	EDGE 850	266
7.7.3	PCS 1900	269
7.7.4	EDGE 1900	272
7.7.5	WCDMA Band 2	275
7.7.6	WCDMA Band 4	278
7.7.7	WCDMA Band 5	281
7.7.8	LTE Band 2	284
7.7.9	LTE Band 4	293
7.7.10	LTE Band 5	302
7.7.11	LTE Band 7	311
7.7.12	LTE Band 12	317
7.7.13	LTE Band 13	326
7.7.14	LTE Band 17	330
7.8	Frequency Stability	336
7.8.1	GSM850	336
7.8.2	EDGE850	337
7.8.3	GSM1900	338
7.8.4	EDGE1900	339
7.8.5	WCDMA Band 2	340
7.8.6	WCDMA Band 4	341
7.8.7	WCDMA Band 5	342
7.8.8	LTE Band 2	343
7.8.9	LTE Band 4	349
7.8.10	LTE Band 5	355
7.8.11	LTE Band 7	359
7.8.12	LTE Band 12	363
7.8.13	LTE Band 13	367
7.8.14	LTE Band 17	369
8	Pictures of Test Arrangements	371
9	Information of the Testing Laboratories	372



Release Control Record

Issue No.	Description	Date Issued
RFBCKS-WTW-P23070373	Original Release	2023/9/28

1 Certificate

Product: 2G/3G/4G Module

Brand: WNC

Test Model: 48VMC28UT1

Sample Status: Engineering Sample

Applicant: Wistron NeWeb Corporation

Test Date: 2023/7/24 ~ 2023/8/1

Standard: 47 CFR FCC Part 22
47 CFR FCC Part 24
47 CFR FCC Part 27
47 CFR FCC Part 2

Measurement ANSI/TIA/EIA-603-E 2016

procedure: ANSI C63.26-2015

KDB 971168 D01 Power Meas License Digital Systems v03r01

KDB 971168 D02 Misc Rev Approv License Devices v02r02

The above equipment has been tested by **Bureau Veritas Consumer Products Services (H.K.) Ltd., Taoyuan Branch**, and found compliance with the requirement of the above standards. The test record, data evaluation & Equipment Under Test (EUT) configurations represented herein are true and accurate accounts of the measurements of the sample's RF characteristics under the conditions specified in this report.

2 Summary of Test Results

47 CFR FCC Part 22 47 CFR FCC Part 24 47 CFR FCC Part 27 47 CFR FCC Part 2			
Standard / Clause	Test Item	Result	Remark
FCC 47 CFR Part 2.1046 FCC 47 CFR Part 22.913 (a) FCC 47 CFR Part 24.232 (c) FCC 47 CFR Part 27.50(d) FCC 47 CFR Part 27.50(h) FCC 47 CFR Part 27.50(c) FCC 47 CFR Part 27.50(b)	Effective Radiated Power and Equivalent Isotropically Radiated Power	Pass	Meet the requirement of limit.
FCC 47 CFR Part 2.1047	Modulation Characteristics	Pass	Meet the requirement of limit.
FCC 47 CFR Part 22.913 (d) FCC 47 CFR Part 24.232 (d) FCC 47 CFR Part 27.50(d)	Peak to Average Ratio	Pass	Meet the requirement of limit.
FCC 47 CFR Part 2.1049	Bandwidth	Pass	Meet the requirement of limit.
FCC 47 CFR Part 2.1051 FCC 47 CFR Part 22.917 FCC 47 CFR Part 24.238 FCC 47 CFR Part 27.53(h) FCC 47 CFR Part 27.53(m) FCC 47 CFR Part 27.53(g) FCC 47 CFR Part 27.53(c)(f)	Conducted Spurious Emissions	Pass	Meet the requirement of limit.
FCC 47 CFR Part 2.1053 FCC 47 CFR Part 22.917 FCC 47 CFR Part 24.238 FCC 47 CFR Part 27.53(h) FCC 47 CFR Part 27.53(m) FCC 47 CFR Part 27.53(g) FCC 47 CFR Part 27.53(c)(f)	Radiated Spurious Emissions below 1GHz	Pass	Minimum passing margin is -22.80 dB at 130.88 MHz

47 CFR FCC Part 22
 47 CFR FCC Part 24
 47 CFR FCC Part 27
 47 CFR FCC Part 2

Standard / Clause	Test Item	Result	Remark
FCC 47 CFR Part 2.1053 FCC 47 CFR Part 22.917 FCC 47 CFR Part 24.238 FCC 47 CFR Part 27.53(h) FCC 47 CFR Part 27.53(m) FCC 47 CFR Part 27.53(g) FCC 47 CFR Part 27.53(c)(f)	Radiated Spurious Emissions above 1GHz	Pass	Minimum passing margin is -11.94 dB at 1569.00 MHz
FCC 47 CFR Part 2.1055 FCC 47 CFR Part 22.355 FCC 47 CFR Part 24.235 FCC 47 CFR Part 27.54	Frequency Stability	Pass	Meet the requirement of limit.

Note: Determining compliance based on the results of the compliance measurement, not taking into account measurement instrumentation uncertainty.

2.1 Measurement Uncertainty

Where relevant, the following measurement uncertainty levels have been estimated for tests performed on the EUT as specified in CISPR 16-4-2:

Measurement	Specification	Expanded Uncertainty (k=2) (±)
Radiated Spurious Emissions below 1GHz	9 kHz ~ 30 MHz	3.00 dB
	30 MHz ~ 1 GHz	2.93 dB
Radiated Spurious Emissions above 1GHz	1 GHz ~ 18 GHz	1.76 dB
	18 GHz ~ 40 GHz	1.77 dB

The other instruments specified are routine verified to remain within the calibrated levels, no measurement uncertainty is required to be calculated.

2.2 Supplementary Information

There is not any deviation from the test standards for the test method, and no modifications required for compliance.

3 General Information

3.1 General Description of EUT

Product	2G/3G/4G Module
Brand	WNC
Test Model	48VMC28UT1
Status of EUT	Engineering Sample
Power Supply Rating	3.8Vdc from power supply

Note:

1. EUT Overview

Band / Bandwidth	TX Frequency Range (MHz)	Max. EIRP Power
GSM1900	1850.2-1909.8	1655.770mW (32.19dBm)
WCDMA Band 2	1852.4-1907.6	331.131mW (25.20dBm)
WCDMA Band 4	1712.4-1752.6	331.894mW (25.21dBm)

Band / Bandwidth	TX Frequency Range (MHz)	Max. ERP Power
GSM850	824.2-848.8	2009.093mW (33.03dBm)
WCDMA Band 5	826.4-846.6	223.872mW (23.50dBm)

Band / Bandwidth	TX Frequency Range (MHz)	Max. EIRP Power	
		QPSK	16QAM
LTE Band 2 (Channel Bandwidth 1.4MHz)	1850.7-1909.3	316.228mW (25.00dBm)	250.611mW (23.99dBm)
LTE Band 2 (Channel Bandwidth 3MHz)	1851.5-1908.5	311.172mW (24.93dBm)	243.781mW (23.87dBm)
LTE Band 2 (Channel Bandwidth 5MHz)	1852.5-1907.5	316.957mW (25.01dBm)	246.604mW (23.92dBm)
LTE Band 2 (Channel Bandwidth 10MHz)	1855.0-1905.0	317.687mW (25.02dBm)	252.348mW (24.02dBm)
LTE Band 2 (Channel Bandwidth 15MHz)	1857.5-1902.5	319.890mW (25.05dBm)	248.313mW (23.95dBm)
LTE Band 2 (Channel Bandwidth 20MHz)	1860.0-1900.0	323.594mW (25.10dBm)	256.448mW (24.09dBm)
LTE Band 4 (Channel Bandwidth 1.4MHz)	1710.7-1754.3	345.939mW (25.39dBm)	269.774mW (24.31dBm)
LTE Band 4 (Channel Bandwidth 3MHz)	1711.5-1753.5	345.144mW (25.38dBm)	273.527mW (24.37dBm)
LTE Band 4 (Channel Bandwidth 5MHz)	1712.5-1752.5	343.558mW (25.36dBm)	269.153mW (24.30dBm)
LTE Band 4 (Channel Bandwidth 10MHz)	1715.0-1750.0	368.129mW (25.66dBm)	287.078mW (24.58dBm)
LTE Band 4 (Channel Bandwidth 15MHz)	1717.5-1747.5	354.813mW (25.50dBm)	281.190mW (24.49dBm)
LTE Band 4 (Channel Bandwidth 20MHz)	1720.0-1745.0	370.681mW (25.69dBm)	288.403mW (24.60dBm)

Band / Bandwidth	TX Frequency Range (MHz)	Max. EIRP Power	
		QPSK	16QAM
LTE Band 7 (Channel Bandwidth 5MHz)	2502.5-2567.5	338.844mW (25.30dBm)	267.301mW (24.27dBm)
LTE Band 7 (Channel Bandwidth 10MHz)	2505.0-2565.0	338.065mW (25.29dBm)	266.686mW (24.26dBm)
LTE Band 7 (Channel Bandwidth 15MHz)	2507.5-2562.5	339.625mW (25.31dBm)	269.153mW (24.30dBm)
LTE Band 7 (Channel Bandwidth 20MHz)	2510.0-2560.0	341.979mW (25.34dBm)	266.073mW (24.25dBm)

Band / Bandwidth	TX Frequency Range (MHz)	Max. ERP Power	
		QPSK	16QAM
LTE Band 5 (Channel Bandwidth 1.4MHz)	824.7-848.3	221.309mW (23.45dBm)	171.791mW (22.35dBm)
LTE Band 5 (Channel Bandwidth 3MHz)	825.5-847.5	221.820mW (23.46dBm)	174.985mW (22.43dBm)
LTE Band 5 (Channel Bandwidth 5MHz)	826.5-846.5	222.844mW (23.48dBm)	173.380mW (22.39dBm)
LTE Band 5 (Channel Bandwidth 10MHz)	829.0-844.0	224.388mW (23.51dBm)	176.198mW (22.46dBm)
LTE Band 12 (Channel Bandwidth 1.4MHz)	699.7-715.3	221.309mW (23.45dBm)	174.582mW (22.42dBm)
LTE Band 12 (Channel Bandwidth 3MHz)	700.5-714.5	222.331mW (23.47dBm)	173.780mW (22.40dBm)
LTE Band 12 (Channel Bandwidth 5MHz)	701.5-713.5	221.309mW (23.45dBm)	172.982mW (22.38dBm)
LTE Band 12 (Channel Bandwidth 10MHz)	704.0-711.0	231.206mW (23.64dBm)	179.887mW (22.55dBm)
LTE Band 13 (Channel Bandwidth 5MHz)	779.5-784.5	231.206mW (23.64dBm)	180.717mW (22.57dBm)
LTE Band 13 (Channel Bandwidth 10MHz)	782.0	238.232mW (23.77dBm)	184.927mW (22.67dBm)
LTE Band 17 (Channel Bandwidth 5MHz)	706.5-713.5	224.905mW (23.52dBm)	177.828mW (22.50dBm)
LTE Band 17 (Channel Bandwidth 10MHz)	709.0-711.0	230.144mW (23.62dBm)	179.887mW (22.55dBm)

Band / Bandwidth	TX Frequency Range (MHz)	Emission Designator
GSM850	824.2-848.8	247KGXW
EDGE850	824.2-848.8	245KG7W
GSM1900	1850.2-1909.8	250KGXW
EDGE1900	1850.2-1909.8	248KG7W
WCDMA Band 2	1852.4-1907.6	4M14F9W
WCDMA Band 4	1712.4-1752.6	4M14F9W
WCDMA Band 5	826.4-846.6	4M15F9W

and / Bandwidth	TX Frequency Range (MHz)	Emission Designator	
		QPSK	16QAM
LTE Band 2 (Channel Bandwidth 1.4MHz)	1850.7-1909.3	1M09G7D	1M09D7W
LTE Band 2 (Channel Bandwidth 3MHz)	1851.5-1908.5	2M70G7D	2M70D7W
LTE Band 2 (Channel Bandwidth 5MHz)	1852.5-1907.5	4M50G7D	4M49D7W
LTE Band 2 (Channel Bandwidth 10MHz)	1855.0-1905.0	8M95G7D	8M95D7W
LTE Band 2 (Channel Bandwidth 15MHz)	1857.5-1902.5	13M4G7D	13M4D7W
LTE Band 2 (Channel Bandwidth 20MHz)	1860.0-1900.0	17M9G7D	17M9D7W
LTE Band 4 (Channel Bandwidth 1.4MHz)	1710.7-1754.3	1M09G7D	1M09D7W
LTE Band 4 (Channel Bandwidth 3MHz)	1711.5-1753.5	2M70G7D	2M70D7W
LTE Band 4 (Channel Bandwidth 5MHz)	1712.5-1752.5	4M50G7D	4M49D7W
LTE Band 4 (Channel Bandwidth 10MHz)	1715.0-1750.0	8M96G7D	8M96D7W
LTE Band 4 (Channel Bandwidth 15MHz)	1717.5-1747.5	13M4G7D	13M4D7W
LTE Band 4 (Channel Bandwidth 20MHz)	1720.0-1745.0	17M9G7D	17M9D7W
LTE Band 5 (Channel Bandwidth 1.4MHz)	824.7-848.3	1M09G7D	1M09D7W
LTE Band 5 (Channel Bandwidth 3MHz)	825.5-847.5	2M70G7D	2M70D7W
LTE Band 5 (Channel Bandwidth 5MHz)	826.5-846.5	4M49G7D	4M49D7W
LTE Band 5 (Channel Bandwidth 10MHz)	829.0-844.0	8M97G7D	8M97D7W
LTE Band 7 (Channel Bandwidth 5MHz)	2502.5-2567.5	4M49G7D	4M49D7W
LTE Band 7 (Channel Bandwidth 10MHz)	2505.0-2565.0	8M96G7D	8M95D7W
LTE Band 7 (Channel Bandwidth 15MHz)	2507.5-2562.5	13M4G7D	13M4D7W
LTE Band 7 (Channel Bandwidth 20MHz)	2510.0-2560.0	17M9G7D	17M9D7W
LTE Band 12 (Channel Bandwidth 1.4MHz)	699.7-715.3	1M09G7D	1M09D7W
LTE Band 12 (Channel Bandwidth 3MHz)	700.5-714.5	2M70G7D	2M70D7W
LTE Band 12 (Channel Bandwidth 5MHz)	701.5-713.5	4M50G7D	4M49D7W
LTE Band 12 (Channel Bandwidth 10MHz)	704.0-711.0	8M98G7D	8M98D7W
LTE Band 13 (Channel Bandwidth 5MHz)	779.5-784.5	4M49G7D	4M49D7W
LTE Band 13 (Channel Bandwidth 10MHz)	782.0	8M94G7D	8M94D7W
LTE Band 17 (Channel Bandwidth 5MHz)	706.5-713.5	4M50G7D	4M50D7W
LTE Band 17 (Channel Bandwidth 10MHz)	709.0-711.0	8M97G7D	8M97D7W

2. The above EUT information is declared by manufacturer and for more detailed features description, please refers to the manufacturer's specifications or user's manual.

3.2 Antenna Description of EUT

1. The antenna information is listed as below.

Antenna Type	Dipole Antenna	
Antenna Connector	SMA	
Antenna Gain (dBi)	GSM850	2
	GSM1900	2
	WCDMA Band 2	2
	WCDMA Band 4	2
	WCDMA Band 5	2
	LTE Band 2	2
	LTE Band 4	2
	LTE Band 5	2
	LTE Band 7	2
	LTE Band 12	2
	LTE Band 13	2
	LTE Band 17	2

* Detail antenna specification please refer to antenna datasheet and/or antenna measurement report.

3.3 Test Mode Applicability and Tested Channel Detail

Pre-Scan:	The EUT is designed to be positioned on the Z-plane only.
-----------	---

For GSM850

Test Item	Tested Channel	Channel Bandwidth	Modulation	Mode
ERP	128 (824.20 MHz) 189 (836.40 MHz) 251 (848.80 MHz)	-	-	GSM, EDGE
Modulation Characteristics	128 (824.20 MHz)	-	-	GSM, EDGE
Frequency Stability	128 (824.20 MHz) 251 (848.80 MHz)	-	-	GSM, EDGE
Occupied Bandwidth	128 (824.20 MHz) 189 (836.40 MHz) 251 (848.80 MHz)	-	-	GSM, EDGE
Peak to Average Ratio	128 (824.20 MHz) 189 (836.40 MHz) 251 (848.80 MHz)	-	-	GSM, EDGE
Conducted Emission	128 (824.20 MHz) 189 (836.40 MHz) 251 (848.80 MHz)	-	-	GSM, EDGE
Radiated Spurious Emissions below 1GHz	251 (848.80 MHz)	-	-	GSM, EDGE
Radiated Spurious Emissions above 1GHz	128 (824.20 MHz) 189 (836.40 MHz) 251 (848.80 MHz)	-	-	GSM, EDGE

For GSM1900

Test Item	Tested Channel	Channel Bandwidth	Modulation	Mode
EIRP	512 (1850.20 MHz) 661 (1880.00 MHz) 810 (1909.80 MHz)	-	-	GSM, EDGE
Modulation Characteristics	512 (1850.20 MHz)	-	-	GSM, EDGE
Frequency Stability	512 (1850.20 MHz) 810 (1909.80 MHz)	-	-	GSM, EDGE
Occupied Bandwidth	512 (1850.20 MHz) 661 (1880.00 MHz) 810 (1909.80 MHz)	-	-	GSM, EDGE
Peak to Average Ratio	512 (1850.20 MHz) 661 (1880.00 MHz) 810 (1909.80 MHz)	-	-	GSM, EDGE
Conducted Emission	512 (1850.20 MHz) 661 (1880.00 MHz) 810 (1909.80 MHz)	-	-	GSM, EDGE
Radiated Spurious Emissions below 1GHz	810 (1909.80 MHz)	-	-	GSM, EDGE
Radiated Spurious Emissions above 1GHz	512 (1850.20 MHz) 661 (1880.00 MHz) 810 (1909.80 MHz)	-	-	GSM, EDGE

For WCDMA Band 2

Test Item	Tested Channel	Channel Bandwidth	Modulation	Mode
EIRP	9262 (1852.40 MHz) 9400 (1880.00 MHz) 9538 (1907.60 MHz)	-	-	WCDMA HSDPA HSUPA
Modulation Characteristics	9400 (1880.00 MHz)	-	-	WCDMA HSDPA HSUPA
Frequency Stability	9262 (1852.40 MHz) 9538 (1907.60 MHz)	-	-	WCDMA
Occupied Bandwidth	9262 (1852.40 MHz) 9400 (1880.00 MHz) 9538 (1907.60 MHz)	-	-	WCDMA HSDPA HSUPA
Peak to Average Ratio	9262 (1852.40 MHz) 9400 (1880.00 MHz) 9538 (1907.60 MHz)	-	-	WCDMA HSDPA HSUPA
Conducted Emission	9262 (1852.40 MHz) 9400 (1880.00 MHz) 9538 (1907.60 MHz)	-	-	WCDMA HSDPA HSUPA
Radiated Spurious Emissions below 1GHz	9538 (1907.60 MHz)	-	-	WCDMA
Radiated Spurious Emissions above 1GHz	9262 (1852.40 MHz) 9400 (1880.00 MHz) 9538 (1907.60 MHz)	-	-	WCDMA

For WCDMA Band 4

Test Item	Tested Channel	Channel Bandwidth	Modulation	Mode
EIRP	1312 (1712.40 MHz) 1413 (1732.60 MHz) 1513 (1752.60 MHz)	-	-	WCDMA HSDPA HSUPA
Modulation Characteristics	1413 (1732.60 MHz)	-	-	WCDMA HSDPA HSUPA
Frequency Stability	1312 (1712.40 MHz) 1513 (1752.60 MHz)	-	-	WCDMA
Occupied Bandwidth	1312 (1712.40 MHz) 1413 (1732.60 MHz) 1513 (1752.60 MHz)	-	-	WCDMA HSDPA HSUPA
Peak to Average Ratio	1312 (1712.40 MHz) 1413 (1732.60 MHz) 1513 (1752.60 MHz)	-	-	WCDMA HSDPA HSUPA
Conducted Emission	1312 (1712.40 MHz) 1413 (1732.60 MHz) 1513 (1752.60 MHz)	-	-	WCDMA HSDPA HSUPA
Radiated Spurious Emissions below 1GHz	1513 (1752.60 MHz)	-	-	WCDMA
Radiated Spurious Emissions above 1GHz	1312 (1712.40 MHz) 1413 (1732.60 MHz) 1513 (1752.60 MHz)	-	-	WCDMA

For WCDMA Band 5

Test Item	Tested Channel	Channel Bandwidth	Modulation	Mode
ERP	4132 (826.40 MHz) 4182 (836.40 MHz) 4233 (846.60 MHz)	-	-	WCDMA HSDPA HSUPA
Modulation Characteristics	4182 (836.40 MHz)	-	-	WCDMA HSDPA HSUPA
Frequency Stability	4132 (826.40 MHz) 4233 (846.60 MHz)	-	-	WCDMA
Occupied Bandwidth	4132 (826.40 MHz) 4182 (836.40 MHz) 4233 (846.60 MHz)	-	-	WCDMA HSDPA HSUPA
Peak to Average Ratio	4132 (826.40 MHz) 4182 (836.40 MHz) 4233 (846.60 MHz)	-	-	WCDMA HSDPA HSUPA
Conducted Emission	4132 (826.40 MHz) 4182 (836.40 MHz) 4233 (846.60 MHz)	-	-	WCDMA HSDPA HSUPA
Radiated Spurious Emissions below 1GHz	4233 (846.60 MHz)	-	-	WCDMA
Radiated Spurious Emissions above 1GHz	4132 (826.40 MHz) 4182 (836.40 MHz) 4233 (846.60 MHz)	-	-	WCDMA

For LTE Band 2

Test Item	Tested Channel	Channel Bandwidth	Modulation	Mode
EIRP	18607 (1850.70 MHz) 18900 (1880.00 MHz) 19193 (1909.30 MHz)	1.4 MHz	QPSK / 16QAM	1 RB Half RB Full RB
	18615 (1851.50 MHz) 18900 (1880.00 MHz) 19185 (1908.50 MHz)	3 MHz	QPSK / 16QAM	1 RB Half RB Full RB
	18625 (1852.50 MHz) 18900 (1880.00 MHz) 19175 (1907.50 MHz)	5 MHz	QPSK / 16QAM	1 RB Half RB Full RB
	18650 (1855.00 MHz) 18900 (1880.00 MHz) 19150 (1905.00 MHz)	10 MHz	QPSK / 16QAM	1 RB Half RB Full RB
	18675 (1857.50 MHz) 18900 (1880.00 MHz) 19125 (1902.50 MHz)	15 MHz	QPSK / 16QAM	1 RB Half RB Full RB
	18700 (1860.00 MHz) 18900 (1880.00 MHz) 19100 (1900.00 MHz)	20 MHz	QPSK / 16QAM	1 RB Half RB Full RB
Modulation Characteristics	18900 (1880.00 MHz)	20 MHz	QPSK / 16QAM	Full RB
Frequency Stability	18607 (1850.70 MHz) 19193 (1909.30 MHz)	1.4 MHz	QPSK	Full RB
	18615 (1851.50 MHz) 19185 (1908.50 MHz)	3 MHz	QPSK	Full RB
	18625 (1852.50 MHz) 19175 (1907.50 MHz)	5 MHz	QPSK	Full RB
	18650 (1855.00 MHz) 19150 (1905.00 MHz)	10 MHz	QPSK	Full RB
	18675 (1857.50 MHz) 19125 (1902.50 MHz)	15 MHz	QPSK	Full RB
	18700 (1860.00 MHz) 19100 (1900.00 MHz)	20 MHz	QPSK	Full RB

Test Item	Tested Channel	Channel Bandwidth	Modulation	Mode
Occupied Bandwidth	18607 (1850.70 MHz) 18900 (1880.00 MHz) 19193 (1909.30 MHz)	1.4 MHz	QPSK / 16QAM	Full RB
	18615 (1851.50 MHz) 18900 (1880.00 MHz) 19185 (1908.50 MHz)	3 MHz	QPSK / 16QAM	Full RB
	18625 (1852.50 MHz) 18900 (1880.00 MHz) 19175 (1907.50 MHz)	5 MHz	QPSK / 16QAM	Full RB
	18650 (1855.00 MHz) 18900 (1880.00 MHz) 19150 (1905.00 MHz)	10 MHz	QPSK / 16QAM	Full RB
	18675 (1857.50 MHz) 18900 (1880.00 MHz) 19125 (1902.50 MHz)	15 MHz	QPSK / 16QAM	Full RB
	18700 (1860.00 MHz) 18900 (1880.00 MHz) 19100 (1900.00 MHz)	20 MHz	QPSK / 16QAM	Full RB
Peak to Average Ratio	18607 (1850.70 MHz) 18900 (1880.00 MHz) 19193 (1909.30 MHz)	1.4 MHz	QPSK / 16QAM	1 RB
	18615 (1851.50 MHz) 18900 (1880.00 MHz) 19185 (1908.50 MHz)	3 MHz	QPSK / 16QAM	1 RB
	18625 (1852.50 MHz) 18900 (1880.00 MHz) 19175 (1907.50 MHz)	5 MHz	QPSK / 16QAM	1 RB
	18650 (1855.00 MHz) 18900 (1880.00 MHz) 19150 (1905.00 MHz)	10 MHz	QPSK / 16QAM	1 RB
	18675 (1857.50 MHz) 18900 (1880.00 MHz) 19125 (1902.50 MHz)	15 MHz	QPSK / 16QAM	1 RB
	18700 (1860.00 MHz) 18900 (1880.00 MHz) 19100 (1900.00 MHz)	20 MHz	QPSK / 16QAM	1 RB

Test Item	Tested Channel	Channel Bandwidth	Modulation	Mode
Conducted Emission	18607 (1850.70 MHz) 18900 (1880.00 MHz) 19193 (1909.30 MHz)	1.4 MHz	QPSK	1 RB Full RB
	18615 (1851.50 MHz) 18900 (1880.00 MHz) 19185 (1908.50 MHz)	3 MHz	QPSK	1 RB Full RB
	18625 (1852.50 MHz) 18900 (1880.00 MHz) 19175 (1907.50 MHz)	5 MHz	QPSK	1 RB Full RB
	18650 (1855.00 MHz) 18900 (1880.00 MHz) 19150 (1905.00 MHz)	10 MHz	QPSK	1 RB Full RB
	18675 (1857.50 MHz) 18900 (1880.00 MHz) 19125 (1902.50 MHz)	15 MHz	QPSK	1 RB Full RB
	18700 (1860.00 MHz) 18900 (1880.00 MHz) 19100 (1900.00 MHz)	20 MHz	QPSK	1 RB Full RB
Radiated Spurious Emissions below 1GHz	19100 (1900.00 MHz)	20 MHz	QPSK	1 RB
Radiated Spurious Emissions above 1GHz	18607 (1850.70 MHz) 18900 (1880.00 MHz) 19193 (1909.30 MHz)	1.4 MHz	QPSK	1 RB
	18625 (1852.50 MHz) 18900 (1880.00 MHz) 19175 (1907.50 MHz)	5 MHz	QPSK	1 RB
	18700 (1860.00 MHz) 18900 (1880.00 MHz) 19100 (1900.00 MHz)	20 MHz	QPSK	1 RB

For LTE Band 4

Test Item	Tested Channel	Channel Bandwidth	Modulation	Mode
EIRP	19957 (1710.70 MHz) 20175 (1732.50 MHz) 20393 (1754.30 MHz)	1.4 MHz	QPSK / 16QAM	1 RB Half RB Full RB
	19965 (1711.50 MHz) 20175 (1732.50 MHz) 20385 (1753.50 MHz)	3 MHz	QPSK / 16QAM	1 RB Half RB Full RB
	19975 (1712.50 MHz) 20175 (1732.50 MHz) 20375 (1752.50 MHz)	5 MHz	QPSK / 16QAM	1 RB Half RB Full RB
	20000 (1715.00 MHz) 20175 (1732.50 MHz) 20350 (1750.00 MHz)	10 MHz	QPSK / 16QAM	1 RB Half RB Full RB
	20025 (1717.50 MHz) 20175 (1732.50 MHz) 20325 (1747.50 MHz)	15 MHz	QPSK / 16QAM	1 RB Half RB Full RB
	20050 (1720.00 MHz) 20175 (1732.50 MHz) 20300 (1745.00 MHz)	20 MHz	QPSK / 16QAM	1 RB Half RB Full RB
Modulation Characteristics	20175 (1732.50 MHz)	20 MHz	QPSK / 16QAM	Full RB
Frequency Stability	19957 (1710.70 MHz) 20393 (1754.30 MHz)	1.4 MHz	QPSK	Full RB
	19965 (1711.50 MHz) 20385 (1753.50 MHz)	3 MHz	QPSK	Full RB
	19975 (1712.50 MHz) 20375 (1752.50 MHz)	5 MHz	QPSK	Full RB
	20000 (1715.00 MHz) 20350 (1750.00 MHz)	10 MHz	QPSK	Full RB
	20025 (1717.50 MHz) 20325 (1747.50 MHz)	15 MHz	QPSK	Full RB
	20050 (1720.00 MHz) 20300 (1745.00 MHz)	20 MHz	QPSK	Full RB
Occupied Bandwidth	19957 (1710.70 MHz) 20175 (1732.50 MHz) 20393 (1754.30 MHz)	1.4 MHz	QPSK / 16QAM	Full RB
	19965 (1711.50 MHz) 20175 (1732.50 MHz) 20385 (1753.50 MHz)	3 MHz	QPSK / 16QAM	Full RB
	19975 (1712.50 MHz) 20175 (1732.50 MHz) 20375 (1752.50 MHz)	5 MHz	QPSK / 16QAM	Full RB
	20000 (1715.00 MHz) 20175 (1732.50 MHz) 20350 (1750.00 MHz)	10 MHz	QPSK / 16QAM	Full RB
	20025 (1717.50 MHz) 20175 (1732.50 MHz) 20325 (1747.50 MHz)	15 MHz	QPSK / 16QAM	Full RB
	20050 (1720.00 MHz) 20175 (1732.50 MHz) 20300 (1745.00 MHz)	20 MHz	QPSK / 16QAM	Full RB

Test Item	Tested Channel	Channel Bandwidth	Modulation	Mode
Peak to Average Ratio	19957 (1710.70 MHz) 20175 (1732.50 MHz) 20393 (1754.30 MHz)	1.4 MHz	QPSK / 16QAM	1 RB
	19965 (1711.50 MHz) 20175 (1732.50 MHz) 20385 (1753.50 MHz)	3 MHz	QPSK / 16QAM	1 RB
	19975 (1712.50 MHz) 20175 (1732.50 MHz) 20375 (1752.50 MHz)	5 MHz	QPSK / 16QAM	1 RB
	20000 (1715.00 MHz) 20175 (1732.50 MHz) 20350 (1750.00 MHz)	10 MHz	QPSK / 16QAM	1 RB
	20025 (1717.50 MHz) 20175 (1732.50 MHz) 20325 (1747.50 MHz)	15 MHz	QPSK / 16QAM	1 RB
	20050 (1720.00 MHz) 20175 (1732.50 MHz) 20300 (1745.00 MHz)	20 MHz	QPSK / 16QAM	1 RB
Conducted Emission	19957 (1710.70 MHz) 20175 (1732.50 MHz) 20393 (1754.30 MHz)	1.4 MHz	QPSK	1 RB Full RB
	19965 (1711.50 MHz) 20175 (1732.50 MHz) 20385 (1753.50 MHz)	3 MHz	QPSK	1 RB Full RB
	19975 (1712.50 MHz) 20175 (1732.50 MHz) 20375 (1752.50 MHz)	5 MHz	QPSK	1 RB Full RB
	20000 (1715.00 MHz) 20175 (1732.50 MHz) 20350 (1750.00 MHz)	10 MHz	QPSK	1 RB Full RB
	20025 (1717.50 MHz) 20175 (1732.50 MHz) 20325 (1747.50 MHz)	15 MHz	QPSK	1 RB Full RB
	20050 (1720.00 MHz) 20175 (1732.50 MHz) 20300 (1745.00 MHz)	20 MHz	QPSK	1 RB Full RB
Radiated Spurious Emissions below 1GHz	20375 (1752.50 MHz)	5 MHz	QPSK	1 RB
Radiated Spurious Emissions above 1GHz	19957 (1710.70 MHz) 20175 (1732.50 MHz) 20393 (1754.30 MHz)	1.4 MHz	QPSK	1 RB
	19975 (1712.50 MHz) 20175 (1732.50 MHz) 20375 (1752.50 MHz)	5 MHz	QPSK	1 RB
	20050 (1720.00 MHz) 20175 (1732.50 MHz) 20300 (1745.00 MHz)	20 MHz	QPSK	1 RB

For LTE Band 5

Test Item	Tested Channel	Channel Bandwidth	Modulation	Mode
ERP	20407 (824.70 MHz) 20525 (836.50 MHz) 20643 (848.30 MHz)	1.4 MHz	QPSK / 16QAM	1 RB Half RB Full RB
	20415 (825.50 MHz) 20525 (836.50 MHz) 20635 (847.50 MHz)	3 MHz	QPSK / 16QAM	1 RB Half RB Full RB
	20425 (826.50 MHz) 20525 (836.50 MHz) 20625 (846.50 MHz)	5 MHz	QPSK / 16QAM	1 RB Half RB Full RB
	20450 (829.00 MHz) 20525 (836.50 MHz) 20600 (844.00 MHz)	10 MHz	QPSK / 16QAM	1 RB Half RB Full RB
Modulation Characteristics	20525 (836.50 MHz)	10 MHz	QPSK / 16QAM	Full RB
Frequency Stability	20407 (824.70 MHz) 20643 (848.30 MHz)	1.4 MHz	QPSK	Full RB
	20415 (825.50 MHz) 20635 (847.50 MHz)	3 MHz	QPSK	Full RB
	20425 (826.50 MHz) 20625 (846.50 MHz)	5 MHz	QPSK	Full RB
	20450 (829.00 MHz) 20600 (844.00 MHz)	10 MHz	QPSK	Full RB
Occupied Bandwidth	20407 (824.70 MHz) 20525 (836.50 MHz) 20643 (848.30 MHz)	1.4 MHz	QPSK / 16QAM	Full RB
	20415 (825.50 MHz) 20525 (836.50 MHz) 20635 (847.50 MHz)	3 MHz	QPSK / 16QAM	Full RB
	20425 (826.50 MHz) 20525 (836.50 MHz) 20625 (846.50 MHz)	5 MHz	QPSK / 16QAM	Full RB
	20450 (829.00 MHz) 20525 (836.50 MHz) 20600 (844.00 MHz)	10 MHz	QPSK / 16QAM	Full RB
Peak to Average Ratio	20407 (824.70 MHz) 20525 (836.50 MHz) 20643 (848.30 MHz)	1.4 MHz	QPSK / 16QAM	1 RB
	20415 (825.50 MHz) 20525 (836.50 MHz) 20635 (847.50 MHz)	3 MHz	QPSK / 16QAM	1 RB
	20425 (826.50 MHz) 20525 (836.50 MHz) 20625 (846.50 MHz)	5 MHz	QPSK / 16QAM	1 RB
	20450 (829.00 MHz) 20525 (836.50 MHz) 20600 (844.00 MHz)	10 MHz	QPSK / 16QAM	1 RB

Test Item	Tested Channel	Channel Bandwidth	Modulation	Mode
Conducted Emission	20407 (824.70 MHz) 20525 (836.50 MHz) 20643 (848.30 MHz)	1.4 MHz	QPSK	1 RB Full RB
	20415 (825.50 MHz) 20525 (836.50 MHz) 20635 (847.50 MHz)	3 MHz	QPSK	1 RB Full RB
	20425 (826.50 MHz) 20525 (836.50 MHz) 20625 (846.50 MHz)	5 MHz	QPSK	1 RB Full RB
	20450 (829.00 MHz) 20525 (836.50 MHz) 20600 (844.00 MHz)	10 MHz	QPSK	1 RB Full RB
Radiated Spurious Emissions below 1GHz	20643 (848.30 MHz)	1.4 MHz	QPSK	1 RB
Radiated Spurious Emissions above 1GHz	20407 (824.70 MHz) 20525 (836.50 MHz) 20643 (848.30 MHz)	1.4 MHz	QPSK	1 RB
	20425 (826.50 MHz) 20525 (836.50 MHz) 20625 (846.50 MHz)	5 MHz	QPSK	1 RB
	20450 (829.00 MHz) 20525 (836.50 MHz) 20600 (844.00 MHz)	10 MHz	QPSK	1 RB

For LTE Band 7

Test Item	Tested Channel	Channel Bandwidth	Modulation	Mode
EIRP	20775 (2502.50 MHz) 21100 (2535.00 MHz) 21425 (2567.50 MHz)	5 MHz	QPSK / 16QAM	1 RB Half RB Full RB
	20800 (2505.00 MHz) 21100 (2535.00 MHz) 21400 (2565.00 MHz)	10 MHz	QPSK / 16QAM	1 RB Half RB Full RB
	20825 (2507.50 MHz) 21100 (2535.00 MHz) 21375 (2562.50 MHz)	15 MHz	QPSK / 16QAM	1 RB Half RB Full RB
	20850 (2510.00 MHz) 21100 (2535.00 MHz) 21350 (2560.00 MHz)	20 MHz	QPSK / 16QAM	1 RB Half RB Full RB
Modulation Characteristics	21100 (2535.00 MHz)	20 MHz	QPSK / 16QAM	Full RB
Frequency Stability	20775 (2502.50 MHz) 21425 (2567.50 MHz)	5 MHz	QPSK	Full RB
	20800 (2505.00 MHz) 21400 (2565.00 MHz)	10 MHz	QPSK	Full RB
	20825 (2507.50 MHz) 21375 (2562.50 MHz)	15 MHz	QPSK	Full RB
	20850 (2510.00 MHz) 21350 (2560.00 MHz)	20 MHz	QPSK	Full RB
Occupied Bandwidth	20775 (2502.50 MHz) 21100 (2535.00 MHz) 21425 (2567.50 MHz)	5 MHz	QPSK / 16QAM	Full RB
	20800 (2505.00 MHz) 21100 (2535.00 MHz) 21400 (2565.00 MHz)	10 MHz	QPSK / 16QAM	Full RB
	20825 (2507.50 MHz) 21100 (2535.00 MHz) 21375 (2562.50 MHz)	15 MHz	QPSK / 16QAM	Full RB
	20850 (2510.00 MHz) 21100 (2535.00 MHz) 21350 (2560.00 MHz)	20 MHz	QPSK / 16QAM	Full RB
Peak to Average Ratio	20775 (2502.50 MHz) 21100 (2535.00 MHz) 21425 (2567.50 MHz)	5 MHz	QPSK / 16QAM	1 RB
	20800 (2505.00 MHz) 21100 (2535.00 MHz) 21400 (2565.00 MHz)	10 MHz	QPSK / 16QAM	1 RB
	20825 (2507.50 MHz) 21100 (2535.00 MHz) 21375 (2562.50 MHz)	15 MHz	QPSK / 16QAM	1 RB
	20850 (2510.00 MHz) 21100 (2535.00 MHz) 21350 (2560.00 MHz)	20 MHz	QPSK / 16QAM	1 RB

Test Item	Tested Channel	Channel Bandwidth	Modulation	Mode
Conducted Emission	20775 (2502.50 MHz) 21100 (2535.00 MHz) 21425 (2567.50 MHz)	5 MHz	QPSK	1 RB Full RB
	20800 (2505.00 MHz) 21100 (2535.00 MHz) 21400 (2565.00 MHz)	10 MHz	QPSK	1 RB Full RB
	20825 (2507.50 MHz) 21100 (2535.00 MHz) 21375 (2562.50 MHz)	15 MHz	QPSK	1 RB Full RB
	20850 (2510.00 MHz) 21100 (2535.00 MHz) 21350 (2560.00 MHz)	20 MHz	QPSK	1 RB Full RB
Radiated Spurious Emissions below 1GHz	21350 (2560.00 MHz)	20 MHz	QPSK	1 RB
Radiated Spurious Emissions above 1GHz	20775 (2502.50 MHz) 21100 (2535.00 MHz) 21425 (2567.50 MHz)	5 MHz	QPSK	1 RB
	20850 (2510.00 MHz) 21100 (2535.00 MHz) 21350 (2560.00 MHz)	20 MHz	QPSK	1 RB

For LTE Band 12

Test Item	Tested Channel	Channel Bandwidth	Modulation	Mode
ERP	23017 (699.70 MHz) 23095 (707.50 MHz) 23173 (715.30 MHz)	1.4 MHz	QPSK / 16QAM	1 RB Half RB Full RB
	23025 (700.50 MHz) 23095 (707.50 MHz) 23165 (714.50 MHz)	3 MHz	QPSK / 16QAM	1 RB Half RB Full RB
	23035 (701.50 MHz) 23095 (707.50 MHz) 23155 (713.50 MHz)	5 MHz	QPSK / 16QAM	1 RB Half RB Full RB
	23060 (704.00 MHz) 23095 (707.50 MHz) 23130 (711.00 MHz)	10 MHz	QPSK / 16QAM	1 RB Half RB Full RB
Modulation Characteristics	23095 (707.50 MHz)	10 MHz	QPSK / 16QAM	Full RB
Frequency Stability	23017 (699.70 MHz) 23173 (715.30 MHz)	1.4 MHz	QPSK	Full RB
	23025 (700.50 MHz) 23165 (714.50 MHz)	3 MHz	QPSK	Full RB
	23035 (701.50 MHz) 23155 (713.50 MHz)	5 MHz	QPSK	Full RB
	23060 (704.00 MHz) 23130 (711.00 MHz)	10 MHz	QPSK	Full RB
Occupied Bandwidth	23017 (699.70 MHz) 23095 (707.50 MHz) 23173 (715.30 MHz)	1.4 MHz	QPSK / 16QAM	Full RB
	23025 (700.50 MHz) 23095 (707.50 MHz) 23165 (714.50 MHz)	3 MHz	QPSK / 16QAM	Full RB
	23035 (701.50 MHz) 23095 (707.50 MHz) 23155 (713.50 MHz)	5 MHz	QPSK / 16QAM	Full RB
	23060 (704.00 MHz) 23095 (707.50 MHz) 23130 (711.00 MHz)	10 MHz	QPSK / 16QAM	Full RB
Peak to Average Ratio	23017 (699.70 MHz) 23095 (707.50 MHz) 23173 (715.30 MHz)	1.4 MHz	QPSK / 16QAM	1 RB
	23025 (700.50 MHz) 23095 (707.50 MHz) 23165 (714.50 MHz)	3 MHz	QPSK / 16QAM	1 RB
	23035 (701.50 MHz) 23095 (707.50 MHz) 23155 (713.50 MHz)	5 MHz	QPSK / 16QAM	1 RB
	23060 (704.00 MHz) 23095 (707.50 MHz) 23130 (711.00 MHz)	10 MHz	QPSK / 16QAM	1 RB

Test Item	Tested Channel	Channel Bandwidth	Modulation	Mode
Conducted Emission	23017 (699.70 MHz) 23095 (707.50 MHz) 23173 (715.30 MHz)	1.4 MHz	QPSK	1 RB Full RB
	23025 (700.50 MHz) 23095 (707.50 MHz) 23165 (714.50 MHz)	3 MHz	QPSK	1 RB Full RB
	23035 (701.50 MHz) 23095 (707.50 MHz) 23155 (713.50 MHz)	5 MHz	QPSK	1 RB Full RB
	23060 (704.00 MHz) 23095 (707.50 MHz) 23130 (711.00 MHz)	10 MHz	QPSK	1 RB Full RB
Radiated Spurious Emissions below 1GHz	23173 (715.30 MHz)	1.4 MHz	QPSK	1 RB
Radiated Spurious Emissions above 1GHz	23017 (699.70 MHz) 23095 (707.50 MHz) 23173 (715.30 MHz)	1.4 MHz	QPSK	1 RB
	23035 (701.50 MHz) 23095 (707.50 MHz) 23155 (713.50 MHz)	5 MHz	QPSK	1 RB
	23060 (704.00 MHz) 23095 (707.50 MHz) 23130 (711.00 MHz)	10 MHz	QPSK	1 RB

For LTE Band 13

Test Item	Tested Channel	Channel Bandwidth	Modulation	Mode
ERP	23205 (779.50 MHz) 23230 (782.00 MHz) 23255 (784.50 MHz)	5 MHz	QPSK / 16QAM	1 RB Half RB Full RB
	23230 (782.00 MHz)	10 MHz	QPSK / 16QAM	1 RB Half RB Full RB
Modulation Characteristics	23230 (782.00 MHz)	10 MHz	QPSK / 16QAM	Full RB
Frequency Stability	23205 (779.50 MHz) 23255 (784.50 MHz)	5 MHz	QPSK	Full RB
	23230 (782.00 MHz)	10 MHz	QPSK	Full RB
Occupied Bandwidth	23205 (779.50 MHz) 23230 (782.00 MHz) 23255 (784.50 MHz)	5 MHz	QPSK / 16QAM	Full RB
	23230 (782.00 MHz)	10 MHz	QPSK / 16QAM	Full RB
Peak to Average Ratio	23205 (779.50 MHz) 23230 (782.00 MHz) 23255 (784.50 MHz)	5 MHz	QPSK / 16QAM	1 RB
	23230 (782.00 MHz)	10 MHz	QPSK / 16QAM	1 RB
Conducted Emission	23205 (779.50 MHz) 23230 (782.00 MHz) 23255 (784.50 MHz)	5 MHz	QPSK	1 RB Full RB
	23230 (782.00 MHz)	10 MHz	QPSK	1 RB Full RB
Radiated Spurious Emissions below 1GHz	23255 (784.50 MHz)	5 MHz	QPSK	1 RB
Radiated Spurious Emissions above 1GHz	23205 (779.50 MHz) 23230 (782.00 MHz) 23255 (784.50 MHz)	5 MHz	QPSK	1 RB
	23230 (782.00 MHz)	10 MHz	QPSK	1 RB

For LTE Band 17

Test Item	Tested Channel	Channel Bandwidth	Modulation	Mode
ERP	23755 (706.50 MHz) 23790 (710.00 MHz) 23825 (713.50 MHz)	5 MHz	QPSK / 16QAM	1 RB Half RB Full RB
	23780 (709.00 MHz) 23790 (710.00 MHz) 23800 (711.00 MHz)	10 MHz	QPSK / 16QAM	1 RB Half RB Full RB
Modulation Characteristics	23790 (710.00 MHz)	10 MHz	QPSK / 16QAM	Full RB
Frequency Stability	23755 (706.50 MHz) 23825 (713.50 MHz)	5 MHz	QPSK	Full RB
	23780 (709.00 MHz) 23800 (711.00 MHz)	10 MHz	QPSK	Full RB
Occupied Bandwidth	23755 (706.50 MHz) 23790 (710.00 MHz) 23825 (713.50 MHz)	5 MHz	QPSK / 16QAM	Full RB
	23780 (709.00 MHz) 23790 (710.00 MHz) 23800 (711.00 MHz)	10 MHz	QPSK / 16QAM	Full RB
Peak to Average Ratio	23755 (706.50 MHz) 23790 (710.00 MHz) 23825 (713.50 MHz)	5 MHz	QPSK / 16QAM	1 RB
	23780 (709.00 MHz) 23790 (710.00 MHz) 23800 (711.00 MHz)	10 MHz	QPSK / 16QAM	1 RB
Conducted Emission	23755 (706.50 MHz) 23790 (710.00 MHz) 23825 (713.50 MHz)	5 MHz	QPSK	1 RB Full RB
	23780 (709.00 MHz) 23790 (710.00 MHz) 23800 (711.00 MHz)	10 MHz	QPSK	1 RB Full RB
Radiated Spurious Emissions below 1GHz	23755 (706.50 MHz)	5 MHz	QPSK	1 RB
Radiated Spurious Emissions above 1GHz	23755 (706.50 MHz) 23790 (710.00 MHz) 23825 (713.50 MHz)	5 MHz	QPSK	1 RB
	23780 (709.00 MHz) 23790 (710.00 MHz) 23800 (711.00 MHz)	10 MHz	QPSK	1 RB

3.4 Test Program Used and Operation Descriptions

There is no need to controlling software during the test, and the EUT can be paired with the Radio Communication Analyzer to test the connection when it is powered on.

3.5 Connection Diagram of EUT and Peripheral Devices

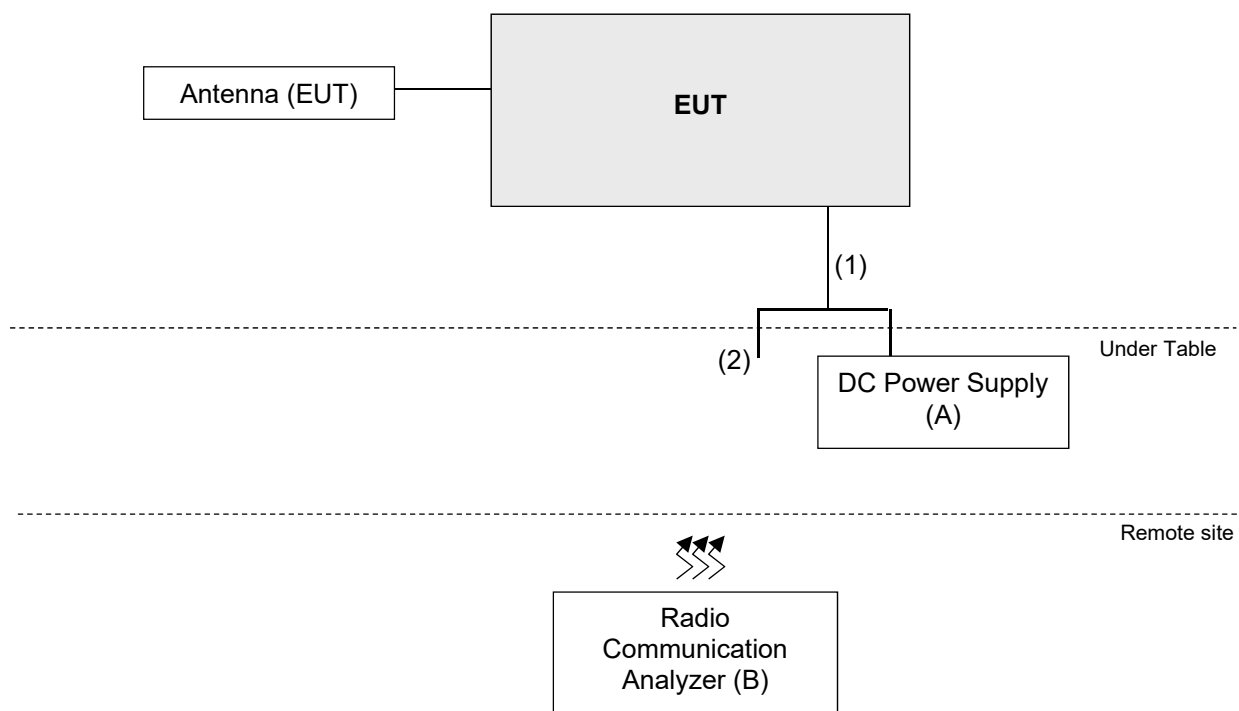

3.6 Configuration of Peripheral Devices and Cable Connections

ID	Product	Brand	Model No.	Serial No.	FCC ID	Remarks
A	DC power supply	JIN YIH Technology	ODP3033	ODP30332128138	N/A	Provided by Lab
B	Radio Communication Analyzer	Anritsu	MT8821C	6201462755	N/A	Provided by Lab

ID	Cable Descriptions	Qty.	Length (m)	Shielding (Yes/No)	Cores (Qty.)	Remarks
1	DC Cable	1	1.5	No	0	Supplied by applicant
2	DC Cable	1	1.5	No	0	Supplied by applicant

4 Test Instruments

The calibration interval of the all test instruments are 12 months and the calibrations are traceable to NML/ROC and NIST/USA.

4.1 Effective Radiated Power and Equivalent Isotropically Radiated Power

Description Manufacturer	Model No.	Serial No.	Calibrated Date	Calibrated Until
N9030B - PXA Signal Analyzer KEYSIGHT	N9030B	MY57140488	2023/3/6	2024/3/5
Radio Communication Analyzer Anritsu	MT8821C	6201462755	2023/3/3	2024/3/2
Software BV	ADT_RF Test Software V6.6.5.4	N/A	N/A	N/A

Notes:

1. The test was performed in Oven room.
2. Tested Date: 2023/7/25 ~ 2023/7/31

4.2 Modulation Characteristics

Description Manufacturer	Model No.	Serial No.	Calibrated Date	Calibrated Until
N9030B - PXA Signal Analyzer KEYSIGHT	N9030B	MY57140938	2023/3/16	2024/3/15
Radio Communication Analyzer Anritsu	MT8821C	6201462755	2023/3/3	2024/3/2
Software BV	ADT_RF Test Software V6.6.5.4	N/A	N/A	N/A

Notes:

1. The test was performed in Oven room.
2. Tested Date: 2023/7/25 ~ 2023/7/31

4.3 Peak to Average Ratio

Refer to section 4.2 to get information of the instruments.

4.4 Bandwidth

Refer to section 4.2 to get information of the instruments.

4.5 Conducted Spurious Emissions

Refer to section 4.2 to get information of the instruments.

4.6 Radiated Spurious Emissions below 1GHz

Description Manufacturer	Model No.	Serial No.	Calibrated Date	Calibrated Until
Antenna Tower Max-Full	MFT-151SS-0.5T	N/A	N/A	N/A
Bi-log Broadband Antenna Schwarzbeck	VULB9168	9168-1213	2022/10/20	2023/10/19
Loop Antenna EMCI	EM-6879	269	2022/9/19	2023/9/18
Loop Antenna TESEQ	HLA 6121	45745	2022/7/27	2023/7/26
Pre-amplifier EMCI	EMC001340	980201	2022/9/23	2023/9/22
Pre_Amplifier EMCI	EMC330N	980782	2023/1/16	2024/1/15
RF Coaxial Cable EMCI	5D-NM-BM	140903+140902	2023/1/7	2024/1/6
	EMCCFD400-NM-NM- 500	201233	2023/1/16	2024/1/15
	EMCCFD400-NM-NM- 3000	201235	2023/1/16	2024/1/15
	EMCCFD400-NM-NM- 9000	201236	2023/1/16	2024/1/15
Software BV ADT	ADT_Radiated_ V7.6.15.9.5	N/A	N/A	N/A
Spectrum Analyzer R&S	FSW43	101866	2023/1/10	2024/1/9
Test Receiver R&S	ESR3+	102782	2022/12/12	2023/12/11
Turn Table Max-Full	MF-7802BS	N/A	N/A	N/A
Turn Table Controller Max-Full	MF-7802BS	MF780208674	N/A	N/A
Radio Communication Analyzer Anritsu	MT8821C	6201462755	2023/3/3	2024/3/2

Notes:

1. The test was performed in WM - 966 chamber 8.
2. Tested Date: 2023/7/25 ~ 2023/7/26

4.7 Radiated Spurious Emissions above 1GHz

Description Manufacturer	Model No.	Serial No.	Calibrated Date	Calibrated Until
Antenna Tower Max-Full	MFT-151SS-0.5T	N/A	N/A	N/A
Horn Antenna RFSPIN	DRH18-E	210103A18E	2022/11/13	2023/11/12
Horn Antenna Schwarzbeck	BBHA 9170	9170-1049	2022/11/13	2023/11/12
Pre_Amplifier EMCI	EMC118A45SE	980808	2022/12/29	2023/12/28
	EMC184045SE	980788	2023/1/16	2024/1/15
RF Coaxial Cable EMCI	EMC101G-KM-KM-2000	201254	2023/1/16	2024/1/15
	EMC101G-KM-KM-3000	201257	2023/1/16	2024/1/15
	EMC101G-KM-KM-5000	201260	2023/1/16	2024/1/15
	EMC104-SM-SM-1000	210102	2023/1/16	2024/1/15
	EMC104-SM-SM-3000	201231	2023/1/16	2024/1/15
	EMC104-SM-SM-9000	201243	2023/1/16	2024/1/15
Software BV ADT	ADT_Radiated_ V7.6.15.9.5	N/A	N/A	N/A
Spectrum Analyzer R&S	FSW43	101866	2023/1/10	2024/1/9
Test Receiver R&S	ESR3+	102782	2022/12/12	2023/12/11
Turn Table Max-Full	MF-7802BS	N/A	N/A	N/A
Turn Table Controller Max-Full	MF-7802BS	MF780208674	N/A	N/A
Radio Communication Analyzer Anritsu	MT8821C	6201462755	2023/3/3	2024/3/2

Notes:

1. The test was performed in WM - 966 chamber 8.
2. Tested Date: 2023/7/24 ~ 2023/7/26

4.8 Frequency Stability

Description Manufacturer	Model No.	Serial No.	Calibrated Date	Calibrated Until
3-channel DC power supply JIN YIH Technology	ODP3033	ODP30332128138	N/A	N/A
Digital Multimeter Fluke	87-III	70360742	2023/7/6	2024/7/5
Software BV	ADT_RF Test Software V6.6.5.4	N/A	N/A	N/A
Spectrum Analyzer R&S	FSV40	100980	2023/5/3	2024/5/2
Temperature & Humidity Chamber TERCHY	HRM-120RF	931022	2022/12/27	2023/12/26
Radio Communication Analyzer Anritsu	MT8821C	6201462755	2023/3/3	2024/3/2

Notes:

1. The test was performed in Oven room.
2. Tested Date: 2023/8/1

5 Limits of Test Items

5.1 Effective Radiated Power and Equivalent Isotropically Radiated Power

For GSM1900, WCDMA Band 2, LTE Band 2:

Mobile and portable stations are limited to 2 watts EIRP.

For WCDMA Band 4, LTE Band 4:

Fixed, mobile, and portable (hand-held) stations operating in the 1710-1755 MHz band and mobile and portable stations operating in the 1695-1710 MHz and 1755-1780 MHz bands are limited to 1 watt EIRP.

For GSM850, WCDMA Band 5, LTE Band 5:

The ERP of mobile transmitters and auxiliary test transmitters must not exceed 7 watts.

For LTE Band 7:

Mobile stations are limited to 2.0 watts EIRP. All user stations are limited to 2.0 watts transmitter output power.

For LTE Band 12, LTE Band 17:

Portable stations (hand-held devices) in the 600 MHz uplink band and the 698-746 MHz band, and fixed and mobile stations in the 600 MHz uplink band are limited to 3 watts ERP.

For LTE Band 13:

Portable stations (hand-held devices) transmitting in the 746-757 MHz, 776-788 MHz, and 805-806 MHz bands are limited to 3 watts ERP.

5.2 Modulation Characteristics

A curve or equivalent data which shows that the equipment will meet the modulation requirements of the rules under which the equipment is to be licensed.

5.3 Peak to Average Ratio

In measuring transmissions in this band using an average power technique, the peak to-average ratio (PAR) of the transmission may not exceed 13 dB.

5.4 Bandwidth

According to FCC 47 CFR part 2.1049, the occupied bandwidth, that is the frequency bandwidth such that, below its lower and above its upper frequency limits, the mean powers radiated are each equal to 0.5% of the total mean power radiated by a given emission.

5.5 Conducted Spurious Emissions

For GSM850, GSM1900, WCDMA Band 2, WCDMA Band 5, LTE Band 2, LTE Band 5:

The power of any emission outside of the authorized operating frequency ranges must be attenuated below the transmitting power (P) by a factor of at least $43 + 10 \log(P)$ dB. The emission limit equal to -13 dBm.

For WCDMA Band 4, LTE Band 4:

According to FCC 47 CFR part 27.53(h), for operations in the 1695-1710 MHz, 1710-1755 MHz, 1755-1780 MHz, 1915-1920 MHz, 1995-2000 MHz, 2000-2020 MHz, 2110-2155 MHz, 2155-2180 MHz, and 2180-2200 MHz bands, the power of any emission outside a licensee's frequency block shall be attenuated below the transmitter power (P) in watts by at least $43 + 10 \log(P)$ dB. However, in the 1 megahertz bands immediately outside and adjacent to the licensee's frequency block, a resolution bandwidth of at least one percent of the emission bandwidth of the fundamental emission of the transmitter may be employed.

For LTE Band 7:

According to FCC 47 CFR part 27.53(m)(4) regulations, any transmit power outside of the channel edge must be attenuated below the transmitting power (P) by a factor shall be not less than $40 + 10 \log(P)$ dB on all frequencies between the channel edge and 5 megahertz from the channel edge, $43 + 10 \log(P)$ dB on all frequencies between 5 megahertz and X megahertz from the channel edge, and $55 + 10 \log(P)$ dB on all frequencies more than X megahertz from the channel edge, where X is the greater of 6 megahertz or the actual emission bandwidth. In addition, the attenuation factor shall not be less that $43 + 10 \log(P)$ dB on all frequencies between 2490.5 MHz and 2496 MHz and $55 + 10 \log(P)$ dB at or below 2490.5 MHz. In the 1 MHz bands immediately outside and adjacent to the frequency block a resolution bandwidth of at least two percent may be employed, except when the 1 megahertz band is 2495-2496 MHz, in which case a resolution bandwidth of at least one percent may be employed.

For LTE Band 12, LTE Band 17:

According to FCC 47 CFR part 27.53(g), for operations in the 600 MHz band and the 698-746 MHz band, the power of any emission outside a licensee's frequency band(s) of operation shall be attenuated below the transmitter power (P) within the licensed band(s) of operation, measured in watts, by at least $43 + 10 \log(P)$ dB. Compliance with this provision is based on the use of measurement instrumentation employing a resolution bandwidth of 100 kilohertz or greater. However, in the 100 kilohertz bands immediately outside and adjacent to a licensee's frequency block, a resolution bandwidth of at least 30 kHz may be employed.

For LTE Band 13:

According to FCC 47 CFR part 27.53(c)(2), for on any frequency outside the 776-788 MHz band, the power of any emission shall be attenuated outside the band below the transmitter power (P) by at least $43 + 10 \log(P)$ dB. Compliance with this provision is based on the use of measurement instrumentation employing a resolution bandwidth of 100 kilohertz or greater. However, in the 100 kilohertz bands immediately outside and adjacent to a licensee's frequency block, a resolution bandwidth of at least 30 kHz may be employed.

According to FCC 47 CFR part 27.53(c)(4) On all frequencies between 763-775 MHz and 793-805 MHz, by a factor not less than $65 + 10 \log(P)$ dB in a 6.25 kHz band segment, for mobile and portable stations.

For operations in the 775-788 MHz, emissions in the band 1559-1610 MHz shall be limited to -70 dBW/MHz (EIRP). The limit of emissions is equal to -40 dBm.

5.6 Radiated Spurious Emissions below 1GHz

For GSM850, GSM1900, WCDMA Band 2, WCDMA Band 5, LTE Band 2, LTE Band 5:

The power of any emission outside of the authorized operating frequency ranges must be attenuated below the transmitting power (P) by a factor of at least $43 + 10 \log(P)$ dB. The emission limit equal to -13 dBm.

For WCDMA Band 4, LTE Band 4:

According to FCC 47 CFR part 27.53(h), for operations in the 1695-1710 MHz, 1710-1755 MHz, 1755-1780 MHz bands, the power of any emission outside a licensee's frequency block shall be attenuated below the transmitter power (P) in watts by at least $43 + 10 \log(P)$ dB. The limit of emission is equal to -13 dBm.

For LTE Band 7:

According to FCC 47 CFR part 27.53(m)(4), on any frequency outside a licensee's frequency block, The power of any emission shall be attenuated below the transmitter power (P) by at least $55 + 10 \log(P)$ dB. The emission limit equal to -25 dBm.

For LTE Band 12, LTE Band 17:

According to FCC 47 CFR part 27.53(g), for operations in the 600 MHz band and the 698-746 MHz band, the power of any emission outside a licensee's frequency band(s) of operation shall be attenuated below the transmitter power (P) within the licensed band(s) of operation, measured in watts, by at least $43 + 10 \log(P)$ dB. The limit of emissions is equal to -13 dBm.

For LTE Band 13:

According to FCC 47 CFR part 27.53(c)(2), for on any frequency outside the 776-788 MHz band, the power of any emission shall be attenuated outside the band below the transmitter power (P) by at least $43 + 10 \log(P)$ dB. The limit of emissions is equal to -13 dBm.

For operations in the 775-788 MHz, emissions in the band 1559-1610 MHz shall be limited to -70 dBW/MHz (EIRP). The limit of emissions is equal to -40 dBm.

5.7 Radiated Spurious Emissions above 1GHz

For GSM850, GSM1900, WCDMA Band 2, WCDMA Band 5, LTE Band 2, LTE Band 5:

The power of any emission outside of the authorized operating frequency ranges must be attenuated below the transmitting power (P) by a factor of at least $43 + 10 \log(P)$ dB. The emission limit equal to -13 dBm.

For WCDMA Band 4, LTE Band 4:

According to FCC 47 CFR part 27.53(h), for operations in the 1695-1710 MHz, 1710-1755 MHz, 1755-1780 MHz bands, the power of any emission outside a licensee's frequency block shall be attenuated below the transmitter power (P) in watts by at least $43 + 10 \log(P)$ dB. The limit of emission is equal to -13 dBm.

For LTE Band 7:

According to FCC 47 CFR part 27.53(m)(4), on any frequency outside a licensee's frequency block, The power of any emission shall be attenuated below the transmitter power (P) by at least $55 + 10 \log(P)$ dB. The emission limit equal to -25 dBm.

For LTE Band 12, LTE Band 17:

According to FCC 47 CFR part 27.53(g), for operations in the 600 MHz band and the 698-746 MHz band, the power of any emission outside a licensee's frequency band(s) of operation shall be attenuated below the transmitter power (P) within the licensed band(s) of operation, measured in watts, by at least $43 + 10 \log(P)$ dB. The limit of emissions is equal to -13 dBm.

For LTE Band 13:

According to FCC 47 CFR part 27.53(c)(2), for on any frequency outside the 776-788 MHz band, the power of any emission shall be attenuated outside the band below the transmitter power (P) by at least $43 + 10 \log(P)$ dB. The limit of emissions is equal to -13 dBm.

For operations in the 775-788 MHz, emissions in the band 1559-1610 MHz shall be limited to -70 dBW/MHz (EIRP). The limit of emissions is equal to -40 dBm.

5.8 Frequency Stability

For GSM850, WCDMA Band 5, LTE Band 5:

1.5 ppm is for base and fixed station. 2.5 ppm is for mobile station.

For GSM1900, WCDMA Band 2, WCDMA Band 4, LTE Band 2, LTE Band 4, LTE Band 7, LTE Band 12, LTE Band 13, LTE Band 17:

The frequency stability shall be sufficient to ensure that the fundamental emissions stay within the authorized bands of operation (authorized frequency block).

6 Test Arrangements

6.1 Effective Radiated Power and Equivalent Isotropically Radiated Power

6.1.1 Test Setup

Conducted Power Measurement:

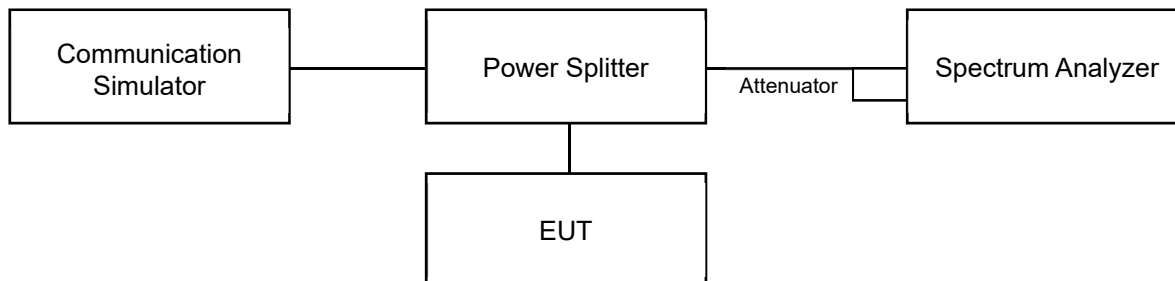

6.1.2 Test Procedure

Conducted Power Measurement:

The EUT is configured by emulator to set data modulation and maximum power using WWAN technology. The average (rms) power measurement was performed on emulator and power value was measured from power function on emulator. Set the EUT to transmit under low, middle and high channel and record the power level shown on simulator.

Maximum EIRP / ERP

The relevant equation for determining the maximum ERP or EIRP from the measured RF output power is given in Equation as follows:

$$\text{EIRP} = P_{\text{Meas}} + G_{\text{T}}$$

$$\text{ERP} = P_{\text{Meas}} + G_{\text{T}} - 2.15$$

where

ERP or EIRP effective radiated power or equivalent isotropically radiated power, respectively

(expressed in the same units as P_{Meas} , e.g., dBm or dBW)

P_{Meas} measured transmitter output power or PSD, in dBm or dBW

G_{T} gain of the transmitting antenna, in dBd (ERP) or dBi (EIRP)

6.2 Modulation Characteristics

6.2.1 Test Setup

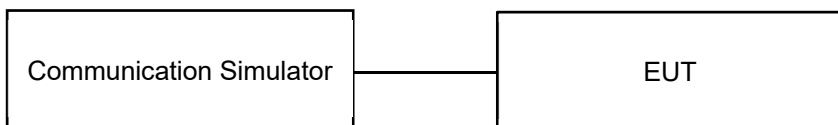

6.2.2 Test Procedure

Connect the EUT to Communication Simulator via the antenna connector, the frequency band is set as EUT supported Modulation and Channels, the EUT output is matched with 50 ohm load, the waveform quality and constellation of the EUT was tested.

6.3 Peak to Average Ratio

6.3.1 Test Setup

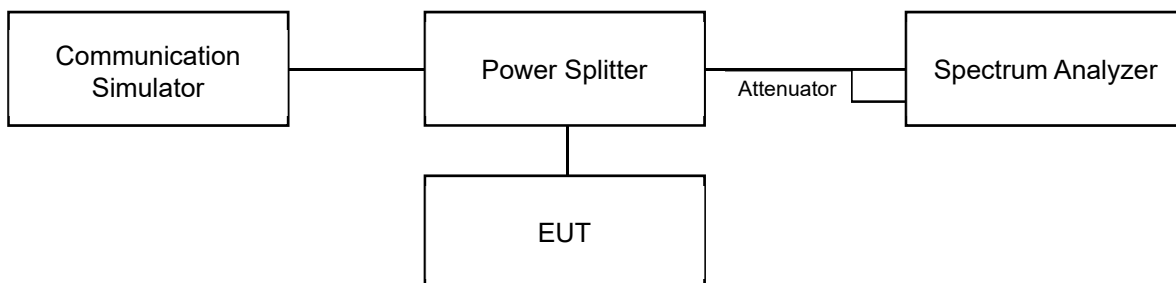

6.3.2 Test Procedure

- a. Set resolution/measurement bandwidth \geq signal's occupied bandwidth;
- b. Set the number of counts to a value that stabilizes the measured CCDF curve;
- c. Record the maximum PAPR level associated with a probability of 0.1%.

6.4 Bandwidth

6.4.1 Test Setup

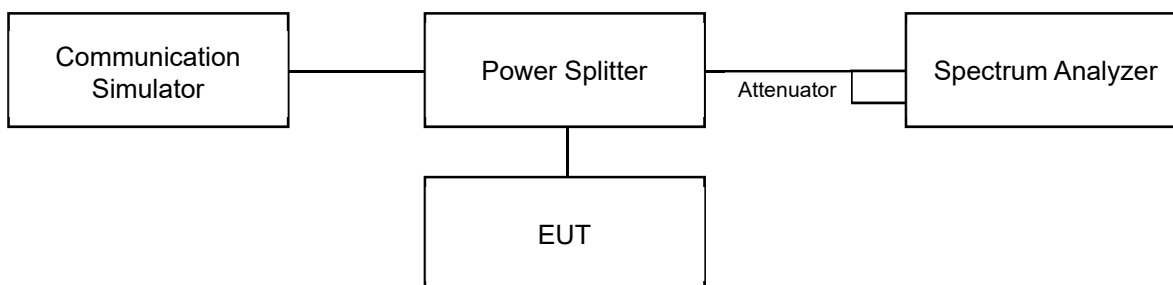

6.4.2 Test Procedure

For the 26 dBc bandwidth measurement method, please refer to section 5.4.3 of ANSI C63.26.

- a. The spectrum analyzer center frequency is set to the nominal EUT channel center frequency. The span range for the spectrum analyzer shall be wide enough to see sufficient roll off of the signal to make the measurement.
- b. The nominal RBW shall be in the range of 1% to 5% of the anticipated OBW, and the VBW shall be set $\geq 3 \times$ RBW.
- c. Set the reference level of the instrument as required to prevent the signal amplitude from exceeding the maximum spectrum analyzer input mixer level for linear operation. See guidance provided in 4.2.3.
- d. The dynamic range of the spectrum analyzer at the selected RBW shall be more than 10 dB below the target “-X dB” requirement, i.e., if the requirement calls for measuring the -26 dB OBW, the spectrum analyzer noise floor at the selected RBW shall be at least 36 dB below the reference level.
- e. Set spectrum analyzer detection mode to peak, and the trace mode to max hold.
- f. Determine the following reference values: Set the EUT to transmit a modulated signal. Allow the trace to stabilize. Set the spectrum analyzer marker to the highest level of the displayed trace (this is the reference value).
- g. Determine the “-X dB amplitude” as equal to (Reference Value - X). Alternatively, this calculation can be performed on the spectrum analyzer using the delta-marker measurement function.
- h. Place two markers, one at the lowest and the other at the highest frequency of the envelope of the spectral display such that each marker is at or slightly below the “-X dB amplitude” determined in step f). If a marker is below this “-X dB amplitude” value it should be as close as possible to this value. The OBW is the positive frequency difference between the two markers.
- i. The OBW shall be reported by providing plot(s) of the measuring instrument display, to include markers depicting the relevant frequency and amplitude information (e.g., marker table). The frequency and amplitude axis and scale shall be clearly labeled. Tabular data may be reported in addition to the plot(s).

For the occupied bandwidth measurement method, please refer to section 5.4.4 of ANSI C63.26.

- a. The spectrum analyzer center frequency is set to the nominal EUT channel center frequency. The span range for the spectrum analyzer shall be wide enough to see sufficient roll off of the signal to make the measurement.
- b. The nominal RBW shall be in the range of 1% to 5% of the anticipated OBW, and the VBW shall be set $\geq 3 \times$ RBW.
- c. Set the reference level of the instrument as required to prevent the signal amplitude from exceeding the maximum spectrum analyzer input mixer level for linear operation. See guidance provided in 4.2.3.
- d. The dynamic range of the spectrum analyzer at the selected RBW shall be more than 10 dB below the target “-X dB” requirement, i.e., if the requirement calls for measuring the -26 dB OBW, the spectrum analyzer noise floor at the selected RBW shall be at least 36 dB below the reference level.
- e. Set spectrum analyzer detection mode to peak, and the trace mode to max hold.
- f. Determine the reference value by either of the following:
 - g. 1) Set the EUT to transmit a modulated signal. Allow the trace to stabilize. Set the spectrum analyzer marker to the highest level of the displayed trace (this is the reference value).
 - h. 2) Set the EUT to transmit an unmodulated carrier. Set the spectrum analyzer marker to the level of the carrier.
- i. Determine the “-X dB amplitude” as equal to (Reference Value - X). Alternatively, this calculation can be performed on the spectrum analyzer using the delta-marker measurement function.
- j. If the reference value was determined using an unmodulated carrier, turn the EUT modulation on, then either clear the existing trace or start a new trace on the spectrum analyzer and allow the new trace to stabilize. Otherwise the trace from step f) shall be used for step i).
- k. Place two markers, one at the lowest and the other at the highest frequency of the envelope of the spectral display such that each marker is at or slightly below the “-X dB amplitude” determined in step f). If a marker is below this “-X dB amplitude” value it should be as close as possible to this value. The OBW is the positive frequency difference between the two markers. The spectral envelope can cross the “-X dB amplitude” at multiple points. The lowest or highest frequency shall be selected as the frequencies that are the farthest away from the center frequency at which the spectral envelope crosses the “-X dB amplitude.”
- l. The OBW shall be reported by providing plot(s) of the measuring instrument display, to include markers depicting the relevant frequency and amplitude information (e.g., marker table). The frequency and amplitude axis and scale shall be clearly labeled. Tabular data may be reported in addition to the plot(s).

6.5 Conducted Spurious Emissions

6.5.1 Test Setup

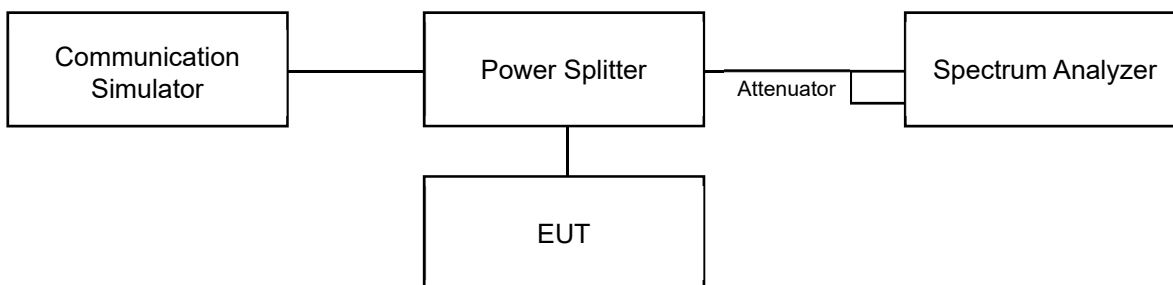

6.5.2 Test Procedure

- a. Measurement refer to ANSI C63.26 section 5.7.
- b. All measurements were done at 3 channels: low, middle and high operational frequency range.
- c. Measuring frequency range is from 9 kHz up to the tenth harmonic of the highest fundamental frequency or to 40 GHz, whichever is lower. 20 dB attenuation pad is connected with spectrum.
- d. The fundamental frequency above 1 GHz, the spectrum set RBW = 1 MHz, VBW = 3 MHz, Detector = Average.
- e. The fundamental frequency below 1 GHz, the spectrum set RBW \geq 100 kHz, VBW \geq 3 x RBW, Detector = Average.
- f. Measuring frequency band edge, narrow RBW (no less than 1% of the OBW) is used for conducted emission measurement.

6.6 Radiated Spurious Emissions below 1GHz

6.6.1 Test Setup

For radiated emission 30 MHz to 1 GHz

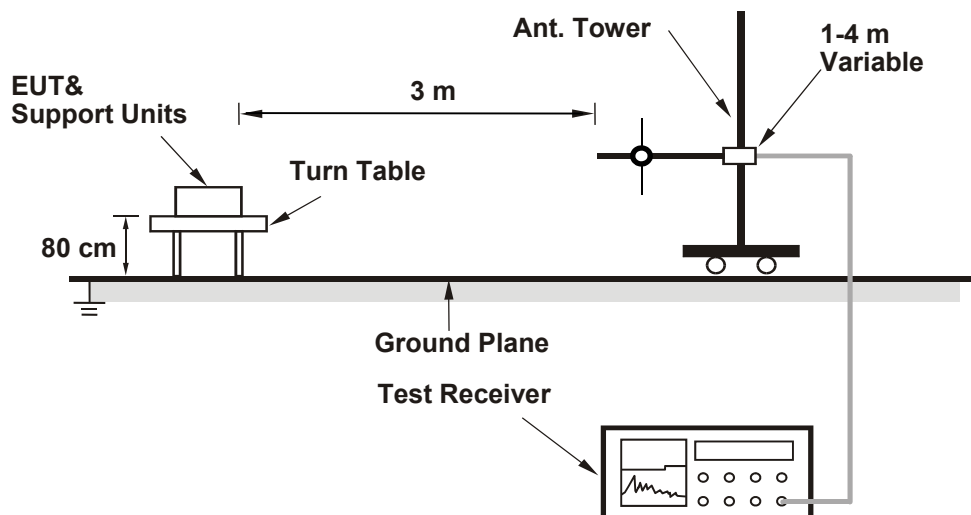

For the actual test configuration, please refer to the attached file (Test Setup Photo).

6.6.2 Test Procedure

The EUT is configured by emulator to set data modulation and maximum power using WWAN technology.

- In the semi-anechoic chamber, EUT placed on the 0.8 m (below or equal 1 GHz) height of turn table, rotated the table around 360 degrees to search the maximum radiation power and receiver antenna shall be rotated vertical and horizontal polarization and moved height from 1 m to 4 m to find the maximum polar radiated power. The "Read Value" is the spectrum reading the maximum power value.
- The height of antenna is varied from one meter to four meters above the ground to determine the maximum value of the field strength. Both horizontal and vertical polarizations of the antenna are set to make the measurement.
- Perform a field strength measurement and record the worse read value, is the field strength value via a spectrum reading obtained corrected for antenna factor, cable loss and pre-amplifier factor and then mathematically convert the measured field strength level to EIRP/ERP level.
- Following C63.26 section 5.5 and 5.2.7
- $EIRP (dBm) = E (dB\mu V/m) + 20\log(D) - 104.8$; where D is the measurement distance (in the far field region) in m.
- $ERP (dBm) = E (dB\mu V/m) + 20\log(D) - 104.8 - 2.15$; where D is the measurement distance (in the far field region) in m.

Note:

- The resolution bandwidth and video bandwidth of test receiver/spectrum analyzer is 1 MHz/3 MHz.
- The emission levels were against the limit of frequency range 9 kHz ~ 30 MHz:
The amplitude of spurious emissions attenuated more than 20 dB below the permissible value is not required to be report.

6.7 Radiated Spurious Emissions above 1GHz

6.7.1 Test Setup

For radiated emission above 1 GHz

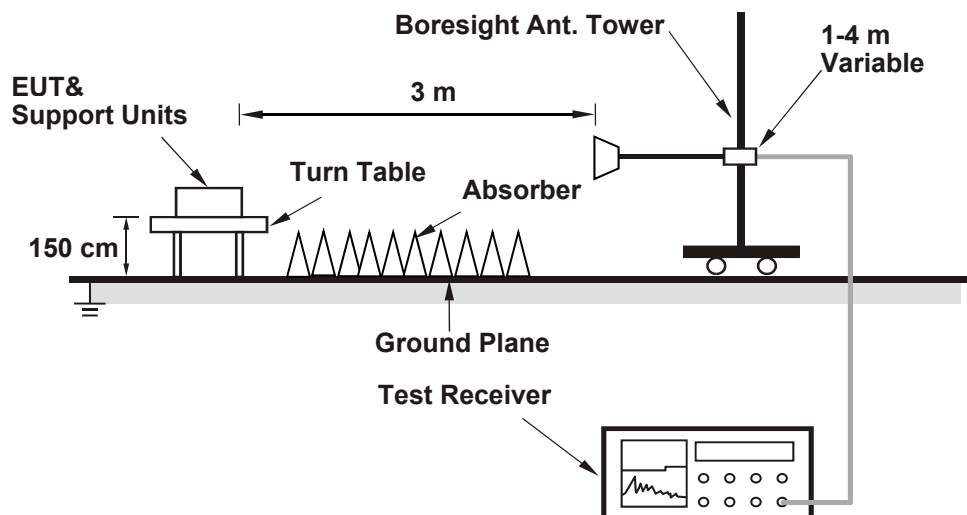

For the actual test configuration, please refer to the attached file (Test Setup Photo).

6.7.2 Test Procedure

The EUT is configured by emulator to set data modulation and maximum power using WWAN technology.

- In the semi-anechoic chamber, EUT placed on the 1.5 m height of turn table, rotated the table around 360 degrees to search the maximum radiation power and receiver antenna shall be rotated vertical and horizontal polarization and moved height from 1 m to 4 m to find the maximum polar radiated power. The "Read Value" is the spectrum reading the maximum power value.
- The height of antenna is varied from one meter to four meters above the ground to determine the maximum value of the field strength. Both horizontal and vertical polarizations of the antenna are set to make the measurement.
- Perform a field strength measurement and record the worse read value, is the field strength value via a spectrum reading obtained corrected for antenna factor, cable loss and pre-amplifier factor and then mathematically convert the measured field strength level to EIRP/ERP level.
- Following C63.26 section 5.5 and 5.2.7
- $EIRP (dBm) = E (dB\mu V/m) + 20\log(D) - 104.8$; where D is the measurement distance (in the far field region) in m.
- $ERP (dBm) = E (dB\mu V/m) + 20\log(D) - 104.8 - 2.15$; where D is the measurement distance (in the far field region) in m.

Note:

- The resolution bandwidth and video bandwidth of test receiver/spectrum analyzer is 1 MHz/3 MHz.

6.8 Frequency Stability

6.8.1 Test Setup

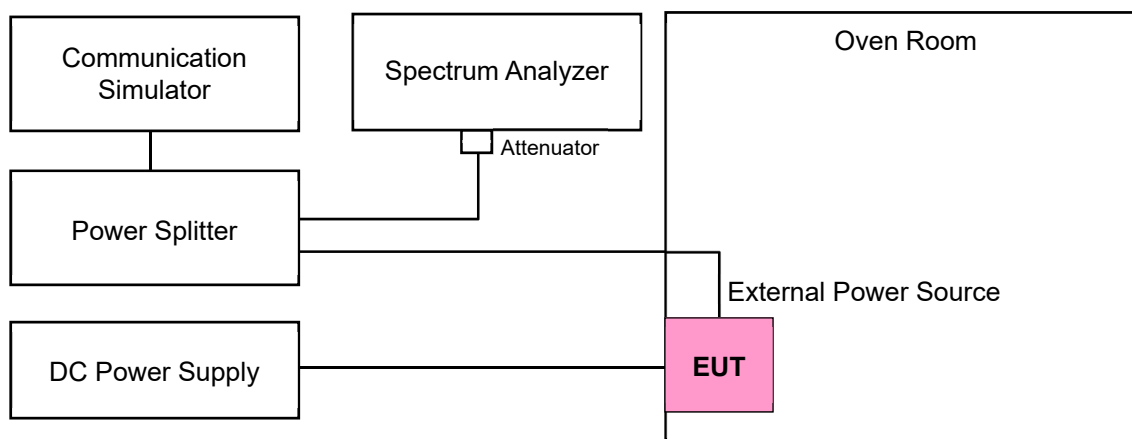

6.8.2 Test Procedure

The EUT is configured by emulator to set data modulation and maximum power using WWAN technology.

- Device is placed at the oven room. The oven room could control the temperatures and humidity. Power warm up is at least 15 min and power applied should perform before recording frequency error.
- EUT is connected the external power supply to control the DC input power. The test voltage range is from minimum to maximum working voltage. Each step shall be record the frequency error rate.
- The temperature range step is 10 degrees in this test items. All temperature levels shall be hold the $\pm 0.5^{\circ}\text{C}$ during the measurement testing. The each temperature step shall be at least 0.5 hours, consider the EUT could be test under the stability condition.

Note: The frequency error was recorded frequency error from the communication simulator.

7 Test Results of Test Item

7.1 Effective Radiated Power and Equivalent Isotropically Radiated Power

Input Power:	3.8 Vdc	Environmental Conditions:	22°C, 65% RH	Tested By:	Willy Cheng
--------------	---------	---------------------------	--------------	------------	-------------

7.1.1 GSM850

Conducted Output Power (dBm)

Band	GSM850		
Channel	128	189	251
Frequency (MHz)	824.2	836.4	848.8
GPRS	33.18	33.09	33.16
EDGE	33.15	33.02	33.06

ERP Power (dBm)

Band	GSM850		
Channel	128	189	251
Frequency (MHz)	824.2	836.4	848.8
GPRS	33.03	32.94	33.01
EDGE	33.00	32.87	32.91

*ERP (dBm) = Conducted Output Power (dBm) + Antenna Gain (dBi) - 2.15

7.1.2 GSM1900

Conducted Output Power (dBm)

Band	GSM1900		
Channel	512	661	810
Frequency (MHz)	1850.2	1880	1909.8
GPRS	30.02	30.19	30.03
EDGE	30.15	30.12	30.00

EIRP Power (dBm)

Band	GSM1900		
Channel	512	661	810
Frequency (MHz)	1850.2	1880	1909.8
GPRS	32.02	32.19	32.03
EDGE	32.15	32.12	32.00

*EIRP (dBm) = Conducted Output Power (dBm) + Antenna Gain (dBi)

7.1.3 WCDMA Band 2

Conducted Output Power (dBm)

Band	WCDMA II		
TX Channel	9262	9400	9538
Rx Channel	9662	9800	9938
Frequency	1852.4	1880	1907.6
RMC 12.2K	23.13	23.20	23.15
HSDPA	22.10	22.20	22.22
HSUPA	21.99	21.28	21.33

EIRP Power (dBm)

Band	WCDMA II		
TX Channel	9262	9400	9538
Rx Channel	9662	9800	9938
Frequency	1852.4	1880	1907.6
RMC 12.2K	25.13	25.20	25.15
HSDPA	24.10	24.20	24.22
HSUPA	23.99	23.28	23.33

*EIRP (dBm) = Conducted Output Power (dBm) + Antenna Gain (dBi)

7.1.4 WCDMA Band 4

Conducted Output Power (dBm)

Band	WCDMA IV		
TX Channel	1312	1413	1513
Rx Channel	1537	1638	1738
Frequency	1712.4	1732.6	1752.6
RMC 12.2K	23.10	23.12	23.21
HSDPA	22.79	22.15	22.94
HSUPA	21.23	21.11	21.40

EIRP Power (dBm)

Band	WCDMA IV		
TX Channel	1312	1413	1513
Rx Channel	1537	1638	1738
Frequency	1712.4	1732.6	1752.6
RMC 12.2K	25.10	25.12	25.21
HSDPA	24.79	24.15	24.94
HSUPA	23.23	23.11	23.40

*EIRP (dBm) = Conducted Output Power (dBm) + Antenna Gain (dBi)

7.1.5 WCDMA Band 5

Conducted Output Power (dBm)

Band	WCDMA V		
TX Channel	4132	4182	4233
Rx Channel	4357	4407	4458
Frequency	826.4	836.4	846.6
RMC 12.2K	23.65	23.65	23.60
HSDPA	22.69	22.77	22.60
HSUPA	22.48	22.66	22.29

ERP Power (dBm)

Band	WCDMA V		
TX Channel	4132	4182	4233
Rx Channel	4357	4407	4458
Frequency	826.4	836.4	846.6
RMC 12.2K	23.50	23.50	23.45
HSDPA	22.54	22.62	22.45
HSUPA	22.33	22.51	22.14

*ERP (dBm) = Conducted Output Power (dBm) + Antenna Gain (dBi) - 2.15

7.1.6 LTE Band 2

Conducted Output Power (dBm)

LTE Band 2						
BW	MCS Index	RB Size	RB Offset	Low	Mid	High
		Channel		18700	18900	19100
		Frequency (MHz)		1860	1880	1900
20M	QPSK	1	0	22.77	22.89	22.78
		1	50	22.99	23.10	22.99
		1	99	22.89	23.03	22.90
		50	0	21.86	22.00	21.85
		50	25	21.86	21.99	21.86
		50	50	21.80	21.92	21.80
		100	0	21.74	21.88	21.73
20M	16QAM	1	0	21.71	21.81	21.78
		1	50	21.89	22.09	21.95
		1	99	21.85	21.93	21.89
		50	0	20.82	20.91	20.78
		50	25	20.81	20.95	20.83
		50	50	20.79	20.89	20.74
		100	0	20.70	20.86	20.72

LTE Band 2						
BW	MCS Index	RB Size	RB Offset	Low	Mid	High
		Channel		18675	18900	19125
		Frequency (MHz)		1857.5	1880	1902.5
15M	QPSK	1	0	22.94	23.05	22.90
		1	37	22.88	23.01	22.89
		1	74	22.86	22.97	22.85
		36	0	21.99	22.10	21.99
		36	19	21.98	22.11	21.96
		36	39	21.90	22.03	21.88
		75	0	21.83	21.96	21.81
15M	16QAM	1	0	21.92	21.95	21.88
		1	37	21.81	21.92	21.83
		1	74	21.81	21.87	21.78
		36	0	20.94	21.03	20.99
		36	19	20.98	21.11	20.96
		36	39	20.84	21.02	20.88
		75	0	20.81	20.91	20.74



LTE Band 2						
BW	MCS Index	RB Size	RB Offset	Low	Mid	High
		Channel		18650	18900	19150
		Frequency (MHz)		1855	1880	1905
10M	QPSK	1	0	22.78	22.89	22.78
		1	24	22.91	23.02	22.91
		1	49	22.68	22.80	22.69
		25	0	21.92	22.04	21.89
		25	12	21.91	22.06	21.94
		25	25	21.79	21.90	21.76
		50	0	21.83	21.98	21.83
10M	16QAM	1	0	21.70	21.87	21.72
		1	24	21.85	22.02	21.83
		1	49	21.65	21.79	21.66
		25	0	20.91	21.00	20.87
		25	12	20.85	20.98	20.93
		25	25	20.70	20.89	20.72
		50	0	20.74	20.91	20.80

LTE Band 2						
BW	MCS Index	RB Size	RB Offset	Low	Mid	High
		Channel		18625	18900	19175
		Frequency (MHz)		1852.5	1880	1907.5
5M	QPSK	1	0	22.75	22.87	22.72
		1	12	22.75	22.89	22.78
		1	24	22.86	23.01	22.86
		12	0	21.92	22.03	21.91
		12	6	21.96	22.10	21.99
		12	13	21.93	22.05	21.91
		25	0	21.92	22.03	21.92
5M	16QAM	1	0	21.75	21.78	21.70
		1	12	21.73	21.86	21.73
		1	24	21.76	21.92	21.85
		12	0	20.92	21.01	20.83
		12	6	20.92	21.06	20.93
		12	13	20.86	21.04	20.82
		25	0	20.89	20.99	20.82



LTE Band 2						
BW	MCS Index	RB Size	RB Offset	Low	Mid	High
		Channel		18615	18900	19185
		Frequency (MHz)		1851.5	1880	1908.5
3M	QPSK	1	0	22.75	22.90	22.75
		1	7	22.79	22.93	22.81
		1	14	22.72	22.85	22.70
		8	0	21.90	22.01	21.89
		8	3	21.76	21.89	21.75
		8	7	21.83	21.98	21.85
		15	0	21.86	21.99	21.85
3M	16QAM	1	0	21.73	21.86	21.75
		1	7	21.74	21.87	21.73
		1	14	21.69	21.76	21.61
		8	0	20.88	20.96	20.80
		8	3	20.76	20.88	20.71
		8	7	20.80	20.95	20.76
		15	0	20.76	20.97	20.81

LTE Band 2						
BW	MCS Index	RB Size	RB Offset	Low	Mid	High
		Channel		18607	18900	19193
		Frequency (MHz)		1850.7	1880	1909.3
1.4M	QPSK	1	0	22.87	23.00	22.89
		1	2	22.86	22.98	22.84
		1	5	22.86	22.99	22.88
		3	0	22.74	22.89	22.74
		3	1	22.71	22.83	22.72
		3	3	22.72	22.86	22.74
		6	0	21.86	22.01	21.86
1.4M	16QAM	1	0	21.86	21.90	21.79
		1	2	21.84	21.96	21.82
		1	5	21.79	21.99	21.83
		3	0	21.67	21.87	21.71
		3	1	21.69	21.78	21.62
		3	3	21.62	21.84	21.70
		6	0	20.77	20.98	20.76

EIRP Power (dBm)

LTE Band 2						
BW	MCS Index	RB Size	RB Offset	Low	Mid	High
		Channel		18700	18900	19100
		Frequency (MHz)		1860	1880	1900
20M	QPSK	1	0	24.77	24.89	24.78
		1	50	24.99	25.10	24.99
		1	99	24.89	25.03	24.90
		50	0	23.86	24.00	23.85
		50	25	23.86	23.99	23.86
		50	50	23.80	23.92	23.80
		100	0	23.74	23.88	23.73
20M	16QAM	1	0	23.71	23.81	23.78
		1	50	23.89	24.09	23.95
		1	99	23.85	23.93	23.89
		50	0	22.82	22.91	22.78
		50	25	22.81	22.95	22.83
		50	50	22.79	22.89	22.74
		100	0	22.70	22.86	22.72

*EIRP (dBm) = Conducted Output Power (dBm) + Antenna Gain (dBi)

LTE Band 2						
BW	MCS Index	RB Size	RB Offset	Low	Mid	High
		Channel		18675	18900	19125
		Frequency (MHz)		1857.5	1880	1902.5
15M	QPSK	1	0	24.94	25.05	24.90
		1	37	24.88	25.01	24.89
		1	74	24.86	24.97	24.85
		36	0	23.99	24.10	23.99
		36	19	23.98	24.11	23.96
		36	39	23.90	24.03	23.88
		75	0	23.83	23.96	23.81
15M	16QAM	1	0	23.92	23.95	23.88
		1	37	23.81	23.92	23.83
		1	74	23.81	23.87	23.78
		36	0	22.94	23.03	22.99
		36	19	22.98	23.11	22.96
		36	39	22.84	23.02	22.88
		75	0	22.81	22.91	22.74

*EIRP (dBm) = Conducted Output Power (dBm) + Antenna Gain (dBi)



LTE Band 2						
BW	MCS Index	RB Size	RB Offset	Low	Mid	High
		Channel		18650	18900	19150
		Frequency (MHz)		1855	1880	1905
10M	QPSK	1	0	24.78	24.89	24.78
		1	24	24.91	25.02	24.91
		1	49	24.68	24.80	24.69
		25	0	23.92	24.04	23.89
		25	12	23.91	24.06	23.94
		25	25	23.79	23.90	23.76
		50	0	23.83	23.98	23.83
10M	16QAM	1	0	23.70	23.87	23.72
		1	24	23.85	24.02	23.83
		1	49	23.65	23.79	23.66
		25	0	22.91	23.00	22.87
		25	12	22.85	22.98	22.93
		25	25	22.70	22.89	22.72
		50	0	22.74	22.91	22.80

*EIRP (dBm) = Conducted Output Power (dBm) + Antenna Gain (dBi)

LTE Band 2						
BW	MCS Index	RB Size	RB Offset	Low	Mid	High
		Channel		18625	18900	19175
		Frequency (MHz)		1852.5	1880	1907.5
5M	QPSK	1	0	24.75	24.87	24.72
		1	12	24.75	24.89	24.78
		1	24	24.86	25.01	24.86
		12	0	23.92	24.03	23.91
		12	6	23.96	24.10	23.99
		12	13	23.93	24.05	23.91
		25	0	23.92	24.03	23.92
5M	16QAM	1	0	23.75	23.78	23.70
		1	12	23.73	23.86	23.73
		1	24	23.76	23.92	23.85
		12	0	22.92	23.01	22.83
		12	6	22.92	23.06	22.93
		12	13	22.86	23.04	22.82
		25	0	22.89	22.99	22.82

*EIRP (dBm) = Conducted Output Power (dBm) + Antenna Gain (dBi)

LTE Band 2						
BW	MCS Index	RB Size	RB Offset	Low	Mid	High
		Channel		18615	18900	19185
		Frequency (MHz)		1851.5	1880	1908.5
3M	QPSK	1	0	24.75	24.90	24.75
		1	7	24.79	24.93	24.81
		1	14	24.72	24.85	24.70
		8	0	23.90	24.01	23.89
		8	3	23.76	23.89	23.75
		8	7	23.83	23.98	23.85
		15	0	23.86	23.99	23.85
3M	16QAM	1	0	23.73	23.86	23.75
		1	7	23.74	23.87	23.73
		1	14	23.69	23.76	23.61
		8	0	22.88	22.96	22.80
		8	3	22.76	22.88	22.71
		8	7	22.80	22.95	22.76
		15	0	22.76	22.97	22.81

*EIRP (dBm) = Conducted Output Power (dBm) + Antenna Gain (dBi)

LTE Band 2						
BW	MCS Index	RB Size	RB Offset	Low	Mid	High
		Channel		18607	18900	19193
		Frequency (MHz)		1850.7	1880	1909.3
1.4M	QPSK	1	0	24.87	25.00	24.89
		1	2	24.86	24.98	24.84
		1	5	24.86	24.99	24.88
		3	0	24.74	24.89	24.74
		3	1	24.71	24.83	24.72
		3	3	24.72	24.86	24.74
		6	0	23.86	24.01	23.86
1.4M	16QAM	1	0	23.86	23.90	23.79
		1	2	23.84	23.96	23.82
		1	5	23.79	23.99	23.83
		3	0	23.67	23.87	23.71
		3	1	23.69	23.78	23.62
		3	3	23.62	23.84	23.70
		6	0	22.77	22.98	22.76

*EIRP (dBm) = Conducted Output Power (dBm) + Antenna Gain (dBi)

7.1.7 LTE Band 4
Conducted Output Power (dBm)

LTE Band 4						
BW	MCS Index	RB Size	RB Offset	Low	Mid	High
		Channel		20050	20175	20300
		Frequency (MHz)		1720	1732.5	1745
20M	QPSK	1	0	23.24	23.39	23.26
		1	50	23.55	23.69	23.54
		1	99	23.16	23.30	23.19
		50	0	22.06	22.20	22.05
		50	25	22.09	22.23	22.11
		50	50	22.14	22.28	22.16
		100	0	21.99	22.11	21.96
20M	16QAM	1	0	22.15	22.33	22.25
		1	50	22.50	22.60	22.48
		1	99	22.08	22.28	22.14
		50	0	21.03	21.16	20.97
		50	25	21.06	21.20	21.01
		50	50	21.06	21.19	21.14
		100	0	20.94	21.11	20.92

LTE Band 4						
BW	MCS Index	RB Size	RB Offset	Low	Mid	High
		Channel		20025	20175	20325
		Frequency (MHz)		1717.5	1732.5	1747.5
15M	QPSK	1	0	23.26	23.41	23.27
		1	37	23.35	23.50	23.36
		1	74	23.17	23.30	23.18
		36	0	22.03	22.15	22.00
		36	19	21.98	22.09	21.94
		36	39	22.11	22.26	22.12
		75	0	22.14	22.27	22.15
15M	16QAM	1	0	22.17	22.40	22.26
		1	37	22.28	22.49	22.30
		1	74	22.15	22.28	22.13
		36	0	20.99	21.06	20.97
		36	19	20.89	21.06	20.89
		36	39	21.07	21.18	21.12
		75	0	21.06	21.18	21.10



LTE Band 4						
BW	MCS Index	RB Size	RB Offset	Low	Mid	High
		Channel		20000	20175	20350
		Frequency (MHz)		1715	1732.5	1750
10M	QPSK	1	0	23.18	23.30	23.19
		1	24	23.54	23.66	23.53
		1	49	23.15	23.29	23.18
		25	0	21.97	22.11	21.98
		25	12	22.12	22.26	22.13
		25	25	22.07	22.20	22.08
		50	0	22.06	22.19	22.04
10M	16QAM	1	0	22.11	22.27	22.19
		1	24	22.48	22.58	22.53
		1	49	22.08	22.22	22.09
		25	0	20.95	21.06	20.92
		25	12	21.07	21.17	21.06
		25	25	21.06	21.10	21.07
		50	0	21.01	21.17	20.94

LTE Band 4						
BW	MCS Index	RB Size	RB Offset	Low	Mid	High
		Channel		19975	20175	20375
		Frequency (MHz)		1712.5	1732.5	1752.5
5M	QPSK	1	0	22.98	23.13	23.02
		1	12	23.24	23.36	23.21
		1	24	22.98	23.11	22.97
		12	0	22.10	22.25	22.12
		12	6	22.19	22.31	22.17
		12	13	21.94	22.09	21.96
		25	0	22.15	22.26	22.13
5M	16QAM	1	0	21.93	22.13	21.95
		1	12	22.16	22.30	22.13
		1	24	21.89	22.11	21.91
		12	0	21.00	21.18	21.04
		12	6	21.09	21.28	21.07
		12	13	20.94	21.09	20.88
		25	0	21.13	21.16	21.12



LTE Band 4						
BW	MCS Index	RB Size	RB Offset	Low	Mid	High
		Channel		19965	20175	20385
		Frequency (MHz)		1711.5	1732.5	1753.5
3M	QPSK	1	0	23.25	23.38	23.25
		1	7	23.19	23.32	23.18
		1	14	23.17	23.28	23.16
		8	0	22.13	22.24	22.13
		8	3	22.20	22.31	22.16
		8	7	22.15	22.29	22.17
		15	0	22.13	22.26	22.11
3M	16QAM	1	0	22.24	22.37	22.23
		1	7	22.12	22.22	22.18
		1	14	22.08	22.19	22.14
		8	0	21.08	21.22	21.12
		8	3	21.14	21.31	21.13
		8	7	21.12	21.26	21.15
		15	0	21.07	21.20	21.02

LTE Band 4						
BW	MCS Index	RB Size	RB Offset	Low	Mid	High
		Channel		19957	20175	20393
		Frequency (MHz)		1710.7	1732.5	1754.3
1.4M	QPSK	1	0	22.99	23.13	23.02
		1	2	23.17	23.31	23.17
		1	5	22.97	23.12	22.99
		3	0	23.08	23.20	23.08
		3	1	23.24	23.39	23.25
		3	3	23.09	23.20	23.08
		6	0	21.89	22.04	21.89
1.4M	16QAM	1	0	21.92	22.09	21.92
		1	2	22.12	22.22	22.16
		1	5	21.88	22.07	21.97
		3	0	22.06	22.18	22.08
		3	1	22.23	22.31	22.22
		3	3	22.05	22.19	22.02
		6	0	20.81	21.02	20.83

EIRP Power (dBm)

LTE Band 4						
BW	MCS Index	RB Size	RB Offset	Low	Mid	High
		Channel		20050	20175	20300
		Frequency (MHz)		1720	1732.5	1745
20M	QPSK	1	0	25.24	25.39	25.26
		1	50	25.55	25.69	25.54
		1	99	25.16	25.30	25.19
		50	0	24.06	24.20	24.05
		50	25	24.09	24.23	24.11
		50	50	24.14	24.28	24.16
		100	0	23.99	24.11	23.96
20M	16QAM	1	0	24.15	24.33	24.25
		1	50	24.50	24.60	24.48
		1	99	24.08	24.28	24.14
		50	0	23.03	23.16	22.97
		50	25	23.06	23.20	23.01
		50	50	23.06	23.19	23.14
		100	0	22.94	23.11	22.92

*EIRP (dBm) = Conducted Output Power (dBm) + Antenna Gain (dBi)

LTE Band 4						
BW	MCS Index	RB Size	RB Offset	Low	Mid	High
		Channel		20025	20175	20325
		Frequency (MHz)		1717.5	1732.5	1747.5
15M	QPSK	1	0	25.26	25.41	25.27
		1	37	25.35	25.50	25.36
		1	74	25.17	25.30	25.18
		36	0	24.03	24.15	24.00
		36	19	23.98	24.09	23.94
		36	39	24.11	24.26	24.12
		75	0	24.14	24.27	24.15
15M	16QAM	1	0	24.17	24.40	24.26
		1	37	24.28	24.49	24.30
		1	74	24.15	24.28	24.13
		36	0	22.99	23.06	22.97
		36	19	22.89	23.06	22.89
		36	39	23.07	23.18	23.12
		75	0	23.06	23.18	23.10

*EIRP (dBm) = Conducted Output Power (dBm) + Antenna Gain (dBi)

LTE Band 4						
BW	MCS Index	RB Size	RB Offset	Low	Mid	High
		Channel		20000	20175	20350
		Frequency (MHz)		1715	1732.5	1750
10M	QPSK	1	0	25.18	25.30	25.19
		1	24	25.54	25.66	25.53
		1	49	25.15	25.29	25.18
		25	0	23.97	24.11	23.98
		25	12	24.12	24.26	24.13
		25	25	24.07	24.20	24.08
		50	0	24.06	24.19	24.04
10M	16QAM	1	0	24.11	24.27	24.19
		1	24	24.48	24.58	24.53
		1	49	24.08	24.22	24.09
		25	0	22.95	23.06	22.92
		25	12	23.07	23.17	23.06
		25	25	23.06	23.10	23.07
		50	0	23.01	23.17	22.94

*EIRP (dBm) = Conducted Output Power (dBm) + Antenna Gain (dBi)

LTE Band 4						
BW	MCS Index	RB Size	RB Offset	Low	Mid	High
		Channel		19975	20175	20375
		Frequency (MHz)		1712.5	1732.5	1752.5
5M	QPSK	1	0	24.98	25.13	25.02
		1	12	25.24	25.36	25.21
		1	24	24.98	25.11	24.97
		12	0	24.10	24.25	24.12
		12	6	24.19	24.31	24.17
		12	13	23.94	24.09	23.96
		25	0	24.15	24.26	24.13
5M	16QAM	1	0	23.93	24.13	23.95
		1	12	24.16	24.30	24.13
		1	24	23.89	24.11	23.91
		12	0	23.00	23.18	23.04
		12	6	23.09	23.28	23.07
		12	13	22.94	23.09	22.88
		25	0	23.13	23.16	23.12

*EIRP (dBm) = Conducted Output Power (dBm) + Antenna Gain (dBi)

LTE Band 4						
BW	MCS Index	RB Size	RB Offset	Low	Mid	High
		Channel		19965	20175	20385
		Frequency (MHz)		1711.5	1732.5	1753.5
3M	QPSK	1	0	25.25	25.38	25.25
		1	7	25.19	25.32	25.18
		1	14	25.17	25.28	25.16
		8	0	24.13	24.24	24.13
		8	3	24.20	24.31	24.16
		8	7	24.15	24.29	24.17
		15	0	24.13	24.26	24.11
3M	16QAM	1	0	24.24	24.37	24.23
		1	7	24.12	24.22	24.18
		1	14	24.08	24.19	24.14
		8	0	23.08	23.22	23.12
		8	3	23.14	23.31	23.13
		8	7	23.12	23.26	23.15
		15	0	23.07	23.20	23.02

*EIRP (dBm) = Conducted Output Power (dBm) + Antenna Gain (dBi)

LTE Band 4						
BW	MCS Index	RB Size	RB Offset	Low	Mid	High
		Channel		19957	20175	20393
		Frequency (MHz)		1710.7	1732.5	1754.3
1.4M	QPSK	1	0	24.99	25.13	25.02
		1	2	25.17	25.31	25.17
		1	5	24.97	25.12	24.99
		3	0	25.08	25.20	25.08
		3	1	25.24	25.39	25.25
		3	3	25.09	25.20	25.08
		6	0	23.89	24.04	23.89
1.4M	16QAM	1	0	23.92	24.09	23.92
		1	2	24.12	24.22	24.16
		1	5	23.88	24.07	23.97
		3	0	24.06	24.18	24.08
		3	1	24.23	24.31	24.22
		3	3	24.05	24.19	24.02
		6	0	22.81	23.02	22.83

*EIRP (dBm) = Conducted Output Power (dBm) + Antenna Gain (dBi)

7.1.8 LTE Band 5

Conducted Output Power (dBm)

LTE Band 5						
BW	MCS Index	RB Size	RB Offset	Low	Mid	High
		Channel		20450	20525	20600
		Frequency (MHz)		829	836.5	844
10M	QPSK	1	0	23.38	23.49	23.38
		1	24	23.54	23.66	23.55
		1	49	23.13	23.24	23.10
		25	0	22.44	22.56	22.41
		25	12	22.43	22.58	22.43
		25	25	22.31	22.42	22.28
		50	0	22.42	22.56	22.44
10M	16QAM	1	0	22.29	22.49	22.28
		1	24	22.53	22.61	22.45
		1	49	22.09	22.21	22.06
		25	0	21.37	21.55	21.38
		25	12	21.39	21.58	21.36
		25	25	21.31	21.38	21.25
		50	0	21.40	21.48	21.37

LTE Band 5						
BW	MCS Index	RB Size	RB Offset	Low	Mid	High
		Channel		20425	20525	20625
		Frequency (MHz)		826.5	836.5	846.5
5M	QPSK	1	0	23.18	23.30	23.19
		1	12	23.48	23.63	23.51
		1	24	23.01	23.15	23.01
		12	0	22.36	22.47	22.34
		12	6	22.42	22.55	22.42
		12	13	22.44	22.55	22.43
		25	0	22.27	22.40	22.26
5M	16QAM	1	0	22.10	22.28	22.18
		1	12	22.42	22.54	22.49
		1	24	22.00	22.12	22.01
		12	0	21.29	21.45	21.31
		12	6	21.39	21.55	21.37
		12	13	21.43	21.46	21.38
		25	0	21.25	21.32	21.23



LTE Band 5						
BW	MCS Index	RB Size	RB Offset	Low	Mid	High
		Channel		20415	20525	20635
		Frequency (MHz)		825.5	836.5	847.5
3M	QPSK	1	0	23.04	23.19	23.04
		1	7	23.50	23.61	23.46
		1	14	23.19	23.32	23.19
		8	0	22.41	22.54	22.40
		8	3	22.40	22.52	22.41
		8	7	22.46	22.59	22.48
		15	0	22.27	22.41	22.26
3M	16QAM	1	0	21.99	22.14	22.02
		1	7	22.50	22.58	22.36
		1	14	22.10	22.29	22.09
		8	0	21.36	21.54	21.39
		8	3	21.37	21.49	21.35
		8	7	21.38	21.50	21.47
		15	0	21.26	21.40	21.20

LTE Band 5						
BW	MCS Index	RB Size	RB Offset	Low	Mid	High
		Channel		20407	20525	20643
		Frequency (MHz)		824.7	836.5	848.3
1.4M	QPSK	1	0	23.08	23.20	23.08
		1	2	22.85	23.00	22.87
		1	5	23.26	23.40	23.26
		3	0	23.48	23.60	23.46
		3	1	23.31	23.45	23.34
		3	3	23.28	23.39	23.25
		6	0	22.42	22.53	22.38
1.4M	16QAM	1	0	22.04	22.15	22.08
		1	2	21.77	21.92	21.80
		1	5	22.18	22.34	22.23
		3	0	22.44	22.50	22.46
		3	1	22.26	22.43	22.24
		3	3	22.27	22.39	22.20
		6	0	21.35	21.51	21.30

ERP Power (dBm)

LTE Band 5						
BW	MCS Index	RB Size	RB Offset	Low	Mid	High
		Channel		20450	20525	20600
		Frequency (MHz)		829	836.5	844
10M	QPSK	1	0	23.23	23.34	23.23
		1	24	23.39	23.51	23.40
		1	49	22.98	23.09	22.95
		25	0	22.29	22.41	22.26
		25	12	22.28	22.43	22.28
		25	25	22.16	22.27	22.13
		50	0	22.27	22.41	22.29
10M	16QAM	1	0	22.14	22.34	22.13
		1	24	22.38	22.46	22.30
		1	49	21.94	22.06	21.91
		25	0	21.22	21.40	21.23
		25	12	21.24	21.43	21.21
		25	25	21.16	21.23	21.10
		50	0	21.25	21.33	21.22

*ERP (dBm) = Conducted Output Power (dBm) + Antenna Gain (dBi) - 2.15

LTE Band 5						
BW	MCS Index	RB Size	RB Offset	Low	Mid	High
		Channel		20425	20525	20625
		Frequency (MHz)		826.5	836.5	846.5
5M	QPSK	1	0	23.03	23.15	23.04
		1	12	23.33	23.48	23.36
		1	24	22.86	23.00	22.86
		12	0	22.21	22.32	22.19
		12	6	22.27	22.40	22.27
		12	13	22.29	22.40	22.28
		25	0	22.12	22.25	22.11
5M	16QAM	1	0	21.95	22.13	22.03
		1	12	22.27	22.39	22.34
		1	24	21.85	21.97	21.86
		12	0	21.14	21.30	21.16
		12	6	21.24	21.40	21.22
		12	13	21.28	21.31	21.23
		25	0	21.10	21.17	21.08

*ERP (dBm) = Conducted Output Power (dBm) + Antenna Gain (dBi) - 2.15

LTE Band 5						
BW	MCS Index	RB Size	RB Offset	Low	Mid	High
		Channel		20415	20525	20635
		Frequency (MHz)		825.5	836.5	847.5
3M	QPSK	1	0	22.89	23.04	22.89
		1	7	23.35	23.46	23.31
		1	14	23.04	23.17	23.04
		8	0	22.26	22.39	22.25
		8	3	22.25	22.37	22.26
		8	7	22.31	22.44	22.33
		15	0	22.12	22.26	22.11
3M	16QAM	1	0	21.84	21.99	21.87
		1	7	22.35	22.43	22.21
		1	14	21.95	22.14	21.94
		8	0	21.21	21.39	21.24
		8	3	21.22	21.34	21.20
		8	7	21.23	21.35	21.32
		15	0	21.11	21.25	21.05

*ERP (dBm) = Conducted Output Power (dBm) + Antenna Gain (dBi) - 2.15

LTE Band 5						
BW	MCS Index	RB Size	RB Offset	Low	Mid	High
		Channel		20407	20525	20643
		Frequency (MHz)		824.7	836.5	848.3
1.4M	QPSK	1	0	22.93	23.05	22.93
		1	2	22.70	22.85	22.72
		1	5	23.11	23.25	23.11
		3	0	23.33	23.45	23.31
		3	1	23.16	23.30	23.19
		3	3	23.13	23.24	23.10
		6	0	22.27	22.38	22.23
1.4M	16QAM	1	0	21.89	22.00	21.93
		1	2	21.62	21.77	21.65
		1	5	22.03	22.19	22.08
		3	0	22.29	22.35	22.31
		3	1	22.11	22.28	22.09
		3	3	22.12	22.24	22.05
		6	0	21.20	21.36	21.15

*ERP (dBm) = Conducted Output Power (dBm) + Antenna Gain (dBi) - 2.15

7.1.9 LTE Band 7
Conducted Output Power (dBm)

LTE Band 7						
BW	MCS Index	RB Size	RB Offset	Low	Mid	High
		Channel		20850	21100	21350
		Frequency (MHz)		2510	2535	2560
20M	QPSK	1	0	23.01	23.13	22.98
		1	50	23.20	23.34	23.22
		1	99	22.67	22.78	22.63
		50	0	22.05	22.19	22.06
		50	25	22.23	22.35	22.21
		50	50	22.09	22.21	22.10
		100	0	21.92	22.04	21.89
20M	16QAM	1	0	21.94	22.07	21.91
		1	50	22.11	22.25	22.16
		1	99	21.63	21.70	21.60
		50	0	20.98	21.14	21.05
		50	25	21.23	21.34	21.16
		50	50	21.03	21.12	21.07
		100	0	20.87	21.00	20.83

LTE Band 7						
BW	MCS Index	RB Size	RB Offset	Low	Mid	High
		Channel		20825	21100	21375
		Frequency (MHz)		2507.5	2535	2562.5
15M	QPSK	1	0	23.11	23.22	23.10
		1	37	23.17	23.31	23.20
		1	74	22.88	23.02	22.88
		36	0	22.06	22.21	22.07
		36	19	21.98	22.13	22.02
		36	39	21.98	22.11	21.97
		75	0	21.90	22.02	21.88
15M	16QAM	1	0	22.03	22.18	22.08
		1	37	22.12	22.30	22.17
		1	74	21.82	21.92	21.78
		36	0	21.03	21.14	21.04
		36	19	20.93	21.11	20.98
		36	39	20.93	21.09	20.89
		75	0	20.84	21.00	20.78



LTE Band 7						
BW	MCS Index	RB Size	RB Offset	Low	Mid	High
		Channel		20800	21100	21400
		Frequency (MHz)		2505	2535	2565
10M	QPSK	1	0	23.11	23.26	23.15
		1	24	23.14	23.29	23.17
		1	49	23.04	23.15	23.01
		25	0	21.95	22.10	21.98
		25	12	22.06	22.19	22.05
		25	25	21.93	22.06	21.92
		50	0	22.00	22.14	22.02
10M	16QAM	1	0	22.08	22.26	22.13
		1	24	22.09	22.26	22.15
		1	49	21.97	22.06	22.01
		25	0	20.87	21.04	20.98
		25	12	21.00	21.16	21.03
		25	25	20.84	20.99	20.89
		50	0	20.93	21.11	20.98

LTE Band 7						
BW	MCS Index	RB Size	RB Offset	Low	Mid	High
		Channel		20775	21100	21425
		Frequency (MHz)		2502.5	2535	2567.5
5M	QPSK	1	0	23.19	23.30	23.17
		1	12	23.08	23.22	23.11
		1	24	22.97	23.10	22.96
		12	0	21.98	22.13	22.00
		12	6	21.96	22.11	22.00
		12	13	22.09	22.21	22.10
		25	0	21.90	22.02	21.89
5M	16QAM	1	0	22.12	22.27	22.12
		1	12	22.07	22.16	22.07
		1	24	21.91	22.01	21.93
		12	0	20.89	21.05	20.96
		12	6	20.93	21.06	20.96
		12	13	21.06	21.20	21.07
		25	0	20.86	20.98	20.80

EIRP Power (dBm)

LTE Band 7						
BW	MCS Index	RB Size	RB Offset	Low	Mid	High
		Channel		20850	21100	21350
		Frequency (MHz)		2510	2535	2560
20M	QPSK	1	0	25.01	25.13	24.98
		1	50	25.20	25.34	25.22
		1	99	24.67	24.78	24.63
		50	0	24.05	24.19	24.06
		50	25	24.23	24.35	24.21
		50	50	24.09	24.21	24.10
		100	0	23.92	24.04	23.89
20M	16QAM	1	0	23.94	24.07	23.91
		1	50	24.11	24.25	24.16
		1	99	23.63	23.70	23.60
		50	0	22.98	23.14	23.05
		50	25	23.23	23.34	23.16
		50	50	23.03	23.12	23.07
		100	0	22.87	23.00	22.83

*EIRP (dBm) = Conducted Output Power (dBm) + Antenna Gain (dBi)

LTE Band 7						
BW	MCS Index	RB Size	RB Offset	Low	Mid	High
		Channel		20825	21100	21375
		Frequency (MHz)		2507.5	2535	2562.5
15M	QPSK	1	0	25.11	25.22	25.10
		1	37	25.17	25.31	25.20
		1	74	24.88	25.02	24.88
		36	0	24.06	24.21	24.07
		36	19	23.98	24.13	24.02
		36	39	23.98	24.11	23.97
		75	0	23.90	24.02	23.88
15M	16QAM	1	0	24.03	24.18	24.08
		1	37	24.12	24.30	24.17
		1	74	23.82	23.92	23.78
		36	0	23.03	23.14	23.04
		36	19	22.93	23.11	22.98
		36	39	22.93	23.09	22.89
		75	0	22.84	23.00	22.78

*EIRP (dBm) = Conducted Output Power (dBm) + Antenna Gain (dBi)

LTE Band 7						
BW	MCS Index	RB Size	RB Offset	Low	Mid	High
		Channel		20800	21100	21400
		Frequency (MHz)		2505	2535	2565
10M	QPSK	1	0	25.11	25.26	25.15
		1	24	25.14	25.29	25.17
		1	49	25.04	25.15	25.01
		25	0	23.95	24.10	23.98
		25	12	24.06	24.19	24.05
		25	25	23.93	24.06	23.92
		50	0	24.00	24.14	24.02
10M	16QAM	1	0	24.08	24.26	24.13
		1	24	24.09	24.26	24.15
		1	49	23.97	24.06	24.01
		25	0	22.87	23.04	22.98
		25	12	23.00	23.16	23.03
		25	25	22.84	22.99	22.89
		50	0	22.93	23.11	22.98

*EIRP (dBm) = Conducted Output Power (dBm) + Antenna Gain (dBi)

LTE Band 7						
BW	MCS Index	RB Size	RB Offset	Low	Mid	High
		Channel		20775	21100	21425
		Frequency (MHz)		2502.5	2535	2567.5
5M	QPSK	1	0	25.19	25.30	25.17
		1	12	25.08	25.22	25.11
		1	24	24.97	25.10	24.96
		12	0	23.98	24.13	24.00
		12	6	23.96	24.11	24.00
		12	13	24.09	24.21	24.10
		25	0	23.90	24.02	23.89
5M	16QAM	1	0	24.12	24.27	24.12
		1	12	24.07	24.16	24.07
		1	24	23.91	24.01	23.93
		12	0	22.89	23.05	22.96
		12	6	22.93	23.06	22.96
		12	13	23.06	23.20	23.07
		25	0	22.86	22.98	22.80

*EIRP (dBm) = Conducted Output Power (dBm) + Antenna Gain (dBi)

7.1.10 LTE Band 12

Conducted Output Power (dBm)

LTE Band 12						
BW	MCS Index	RB Size	RB Offset	Low	Mid	High
		Channel		23060	23095	23130
		Frequency (MHz)		704	707.5	711
10M	QPSK	1	0	23.28	23.43	23.29
		1	24	23.65	23.79	23.65
		1	49	23.45	23.58	23.44
		25	0	22.27	22.41	22.27
		25	12	22.36	22.51	22.40
		25	25	22.44	22.55	22.40
		50	0	22.44	22.56	22.45
10M	16QAM	1	0	22.25	22.39	22.19
		1	24	22.64	22.70	22.61
		1	49	22.36	22.57	22.34
		25	0	21.23	21.39	21.18
		25	12	21.33	21.47	21.30
		25	25	21.39	21.54	21.36
		50	0	21.35	21.46	21.44

LTE Band 12						
BW	MCS Index	RB Size	RB Offset	Low	Mid	High
		Channel		23035	23095	23155
		Frequency (MHz)		701.5	707.5	713.5
5M	QPSK	1	0	23.25	23.40	23.27
		1	12	23.46	23.60	23.45
		1	24	23.20	23.35	23.22
		12	0	22.31	22.46	22.35
		12	6	22.30	22.45	22.31
		12	13	22.39	22.50	22.39
		25	0	22.29	22.42	22.30
5M	16QAM	1	0	22.16	22.30	22.21
		1	12	22.45	22.53	22.41
		1	24	22.19	22.31	22.17
		12	0	21.24	21.36	21.35
		12	6	21.25	21.45	21.22
		12	13	21.33	21.50	21.33
		25	0	21.28	21.33	21.26



LTE Band 12						
BW	MCS Index	RB Size	RB Offset	Low	Mid	High
		Channel		23025	23095	23165
		Frequency (MHz)		700.5	707.5	714.5
3M	QPSK	1	0	23.26	23.41	23.27
		1	7	23.51	23.62	23.47
		1	14	23.36	23.51	23.39
		8	0	22.39	22.50	22.36
		8	3	22.45	22.56	22.45
		8	7	22.46	22.60	22.47
		15	0	22.34	22.49	22.35
3M	16QAM	1	0	22.23	22.37	22.19
		1	7	22.47	22.55	22.40
		1	14	22.34	22.42	22.35
		8	0	21.31	21.48	21.30
		8	3	21.44	21.56	21.43
		8	7	21.45	21.59	21.42
		15	0	21.31	21.48	21.34

LTE Band 12						
BW	MCS Index	RB Size	RB Offset	Low	Mid	High
		Channel		23017	23095	23173
		Frequency (MHz)		699.7	707.5	715.3
1.4M	QPSK	1	0	23.36	23.50	23.39
		1	2	23.48	23.60	23.45
		1	5	23.36	23.49	23.36
		3	0	23.29	23.40	23.28
		3	1	23.30	23.44	23.31
		3	3	23.35	23.46	23.32
		6	0	22.37	22.50	22.38
1.4M	16QAM	1	0	22.27	22.44	22.29
		1	2	22.48	22.57	22.45
		1	5	22.29	22.46	22.28
		3	0	22.22	22.40	22.23
		3	1	22.25	22.38	22.24
		3	3	22.33	22.46	22.27
		6	0	21.34	21.47	21.35

ERP Power (dBm)

LTE Band 12						
BW	MCS Index	RB Size	RB Offset	Low	Mid	High
		Channel		23060	23095	23130
		Frequency (MHz)		704	707.5	711
10M	QPSK	1	0	23.13	23.28	23.14
		1	24	23.50	23.64	23.50
		1	49	23.30	23.43	23.29
		25	0	22.12	22.26	22.12
		25	12	22.21	22.36	22.25
		25	25	22.29	22.40	22.25
		50	0	22.29	22.41	22.30
10M	16QAM	1	0	22.10	22.24	22.04
		1	24	22.49	22.55	22.46
		1	49	22.21	22.42	22.19
		25	0	21.08	21.24	21.03
		25	12	21.18	21.32	21.15
		25	25	21.24	21.39	21.21
		50	0	21.20	21.31	21.29

*ERP (dBm) = Conducted Output Power (dBm) + Antenna Gain (dBi) - 2.15

LTE Band 12						
BW	MCS Index	RB Size	RB Offset	Low	Mid	High
		Channel		23035	23095	23155
		Frequency (MHz)		701.5	707.5	713.5
5M	QPSK	1	0	23.10	23.25	23.12
		1	12	23.31	23.45	23.30
		1	24	23.05	23.20	23.07
		12	0	22.16	22.31	22.20
		12	6	22.15	22.30	22.16
		12	13	22.24	22.35	22.24
		25	0	22.14	22.27	22.15
5M	16QAM	1	0	22.01	22.15	22.06
		1	12	22.30	22.38	22.26
		1	24	22.04	22.16	22.02
		12	0	21.09	21.21	21.20
		12	6	21.10	21.30	21.07
		12	13	21.18	21.35	21.18
		25	0	21.13	21.18	21.11

*ERP (dBm) = Conducted Output Power (dBm) + Antenna Gain (dBi) - 2.15

LTE Band 12						
BW	MCS Index	RB Size	RB Offset	Low	Mid	High
		Channel		23025	23095	23165
		Frequency (MHz)		700.5	707.5	714.5
3M	QPSK	1	0	23.11	23.26	23.12
		1	7	23.36	23.47	23.32
		1	14	23.21	23.36	23.24
		8	0	22.24	22.35	22.21
		8	3	22.30	22.41	22.30
		8	7	22.31	22.45	22.32
		15	0	22.19	22.34	22.20
3M	16QAM	1	0	22.08	22.22	22.04
		1	7	22.32	22.40	22.25
		1	14	22.19	22.27	22.20
		8	0	21.16	21.33	21.15
		8	3	21.29	21.41	21.28
		8	7	21.30	21.44	21.27
		15	0	21.16	21.33	21.19

*ERP (dBm) = Conducted Output Power (dBm) + Antenna Gain (dBi) - 2.15

LTE Band 12						
BW	MCS Index	RB Size	RB Offset	Low	Mid	High
		Channel		23017	23095	23173
		Frequency (MHz)		699.7	707.5	715.3
1.4M	QPSK	1	0	23.21	23.35	23.24
		1	2	23.33	23.45	23.30
		1	5	23.21	23.34	23.21
		3	0	23.14	23.25	23.13
		3	1	23.15	23.29	23.16
		3	3	23.20	23.31	23.17
		6	0	22.22	22.35	22.23
1.4M	16QAM	1	0	22.12	22.29	22.14
		1	2	22.33	22.42	22.30
		1	5	22.14	22.31	22.13
		3	0	22.07	22.25	22.08
		3	1	22.10	22.23	22.09
		3	3	22.18	22.31	22.12
		6	0	21.19	21.32	21.20

*ERP (dBm) = Conducted Output Power (dBm) + Antenna Gain (dBi) - 2.15

7.1.11 LTE Band 13

Conducted Output Power (dBm)

LTE Band 13				
BW	MCS Index	RB Size	RB Offset	Mid
		Channel		23230
		Frequency (MHz)		782
10M	QPSK	1	0	23.77
		1	24	23.92
		1	49	23.49
		25	0	22.72
		25	12	22.6
		25	25	22.62
		50	0	22.61
10M	16QAM	1	0	22.70
		1	24	22.82
		1	49	22.39
		25	0	21.66
		25	12	21.56
		25	25	21.55
		50	0	21.54

LTE Band 13							
BW	MCS Index	RB Size	RB Offset	Low	Mid	High	
		Channel			23205	23230	23255
		Frequency (MHz)			779.5	782	784.5
5M	QPSK	1	0	23.13	23.26	23.15	
		1	12	23.64	23.79	23.67	
		1	24	23.38	23.49	23.36	
		12	0	22.48	22.61	22.49	
		12	6	22.59	22.70	22.59	
		12	13	22.54	22.69	22.55	
		25	0	22.60	22.72	22.58	
5M	16QAM	1	0	22.13	22.16	22.14	
		1	12	22.58	22.72	22.65	
		1	24	22.36	22.48	22.26	
		12	0	21.43	21.59	21.47	
		12	6	21.50	21.65	21.54	
		12	13	21.46	21.65	21.49	
		25	0	21.51	21.62	21.56	

ERP Power (dBm)

LTE Band 13				
BW	MCS Index	RB Size	RB Offset	Mid
		Channel		23230
		Frequency (MHz)		782
10M	QPSK	1	0	23.62
		1	24	23.77
		1	49	23.34
		25	0	22.57
		25	12	22.45
		25	25	22.47
		50	0	22.46
10M	16QAM	1	0	22.55
		1	24	22.67
		1	49	22.24
		25	0	21.51
		25	12	21.41
		25	25	21.40
		50	0	21.39

*ERP (dBm) = Conducted Output Power (dBm) + Antenna Gain (dBi) - 2.15

LTE Band 13							
BW	MCS Index	RB Size	RB Offset	Low	Mid	High	
		Channel			23205	23230	23255
		Frequency (MHz)			779.5	782	784.5
5M	QPSK	1	0	22.98	23.11	23.00	
		1	12	23.49	23.64	23.52	
		1	24	23.23	23.34	23.21	
		12	0	22.33	22.46	22.34	
		12	6	22.44	22.55	22.44	
		12	13	22.39	22.54	22.40	
		25	0	22.45	22.57	22.43	
5M	16QAM	1	0	21.98	22.01	21.99	
		1	12	22.43	22.57	22.50	
		1	24	22.21	22.33	22.11	
		12	0	21.28	21.44	21.32	
		12	6	21.35	21.50	21.39	
		12	13	21.31	21.50	21.34	
		25	0	21.36	21.47	21.41	

*ERP (dBm) = Conducted Output Power (dBm) + Antenna Gain (dBi) - 2.15

7.1.12 LTE Band 17

Conducted Output Power (dBm)

LTE Band 17						
BW	MCS Index	RB Size	RB Offset	Low	Mid	High
		Channel		23780	23790	23800
		Frequency (MHz)		709	710	711
10M	QPSK	1	0	23.35	23.46	23.34
		1	24	23.63	23.77	23.62
		1	49	23.22	23.33	23.22
		25	0	22.29	22.43	22.28
		25	12	22.41	22.55	22.42
		25	25	22.32	22.45	22.34
		50	0	22.30	22.41	22.29
10M	16QAM	1	0	22.28	22.44	22.31
		1	24	22.54	22.70	22.55
		1	49	22.20	22.26	22.14
		25	0	21.29	21.33	21.18
		25	12	21.40	21.50	21.34
		25	25	21.23	21.44	21.29
		50	0	21.25	21.32	21.27

LTE Band 17						
BW	MCS Index	RB Size	RB Offset	Low	Mid	High
		Channel		23755	23790	23825
		Frequency (MHz)		706.5	710	713.5
5M	QPSK	1	0	23.31	23.42	23.29
		1	12	23.52	23.67	23.52
		1	24	23.36	23.48	23.34
		12	0	22.35	22.48	22.35
		12	6	22.38	22.52	22.40
		12	13	22.58	22.70	22.58
		25	0	22.39	22.51	22.40
5M	16QAM	1	0	22.25	22.32	22.29
		1	12	22.47	22.65	22.43
		1	24	22.28	22.38	22.29
		12	0	21.33	21.48	21.33
		12	6	21.38	21.52	21.37
		12	13	21.50	21.68	21.55
		25	0	21.35	21.43	21.40

ERP Power (dBm)

LTE Band 17						
BW	MCS Index	RB Size	RB Offset	Low	Mid	High
		Channel		23780	23790	23800
		Frequency (MHz)		709	710	711
10M	QPSK	1	0	23.20	23.31	23.19
		1	24	23.48	23.62	23.47
		1	49	23.07	23.18	23.07
		25	0	22.14	22.28	22.13
		25	12	22.26	22.40	22.27
		25	25	22.17	22.30	22.19
		50	0	22.15	22.26	22.14
10M	16QAM	1	0	22.13	22.29	22.16
		1	24	22.39	22.55	22.40
		1	49	22.05	22.11	21.99
		25	0	21.14	21.18	21.03
		25	12	21.25	21.35	21.19
		25	25	21.08	21.29	21.14
		50	0	21.10	21.17	21.12

*ERP (dBm) = Conducted Output Power (dBm) + Antenna Gain (dBi) - 2.15

LTE Band 17						
BW	MCS Index	RB Size	RB Offset	Low	Mid	High
		Channel		23755	23790	23825
		Frequency (MHz)		706.5	710	713.5
5M	QPSK	1	0	23.16	23.27	23.14
		1	12	23.37	23.52	23.37
		1	24	23.21	23.33	23.19
		12	0	22.20	22.33	22.20
		12	6	22.23	22.37	22.25
		12	13	22.43	22.55	22.43
		25	0	22.24	22.36	22.25
5M	16QAM	1	0	22.10	22.17	22.14
		1	12	22.32	22.50	22.28
		1	24	22.13	22.23	22.14
		12	0	21.18	21.33	21.18
		12	6	21.23	21.37	21.22
		12	13	21.35	21.53	21.40
		25	0	21.20	21.28	21.25

*ERP (dBm) = Conducted Output Power (dBm) + Antenna Gain (dBi) - 2.15

7.2 Modulation Characteristics

Input Power:	3.8 Vdc	Environmental Conditions:	22°C, 68% RH	Tested By:	Noah Chang
--------------	---------	---------------------------	--------------	------------	------------

7.2.1 GSM850

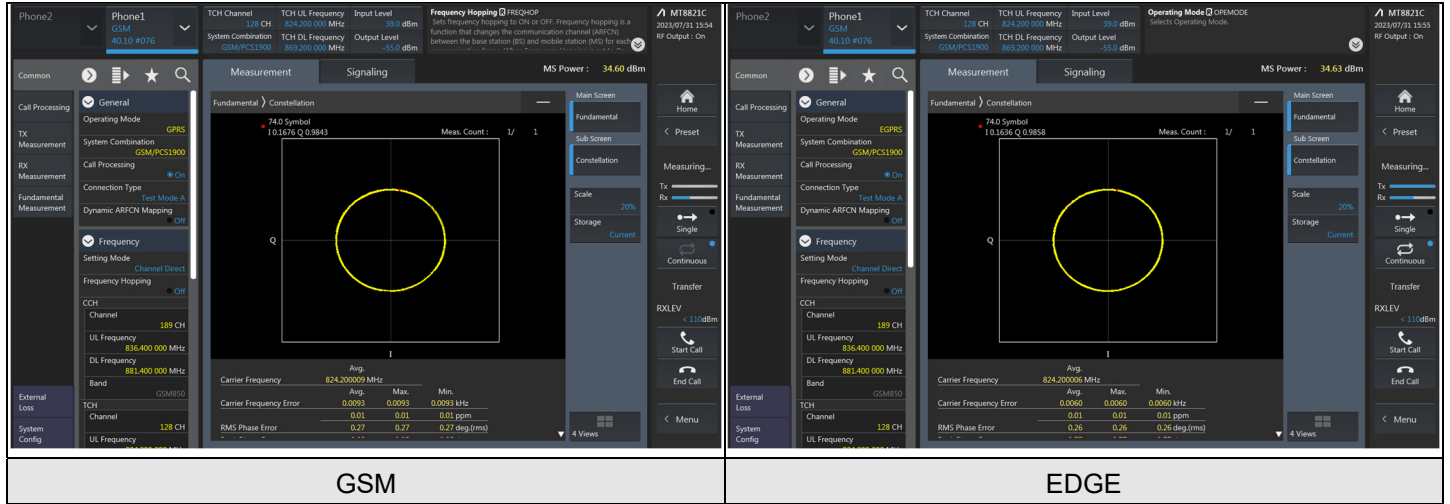

7.2.2 GSM1900

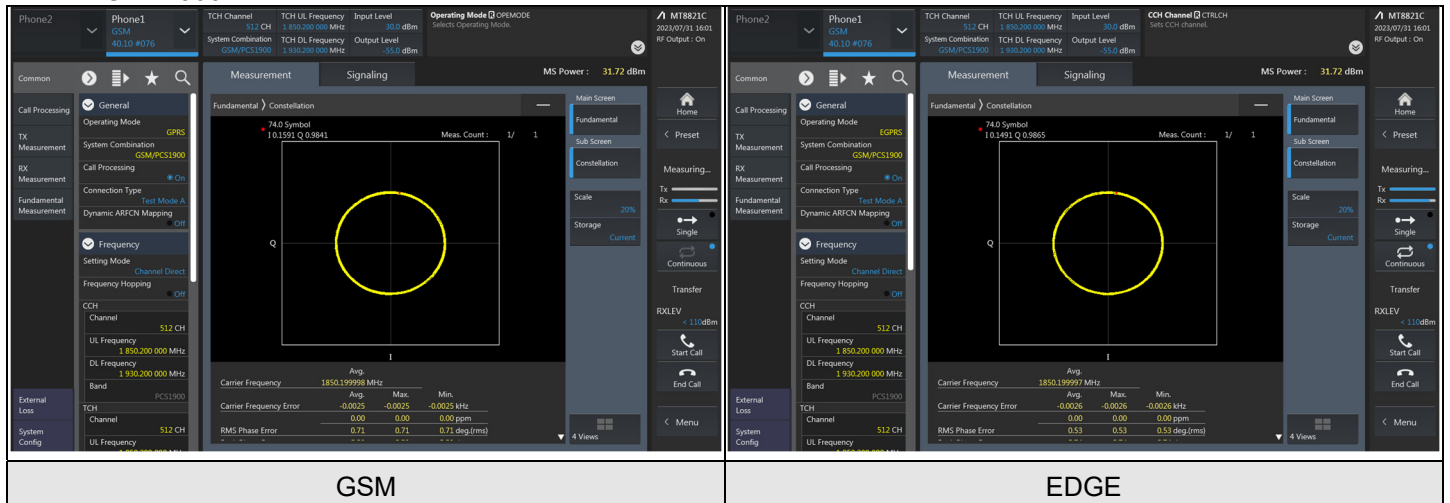

7.2.3 WCDMA Band 2

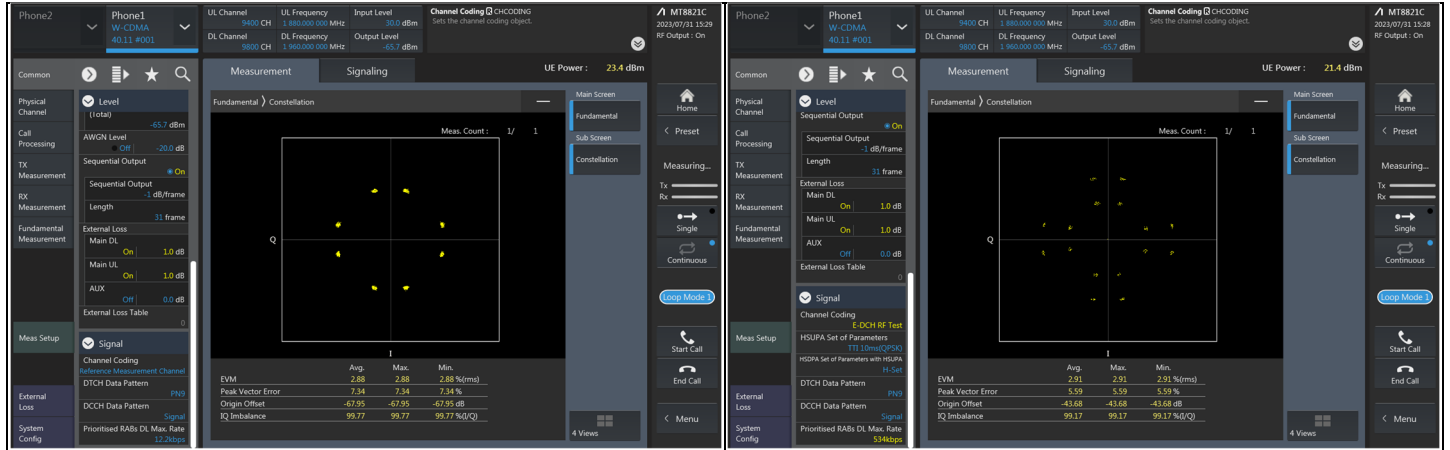

WCDMA CH 9400 (1880 MHz)

HSPA CH 9400 (1880 MHz)

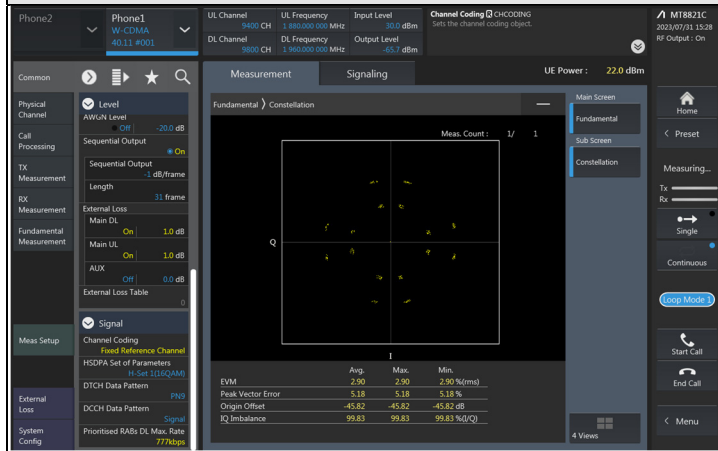

HSDPA CH 9400 (1880 MHz)

7.2.4 WCDMA Band 4

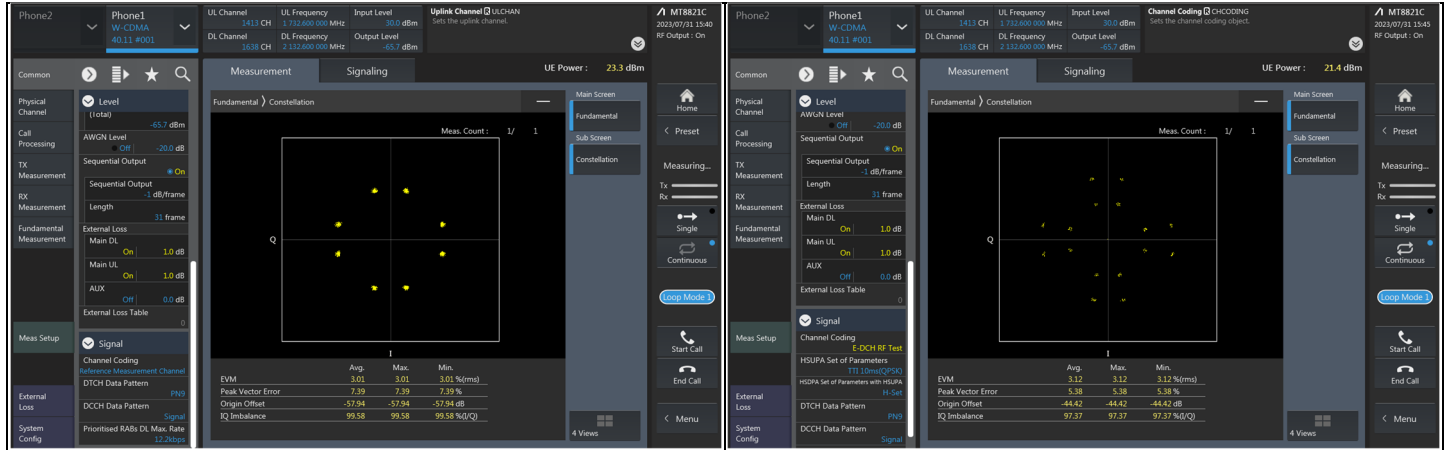

WCDMA CH 1413 (1732.6 MHz)

HSPA CH 1413 (1732.6 MHz)

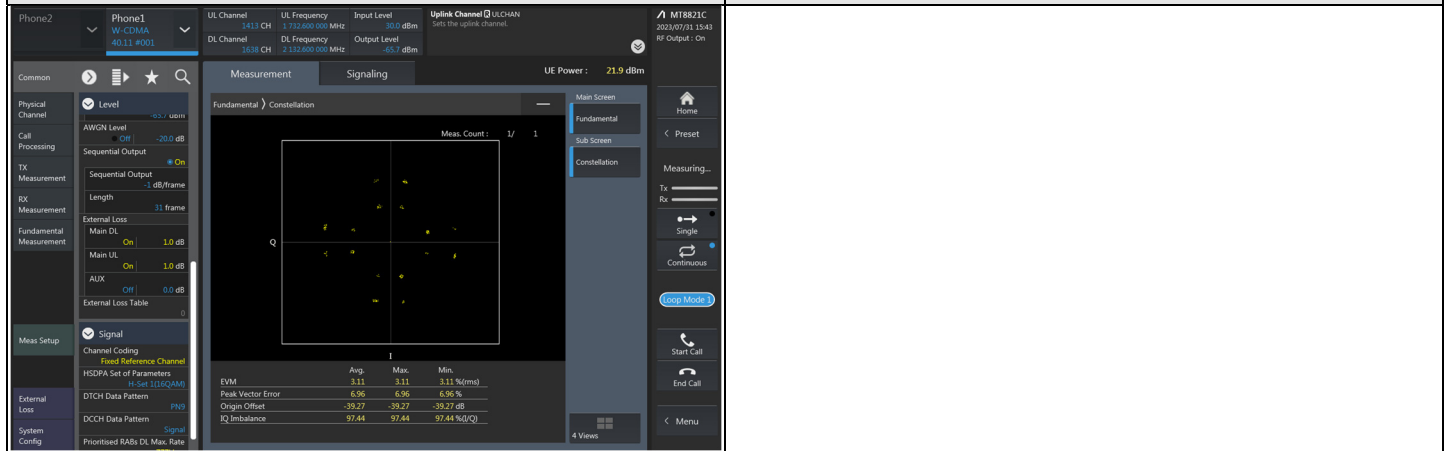

HSDPA CH 1413 (1732.6 MHz)

7.2.5 WCDMA Band 5

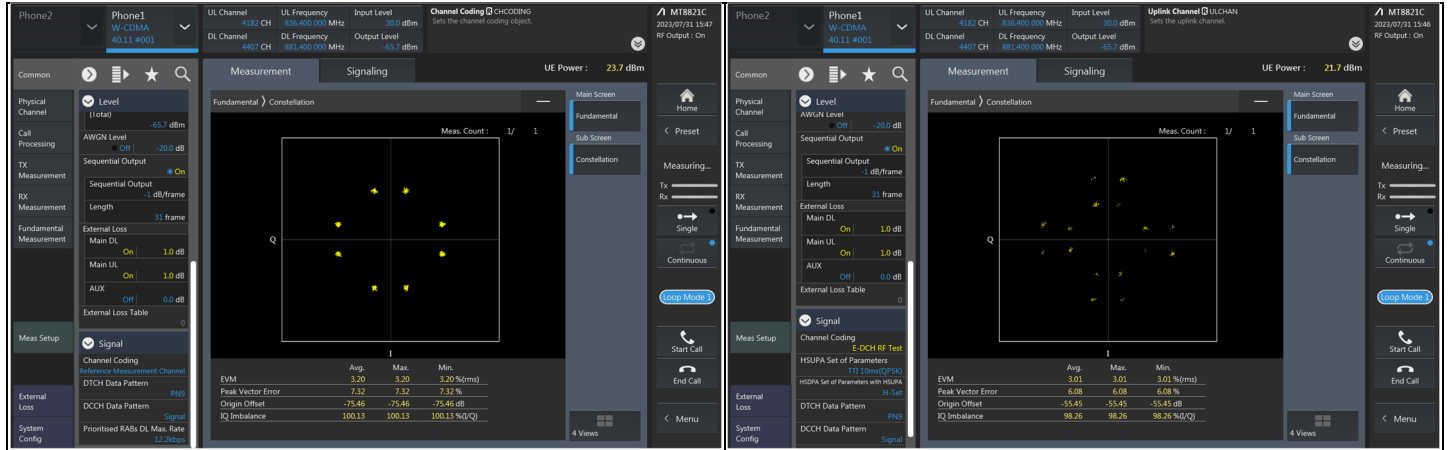

WCDMA CH 4182 (836.4 MHz)

HSPA CH 4182 (836.4 MHz)

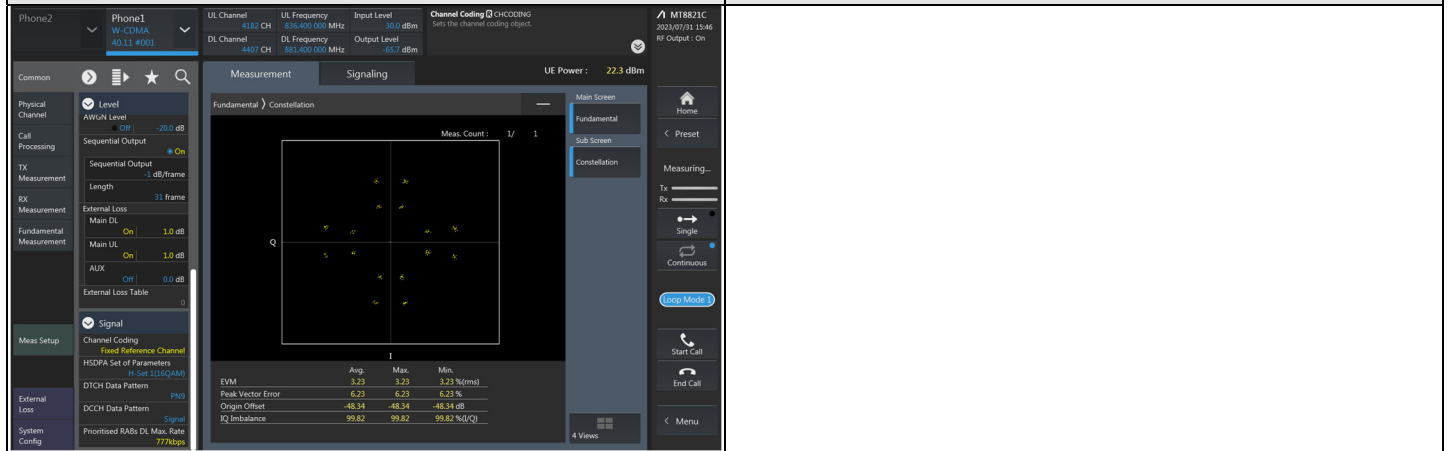

HSDPA CH 4182 (836.4 MHz)

7.2.6 LTE Band 2

LTE Band 2, Channel Bandwidth: 20 MHz

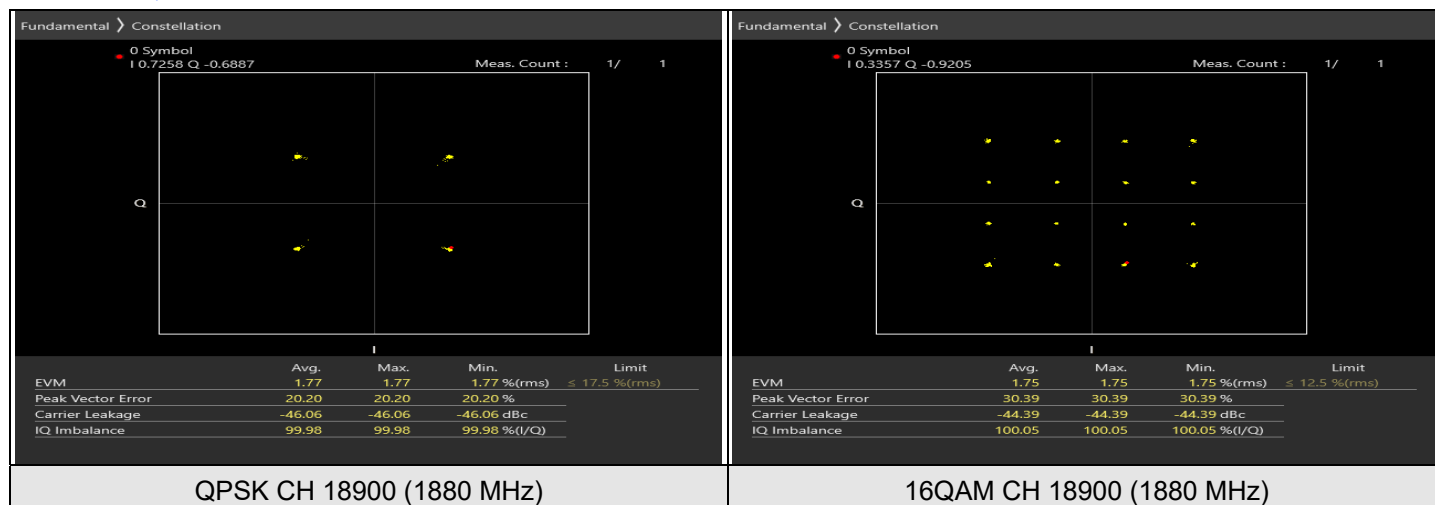

7.2.7 LTE Band 4

LTE Band 4, Channel Bandwidth: 20 MHz

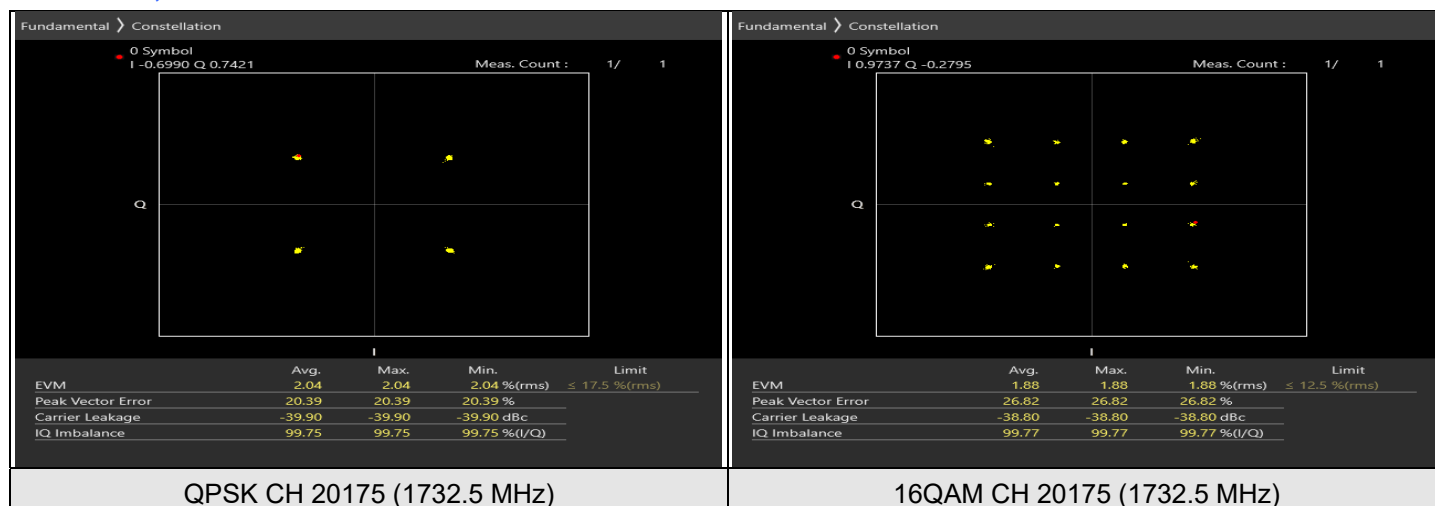

7.2.8 LTE Band 5

LTE Band 5, Channel Bandwidth: 10 MHz

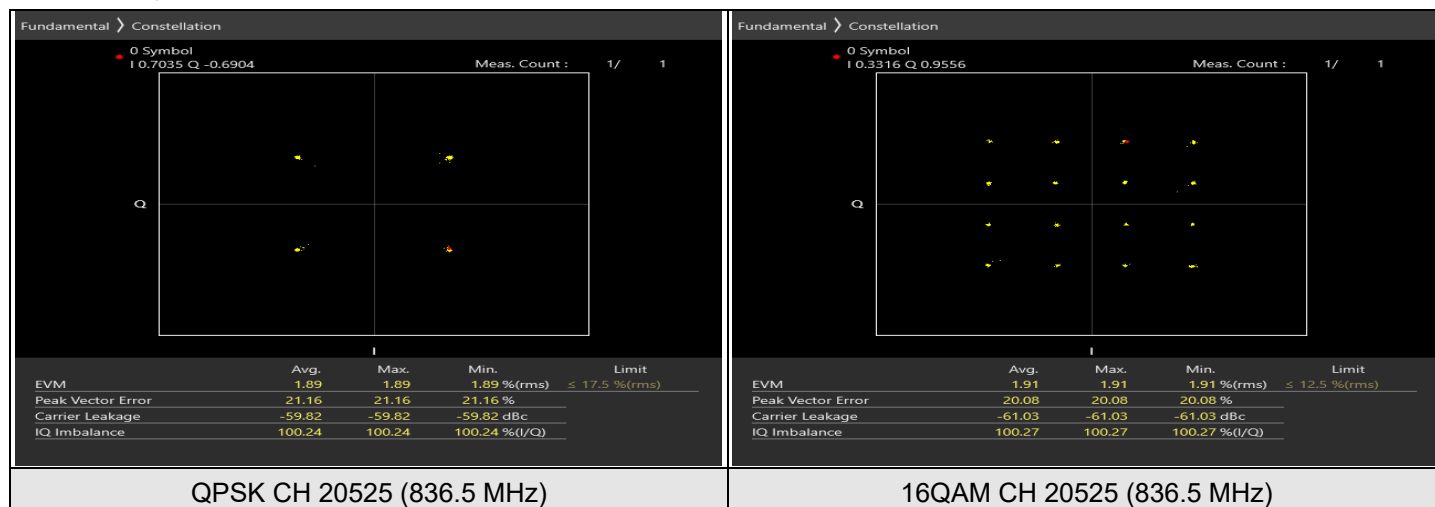

7.2.9 LTE Band 7

LTE Band 7, Channel Bandwidth: 20 MHz

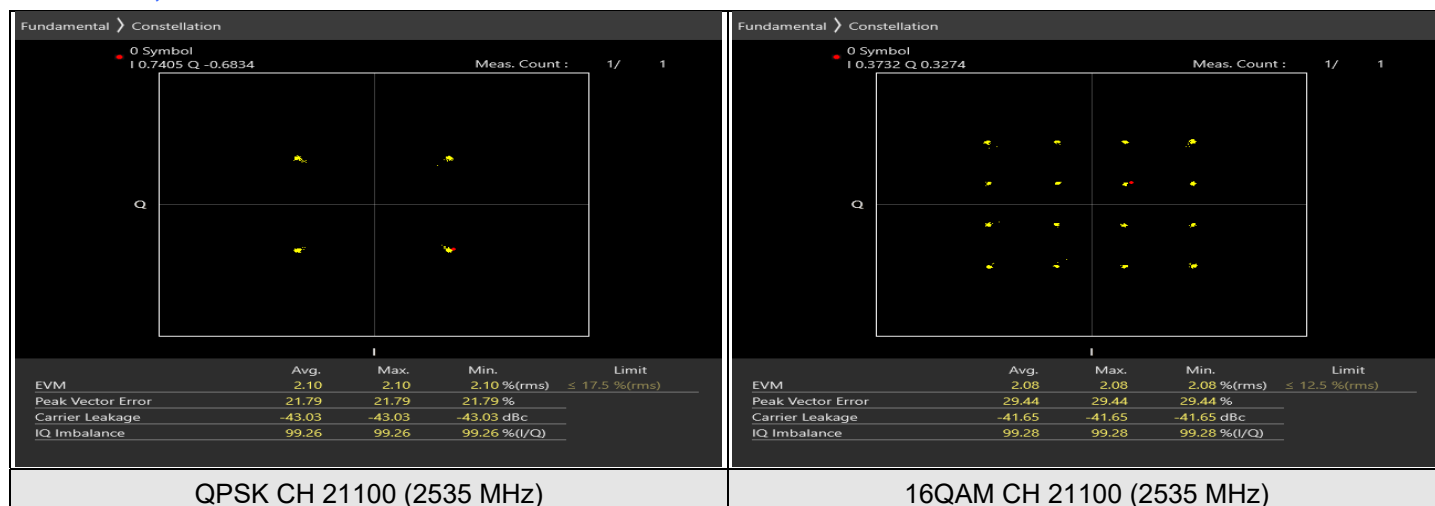

7.2.10 LTE Band 12

LTE Band 12, Channel Bandwidth: 10 MHz

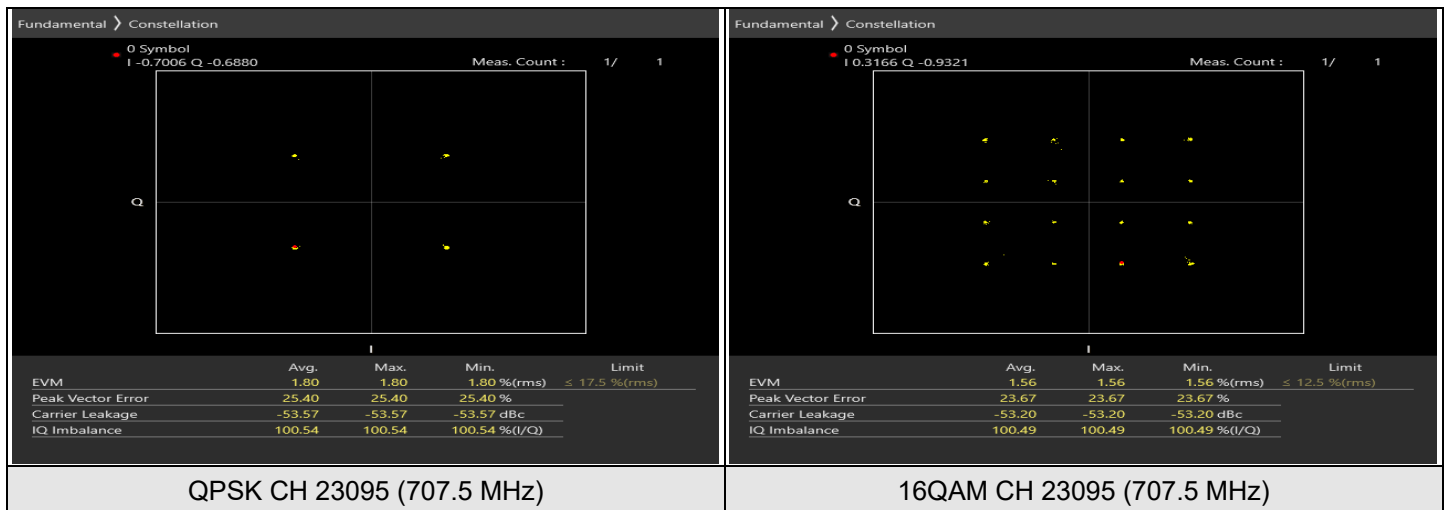

7.2.11 LTE Band 13

LTE Band 13, Channel Bandwidth: 10 MHz

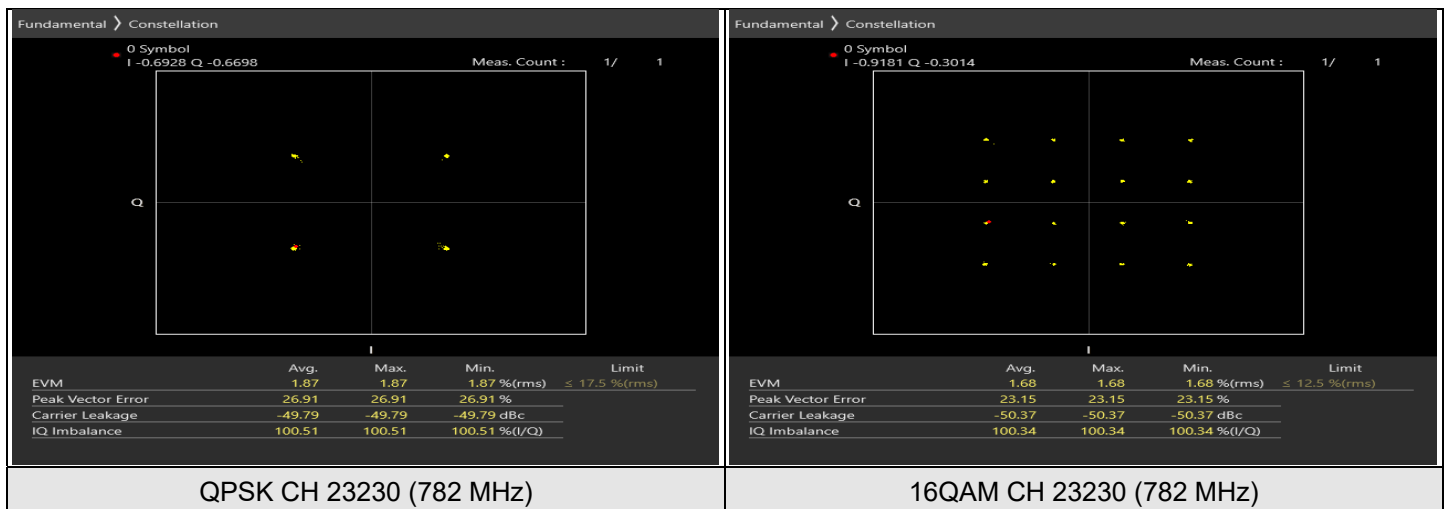

7.2.12 LTE Band 17

LTE Band 17, Channel Bandwidth: 10 MHz

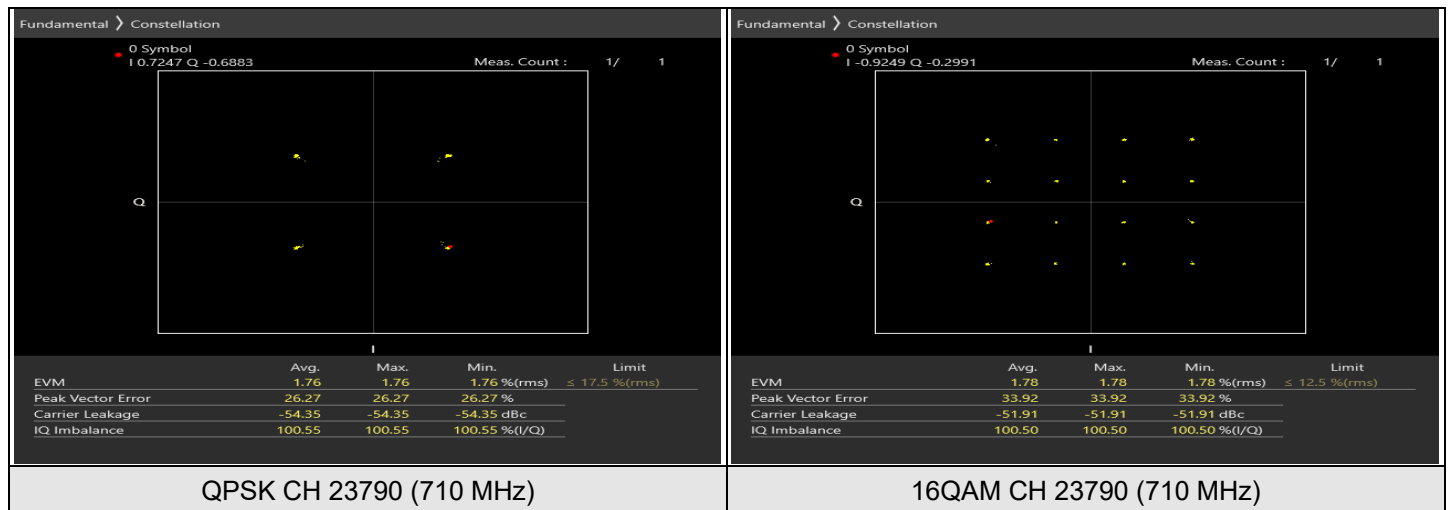

7.3 Peak to Average Ratio

Input Power:	3.8 Vdc	Environmental Conditions:	22°C, 68% RH	Tested By:	Noah Chang
--------------	---------	---------------------------	--------------	------------	------------

7.3.1 GSM850

Modulation	Channel	Frequency (MHz)	Measurement Value(dB)	Limit (dB)	Result
GSM	128	824.2	2.77	13	Pass
GSM	189	836.4	2.75	13	Pass
GSM	251	848.8	2.74	13	Pass
EDGE	128	824.2	2.77	13	Pass
EDGE	189	836.4	2.75	13	Pass
EDGE	251	848.8	2.75	13	Pass

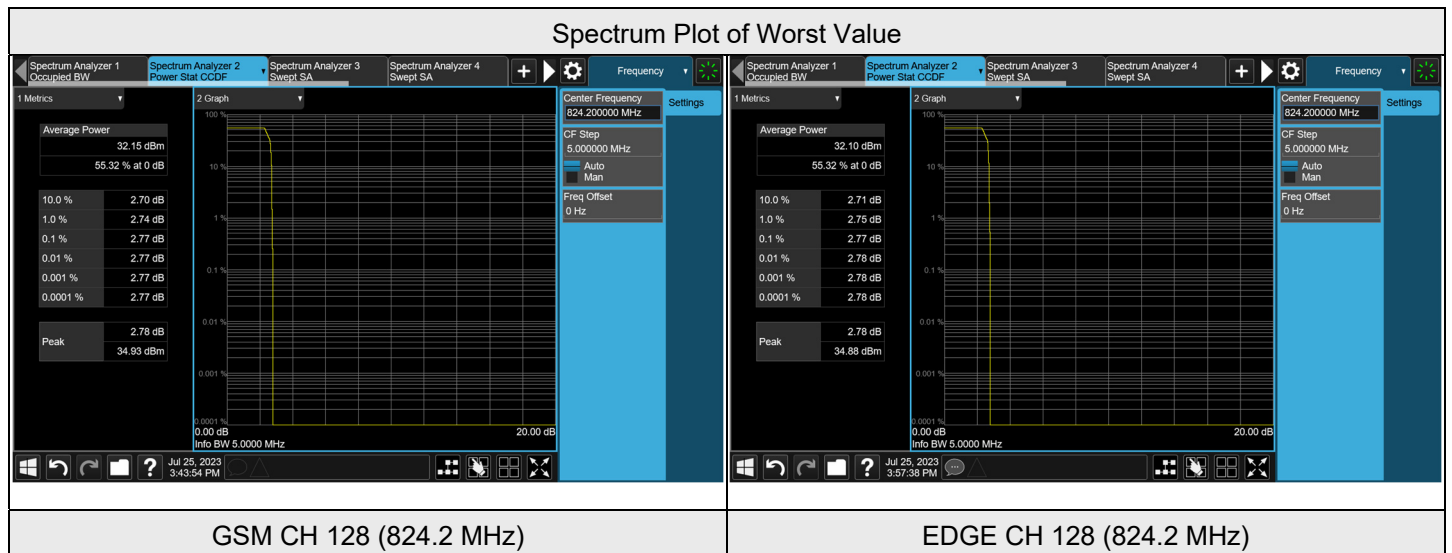

7.3.2 GSM1900

Modulation	Channel	Frequency (MHz)	Measurement Value(dB)	Limit (dB)	Result
GSM	512	1850.2	2.77	13	Pass
GSM	661	1880.0	2.80	13	Pass
GSM	810	1909.8	2.81	13	Pass
EDGE	512	1850.2	2.78	13	Pass
EDGE	661	1880.0	2.80	13	Pass
EDGE	810	1909.8	2.82	13	Pass

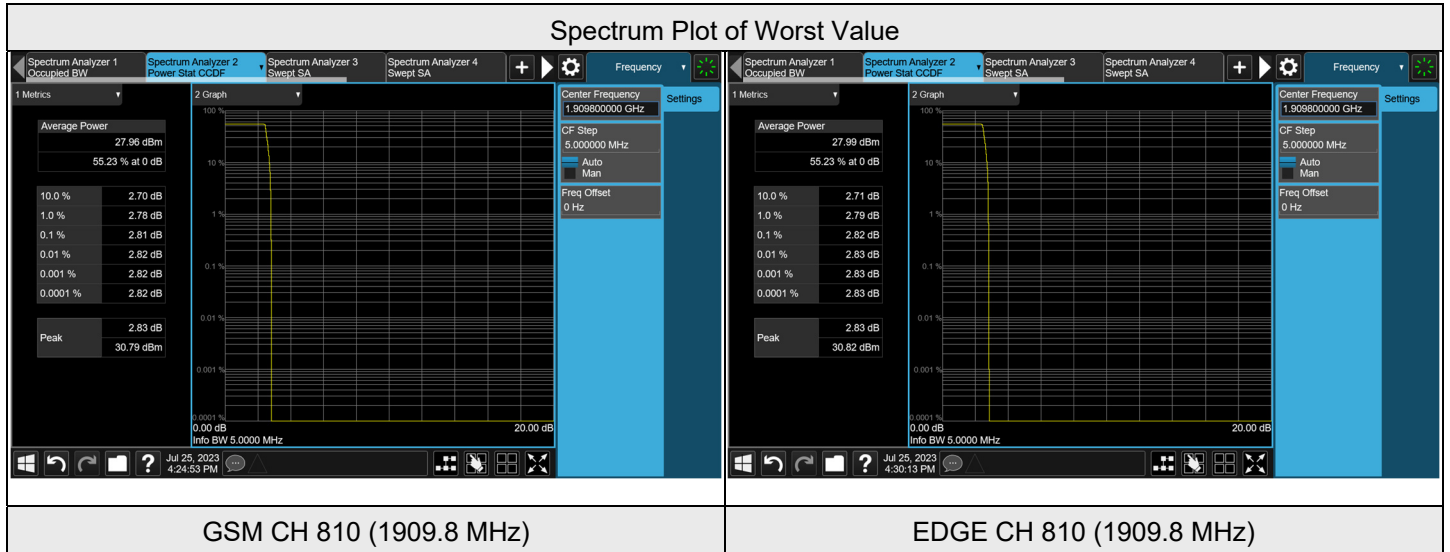

7.3.3 WCDMA Band 2

Modulation	Channel	Frequency (MHz)	Measurement Value(dB)	Limit (dB)	Result
WCDMA	9262	1852.4	3.36	13	Pass
WCDMA	9400	1880	3.33	13	Pass
WCDMA	9538	1907.6	3.46	13	Pass
HSDPA	9262	1852.4	3.86	13	Pass
HSDPA	9400	1880	3.94	13	Pass
HSDPA	9538	1907.6	4.05	13	Pass
HSUPA	9262	1852.4	3.79	13	Pass
HSUPA	9400	1880	3.72	13	Pass
HSUPA	9538	1907.6	4.04	13	Pass

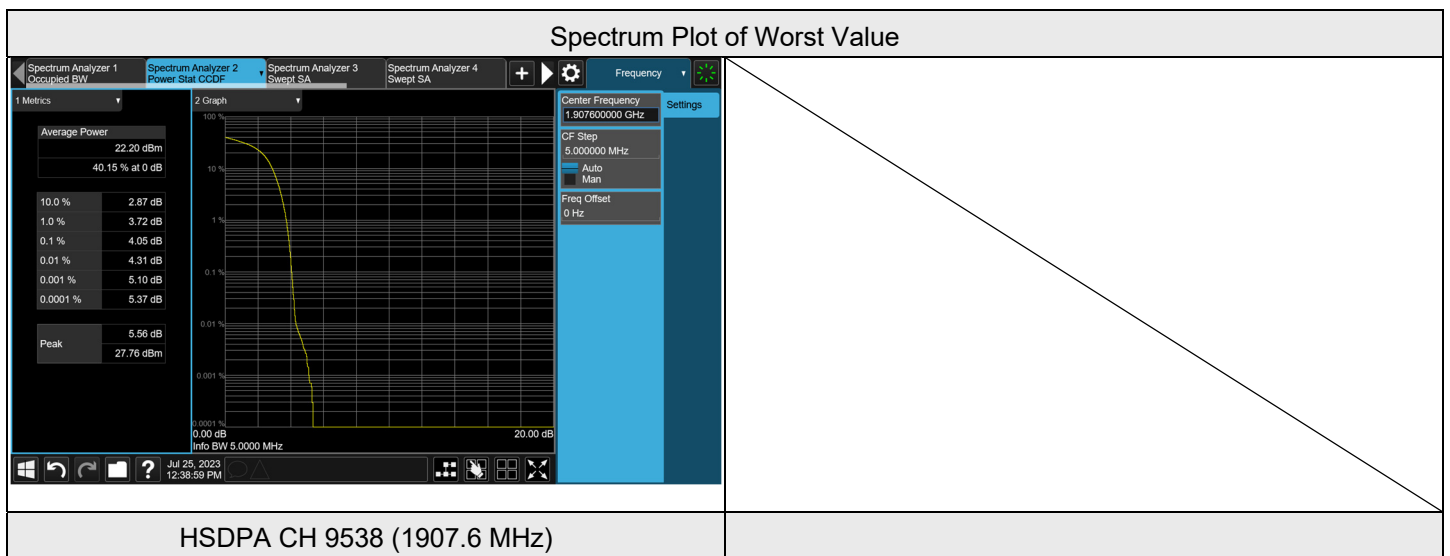

7.3.4 WCDMA Band 4

Modulation	Channel	Frequency (MHz)	Measurement Value(dB)	Limit (dB)	Result
WCDMA	1312	1712.4	3.56	13	Pass
WCDMA	1413	1732.6	3.60	13	Pass
WCDMA	1513	1752.6	3.65	13	Pass
HSDPA	1312	1712.4	4.00	13	Pass
HSDPA	1413	1732.6	3.99	13	Pass
HSDPA	1513	1752.6	4.07	13	Pass
HSUPA	1312	1712.4	3.90	13	Pass
HSUPA	1413	1732.6	3.94	13	Pass
HSUPA	1513	1752.6	3.95	13	Pass

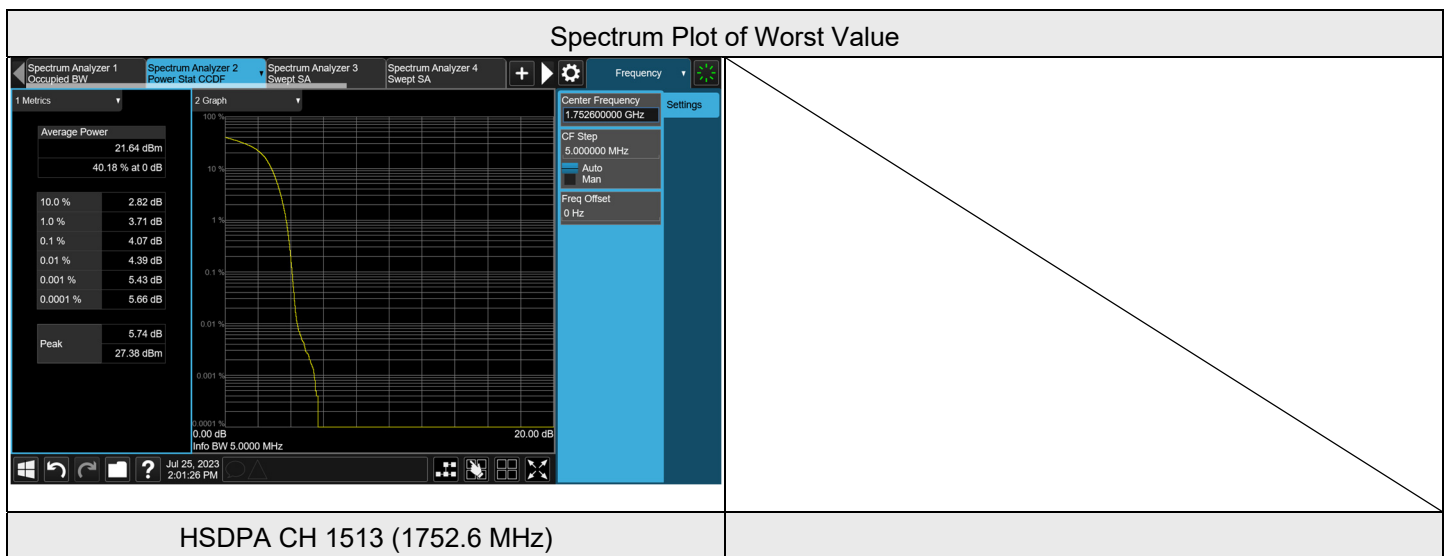

7.3.5 WCDMA Band 5

Modulation	Channel	Frequency (MHz)	Measurement Value(dB)	Limit (dB)	Result
WCDMA	4132	826.4	3.38	13	Pass
WCDMA	4182	836.4	3.52	13	Pass
WCDMA	4223	846.6	3.27	13	Pass
HSDPA	4132	826.4	3.88	13	Pass
HSDPA	4182	836.4	4.02	13	Pass
HSDPA	4223	846.6	3.97	13	Pass
HSUPA	4132	826.4	3.93	13	Pass
HSUPA	4182	836.4	3.96	13	Pass
HSUPA	4223	846.6	3.98	13	Pass

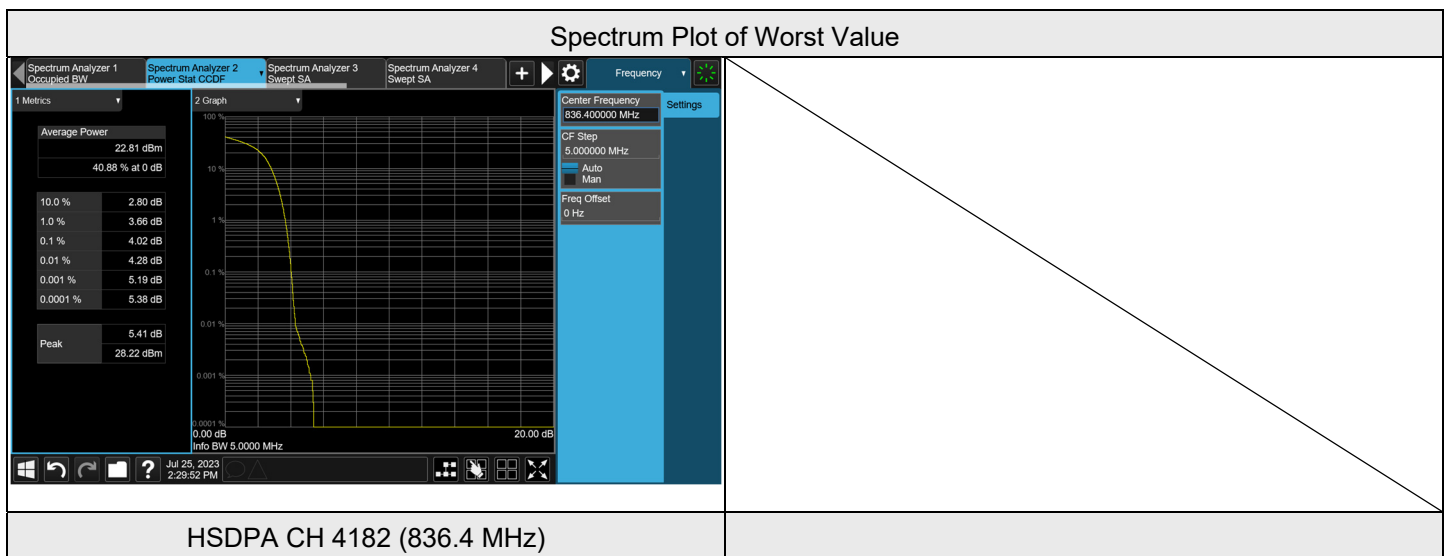

7.3.6 LTE Band 2

LTE Band 2, Channel Bandwidth: 1.4 MHz

Modulation	Channel	Frequency (MHz)	Measurement Value(dB)	Limit (dB)	Result
QPSK	18607	1850.7	5.06	13	PASS
QPSK	18900	1880	4.99	13	PASS
QPSK	19193	1909.3	4.98	13	PASS
16QAM	18607	1850.7	5.97	13	PASS
16QAM	18900	1880	5.93	13	PASS
16QAM	19193	1909.3	6.08	13	PASS

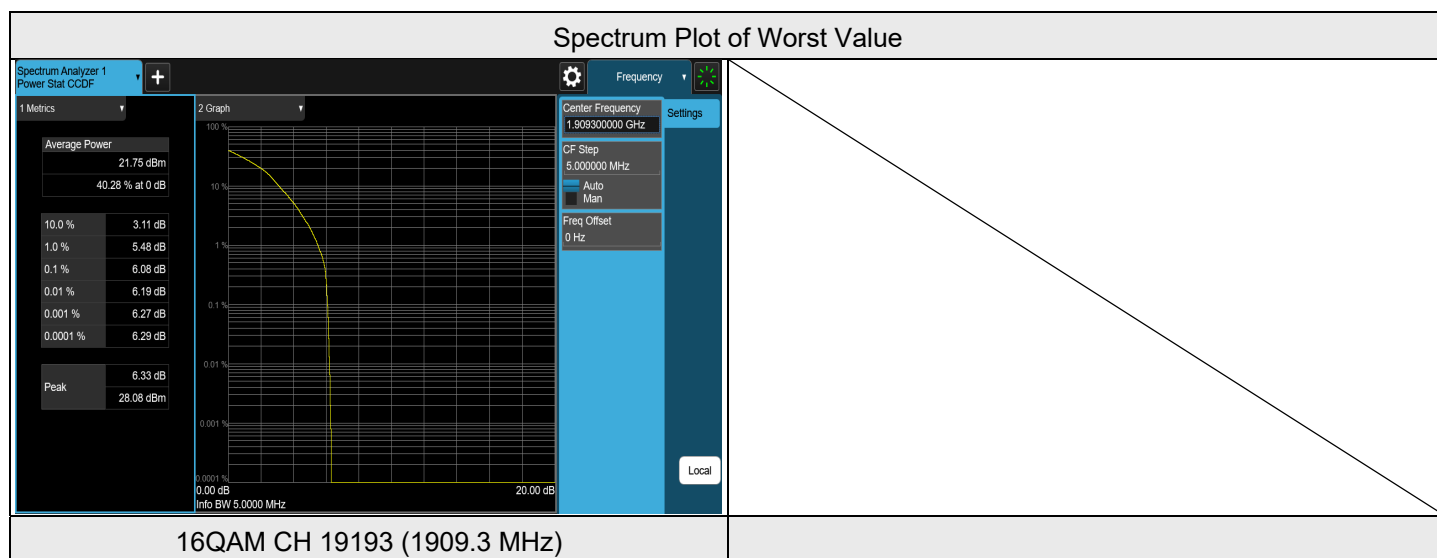

LTE Band 2, Channel Bandwidth: 3 MHz

Modulation	Channel	Frequency (MHz)	Measurement Value(dB)	Limit (dB)	Result
QPSK	18615	1851.5	5.05	13	PASS
QPSK	18900	1880	5.02	13	PASS
QPSK	19185	1908.5	4.96	13	PASS
16QAM	18615	1851.5	6.05	13	PASS
16QAM	18900	1880	5.96	13	PASS
16QAM	19185	1908.5	6.07	13	PASS

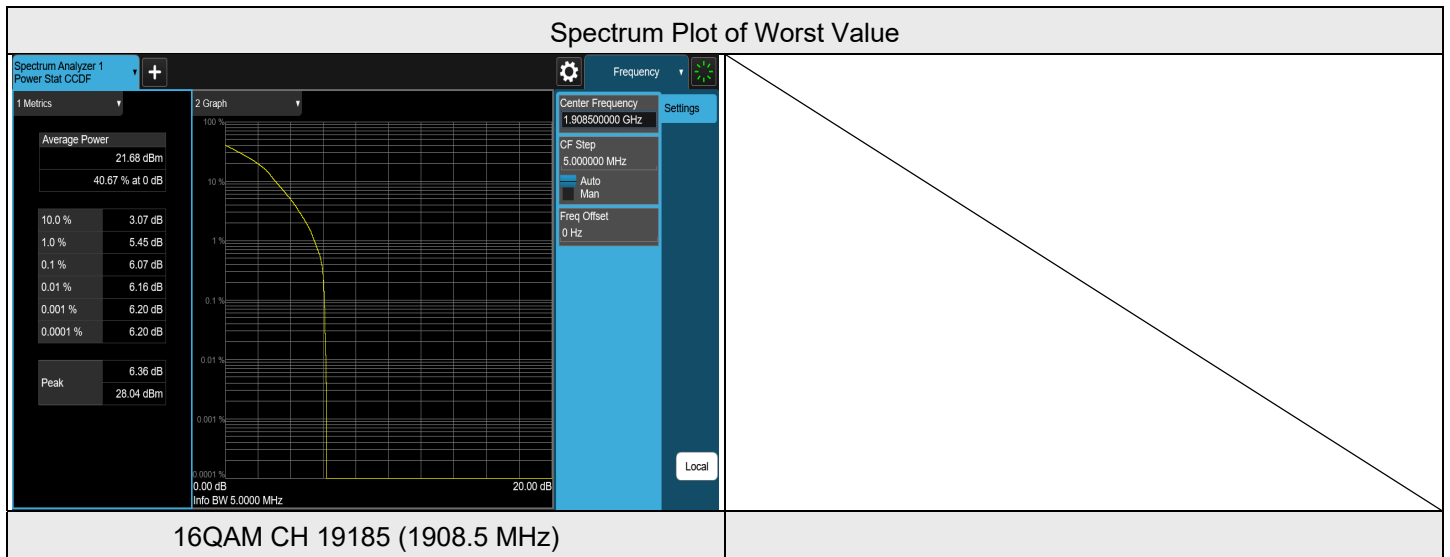

LTE Band 2, Channel Bandwidth: 5 MHz

Modulation	Channel	Frequency (MHz)	Measurement Value(dB)	Limit (dB)	Result
QPSK	18625	1852.5	4.98	13	PASS
QPSK	18900	1880	4.96	13	PASS
QPSK	19175	1907.5	4.98	13	PASS
16QAM	18625	1852.5	6.00	13	PASS
16QAM	18900	1880	5.89	13	PASS
16QAM	19175	1907.5	5.92	13	PASS

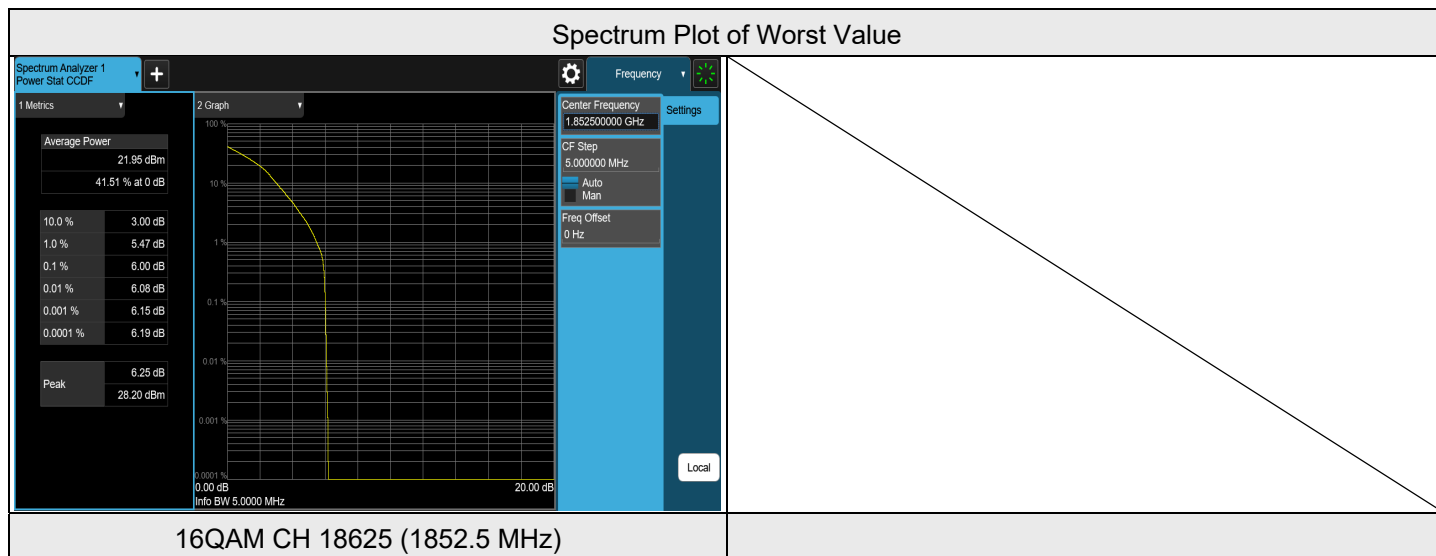



LTE Band 2, Channel Bandwidth: 10 MHz

Modulation	Channel	Frequency (MHz)	Measurement Value(dB)	Limit (dB)	Result
QPSK	18650	1855	4.93	13	PASS
QPSK	18900	1880	4.96	13	PASS
QPSK	19150	1905	5.02	13	PASS
16QAM	18650	1855	5.93	13	PASS
16QAM	18900	1880	5.91	13	PASS
16QAM	19150	1905	5.95	13	PASS

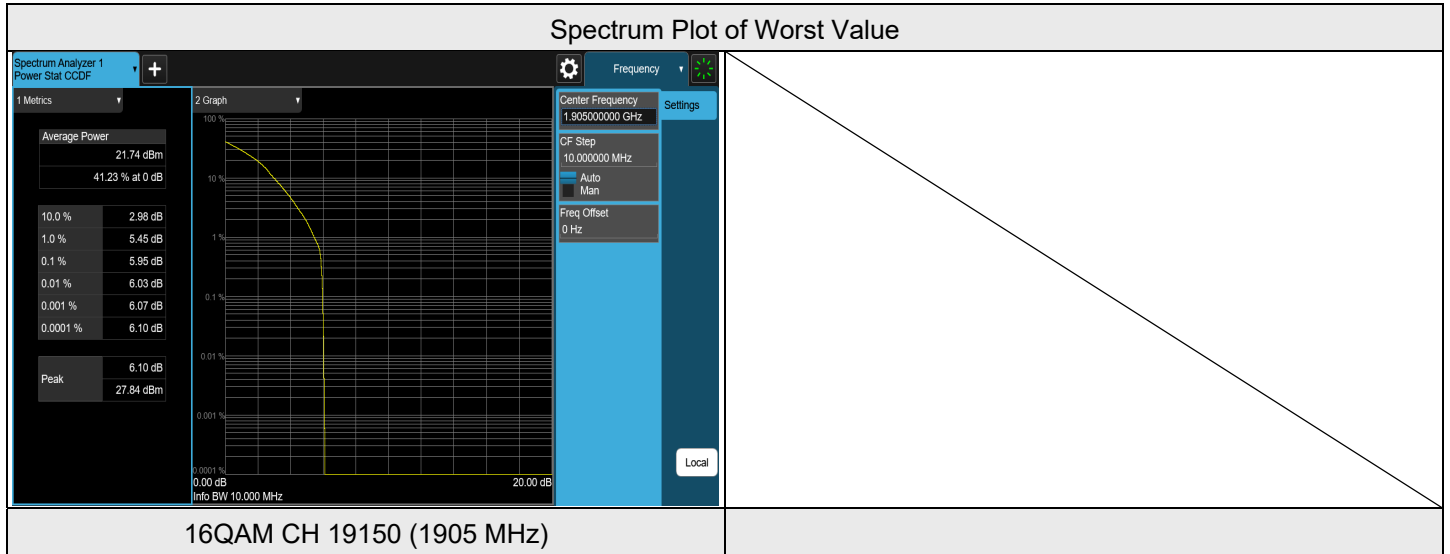



LTE Band 2, Channel Bandwidth: 15 MHz

Modulation	Channel	Frequency (MHz)	Measurement Value(dB)	Limit (dB)	Result
QPSK	18675	1857.5	4.94	13	PASS
QPSK	18900	1880	4.97	13	PASS
QPSK	19125	1902.5	5.11	13	PASS
16QAM	18675	1857.5	5.95	13	PASS
16QAM	18900	1880	5.98	13	PASS
16QAM	19125	1902.5	6.02	13	PASS

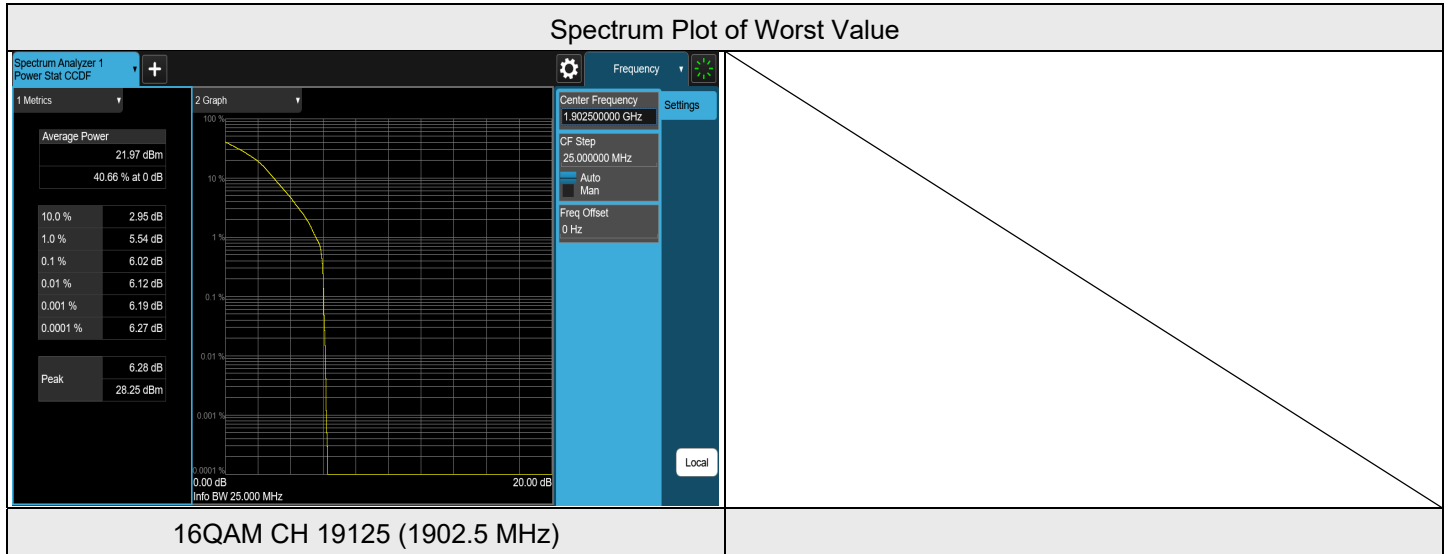



LTE Band 2, Channel Bandwidth: 20 MHz

Modulation	Channel	Frequency (MHz)	Measurement Value(dB)	Limit (dB)	Result
QPSK	18700	1860	4.89	13	PASS
QPSK	18900	1880	4.98	13	PASS
QPSK	19100	1900	5.01	13	PASS
16QAM	18700	1860	5.91	13	PASS
16QAM	18900	1880	6.05	13	PASS
16QAM	19100	1900	5.96	13	PASS

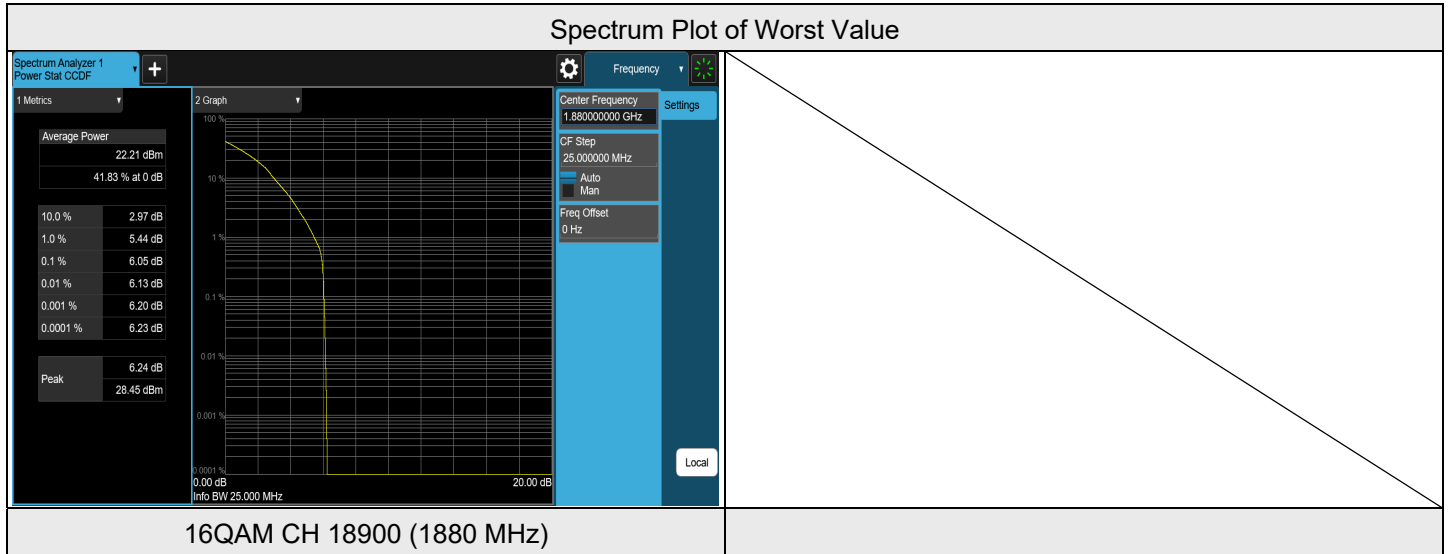

7.3.7 LTE Band 4

LTE Band 4, Channel Bandwidth: 1.4 MHz

Modulation	Channel	Frequency (MHz)	Measurement Value(dB)	Limit (dB)	Result
QPSK	19957	1710.7	5.23	13	PASS
QPSK	20175	1732.5	5.26	13	PASS
QPSK	20393	1754.3	5.30	13	PASS
16QAM	19957	1710.7	6.18	13	PASS
16QAM	20175	1732.5	6.23	13	PASS
16QAM	20393	1754.3	6.30	13	PASS

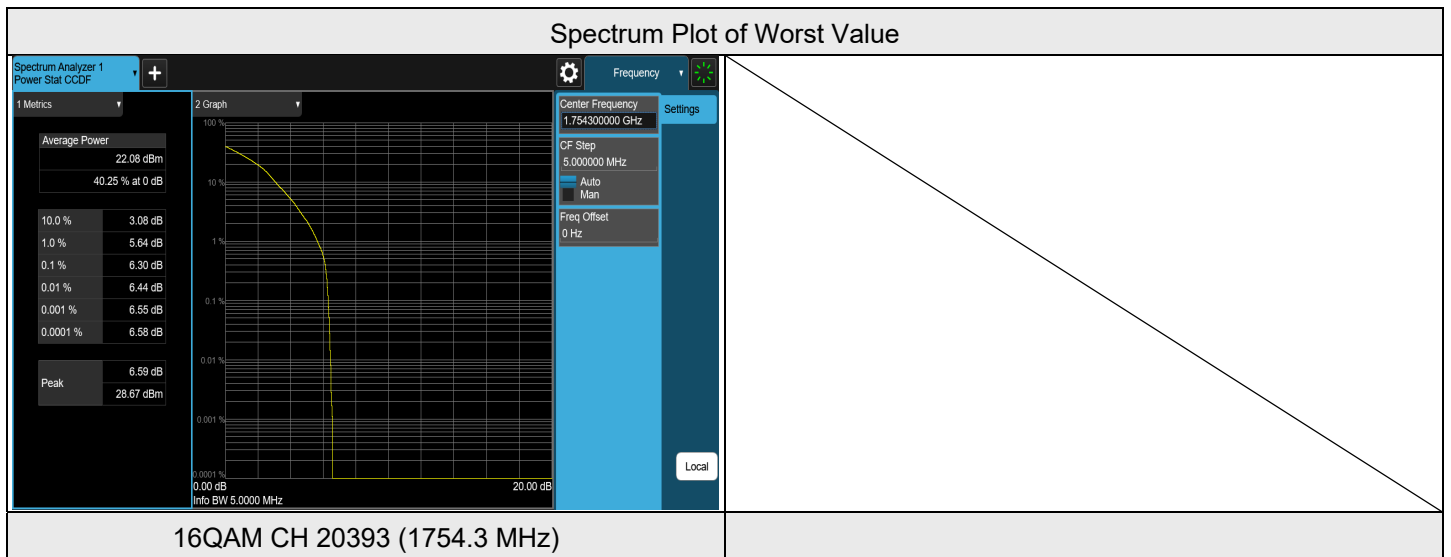



LTE Band 4, Channel Bandwidth: 3 MHz

Test Condition	Channel	Frequency (MHz)	Measure. Value(dB)	Limit dB	Result
QPSK	19965	1711.5	5.23	13	PASS
QPSK	20175	1732.5	5.23	13	PASS
QPSK	20385	1753.5	5.28	13	PASS
16QAM	19965	1711.5	6.16	13	PASS
16QAM	20175	1732.5	6.21	13	PASS
16QAM	20385	1753.5	6.31	13	PASS

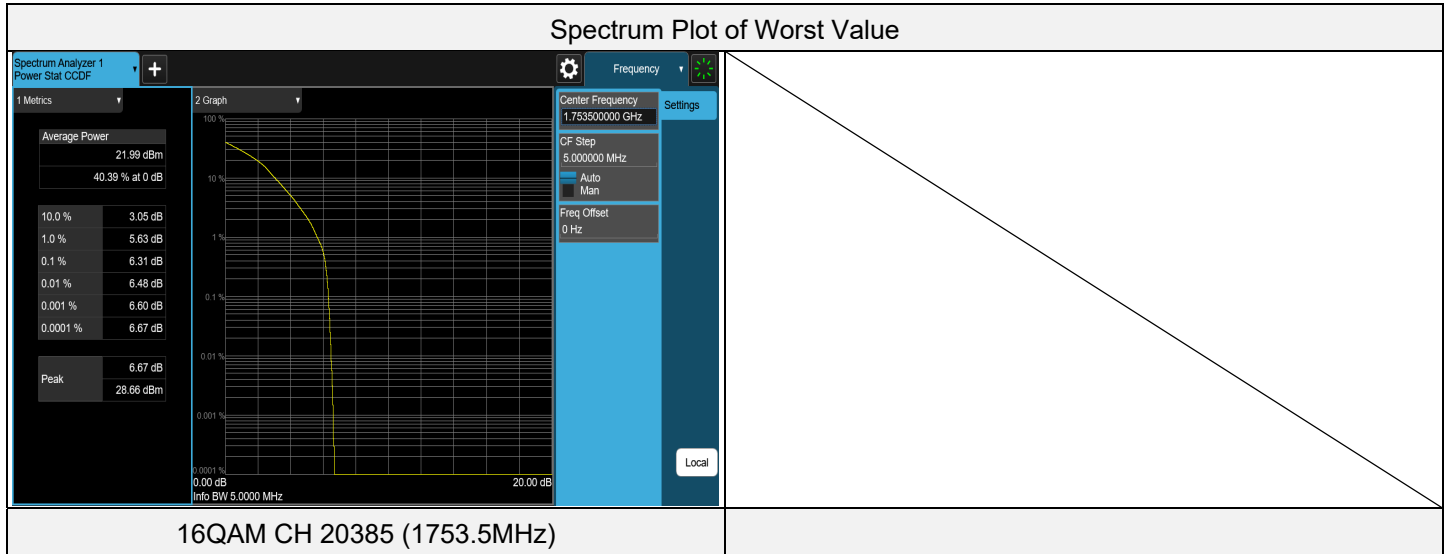



LTE Band 4, Channel Bandwidth: 5 MHz

Modulation	Channel	Frequency (MHz)	Measurement Value(dB)	Limit (dB)	Result
QPSK	19975	1712.5	5.17	13	PASS
QPSK	20175	1732.5	5.17	13	PASS
QPSK	20375	1752.5	5.22	13	PASS
16QAM	19975	1712.5	6.12	13	PASS
16QAM	20175	1732.5	6.16	13	PASS
16QAM	20375	1752.5	6.22	13	PASS

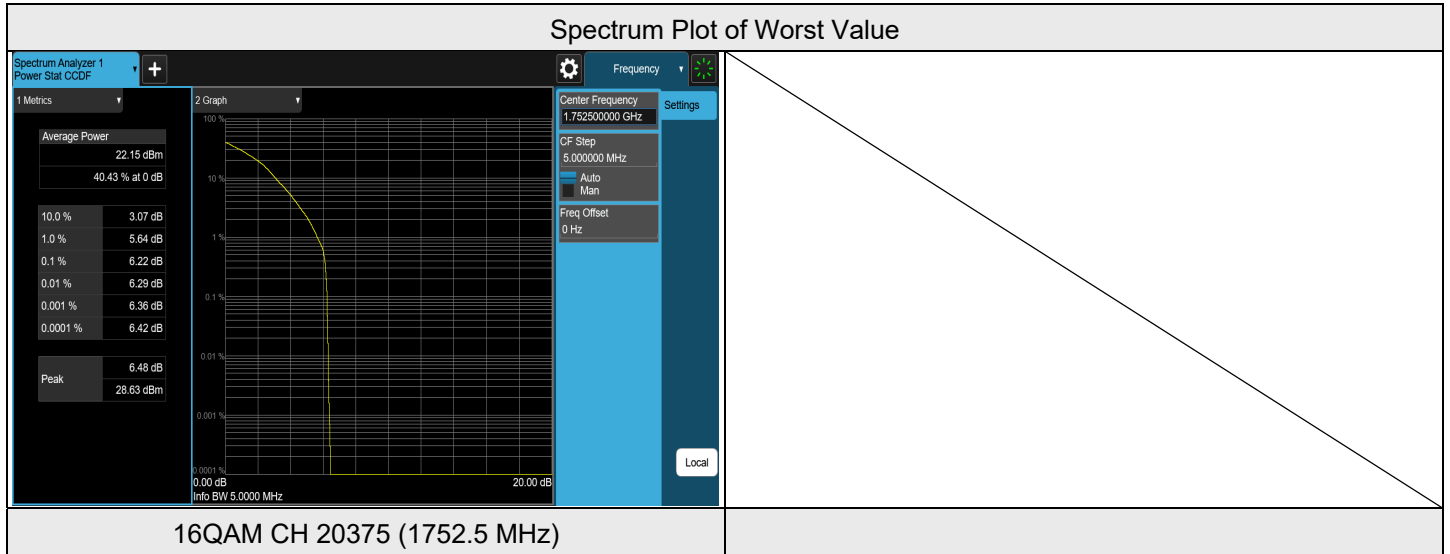



LTE Band 4, Channel Bandwidth: 10 MHz

Modulation	Channel	Frequency (MHz)	Measurement Value(dB)	Limit (dB)	Result
QPSK	20000	1715	5.15	13	PASS
QPSK	20175	1732.5	5.16	13	PASS
QPSK	20350	1750	5.15	13	PASS
16QAM	20000	1715	6.14	13	PASS
16QAM	20175	1732.5	6.16	13	PASS
16QAM	20350	1750	6.13	13	PASS

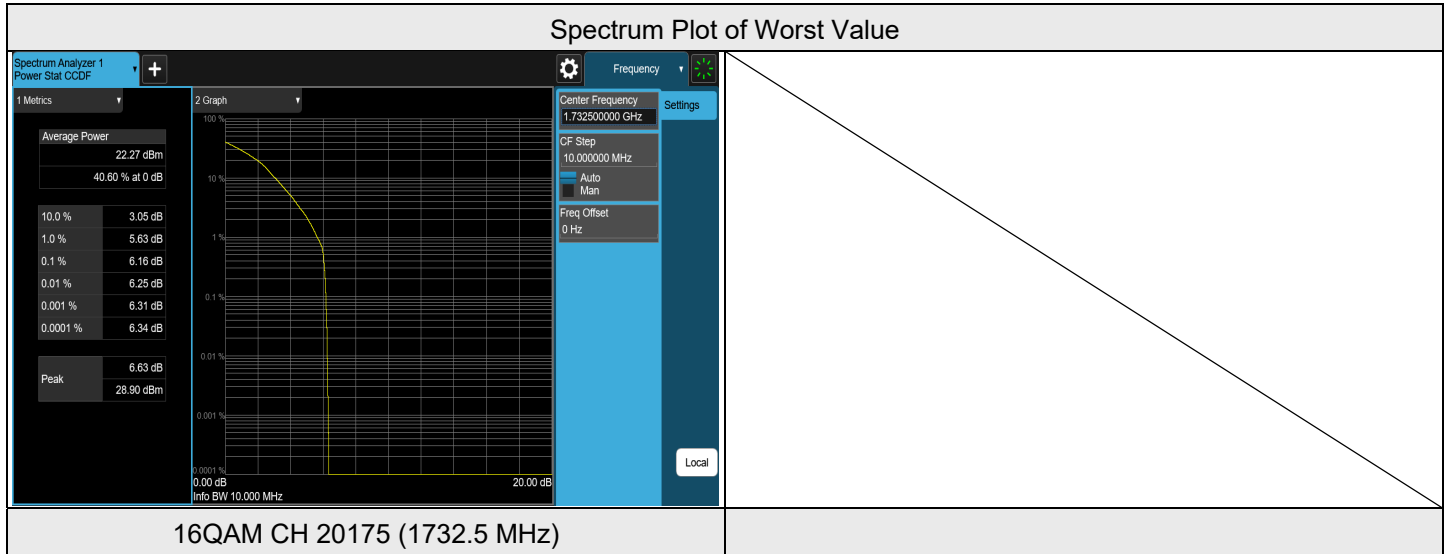



LTE Band 4, Channel Bandwidth: 15 MHz

Modulation	Channel	Frequency (MHz)	Measurement Value(dB)	Limit (dB)	Result
QPSK	20025	1717.5	5.09	13	PASS
QPSK	20175	1732.5	5.15	13	PASS
QPSK	20325	1747.5	5.13	13	PASS
16QAM	20025	1717.5	6.08	13	PASS
16QAM	20175	1732.5	6.18	13	PASS
16QAM	20325	1747.5	6.12	13	PASS

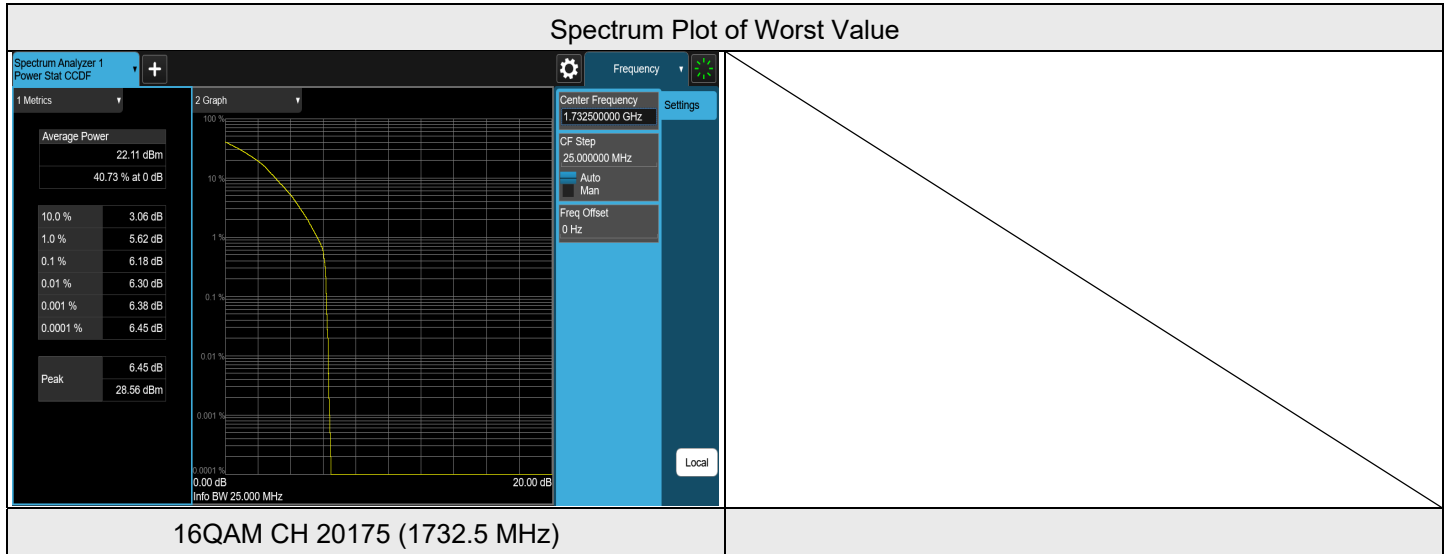



LTE Band 4, Channel Bandwidth: 20 MHz

Modulation	Channel	Frequency (MHz)	Measurement Value(dB)	Limit (dB)	Result
QPSK	20050	1720	5.10	13	PASS
QPSK	20175	1732.5	5.12	13	PASS
QPSK	20300	1745	5.10	13	PASS
16QAM	20050	1720	6.07	13	PASS
16QAM	20175	1732.5	6.12	13	PASS
16QAM	20300	1745	6.08	13	PASS

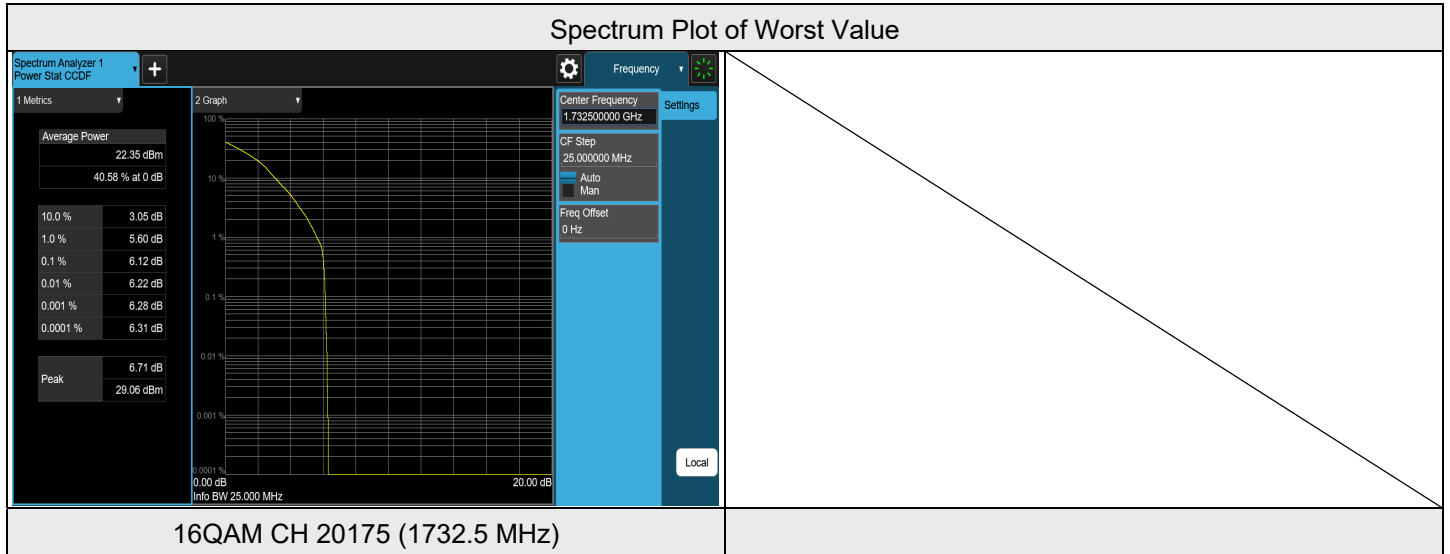

7.3.8 LTE Band 5

LTE Band 5, Channel Bandwidth: 1.4 MHz

Modulation	Channel	Frequency (MHz)	Measurement Value(dB)	Limit (dB)	Result
QPSK	20407	824.7	4.42	13	PASS
QPSK	20525	836.5	5.00	13	PASS
QPSK	20643	848.3	4.86	13	PASS
16QAM	20407	824.7	5.24	13	PASS
16QAM	20525	836.5	5.95	13	PASS
16QAM	20643	848.3	5.75	13	PASS

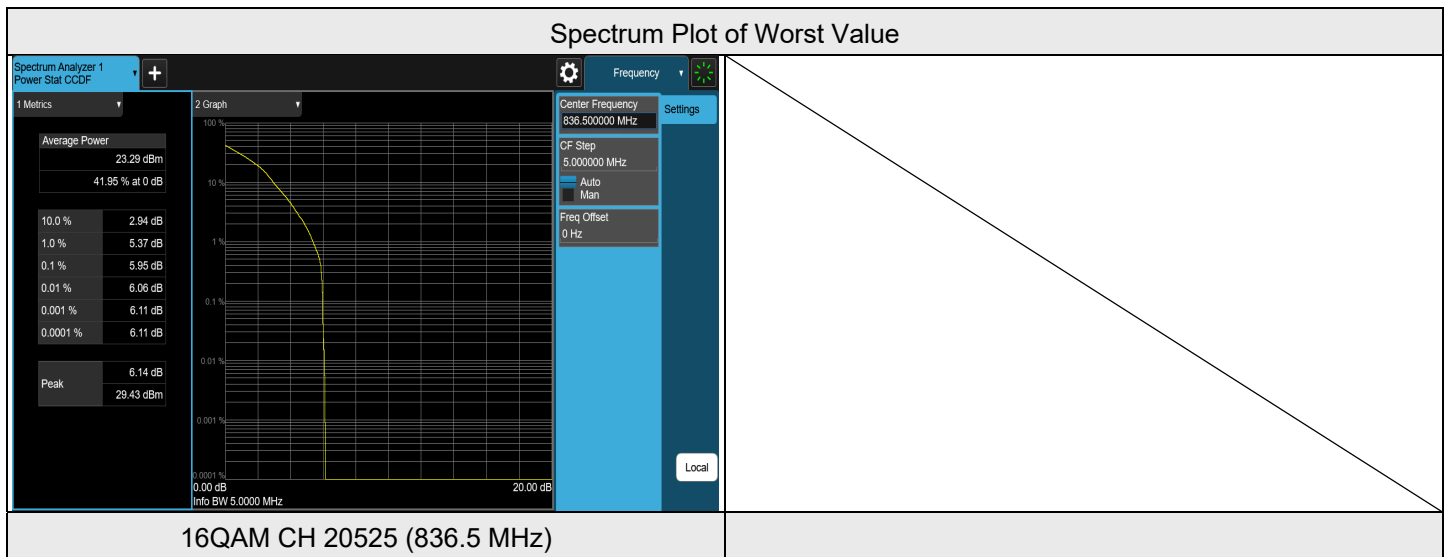

LTE Band 5, Channel Bandwidth: 3 MHz

Modulation	Channel	Frequency (MHz)	Measurement Value(dB)	Limit (dB)	Result
QPSK	20415	825.5	4.39	13	PASS
QPSK	20525	836.5	5.05	13	PASS
QPSK	20635	847.5	4.76	13	PASS
16QAM	20415	825.5	5.27	13	PASS
16QAM	20525	836.5	5.98	13	PASS
16QAM	20635	847.5	5.72	13	PASS

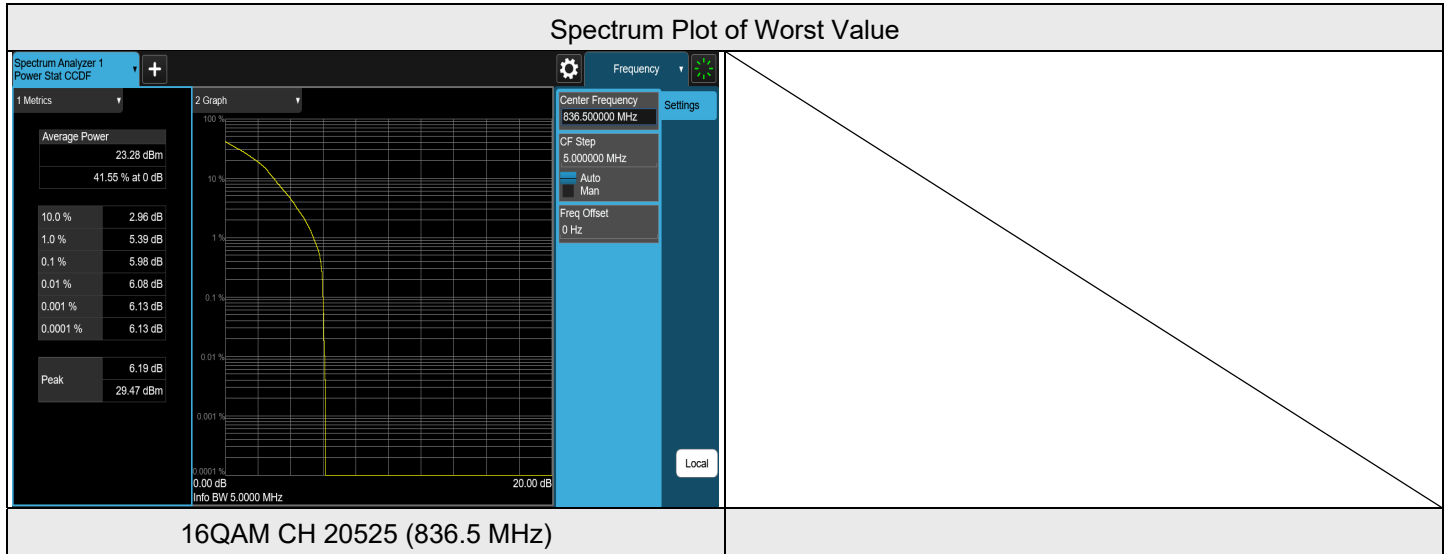

LTE Band 5, Channel Bandwidth: 5 MHz

Modulation	Channel	Frequency (MHz)	Measurement Value(dB)	Limit (dB)	Result
QPSK	20425	826.5	4.38	13	PASS
QPSK	20525	836.5	5.02	13	PASS
QPSK	20625	846.5	4.61	13	PASS
16QAM	20425	826.5	5.31	13	PASS
16QAM	20525	836.5	5.93	13	PASS
16QAM	20625	846.5	5.53	13	PASS

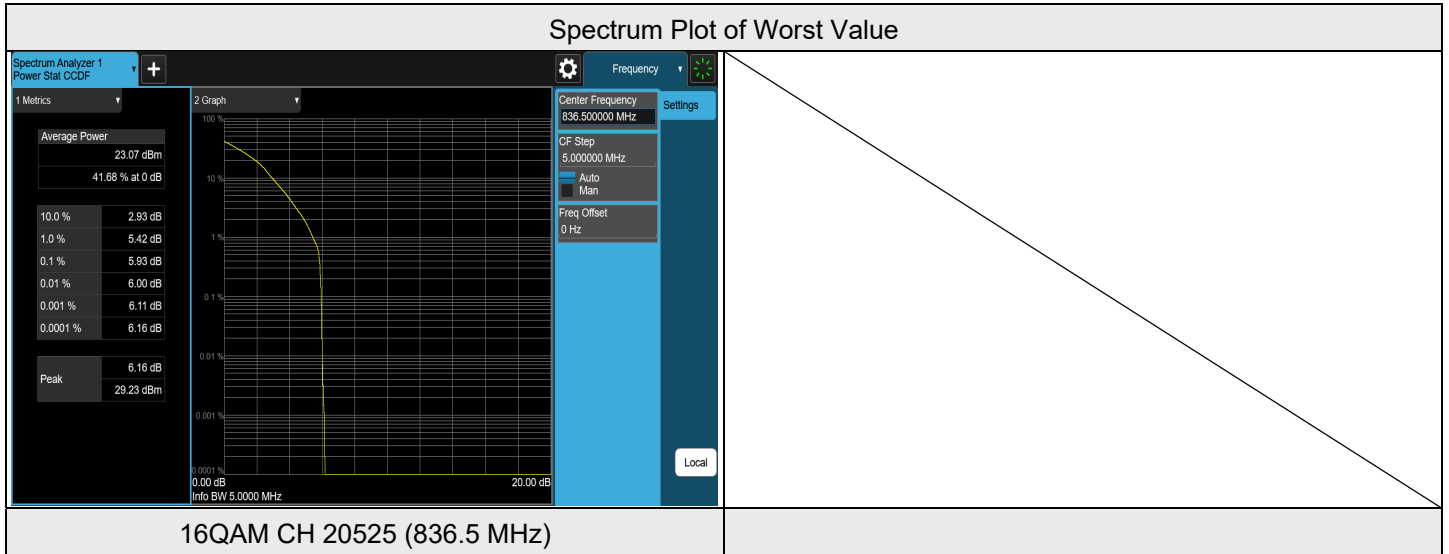



LTE Band 5, Channel Bandwidth: 10 MHz

Modulation	Channel	Frequency (MHz)	Measurement Value(dB)	Limit (dB)	Result
QPSK	20450	829	4.39	13	PASS
QPSK	20525	836.5	4.87	13	PASS
QPSK	20600	844	4.76	13	PASS
16QAM	20450	829	5.30	13	PASS
16QAM	20525	836.5	5.84	13	PASS
16QAM	20600	844	5.65	13	PASS

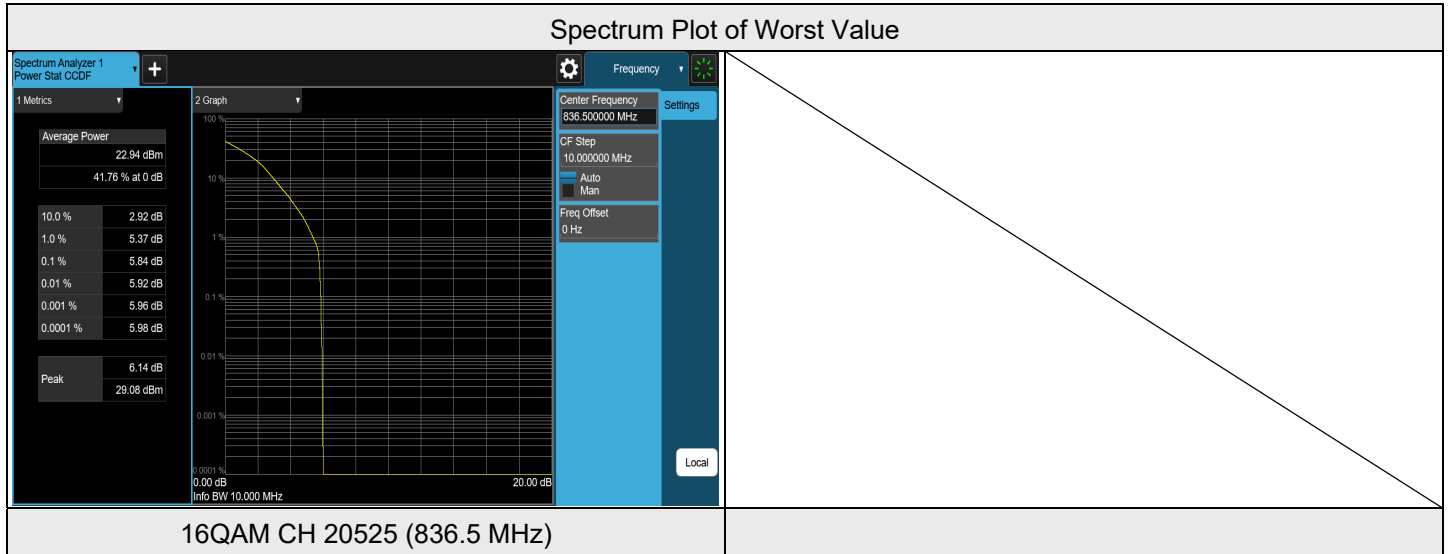

7.3.9 LTE Band 7

LTE Band 7, Channel Bandwidth: 5 MHz

Modulation	Channel	Frequency (MHz)	Measurement Value(dB)	Limit (dB)	Result
QPSK	20775	2502.5	4.04	13	PASS
QPSK	21100	2535	4.36	13	PASS
QPSK	21425	2567.5	3.86	13	PASS
16QAM	20775	2502.5	4.93	13	PASS
16QAM	21100	2535	5.37	13	PASS
16QAM	21425	2567.5	4.76	13	PASS

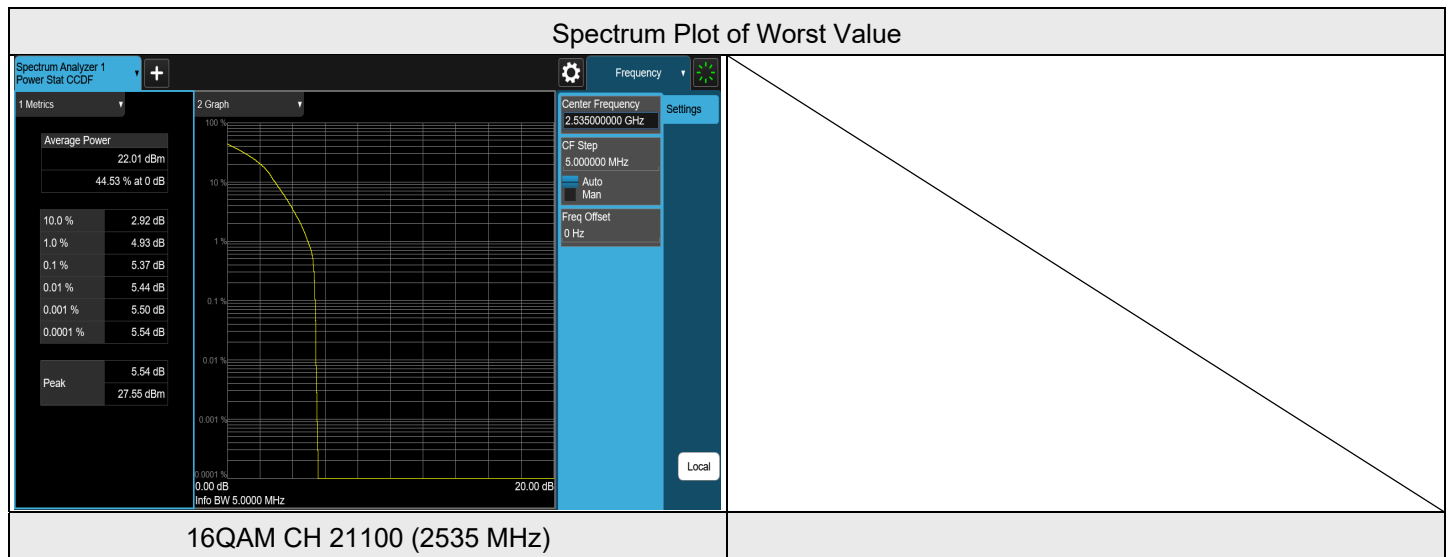

LTE Band 7, Channel Bandwidth: 10 MHz

Modulation	Channel	Frequency (MHz)	Measurement Value(dB)	Limit (dB)	Result
QPSK	20800	2505	4.00	13	PASS
QPSK	21100	2535	4.23	13	PASS
QPSK	21400	2565	3.99	13	PASS
16QAM	20800	2505	5.06	13	PASS
16QAM	21100	2535	5.22	13	PASS
16QAM	21400	2565	4.97	13	PASS

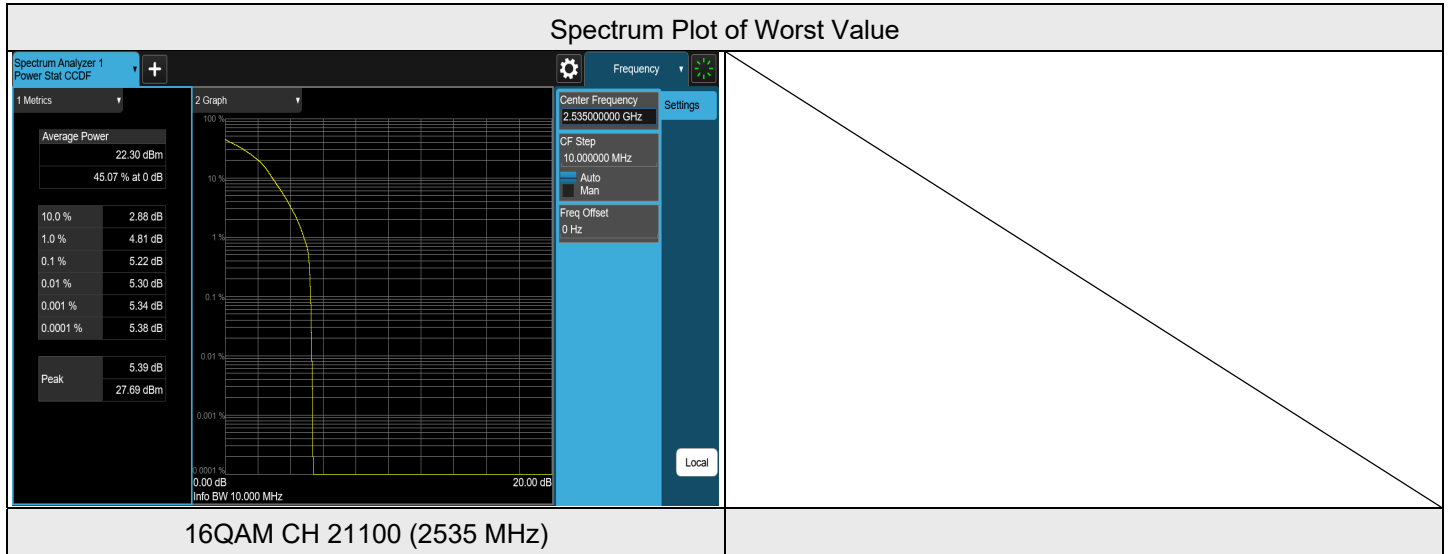



LTE Band 7, Channel Bandwidth: 15 MHz

Modulation	Channel	Frequency (MHz)	Measurement Value(dB)	Limit (dB)	Result
QPSK	20825	2507.5	3.98	13	PASS
QPSK	21100	2535	4.10	13	PASS
QPSK	21375	2562.5	4.08	13	PASS
16QAM	20825	2507.5	4.99	13	PASS
16QAM	21100	2535	5.13	13	PASS
16QAM	21375	2562.5	5.08	13	PASS

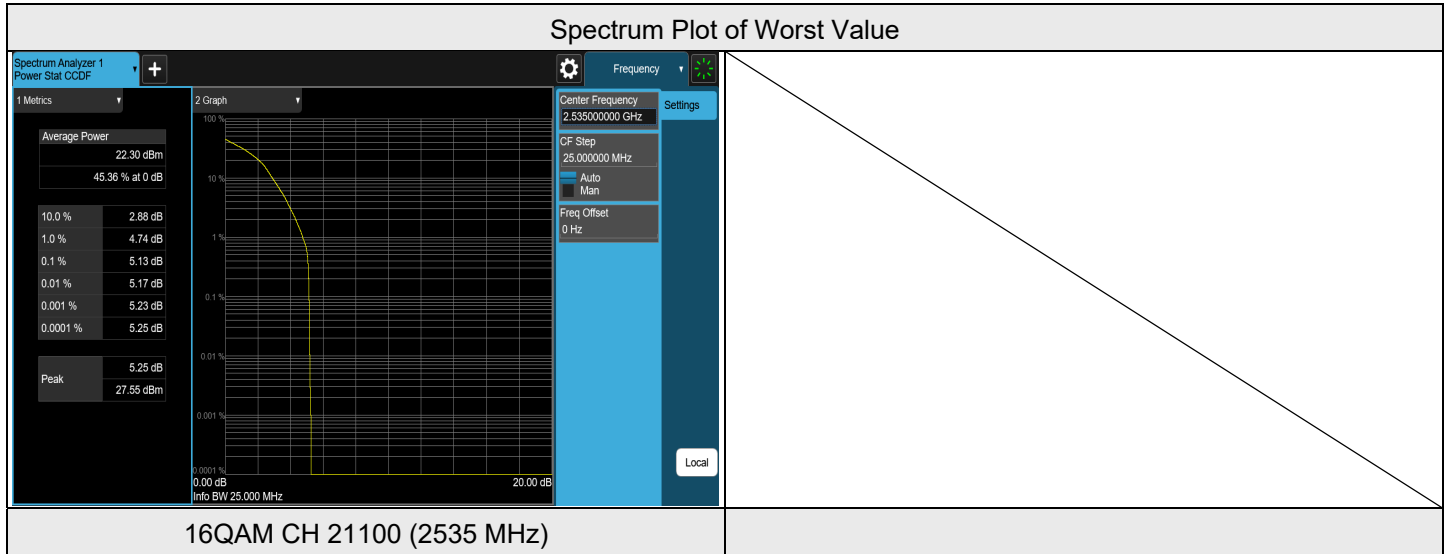

LTE Band 7, Channel Bandwidth: 20 MHz

Modulation	Channel	Frequency (MHz)	Measurement Value(dB)	Limit (dB)	Result
QPSK	20850	2510	4.01	13	PASS
QPSK	21100	2535	3.96	13	PASS
QPSK	21350	2560	4.23	13	PASS
16QAM	20850	2510	5.04	13	PASS
16QAM	21100	2535	4.98	13	PASS
16QAM	21350	2560	5.17	13	PASS

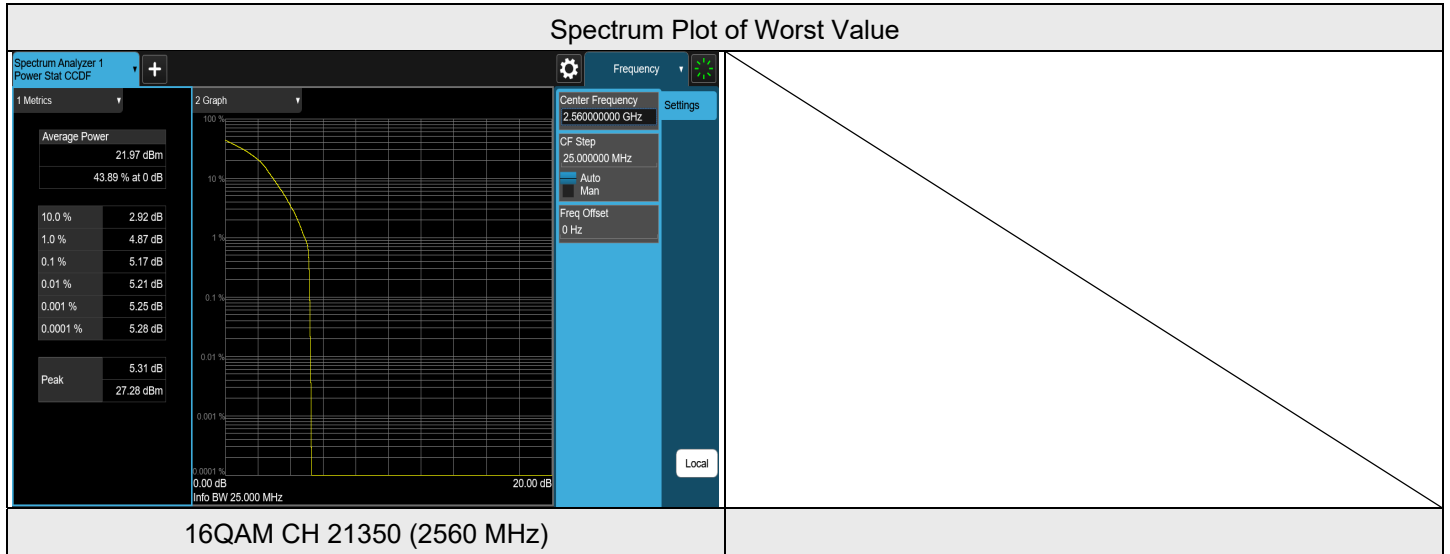

7.3.10 LTE Band 12

LTE Band 12, Channel Bandwidth: 1.4 MHz

Modulation	Channel	Frequency (MHz)	Measurement Value(dB)	Limit (dB)	Result
QPSK	23017	699.7	4.26	13	PASS
QPSK	23095	707.5	4.20	13	PASS
QPSK	23173	715.3	4.15	13	PASS
16QAM	23017	699.7	5.18	13	PASS
16QAM	23095	707.5	5.30	13	PASS
16QAM	23173	715.3	5.06	13	PASS

