

FCC C2PC Test Report

FCC ID : NKR-SY30
Equipment : WLAN/BT Module
Model No. : DHSR-SY30
Brand Name : Wistron NeWeb Corp.
Applicant : Wistron NeWeb Corp.
Address : 20 Park Avenue II, Hsinchu Science Park,
Hsinchu 308, Taiwan, R.O.C.
Standard : 47 CFR FCC Part 15.247
Received Date : Jun. 26, 2017
Tested Date : Jul. 12 ~ Jul. 14, 2017

We, International Certification Corp., would like to declare that the tested sample has been evaluated and in compliance with the requirement of the above standards. The test results contained in this report refer exclusively to the product. It may be duplicated completely for legal use with the approval of the applicant. It shall not be reproduced except in full without the written approval of our laboratory.

Reviewed by:



Along Chen / Assistant Manager

Approved by:



Gary Chang / Manager



Table of Contents

1	GENERAL DESCRIPTION	5
1.1	Information.....	5
1.2	Local Support Equipment List	14
1.3	Test Setup Chart	14
1.4	Test Equipment List and Calibration Data.....	15
1.5	Test Standards	16
1.6	Measurement Uncertainty	16
2	TEST CONFIGURATION	17
2.1	Testing Condition	17
2.2	The Worst Test Modes and Channel Details	17
3	TRANSMITTER TEST RESULTS.....	18
3.1	Conducted Emissions.....	18
3.2	Emissions in Restricted Frequency Bands.....	21
4	TEST LABORATORY INFORMATION	31

Release Record

Report No.	Version	Description	Issued Date
FR5D0701-02AE	Rev. 01	Initial issue	Jul. 24, 2017

Summary of Test Results

FCC Rules	Test Items	Measured	Result
15.207	AC Power Line Conducted Emissions	[dBuV]: 0.383MHz 25.37(Margin -22.84dB) - AV	Pass
15.247(d) 15.209	Radiated Emissions	[dBuV/m at 3m]: 12400.00MHz 42.64 (Margin -11.36dB) - AV	Pass

1 General Description

1.1 Information

This report is issued as a FCC Class II Permissive Change. The modifications are concerned with following item:

- ✧ Additional antenna cables are adding.

Related test items had been performed and recorded in the following sections. Other test results were kept as same as mentioned on original report.

1.1.1 Specification of the Equipment under Test (EUT)

RF General Information				
Frequency Range (MHz)	Bluetooth Mode	Ch. Freq. (MHz)	Channel Number	Data Rate
2400-2483.5	V4.2 LE	2402-2480	0-39 [40]	1 Mbps
Note 1: Bluetooth LE (Low energy) uses GFSK modulation.				

1.1.2 Antenna Details (Addition antenna cable had marked in boldface)

Ant. No.	Model	Type	Connector	Antenna Gain (dBi)
1	Antenna 1 (Green PCB, Cable 1)	Dipole	UFL	0.21
	Antenna 1 (Green PCB, Cable 1)	Dipole	UFL	0.69
2	Antenna 2 (Blue PCB, Cable 2)	Dipole	UFL	1.25
	Antenna 2 (Blue PCB, Cable 2)	Dipole	UFL	2.33

Note:

1. Antenna 2 with highest gain was chosen for final test.
2. Antenna structure is not changed. Reason to obtain higher antenna gain is shorter cable used.

The following antenna cables are used in this EUT. The only difference is cable length.

For Antenna 1 (Green PCB, Cable 1) / original

Cable No.	Model (Cable Color: Black)	Cable No.	Model (Cable Color: Gray)	Cable Length (mm)
1	8JJEKQ1990000001H1	22	8JJEKR1990000001H1	199
2	8JJEKQ2100000001H1	23	8JJEKR2100000001H1	210
3	8JJEKQ2200000001H1	24	8JJEKR2200000001H1	220
4	8JJEKQ2300000001H1	25	8JJEKR2300000001H1	230
5	8JJEKQ2400000001H1	26	8JJEKR2400000001H1	240
6	8JJEKQ2500000001H1	27	8JJEKR2500000001H1	250
7	8JJEKQ2600000001H1	28	8JJEKR2600000001H1	260
8	8JJEKQ2700000001H1	29	8JJEKR2700000001H1	270
9	8JJEKQ2800000001H1	30	8JJEKR2800000001H1	280
10	8JJEKQ2900000001H1	31	8JJEKR2900000001H1	290
11	8JJEKQ3000000001H1	32	8JJEKR3000000001H1	300
12	8JJEKQ3100000001H1	33	8JJEKR3100000001H1	310
13	8JJEKQ3200000001H1	34	8JJEKR3200000001H1	320
14	8JJEKQ3300000001H1	35	8JJEKR3300000001H1	330
15	8JJEKQ3400000001H1	36	8JJEKR3400000001H1	340
16	8JJEKQ3500000001H1	37	8JJEKR3500000001H1	350
17	8JJEKQ3600000001H1	38	8JJEKR3600000001H1	360
18	8JJEKQ3700000001H1	39	8JJEKR3700000001H1	370
19	8JJEKQ3800000001H1	40	8JJEKR3800000001H1	380
20	8JJEKQ3900000001H1	41	8JJEKR3900000001H1	390
21	8JJEKQ4000000001H1	42	8JJEKR4000000001H1	400

For Antenna 2 (Blue PCB, Cable 2) / original

Cable No.	Model (Cable Color: Black)	Cable No.	Model (Cable Color: Gray)	Cable No.	Model (Cable Color: White)	Cable Length (mm)
1	8JJEKQ400000001H1	52	8JJEKR400000001H1	103	8JJEKP400000001H1	400
2	8JJEKQ410000001H1	53	8JJEKR410000001H1	104	8JJEKP410000001H1	410
3	8JJEKQ420000001H1	54	8JJEKR420000001H1	105	8JJEKP420000001H1	420
4	8JJEKQ430000001H1	55	8JJEKR430000001H1	106	8JJEKP430000001H1	430
5	8JJEKQ440000001H1	56	8JJEKR440000001H1	107	8JJEKP440000001H1	440
6	8JJEKQ450000001H1	57	8JJEKR450000001H1	108	8JJEKP450000001H1	450
7	8JJEKQ460000001H1	58	8JJEKR460000001H1	109	8JJEKP460000001H1	460
8	8JJEKQ470000001H1	59	8JJEKR470000001H1	110	8JJEKP470000001H1	470
9	8JJEKQ480000001H1	60	8JJEKR480000001H1	111	8JJEKP480000001H1	480
10	8JJEKQ490000001H1	61	8JJEKR490000001H1	112	8JJEKP490000001H1	490
11	8JJEKQ500000001H1	62	8JJEKR500000001H1	113	8JJEKP500000001H1	500
12	8JJEKQ510000001H1	63	8JJEKR510000001H1	114	8JJEKP510000001H1	510
13	8JJEKQ520000001H1	64	8JJEKR520000001H1	115	8JJEKP520000001H1	520
14	8JJEKQ530000001H1	65	8JJEKR530000001H1	116	8JJEKP530000001H1	530
15	8JJEKQ540000001H1	66	8JJEKR540000001H1	117	8JJEKP540000001H1	540
16	8JJEKQ550000001H1	67	8JJEKR550000001H1	118	8JJEKP550000001H1	550
17	8JJEKQ560000001H1	68	8JJEKR560000001H1	119	8JJEKP560000001H1	560
18	8JJEKQ570000001H1	69	8JJEKR570000001H1	120	8JJEKP570000001H1	570
19	8JJEKQ580000001H1	70	8JJEKR580000001H1	121	8JJEKP580000001H1	580
20	8JJEKQ590000001H1	71	8JJEKR590000001H1	122	8JJEKP590000001H1	590
21	8JJEKQ600000001H1	72	8JJEKR600000001H1	123	8JJEKP600000001H1	600
22	8JJEKQ610000001H1	73	8JJEKR610000001H1	124	8JJEKP610000001H1	610
23	8JJEKQ620000001H1	74	8JJEKR620000001H1	125	8JJEKP620000001H1	620
24	8JJEKQ630000001H1	75	8JJEKR630000001H1	126	8JJEKP630000001H1	630
25	8JJEKQ640000001H1	76	8JJEKR640000001H1	127	8JJEKP640000001H1	640
26	8JJEKQ650000001H1	77	8JJEKR650000001H1	128	8JJEKP650000001H1	650
27	8JJEKQ660000001H1	78	8JJEKR660000001H1	129	8JJEKP660000001H1	660
28	8JJEKQ670000001H1	79	8JJEKR670000001H1	130	8JJEKP670000001H1	670
29	8JJEKQ680000001H1	80	8JJEKR680000001H1	131	8JJEKP680000001H1	680
30	8JJEKQ690000001H1	81	8JJEKR690000001H1	132	8JJEKP690000001H1	690
31	8JJEKQ700000001H1	82	8JJEKR700000001H1	133	8JJEKP700000001H1	700
32	8JJEKQ710000001H1	83	8JJEKR710000001H1	134	8JJEKP710000001H1	710
33	8JJEKQ720000001H1	84	8JJEKR720000001H1	135	8JJEKP720000001H1	720
34	8JJEKQ730000001H1	85	8JJEKR730000001H1	136	8JJEKP730000001H1	730
35	8JJEKQ740000001H1	86	8JJEKR740000001H1	137	8JJEKP740000001H1	740
36	8JJEKQ750000001H1	87	8JJEKR750000001H1	138	8JJEKP750000001H1	750
37	8JJEKQ760000001H1	88	8JJEKR760000001H1	139	8JJEKP760000001H1	760

38	8JJEKQ7700000001H1	89	8JJEKR7700000001H1	140	8JJEKP7700000001H1	770
39	8JJEKQ7800000001H1	90	8JJEKR7800000001H1	141	8JJEKP7800000001H1	780
40	8JJEKQ7900000001H1	91	8JJEKR7900000001H1	142	8JJEKP7900000001H1	790
41	8JJEKQ8000000001H1	92	8JJEKR8000000001H1	143	8JJEKP8000000001H1	800
42	8JJEKQ8100000001H1	93	8JJEKR8100000001H1	144	8JJEKP8100000001H1	810
43	8JJEKQ8200000001H1	94	8JJEKR8200000001H1	145	8JJEKP8200000001H1	820
44	8JJEKQ8300000001H1	95	8JJEKR8300000001H1	146	8JJEKP8300000001H1	830
45	8JJEKQ8400000001H1	96	8JJEKR8400000001H1	147	8JJEKP8400000001H1	840
46	8JJEKQ8500000001H1	97	8JJEKR8500000001H1	148	8JJEKP8500000001H1	850
47	8JJEKQ8600000001H1	98	8JJEKR8600000001H1	149	8JJEKP8600000001H1	860
48	8JJEKQ8700000001H1	99	8JJEKR8700000001H1	150	8JJEKP8700000001H1	870
49	8JJEKQ8800000001H1	100	8JJEKR8800000001H1	151	8JJEKP8800000001H1	880
50	8JJEKQ8900000001H1	101	8JJEKR8900000001H1	152	8JJEKP8900000001H1	890
51	8JJEKQ9000000001H1	102	8JJEKR9000000001H1	153	8JJEKP9000000001H1	900

For Antenna 1 (Green PCB, Cable 1) / Additional

Cable No.	Model (Cable Color: Black)	Cable No.	Model (Cable Color: Gray)	Cable No.	Model (Cable Color: White)	Cable Length (mm)
1	8JJEKQ050000001H1	37	8JJEKR050000001H1	73	8JJEKP050000001H1	50
2	8JJEKQ060000001H1	38	8JJEKR060000001H1	74	8JJEKP060000001H1	60
3	8JJEKQ070000001H1	39	8JJEKR070000001H1	75	8JJEKP070000001H1	70
4	8JJEKQ080000001H1	40	8JJEKR080000001H1	76	8JJEKP080000001H1	80
5	8JJEKQ090000001H1	41	8JJEKR090000001H1	77	8JJEKP090000001H1	90
6	8JJEKQ100000001H1	42	8JJEKR100000001H1	78	8JJEKP100000001H1	100
7	8JJEKQ110000001H1	43	8JJEKR110000001H1	79	8JJEKP110000001H1	110
8	8JJEKQ120000001H1	44	8JJEKR120000001H1	80	8JJEKP120000001H1	120
9	8JJEKQ130000001H1	45	8JJEKR130000001H1	81	8JJEKP130000001H1	130
10	8JJEKQ140000001H1	46	8JJEKR140000001H1	82	8JJEKP140000001H1	140
11	8JJEKQ150000001H1	47	8JJEKR150000001H1	83	8JJEKP150000001H1	150
12	8JJEKQ160000001H1	48	8JJEKR160000001H1	84	8JJEKP160000001H1	160
13	8JJEKQ170000001H1	49	8JJEKR170000001H1	85	8JJEKP170000001H1	170
14	8JJEKQ180000001H1	50	8JJEKR180000001H1	86	8JJEKP180000001H1	180
15	8JJEKQ190000001H1	51	8JJEKR190000001H1	87	8JJEKP190000001H1	190
16	8JJEKQ199000001H1	52	8JJEKR199000001H1	88	8JJEKP199000001H1	199
17	8JJEKQ210000001H1	53	8JJEKR210000001H1	89	8JJEKP210000001H1	210
18	8JJEKQ220000001H1	54	8JJEKR220000001H1	90	8JJEKP220000001H1	220
19	8JJEKQ230000001H1	55	8JJEKR230000001H1	91	8JJEKP230000001H1	230
20	8JJEKQ240000001H1	56	8JJEKR240000001H1	92	8JJEKP240000001H1	240
21	8JJEKQ250000001H1	57	8JJEKR250000001H1	93	8JJEKP250000001H1	250
22	8JJEKQ260000001H1	58	8JJEKR260000001H1	94	8JJEKP260000001H1	260
23	8JJEKQ270000001H1	59	8JJEKR270000001H1	95	8JJEKP270000001H1	270
24	8JJEKQ280000001H1	60	8JJEKR280000001H1	96	8JJEKP280000001H1	280
25	8JJEKQ290000001H1	61	8JJEKR290000001H1	97	8JJEKP290000001H1	290
26	8JJEKQ300000001H1	62	8JJEKR300000001H1	98	8JJEKP300000001H1	300
27	8JJEKQ310000001H1	63	8JJEKR310000001H1	99	8JJEKP310000001H1	310
28	8JJEKQ320000001H1	64	8JJEKR320000001H1	100	8JJEKP320000001H1	320
29	8JJEKQ330000001H1	65	8JJEKR330000001H1	101	8JJEKP330000001H1	330
30	8JJEKQ340000001H1	66	8JJEKR340000001H1	102	8JJEKP340000001H1	340
31	8JJEKQ350000001H1	67	8JJEKR350000001H1	103	8JJEKP350000001H1	350
32	8JJEKQ360000001H1	68	8JJEKR360000001H1	104	8JJEKP360000001H1	360
33	8JJEKQ370000001H1	69	8JJEKR370000001H1	105	8JJEKP370000001H1	370
34	8JJEKQ380000001H1	70	8JJEKR380000001H1	106	8JJEKP380000001H1	380
35	8JJEKQ390000001H1	71	8JJEKR390000001H1	107	8JJEKP390000001H1	390
36	8JJEKQ400000001H1	72	8JJEKR400000001H1	108	8JJEKP400000001H1	400

For Antenna 2 (Blue PCB, Cable 2) / Additional

Cable No.	Model (Cable Color: Black)	Cable No.	Model (Cable Color: Gray)	Cable No.	Model (Cable Color: White)	Cable Length (mm)
1	8JJEKQ050000001H1	87	8JJEKR050000001H1	173	8JJEKP050000001H1	50
2	8JJEKQ060000001H1	88	8JJEKR060000001H1	174	8JJEKP060000001H1	60
3	8JJEKQ070000001H1	89	8JJEKR070000001H1	175	8JJEKP070000001H1	70
4	8JJEKQ080000001H1	90	8JJEKR080000001H1	176	8JJEKP080000001H1	80
5	8JJEKQ090000001H1	91	8JJEKR090000001H1	177	8JJEKP090000001H1	90
6	8JJEKQ100000001H1	92	8JJEKR100000001H1	178	8JJEKP100000001H1	100
7	8JJEKQ110000001H1	93	8JJEKR110000001H1	179	8JJEKP110000001H1	110
8	8JJEKQ120000001H1	94	8JJEKR120000001H1	180	8JJEKP120000001H1	120
9	8JJEKQ130000001H1	95	8JJEKR130000001H1	181	8JJEKP130000001H1	130
10	8JJEKQ140000001H1	96	8JJEKR140000001H1	182	8JJEKP140000001H1	140
11	8JJEKQ150000001H1	97	8JJEKR150000001H1	183	8JJEKP150000001H1	150
12	8JJEKQ160000001H1	98	8JJEKR160000001H1	184	8JJEKP160000001H1	160
13	8JJEKQ170000001H1	99	8JJEKR170000001H1	185	8JJEKP170000001H1	170
14	8JJEKQ180000001H1	100	8JJEKR180000001H1	186	8JJEKP180000001H1	180
15	8JJEKQ190000001H1	101	8JJEKR190000001H1	187	8JJEKP190000001H1	190
16	8JJEKQ199000001H1	102	8JJEKR199000001H1	188	8JJEKP199000001H1	199
17	8JJEKQ210000001H1	103	8JJEKR210000001H1	189	8JJEKP210000001H1	210
18	8JJEKQ220000001H1	104	8JJEKR220000001H1	190	8JJEKP220000001H1	220
19	8JJEKQ230000001H1	105	8JJEKR230000001H1	191	8JJEKP230000001H1	230
20	8JJEKQ240000001H1	106	8JJEKR240000001H1	192	8JJEKP240000001H1	240
21	8JJEKQ250000001H1	107	8JJEKR250000001H1	193	8JJEKP250000001H1	250
22	8JJEKQ260000001H1	108	8JJEKR260000001H1	194	8JJEKP260000001H1	260
23	8JJEKQ270000001H1	109	8JJEKR270000001H1	195	8JJEKP270000001H1	270
24	8JJEKQ280000001H1	110	8JJEKR280000001H1	196	8JJEKP280000001H1	280
25	8JJEKQ290000001H1	111	8JJEKR290000001H1	197	8JJEKP290000001H1	290
26	8JJEKQ300000001H1	112	8JJEKR300000001H1	198	8JJEKP300000001H1	300
27	8JJEKQ310000001H1	113	8JJEKR310000001H1	199	8JJEKP310000001H1	310
28	8JJEKQ320000001H1	114	8JJEKR320000001H1	200	8JJEKP320000001H1	320
29	8JJEKQ330000001H1	115	8JJEKR330000001H1	201	8JJEKP330000001H1	330
30	8JJEKQ340000001H1	116	8JJEKR340000001H1	202	8JJEKP340000001H1	340
31	8JJEKQ350000001H1	117	8JJEKR350000001H1	203	8JJEKP350000001H1	350
32	8JJEKQ360000001H1	118	8JJEKR360000001H1	204	8JJEKP360000001H1	360
33	8JJEKQ370000001H1	119	8JJEKR370000001H1	205	8JJEKP370000001H1	370
34	8JJEKQ380000001H1	120	8JJEKR380000001H1	206	8JJEKP380000001H1	380
35	8JJEKQ390000001H1	121	8JJEKR390000001H1	207	8JJEKP390000001H1	390
36	8JJEKQ400000001H1	122	8JJEKR400000001H1	208	8JJEKP400000001H1	400
37	8JJEKQ410000001H1	123	8JJEKR410000001H1	209	8JJEKP410000001H1	410

38	8JJEKQ4200000001H1	124	8JJEKR4200000001H1	210	8JJEKP4200000001H1	420
39	8JJEKQ4300000001H1	125	8JJEKR4300000001H1	211	8JJEKP4300000001H1	430
40	8JJEKQ4400000001H1	126	8JJEKR4400000001H1	212	8JJEKP4400000001H1	440
41	8JJEKQ4500000001H1	127	8JJEKR4500000001H1	213	8JJEKP4500000001H1	450
42	8JJEKQ4600000001H1	128	8JJEKR4600000001H1	214	8JJEKP4600000001H1	460
43	8JJEKQ4700000001H1	129	8JJEKR4700000001H1	215	8JJEKP4700000001H1	470
44	8JJEKQ4800000001H1	130	8JJEKR4800000001H1	216	8JJEKP4800000001H1	480
45	8JJEKQ4900000001H1	131	8JJEKR4900000001H1	217	8JJEKP4900000001H1	490
46	8JJEKQ5000000001H1	132	8JJEKR5000000001H1	218	8JJEKP5000000001H1	500
47	8JJEKQ5100000001H1	133	8JJEKR5100000001H1	219	8JJEKP5100000001H1	510
48	8JJEKQ5200000001H1	134	8JJEKR5200000001H1	220	8JJEKP5200000001H1	520
49	8JJEKQ5300000001H1	135	8JJEKR5300000001H1	221	8JJEKP5300000001H1	530
50	8JJEKQ5400000001H1	136	8JJEKR5400000001H1	222	8JJEKP5400000001H1	540
51	8JJEKQ5500000001H1	137	8JJEKR5500000001H1	223	8JJEKP5500000001H1	550
52	8JJEKQ5600000001H1	138	8JJEKR5600000001H1	224	8JJEKP5600000001H1	560
53	8JJEKQ5700000001H1	139	8JJEKR5700000001H1	225	8JJEKP5700000001H1	570
54	8JJEKQ5800000001H1	140	8JJEKR5800000001H1	226	8JJEKP5800000001H1	580
55	8JJEKQ5900000001H1	141	8JJEKR5900000001H1	227	8JJEKP5900000001H1	590
56	8JJEKQ6000000001H1	142	8JJEKR6000000001H1	228	8JJEKP6000000001H1	600
57	8JJEKQ6100000001H1	143	8JJEKR6100000001H1	229	8JJEKP6100000001H1	610
58	8JJEKQ6200000001H1	144	8JJEKR6200000001H1	230	8JJEKP6200000001H1	620
59	8JJEKQ6300000001H1	145	8JJEKR6300000001H1	231	8JJEKP6300000001H1	630
60	8JJEKQ6400000001H1	146	8JJEKR6400000001H1	232	8JJEKP6400000001H1	640
61	8JJEKQ6500000001H1	147	8JJEKR6500000001H1	233	8JJEKP6500000001H1	650
62	8JJEKQ6600000001H1	148	8JJEKR6600000001H1	234	8JJEKP6600000001H1	660
63	8JJEKQ6700000001H1	149	8JJEKR6700000001H1	235	8JJEKP6700000001H1	670
64	8JJEKQ6800000001H1	150	8JJEKR6800000001H1	236	8JJEKP6800000001H1	680
65	8JJEKQ6900000001H1	151	8JJEKR6900000001H1	237	8JJEKP6900000001H1	690
66	8JJEKQ7000000001H1	152	8JJEKR7000000001H1	238	8JJEKP7000000001H1	700
67	8JJEKQ7100000001H1	153	8JJEKR7100000001H1	239	8JJEKP7100000001H1	710
68	8JJEKQ7200000001H1	154	8JJEKR7200000001H1	240	8JJEKP7200000001H1	720
69	8JJEKQ7300000001H1	155	8JJEKR7300000001H1	241	8JJEKP7300000001H1	730
70	8JJEKQ7400000001H1	156	8JJEKR7400000001H1	242	8JJEKP7400000001H1	740
71	8JJEKQ7500000001H1	157	8JJEKR7500000001H1	243	8JJEKP7500000001H1	750
72	8JJEKQ7600000001H1	158	8JJEKR7600000001H1	244	8JJEKP7600000001H1	760
73	8JJEKQ7700000001H1	159	8JJEKR7700000001H1	245	8JJEKP7700000001H1	770
74	8JJEKQ7800000001H1	160	8JJEKR7800000001H1	246	8JJEKP7800000001H1	780
75	8JJEKQ7900000001H1	161	8JJEKR7900000001H1	247	8JJEKP7900000001H1	790
76	8JJEKQ8000000001H1	162	8JJEKR8000000001H1	248	8JJEKP8000000001H1	800
77	8JJEKQ8100000001H1	163	8JJEKR8100000001H1	249	8JJEKP8100000001H1	810

78	8JJEKQ8200000001H1	164	8JJEKR8200000001H1	250	8JJEKP8200000001H1	820
79	8JJEKQ8300000001H1	165	8JJEKR8300000001H1	251	8JJEKP8300000001H1	830
80	8JJEKQ8400000001H1	166	8JJEKR8400000001H1	252	8JJEKP8400000001H1	840
81	8JJEKQ8500000001H1	167	8JJEKR8500000001H1	253	8JJEKP8500000001H1	850
82	8JJEKQ8600000001H1	168	8JJEKR8600000001H1	254	8JJEKP8600000001H1	860
83	8JJEKQ8700000001H1	169	8JJEKR8700000001H1	255	8JJEKP8700000001H1	870
84	8JJEKQ8800000001H1	170	8JJEKR8800000001H1	256	8JJEKP8800000001H1	880
85	8JJEKQ8900000001H1	171	8JJEKR8900000001H1	257	8JJEKP8900000001H1	890
86	8JJEKQ9000000001H1	172	8JJEKR9000000001H1	258	8JJEKP9000000001H1	900

1.1.3 Power Supply Type of Equipment under Test (EUT)

Power Supply Type	DC 4V/1A
--------------------------	----------

1.1.4 Accessories

N/A

1.1.5 Channel List

Frequency band (MHz)				2400~2483.5			
Channel	Frequency (MHz)	Channel	Frequency (MHz)	Channel	Frequency (MHz)	Channel	Frequency (MHz)
37	2402	9	2422	18	2442	28	2462
0	2404	10	2424	19	2444	29	2464
1	2406	38	2426	20	2446	30	2466
2	2408	11	2428	21	2448	31	2468
3	2410	12	2430	22	2450	32	2470
4	2412	13	2432	23	2452	33	2472
5	2414	14	2434	24	2454	34	2474
6	2416	15	2436	25	2456	35	2476
7	2418	16	2438	26	2458	36	2478
8	2420	17	2440	27	2460	39	2480

1.2 Local Support Equipment List

Support Equipment List						
No.	Equipment	Brand	Model	S/N	FCC ID	Signal cable / Length (m)
1	Notebook	DELL	Latitude E6440	2ZC4Z52	DoC	---
2	DC Power Supply	GW INSTEK	GPC-3060D	EM884797	---	---
3	Fixture	---	---	---	---	---

Note: Fixture was supplied by applicant.

1.3 Test Setup Chart

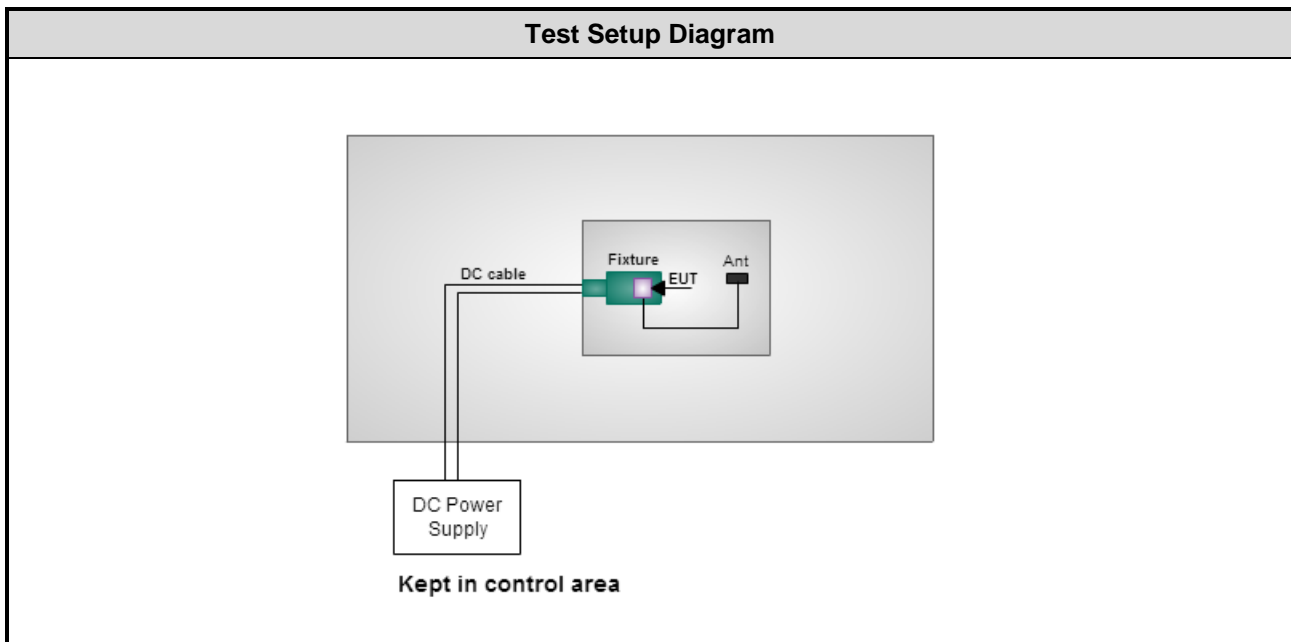

Note: The support notebook was disconnected from EUT and removed from test table when EUT is set to transmit continuously.

1.4 Test Equipment List and Calibration Data

Test Item	Conducted Emission				
Test Site	Conduction room 1 / (CO01-WS)				
Instrument	Manufacturer	Model No.	Serial No.	Calibration Date	Calibration Until
Receiver	R&S	ESR3	101657	Dec. 21, 2016	Dec. 20, 2017
LISN	SCHWARZBECK	Schwarzbeck 8127	8127-667	Nov. 08, 2016	Nov. 07, 2017
RF Cable-CON	EMC	EMCCFD300-BM-BM-6000	50821	Dec. 20, 2016	Dec. 19, 2017
Measurement Software	AUDIX	e3	6.120210k	NA	NA

Note: Calibration Interval of instruments listed above is one year.

Test Item	Radiated Emission				
Test Site	966 chamber1 / (03CH01-WS)				
Instrument	Manufacturer	Model No.	Serial No.	Calibration Date	Calibration Until
Spectrum Analyzer	R&S	FSV40	101498	Nov. 25, 2016	Nov. 24, 2017
Receiver	R&S	ESR3	101658	Nov. 24, 2016	Nov. 23, 2017
Bilog Antenna	SCHWARZBECK	VULB9168	VULB9168-522	Aug. 04, 2016	Aug. 03, 2017
Horn Antenna 1G-18G	SCHWARZBECK	BBHA 9120 D	BBHA 9120 D 1096	Dec. 21, 2016	Dec. 20, 2017
Horn Antenna 18G-40G	SCHWARZBECK	BBHA 9170	BBHA 9170517	Oct. 25, 2016	Oct. 24, 2017
Loop Antenna	R&S	HFH2-Z2	100330	Nov. 10, 2016	Nov. 09, 2017
Loop Antenna Cable	KOAX KABEL	101354-BW	101354-BW	Dec. 09, 2016	Dec. 08, 2017
Preamplifier	EMC	EMC02325	980225	Aug. 05, 2016	Aug. 04, 2017
Preamplifier	Agilent	83017A	MY39501308	Oct. 06, 2016	Oct. 05, 2017
Preamplifier	EMC	EMC184045B	980192	Aug. 24, 2016	Aug. 23, 2017
RF Cable	HUBER+SUHNER	SUCOFLEX104	MY16014/4	Dec. 09, 2016	Dec. 08, 2017
RF Cable	HUBER+SUHNER	SUCOFLEX104	MY16019/4	Dec. 09, 2016	Dec. 08, 2017
RF Cable	HUBER+SUHNER	SUCOFLEX104	MY16139/4	Dec. 09, 2016	Dec. 08, 2017
LF cable 1M	EMC	EMCCFD400-NM-N M-1000	16052	Dec. 09, 2016	Dec. 08, 2017
LF cable 3M	Woken	CFD400NL-LW	CFD400NL-001	Dec. 09, 2016	Dec. 08, 2017
LF cable 10M	Woken	CFD400NL-LW	CFD400NL-002	Dec. 09, 2016	Dec. 08, 2017
Measurement Software	AUDIX	e3	6.120210g	NA	NA

Note: Calibration Interval of instruments listed above is one year.

1.5 Test Standards

According to the specification of EUT, the EUT must comply with following standards and KDB documents.

47 CFR FCC Part 15.247

ANSI C63.10-2013

FCC KDB 558074 D01 DTS Meas Guidance v04

1.6 Measurement Uncertainty

ISO/IEC 17025 requires that an estimate of the measurement uncertainties associated with the emissions test results be included in the report. The measurement uncertainties given below are based on a 95% confidence level (based on a coverage factor ($k=2$))

Measurement Uncertainty	
Parameters	Uncertainty
AC conducted emission	± 2.90 dB
Radiated emission ≤ 1 GHz	± 3.66 dB
Radiated emission > 1 GHz	± 5.63 dB

2 Test Configuration

2.1 Testing Condition

Test Item	Test Site	Ambient Condition	Tested By
AC Conduction	CO01-WS	25°C / 57%	Alex Tsai
Radiated Emissions	03CH01-WS	22-24°C / 62-64%	Vincent Yeh

- FCC Designation No.: TW2732
- FCC site registration No.: 181692
- IC site registration No.: 10807A-1

2.2 The Worst Test Modes and Channel Details

Test item	Mode	Test Frequency (MHz)	Data Rate
AC Power Line Conducted Emissions	BT LE	2402	1Mbps
Radiated Emissions ≤ 1GHz	BT LE	2402	1Mbps
Radiated Emissions > 1GHz	BT LE	2402, 2440, 2480	1Mbps
NOTE: The EUT was pretested with 3 orientations placed on the table for the radiated emission measurement – X, Y, and Z-plane. The Y-plane result was found as the worst case and was shown in this report.			

3 Transmitter Test Results

3.1 Conducted Emissions

3.1.1 Limit of Conducted Emissions

Conducted Emissions Limit		
Frequency Emission (MHz)	Quasi-Peak	Average
0.15-0.5	66 - 56 *	56 - 46 *
0.5-5	56	46
5-30	60	50

Note 1: * Decreases with the logarithm of the frequency.

3.1.2 Test Procedures

1. The device is placed on a test table, raised 80 cm above the reference ground plane. The vertical conducting plane is located 40 cm to the rear of the device.
2. The device is connected to line impedance stabilization network (LISN) and other accessories are connected to other LISN. Measured levels of AC power line conducted emission are across the 50 Ω LISN port.
3. AC conducted emission measurements is made over frequency range from 150 kHz to 30 MHz.
4. This measurement was performed with AC 120V/60Hz

3.1.3 Test Setup

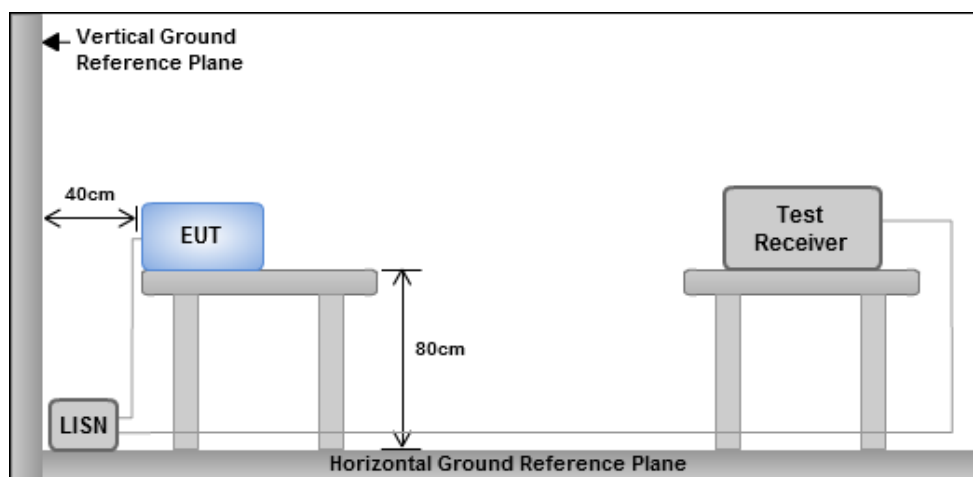

Note: 1. Support units were connected to second LISN.

2. Both of LISNs (AMN) are 80 cm from EUT and at least 80 cm from other units and other metal planes

3.1.4 Test Result of Conducted Emissions

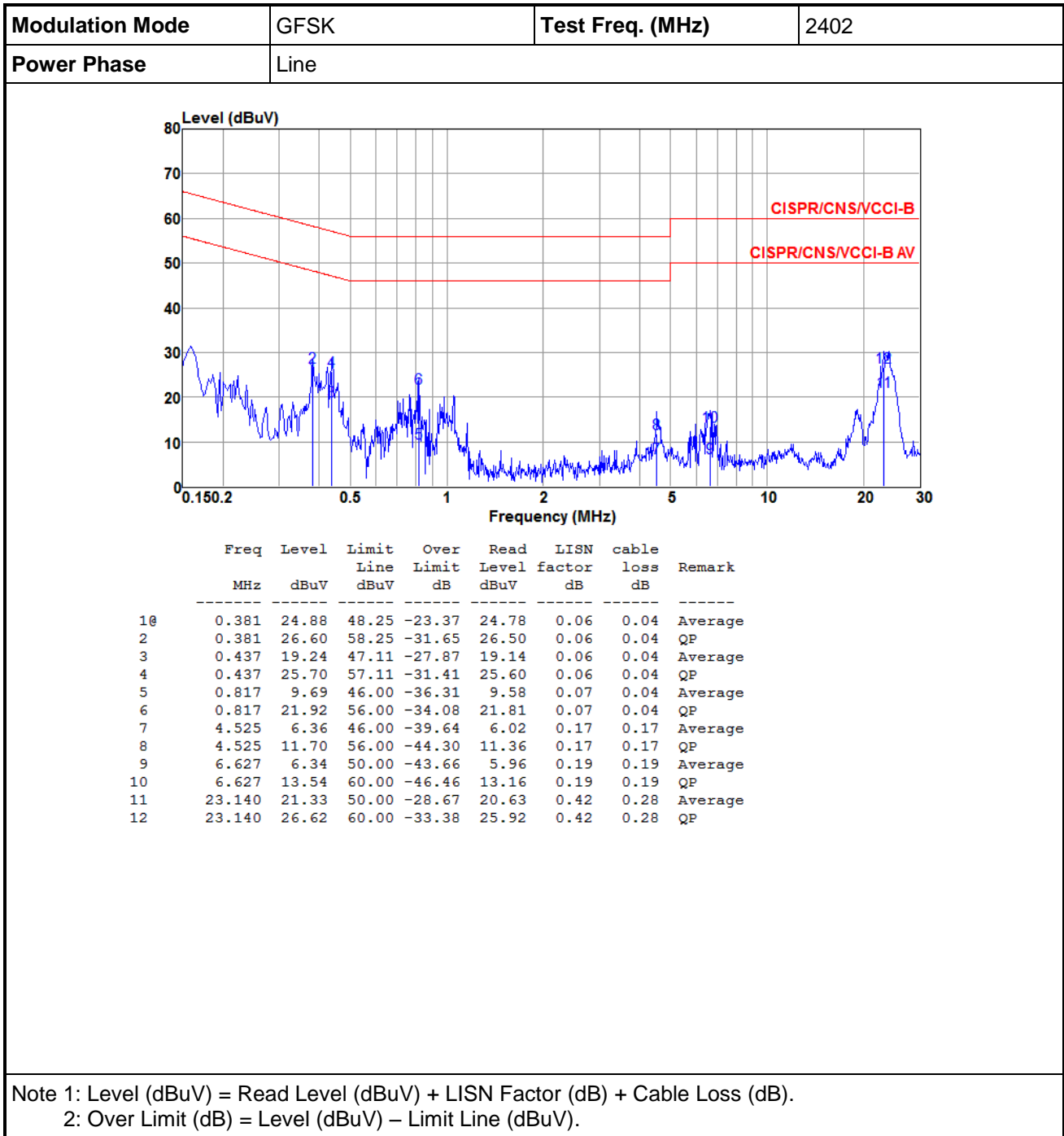

Modulation Mode	GFSK	Test Freq. (MHz)	2402
Power Phase	Neutral		

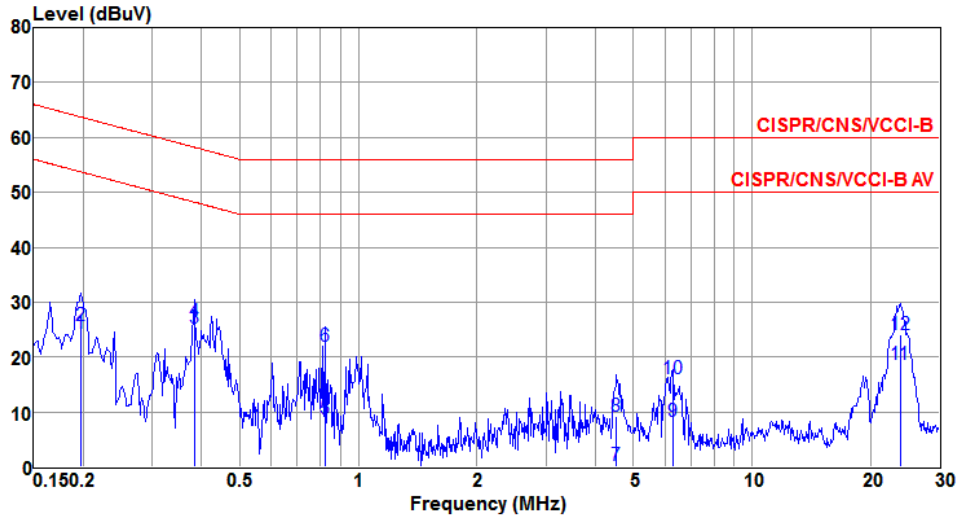

	Freq MHz	Level dBuV	Limit Line dBuV	Over Limit dB	Read Level dBuV	LISN factor dB	cable loss dB	Remark
1	0.198	24.28	53.71	-29.43	24.15	0.09	0.04	Average
2	0.198	25.74	63.71	-37.97	25.61	0.09	0.04	QP
3	0.383	25.37	48.21	-22.84	25.20	0.13	0.04	Average
4	0.383	26.50	58.21	-31.71	26.33	0.13	0.04	QP
5	0.822	8.63	46.00	-37.37	8.49	0.10	0.04	Average
6	0.822	21.90	56.00	-34.10	21.76	0.10	0.04	QP
7	4.525	0.17	46.00	-45.83	-0.16	0.16	0.17	Average
8	4.525	9.13	56.00	-46.87	8.80	0.16	0.17	QP
9	6.319	8.36	50.00	-41.64	7.95	0.22	0.19	Average
10	6.319	16.09	60.00	-43.91	15.68	0.22	0.19	QP
11	23.762	18.60	50.00	-31.40	17.88	0.44	0.28	Average
12	23.762	24.11	60.00	-35.89	23.39	0.44	0.28	QP

Note 1: Level (dBuV) = Read Level (dBuV) + LISN Factor (dB) + Cable Loss (dB).
 2: Over Limit (dB) = Level (dBuV) – Limit Line (dBuV).

3.2 Emissions in Restricted Frequency Bands

3.2.1 Limit of Emissions in Restricted Frequency Bands

Restricted Band Emissions Limit			
Frequency Range (MHz)	Field Strength (uV/m)	Field Strength (dBuV/m)	Measure Distance (m)
0.009~0.490	2400/F(kHz)	48.5 - 13.8	300
0.490~1.705	24000/F(kHz)	33.8 - 23	30
1.705~30.0	30	29	30
30~88	100	40	3
88~216	150	43.5	3
216~960	200	46	3
Above 960	500	54	3

Note 1:
Quasi-Peak value is measured for frequency below 1GHz except for 9–90 kHz, 110–490 kHz frequency band. Peak and average value are measured for frequency above 1GHz. The limit on average radio frequency emission is as above table. The limit on peak radio frequency emissions is 20 dB above the maximum permitted average emission limit

Note 2:
Measurements may be performed at a distance other than what is specified provided. When performing measurements at a distance other than that specified, the results shall be extrapolated to the specified distance using an extrapolation factor as below, Frequency at or above 30 MHz: 20 dB/decade Frequency below 30 MHz: 40 dB/decade.

3.2.2 Test Procedures

1. Measurement is made at a semi-anechoic chamber that incorporates a turntable allowing a EUT rotation of 360°. A continuously-rotating, remotely-controlled turntable is installed at the test site to support the EUT and facilitate determination of the direction of maximum radiation for each EUT emission frequency. The EUT is placed at test table. For emissions testing at or below 1 GHz, the table height is 80 cm above the reference ground plane. For emission measurements above 1 GHz, the table height is 1.5 m
2. Measurement is made with the antenna positioned in both the horizontal and vertical planes of polarization. The measurement antenna is varied in height (1m ~ 4m) above the reference ground plane to obtain the maximum signal strength. Distance between EUT and antenna is 3 m.
3. This investigation is performed with the EUT rotated 360°, the antenna height scanned between 1 m and 4 m, and the antenna rotated to repeat the measurements for both the horizontal and vertical antenna polarizations.

Note:

1. 120kHz measurement bandwidth of test receiver and Quasi-peak detector is for radiated emission below 1GHz.
2. RBW=1MHz, VBW=3MHz and Peak detector is for peak measured value of radiated emission above 1GHz.
3. RBW=1MHz, VBW=1/T and Peak detector is for average measured value of radiated emission above 1GHz.

3.2.3 Test Setup

Radiated Emissions below 1 GHz

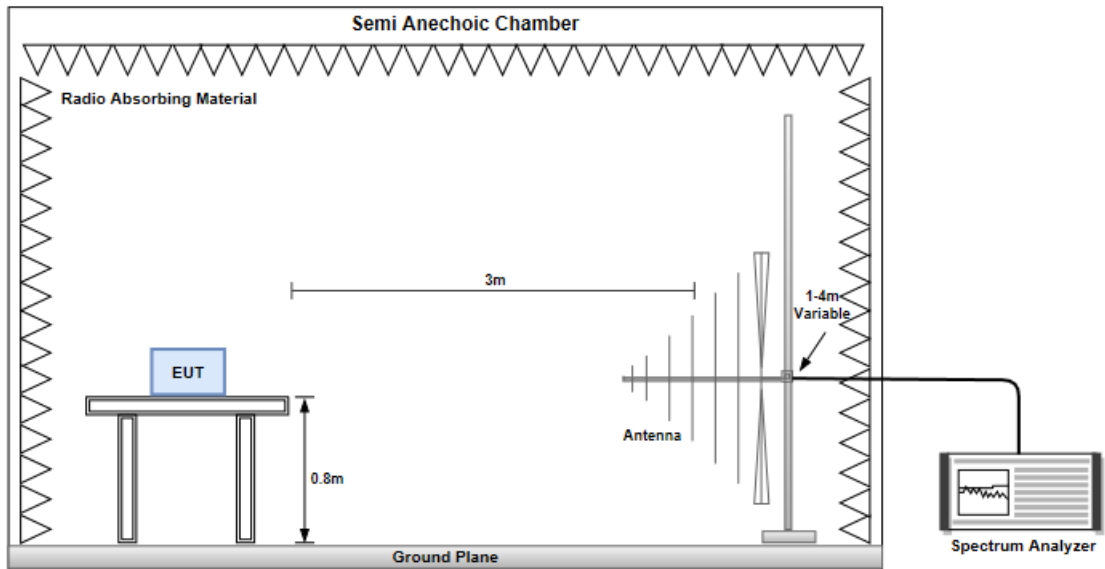

Radiated Emissions above 1 GHz

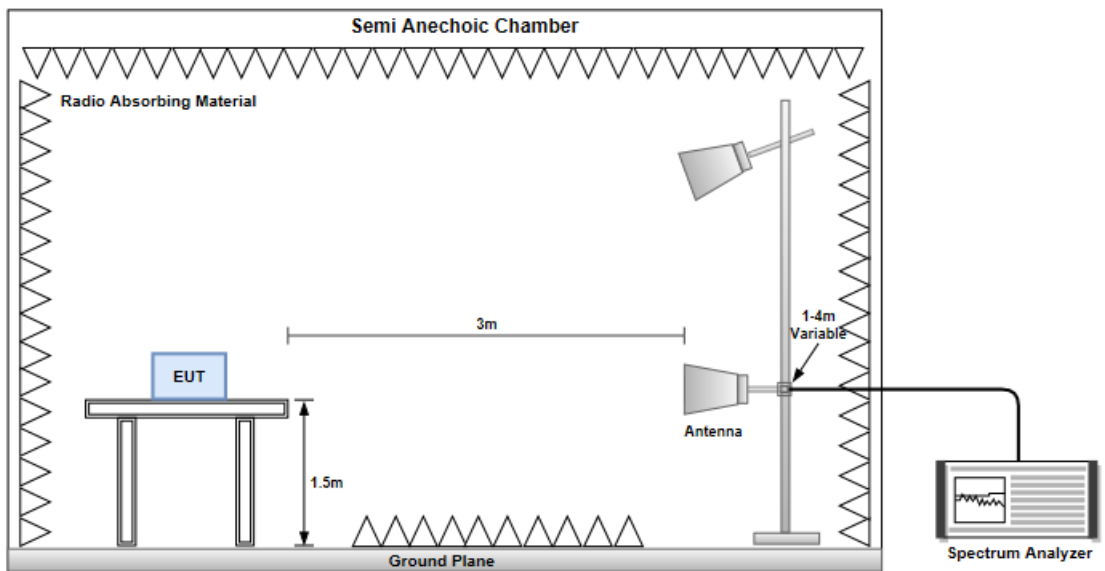

3.2.4 Transmitter Radiated Unwanted Emissions (Below 1GHz)

Modulation	GFSK	Test Freq. (MHz)	2402
Polarization	Horizontal		

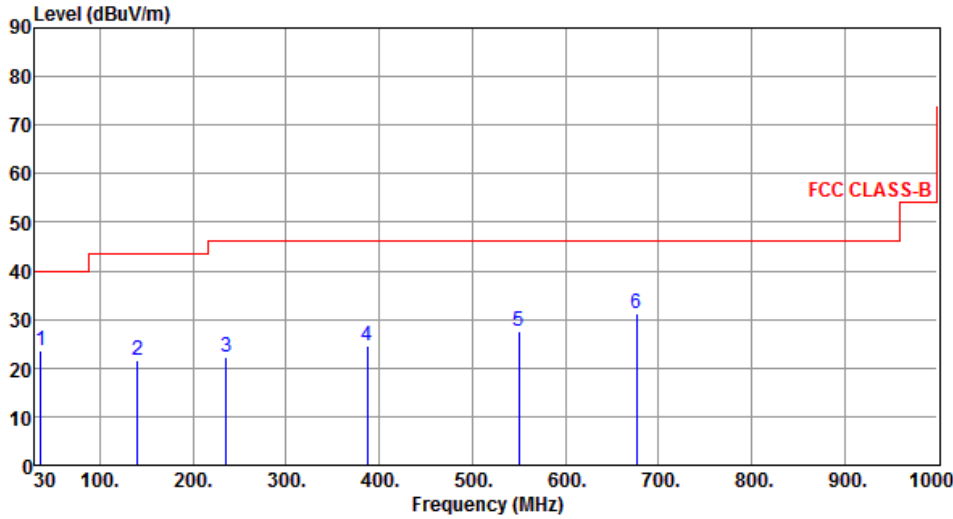

	Freq. MHz	Emission level dBuV/m	Limit dBuV/m	Margin dB	SA reading dBuV	Factor dB	Remark	ANT High cm	Turn Table deg
1	36.34	23.51	40.00	-16.49	31.87	-8.36	Peak	---	---
2	140.38	21.48	43.50	-22.02	29.79	-8.31	Peak	---	---
3	235.64	22.14	46.00	-23.86	31.55	-9.41	Peak	---	---
4	386.96	24.66	46.00	-21.34	29.98	-5.32	Peak	---	---
5	549.92	27.65	46.00	-18.35	29.51	-1.86	Peak	---	---
6	676.75	31.36	46.00	-14.64	30.96	0.40	Peak	---	---

Note 1: Emission Level (dBuV/m) = SA Reading (dBuV/m) + Factor* (dB)
 *Factor includes antenna factor , cable loss and amplifier gain
 Note 2: Margin (dB) = Emission level (dBuV/m) – Limit (dBuV/m).
 Note 3: All spurious emissions below 30MHz are more than 20 dB below the limit.

Modulation	GFSK	Test Freq. (MHz)	2402
Polarization	Vertical		

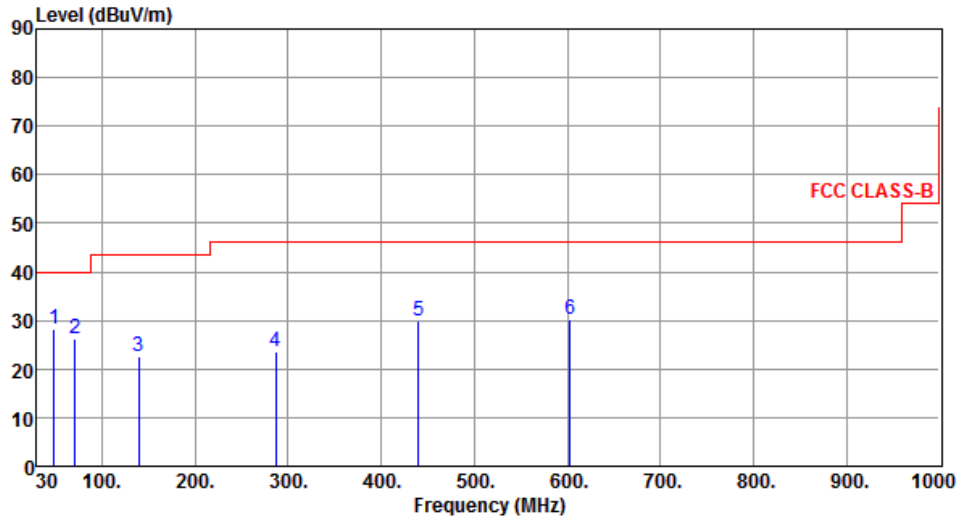

	Freq. MHz	Emission level dBuV/m	Limit dBuV/m	Margin dB	SA reading dBuV	Factor dB	Remark	ANT High cm	Turn Table deg
1	48.66	28.26	40.00	-11.74	35.88	-7.62	QP	105	25
2	70.62	26.24	40.00	-13.76	37.05	-10.81	Peak	---	---
3	139.58	22.63	43.50	-20.87	30.97	-8.34	Peak	---	---
4	286.48	23.63	46.00	-22.37	31.44	-7.81	Peak	---	---
5	439.74	29.76	46.00	-16.24	33.76	-4.00	Peak	---	---
6	602.82	30.26	46.00	-15.74	30.88	-0.62	Peak	---	---

Note 1: Emission Level (dBuV/m) = SA Reading (dBuV/m) + Factor* (dB)

*Factor includes antenna factor , cable loss and amplifier gain

Note 2: Margin (dB) = Emission level (dBuV/m) – Limit (dBuV/m).

Note 3: All spurious emissions below 30MHz are more than 20 dB below the limit.

3.2.5 Transmitter Radiated Unwanted Emissions (Above 1GHz) for GFSK

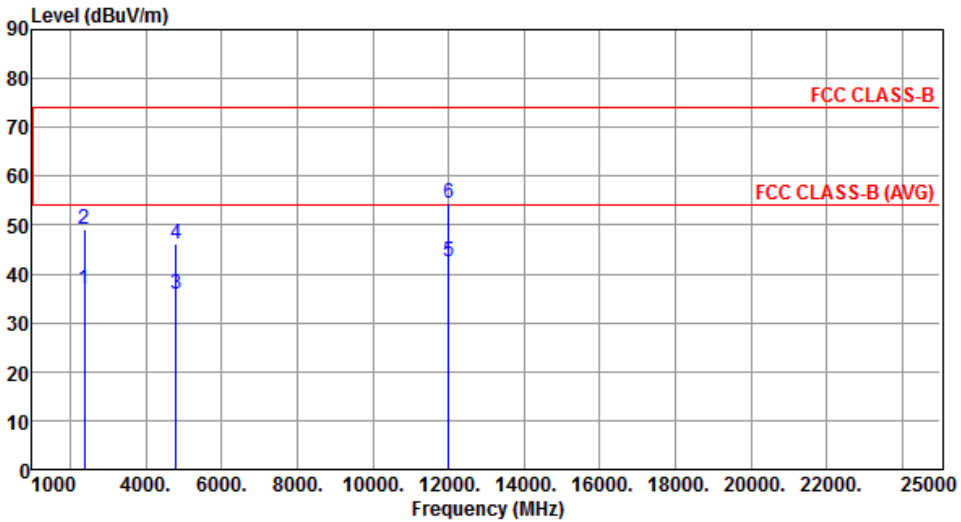
Modulation	GFSK	Test Freq. (MHz)	2402						
Polarization	Horizontal								
									
	Freq.	Emission level	Limit	Margin	SA reading	Factor	Remark	ANT High	Turn Table
	MHz	dBuV/m	dBuV/m	dB	dBuV	dB		cm	deg
1	2390.00	36.97	54.00	-17.03	40.15	-3.18	Average	253	156
2	2390.00	49.31	74.00	-24.69	52.49	-3.18	Peak	253	156
3	4804.00	35.82	54.00	-18.18	32.08	3.74	Average	166	1
4	4804.00	46.22	74.00	-27.78	42.48	3.74	Peak	166	1
5	12010.00	42.47	54.00	-11.53	28.92	13.55	Average	100	178
6	12010.00	54.36	74.00	-19.64	40.81	13.55	Peak	100	178
<p>Note 1: Emission Level (dBuV/m) = SA Reading (dBuV/m) + Factor* (dB) *Factor includes antenna factor , cable loss and amplifier gain Note 2: Margin (dB) = Emission level (dBuV/m) – Limit (dBuV/m).</p>									

Modulation	GFSK	Test Freq. (MHz)	2402
Polarization	Vertical		

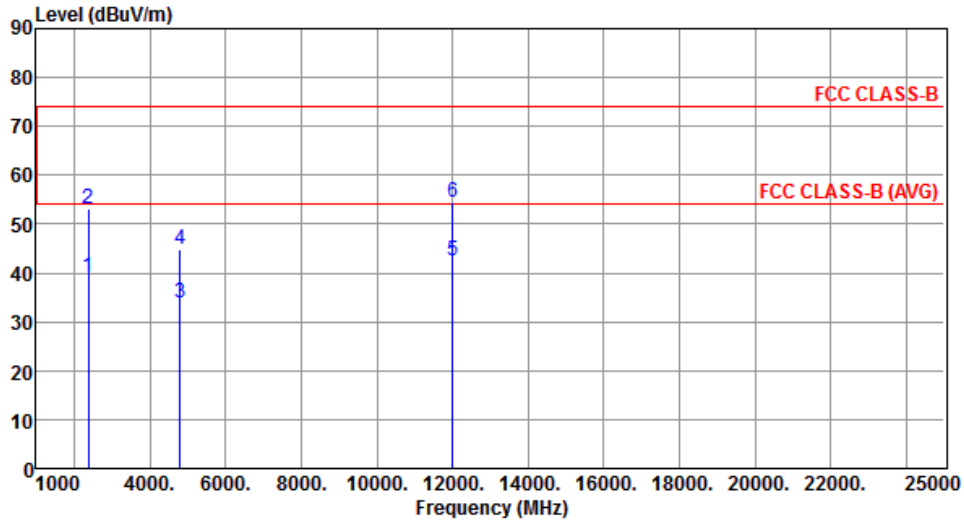

	Freq. MHz	Emission level dBuV/m	Limit dBuV/m	Margin dB	SA reading dBuV	Factor dB	Remark	ANT High cm	Turn Table deg
1	2390.00	39.08	54.00	-14.92	42.26	-3.18	Average	308	94
2	2390.00	53.21	74.00	-20.79	56.39	-3.18	Peak	308	94
3	4804.00	33.76	54.00	-20.24	30.02	3.74	Average	100	45
4	4804.00	44.83	74.00	-29.17	41.09	3.74	Peak	100	45
5	12010.00	42.42	54.00	-11.58	28.87	13.55	Average	100	261
6	12010.00	54.39	74.00	-19.61	40.84	13.55	Peak	100	261

Note 1: Emission Level (dBuV/m) = SA Reading (dBuV/m) + Factor* (dB)

*Factor includes antenna factor , cable loss and amplifier gain

Note 2: Margin (dB) = Emission level (dBuV/m) – Limit (dBuV/m).

Modulation	GFSK	Test Freq. (MHz)	2440
Polarization	Horizontal		

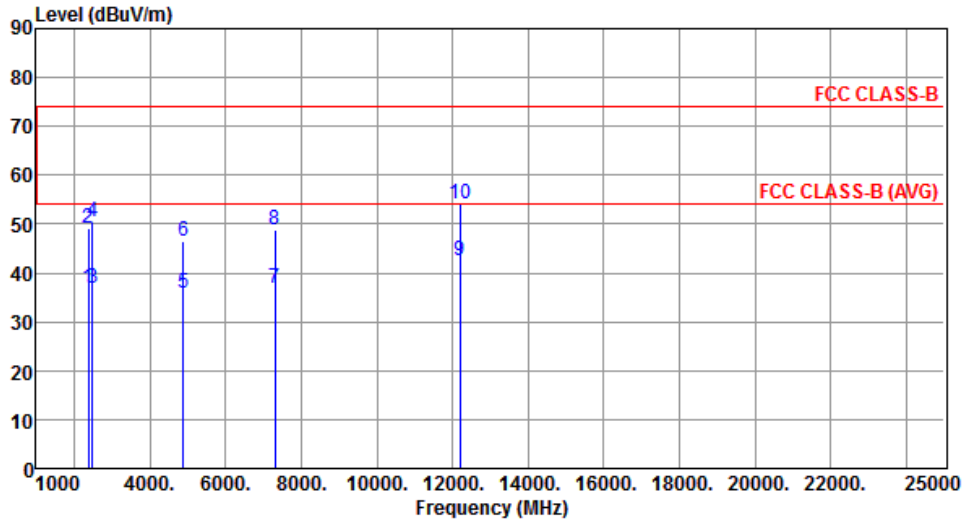

	Freq. MHz	Emission level dBuV/m	Limit dBuV/m	Margin dB	SA reading dBuV	Factor dB	Remark	ANT High cm	Turn Table deg
1	2390.00	36.80	54.00	-17.20	39.98	-3.18	Average	260	158
2	2390.00	49.14	74.00	-24.86	52.32	-3.18	Peak	260	158
3	2483.50	37.02	54.00	-16.98	39.82	-2.80	Average	260	158
4	2483.50	50.34	74.00	-23.66	53.14	-2.80	Peak	260	158
5	4880.00	35.99	54.00	-18.01	32.03	3.96	Average	170	3
6	4880.00	46.37	74.00	-27.63	42.41	3.96	Peak	170	3
7	7320.00	37.01	54.00	-16.99	28.60	8.41	Average	100	140
8	7320.00	48.76	74.00	-25.24	40.35	8.41	Peak	100	140
9	12200.00	42.53	54.00	-11.47	28.85	13.68	Average	100	185
10	12200.00	54.21	74.00	-19.79	40.53	13.68	Peak	100	185

Note 1: Emission Level (dBuV/m) = SA Reading (dBuV/m) + Factor* (dB)

*Factor includes antenna factor , cable loss and amplifier gain

Note 2: Margin (dB) = Emission level (dBuV/m) – Limit (dBuV/m).

Modulation	GFSK	Test Freq. (MHz)	2440
Polarization	Vertical		

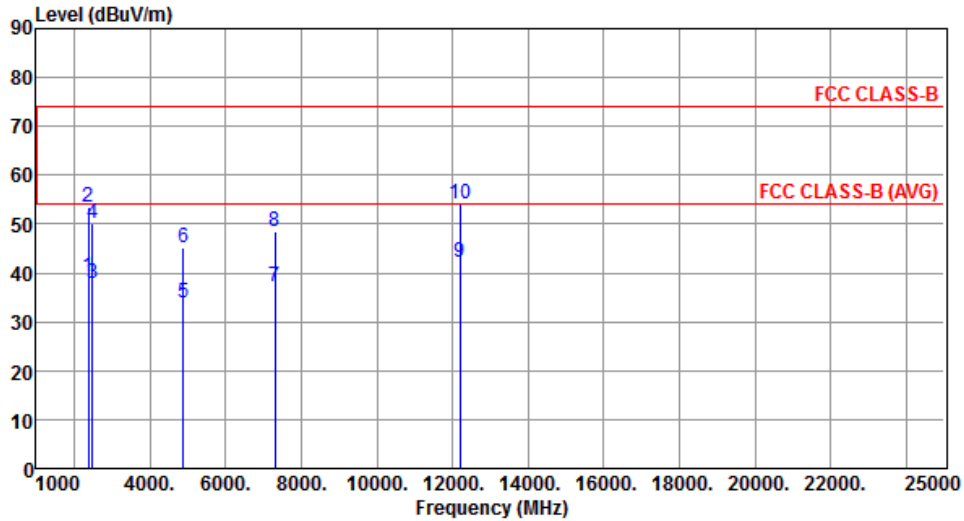

	Freq. MHz	Emission level dBuV/m	Limit dBuV/m	Margin dB	SA reading dBuV	Factor dB	Remark	ANT High cm	Turn Table deg
1	2390.00	39.12	54.00	-14.88	42.30	-3.18	Average	306	97
2	2390.00	53.33	74.00	-20.67	56.51	-3.18	Peak	306	97
3	2483.50	37.83	54.00	-16.17	40.63	-2.80	Average	306	97
4	2483.50	50.09	74.00	-23.91	52.89	-2.80	Peak	306	97
5	4880.00	33.84	54.00	-20.16	29.88	3.96	Average	100	39
6	4880.00	45.01	74.00	-28.99	41.05	3.96	Peak	100	39
7	7320.00	37.03	54.00	-16.97	28.62	8.41	Average	100	131
8	7320.00	48.47	74.00	-25.53	40.06	8.41	Peak	100	131
9	12200.00	42.31	54.00	-11.69	28.63	13.68	Average	100	264
10	12200.00	54.28	74.00	-19.72	40.60	13.68	Peak	100	264

Note 1: Emission Level (dBuV/m) = SA Reading (dBuV/m) + Factor* (dB)

*Factor includes antenna factor , cable loss and amplifier gain

Note 2: Margin (dB) = Emission level (dBuV/m) – Limit (dBuV/m).

Modulation	GFSK	Test Freq. (MHz)	2480
Polarization	Horizontal		

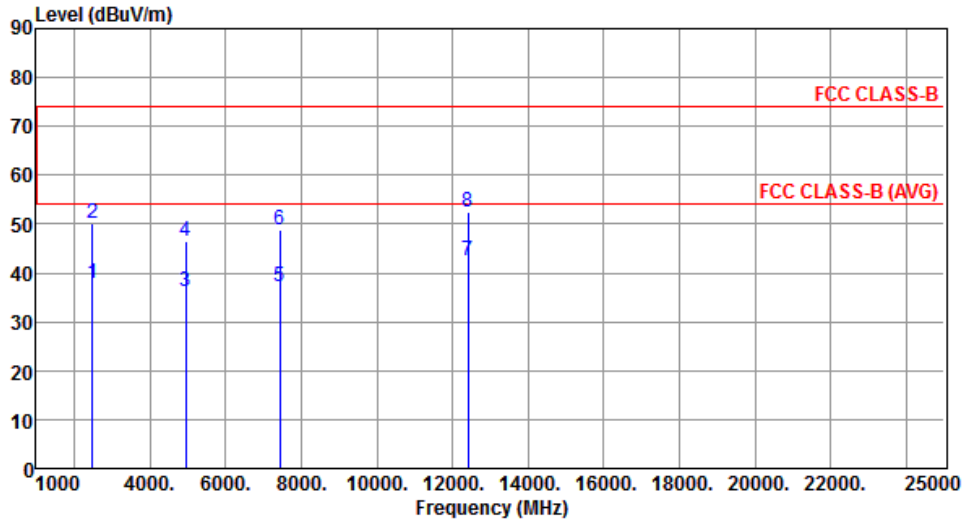

	Freq. MHz	Emission level dBuV/m	Limit dBuV/m	Margin dB	SA reading dBuV	Factor dB	Remark	ANT High cm	Turn Table deg
1	2483.50	38.02	54.00	-15.98	40.82	-2.80	Average	255	157
2	2483.50	50.24	74.00	-23.76	53.04	-2.80	Peak	255	157
3	4960.00	36.25	54.00	-17.75	32.04	4.21	Average	162	0
4	4960.00	46.51	74.00	-27.49	42.30	4.21	Peak	162	0
5	7440.00	37.19	54.00	-16.81	28.66	8.53	Average	100	148
6	7440.00	48.82	74.00	-25.18	40.29	8.53	Peak	100	148
7	12400.00	42.64	54.00	-11.36	28.81	13.83	Average	100	177
8	12400.00	52.51	74.00	-21.49	38.68	13.83	Peak	100	177

Note 1: Emission Level (dBuV/m) = SA Reading (dBuV/m) + Factor* (dB)

*Factor includes antenna factor , cable loss and amplifier gain

Note 2: Margin (dB) = Emission level (dBuV/m) – Limit (dBuV/m).

Modulation	GFSK	Test Freq. (MHz)	2480
Polarization	Vertical		

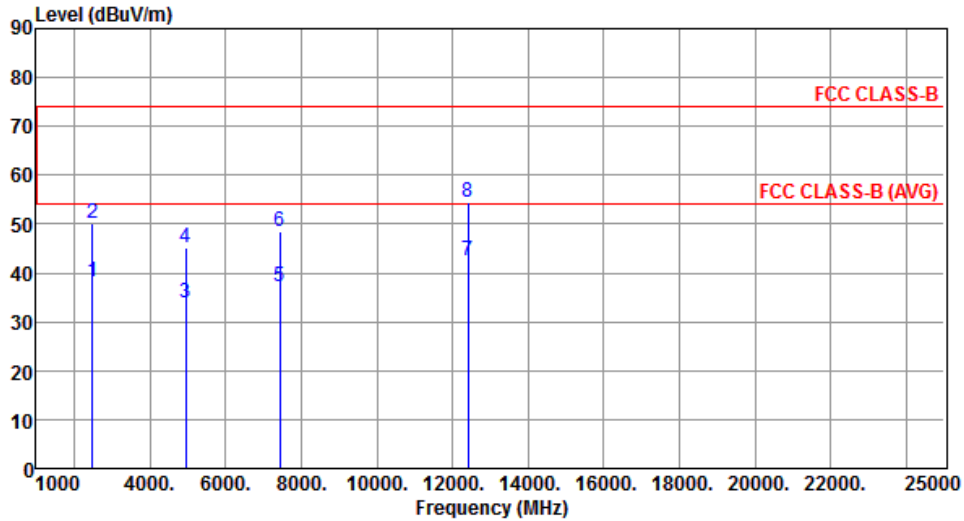

	Freq. MHz	Emission level dBuV/m	Limit dBuV/m	Margin dB	SA reading dBuV	Factor dB	Remark	ANT High cm	Turn Table deg
1	2483.50	38.06	54.00	-15.94	40.86	-2.80	Average	301	95
2	2483.50	50.19	74.00	-23.81	52.99	-2.80	Peak	301	95
3	4960.00	33.95	54.00	-20.05	29.74	4.21	Average	100	42
4	4960.00	45.28	74.00	-28.72	41.07	4.21	Peak	100	42
5	7440.00	37.24	54.00	-16.76	28.71	8.53	Average	100	126
6	7440.00	48.50	74.00	-25.50	39.97	8.53	Peak	100	126
7	12400.00	42.42	54.00	-11.58	28.59	13.83	Average	100	261
8	12400.00	54.58	74.00	-19.42	40.75	13.83	Peak	100	261

Note 1: Emission Level (dBuV/m) = SA Reading (dBuV/m) + Factor* (dB)

*Factor includes antenna factor , cable loss and amplifier gain

Note 2: Margin (dB) = Emission level (dBuV/m) – Limit (dBuV/m).

4 Test laboratory information

Established in 2012, ICC provides foremost EMC & RF Testing and advisory consultation services by our skilled engineers and technicians. Our services employ a wide variety of advanced edge test equipment and one of the widest certification extents in the business.

International Certification Corp (EMC and Wireless Communication Laboratory), it is our definitive objective is to institute long term, trust-based associations with our clients. The expectation we set up with our clients is based on outstanding service, practical expertise and devotion to a certified value structure. Our passion is to grant our clients with best EMC / RF services by oriented knowledgeable and accommodating staff.

Our Test sites are located at Linkou District and Kwei Shan District. Location map can be found on our website <http://www.icertifi.com.tw>.

Linkou

Tel: 886-2-2601-1640

No. 30-2, Ding Fwu Tsuen, Lin
Kou District, New Taipei City,
Taiwan, R.O.C.

Kwei Shan

Tel: 886-3-271-8666

No. 3-1, Lane 6, Wen San 3rd St.,
Kwei Shan District, Tao Yuan City
333, Taiwan, R.O.C.

Kwei Shan Site II

Tel: 886-3-271-8640

No. 14-1, Lane 19, Wen San 3rd
St., Kwei Shan District, Tao Yuan
City 333, Taiwan, R.O.C.

If you have any suggestion, please feel free to contact us as below information.

Tel: 886-3-271-8666

Fax: 886-3-318-0155

Email: ICC_Service@icertifi.com.tw

==END==