



SPORTON International Inc.

No. 52, Hwa Ya 1st Rd., Kwei-Shan Hsiang, TaoYuan Hsien, Taiwan, R.O.C.
Ph: 886-3-327-3456 / FAX: 886-3-327-0973 / www.sporton.com.tw

FCC RADIO TEST REPORT

Applicant's company	Wistron NeWeb Corporation
Applicant Address	20 Park Avenue II, Hsinchu Science Park, Hsinchu 308, Taiwan, R.O.C.
FCC ID	NKR-SWA5
Manufacturer's company	Wistron NeWeb Corporation
Manufacturer Address	20 Park Avenue II, Hsinchu Science Park, Hsinchu 308, Taiwan, R.O.C.

Product Name	Wireless Audio Module
Brand Name	WNC
Model Name	SWA5
Test Rule	47 CFR FCC Part 15 Subpart C § 15.247
Test Freq. Range	2400 ~ 2483.5MHz
Received Date	Oct. 13, 2010
Final Test Date	Oct. 19, 2010
Submission Type	Original Equipment

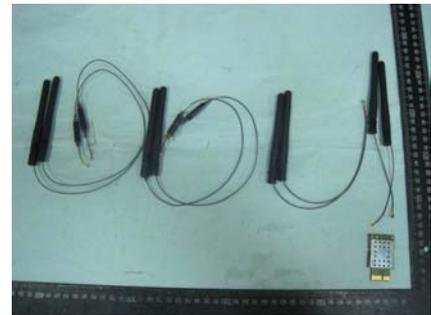

Statement

Test result included in this report is for the IEEE 802.11 part of the product.

The test result in this report refers exclusively to the presented test model / sample.

Without written approval of SPORTON International Inc., the test report shall not be reproduced except in full.

The measurements and test results shown in this test report were made in accordance with the procedures and found in compliance with the limit given in **ANSI C63.4-2003** and **47 CFR FCC Part 15 Subpart C**.

The test equipment used to perform the test is calibrated and traceable to NML/ROC.



Table of Contents

1. CERTIFICATE OF COMPLIANCE	1
2. SUMMARY OF THE TEST RESULT	2
3. GENERAL INFORMATION	3
3.1. Product Details.....	3
3.2. Accessories.....	4
3.3. Table for Filed Antenna	4
3.4. Table for Carrier Frequencies	5
3.5. Table for Test Modes.....	6
3.6. Table for Testing Locations.....	7
3.7. Table for Supporting Units	7
3.8. Table for Parameters of Test Software Setting	8
3.9. Test Configurations	9
4. TEST RESULT	13
4.1. AC Power Line Conducted Emissions Measurement.....	13
4.2. Peak Output Power Measurement	17
4.3. Power Spectral Density Measurement	19
4.4. 6dB Spectrum Bandwidth Measurement	22
4.5. Radiated Emissions Measurement	25
4.6. Band Edge Emissions Measurement	39
4.7. Antenna Requirements	42
5. LIST OF MEASURING EQUIPMENTS.....	43
6. TEST LOCATION	45
7. TAF CERTIFICATE OF ACCREDITATION	46
APPENDIX A. PHOTOGRAPHS OF EUT	A1 ~ A7
APPENDIX B. TEST PHOTOS.....	B1 ~ B8
APPENDIX C. MAXIMUM PERMISSIBLE EXPOSURE	C1 ~C3

1. CERTIFICATE OF COMPLIANCE

Product Name : Wireless Audio Module
Brand Name : WNC
Model Name : SWA5
Applicant : Wistron NeWeb Corporation
Test Rule Part(s) : 47 CFR FCC Part 15 Subpart C § 15.247

Sporton International as requested by the applicant to evaluate the EMC performance of the product sample received on Oct. 13, 2010 would like to declare that the tested sample has been evaluated and found to be in compliance with the tested rule parts. The data recorded as well as the test configuration specified is true and accurate for showing the sample's EMC nature.

Jordan Hsiao 2010-10-26

Jordan Hsiao

SPORTON INTERNATIONAL INC.

2. SUMMARY OF THE TEST RESULT

Applied Standard: 47 CFR FCC Part 15 Subpart C				
Part	Rule Section	Description of Test	Result	Under Limit
4.1	15.207	AC Power Line Conducted Emissions	Complies	11.85 dB
4.2	15.247(b)(3)	Maximum Conducted Output Power	Complies	6.44 dB
4.3	15.247(e)	Power Spectral Density	Complies	19.61 dB
4.4	15.247(a)(2)	6dB Spectrum Bandwidth	Complies	-
4.5	15.247(d)	Radiated Emissions	Complies	1.44 dB
4.6	15.247(d)	Band Edge Emissions	Complies	1.70 dB
4.7	15.203	Antenna Requirements	Complies	-

Test Items	Uncertainty	Remark
AC Power Line Conducted Emissions	±2.3dB	Confidence levels of 95%
Maximum Conducted Output Power	±0.8dB	Confidence levels of 95%
Power Spectral Density	±0.5dB	Confidence levels of 95%
6dB Spectrum Bandwidth	±8.5×10 ⁻⁸	Confidence levels of 95%
Radiated Emissions (9kHz~30MHz)	±0.8dB	Confidence levels of 95%
Radiated Emissions (30MHz~1000MHz)	±1.9dB	Confidence levels of 95%
Radiated / Band Edge Emissions (1GHz~18GHz)	±1.9dB	Confidence levels of 95%
Radiated Emissions (18GHz~40GHz)	±1.9dB	Confidence levels of 95%
Temperature	±0.7°C	Confidence levels of 95%
Humidity	±3.2%	Confidence levels of 95%
DC / AC Power Source	±1.4%	Confidence levels of 95%

3. GENERAL INFORMATION

3.1. Product Details

Items	Description
Radio Type	Intentional Transceiver
Power Type	From Fixture
Modulation	OFDM
Data Modulation	pi/DQPSK
Data Rate (Mbps)	27.55Mbps
Frequency Range	2400 ~ 2483.5MHz
Channel Number	3
Channel Band Width (99%)	16.24 MHz
Conducted Output Power	23.56 dBm
Carrier Frequencies	Please refer to section 3.4
Antenna	Please refer to section 3.3

3.2. Accessories

N/A

3.3. Table for Filed Antenna

Ant.	Brand	Model Name	Antenna Type	Connector	Gain (dBi)	Cable Loss (dB)	Total Gain (dBi)	Antenna Cable Length (cm)
1	MASTER WAVE TECHNOLOGY CO., LTD.	98241MIPF021	Dipole Antenna	I-PEX	1.8	0.3	1.5	9.5
2					1.8	0.6	1.2	19
3					1.8	1	0.8	31.5
4					1.8	1.3	0.5	40

Note:

There are four sets of antenna; the EUT supports the antenna with TX/RX diversity function.

Due to Ant. 1, Ant. 2, Ant. 3 & Ant. 4 are identical and the “port A” generated higher output power than “port B”. All the test were base on this setting and recorded in this report.



3.4. Table for Carrier Frequencies

Frequency Band	Frequency
2400~2483.5MHz	2412 MHz
	2438 MHz
	2462 MHz

3.5. Table for Test Modes

Preliminary tests were performed in different data rate to find the worst radiated emission. The data rate shown in the table below is the worst-case rate with respect to the specific test item. Investigation has been done on all the possible configurations for searching the worst cases. The following table is a list of the test modes shown in this test report.

Test Items	Mode	Data Rate (Mbps)	Frequency (MHz)	Antenna
AC Power Line Conducted Emissions	Normal Link	-	-	-
Maximum Peak Conducted Output Power Power Spectral Density 6dB Spectrum Bandwidth	pi/DQPSK	27.55	2142 2438 2462	1
Radiated Emissions 9kHz~1GHz	Normal Link	-	-	-
Radiated Emissions 1GHz~10 th Harmonic	pi/DQPSK	27.55	2142 2438 2462	1
Band Edge Emissions	pi/DQPSK	27.55	2142 2438 2462	1

Note:

Test Mode: EUT + Ant. 1

Test Mode: EUT + Ant. 2

Test Mode: EUT + Ant. 3

Test Mode: EUT + Ant. 4

<For Conducted Emissions Test, Radiated Emissions Test Above 1GHz and Other Tests>:

Due to Ant.1 ~ Ant. 4 is the same type antenna, only the higher gain antenna Mode 1 (Ant. 1) was tested and recorded in this report.

<For Radiated Emissions Test Below 1GHz>:

All the test modes were performed and recorded in this report.

3.6. Table for Testing Locations

Test Site No.	Site Category	Location	FCC Reg. No.	IC File No.	VCCI Reg. No
03CH03-HY	SAC	Hwa Ya	879474	IC 4086	-
CO04-HY	Conduction	Hwa Ya	879474	IC 4086	-
TH01-HY	OVEN Room	Hwa Ya	-	-	-

Open Area Test Site (OATS); Semi Anechoic Chamber (SAC); Fully Anechoic Chamber (FAC).

Please refer section 6 for Test Site Address.

3.7. Table for Supporting Units

Support Unit	Brand	Model	FCC ID
AC Adaptor	NEC	ALI-000618-003	N/A

3.8. Table for Parameters of Test Software Setting

During testing, Channel & Power Controlling Software provided by the customer was used to control the operating channel as well as the output power level. The RF output power selection is for the setting of RF output power expected by the customer and is going to be fixed on the firmware of the final end product.

Test Software Version	AM2Gtest v1.1.0.59		
Frequency	2412 MHz	2438 MHz	2462 MHz
Ant. 1	155	155	155

During the testing, "AM2Gtest v1.1.0.59" was executed the test program to control the EUT continuously transmit RF signal.

3.9. Test Configurations

3.9.1. Radiation Emissions Test Configuration

Test Configuration: Below 1GHz

Test Mode : Mode 1

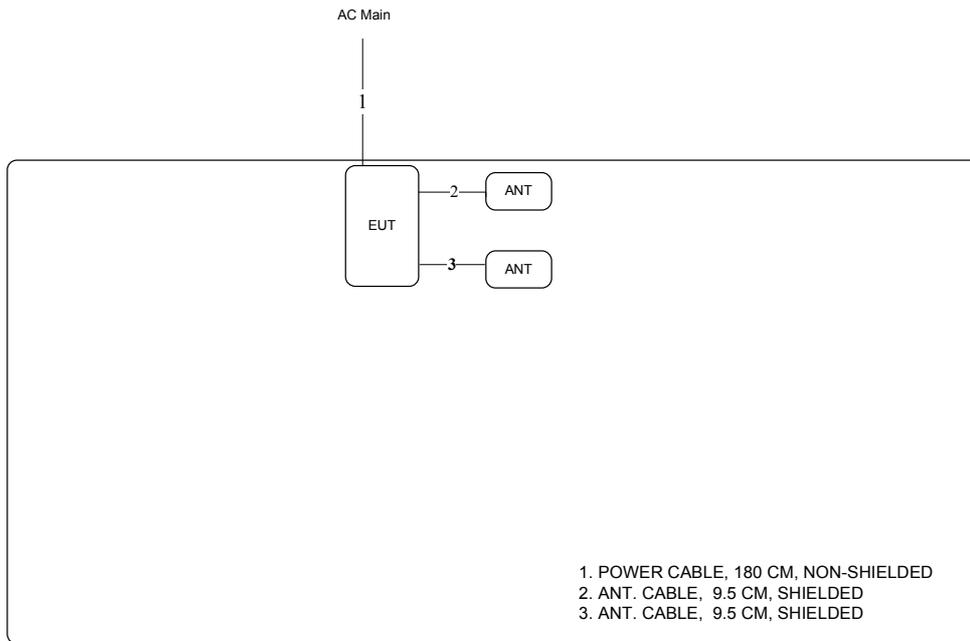

Test Mode : Mode 2

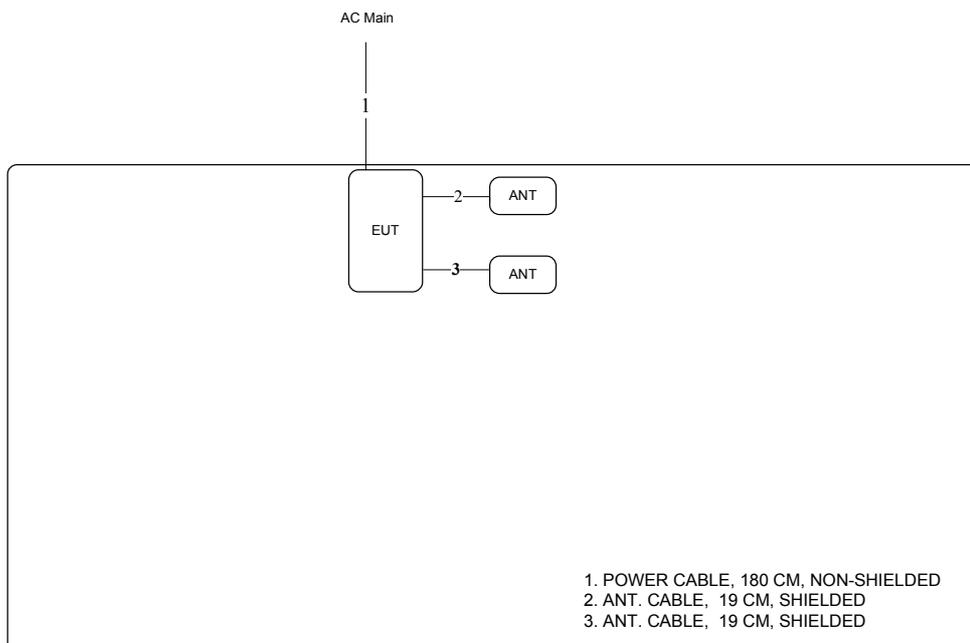

Test Mode : Mode 3

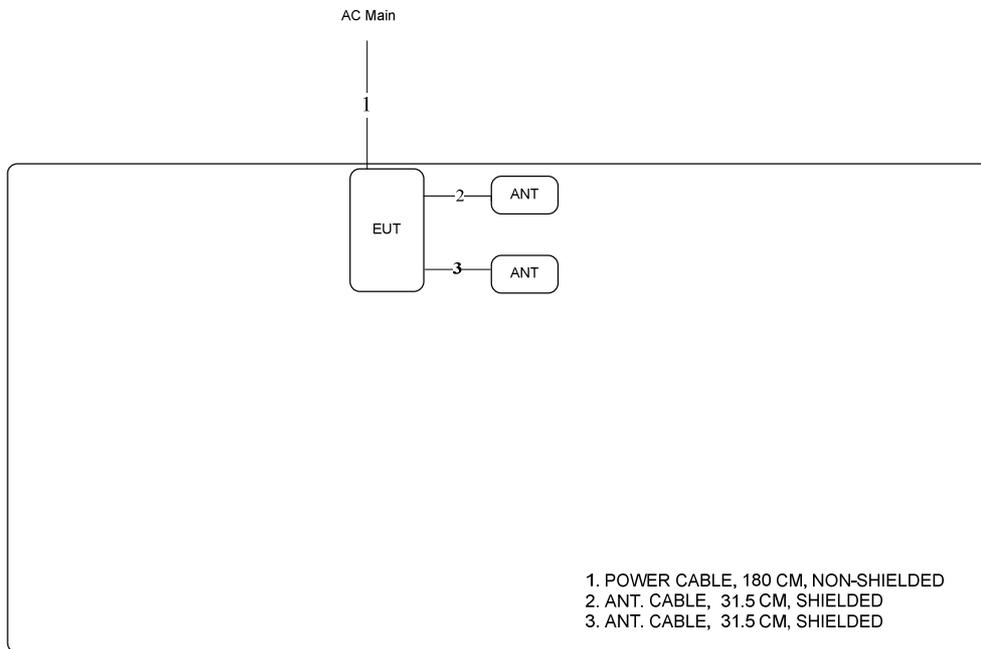

Test Mode : Mode 4

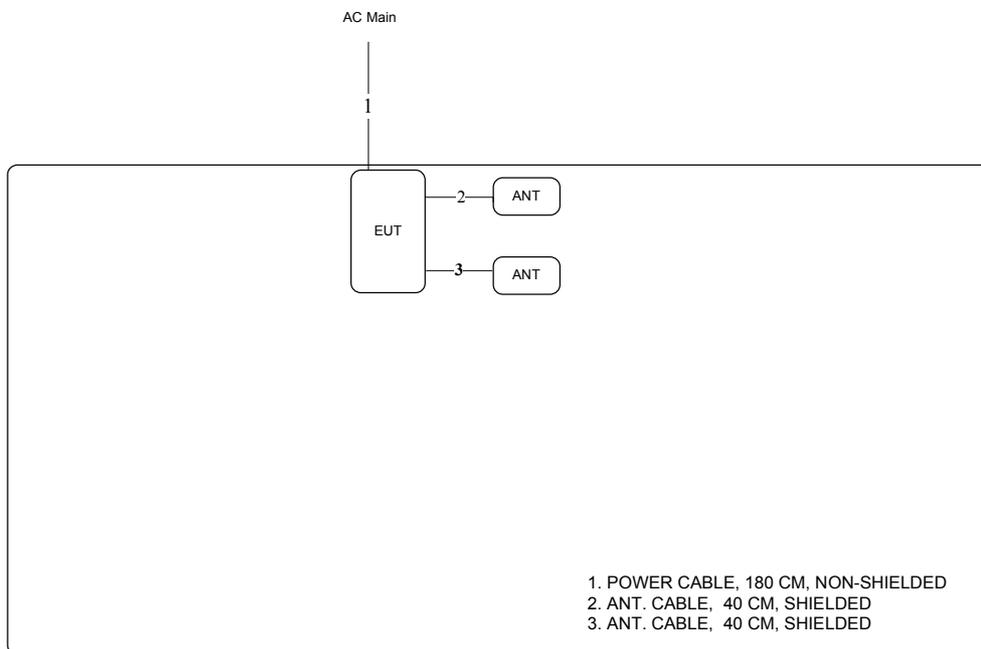

Test Configuration: Above 1GHz

Test Mode : Mode 1

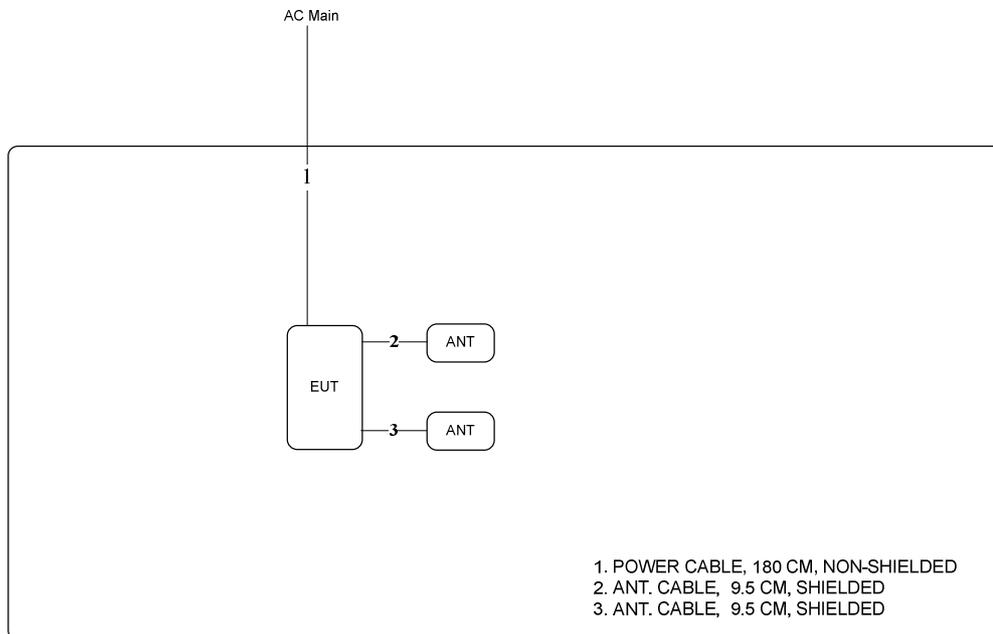

3.9.2. AC Power Line Conduction Emissions Test Configuration

Test Mode: Mode 1

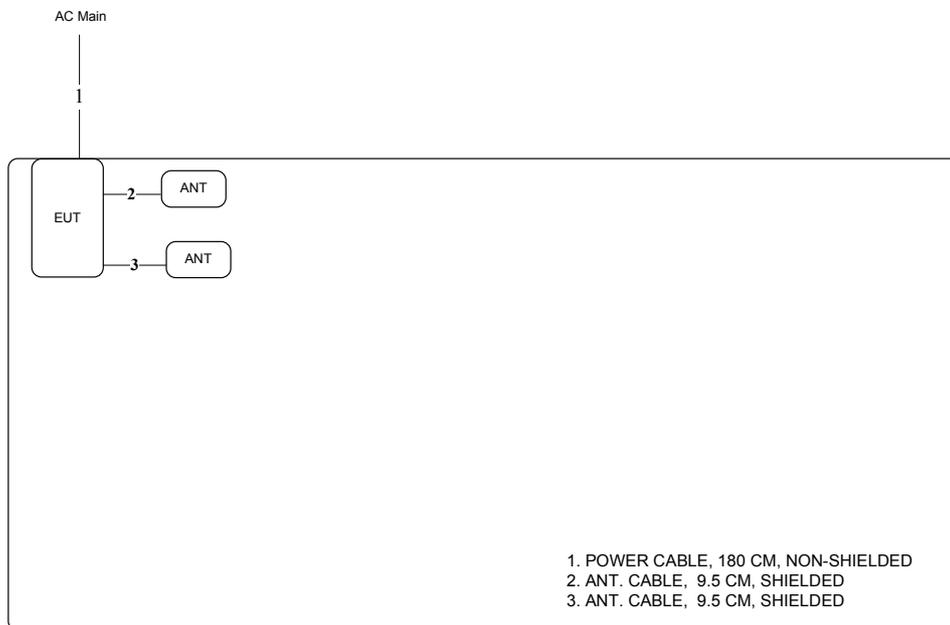

4. TEST RESULT

4.1. AC Power Line Conducted Emissions Measurement

4.1.1. Limit

For this product which is designed to be connected to the AC power line, the radio frequency voltage that is conducted back onto the AC power line on any frequency or frequencies within the band 150 kHz to 30 MHz shall not exceed below limits table.

Frequency (MHz)	QP Limit (dBuV)	AV Limit (dBuV)
0.15~0.5	66~56	56~46
0.5~5	56	46
5~30	60	50

4.1.2. Measuring Instruments and Setting

Please refer to section 5 of equipments list in this report. The following table is the setting of the receiver.

Receiver Parameters	Setting
Attenuation	10 dB
Start Frequency	0.15 MHz
Stop Frequency	30 MHz
IF Bandwidth	9 KHz

4.1.3. Test Procedures

1. Configure the EUT according to ANSI C63.4. The EUT or host of EUT has to be placed 0.4 meter far from the conducting wall of the shielding room and at least 80 centimeters from any other grounded conducting surface.
2. Connect EUT or host of EUT to the power mains through a line impedance stabilization network (LISN).
3. All the support units are connected to the other LISNs. The LISN should provide 50uH/50ohms coupling impedance.
4. The frequency range from 150 KHz to 30 MHz was searched.
5. Set the test-receiver system to Peak Detect Function and Specified Bandwidth with Maximum Hold Mode.
6. The measurement has to be done between each power line and ground at the power terminal.

4.1.4. Test Setup Layout

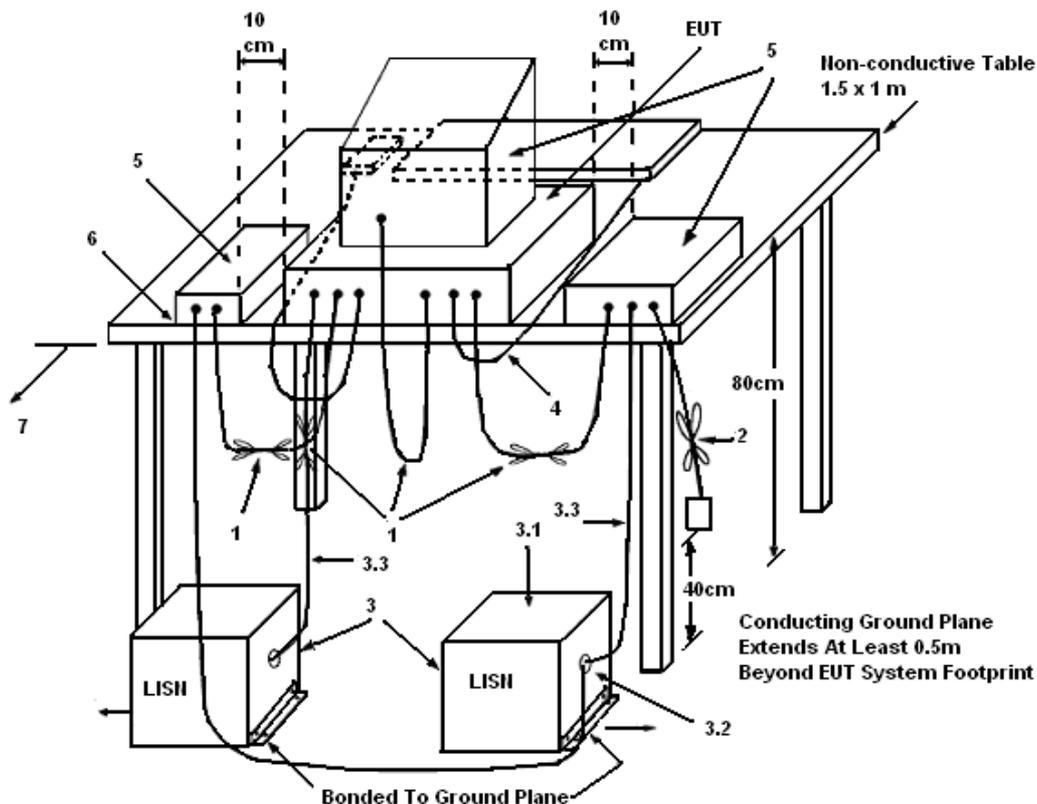

LEGEND:

- (1) Interconnecting cables that hang closer than 40 cm to the ground plane shall be folded back and forth in the center forming a bundle 30 to 40 cm long.
- (2) I/O cables that are not connected to a peripheral shall be bundled in the center. The end of the cable may be terminated, if required, using the correct terminating impedance. The overall length shall not exceed 1 m.
- (3) EUT connected to one LISN. Unused LISN measuring port connectors shall be terminated in 50 Ω. LISN can be placed on top of, or immediately beneath, reference ground plane.
 - (3.1) All other equipment powered from additional LISN(s).
 - (3.2) Multiple outlet strip can be used for multiple power cords of non-EUT equipment.
 - (3.3) LISN at least 80 cm from nearest part of EUT chassis.
- (4) Cables of hand-operated devices, such as keyboards, mice, etc., shall be placed as for normal use.
- (5) Non-EUT components of EUT system being tested.
- (6) Rear of EUT, including peripherals, shall all be aligned and flush with rear of tabletop.
- (7) Rear of tabletop shall be 40 cm removed from a vertical conducting plane that is bonded to the ground plane.

4.1.5. Test Deviation

There is no deviation with the original standard.

4.1.6. EUT Operation during Test

The EUT was placed on the test table and programmed in normal function.

4.1.7. Results of AC Power Line Conducted Emissions Measurement

Temperature	23°C	Humidity	55%
Test Engineer	Beck Wu	Phase	Line
Configuration	Normal Link / Mode 1		

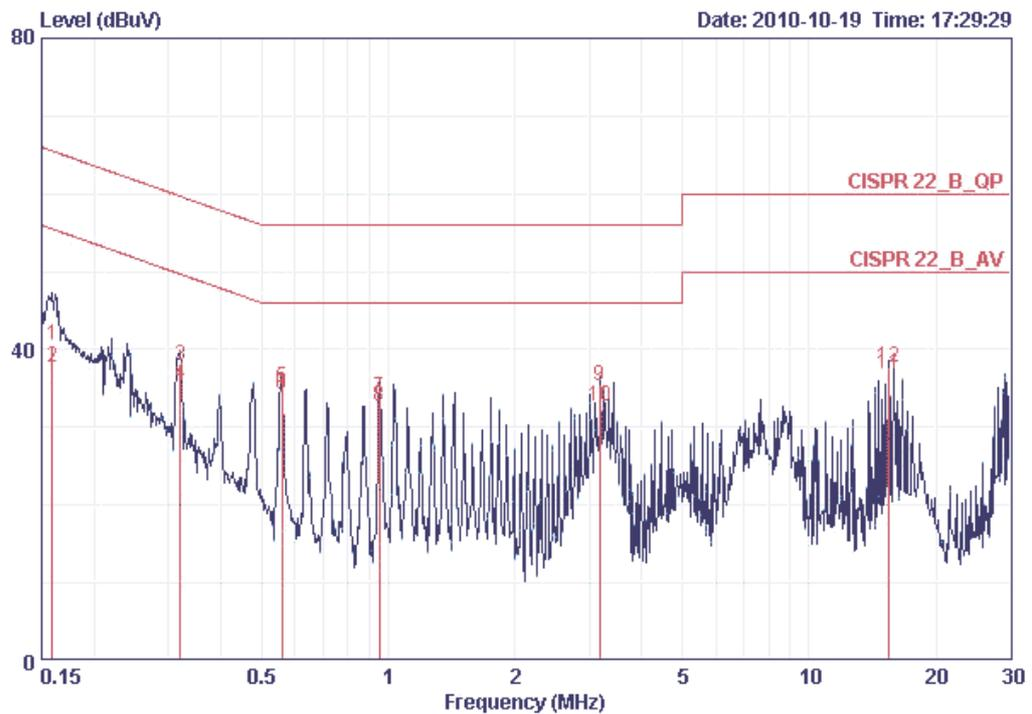

	Freq	Level	Over Limit	Limit Line	Read Level	LISN Factor	Cable Loss	Remark
	MHz	dBuV	dB	dBuV	dBuV	dB	dB	
1	0.15900	40.61	-24.91	65.52	40.34	0.07	0.20	QP
2	0.15900	37.81	-17.71	55.52	37.54	0.07	0.20	AVERAGE
3	0.31999	37.84	-21.87	59.71	37.60	0.04	0.20	QP
4	0.31999	35.60	-14.11	49.71	35.36	0.04	0.20	AVERAGE
5	0.55815	35.12	-20.88	56.00	34.89	0.03	0.20	QP
6	0.55815	34.15	-11.85	46.00	33.92	0.03	0.20	AVERAGE
7	0.95269	33.89	-22.11	56.00	33.66	0.03	0.20	QP
8	0.95269	32.59	-13.41	46.00	32.36	0.03	0.20	AVERAGE
9	3.177	35.40	-20.60	56.00	35.08	0.08	0.24	QP
10	3.177	32.76	-13.24	46.00	32.44	0.08	0.24	AVERAGE
11	15.408	36.94	-13.06	50.00	35.96	0.58	0.40	AVERAGE
12	15.408	37.62	-22.38	60.00	36.64	0.58	0.40	QP

Temperature	23°C	Humidity	55%
Test Engineer	Beck Wu	Phase	Neutral
Configuration	Normal Link / Mode 1		

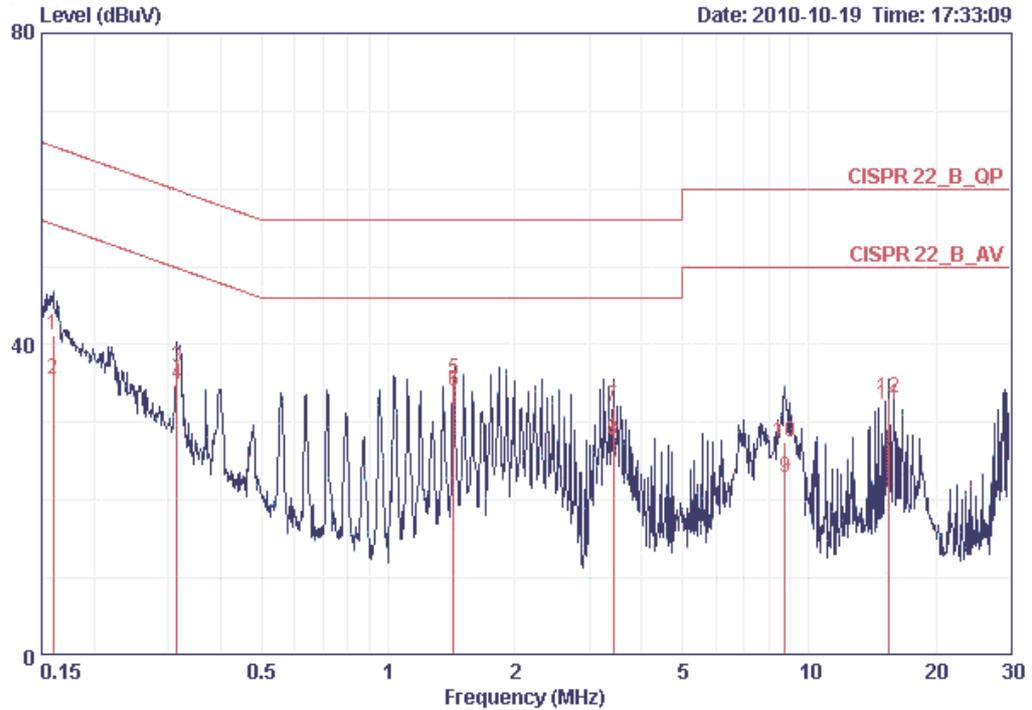

	Freq	Level	Over Limit	Limit Line	Read Level	LISN Factor	Cable Loss	Remark
	MHz	dBuV	dB	dBuV	dBuV	dB	dB	
1	0.15985	41.27	-24.20	65.47	40.97	0.10	0.20	QP
2	0.15985	35.64	-19.83	55.47	35.34	0.10	0.20	AVERAGE
3	0.31495	36.98	-22.86	59.84	36.71	0.07	0.20	QP
4	0.31495	34.84	-15.00	49.84	34.57	0.07	0.20	AVERAGE
5	1.430	35.50	-20.50	56.00	35.31	0.08	0.11	QP
6	1.430	34.06	-11.94	46.00	33.87	0.08	0.11	AVERAGE
7	3.417	32.11	-23.89	56.00	31.70	0.13	0.28	QP
8	3.417	27.68	-18.32	46.00	27.27	0.13	0.28	AVERAGE
9	8.776	22.95	-27.05	50.00	22.30	0.35	0.30	AVERAGE
10	8.776	27.41	-32.59	60.00	26.76	0.35	0.30	QP
11	15.408	32.20	-17.80	50.00	31.20	0.60	0.40	AVERAGE
12	15.408	33.11	-26.89	60.00	32.11	0.60	0.40	QP

Note:

Level = Read Level + LISN Factor + Cable Loss.

4.2. Peak Output Power Measurement

4.2.1. Limit

For systems using digital modulation in the 2400-2483.5MHz, the limit for peak output power is 30dBm. The limited has to be reduced by the amount in dB that the gain of the antenna exceed 6dBi. In case of point-to-point operation, the limit has to be reduced by 1dB for every 3dB that the directional gain of the antenna exceeds 6dBi.

4.2.2. Measuring Instruments and Setting

Please refer to section 5 of equipments list in this report. The following table is the setting of the peak power meter.

Power Meter Parameter	Setting
Bandwidth	50MHz bandwidth is greater than the EUT emission bandwidth
Detector	Peak

4.2.3. Test Procedures

Spectrum Parameter	Setting
RF Output Power Method	<input checked="" type="checkbox"/> ANSI C63.10 clause 6.10.2.1 (a) power meter method
RF Output Power Method	<input type="checkbox"/> ANSI C63.10 clause 6.10.2.1 (b) channel integration method
RF Output Power Method	<input type="checkbox"/> ANSI C63.10 clause 6.10.3.1 Method 1 - spectral trace averaging
RF Output Power Method	<input type="checkbox"/> ANSI C63.10 clause 6.10.3.2 Method 2 - zero-span mode with trace averaging

4.2.4. Test Setup Layout

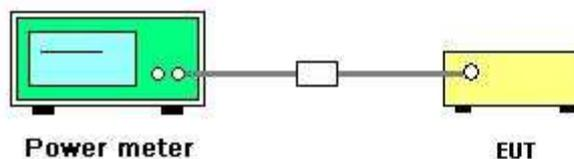

4.2.5. Test Deviation

There is no deviation with the original standard.

4.2.6. EUT Operation during Test

The EUT was programmed to be in continuously transmitting mode.

4.2.7. Test Result of Maximum Conducted Output Power

Temperature	25°C	Humidity	60%
Test Engineer	Sean Ku	Test Date	Oct. 19, 2010

Frequency	Conducted Power (dBm)	Max. Limit (dBm)	Result
2412 MHz	23.56	30.00	Complies
2438 MHz	23.38	30.00	Complies
2462 MHz	23.38	30.00	Complies

4.3. Power Spectral Density Measurement

4.3.1. Limit

For digitally modulated systems, the power spectral density conducted from the intentional radiator to the antenna shall not be greater than 8 dBm in any 3 kHz band during any time interval of continuous transmission.

4.3.2. Measuring Instruments and Setting

Please refer to section 5 of equipments list in this report. The following table is the setting of Spectrum Analyzer.

Spectrum Parameter	Setting
Attenuation	Auto
Span Frequency	30 kHz
RB	3 kHz
VB	30 kHz
Detector	Peak

4.3.3. Test Procedures

Spectrum Parameter	Setting
Power Density Method	<input checked="" type="checkbox"/> UNII for ANSI C63.10 clause 6.11.2.3 Method 1 - peak measurement
Power Density Method	<input type="checkbox"/> UNII for ANSI C63.10 clause 6.11.2.4 Method 2 - trace averaging

4.3.4. Test Setup Layout

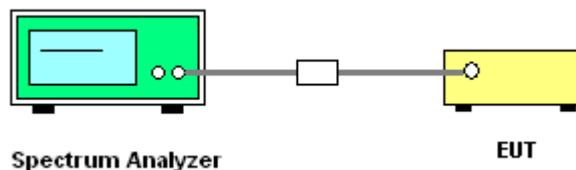

4.3.5. Test Deviation

There is no deviation with the original standard.

4.3.6. EUT Operation during Test

The EUT was programmed to be in continuously transmitting mode.

4.3.7. Test Result of Power Spectral Density

Temperature	25°C	Humidity	60%
Test Engineer	Sean Ku		

Frequency	Power Density (dBm/3kHz)	Max. Limit (dBm/3kHz)	Result
2412 MHz	-11.61	8.00	Complies
2438 MHz	-11.71	8.00	Complies
2462 MHz	-11.93	8.00	Complies

Power Density Plot on 2412 MHz / Ant. 1

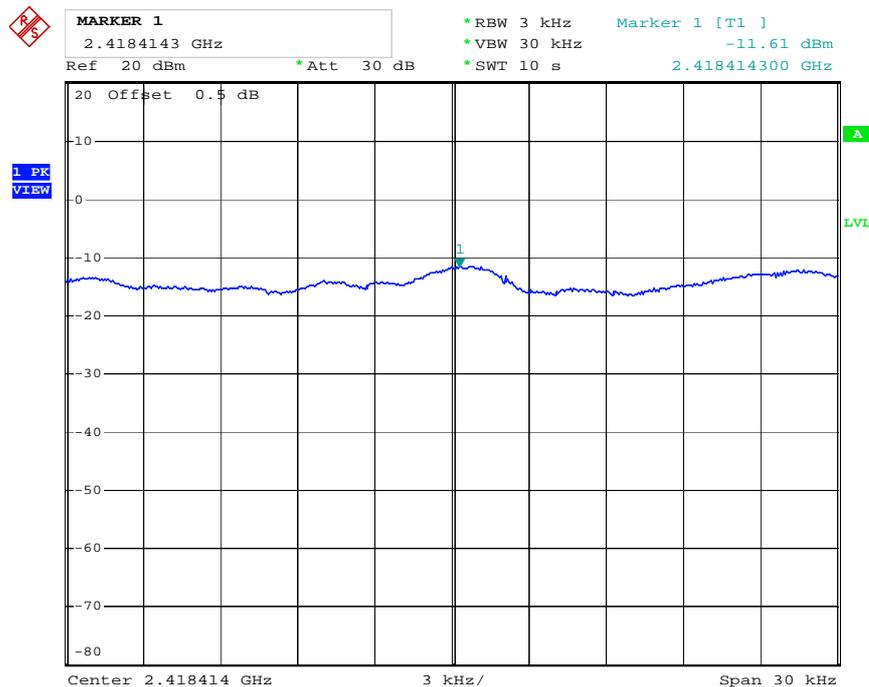

Date: 19.OCT.2010 17:26:32

Power Density Plot on 2438 MHz / Ant. 1

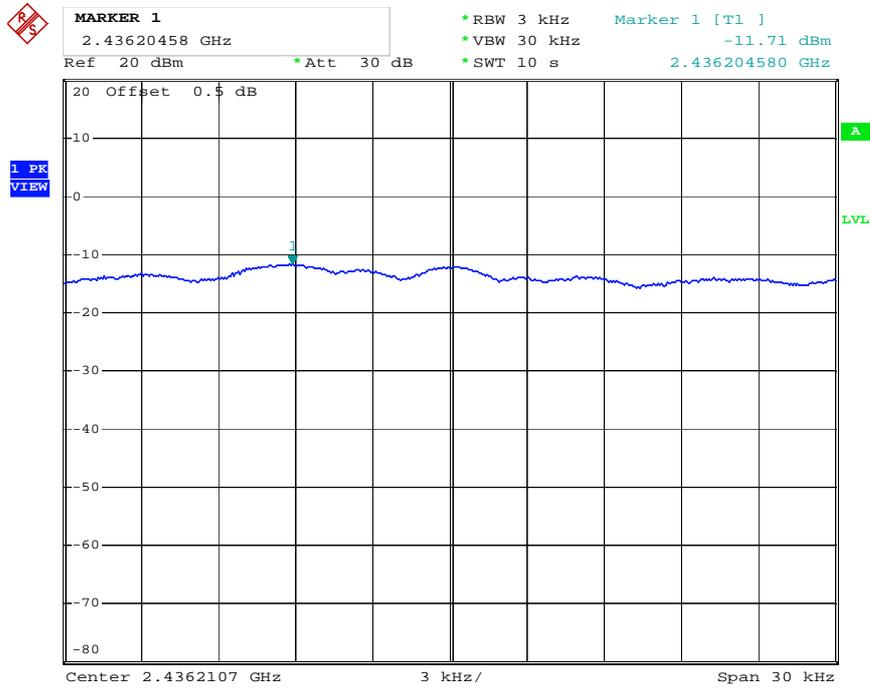

Date: 19.OCT.2010 17:14:15

Power Density Plot on 2462 MHz / Ant. 1

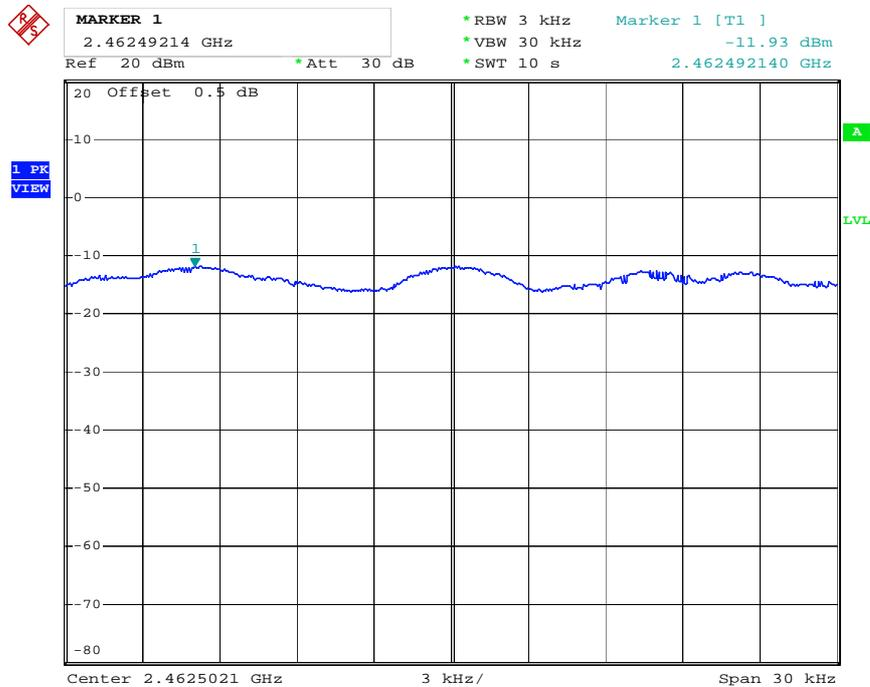

Date: 19.OCT.2010 17:31:15

4.4. 6dB Spectrum Bandwidth Measurement

4.4.1. Limit

For digital modulation systems, the minimum 6 dB bandwidth shall be at least 500 kHz.

4.4.2. Measuring Instruments and Setting

Please refer to section 5 of equipments list in this report. The following table is the setting of the Spectrum Analyzer.

Spectrum Parameters	Setting
Attenuation	Auto
Span Frequency	> 6dB Bandwidth
RB	100 kHz
VB	100 kHz
Detector	Peak
Trace	Max Hold
Sweep Time	Auto

4.4.3. Test Procedures

1. The transmitter output (antenna port) was connected to the spectrum analyzer in peak hold mode.
2. The resolution bandwidth of 100 kHz and the video bandwidth of 100 kHz were used.
3. Measured the spectrum width with power higher than 6dB below carrier.

4.4.4. Test Setup Layout

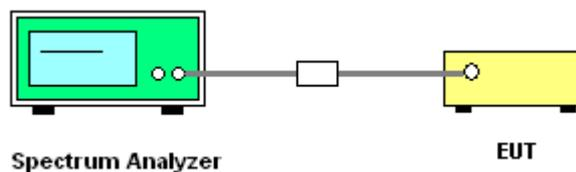

4.4.5. Test Deviation

There is no deviation with the original standard.

4.4.6. EUT Operation during Test

The EUT was programmed to be in continuously transmitting mode.

6 dB Bandwidth Plot on 2438 MHz / Ant. 1

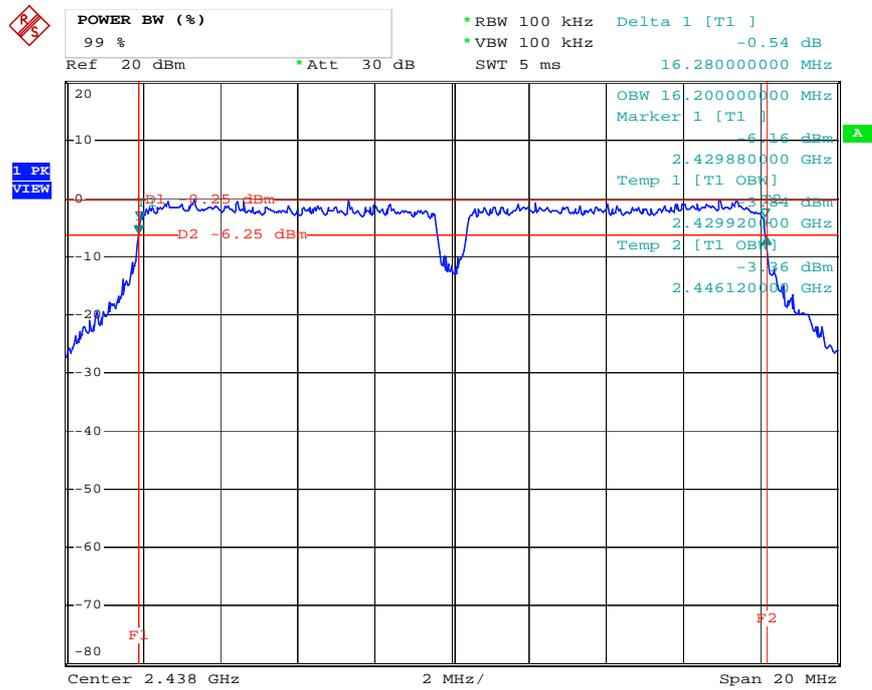

Date: 19.OCT.2010 17:11:54

6 dB Bandwidth Plot on 2462 MHz / Ant. 1

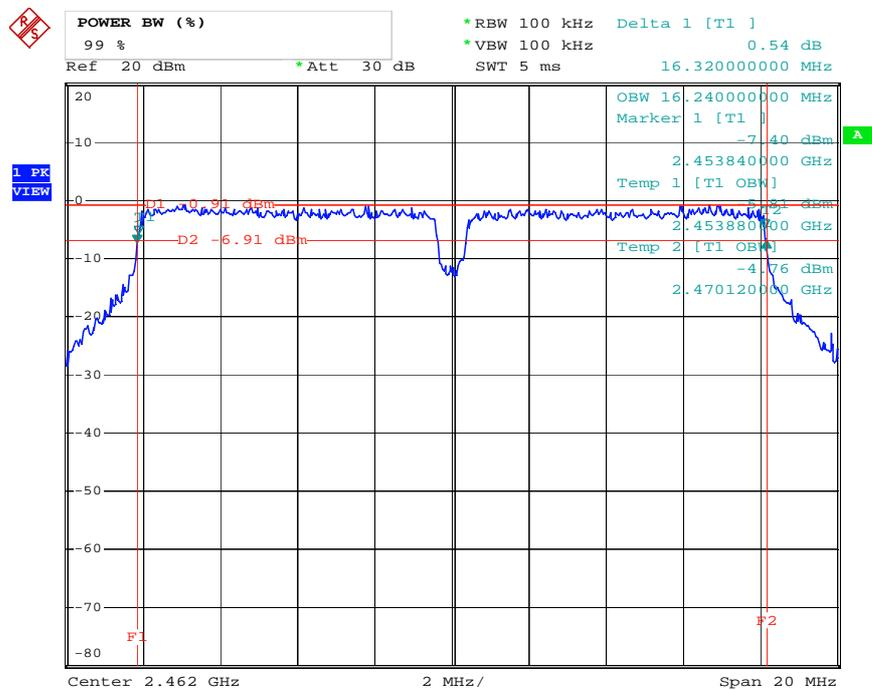

Date: 19.OCT.2010 17:33:02

4.5. Radiated Emissions Measurement

4.5.1. Limit

20dBc in any 100 kHz bandwidth outside the operating frequency band. In case the emission fall within the restricted band specified on 15.205(a), then the 15.209(a) limit in the table below has to be followed.

Frequencies (MHz)	Field Strength (micorvolts/meter)	Measurement Distance (meters)
0.009~0.490	2400/F(KHz)	300
0.490~1.705	24000/F(KHz)	30
1.705~30.0	30	30
30~88	100	3
88~216	150	3
216~960	200	3
Above 960	500	3

4.5.2. Measuring Instruments and Setting

Please refer to section 5 of equipments list in this report. The following table is the setting of spectrum analyzer and receiver.

Spectrum Parameter	Setting
Attenuation	Auto
Start Frequency	1000 MHz
Stop Frequency	10th carrier harmonic
RB / VB (Emission in restricted band)	1MHz / 1MHz for Peak, 1 MHz / 10Hz for Average
RB / VB (Emission in non-restricted band)	1MHz / 1MHz for peak

Receiver Parameter	Setting
Attenuation	Auto
Start ~ Stop Frequency	9kHz~150kHz / RB 200Hz for QP
Start ~ Stop Frequency	150kHz~30MHz / RB 9kHz for QP
Start ~ Stop Frequency	30MHz~1000MHz / RB 120kHz for QP

4.5.3. Test Procedures

1. Configure the EUT according to ANSI C63.4. The EUT was placed on the top of the turntable 0.8 meter above ground. The phase center of the receiving antenna mounted on the top of a height-variable antenna tower was placed 3 meters far away from the turntable.
2. Power on the EUT and all the supporting units. The turntable was rotated by 360 degrees to determine the position of the highest radiation.
3. The height of the broadband receiving antenna was varied between one meter and four meters above ground to find the maximum emissions field strength of both horizontal and vertical polarization.
4. For each suspected emissions, the antenna tower was scan (from 1 m to 4 m) and then the turntable was rotated (from 0 degree to 360 degrees) to find the maximum reading.
5. Set the test-receiver system to Peak or CISPR quasi-peak Detect Function with specified bandwidth under Maximum Hold Mode.
6. For emissions above 1GHz, use 1MHz VBW and RBW for peak reading. Then 1MHz RBW and 10Hz VBW for average reading in spectrum analyzer.
7. When the radiated emissions limits are expressed in terms of the average value of the emissions, and pulsed operation is employed, the measurement field strength shall be determined by averaging over one complete pulse train, including blanking intervals, as long as the pulse train does not exceed 0.1 seconds. As an alternative (provided the transmitter operates for longer than 0.1 seconds) or in cases where the pulse train exceeds 0.1 seconds, the measured field strength shall be determined from the average absolute voltage during a 0.1 second interval during which the field strength is at its maximum value.
8. If the emissions level of the EUT in peak mode was 3 dB lower than the average limit specified, then testing will be stopped and peak values of EUT will be reported, otherwise, the emissions which do not have 3 dB margin will be repeated one by one using the quasi-peak method for below 1GHz.
9. For testing above 1GHz, the emissions level of the EUT in peak mode was lower than average limit (that means the emissions level in peak mode also complies with the limit in average mode), then testing will be stopped and peak values of EUT will be reported, otherwise, the emissions will be measured in average mode again and reported.
10. In case the emission is lower than 30MHz, loop antenna has to be used for measurement and the recorded data should be QP measured by receiver. High – Low scan is not required in this case.

4.5.4. Test Setup Layout

For radiated emissions below 30MHz

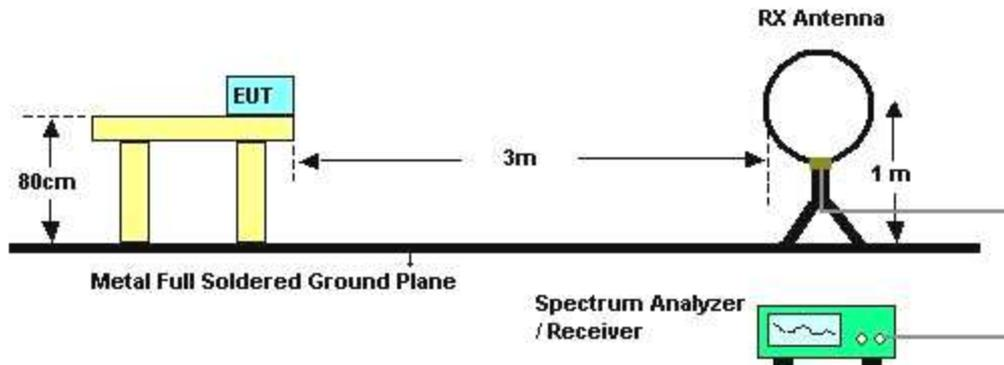

For radiated emissions above 30MHz

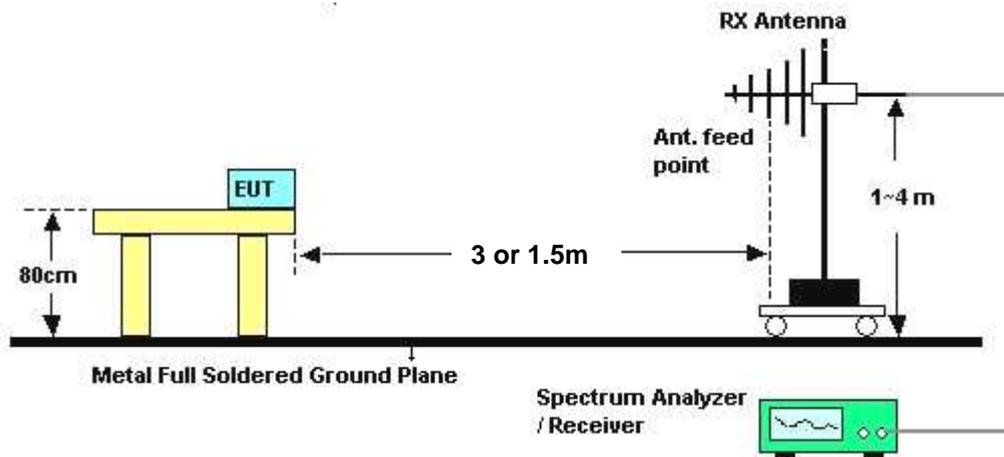

Above 10 GHz shall be extrapolated to the specified distance using an extrapolation factor of 20 dB/decade from 3m to 1.5m.

Distance extrapolation factor = $20 \log(\text{specific distance [3m]} / \text{test distance [1.5m]})$ (dB);

Limit line = specific limits (dBuV) + distance extrapolation factor [6 dB].

4.5.5. Test Deviation

There is no deviation with the original standard.

4.5.6. EUT Operation during Test

The EUT was programmed to be in continuously transmitting mode.

4.5.7. Results of Radiated Emissions (9kHz~30MHz)

Temperature	23°C	Humidity	55%
Test Engineer	Sweway Lee	Evaluation Date	Oct. 15, 2010

Freq. (MHz)	Level (dBuV)	Over Limit (dB)	Limit Line (dBuV)	Remark
-	-	-	-	See Note

Note:

The amplitude of spurious emissions which are attenuated by more than 20 dB below the permissible value has no need to be reported.

Distance extrapolation factor = $40 \log(\text{specific distance} / \text{test distance})$ (dB);

Limit line = specific limits (dBuV) + distance extrapolation factor.

4.5.8. Results of Radiated Emissions (30MHz~1GHz)

Temperature	23°C	Humidity	55%
Test Engineer	Serway Lee	Configurations	Normal Link / Mode1

Horizontal

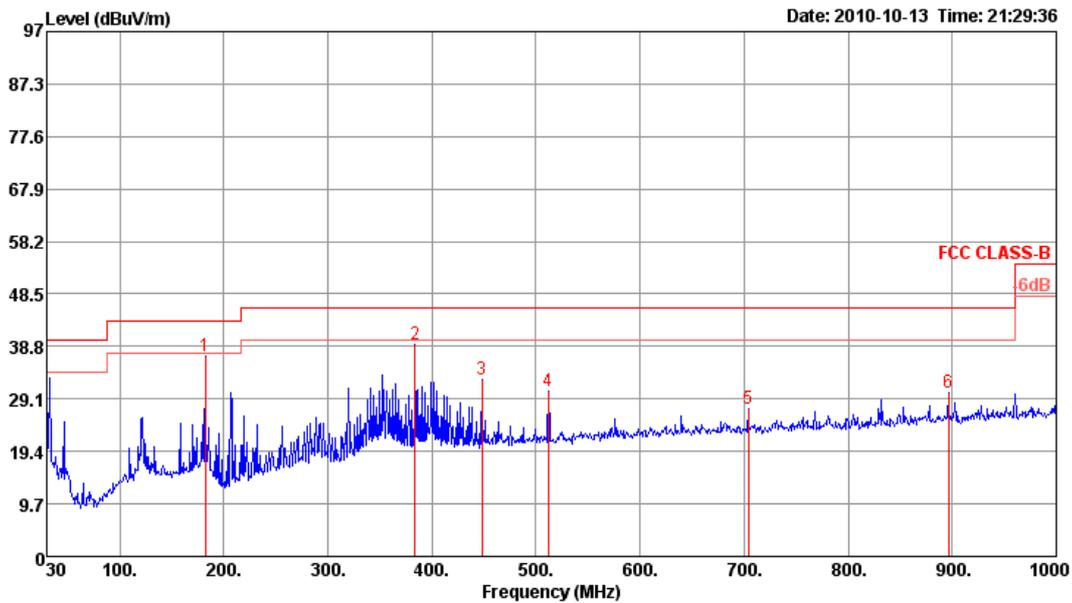

	Freq	Level	Limit Line	Over Limit	Read Level	Cable Loss	Preamp Factor	Antenna Factor	T/Pos	A/Pos	Remark	Pol/Phase
	MHz	dBuV/m	dBuV/m	dB	dBuV	dB	dB	dB/m	deg	cm		
1	182.29	37.13	43.50	-6.37	49.98	1.61	27.19	12.73	0	100	Peak	HORIZONTAL
2	384.05	39.10	46.00	-6.90	48.68	2.27	27.49	15.64	0	100	Peak	HORIZONTAL
3	448.07	32.65	46.00	-13.35	41.09	2.59	27.84	16.81	0	100	Peak	HORIZONTAL
4	512.09	30.45	46.00	-15.55	38.07	2.72	28.10	17.76	0	100	Peak	HORIZONTAL
5	704.15	27.25	46.00	-18.75	32.79	3.32	27.98	19.12	0	100	Peak	HORIZONTAL
6	896.21	30.37	46.00	-15.63	33.70	3.58	27.41	20.50	0	100	Peak	HORIZONTAL

Vertical

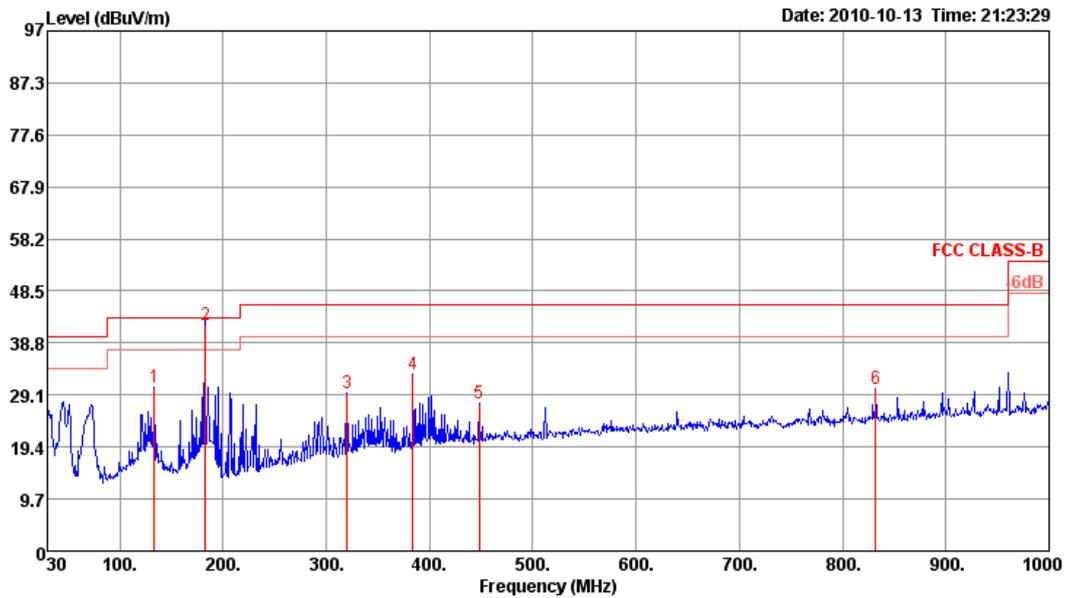

	Freq	Level	Limit Line	Over Limit	Read Level	Cable Loss	Preamp Factor	Antenna Factor	T/Pos	A/Pos	Remark	Pol/Phase
	MHz	dBuV/m	dBuV/m	dB	dBuV	dB	dB	dB/m	deg	cm		
1	133.79	30.42	43.50	-13.08	44.22	1.34	27.43	12.29	0	400	Peak	VERTICAL
2	182.85	42.06	43.50	-1.44	55.09	1.62	27.18	12.53	153	100	QP	VERTICAL
3	320.03	29.48	46.00	-16.52	40.46	2.14	27.03	13.91	0	400	Peak	VERTICAL
4	384.05	32.98	46.00	-13.02	42.56	2.27	27.49	15.64	0	400	Peak	VERTICAL
5	448.07	27.62	46.00	-18.38	36.06	2.59	27.84	16.81	0	400	Peak	VERTICAL
6	832.19	30.34	46.00	-15.66	34.51	3.36	27.54	20.01	0	400	Peak	VERTICAL

Note:

The amplitude of spurious emissions which are attenuated by more than 20 dB below the permissible value has no need to be reported.

Emission level (dBUV/m) = 20 log Emission level (uV/m).

Corrected Reading: Antenna Factor + Cable Loss + Read Level - Preamp Factor = Level.

Temperature	23°C	Humidity	55%
Test Engineer	Serway Lee	Configurations	Normal Link / Mode2

Horizontal

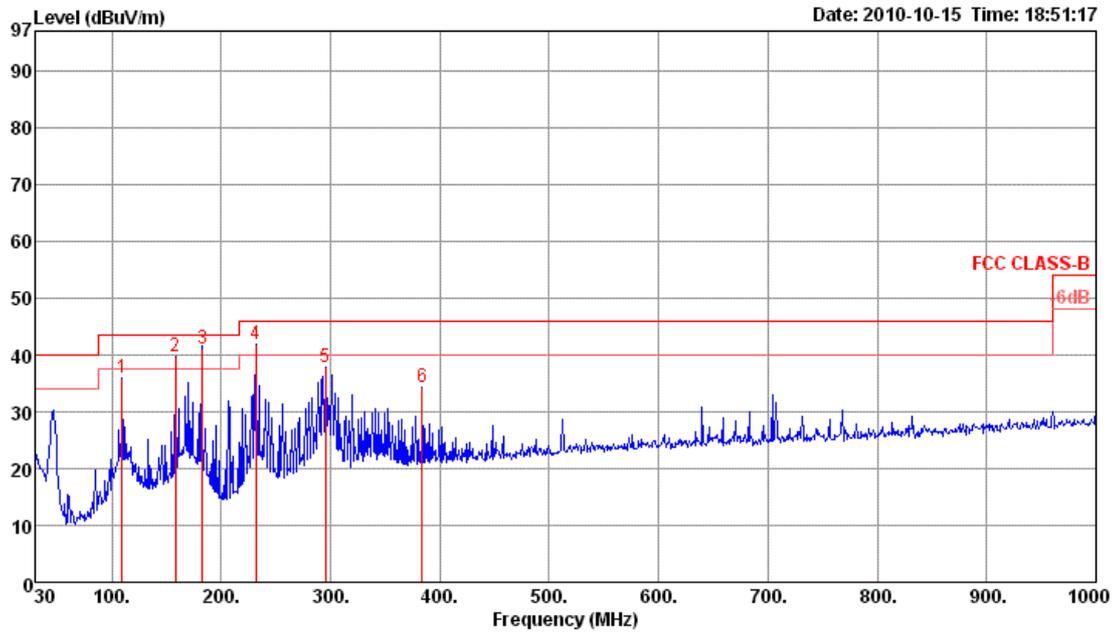

	Freq	Level	Limit Line	Over Limit	Read Level	Cable Loss	Preamp Factor	Antenna Factor	T/Pos	A/Pos	Remark	Pol/Phase
	MHz	dBuV/m	dBuV/m	dB	dBuV	dB	dB	dB/m	deg	cm		
1	109.54	35.95	43.50	-7.55	50.59	1.20	27.56	11.72	0	100	Peak	HORIZONTAL
2	158.04	39.70	43.50	-3.80	53.53	1.49	27.31	11.99	0	100	Peak	HORIZONTAL
3	182.86	40.96	43.50	-2.54	53.99	1.62	27.18	12.53	250	179	QP	HORIZONTAL
4	231.76	41.99	46.00	-4.01	55.79	1.83	27.04	11.41	0	100	Peak	HORIZONTAL
5	295.78	37.79	46.00	-8.21	49.31	2.08	26.91	13.31	0	100	Peak	HORIZONTAL
6	384.05	34.44	46.00	-11.56	44.02	2.27	27.49	15.64	0	100	Peak	HORIZONTAL

Vertical

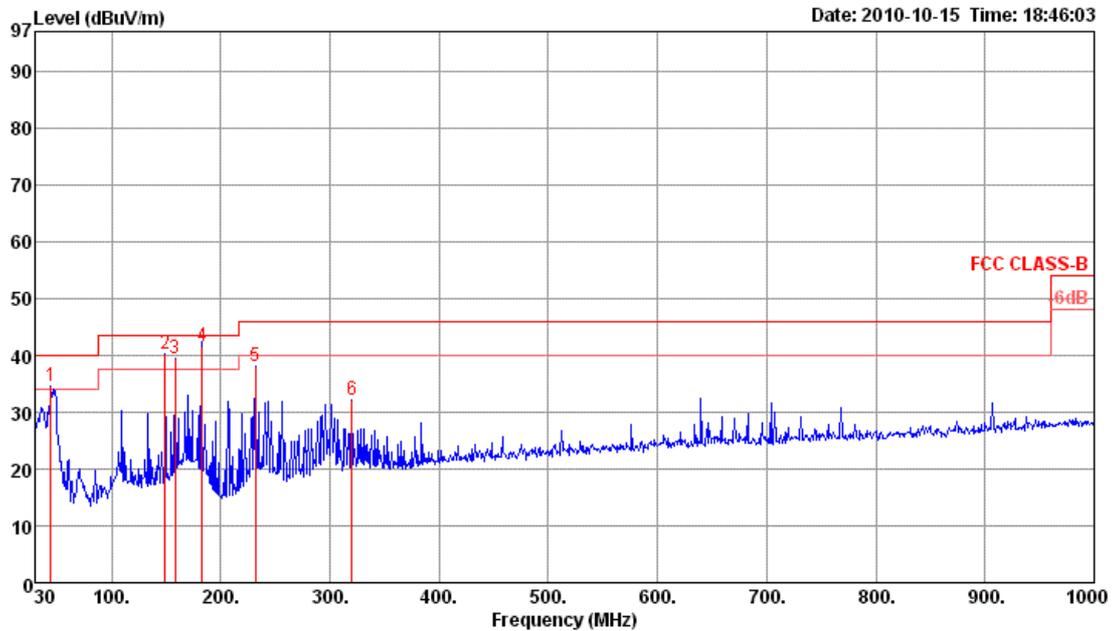

	Freq	Level	Limit	Over	Read	Cable	Preamp	Antenna	T/Pos	A/Pos	Remark	Pol/Phase
	MHz	dBuV/m	dBuV/m	dB	dBuV	dB	dB	dB/m	deg	cm		
1	44.55	34.63	40.00	-5.37	51.41	0.70	27.80	10.32	0	400	Peak	VERTICAL
2	149.31	40.19	43.50	-3.31	54.20	1.45	27.36	11.90	0	400	Peak	VERTICAL
3	158.04	39.52	43.50	-3.98	53.35	1.49	27.31	11.99	0	400	Peak	VERTICAL
4	182.86	41.66	43.50	-1.84	54.69	1.62	27.18	12.53	185	100	QP	VERTICAL
5	231.76	38.15	46.00	-7.85	51.95	1.83	27.04	11.41	0	400	Peak	VERTICAL
6	320.03	32.22	46.00	-13.78	43.20	2.14	27.03	13.91	0	400	Peak	VERTICAL

Note:

The amplitude of spurious emissions which are attenuated by more than 20 dB below the permissible value has no need to be reported.

Emission level (dBuV/m) = 20 log Emission level (uV/m).

Corrected Reading: Antenna Factor + Cable Loss + Read Level - Preamp Factor = Level.

Temperature	23°C	Humidity	55%
Test Engineer	Serway Lee	Configurations	Normal Link / Mode3

Horizontal

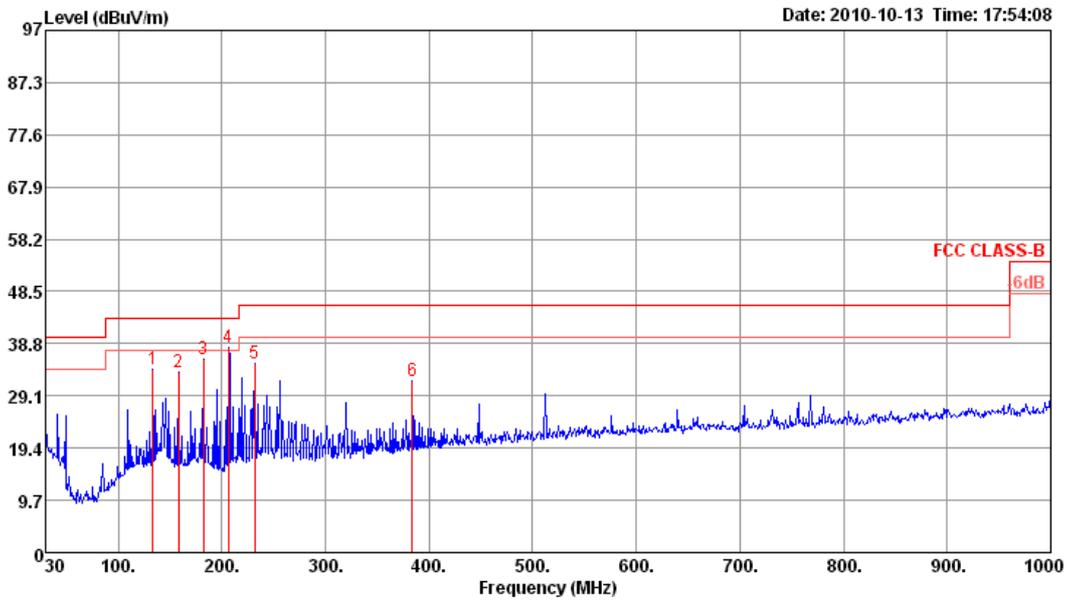

	Freq	Level	Limit Line	Over Limit	Read Level	Cable Loss	Preamp Factor	Antenna Factor	T/Pos	A/Pos	Remark	Pol/Phase
	MHz	dBuV/m	dBuV/m	dB	dBuV	dB	dB	dB/m	deg	cm		
1	133.79	33.96	43.50	-9.54	47.76	1.34	27.43	12.29	0	100	Peak	HORIZONTAL
2	158.04	33.40	43.50	-10.10	47.23	1.49	27.31	11.99	0	100	Peak	HORIZONTAL
3	182.29	35.90	43.50	-7.60	48.75	1.61	27.19	12.73	0	100	Peak	HORIZONTAL
4	206.54	38.11	43.50	-5.39	53.92	1.73	27.09	9.55	0	100	Peak	HORIZONTAL
5	231.76	35.02	46.00	-10.98	48.82	1.83	27.04	11.41	0	100	Peak	HORIZONTAL
6	384.05	31.80	46.00	-14.20	41.38	2.27	27.49	15.64	0	100	Peak	HORIZONTAL

Vertical

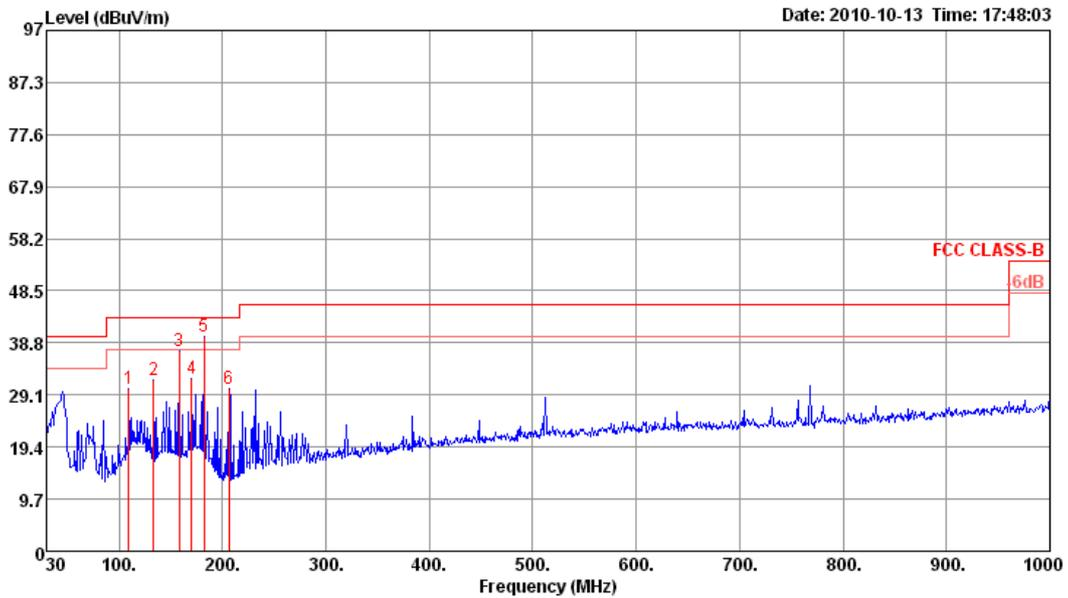

	Freq	Level	Limit Line	Over Limit	Read Level	Cable Loss	Preamp Factor	Antenna Factor	T/Pos	A/Pos	Remark	Pol/Phase
	MHz	dBuV/m	dBuV/m	dB	dBuV	dB	dB	dB/m	deg	cm		
1	109.54	30.25	43.50	-13.25	44.89	1.20	27.56	11.72	0	400	Peak	VERTICAL
2	133.79	31.78	43.50	-11.72	45.58	1.34	27.43	12.29	0	400	Peak	VERTICAL
3	158.04	37.24	43.50	-6.26	51.07	1.49	27.31	11.99	0	400	Peak	VERTICAL
4	170.65	32.22	43.50	-11.28	45.09	1.55	27.25	12.83	0	400	Peak	VERTICAL
5	182.29	40.10	43.50	-3.40	52.95	1.61	27.19	12.73	0	400	Peak	VERTICAL
6	206.54	30.26	43.50	-13.24	46.07	1.73	27.09	9.55	0	400	Peak	VERTICAL

Note:

The amplitude of spurious emissions which are attenuated by more than 20 dB below the permissible value has no need to be reported.

Emission level (dBuV/m) = 20 log Emission level (uV/m).

Corrected Reading: Antenna Factor + Cable Loss + Read Level - Preamp Factor = Level.

Temperature	23°C	Humidity	55%
Test Engineer	Serway Lee	Configurations	Normal Link / Mode4

Horizontal

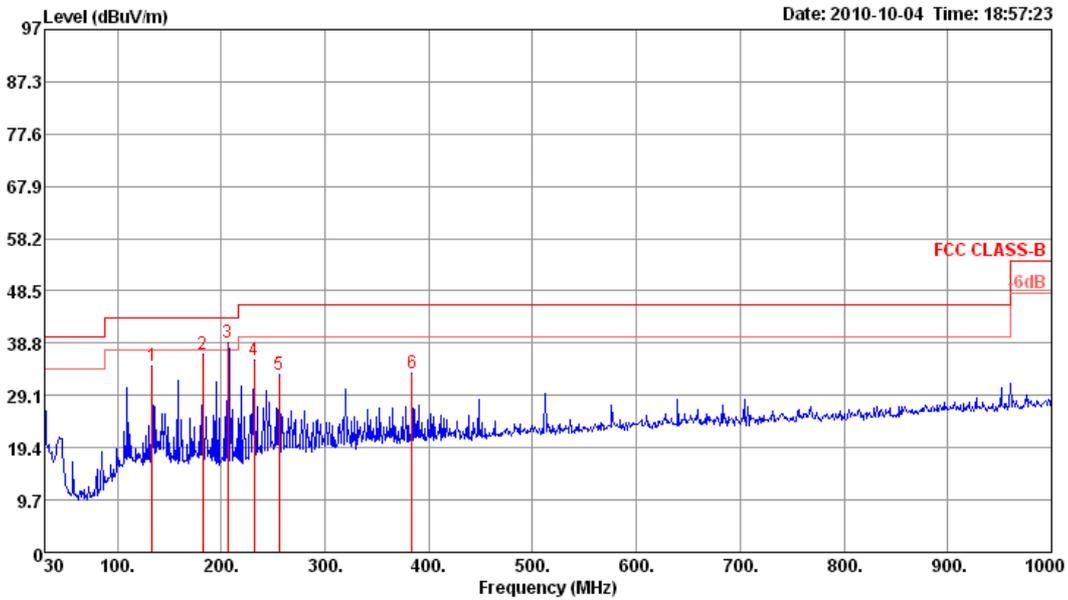

	Freq	Level	Limit Line	Over Limit	Read Level	Cable Loss	Preamp Factor	Antenna Factor	T/Pos	A/Pos	Remark	Pol/Phase
	MHz	dBuV/m	dBuV/m	dB	dBuV	dB	dB	dB/m	deg	cm		
1	133.79	34.63	43.50	-8.87	48.43	1.34	27.43	12.29	0	200	Peak	HORIZONTAL
2	182.29	36.87	43.50	-6.63	49.72	1.61	27.19	12.73	0	200	Peak	HORIZONTAL
3	206.54	39.04	43.50	-4.46	54.85	1.73	27.09	9.55	0	200	Peak	HORIZONTAL
4	231.76	35.62	46.00	-10.38	49.42	1.83	27.04	11.41	0	200	Peak	HORIZONTAL
5	256.01	33.04	46.00	-12.96	45.27	1.92	26.99	12.84	0	200	Peak	HORIZONTAL
6	384.05	33.12	46.00	-12.88	42.70	2.27	27.49	15.64	0	200	Peak	HORIZONTAL

Vertical

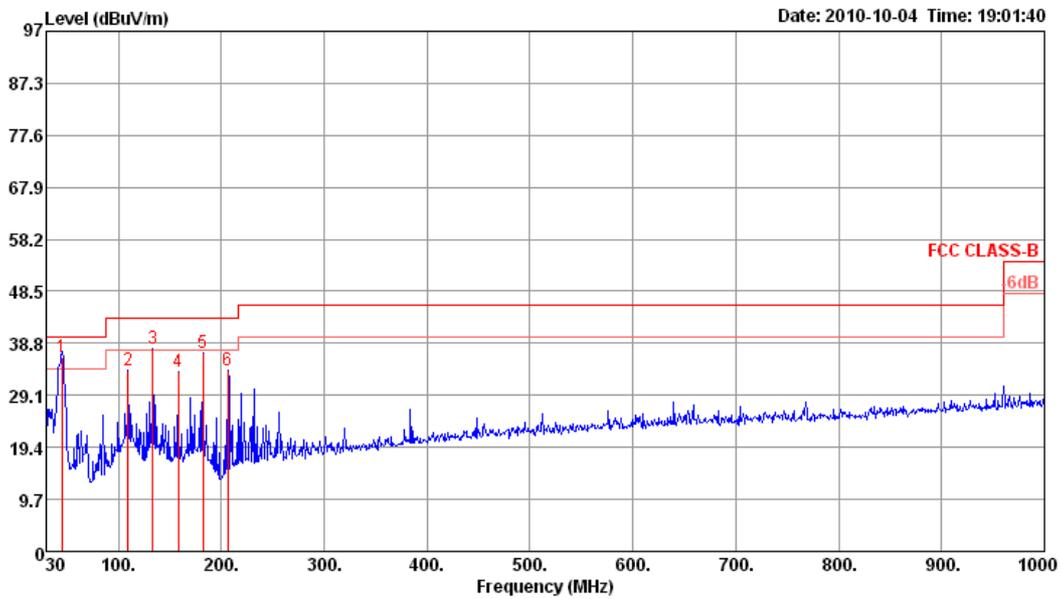

	Freq	Level	Limit	Over	Read	Cable	Preamp	Antenna	T/Pos	A/Pos	Remark	Pol/Phase
	MHz	dBuV/m	dBuV/m	dB	dBuV	dB	dB	dB/m	deg	cm		
1	45.52	36.24	40.00	-3.76	53.32	0.70	27.80	10.02	150	100	QP	VERTICAL
2	109.54	33.76	43.50	-9.74	48.40	1.20	27.56	11.72	0	200	Peak	VERTICAL
3	133.79	37.86	43.50	-5.64	51.66	1.34	27.43	12.29	0	200	Peak	VERTICAL
4	158.04	33.52	43.50	-9.98	47.35	1.49	27.31	11.99	0	200	Peak	VERTICAL
5	182.29	36.99	43.50	-6.51	49.84	1.61	27.19	12.73	0	200	Peak	VERTICAL
6	206.54	33.70	43.50	-9.80	49.51	1.73	27.09	9.55	0	200	Peak	VERTICAL

Note:

The amplitude of spurious emissions which are attenuated by more than 20 dB below the permissible value has no need to be reported.

Emission level (dBuV/m) = 20 log Emission level (uV/m).

Corrected Reading: Antenna Factor + Cable Loss + Read Level - Preamp Factor = Level.

4.5.9. Results for Radiated Emissions (1GHz~10th Harmonic)

Temperature	23°C	Humidity	55%
Test Engineer	Serway Lee	Configurations	Mode 1(Ant. 1) : 2412 MHz
Test Date	Oct. 18, 2010		

Horizontal

	Freq	Level	Limit Line	Over Limit	Read Level	Cable Loss	Preamp Factor	Antenna Factor	T/Pos	A/Pos	Remark	Pol/Phase
	MHz	dBuV/m	dBuV/m	dB	dBuV	dB	dB	dB/m	deg	cm		
1	4824.02	44.89	74.00	-29.11	44.69	3.00	35.26	32.46	6	111	Peak	HORIZONTAL
2	4824.08	32.60	54.00	-21.40	32.40	3.00	35.26	32.46	6	111	Average	HORIZONTAL

Vertical

	Freq	Level	Limit Line	Over Limit	Read Level	Cable Loss	Preamp Factor	Antenna Factor	T/Pos	A/Pos	Remark	Pol/Phase
	MHz	dBuV/m	dBuV/m	dB	dBuV	dB	dB	dB/m	deg	cm		
1	4824.05	40.05	54.00	-13.95	39.85	3.00	35.26	32.46	329	115	Average	VERTICAL
2	4824.35	52.22	74.00	-21.78	52.02	3.00	35.26	32.46	329	115	Peak	VERTICAL

Temperature	23°C	Humidity	55%
Test Engineer	Serway Lee	Configurations	Mode 1(Ant. 1) : 2438 MHz
Test Date	Oct. 18, 2010		

Horizontal

	Freq	Level	Limit Line	Over Limit	Read Level	Cable Loss	Preamp Factor	Antenna Factor	T/Pos	A/Pos	Remark	Pol/Phase
	MHz	dBuV/m	dBuV/m	dB	dBuV	dB	dB	dB/m	deg	cm		
1	4875.90	33.72	54.00	-20.28	33.30	3.01	35.15	32.56	166	131	Average	HORIZONTAL
2	4876.01	44.68	74.00	-29.32	44.26	3.01	35.15	32.56	166	131	Peak	HORIZONTAL

Vertical

	Freq	Level	Limit Line	Over Limit	Read Level	Cable Loss	Preamp Factor	Antenna Factor	T/Pos	A/Pos	Remark	Pol/Phase
	MHz	dBuV/m	dBuV/m	dB	dBuV	dB	dB	dB/m	deg	cm		
1	4875.98	37.08	54.00	-16.92	36.66	3.01	35.15	32.56	326	127	Average	VERTICAL
2	4876.03	49.60	74.00	-24.40	49.18	3.01	35.15	32.56	326	127	Peak	VERTICAL

Temperature	23°C	Humidity	55%
Test Engineer	Serway Lee	Configurations	Mode 1(Ant. 1) : 2462 MHz
Test Date	Oct. 18, 2010		

Horizontal

	Freq	Level	Limit Line	Over Limit	Read Level	Cable Loss	Preamp Factor	Antenna Factor	T/Pos	A/Pos	Remark	Pol/Phase
	MHz	dBuV/m	dBuV/m	dB	dBuV	dB	dB	dB/m	deg	cm		
1	4923.60	43.89	74.00	-30.11	43.24	3.02	35.03	32.66	166	115	Peak	HORIZONTAL
2	4923.89	33.18	54.00	-20.82	32.53	3.02	35.03	32.66	166	115	Average	HORIZONTAL

Vertical

	Freq	Level	Limit Line	Over Limit	Read Level	Cable Loss	Preamp Factor	Antenna Factor	T/Pos	A/Pos	Remark	Pol/Phase
	MHz	dBuV/m	dBuV/m	dB	dBuV	dB	dB	dB/m	deg	cm		
1	4923.97	35.99	54.00	-18.01	35.34	3.02	35.03	32.66	196	100	Average	VERTICAL
2	4924.00	48.92	74.00	-25.08	48.27	3.02	35.03	32.66	196	100	Peak	VERTICAL

4.6. Band Edge Emissions Measurement

4.6.1. Limit

20dBc in any 100 kHz bandwidth outside the operating frequency band. In case the emission fall within the restricted band specified on 15.205(a), then the 15.209(a) limit in the table below has to be followed.

Frequencies (MHz)	Field Strength (micorvolts/meter)	Measurement Distance (meters)
0.009~0.490	2400/F(KHz)	300
0.490~1.705	24000/F(KHz)	30
1.705~30.0	30	30
30~88	100	3
88~216	150	3
216~960	200	3
Above 960	500	3

4.6.2. Measuring Instruments and Setting

Please refer to section 5 of equipments list in this report. The following table is the setting of the spectrum analyzer.

Spectrum Parameter	Setting
Attenuation	Auto
Span Frequency	100 MHz
RB / VB (Emission in restricted band)	1MHz / 1MHz for Peak, 1 MHz / 10Hz for Average
RB / VB (Emission in non-restricted band)	100 KHz /100 KHz for Peak

4.6.3. Test Procedures

1. The test procedure is the same as section 4.5.3, only the frequency range investigated is limited to 100MHz around bandedges.
2. In case the emission is fail due to the used RB/VB is too wide, marker-delta method of FCC Public Notice DA00-705 will be followed.

4.6.4. Test Setup Layout

This test setup layout is the same as that shown in section 4.5.4.

4.6.5. Test Deviation

There is no deviation with the original standard.

4.6.6. EUT Operation during Test

The EUT was programmed to be in continuously transmitting mode.

4.6.7. Test Result of Band Edge and Fundamental Emissions

Temperature	23°C	Humidity	55%
Test Engineer	Serway Lee	Configurations	Mode 1(Ant. 1)
Test Date	Oct. 18, 2010		

2412MHz

	Freq	Level	Limit Line	Over Limit	Read Level	Cable Loss	Preamp Factor	Antenna Factor	T/Pos	A/Pos	Remark	Pol/Phase
	MHz	dBuV/m	dBuV/m	dB	dBuV	dB	dB	dB/m	deg	cm		
1	2390.00	52.30	54.00	-1.70	22.38	2.05	0.00	27.87	278	100	Average	VERTICAL
2	2390.00	65.42	74.00	-8.58	35.50	2.05	0.00	27.87	278	100	Peak	VERTICAL
3	2418.37	116.75	74.00			2.07	0.00	27.84	278	100	Peak	VERTICAL
4	2418.80	105.98	54.00			2.07	0.00	27.84	278	100	Average	VERTICAL

Item 3, 4 are the fundamental frequency at 2412 MHz

2438MHz

	Freq	Level	Limit Line	Over Limit	Read Level	Cable Loss	Preamp Factor	Antenna Factor	T/Pos	A/Pos	Remark	Pol/Phase
	MHz	dBuV/m	dBuV/m	dB	dBuV	dB	dB	dB/m	deg	cm		
1	2390.00	47.31	54.00	-6.69	17.39	2.05	0.00	27.87	84	100	Average	VERTICAL
2	2390.00	59.69	74.00	-14.31	29.77	2.05	0.00	27.87	84	100	Peak	VERTICAL
3	2441.62	113.02	74.00			2.08	0.00	27.78	84	100	Peak	VERTICAL
4	2444.95	102.56	54.00			2.08	0.00	27.78	84	100	Average	VERTICAL
5	2483.50	48.81	54.00	-5.19	18.98	2.10	0.00	27.73	84	100	Average	VERTICAL
6	2483.50	61.84	74.00	-12.16	32.01	2.10	0.00	27.73	84	100	Peak	VERTICAL

Item 3, 4 are the fundamental frequency at 2438MHz.

2462MHz

	Freq	Level	Limit Line	Over Limit	Read Level	Cable Loss	Preamp Factor	Antenna Factor	T/Pos	A/Pos	Remark	Pol/Phase
	MHz	dBuV/m	dBuV/m	dB	dBuV	dB	dB	dB/m	deg	cm		
1	2455.20	102.26	54.00			2.08	0.00	27.76	84	100	Average	VERTICAL
2	2460.26	113.06	74.00			2.08	0.00	27.76	84	100	Peak	VERTICAL
3	2483.50	50.71	54.00	-3.29	20.88	2.10	0.00	27.73	84	100	Average	VERTICAL
4	2483.50	64.09	74.00	-9.91	34.26	2.10	0.00	27.73	84	100	Peak	VERTICAL

Item 1, 2 are the fundamental frequency at 2462 MHz.

For Emission not in Restricted Band
Low Band Edge Plot on 2412 MHz / Ant. 1

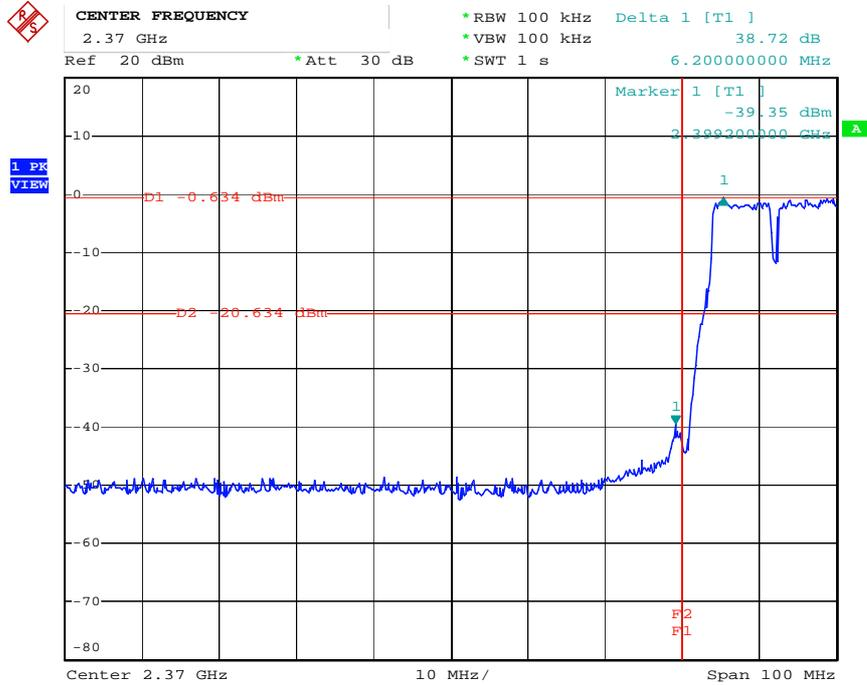

Date: 19.OCT.2010 17:26:55

High Band Edge Plot on 2462 MHz/ Ant.

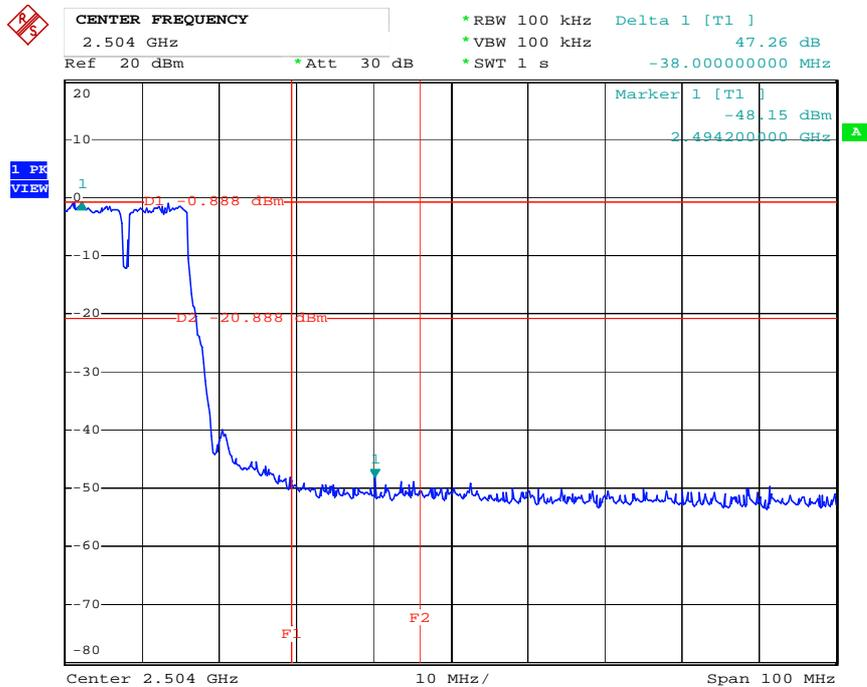

Date: 19.OCT.2010 17:22:10

4.7. Antenna Requirements

4.7.1. Limit

Except for special regulations, the Low-power Radio-frequency Devices must not be equipped with any jacket for installing an antenna with extension cable. An intentional radiator shall be designed to ensure that no antenna other than that furnished by the responsible party shall be used with the device. The use of a permanently attached antenna or of an antenna that uses a unique coupling to the intentional radiator shall be considered sufficient to comply with the provisions of this Section. The manufacturer may design the unit so that the user can replace a broken antenna, but the use of a standard antenna jack or electrical connector is prohibited. Further, this requirement does not apply to intentional radiators that must be professionally installed.

4.7.2. Antenna Connector Construction

Please refer to section 3.3 in this test report; antenna connector complied with the requirements.

5. LIST OF MEASURING EQUIPMENTS

Instrument	Manufacturer	Model No.	Serial No.	Characteristics	Calibration Date	Remark
EMC Receiver	R&S	ESCS 30	100174	9kHz – 2.75GHz	Apr. 06, 2010	Conduction (CO04-HY)
LISN	MessTec	NNB-2/16Z	99041	9kHz – 30MHz	Mar. 23, 2010	Conduction (CO04-HY)
LISN (Support Unit)	EMCO	3810/2NM	9703-1839	9kHz – 30MHz	Apr. 29, 2010	Conduction (CO04-HY)
RF Cable-CON	UTIFLEX	3102-26886-4	CB049	9kHz – 30MHz	Apr. 20, 2010	Conduction (CO04-HY)
EMI Filter	LINDGREN	LRE-2030	2651	< 450 Hz	N/A	Conduction (CO04-HY)
3m Semi Anechoic Chamber	SIDT FRANKONIA	SAC-3M	03CH03-HY	30 MHz - 1 GHz 3m	Jun. 18, 2010	Radiation (03CH03-HY)
Amplifier	SCHAFFNER	COA9231A	18667	9 kHz - 2 GHz	Jan. 24, 2010	Radiation (03CH03-HY)
Amplifier	Agilent	8449B	3008A02120	1 GHz - 26.5 GHz	Aug. 02, 2010	Radiation (03CH03-HY)
Spectrum Analyzer	R&S	FSP40	100004	9 kHz - 40 GHz	Oct. 03, 2010	Radiation (03CH03-HY)
Bilog Antenna	SCHAFFNER	CBL 6112D	22237	30 MHz – 1 GHz	Oct. 16, 2010	Radiation (03CH03-HY)
Horn Antenna	EMCO	3115	6741	1GHz ~ 18GHz	May 20, 2010	Radiation (03CH03-HY)
Horn Antenna	SCHWARZBECK	BBHA9170	BBHA9170154	15 GHz - 40 GHz	Jan.11, 2010	Radiation (03CH03-HY)
RF Cable-R03m	Jye Bao	RG142	CB021	30 MHz - 1 GHz	Jan. 05, 2010	Radiation (03CH03-HY)
RF Cable-HIGH	SUHNER	SUCOFLEX 106	03CH03-HY	1 GHz - 40 GHz	Jan. 05, 2010	Radiation (03CH03-HY)
Turn Table	HD	DS 420	420/650/00	0 – 360 degree	N/A	Radiation (03CH03-HY)
Antenna Mast	HD	MA 240	240/560/00	1 m - 4 m	N/A	Radiation (03CH03-HY)
Loop Antenna	R&S	HFH2-Z2	860004/001	9 kHz - 30 MHz	Jul. 29, 2010*	Radiation (03CH03-HY)
Spectrum Analyzer	R&S	FSU26.5	100015	20Hz ~ 26.5GHz	Oct. 29, 2009	Conducted (TH01-HY)
AC Power Source	HPC	HPA-500W	HPA-9100024	AC 0 ~ 300V	Jul. 26, 2010*	Conducted (TH01-HY)
DC Power Source	G.W.	GPC-6030D	C671845	DC 1V ~ 60V	Apr. 16, 2010	Conducted (TH01-HY)
Temp. and Humidity Chamber	Giant Force	GTH-225-20-S	MAB0103-001	N/A	Aug. 05, 2010	Conducted (TH01-HY)
RF CABLE-1m	Jye Bao	RG142	CB034-1m	20MHz ~ 7GHz	Dec. 02, 2009	Conducted (TH01-HY)
RF CABLE-2m	Jye Bao	RG142	CB035-2m	20MHz ~ 1GHz	Dec. 02, 2009	Conducted (TH01-HY)
Signal Generator	R&S	SMR40	100116	10MHz ~ 40GHz	Mar. 30, 2010	Conducted (TH01-HY)
Power Sensor	Anritsu	MA2411B	0917017	300MHz~40GHz	Dec. 03, 2009	Conducted (TH01-HY)



Instrument	Manufacturer	Model No.	Serial No.	Characteristics	Calibration Date	Remark
Power Meter	Anritsu	ML2495A	0949003	300MHz~40GHz	Dec. 03, 2009	Conducted (TH01-HY)

Note: Calibration Interval of instruments listed above is one year.

Note: For "*" Calibration Interval of instruments listed above is two years.

6. TEST LOCATION

SHIJR	ADD : 6Fl., No. 106, Sec. 1, Shintai 5th Rd., Shijr City, Taipei, Taiwan 221, R.O.C. TEL : 886-2-2696-2468 FAX : 886-2-2696-2255
HWA YA	ADD : No. 52, Hwa Ya 1st Rd., Kwei-Shan Hsiang, Tao Yuan Hsien, Taiwan, R.O.C. TEL : 886-3-327-3456 FAX : 886-3-318-0055
LINKOU	ADD : No. 30-2, Dingfu Tsuen, Linkou Shiang, Taipei, Taiwan 244, R.O.C TEL : 886-2-2601-1640 FAX : 886-2-2601-1695
DUNGHU	ADD : No. 3, Lane 238, Kangle St., Neihu Chiu, Taipei, Taiwan 114, R.O.C. TEL : 886-2-2631-4739 FAX : 886-2-2631-9740
JUNGHE	ADD : 7Fl., No. 758, Jungjeng Rd., Junghe City, Taipei, Taiwan 235, R.O.C. TEL : 886-2-8227-2020 FAX : 886-2-8227-2626
NEIHU	ADD : 4Fl., No. 339, Hsin Hu 2 nd Rd., Taipei 114, Taiwan, R.O.C. TEL : 886-2-2794-8886 FAX : 886-2-2794-9777
JHUBEI	ADD : No.8, Lane 724, Bo-ai St., Jhubei City, HsinChu County 302, Taiwan, R.O.C. TEL : 886-3-656-9065 FAX : 886-3-656-9085

7. TAF CERTIFICATE OF ACCREDITATION



Certificate No. : L1190-091230

財團法人全國認證基金會
Taiwan Accreditation Foundation

Certificate of Accreditation

This is to certify that

Sporton International Inc.
EMC & Wireless Communications Laboratory
No.52, Hwa Ya 1st Rd., Hwa Ya Technology Park, Kwei-Shan Hsiang, Tao Yuan Hsien,
Taiwan, R.O.C.

is accredited in respect of laboratory

Accreditation Criteria	: ISO/IEC 17025:2005
Accreditation Number	: 1190
Originally Accredited	: December 15, 2003
Effective Period	: January 10, 2010 to January 09, 2013
Accredited Scope	: Testing Field, see described in the Appendix
Specific Accreditation Program	: Accreditation Program for Designated Testing Laboratory for Commodities Inspection Accreditation Program for Telecommunication Equipment Testing Laboratory Accreditation Program for BSMI Mutual Recognition Arrangement with Foreign Authorities

Jay-san Chen

Jay-San Chen
President, Taiwan Accreditation Foundation
Date : December 30, 2009

Pl, total 22 pages

The Appendix forms an integral part of this Certificate, which shall be invalid when use without the Appendix