

FCC Test Report

FCC ID : NKR-SP69
Equipment : 11abgn/ac WLAN/Bluetooth Combo Module
Model No. : DHUB-SP69
Brand Name : SHARP Corporation
Applicant : Wistron NeWeb Corp.
Address : 20 Park Avenue II, Hsinchu Science Park,
Hsinchu 308, Taiwan, R.O.C.
Standard : 47 CFR FCC Part 15.247
Received Date : Oct. 13, 2014
Tested Date : Oct. 29 ~ Nov. 12 , 2014

We, International Certification Corp., would like to declare that the tested sample has been evaluated and in compliance with the requirement of the above standards. The test results contained in this report refer exclusively to the product. It may be duplicated completely for legal use with the approval of the applicant. It shall not be reproduced except in full without the written approval of our laboratory.

Approved & Reviewed by:



Gary Chang / Manager



Table of Contents

| | | |
|----------|--|-----------|
| 1 | GENERAL DESCRIPTION | 5 |
| 1.1 | Information..... | 5 |
| 1.2 | Local Support Equipment List | 7 |
| 1.3 | Test Setup Chart | 7 |
| 1.4 | The Equipment List | 8 |
| 1.5 | Test Standards | 9 |
| 1.6 | Measurement Uncertainty | 9 |
| 2 | TEST CONFIGURATION | 10 |
| 2.1 | Testing Condition | 10 |
| 2.2 | The Worst Test Modes and Channel Details | 10 |
| 3 | TRANSMITTER TEST RESULTS..... | 11 |
| 3.1 | Conducted Emissions..... | 11 |
| 3.2 | Unwanted Emissions into Restricted Frequency Bands | 14 |
| 3.3 | Unwanted Emissions into Non-Restricted Frequency Bands | 32 |
| 3.4 | Conducted Output Power | 37 |
| 3.5 | Number of Hopping Frequency | 39 |
| 3.6 | 20dB and Occupied Bandwidth | 41 |
| 3.7 | Channel Separation..... | 43 |
| 3.8 | Number of Dwell Time..... | 45 |
| 4 | TEST LABORATORY INFORMATION | 48 |

Release Record

| Report No. | Version | Description | Issued Date |
|------------|---------|---------------|---------------|
| FR4O1301AD | Rev. 01 | Initial issue | Dec. 04, 2014 |

Summary of Test Results

| FCC Rules | Test Items | Measured | Result |
|---------------------|----------------------------|---|--------|
| 15.207 | Conducted Emissions | [dBuV]: 0.491MHz 33.33 (Margin -12.81dB) - AV | Pass |
| 15.247(d) 15.209 | Radiated Emissions | [dBuV/m at 3m]:719.67MHz 44.74 (Margin -1.26dB) - QP | Pass |
| 15.247(d) | Band Edge | Meet the requirement of limit | Pass |
| 15.247(b)(1) | Conducted Output Power | Power [dBm]: 11.85 | Pass |
| 15.247(a)(1)(iii) | Number of Hopping Channels | Meet the requirement of limit | Pass |
| 15.247(a)(1) | Hopping Channel Separation | Meet the requirement of limit | Pass |
| 15.247(a)(1)(iii) | Dwell Time | Meet the requirement of limit | Pass |
| 15.203 | Antenna Requirement | Meet the requirement of limit | Pass |

1 General Description

1.1 Information

1.1.1 Specification of the Equipment under Test (EUT)

| RF General Information | | | | |
|------------------------|----------------|---------------------|----------------|-----------|
| Frequency Range (MHz) | Bluetooth Mode | Ch. Frequency (MHz) | Channel Number | Data Rate |
| 2400-2483.5 | BR V4.0 | 2402-2480 | 0-78 [79] | 1 Mbps |
| 2400-2483.5 | EDR V4.0 | 2402-2480 | 0-78 [79] | 2 Mbps |
| 2400-2483.5 | EDR V4.0 | 2402-2480 | 0-78 [79] | 3 Mbps |

Note 1: RF output power specifies that Maximum Peak Conducted Output Power.
 Note 2: Bluetooth BR uses a GFSK.
 Note 3: Bluetooth EDR uses a combination of $\pi/4$ -DQPSK and 8DPSK.

1.1.2 Antenna Details

| Ant. No. | Type | Gain (dBi) | Connector | Remark |
|----------|------|------------|-----------|--------|
| 1 | PIFA | 4.2 | U.FL | --- |

1.1.3 Power Supply Type of Equipment under Test (EUT)

| | |
|--------------------------|----------------|
| Power Supply Type | 5Vdc from host |
|--------------------------|----------------|

1.1.4 Accessories

NA

1.1.5 Channel List

| Frequency band (MHz) | | | | 2400~2483.5 | | | |
|----------------------|-----------------|---------|-----------------|-------------|-----------------|---------|-----------------|
| Channel | Frequency (MHz) | Channel | Frequency (MHz) | Channel | Frequency (MHz) | Channel | Frequency (MHz) |
| 0 | 2402 | 20 | 2422 | 40 | 2442 | 60 | 2462 |
| 1 | 2403 | 21 | 2423 | 41 | 2443 | 61 | 2463 |
| 2 | 2404 | 22 | 2424 | 42 | 2444 | 62 | 2464 |
| 3 | 2405 | 23 | 2425 | 43 | 2445 | 63 | 2465 |
| 4 | 2406 | 24 | 2426 | 44 | 2446 | 64 | 2466 |
| 5 | 2407 | 25 | 2427 | 45 | 2447 | 65 | 2467 |
| 6 | 2408 | 26 | 2428 | 46 | 2448 | 66 | 2468 |
| 7 | 2409 | 27 | 2429 | 47 | 2449 | 67 | 2469 |
| 8 | 2410 | 28 | 2430 | 48 | 2450 | 68 | 2470 |
| 9 | 2411 | 29 | 2431 | 49 | 2451 | 69 | 2471 |
| 10 | 2412 | 30 | 2432 | 50 | 2452 | 70 | 2472 |
| 11 | 2413 | 31 | 2433 | 51 | 2453 | 71 | 2473 |
| 12 | 2414 | 32 | 2434 | 52 | 2454 | 72 | 2474 |
| 13 | 2415 | 33 | 2435 | 53 | 2455 | 73 | 2475 |
| 14 | 2416 | 34 | 2436 | 54 | 2456 | 74 | 2476 |
| 15 | 2417 | 35 | 2437 | 55 | 2457 | 75 | 2477 |
| 16 | 2418 | 36 | 2438 | 56 | 2458 | 76 | 2478 |
| 17 | 2419 | 37 | 2439 | 57 | 2459 | 77 | 2479 |
| 18 | 2420 | 38 | 2440 | 58 | 2460 | 78 | 2480 |
| 19 | 2421 | 39 | 2441 | 59 | 2461 | --- | --- |

1.1.6 Test Tool and Duty Cycle

| | |
|------------------|-----------------------------|
| Test Tool | Blue Tool, Version: 1.8.8.6 |
|------------------|-----------------------------|

1.1.7 Power Setting

| Modulation Mode | Test Frequency (MHz) | | |
|-----------------|----------------------|--------|--------|
| | 2402 | 2441 | 2480 |
| GFSK/1Mbps | index0 | index0 | index0 |
| π/4 QPSK/2Mbps | index0 | index0 | index0 |
| 8DPSK/3Mbps | index0 | index0 | index0 |

1.2 Local Support Equipment List

| Support Equipment List | | | | | |
|------------------------|-----------|-------|-------|--------|---|
| No. | Equipment | Brand | Model | FCC ID | Signal cable / Length (m) |
| 1 | Notebook | DELL | E6430 | DoC | Fixture cable 0.12m non-shielded cable w/o core |

1.3 Test Setup Chart

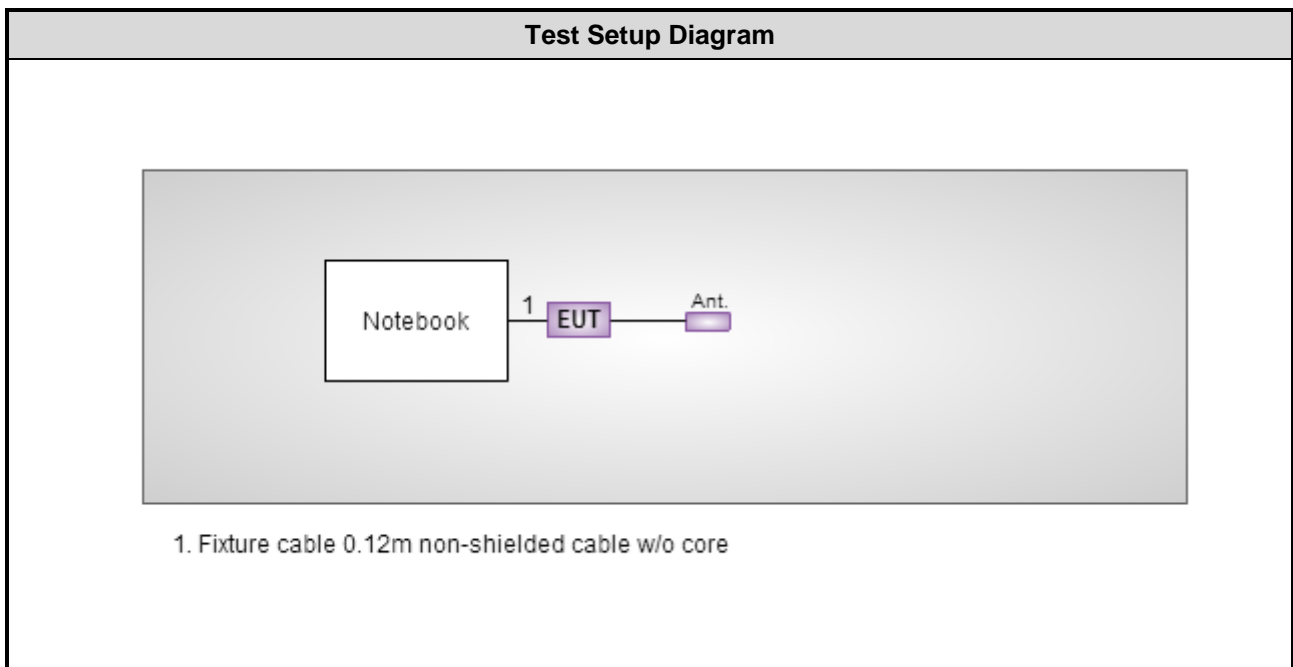

1.4 The Equipment List

| Test Item | Conducted Emission | | | | |
|--------------------------------|-------------------------------|------------------|---------------|------------------|-------------------|
| Test Site | Conduction room 1 / (CO01-WS) | | | | |
| Instrument | Manufacturer | Model No. | Serial No. | Calibration Date | Calibration Until |
| EMC Receiver | R&S | ESCS 30 | 100174 | Apr. 14, 2014 | Apr. 13, 2015 |
| LISN | SCHWARZBECK | Schwarzbeck 8127 | 8127-667 | Nov. 23, 2013 | Nov. 22, 2014 |
| LISN (Support Unit) | SCHWARZBECK | Schwarzbeck 8127 | 8127-666 | Dec. 04, 2013 | Dec. 03, 2014 |
| RF Cable-CON | Woken | CFD200-NL | CFD200-NL-001 | Apr. 23, 2014 | Apr. 22, 2015 |
| 50 ohm terminal (Support Unit) | NA | 50 | 04 | Apr. 18, 2014 | Apr. 17, 2015 |
| Measurement Software | AUDIX | e3 | 6.120210k | NA | NA |

Note: Calibration Interval of instruments listed above is one year.

| Test Item | Radiated Emission | | | | |
|----------------------|-----------------------------|-------------------|---------------------|------------------|-------------------|
| Test Site | 966 chamber 3 / (03CH03-WS) | | | | |
| Instrument | Manufacturer | Model No. | Serial No. | Calibration Date | Calibration Until |
| Spectrum Analyzer | Agilent | N9010A | MY53400091 | Sep. 16, 2014 | Sep. 15, 2015 |
| Receiver | R&S | ESR3 | 101657 | Jan. 18, 2014 | Jan. 17, 2015 |
| Bilog Antenna | SCHWARZBECK | VULB9168 | VULB9168-562 | Feb. 07, 2014 | Feb. 06, 2015 |
| Horn Antenna 1G-18G | SCHWARZBECK | BBHA 9120 D | BBHA 9120 D 1206 | Feb. 20, 2014 | Feb. 19, 2015 |
| Horn Antenna 18G-40G | SCHWARZBECK | BBHA 9170 | BBHA9170154 | Jan. 10, 2014 | Jan. 09, 2015 |
| Preamplifier | EMC | EMC02325 | 980187 | Nov. 22, 2013 | Nov. 21, 2014 |
| Preamplifier | Agilent | 83017A | MY53270014 | Sep. 17, 2014 | Sep. 16, 2015 |
| Preamplifier | EMC | EMC184045B | 980192 | Aug. 26, 2014 | Aug. 25, 2015 |
| RF cable-3M | HUBER+SUHNER | SUCOFLEX104 | MY22620/4 | Feb. 19, 2014 | Feb. 18, 2015 |
| RF cable-8M | HUBER+SUHNER | SUCOFLEX104 | MY22601/4 | Feb. 19, 2014 | Feb. 18, 2015 |
| RF cable-1M | HUBER+SUHNER | SUCOFLEX104 | MY22624/4 | Feb. 19, 2014 | Feb. 18, 2015 |
| LF cable-0.8M | EMC | EMC8D-NM-NM-800 | EMC8D-NM-NM-800-001 | Feb. 17, 2014 | Feb. 16, 2015 |
| LF cable-3M | EMC | EMC8D-NM-NM-3000 | 131103 | Feb. 17, 2014 | Feb. 16, 2015 |
| LF cable-13M | EMC | EMC8D-NM-NM-13000 | 131104 | Feb. 17, 2014 | Feb. 16, 2015 |
| Measurement Software | AUDIX | e3 | 6.120210g | NA | NA |

Note: Calibration Interval of instruments listed above is one year.

| | | | | | |
|--------------|-----|---------|--------|---------------|---------------|
| Loop Antenna | R&S | HFH2-Z2 | 100330 | Nov. 15, 2012 | Nov. 14, 2014 |
|--------------|-----|---------|--------|---------------|---------------|

Note: Calibration Interval of instruments listed above is two year.

| | | | | | |
|---|---------------------|------------------|-------------------|-------------------------|--------------------------|
| Test Item | RF Conducted | | | | |
| Test Site | (TH01-WS) | | | | |
| Instrument | Manufacturer | Model No. | Serial No. | Calibration Date | Calibration Until |
| Spectrum Analyzer | R&S | FSV40 | 101063 | Feb. 17, 2014 | Feb. 16, 2015 |
| Spectrum Analyzer | Agilent | N9010A | MY53400091 | Sep. 16, 2014 | Sep. 15, 2015 |
| TEMP&HUMIDITY CHAMBER | GIANT FORCE | GCT-225-40-SP-SD | MAF1212-002 | Dec. 11, 2013 | Dec. 10, 2014 |
| Power Meter | Anritsu | ML2495A | 1241002 | Sep. 29, 2014 | Sep. 28, 2015 |
| Power Sensor | Anritsu | MA2411B | 1207366 | Sep. 29, 2014 | Sep. 28, 2015 |
| Signal Generator | R&S | SMB100A | 175727 | Jan. 07, 2014 | Jan. 06, 2015 |
| Radio Communication Analyzer | Anritsu | MT8820C | 6201240341 | Mar. 18, 2014 | Mar. 17, 2015 |
| MXG-B RF Vector Signal Generator | Agilent | N5182B | MY53050081 | Apr. 08, 2014 | Apr. 07, 2015 |
| Measurement Software | Sporton | Sporton_1 | 1.3.30 | NA | NA |
| Note: Calibration Interval of instruments listed above is one year. | | | | | |

1.5 Test Standards

According to the specification of EUT, the EUT must comply with following standards and KDB documents.

47 CFR FCC Part 15.247

FCC Public notice DA 00-705

ANSI C63.10-2009

1.6 Measurement Uncertainty

ISO/IEC 17025 requires that an estimate of the measurement uncertainties associated with the emissions test results be included in the report. The measurement uncertainties given below are based on a 95% confidence level (based on a coverage factor (k=2))

| Measurement Uncertainty | |
|--------------------------|-------------|
| Parameters | Uncertainty |
| Bandwidth | ±34.134 Hz |
| Conducted power | ±0.808 dB |
| Frequency error | ±34.134 Hz |
| Temperature | ±0.6 °C |
| Conducted emission | ±2.670 dB |
| AC conducted emission | ±2.92 dB |
| Radiated emission ≤ 1GHz | ±3.26 dB |
| Radiated emission > 1GHz | ±4.94 dB |

2 Test Configuration

2.1 Testing Condition

| Test Item | Test Site | Ambient Condition | Tested By |
|--------------------|-----------|-------------------|------------|
| AC Conduction | CO01-WS | 22°C / 69% | Peter Lin |
| Radiated Emissions | 03CH03-WS | 21-22°C / 61-63% | Aska Huang |
| RF Conducted | TH01-WS | 23°C / 62% | Brad Wu |

➤ FCC site registration No.: 390588

➤ IC site registration No.: 10807C-1

2.2 The Worst Test Modes and Channel Details

| Test item | Mode | Test Frequency (MHz) | Data Rate (Mbps) | Test Configuration |
|----------------------------|----------------------------|--|-------------------------|--------------------|
| Conducted Emissions | GFSK | 2441 | 1Mbps | 1 |
| Radiated Emissions ≤ 1GHz | GFSK | 2441 | 1Mbps | 1,2 |
| Radiated Emissions > 1GHz | GFSK 8DPSK | 2402, 2441, 2480 2402, 2441, 2480 | 1Mbps 3Mbps | 1 |
| Conducted Output Power | GFSK π/4 QDPSK 8DPSK | 2402, 2441, 2480 2402, 2441, 2480 2402, 2441, 2480 | 1Mbps 2Mbps 3Mbps | 1 |
| Number of Hopping Channels | GFSK 8DPSK | 2402~2480 2402~2480 | 1Mbps 3Mbps | 1 |
| Hopping Channel Separation | GFSK 8DPSK | 2402, 2441, 2480 2402, 2441, 2480 | 1Mbps 3Mbps | 1 |
| Dwell Time | GFSK 8DPSK | 2480 2480 | 1Mbps 3Mbps | 1 |

NOTE:

- The EUT and its antenna were pretested with 3 orientations placed on the table for the radiated emission measurement – X, Y, and Z-plane. The **Y-plane** results were found as the worst case for EUT, and the **X-plane** results were found as the worst case for antenna and shown in this report.
- 4 different length of BT antenna cable were provided for this device: 400mm / 500mm / 550mm / 600mm. 400mm and 600mm were selected for final testing as below test configurations.
 - Configuration 1: 400mm
 - Configuration 2: 600mm

3 Transmitter Test Results

3.1 Conducted Emissions

3.1.1 Limit of Conducted Emissions

| Conducted Emissions Limit | | |
|---------------------------|------------|-----------|
| Frequency Emission (MHz) | Quasi-Peak | Average |
| 0.15-0.5 | 66 - 56 * | 56 - 46 * |
| 0.5-5 | 56 | 46 |
| 5-30 | 60 | 50 |

Note 1: * Decreases with the logarithm of the frequency.

3.1.2 Test Procedures

1. The device is placed on a test table, raised 80 cm above the reference ground plane. The vertical conducting plane is located 40 cm to the rear of the device.
2. The device is connected to line impedance stabilization network (LISN) and other accessories are connected to other LISN. Measured levels of AC power line conducted emission are across the 50 Ω LISN port.
3. AC conducted emission measurements is made over frequency range from 150 kHz to 30 MHz.
4. This measurement was performed with AC 120V/60Hz

3.1.3 Test Setup

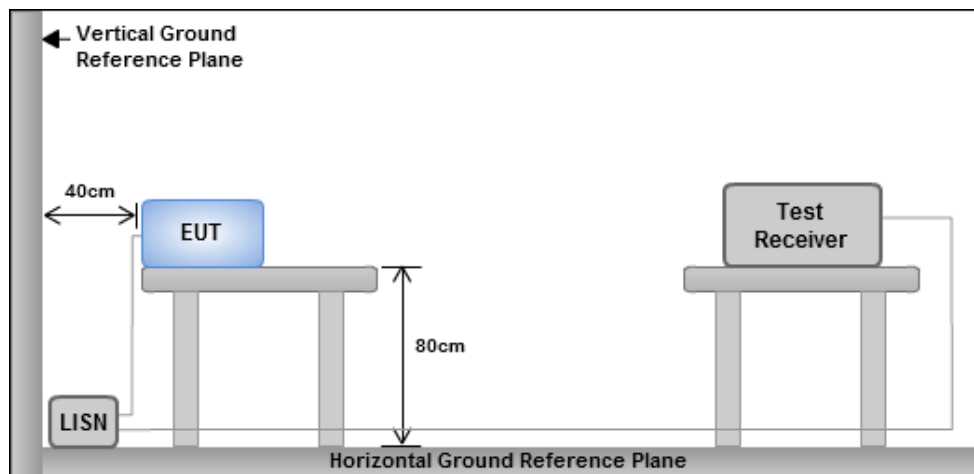

- Note: 1. Support units were connected to second LISN.
 2. Both of LISNs (AMN) are 80 cm from EUT and at least 80 cm from other units and other metal planes

3.1.4 Test Result of Conducted Emissions

| | | | |
|------------------------|------|-------------------------|------|
| Modulation Mode | GFSK | Test Freq. (MHz) | 2441 |
| Power Phase | Line | | |

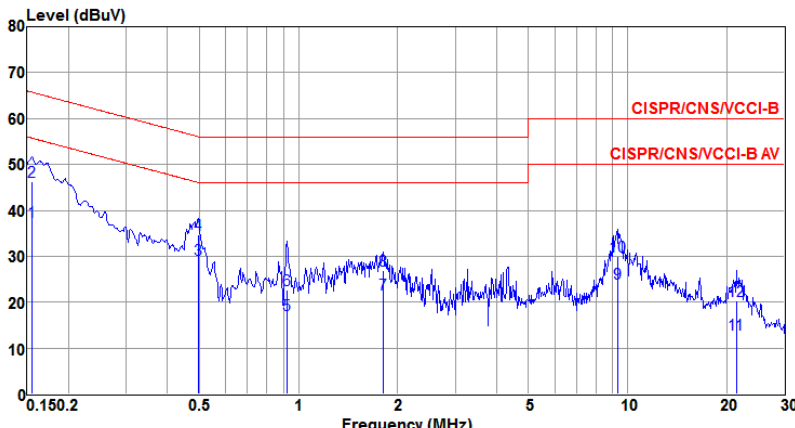

| | Freq MHz | Level dBuV | Limit Line dBuV | Over Limit dB | Read Level dBuV | LISN factor dB | cable loss dB | Remark |
|----|-------------|---------------|-----------------------|---------------------|-----------------------|----------------------|---------------------|---------|
| 1 | 0.155 | 37.55 | 55.74 | -18.19 | 37.13 | 0.40 | 0.02 | Average |
| 2 | 0.155 | 46.35 | 65.74 | -19.39 | 45.93 | 0.40 | 0.02 | QP |
| 3* | 0.497 | 29.30 | 46.05 | -16.75 | 28.89 | 0.39 | 0.02 | Average |
| 4 | 0.497 | 34.67 | 56.05 | -21.38 | 34.26 | 0.39 | 0.02 | QP |
| 5 | 0.923 | 17.29 | 46.00 | -28.71 | 16.86 | 0.41 | 0.02 | Average |
| 6 | 0.923 | 22.59 | 56.00 | -33.41 | 22.16 | 0.41 | 0.02 | QP |
| 7 | 1.810 | 21.75 | 46.00 | -24.25 | 21.30 | 0.43 | 0.02 | Average |
| 8 | 1.810 | 26.82 | 56.00 | -29.18 | 26.37 | 0.43 | 0.02 | QP |
| 9 | 9.302 | 24.07 | 50.00 | -25.93 | 23.30 | 0.53 | 0.24 | Average |
| 10 | 9.302 | 29.90 | 60.00 | -30.10 | 29.13 | 0.53 | 0.24 | QP |
| 11 | 21.373 | 12.90 | 50.00 | -37.10 | 11.94 | 0.55 | 0.41 | Average |
| 12 | 21.373 | 20.24 | 60.00 | -39.76 | 19.28 | 0.55 | 0.41 | QP |

Note 1: Level (dBuV) = Read Level (dBuV) + LISN Factor (dB) + Cable Loss (dB).
 2: Over Limit (dB) = Level (dBuV) – Limit Line (dBuV).

| | | | |
|------------------------|---------|-------------------------|------|
| Modulation Mode | GFSK | Test Freq. (MHz) | 2441 |
| Power Phase | Neutral | | |

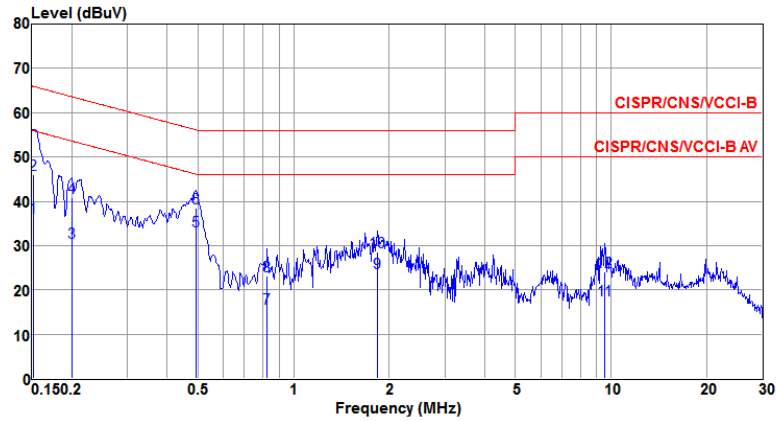

| | Freq MHz | Level dBuV | Limit Line dBuV | Over Limit dB | Read Level dBuV | LISN factor dB | cable loss dB | Remark |
|----|-------------|---------------|-----------------------|---------------------|-----------------------|----------------------|---------------------|---------|
| 1 | 0.152 | 36.45 | 55.91 | -19.46 | 35.95 | 0.48 | 0.02 | Average |
| 2 | 0.152 | 45.91 | 65.91 | -20.00 | 45.41 | 0.48 | 0.02 | QP |
| 3 | 0.200 | 30.80 | 53.62 | -22.82 | 30.31 | 0.48 | 0.01 | Average |
| 4 | 0.200 | 40.85 | 63.62 | -22.77 | 40.36 | 0.48 | 0.01 | QP |
| 5* | 0.491 | 33.33 | 46.14 | -12.81 | 32.84 | 0.47 | 0.02 | Average |
| 6 | 0.491 | 38.50 | 56.14 | -17.64 | 38.01 | 0.47 | 0.02 | QP |
| 7 | 0.826 | 15.92 | 46.00 | -30.08 | 15.42 | 0.48 | 0.02 | Average |
| 8 | 0.826 | 23.04 | 56.00 | -32.96 | 22.54 | 0.48 | 0.02 | QP |
| 9 | 1.839 | 23.76 | 46.00 | -22.24 | 23.24 | 0.50 | 0.02 | Average |
| 10 | 1.839 | 28.57 | 56.00 | -27.43 | 28.05 | 0.50 | 0.02 | QP |
| 11 | 9.552 | 17.75 | 50.00 | -32.25 | 16.95 | 0.56 | 0.24 | Average |
| 12 | 9.552 | 24.07 | 60.00 | -35.93 | 23.27 | 0.56 | 0.24 | QP |

Note 1: Level (dBuV) = Read Level (dBuV) + LISN Factor (dB) + Cable Loss (dB).
 2: Over Limit (dB) = Level (dBuV) – Limit Line (dBuV).

3.2 Unwanted Emissions into Restricted Frequency Bands

3.2.1 Limit of Unwanted Emissions into Restricted Frequency Bands

| Restricted Band Emissions Limit | | | |
|---------------------------------|-----------------------|-------------------------|----------------------|
| Frequency Range (MHz) | Field Strength (uV/m) | Field Strength (dBuV/m) | Measure Distance (m) |
| 0.009~0.490 | 2400/F(kHz) | 48.5 - 13.8 | 300 |
| 0.490~1.705 | 24000/F(kHz) | 33.8 - 23 | 30 |
| 1.705~30.0 | 30 | 29 | 30 |
| 30~88 | 100 | 40 | 3 |
| 88~216 | 150 | 43.5 | 3 |
| 216~960 | 200 | 46 | 3 |
| Above 960 | 500 | 54 | 3 |

Note 1:
Qusai-Peak value is measured for frequency below 1GHz except for 9–90 kHz, 110–490 kHz frequency band. Peak and average value are measured for frequency above 1GHz. The limit on average radio frequency emission is as above table. The limit on peak radio frequency emissions is 20 dB above the maximum permitted average emission limit

Note 2:
Measurements may be performed at a distance other than what is specified provided. When performing measurements at a distance other than that specified, the results shall be extrapolated to the specified distance using an extrapolation factor as below, Frequency at or above 30 MHz: 20 dB/decade Frequency below 30 MHz: 40 dB/decade.

3.2.2 Test Procedures

1. Measurement is made at a semi-anechoic chamber that incorporates a turntable allowing a EUT rotation of 360°. A continuously-rotating, remotely-controlled turntable is installed at the test site to support the EUT and facilitate determination of the direction of maximum radiation for each EUT emission frequency. The EUT is placed at a height of 0.8 m test table above the ground plane.
2. Measurement is made with the antenna positioned in both the horizontal and vertical planes of polarization. The measurement antenna is varied in height (1m ~ 4m) above the reference ground plane to obtain the maximum signal strength. Distance between EUT and antenna is 3 m.
3. This investigation is performed with the EUT rotated 360°, the antenna height scanned between 1 m and 4 m, and the antenna rotated to repeat the measurements for both the horizontal and vertical antenna polarizations.

Note:

1. 120kHz measurement bandwidth of test receiver and Quasi-peak detector is for radiated emission below 1GHz.
2. Radiated emission above 1GHz / Peak value
RBW=1MHz, VBW=3MHz and Peak detector
Radiated emission above 1GHz / Average value for harmonics
The average value is: Average = Peak value + 20log(Duty cycle) Where the duty factor is calculated from following formula for DH5 packet type which has worst duty factor:
3.
$$20\log(\text{Duty cycle}) = 20\log \frac{1\text{s} / 1600 * 5}{100\text{ ms}} = -30.1\text{dB}$$
4. Radiated emission above 1GHz / Average value for other emissions
RBW=1MHz, VBW=1/T and Peak detector

3.2.3 Test Setup

Radiated Emissions below 1 GHz

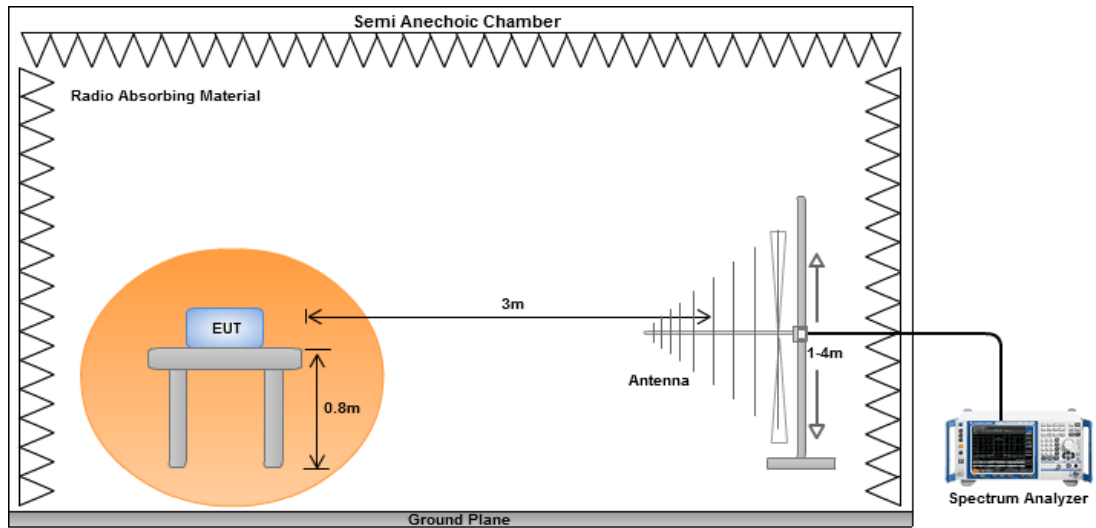

Radiated Emissions above 1 GHz

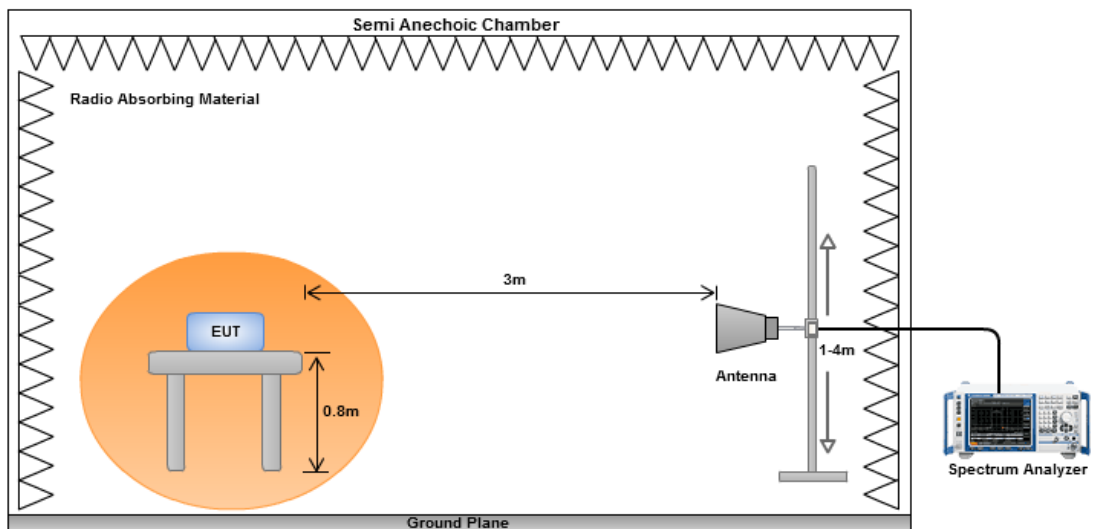

3.2.4 Transmitter Radiated Unwanted Emissions (Below 1GHz)

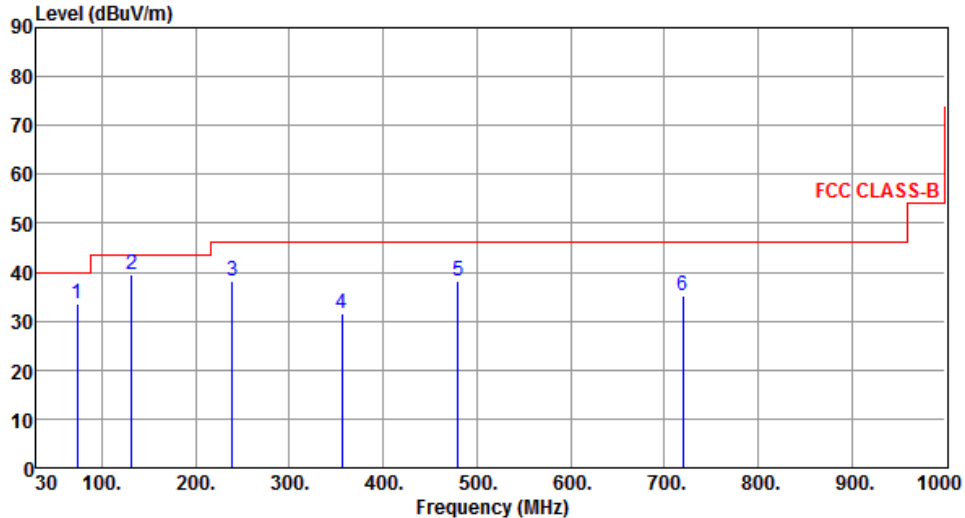
| Modulation | GFSK | Test Freq. (MHz) | 2441 | | | | | | | | | | | | | | | | | | | | | | | | | | | | | | | | | | | | | | | | | | | | | | | | | | | | | | | | | | | | | | | | | | | | | | | | |
|---|--|--------------------|----------------|------------|--------|------------|-------------|----------------|-------------|----------------|-----|--------|--------|----|------|----|--|--|--|---|-------|-------|-------|-------|-------|--------|------|-----|---|--------|-------|-------|-------|-------|--------|------|-----|---|--------|-------|-------|-------|-------|--------|------|-----|---|--------|-------|-------|--------|-------|--------|------|-----|---|--------|-------|-------|-------|-------|-------|------|-----|---|--------|-------|-------|--------|-------|-------|------|-----|--|--|
| Polarization | Horizontal | Test Configuration | 1 | | | | | | | | | | | | | | | | | | | | | | | | | | | | | | | | | | | | | | | | | | | | | | | | | | | | | | | | | | | | | | | | | | | | | | | | |
|  <p>The graph plots Level (dBuV/m) on the y-axis (0 to 90) against Frequency (MHz) on the x-axis (30 to 1000). A red stepped line represents the FCC CLASS-B limit, which is 40 dBuV/m from 30 to 100 MHz, 45 dBuV/m from 100 to 200 MHz, 48 dBuV/m from 200 to 300 MHz, 50 dBuV/m from 300 to 1000 MHz, and 55 dBuV/m from 1000 MHz to 1000 MHz. Six blue vertical lines represent emission peaks labeled 1 through 6, with their respective frequencies and levels indicated in the table below.</p> | | | | | | | | | | | | | | | | | | | | | | | | | | | | | | | | | | | | | | | | | | | | | | | | | | | | | | | | | | | | | | | | | | | | | | | | | | | |
| | <table border="1"> <thead> <tr> <th>Freq.</th> <th>Emission level</th> <th>Limit</th> <th>Margin</th> <th>SA reading</th> <th>Factor</th> <th>Remark</th> <th>ANT High cm</th> <th>Turn Table deg</th> </tr> <tr> <th>MHz</th> <th>dBuV/m</th> <th>dBuV/m</th> <th>dB</th> <th>dBuV</th> <th>dB</th> <th></th> <th></th> <th></th> </tr> </thead> <tbody> <tr> <td>1</td> <td>73.65</td> <td>33.70</td> <td>40.00</td> <td>-6.30</td> <td>49.91</td> <td>-16.21</td> <td>Peak</td> <td>---</td> </tr> <tr> <td>2</td> <td>131.85</td> <td>39.67</td> <td>43.50</td> <td>-3.83</td> <td>54.10</td> <td>-14.43</td> <td>Peak</td> <td>---</td> </tr> <tr> <td>3</td> <td>239.52</td> <td>38.07</td> <td>46.00</td> <td>-7.93</td> <td>52.80</td> <td>-14.73</td> <td>Peak</td> <td>---</td> </tr> <tr> <td>4</td> <td>355.92</td> <td>31.47</td> <td>46.00</td> <td>-14.53</td> <td>42.68</td> <td>-11.21</td> <td>Peak</td> <td>---</td> </tr> <tr> <td>5</td> <td>480.08</td> <td>38.22</td> <td>46.00</td> <td>-7.78</td> <td>46.46</td> <td>-8.24</td> <td>Peak</td> <td>---</td> </tr> <tr> <td>6</td> <td>719.67</td> <td>35.22</td> <td>46.00</td> <td>-10.78</td> <td>38.96</td> <td>-3.74</td> <td>Peak</td> <td>---</td> </tr> </tbody> </table> | Freq. | Emission level | Limit | Margin | SA reading | Factor | Remark | ANT High cm | Turn Table deg | MHz | dBuV/m | dBuV/m | dB | dBuV | dB | | | | 1 | 73.65 | 33.70 | 40.00 | -6.30 | 49.91 | -16.21 | Peak | --- | 2 | 131.85 | 39.67 | 43.50 | -3.83 | 54.10 | -14.43 | Peak | --- | 3 | 239.52 | 38.07 | 46.00 | -7.93 | 52.80 | -14.73 | Peak | --- | 4 | 355.92 | 31.47 | 46.00 | -14.53 | 42.68 | -11.21 | Peak | --- | 5 | 480.08 | 38.22 | 46.00 | -7.78 | 46.46 | -8.24 | Peak | --- | 6 | 719.67 | 35.22 | 46.00 | -10.78 | 38.96 | -3.74 | Peak | --- | | |
| Freq. | Emission level | Limit | Margin | SA reading | Factor | Remark | ANT High cm | Turn Table deg | | | | | | | | | | | | | | | | | | | | | | | | | | | | | | | | | | | | | | | | | | | | | | | | | | | | | | | | | | | | | | | | | | | |
| MHz | dBuV/m | dBuV/m | dB | dBuV | dB | | | | | | | | | | | | | | | | | | | | | | | | | | | | | | | | | | | | | | | | | | | | | | | | | | | | | | | | | | | | | | | | | | | | | | |
| 1 | 73.65 | 33.70 | 40.00 | -6.30 | 49.91 | -16.21 | Peak | --- | | | | | | | | | | | | | | | | | | | | | | | | | | | | | | | | | | | | | | | | | | | | | | | | | | | | | | | | | | | | | | | | | | | |
| 2 | 131.85 | 39.67 | 43.50 | -3.83 | 54.10 | -14.43 | Peak | --- | | | | | | | | | | | | | | | | | | | | | | | | | | | | | | | | | | | | | | | | | | | | | | | | | | | | | | | | | | | | | | | | | | | |
| 3 | 239.52 | 38.07 | 46.00 | -7.93 | 52.80 | -14.73 | Peak | --- | | | | | | | | | | | | | | | | | | | | | | | | | | | | | | | | | | | | | | | | | | | | | | | | | | | | | | | | | | | | | | | | | | | |
| 4 | 355.92 | 31.47 | 46.00 | -14.53 | 42.68 | -11.21 | Peak | --- | | | | | | | | | | | | | | | | | | | | | | | | | | | | | | | | | | | | | | | | | | | | | | | | | | | | | | | | | | | | | | | | | | | |
| 5 | 480.08 | 38.22 | 46.00 | -7.78 | 46.46 | -8.24 | Peak | --- | | | | | | | | | | | | | | | | | | | | | | | | | | | | | | | | | | | | | | | | | | | | | | | | | | | | | | | | | | | | | | | | | | | |
| 6 | 719.67 | 35.22 | 46.00 | -10.78 | 38.96 | -3.74 | Peak | --- | | | | | | | | | | | | | | | | | | | | | | | | | | | | | | | | | | | | | | | | | | | | | | | | | | | | | | | | | | | | | | | | | | | |
| <p>Note 1: Emission Level (dBuV/m) = SA Reading (dBuV/m) + Factor* (dB) *Factor includes antenna factor , cable loss and amplifier gain Note 2: Margin (dB) = Emission level (dBuV/m) – Limit (dBuV/m). Note 3: All spurious emissions below 30MHz are more than 20 dB below the limit.</p> | | | | | | | | | | | | | | | | | | | | | | | | | | | | | | | | | | | | | | | | | | | | | | | | | | | | | | | | | | | | | | | | | | | | | | | | | | | |

| | | | |
|---------------------|----------|---------------------------|------|
| Modulation | GFSK | Test Freq. (MHz) | 2441 |
| Polarization | Vertical | Test Configuration | 1 |

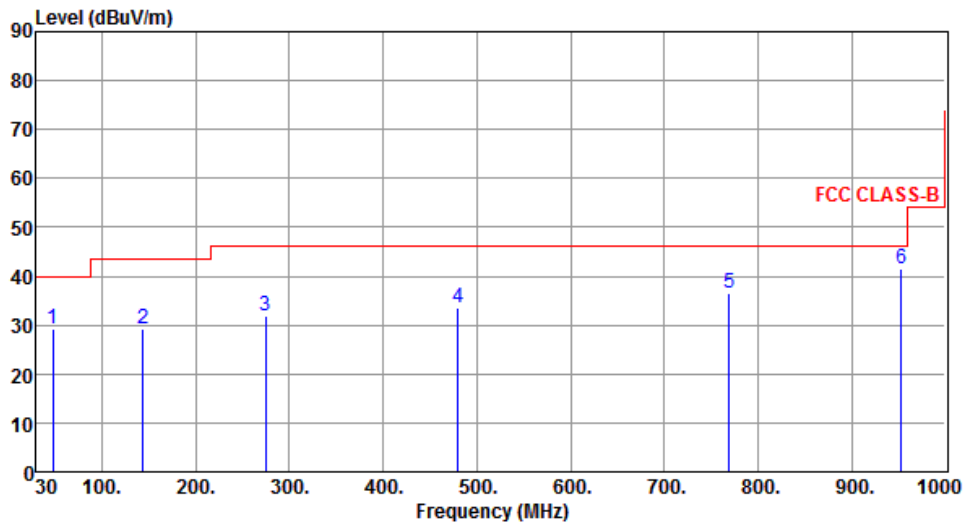

| | Freq. MHz | Emission level dBuV/m | Limit dBuV/m | Margin dB | SA reading dBuV | Factor dB | Remark | ANT High cm | Turn Table deg |
|---|--------------|-----------------------------|-----------------|--------------|-----------------------|--------------|--------|-------------------|----------------------|
| 1 | 47.46 | 29.16 | 40.00 | -10.84 | 42.24 | -13.08 | Peak | --- | --- |
| 2 | 143.49 | 29.36 | 43.50 | -14.14 | 42.86 | -13.50 | Peak | --- | --- |
| 3 | 274.44 | 31.80 | 46.00 | -14.20 | 45.18 | -13.38 | Peak | --- | --- |
| 4 | 480.08 | 33.62 | 46.00 | -12.38 | 41.86 | -8.24 | Peak | --- | --- |
| 5 | 769.14 | 36.65 | 46.00 | -9.35 | 39.52 | -2.87 | Peak | --- | --- |
| 6 | 952.47 | 41.59 | 46.00 | -4.41 | 41.34 | 0.25 | Peak | --- | --- |

Note 1: Emission Level (dBuV/m) = SA Reading (dBuV/m) + Factor* (dB)

*Factor includes antenna factor , cable loss and amplifier gain

Note 2: Margin (dB) = Emission level (dBuV/m) – Limit (dBuV/m).

Note 3: All spurious emissions below 30MHz are more than 20 dB below the limit.

| | | | |
|---------------------|------------|---------------------------|------|
| Modulation | GFSK | Test Freq. (MHz) | 2441 |
| Polarization | Horizontal | Test Configuration | 2 |

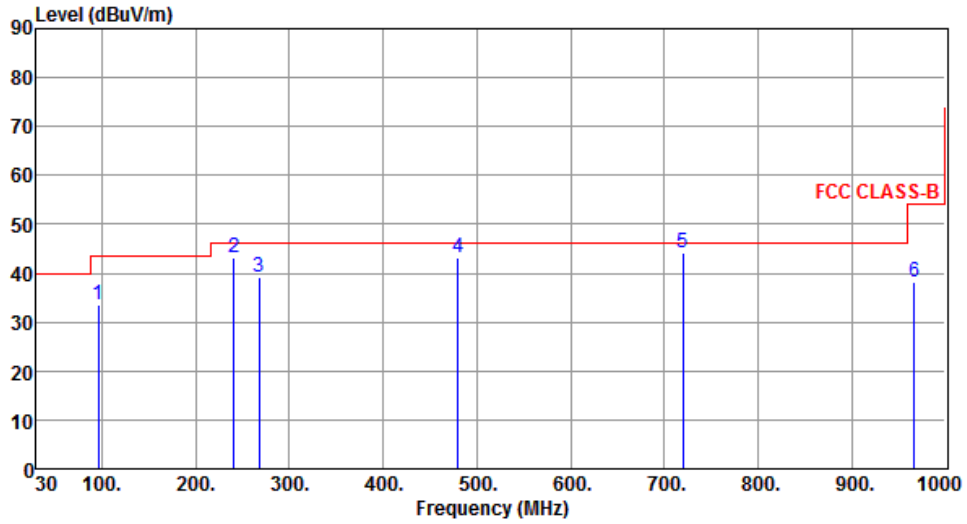

| | Freq. MHz | Emission level dBuV/m | Limit dBuV/m | Margin dB | SA reading dBuV | Factor dB | Remark | ANT High cm | Turn Table deg |
|---|--------------|-----------------------------|-----------------|--------------|-----------------------|--------------|--------|-------------------|----------------------|
| 1 | 95.96 | 33.52 | 43.50 | -9.98 | 52.07 | -18.55 | Peak | --- | --- |
| 2 | 240.49 | 43.21 | 46.00 | -2.79 | 57.90 | -14.69 | Peak | --- | --- |
| 3 | 267.65 | 39.34 | 46.00 | -6.66 | 53.05 | -13.71 | Peak | --- | --- |
| 4 | 480.08 | 43.04 | 46.00 | -2.96 | 51.28 | -8.24 | Peak | --- | --- |
| 5 | 719.67 | 44.17 | 46.00 | -1.83 | 47.91 | -3.74 | QP | --- | --- |
| 6 | 967.02 | 38.20 | 54.00 | -15.80 | 37.79 | 0.41 | Peak | --- | --- |

Note 1: Emission Level (dBuV/m) = SA Reading (dBuV/m) + Factor* (dB)

*Factor includes antenna factor , cable loss and amplifier gain

Note 2: Margin (dB) = Emission level (dBuV/m) – Limit (dBuV/m).

Note 3: All spurious emissions below 30MHz are more than 20 dB below the limit.

| | | | |
|---------------------|----------|---------------------------|------|
| Modulation | GFSK | Test Freq. (MHz) | 2441 |
| Polarization | Vertical | Test Configuration | 2 |

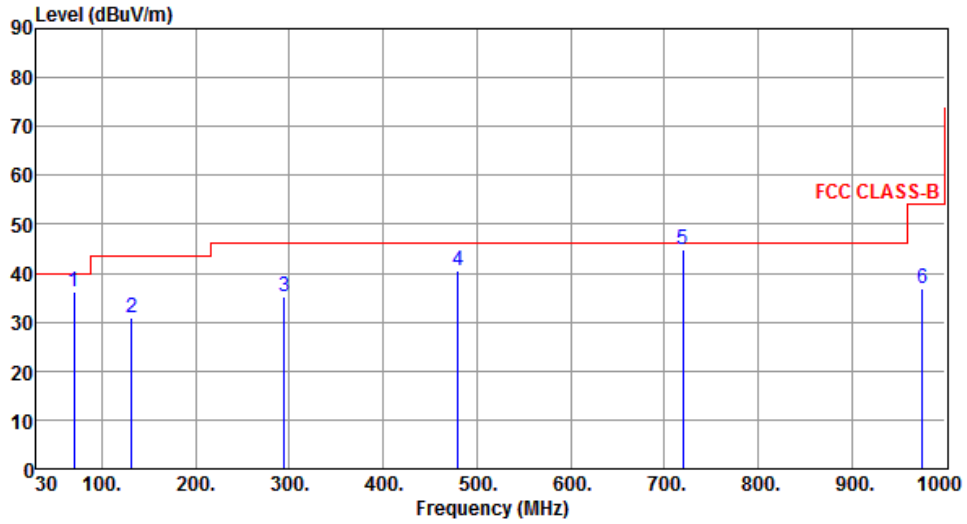

| | Freq. MHz | Emission level dBuV/m | Limit dBuV/m | Margin dB | SA reading dBuV | Factor dB | Remark | ANT High cm | Turn Table deg |
|---|--------------|-----------------------------|-----------------|--------------|-----------------------|--------------|--------|-------------------|----------------------|
| 1 | 69.77 | 36.21 | 40.00 | -3.79 | 51.54 | -15.33 | Peak | --- | --- |
| 2 | 131.85 | 30.91 | 43.50 | -12.59 | 45.34 | -14.43 | Peak | --- | --- |
| 3 | 294.81 | 35.14 | 46.00 | -10.86 | 47.87 | -12.73 | Peak | --- | --- |
| 4 | 480.08 | 40.60 | 46.00 | -5.40 | 48.84 | -8.24 | Peak | --- | --- |
| 5 | 719.67 | 44.74 | 46.00 | -1.26 | 48.48 | -3.74 | QP | --- | --- |
| 6 | 975.75 | 37.01 | 54.00 | -16.99 | 36.51 | 0.50 | Peak | --- | --- |

Note 1: Emission Level (dBuV/m) = SA Reading (dBuV/m) + Factor* (dB)

*Factor includes antenna factor , cable loss and amplifier gain

Note 2: Margin (dB) = Emission level (dBuV/m) – Limit (dBuV/m).

Note 3: All spurious emissions below 30MHz are more than 20 dB below the limit.

3.2.5 Transmitter Radiated Unwanted Emissions (Above 1GHz) for GFSK

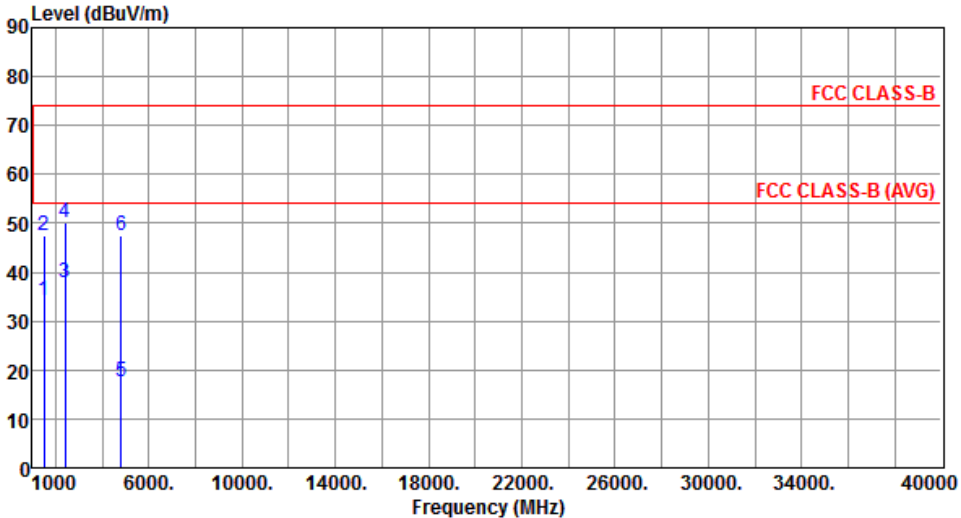
| Modulation | GFSK | Test Freq. (MHz) | 2402 | | | | | | | | | | | | | | | | | | | | | | | | | | | | | | | | | | | | | | | | | | | | | | | | | | | | | | | | | | | | | | | | | | | | | | |
|---|--|--------------------|----------------|------------|--------|------------|----------|------------|----------|------------|-----|--------|--------|----|------|----|--|----|-----|---|---------|-------|-------|--------|-------|-------|---------|-----|---|---------|-------|-------|--------|-------|-------|------|-----|---|---------|-------|-------|--------|-------|-------|---------|-----|---|---------|-------|-------|--------|-------|-------|------|-----|---|---------|-------|-------|--------|-------|------|---------|-----|---|---------|-------|-------|--------|-------|------|------|-----|
| Polarization | Horizontal | Test Configuration | 1 | | | | | | | | | | | | | | | | | | | | | | | | | | | | | | | | | | | | | | | | | | | | | | | | | | | | | | | | | | | | | | | | | | | | | | |
|  | | | | | | | | | | | | | | | | | | | | | | | | | | | | | | | | | | | | | | | | | | | | | | | | | | | | | | | | | | | | | | | | | | | | | | | | | |
| | <table border="1"> <thead> <tr> <th>Freq.</th> <th>Emission level</th> <th>Limit</th> <th>Margin</th> <th>SA reading</th> <th>Factor</th> <th>Remark</th> <th>ANT High</th> <th>Turn Table</th> </tr> <tr> <th>MHz</th> <th>dBuV/m</th> <th>dBuV/m</th> <th>dB</th> <th>dBuV</th> <th>dB</th> <th></th> <th>cm</th> <th>deg</th> </tr> </thead> <tbody> <tr> <td>1</td> <td>1500.00</td> <td>34.35</td> <td>54.00</td> <td>-19.65</td> <td>39.34</td> <td>-4.99</td> <td>Average</td> <td>---</td> </tr> <tr> <td>2</td> <td>1500.00</td> <td>47.44</td> <td>74.00</td> <td>-26.56</td> <td>52.43</td> <td>-4.99</td> <td>Peak</td> <td>---</td> </tr> <tr> <td>3</td> <td>2390.00</td> <td>37.94</td> <td>54.00</td> <td>-16.06</td> <td>39.62</td> <td>-1.68</td> <td>Average</td> <td>---</td> </tr> <tr> <td>4</td> <td>2390.00</td> <td>50.19</td> <td>74.00</td> <td>-23.81</td> <td>51.87</td> <td>-1.68</td> <td>Peak</td> <td>---</td> </tr> <tr> <td>5</td> <td>4804.00</td> <td>17.49</td> <td>54.00</td> <td>-36.51</td> <td>12.15</td> <td>5.34</td> <td>Average</td> <td>---</td> </tr> <tr> <td>6</td> <td>4804.00</td> <td>47.59</td> <td>74.00</td> <td>-26.41</td> <td>42.25</td> <td>5.34</td> <td>Peak</td> <td>---</td> </tr> </tbody> </table> | Freq. | Emission level | Limit | Margin | SA reading | Factor | Remark | ANT High | Turn Table | MHz | dBuV/m | dBuV/m | dB | dBuV | dB | | cm | deg | 1 | 1500.00 | 34.35 | 54.00 | -19.65 | 39.34 | -4.99 | Average | --- | 2 | 1500.00 | 47.44 | 74.00 | -26.56 | 52.43 | -4.99 | Peak | --- | 3 | 2390.00 | 37.94 | 54.00 | -16.06 | 39.62 | -1.68 | Average | --- | 4 | 2390.00 | 50.19 | 74.00 | -23.81 | 51.87 | -1.68 | Peak | --- | 5 | 4804.00 | 17.49 | 54.00 | -36.51 | 12.15 | 5.34 | Average | --- | 6 | 4804.00 | 47.59 | 74.00 | -26.41 | 42.25 | 5.34 | Peak | --- |
| Freq. | Emission level | Limit | Margin | SA reading | Factor | Remark | ANT High | Turn Table | | | | | | | | | | | | | | | | | | | | | | | | | | | | | | | | | | | | | | | | | | | | | | | | | | | | | | | | | | | | | | | | | |
| MHz | dBuV/m | dBuV/m | dB | dBuV | dB | | cm | deg | | | | | | | | | | | | | | | | | | | | | | | | | | | | | | | | | | | | | | | | | | | | | | | | | | | | | | | | | | | | | | | | | |
| 1 | 1500.00 | 34.35 | 54.00 | -19.65 | 39.34 | -4.99 | Average | --- | | | | | | | | | | | | | | | | | | | | | | | | | | | | | | | | | | | | | | | | | | | | | | | | | | | | | | | | | | | | | | | | | |
| 2 | 1500.00 | 47.44 | 74.00 | -26.56 | 52.43 | -4.99 | Peak | --- | | | | | | | | | | | | | | | | | | | | | | | | | | | | | | | | | | | | | | | | | | | | | | | | | | | | | | | | | | | | | | | | | |
| 3 | 2390.00 | 37.94 | 54.00 | -16.06 | 39.62 | -1.68 | Average | --- | | | | | | | | | | | | | | | | | | | | | | | | | | | | | | | | | | | | | | | | | | | | | | | | | | | | | | | | | | | | | | | | | |
| 4 | 2390.00 | 50.19 | 74.00 | -23.81 | 51.87 | -1.68 | Peak | --- | | | | | | | | | | | | | | | | | | | | | | | | | | | | | | | | | | | | | | | | | | | | | | | | | | | | | | | | | | | | | | | | | |
| 5 | 4804.00 | 17.49 | 54.00 | -36.51 | 12.15 | 5.34 | Average | --- | | | | | | | | | | | | | | | | | | | | | | | | | | | | | | | | | | | | | | | | | | | | | | | | | | | | | | | | | | | | | | | | | |
| 6 | 4804.00 | 47.59 | 74.00 | -26.41 | 42.25 | 5.34 | Peak | --- | | | | | | | | | | | | | | | | | | | | | | | | | | | | | | | | | | | | | | | | | | | | | | | | | | | | | | | | | | | | | | | | | |
| <p>Note 1: Emission Level (dBuV/m) = SA Reading (dBuV/m) + Factor* (dB) *Factor includes antenna factor , cable loss and amplifier gain Note 2: Margin (dB) = Emission level (dBuV/m) – Limit (dBuV/m).</p> | | | | | | | | | | | | | | | | | | | | | | | | | | | | | | | | | | | | | | | | | | | | | | | | | | | | | | | | | | | | | | | | | | | | | | | | | |

| | | | |
|---------------------|----------|---------------------------|------|
| Modulation | GFSK | Test Freq. (MHz) | 2402 |
| Polarization | Vertical | Test Configuration | 1 |

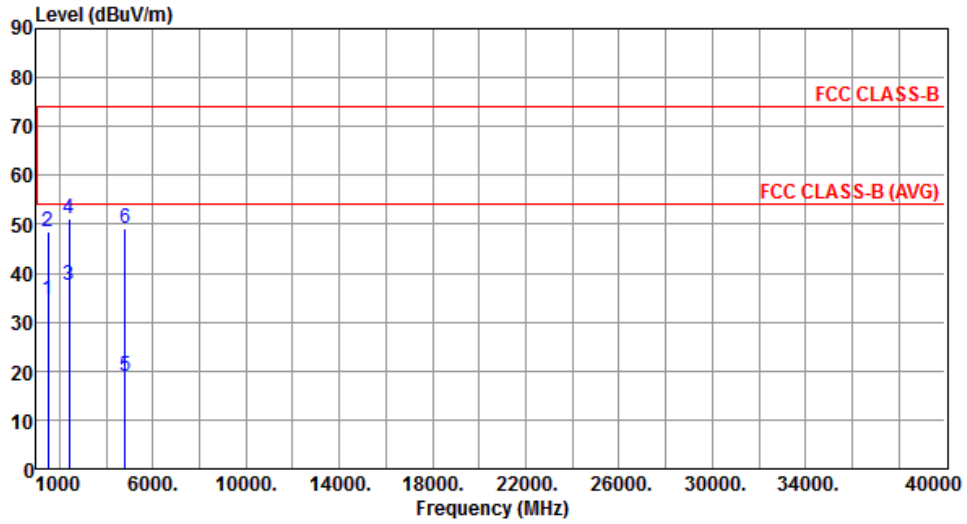

| | Freq. MHz | Emission level dBuV/m | Limit dBuV/m | Margin dB | SA reading dBuV | Factor dB | Remark | ANT High cm | Turn Table deg |
|---|--------------|-----------------------------|-----------------|--------------|-----------------------|--------------|---------|-------------------|----------------------|
| 1 | 1500.00 | 34.44 | 54.00 | -19.56 | 39.43 | -4.99 | Average | --- | --- |
| 2 | 1500.00 | 48.35 | 74.00 | -25.65 | 53.34 | -4.99 | Peak | --- | --- |
| 3 | 2390.00 | 37.63 | 54.00 | -16.37 | 39.31 | -1.68 | Average | --- | --- |
| 4 | 2390.00 | 50.99 | 74.00 | -23.01 | 52.67 | -1.68 | Peak | --- | --- |
| 5 | 4804.00 | 19.07 | 54.00 | -34.93 | 13.73 | 5.34 | Average | --- | --- |
| 6 | 4804.00 | 49.17 | 74.00 | -24.83 | 43.83 | 5.34 | Peak | --- | --- |

Note 1: Emission Level (dBuV/m) = SA Reading (dBuV/m) + Factor* (dB)

*Factor includes antenna factor , cable loss and amplifier gain

Note 2: Margin (dB) = Emission level (dBuV/m) – Limit (dBuV/m).

| | | | |
|---------------------|------------|---------------------------|------|
| Modulation | GFSK | Test Freq. (MHz) | 2441 |
| Polarization | Horizontal | Test Configuration | 1 |

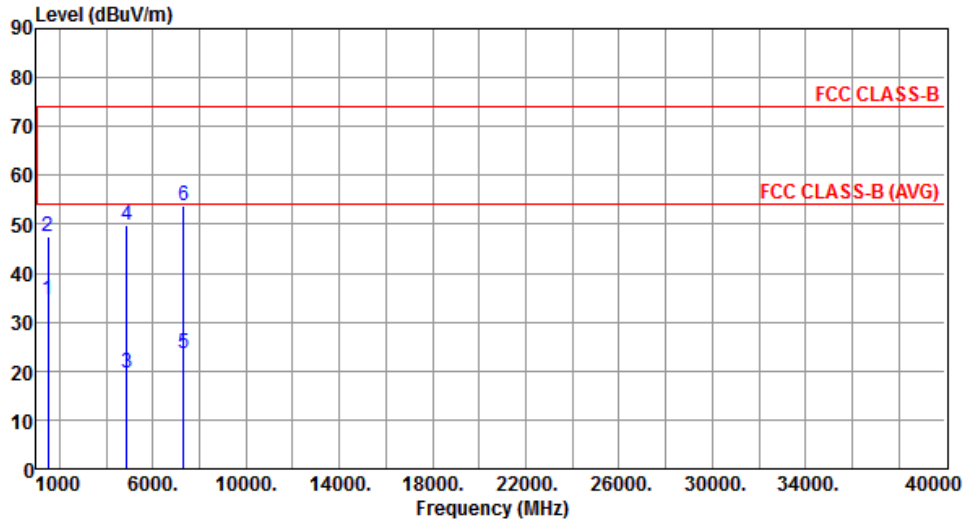

| | Freq. MHz | Emission level dBuV/m | Limit dBuV/m | Margin dB | SA reading dBuV | Factor dB | Remark | ANT High cm | Turn Table deg |
|---|--------------|-----------------------------|-----------------|--------------|-----------------------|--------------|---------|-------------------|----------------------|
| 1 | 1500.00 | 34.39 | 54.00 | -19.61 | 39.38 | -4.99 | Average | --- | --- |
| 2 | 1500.00 | 47.49 | 74.00 | -26.51 | 52.48 | -4.99 | Peak | --- | --- |
| 3 | 4882.00 | 19.70 | 54.00 | -34.30 | 14.16 | 5.54 | Average | --- | --- |
| 4 | 4882.00 | 49.80 | 74.00 | -24.20 | 44.26 | 5.54 | Peak | --- | --- |
| 5 | 7323.00 | 23.54 | 54.00 | -30.46 | 12.25 | 11.29 | Average | --- | --- |
| 6 | 7323.00 | 53.64 | 74.00 | -20.36 | 42.35 | 11.29 | Peak | --- | --- |

Note 1: Emission Level (dBuV/m) = SA Reading (dBuV/m) + Factor* (dB)

*Factor includes antenna factor , cable loss and amplifier gain

Note 2: Margin (dB) = Emission level (dBuV/m) – Limit (dBuV/m).

| | | | |
|---------------------|----------|---------------------------|------|
| Modulation | GFSK | Test Freq. (MHz) | 2441 |
| Polarization | Vertical | Test Configuration | 1 |

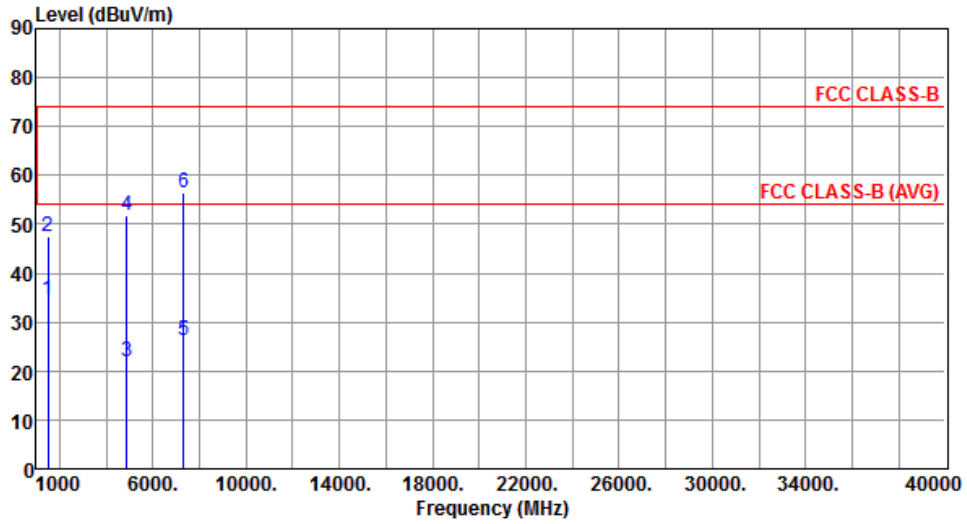

| | Freq. MHz | Emission level dBuV/m | Limit dBuV/m | Margin dB | SA reading dBuV | Factor dB | Remark | ANT High cm | Turn Table deg |
|---|--------------|-----------------------------|-----------------|--------------|-----------------------|--------------|---------|-------------------|----------------------|
| 1 | 1500.00 | 34.40 | 54.00 | -19.60 | 39.39 | -4.99 | Average | --- | --- |
| 2 | 1500.00 | 47.38 | 74.00 | -26.62 | 52.37 | -4.99 | Peak | --- | --- |
| 3 | 4882.00 | 21.80 | 54.00 | -32.20 | 16.26 | 5.54 | Average | --- | --- |
| 4 | 4882.00 | 51.90 | 74.00 | -22.10 | 46.36 | 5.54 | Peak | --- | --- |
| 5 | 7323.00 | 26.37 | 54.00 | -27.63 | 15.08 | 11.29 | Average | --- | --- |
| 6 | 7323.00 | 56.47 | 74.00 | -17.53 | 45.18 | 11.29 | Peak | --- | --- |

Note 1: Emission Level (dBuV/m) = SA Reading (dBuV/m) + Factor* (dB)

*Factor includes antenna factor , cable loss and amplifier gain

Note 2: Margin (dB) = Emission level (dBuV/m) – Limit (dBuV/m).

| | | | |
|---------------------|------------|---------------------------|------|
| Modulation | GFSK | Test Freq. (MHz) | 2480 |
| Polarization | Horizontal | Test Configuration | 1 |

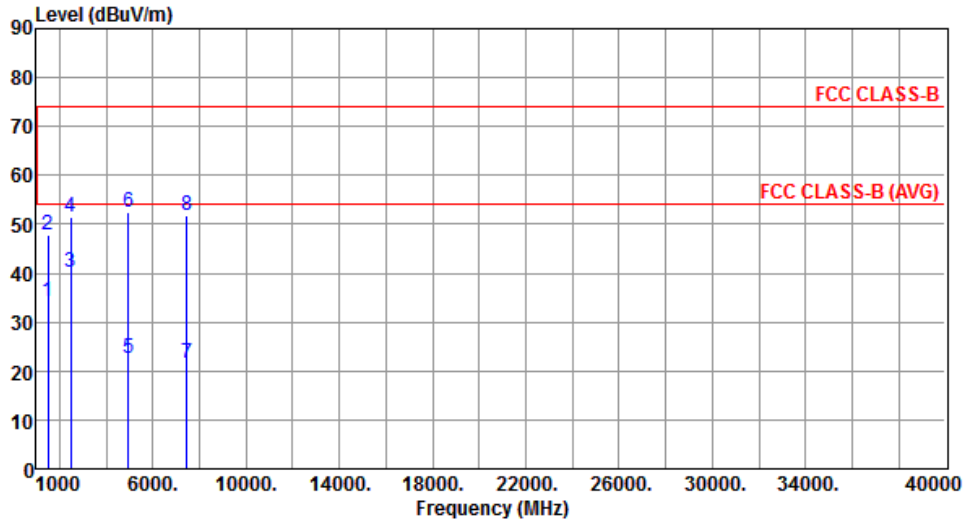

| | Freq. MHz | Emission level dBuV/m | Limit dBuV/m | Margin dB | SA reading dBuV | Factor dB | Remark | ANT High cm | Turn Table deg |
|---|--------------|-----------------------------|-----------------|--------------|-----------------------|--------------|---------|-------------------|----------------------|
| 1 | 1500.00 | 34.33 | 54.00 | -19.67 | 39.32 | -4.99 | Average | --- | --- |
| 2 | 1500.00 | 47.72 | 74.00 | -26.28 | 52.71 | -4.99 | Peak | --- | --- |
| 3 | 2483.50 | 40.12 | 54.00 | -13.88 | 41.46 | -1.34 | Average | --- | --- |
| 4 | 2483.50 | 51.54 | 74.00 | -22.46 | 52.88 | -1.34 | Peak | --- | --- |
| 5 | 4960.00 | 22.51 | 54.00 | -31.49 | 16.77 | 5.74 | Average | --- | --- |
| 6 | 4960.00 | 52.61 | 74.00 | -21.39 | 46.87 | 5.74 | Peak | --- | --- |
| 7 | 7440.00 | 21.57 | 54.00 | -32.43 | 10.31 | 11.26 | Average | --- | --- |
| 8 | 7440.00 | 51.67 | 74.00 | -22.33 | 40.41 | 11.26 | Peak | --- | --- |

Note 1: Emission Level (dBuV/m) = SA Reading (dBuV/m) + Factor* (dB)

*Factor includes antenna factor , cable loss and amplifier gain

Note 2: Margin (dB) = Emission level (dBuV/m) – Limit (dBuV/m).

| | | | |
|---------------------|----------|---------------------------|------|
| Modulation | GFSK | Test Freq. (MHz) | 2480 |
| Polarization | Vertical | Test Configuration | 1 |

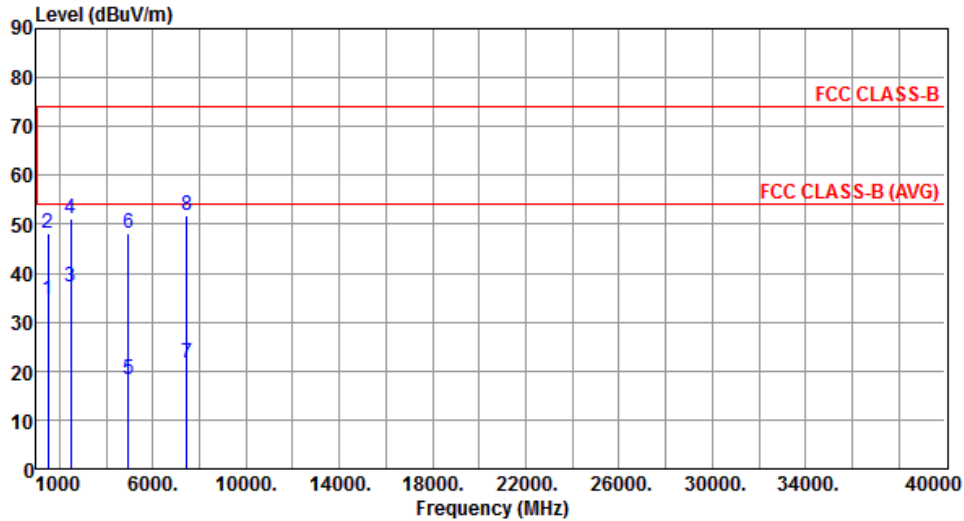

| | Freq. MHz | Emission level dBuV/m | Limit dBuV/m | Margin dB | SA reading dBuV | Factor dB | Remark | ANT High cm | Turn Table deg |
|---|--------------|-----------------------------|-----------------|--------------|-----------------------|--------------|---------|-------------------|----------------------|
| 1 | 1500.00 | 34.62 | 54.00 | -19.38 | 39.61 | -4.99 | Average | --- | --- |
| 2 | 1500.00 | 48.26 | 74.00 | -25.74 | 53.25 | -4.99 | Peak | --- | --- |
| 3 | 2483.50 | 37.20 | 54.00 | -16.80 | 38.54 | -1.34 | Average | --- | --- |
| 4 | 2483.50 | 51.14 | 74.00 | -22.86 | 52.48 | -1.34 | Peak | --- | --- |
| 5 | 4960.00 | 18.18 | 54.00 | -35.82 | 12.44 | 5.74 | Average | --- | --- |
| 6 | 4960.00 | 48.28 | 74.00 | -25.72 | 42.54 | 5.74 | Peak | --- | --- |
| 7 | 7440.00 | 21.59 | 54.00 | -32.41 | 10.33 | 11.26 | Average | --- | --- |
| 8 | 7440.00 | 51.69 | 74.00 | -22.31 | 40.43 | 11.26 | Peak | --- | --- |

Note 1: Emission Level (dBuV/m) = SA Reading (dBuV/m) + Factor* (dB)

*Factor includes antenna factor , cable loss and amplifier gain

Note 2: Margin (dB) = Emission level (dBuV/m) – Limit (dBuV/m).

3.2.6 Transmitter Radiated Unwanted Emissions (Above 1GHz) for 8DPSK

| Modulation | 8DPSK | Test Freq. (MHz) | 2402 |
|--------------|------------|--------------------|------|
| Polarization | Horizontal | Test Configuration | 1 |

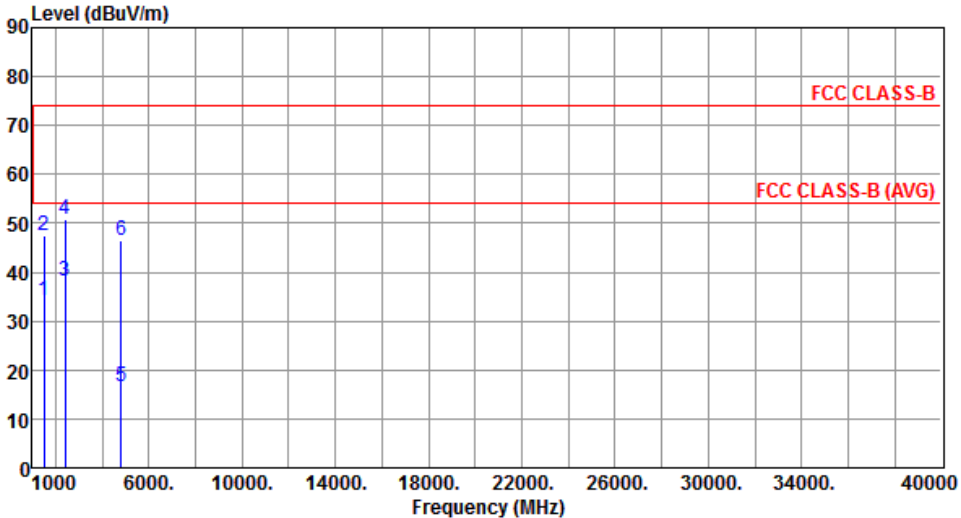

The graph plots Level (dBuV/m) on the y-axis (0 to 90) against Frequency (MHz) on the x-axis (1000 to 40000). Two horizontal red lines represent the FCC CLASS-B limit at 74 dBuV/m and the FCC CLASS-B (AVG) limit at 54 dBuV/m. Six vertical blue lines represent measured emission levels at various frequencies: 1500 MHz (47.62 dBuV/m), 2390 MHz (50.74 dBuV/m), and 4804 MHz (46.66 dBuV/m). All measured levels are significantly below the 74 dBuV/m limit.

| | Freq. MHz | Emission level dBuV/m | Limit dBuV/m | Margin dB | SA reading dBuV | Factor dB | Remark | ANT High cm | Turn Table deg |
|---|--------------|-----------------------------|-----------------|--------------|-----------------------|--------------|---------|-------------------|----------------------|
| 1 | 1500.00 | 34.28 | 54.00 | -19.72 | 39.27 | -4.99 | Average | --- | --- |
| 2 | 1500.00 | 47.62 | 74.00 | -26.38 | 52.61 | -4.99 | Peak | --- | --- |
| 3 | 2390.00 | 38.12 | 54.00 | -15.88 | 39.80 | -1.68 | Average | --- | --- |
| 4 | 2390.00 | 50.74 | 74.00 | -23.26 | 52.42 | -1.68 | Peak | --- | --- |
| 5 | 4804.00 | 16.56 | 54.00 | -37.44 | 11.22 | 5.34 | Average | --- | --- |
| 6 | 4804.00 | 46.66 | 74.00 | -27.34 | 41.32 | 5.34 | Peak | --- | --- |

Note 1: Emission Level (dBuV/m) = SA Reading (dBuV/m) + Factor* (dB)
 *Factor includes antenna factor , cable loss and amplifier gain
 Note 2: Margin (dB) = Emission level (dBuV/m) – Limit (dBuV/m).

| | | | |
|---------------------|----------|---------------------------|------|
| Modulation | 8DPSK | Test Freq. (MHz) | 2402 |
| Polarization | Vertical | Test Configuration | 1 |

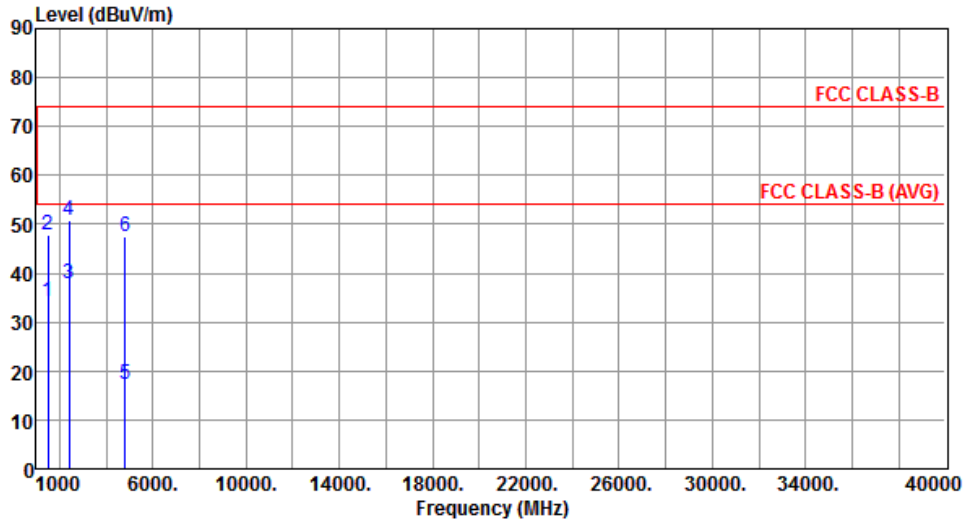

| | Freq. MHz | Emission level dBuV/m | Limit dBuV/m | Margin dB | SA reading dBuV | Factor dB | Remark | ANT High cm | Turn Table deg |
|---|--------------|-----------------------------|-----------------|--------------|-----------------------|--------------|---------|-------------------|----------------------|
| 1 | 1500.00 | 34.33 | 54.00 | -19.67 | 39.32 | -4.99 | Average | --- | --- |
| 2 | 1500.00 | 47.80 | 74.00 | -26.20 | 52.79 | -4.99 | Peak | --- | --- |
| 3 | 2390.00 | 37.74 | 54.00 | -16.26 | 39.42 | -1.68 | Average | --- | --- |
| 4 | 2390.00 | 50.85 | 74.00 | -23.15 | 52.53 | -1.68 | Peak | --- | --- |
| 5 | 4804.00 | 17.26 | 54.00 | -36.74 | 11.92 | 5.34 | Average | --- | --- |
| 6 | 4804.00 | 47.36 | 74.00 | -26.64 | 42.02 | 5.34 | Peak | --- | --- |

Note 1: Emission Level (dBuV/m) = SA Reading (dBuV/m) + Factor* (dB)

*Factor includes antenna factor , cable loss and amplifier gain

Note 2: Margin (dB) = Emission level (dBuV/m) – Limit (dBuV/m).

| | | | |
|---------------------|------------|---------------------------|------|
| Modulation | 8DPSK | Test Freq. (MHz) | 2441 |
| Polarization | Horizontal | Test Configuration | 1 |

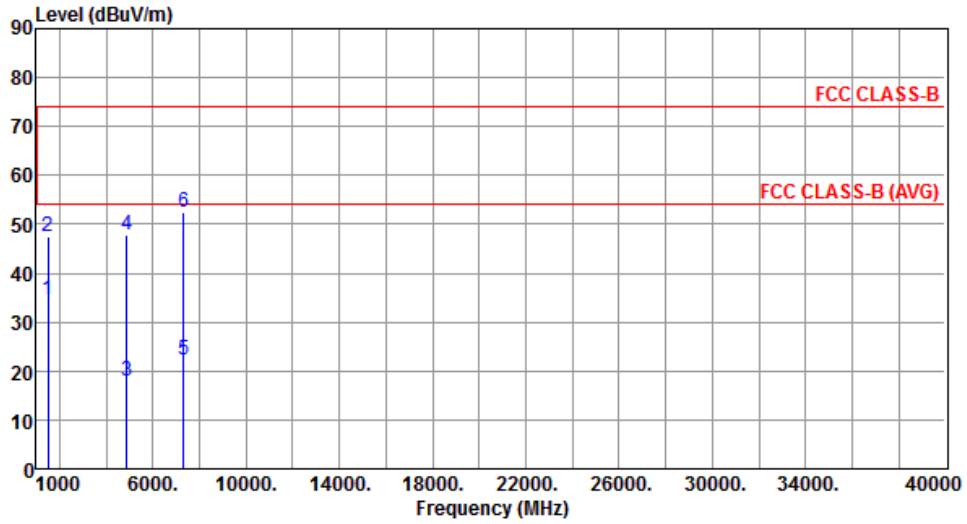

| | Freq. MHz | Emission level dBuV/m | Limit dBuV/m | Margin dB | SA reading dBuV | Factor dB | Remark | ANT High cm | Turn Table deg |
|---|--------------|-----------------------------|-----------------|--------------|-----------------------|--------------|---------|-------------------|----------------------|
| 1 | 1500.00 | 34.44 | 54.00 | -19.56 | 39.43 | -4.99 | Average | --- | --- |
| 2 | 1500.00 | 47.55 | 74.00 | -26.45 | 52.54 | -4.99 | Peak | --- | --- |
| 3 | 4882.00 | 17.87 | 54.00 | -36.13 | 12.33 | 5.54 | Average | --- | --- |
| 4 | 4882.00 | 47.97 | 74.00 | -26.03 | 42.43 | 5.54 | Peak | --- | --- |
| 5 | 7323.00 | 22.21 | 54.00 | -31.79 | 10.92 | 11.29 | Average | --- | --- |
| 6 | 7323.00 | 52.31 | 74.00 | -21.69 | 41.02 | 11.29 | Peak | --- | --- |

Note 1: Emission Level (dBuV/m) = SA Reading (dBuV/m) + Factor* (dB)

*Factor includes antenna factor , cable loss and amplifier gain

Note 2: Margin (dB) = Emission level (dBuV/m) – Limit (dBuV/m).

| | | | |
|---------------------|----------|---------------------------|------|
| Modulation | 8DPSK | Test Freq. (MHz) | 2441 |
| Polarization | Vertical | Test Configuration | 1 |

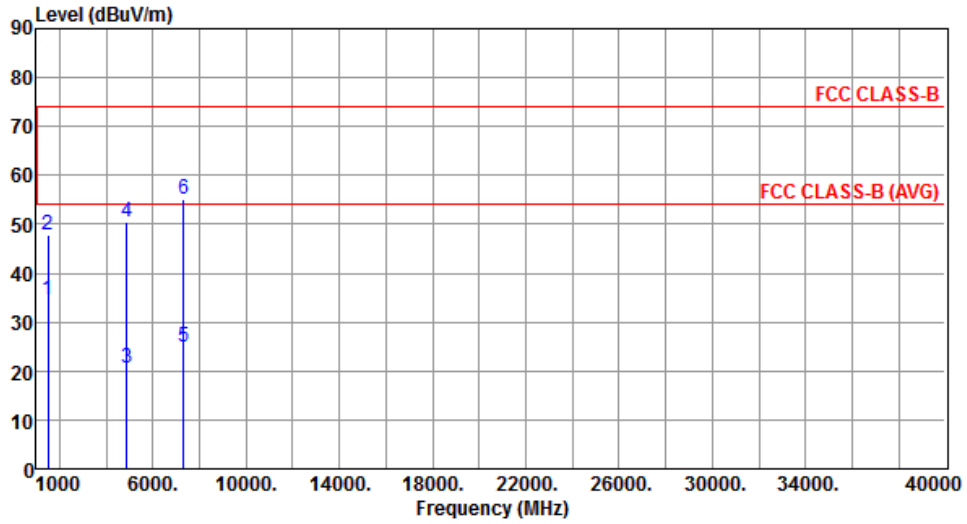

| | Freq. MHz | Emission level dBuV/m | Limit dBuV/m | Margin dB | SA reading dBuV | Factor dB | Remark | ANT High cm | Turn Table deg |
|---|--------------|-----------------------------|-----------------|--------------|-----------------------|--------------|---------|-------------------|----------------------|
| 1 | 1500.00 | 34.56 | 54.00 | -19.44 | 39.55 | -4.99 | Average | --- | --- |
| 2 | 1500.00 | 47.69 | 74.00 | -26.31 | 52.68 | -4.99 | Peak | --- | --- |
| 3 | 4882.00 | 20.46 | 54.00 | -33.54 | 14.92 | 5.54 | Average | --- | --- |
| 4 | 4882.00 | 50.56 | 74.00 | -23.44 | 45.02 | 5.54 | Peak | --- | --- |
| 5 | 7323.00 | 25.05 | 54.00 | -28.95 | 13.76 | 11.29 | Average | --- | --- |
| 6 | 7323.00 | 55.15 | 74.00 | -18.85 | 43.86 | 11.29 | Peak | --- | --- |

Note 1: Emission Level (dBuV/m) = SA Reading (dBuV/m) + Factor* (dB)

*Factor includes antenna factor , cable loss and amplifier gain

Note 2: Margin (dB) = Emission level (dBuV/m) – Limit (dBuV/m).

| | | | |
|---------------------|------------|---------------------------|------|
| Modulation | 8DPSK | Test Freq. (MHz) | 2480 |
| Polarization | Horizontal | Test Configuration | 1 |

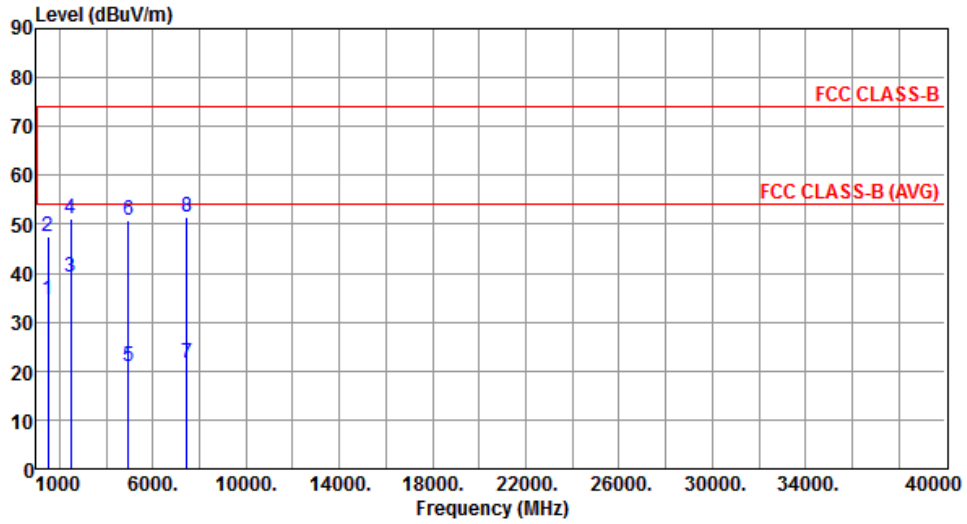

| | Freq. MHz | Emission level dBuV/m | Limit dBuV/m | Margin dB | SA reading dBuV | Factor dB | Remark | ANT High cm | Turn Table deg |
|---|--------------|-----------------------------|-----------------|--------------|-----------------------|--------------|---------|-------------------|----------------------|
| 1 | 1500.00 | 34.40 | 54.00 | -19.60 | 39.39 | -4.99 | Average | --- | --- |
| 2 | 1500.00 | 47.55 | 74.00 | -26.45 | 52.54 | -4.99 | Peak | --- | --- |
| 3 | 2483.50 | 39.35 | 54.00 | -14.65 | 40.69 | -1.34 | Average | --- | --- |
| 4 | 2483.50 | 51.11 | 74.00 | -22.89 | 52.45 | -1.34 | Peak | --- | --- |
| 5 | 4960.00 | 20.78 | 54.00 | -33.22 | 15.04 | 5.74 | Average | --- | --- |
| 6 | 4960.00 | 50.88 | 74.00 | -23.12 | 45.14 | 5.74 | Peak | --- | --- |
| 7 | 7440.00 | 21.47 | 54.00 | -32.53 | 10.21 | 11.26 | Average | --- | --- |
| 8 | 7440.00 | 51.57 | 74.00 | -22.43 | 40.31 | 11.26 | Peak | --- | --- |

Note 1: Emission Level (dBuV/m) = SA Reading (dBuV/m) + Factor* (dB)

*Factor includes antenna factor , cable loss and amplifier gain

Note 2: Margin (dB) = Emission level (dBuV/m) – Limit (dBuV/m).

| | | | |
|---------------------|----------|---------------------------|------|
| Modulation | 8DPSK | Test Freq. (MHz) | 2480 |
| Polarization | Vertical | Test Configuration | 1 |

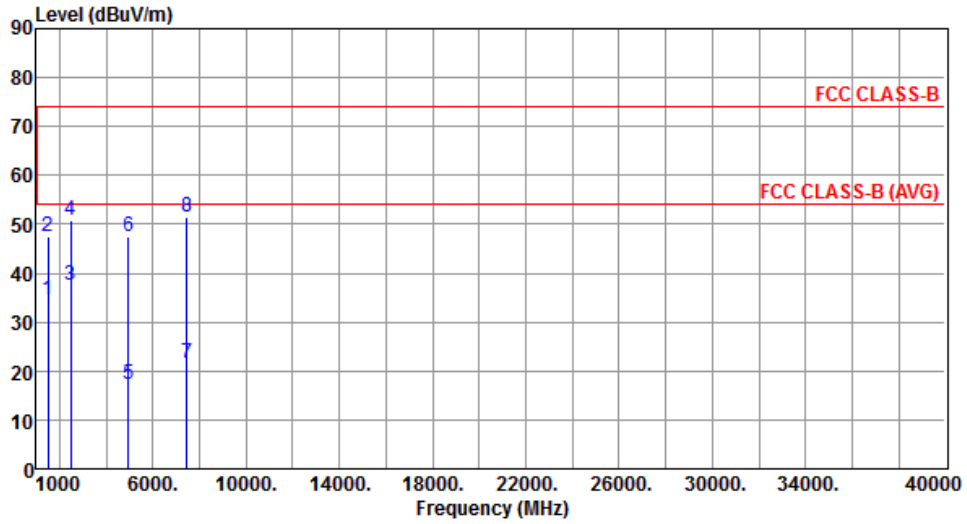

| | Freq. MHz | Emission level dBuV/m | Limit dBuV/m | Margin dB | SA reading dBuV | Factor dB | Remark | ANT High cm | Turn Table deg |
|---|--------------|-----------------------------|-----------------|--------------|-----------------------|--------------|---------|-------------------|----------------------|
| 1 | 1500.00 | 34.48 | 54.00 | -19.52 | 39.47 | -4.99 | Average | --- | --- |
| 2 | 1500.00 | 47.40 | 74.00 | -26.60 | 52.39 | -4.99 | Peak | --- | --- |
| 3 | 2483.50 | 37.53 | 54.00 | -16.47 | 38.87 | -1.34 | Average | --- | --- |
| 4 | 2483.50 | 50.90 | 74.00 | -23.10 | 52.24 | -1.34 | Peak | --- | --- |
| 5 | 4960.00 | 17.33 | 54.00 | -36.67 | 11.59 | 5.74 | Average | --- | --- |
| 6 | 4960.00 | 47.43 | 74.00 | -26.57 | 41.69 | 5.74 | Peak | --- | --- |
| 7 | 7440.00 | 21.53 | 54.00 | -32.47 | 10.27 | 11.26 | Average | --- | --- |
| 8 | 7440.00 | 51.63 | 74.00 | -22.37 | 40.37 | 11.26 | Peak | --- | --- |

Note 1: Emission Level (dBuV/m) = SA Reading (dBuV/m) + Factor* (dB)

*Factor includes antenna factor , cable loss and amplifier gain

Note 2: Margin (dB) = Emission level (dBuV/m) – Limit (dBuV/m).

3.3 Unwanted Emissions into Non-Restricted Frequency Bands

3.3.1 Limit of Unwanted Emissions into Non-Restricted Frequency Bands

The peak output power measured in any 100 kHz bandwidth outside of the authorized frequency band shall be attenuated by at least 20 dB relative to the maximum in-band peak PSD level in 100 kHz.

3.3.2 Test Procedures

Reference Level Measurement

1. Set the RBW = 100 kHz, VBW = 300 kHz, Detector = peak.
2. Set Sweep time = auto couple, Trace mode = max hold.
3. Allow trace to fully stabilize.
4. Use the peak marker function to determine the maximum amplitude level.

Unwanted Emissions Level Measurement

1. Set RBW = 100 kHz, VBW = 300 kHz, Detector = peak.
2. Trace Mode = max hold, Sweep = auto couple.
3. Allow the trace to stabilize.
4. Use peak marker function to determine maximum amplitude of all unwanted emissions within any 100 kHz bandwidth.

3.3.3 Test Setup

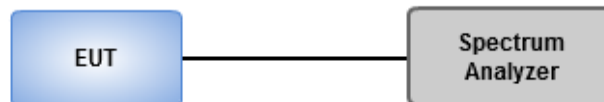

3.3.4 Unwanted Emissions into Non-Restricted Frequency Bands

GFSK

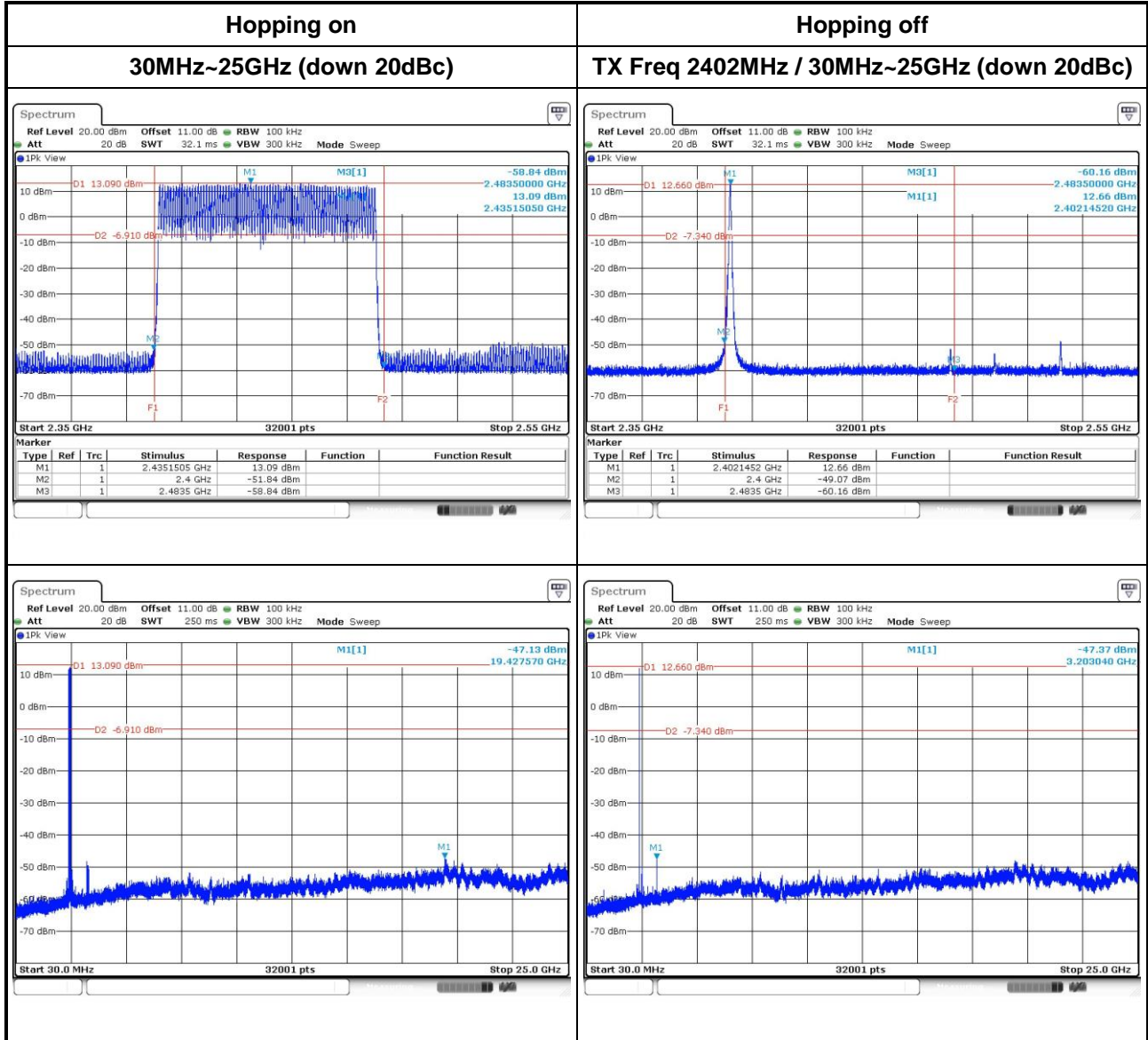

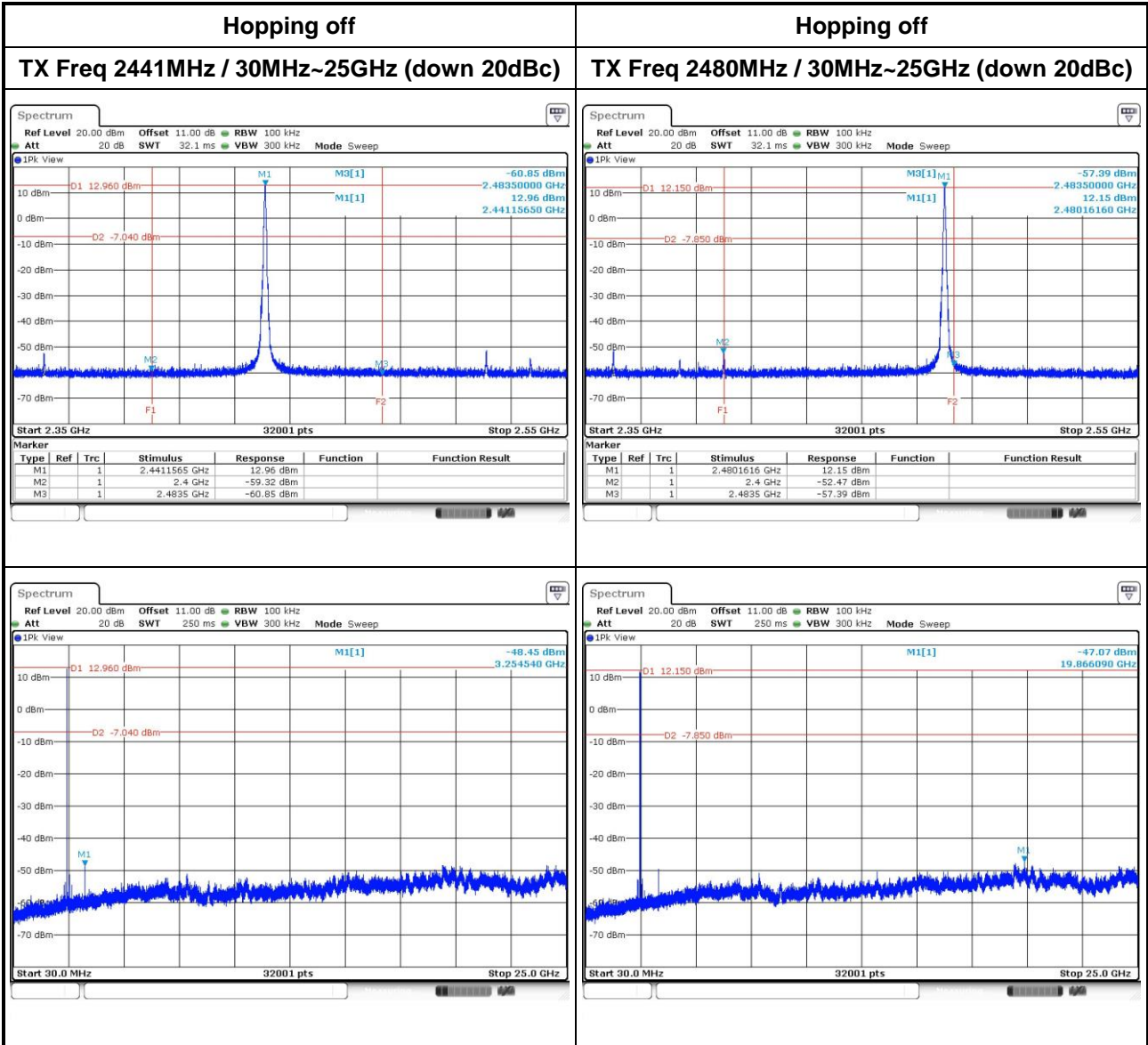

8DPSK

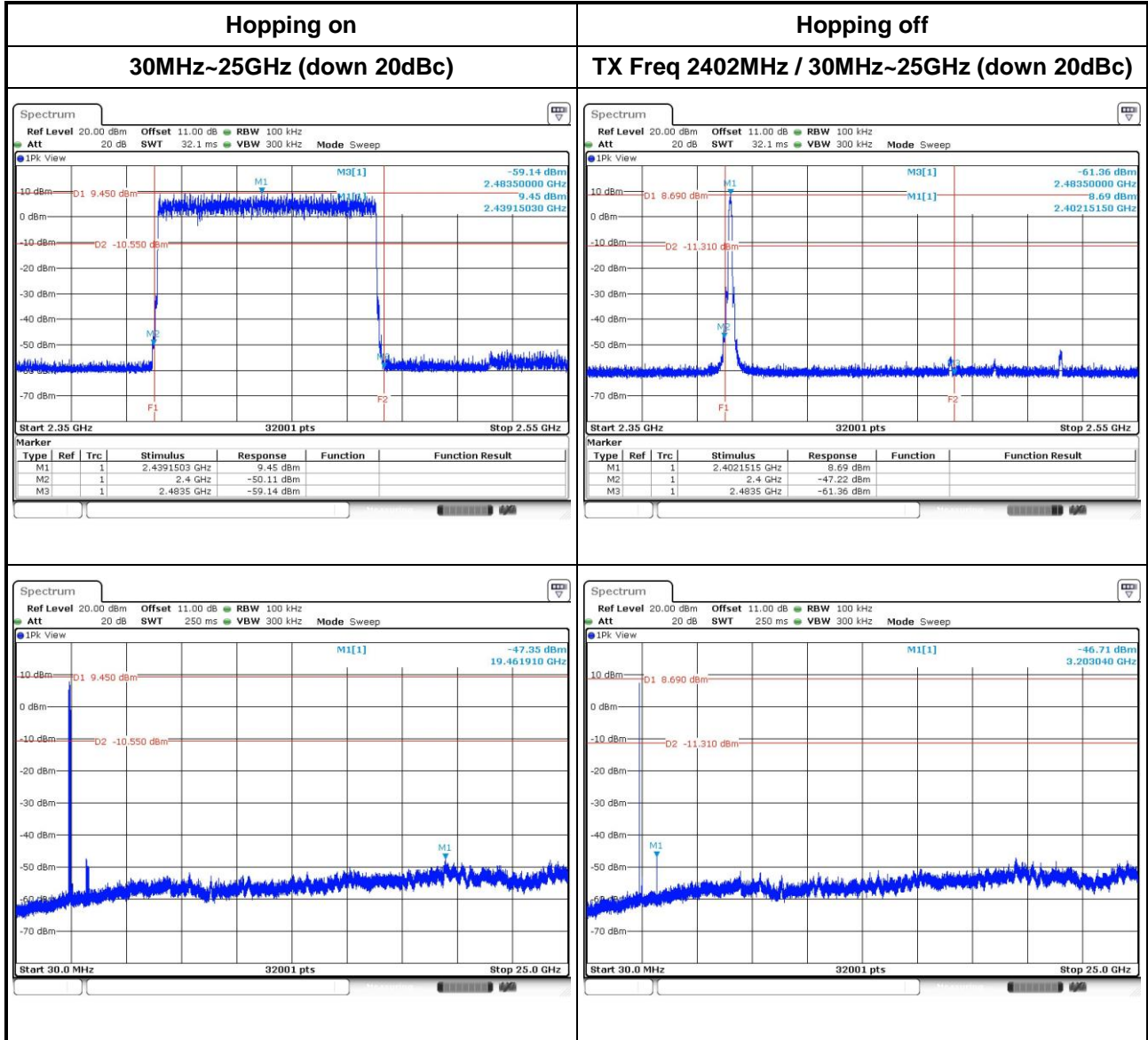

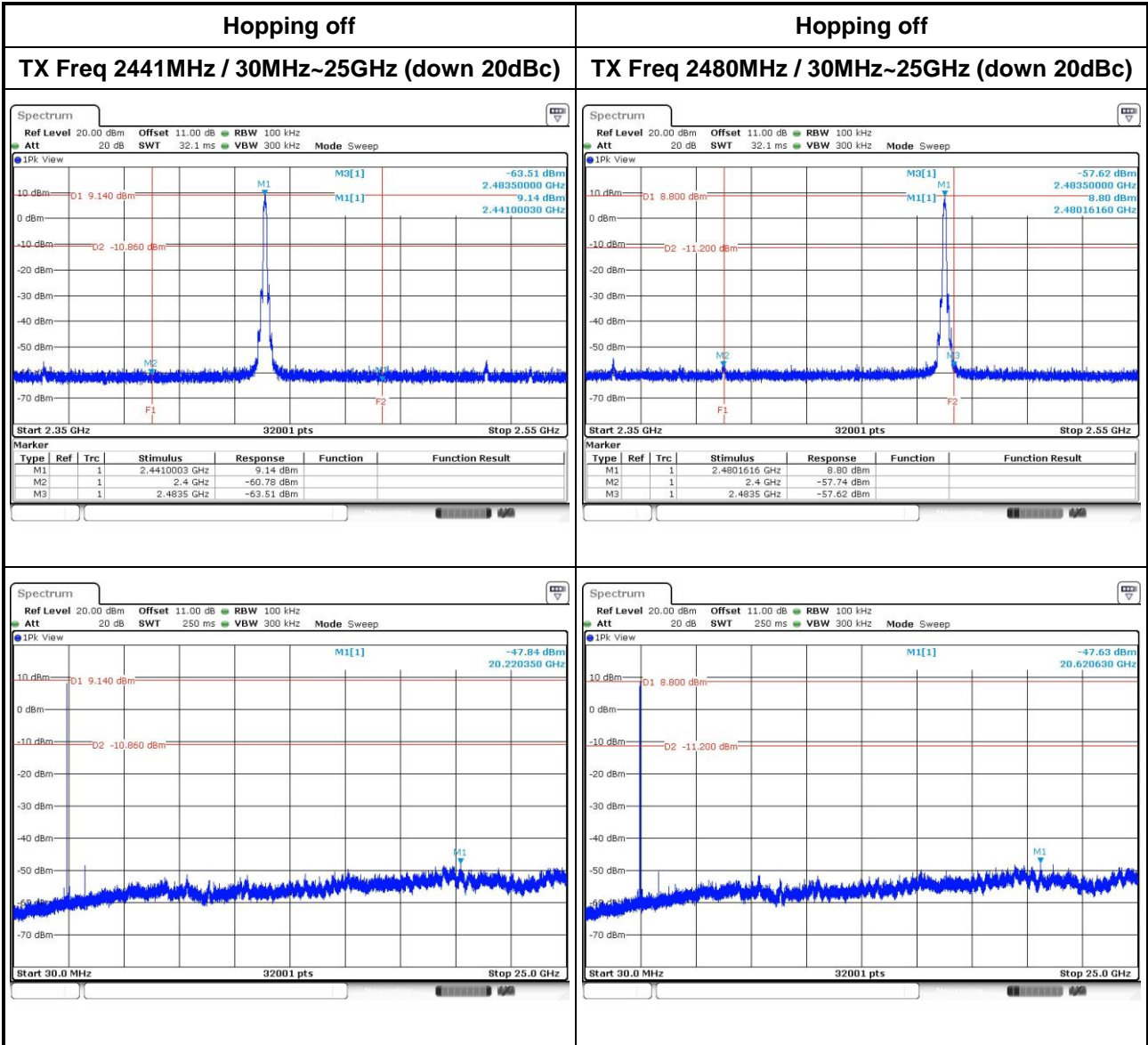

3.4 Conducted Output Power

3.4.1 Limit of Unwanted Emissions into Non-Restricted Frequency Bands

- 1 Watt
For frequency hopping systems operating in the 2400–2483.5 MHz band employing at least 75 non overlapping hopping channels, and all frequency hopping systems in the 5725–5850 MHz band.
- 0.125 Watt
For all other frequency hopping systems in the 2400–2483.5 MHz band.
- 0.125 Watt
For Frequency hopping systems operating in the 2400–2483.5 MHz band have hopping channel carrier frequencies that are separated by two-thirds of the 20 dB bandwidth of the hopping channel.

3.4.2 Test Procedures

1. A wideband power meter is used for power measurement. Bandwidth of power sensor and meter is 50MHz
2. If duty cycle of test signal is not 100 %, trigger and gating function of power meter will be enabled to capture transmission burst for measuring output power

3.4.3 Test Setup

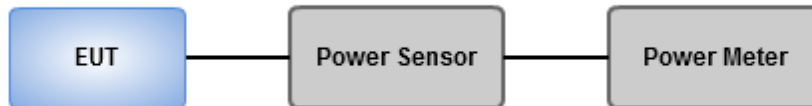

3.4.4 Test Result of Conducted Output Power

| Modulation Mode | Freq. (MHz) | Output Power (mW) | Output Power (dBm) | Limit (mW) |
|-----------------|-------------|-------------------|--------------------|------------|
| GFSK | 2402 | 13.68 | 11.36 | 125 |
| GFSK | 2441 | 15.31 | 11.85 | 125 |
| GFSK | 2480 | 12.74 | 11.05 | 125 |
| π/4 DQPSK | 2402 | 10.69 | 10.29 | 125 |
| π/4 DQPSK | 2441 | 12.05 | 10.81 | 125 |
| π/4 DQPSK | 2480 | 10.67 | 10.28 | 125 |
| 8DPSK | 2402 | 11.09 | 10.45 | 125 |
| 8DPSK | 2441 | 12.53 | 10.98 | 125 |
| 8DPSK | 2480 | 11.22 | 10.50 | 125 |

| Modulation Mode | Freq. (MHz) | AV Output Power (mW) | AV Output Power (dBm) |
|-----------------|-------------|----------------------|-----------------------|
| GFSK | 2402 | 13.12 | 11.18 |
| GFSK | 2441 | 14.76 | 11.69 |
| GFSK | 2480 | 12.19 | 10.86 |
| π/4 DQPSK | 2402 | 6.00 | 7.78 |
| π/4 DQPSK | 2441 | 6.92 | 8.40 |
| π/4 DQPSK | 2480 | 6.04 | 7.81 |
| 8DPSK | 2402 | 6.04 | 7.81 |
| 8DPSK | 2441 | 6.93 | 8.41 |
| 8DPSK | 2480 | 5.97 | 7.76 |

Note: Average power is for reference only.

3.5 Number of Hopping Frequency

3.5.1 Limit of Number of Hopping Frequency

Frequency hopping systems in the 2400–2483.5 MHz band shall use at least 15 channels.

3.5.2 Test Procedures

1. Set RBW = 100kHz, VBW = 300kHz, Sweep time = Auto, Detector = Peak Trace max hold.
2. Allow trace to stabilize.

3.5.3 Test Setup

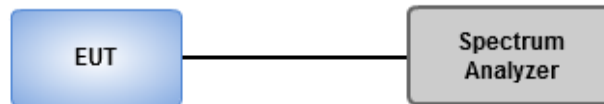

3.5.4 Test Result of Number of Hopping Frequency

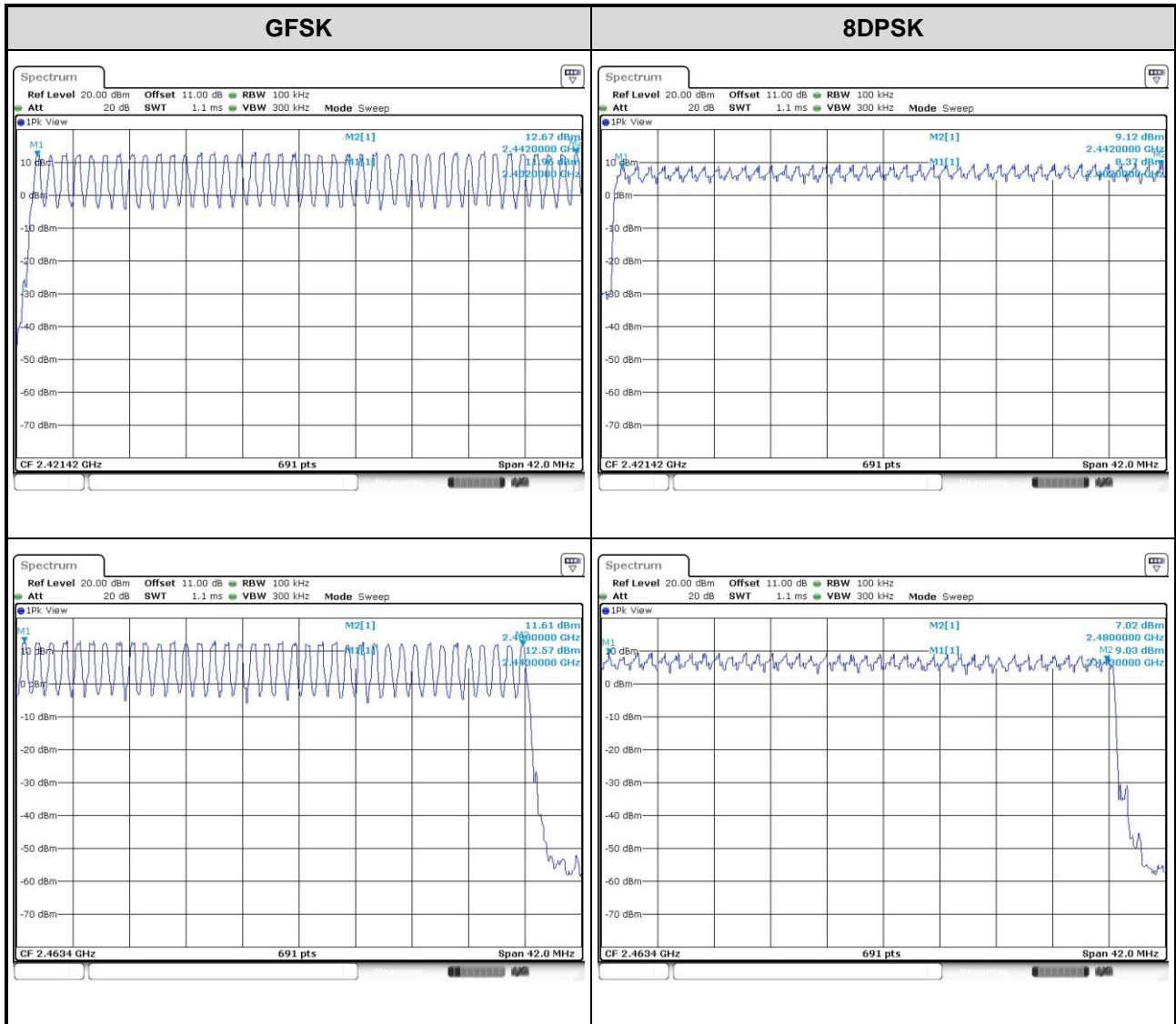

3.6 20dB and Occupied Bandwidth

3.6.1 Test Procedures

1. Set RBW=30kHz, VBW=100kHz, Sweep time = Auto, Detector=Peak Trace max hold
2. Allow trace to stabilize
3. Use N dB function of spectrum analyzer to measuring 20 dB bandwidth
4. Use Occupied bandwidth function of spectrum analyzer to measuring 99% occupied bandwidth

3.6.2 Test Setup

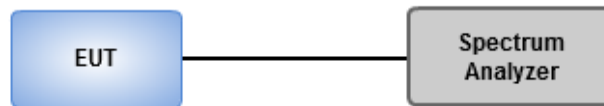

3.6.3 Test result of 20dB and Occupied Bandwidth

| Modulation Mode | Freq. (MHz) | 20dB Bandwidth (MHz) | Occupied Bandwidth (MHz) |
|-----------------|-------------|----------------------|--------------------------|
| GFSK | 2402 | 0.952 | 0.907 |
| GFSK | 2441 | 0.952 | 0.907 |
| GFSK | 2480 | 0.948 | 0.903 |
| 8DPSK | 2402 | 1.326 | 1.211 |
| 8DPSK | 2441 | 1.326 | 1.211 |
| 8DPSK | 2480 | 1.326 | 1.211 |

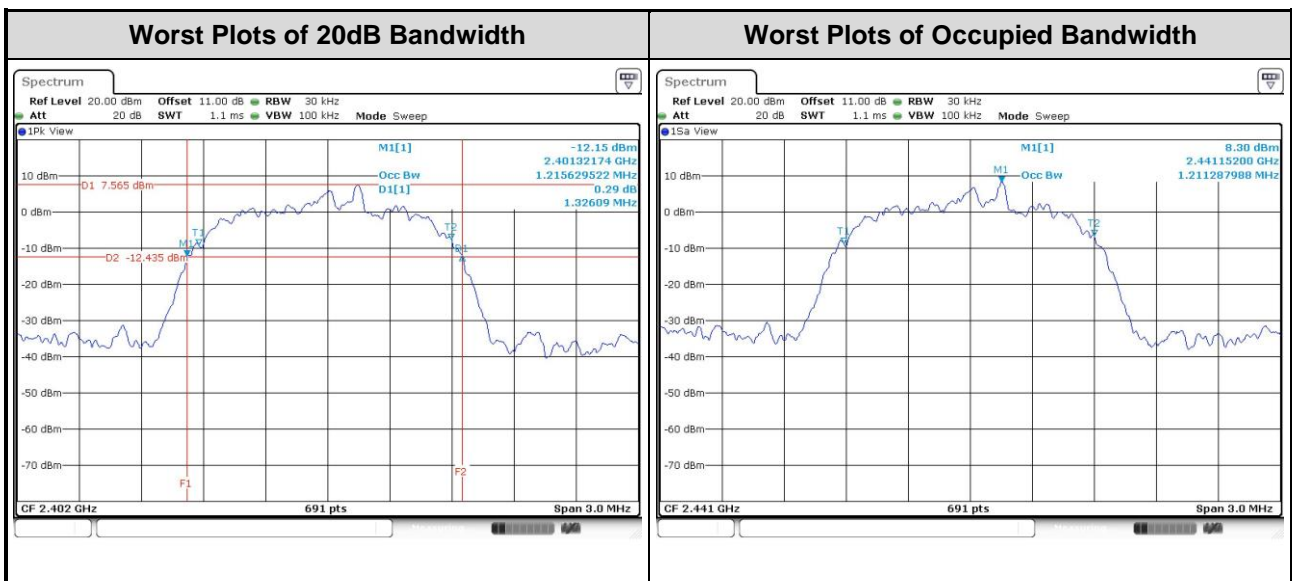

3.7 Channel Separation

3.7.1 Limit of Channel Separation

- Frequency hopping systems shall have hopping channel carrier frequencies separated by a minimum of 25 kHz or the 20 dB bandwidth of the hopping channel, whichever is greater.
- Frequency hopping systems operating in the 2400–2483.5 MHz band may have hopping channel carrier frequencies that are separated by 25 kHz or two-thirds of the 20 dB bandwidth of the hopping channel, whichever is greater.

3.7.2 Test Procedures

1. Set RBW=100kHz, VBW=300kHz, Sweep time = Auto, Detector=Peak Trace max hold
2. Allow trace to stabilize
3. Use the marker-delta function to determine the separation between the peaks of the adjacent channels. The EUT shall show compliance with the appropriate regulatory limit

3.7.3 Test Setup

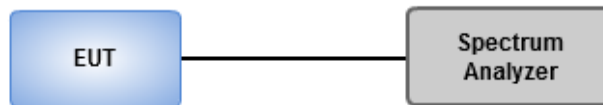

3.7.4 Test result of Channel Separation

| Modulation Mode | Freq. (MHz) | Channel Separation (MHz) | 20dB Bandwidth (MHz) | Minimum Limit (MHz) |
|-----------------|-------------|--------------------------|----------------------|---------------------|
| GFSK | 2402 | 1.003 | 0.952 | 0.635 |
| GFSK | 2441 | 1.003 | 0.952 | 0.635 |
| GFSK | 2480 | 1.003 | 0.948 | 0.632 |
| 8DPSK | 2402 | 1.003 | 1.326 | 0.884 |
| 8DPSK | 2441 | 1.003 | 1.326 | 0.884 |
| 8DPSK | 2480 | 1.003 | 1.326 | 0.884 |

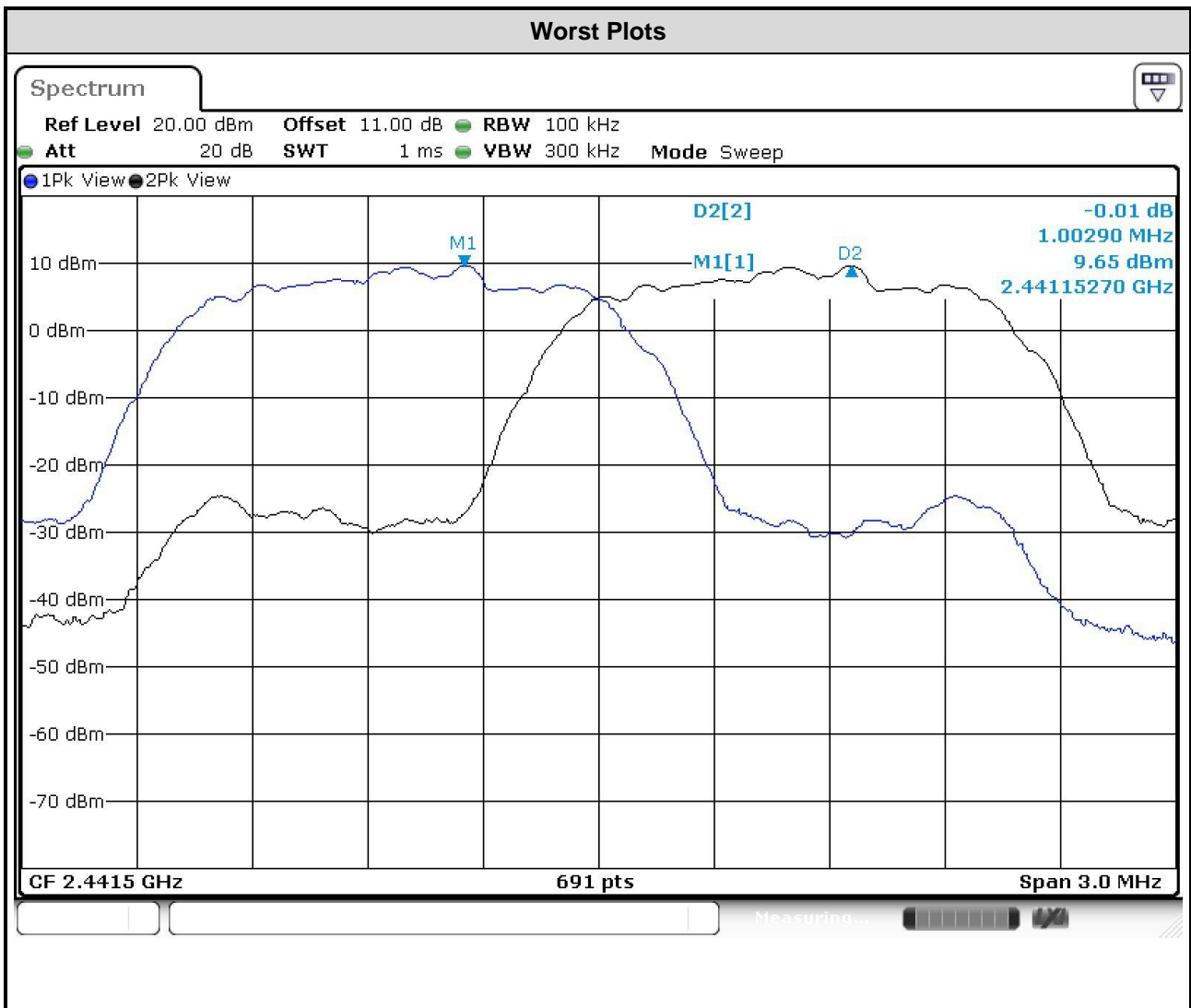

3.8 Number of Dwell Time

3.8.1 Limit of Dwell time

The average time of occupancy on any channel shall not be greater than 0.4 seconds within a period of 0.4 seconds multiplied by the number of hopping channels employed.

3.8.2 Test Procedures

1. Set RBW=100kHz,VBW=300kHz,Sweep time = 500us(DH1),2ms(DH3),4ms(DH5), Detector=Peak, Span=0Hz,Trace max hold
2. Enable gating and trigger function of spectrum analyzer to measure burst on time.
3. The DH1 packet can cover a single time slot. A maximum length packet has duration of 1 time slots. The hopping rate is 1600 hops/second so the maximum dwell time is 1/1600 seconds, or 0.625ms. DH1 Packet permit maximum $1600 / 79 / 2 = 10.12$ hops per second in each channel (1 time slot TX, 1 time slot RX). So, the dwell time is the time duration of the pulse times $10.12 \times 31.6 = 320$ within 31.6 seconds.
4. The DH3 packet can cover up to 3 time slots. A maximum length packet has duration of 3 time slots. The hopping rate is 1600 hops/second so the maximum dwell time is 3/1600 seconds, or 1.875ms. DH3 Packet permit maximum $1600 / 79 / 4 = 5.06$ hops per second in each channel (3 time slots TX, 1 time slot RX). So, the dwell time is the time duration of the pulse times $5.06 \times 31.6 = 160$ within 31.6 seconds.
5. The DH5 packet can cover up to 5 time slots. Operate DH5 at maximum dwell time and maximum duty cycle. A maximum length packet has duration of 5 time slots. The hopping rate is 1600 hops/second so the maximum dwell time is 5/1600 seconds, or 3.125ms. DH5 Packet permit maximum $1600 / 79 / 6 = 3.37$ hops per second in each channel (5 time slots TX, 1 time slot RX). So, the dwell time is the time duration of the pulse times $3.37 \times 31.6 = 106.6$ within 31.6 seconds

3.8.3 Test Setup

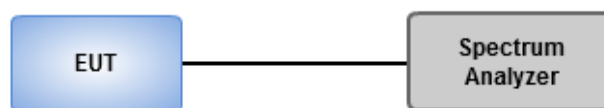

3.8.4 Test Result of Dwell Time

| Modulation Mode | Freq. (MHz) | Length of Transmission Time (msec) | Number of Transmission in a 31.6 (79 Hopping*0.4) | Result (s) | Limit (s) |
|-----------------|-------------|------------------------------------|---|------------|-----------|
| GFSK-DH1 | 2402 | 0.46087 | 320 | 0.147 | 0.4 |
| GFSK-DH3 | 2402 | 1.70464 | 160 | 0.273 | 0.4 |
| GFSK-DH5 | 2402 | 2.95826 | 106.6 | 0.315 | 0.4 |
| 8DPSK-DH1 | 2402 | 0.46522 | 320 | 0.149 | 0.4 |
| 8DPSK-DH3 | 2402 | 1.70232 | 160 | 0.272 | 0.4 |
| 8DPSK-DH5 | 2402 | 3.00812 | 106.6 | 0.321 | 0.4 |

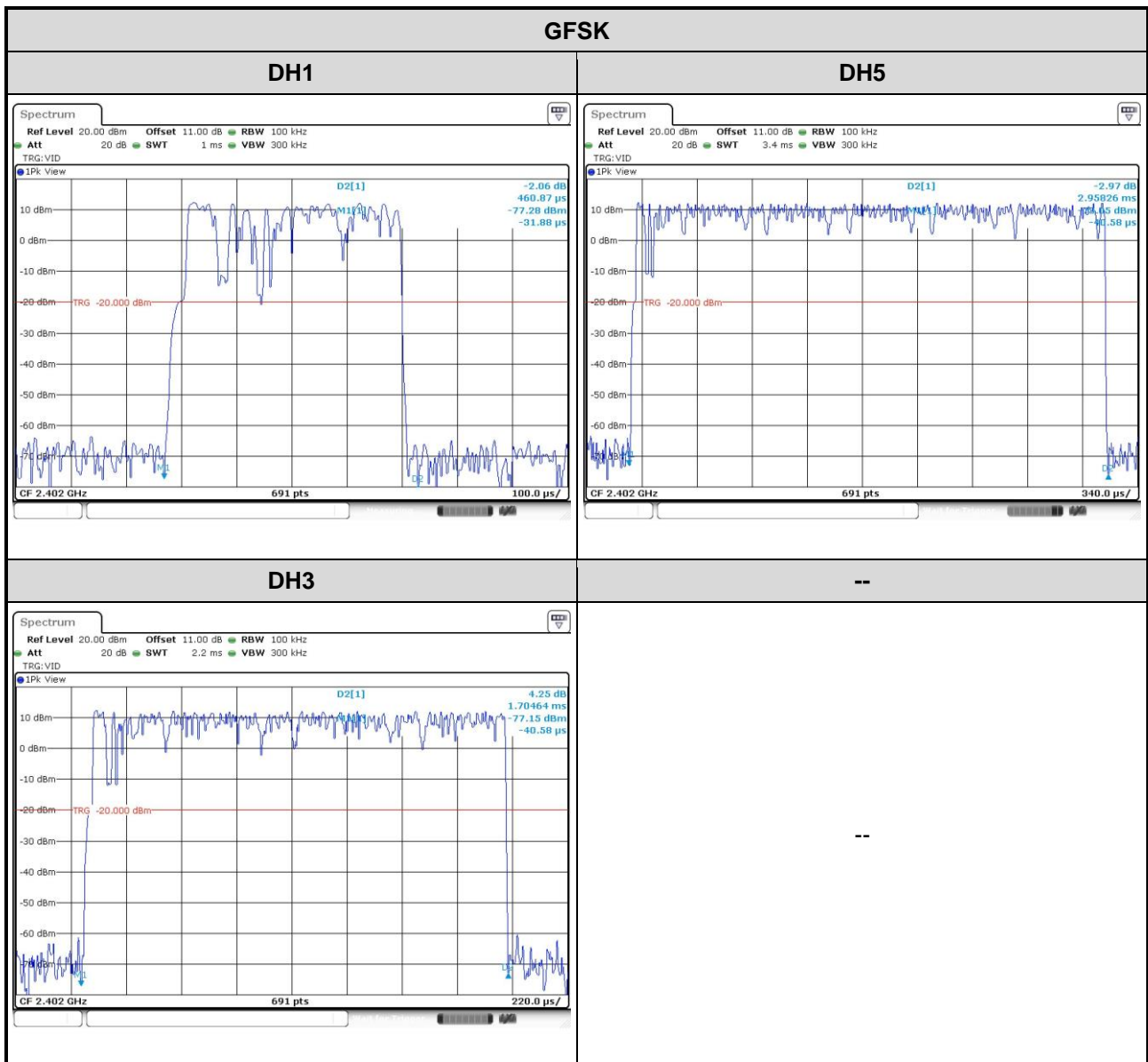

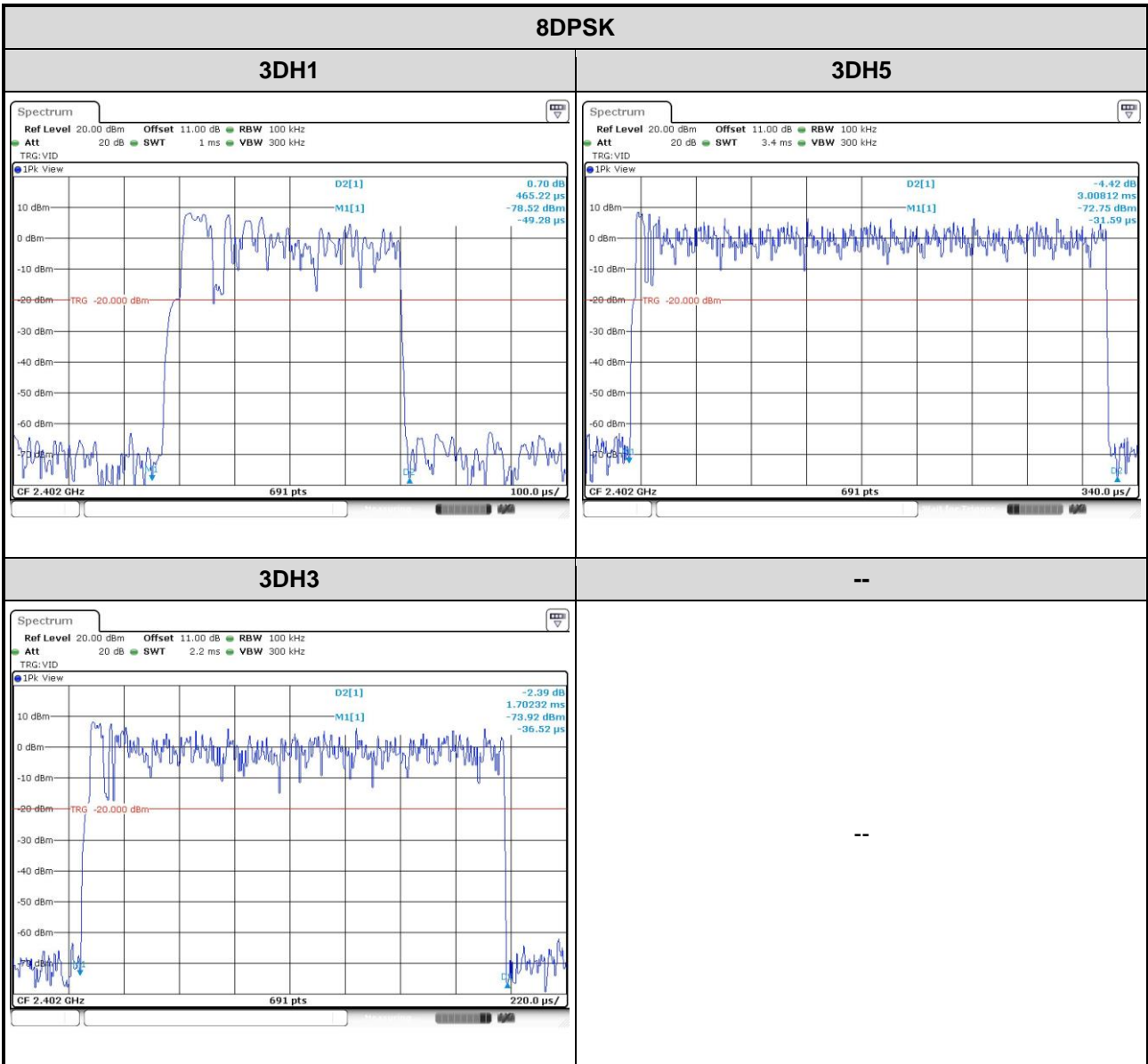

4 Test laboratory information

Established in 2012, ICC provides foremost EMC & RF Testing and advisory consultation services by our skilled engineers and technicians. Our services employ a wide variety of advanced edge test equipment and one of the widest certification extents in the business.

International Certification Corp, it is our definitive objective is to institute long term, trust-based associations with our clients. The expectation we set up with our clients is based on outstanding service, practical expertise and devotion to a certified value structure. Our passion is to grant our clients with best EMC / RF services by oriented knowledgeable and accommodating staff.

Our Test sites are located at Linkou District and Kwei Shan Hsiang. Location map can be found on our website <http://www.icertifi.com.tw>.

Linkou

Tel: 886-2-2601-1640

No. 30-2, Ding Fwu Tsuen, Lin Kou
District, New Taipei City, Taiwan,
R.O.C.

Kwei Shan

Tel: 886-3-271-8666

No. 3-1, Lane 6, Wen San 3rd
St., Kwei Shan Hsiang, Tao Yuan
Hsien 333, Taiwan, R.O.C.

Kwei Shan Site II

Tel: 886-3-271-8640

No. 14-1, Lane 19, Wen San 3rd
St., Kwei Shan Hsiang, Tao Yuan
Hsien 333, Taiwan, R.O.C.

If you have any suggestion, please feel free to contact us as below information

Tel: 886-3-271-8666

Fax: 886-3-318-0155

Email: ICC_Service@icertifi.com.tw

==END==