



International Certification Corp.

No. 3-1, Lane 6, Wen San 3rd St., Kwei Shan Hsiang, Tao Yuan Hsien 333, Taiwan, R.O.C.

Tel: 886-3-271-8666

Fax: 886-3-318-0155

FCC Test Report

FCC ID : NKR-SP1
Equipment : 11abgn WLAN/Bluetooth Combo Module
Model No. : DHUB-SP1
Brand Name : SHARP Corporation
Applicant : Wistron Neweb Corporation
Address : 20 Park Avenue II, Hsinchu Science Park,
Hsinchu 308,Taiwan,R.O.C./
Standard : 47 CFR FCC Part 15.247
Received Date : Aug. 21, 2013
Tested Date : Aug. 22 ~ Sep. 02, 2013

We, International Certification Corp., would like to declare that the tested sample has been evaluated and in compliance with the requirement of the above standards. The test results contained in this report refer exclusively to the product. It may be duplicated completely for legal use with the approval of the applicant. It shall not be reproduced except in full without the written approval of our laboratory.

Approved & Reviewed by:

Gary Chang / Manager



Testing Laboratory
2732



Table of Contents

| | | |
|----------|--|-----------|
| 1 | GENERAL DESCRIPTION | 5 |
| 1.1 | Information..... | 5 |
| 1.2 | Local Support Equipment List | 7 |
| 1.3 | Test Setup Chart | 7 |
| 1.4 | The Equipment List | 8 |
| 1.5 | Test Standards | 10 |
| 1.6 | Measurement Uncertainty | 11 |
| 2 | TEST CONFIGURATION | 12 |
| 2.1 | Testing Condition | 12 |
| 2.2 | The Worst Test Modes and Channel Details | 12 |
| 3 | TRANSMITTER TEST RESULTS..... | 13 |
| 3.1 | Conducted Emissions..... | 13 |
| 3.2 | 6dB and Occupied Bandwidth | 16 |
| 3.3 | RF Output Power | 19 |
| 3.4 | Power Spectral Density | 22 |
| 3.5 | Unwanted Emissions into Restricted Frequency Bands | 24 |
| 3.6 | Emissions in non-restricted frequency bands | 52 |



International Certification Corp.

No. 3-1, Lane 6, Wen San 3rd St., Kwei Shan Hsiang, Tao Yuan Hsien 333, Taiwan, R.O.C.

Tel: 886-3-271-8666

Fax: 886-3-318-0155

Release Record

| Report No. | Version | Description | Issued Date |
|------------|---------|---------------|---------------|
| FR382103AC | Rev. 01 | Initial issue | Sep. 23, 2013 |



Summary of Test Results

| FCC Rules | Test Items | Measured | Result |
|---------------------|-----------------------------------|---|--------|
| 15.207 | Conducted Emissions | [dBuV]: 0.162MHz 44.59 (Margin -10.75dB) - AV | Pass |
| 15.247(d) 15.209 | Radiated Emissions | [dBuV/m at 3m]: 2390.00MHz 73.00 (Margin -1.00dB) – PK 2390.00MHz 53.00 (Margin -1.00dB) – AV | Pass |
| 15.247(b)(3) | Fundamental Emission Output Power | Power [dBm]: 11b: 22.26 11g: 27.23 HT20: 26.77 HT40: 25.05 | Pass |
| 15.247(a)(2) | 6dB Bandwidth | Meet the requirement of limit | Pass |
| 15.247(e) | Power Spectral Density | Meet the requirement of limit | Pass |
| 15.203 | Antenna Requirement | Meet the requirement of limit | Pass |



1 General Description

1.1 Information

1.1.1 Specification of the Equipment under Test (EUT)

| RF General Information | | | | | |
|------------------------|------------------|-----------------|----------------|------------------------------------|-----------------|
| Frequency Range (MHz) | IEEE Std. 802.11 | Ch. Freq. (MHz) | Channel Number | Transmit Chains (N _{TX}) | Data Rate / MCS |
| 2400-2483.5 | b | 2412-2462 | 1-11 [11] | 1 | 1-11 Mbps |
| 2400-2483.5 | g | 2412-2462 | 1-11 [11] | 2 | 6-54 Mbps |
| 2400-2483.5 | n (HT20) | 2412-2462 | 1-11 [11] | 2 | MCS 0-15 |
| 2400-2483.5 | n (HT40) | 2422-2452 | 3-9 [7] | 2 | MCS 0-15 |

Note 1: RF output power specifies that Maximum Peak Conducted Output Power.
 Note 2: 802.11b uses a combination of DSSS-DBPSK, DQPSK, CCK modulation.
 Note 3: 802.11g/n uses a combination of OFDM-BPSK, QPSK, 16QAM, 64QAM modulation.

1.1.2 Antenna Details

| Ant. No. | Model | Type | Connector | Operating Frequencies (MHz) / Antenna Gain (dBi) | | | | |
|----------|---------------|---------|-----------|--|-----------|-----------|-----------|-----------|
| | | | | 2400~2483.5 | 5150~5250 | 5250~5350 | 5470~5725 | 5725~5850 |
| 1 | Left antenna | Printed | N/A | 3.97 | 3.31 | 3.31 | 3.42 | 2.92 |
| 2 | Right antenna | Printed | N/A | 2.2 | 1.11 | 1.27 | 1.66 | 0.34 |

1.1.3 EUT Operational Condition

| | |
|--------------------------|----------------|
| Power Supply Type | 5Vdc from Host |
|--------------------------|----------------|

1.1.4 Accessories

N/A



1.1.5 Channel List

| Frequency band (MHz) | | 2400~2483.5 | |
|-----------------------|----------------|--------------|----------------|
| 802.11 b / g / n HT20 | | 802.11n HT40 | |
| Channel | Frequency(MHz) | Channel | Frequency(MHz) |
| 1 | 2412 | 3 | 2422 |
| 2 | 2417 | 4 | 2427 |
| 3 | 2422 | 5 | 2432 |
| 4 | 2427 | 6 | 2437 |
| 5 | 2432 | 7 | 2442 |
| 6 | 2437 | 8 | 2447 |
| 7 | 2442 | 9 | 2452 |
| 8 | 2447 | --- | --- |
| 9 | 2452 | --- | --- |
| 10 | 2457 | --- | --- |
| 11 | 2462 | --- | --- |

1.1.6 Test Tool and Duty Cycle

| | |
|-------------------------------|---|
| Test tool | Broadcom M Tool, Version 2.0.0.9 |
| Duty Cycle Of Test Signal (%) | 100.00% - IEEE 802.11b 99.31% - IEEE 802.11g 99.63% - IEEE 802.11n (HT20) 98.19% - IEEE 802.11n (HT40) |
| Duty Factor | 0 - IEEE 802.11b 0.03 - IEEE 802.11g 0.02 - IEEE 802.11n (HT20) 0.08 - IEEE 802.11n (HT40) |



1.1.7 Power Setting

| Modulation Mode | Test Frequency (MHz) | Power Set |
|-----------------|----------------------|-----------|
| 11b | 2412 | 64 |
| 11b | 2437 | 70 |
| 11b | 2462 | 71 |
| 11g | 2412 | 45 |
| 11g | 2437 | 63 |
| 11g | 2462 | 48 |
| HT20 | 2412 | 43 |
| HT20 | 2437 | 59 |
| HT20 | 2462 | 45 |
| HT40 | 2422 | 40 |
| HT40 | 2437 | 50 |
| HT40 | 2452 | 42 |

1.2 Local Support Equipment List

| Support Equipment List | | | | | | |
|------------------------|-----------|-------|-------|-----|--------|---|
| No. | Equipment | Brand | Model | S/N | FCC ID | Signal cable / Length (m) |
| 1 | Notebook | DELL | E5420 | --- | DoC | 1. USB, 1.85m shielded w/o core. 2. USB, 1.85m shielded w/o core |

1.3 Test Setup Chart

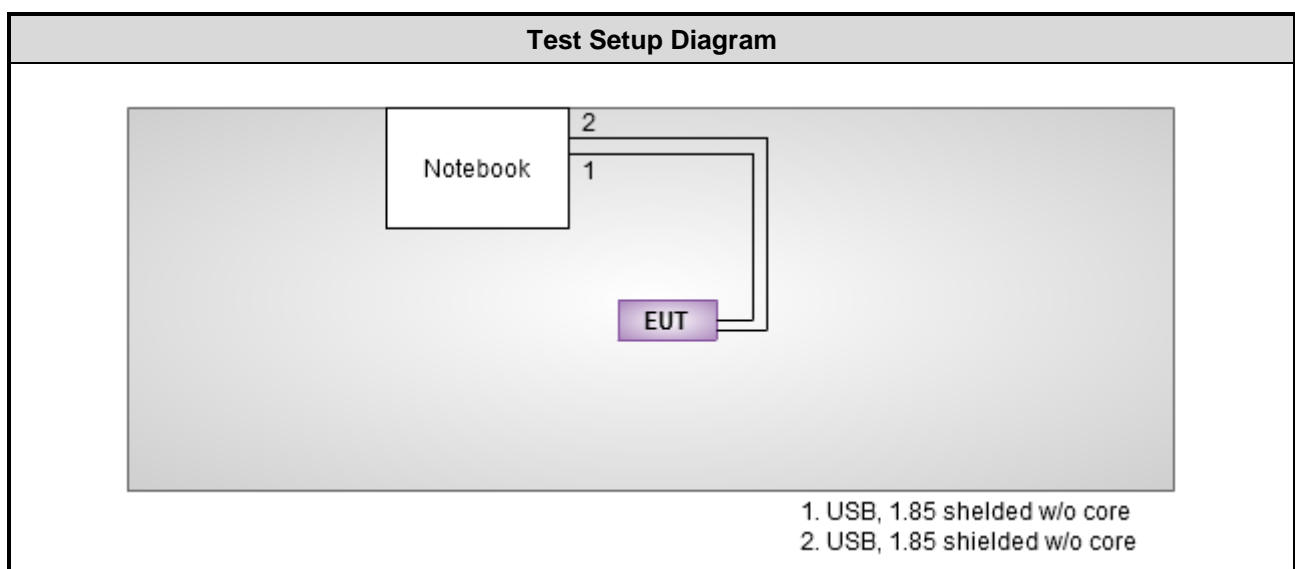



1.4 The Equipment List

| Test Item | Conducted Emission | | | | |
|-----------------------------------|--------------------------------|------------------|---------------|------------------|-------------------|
| Test Site | Conduction room 1 / (CO01-WS) | | | | |
| Instrument | Manufacturer | Model No. | Serial No. | Calibration Date | Calibration Until |
| EMC Receiver | R&S | ESCS 30 | 100169 | Oct. 02, 2012 | Oct. 01, 2013 |
| LISN | SCHWARZBECK MESS-ELEKTRONIK | Schwarzbeck 8127 | 8127-667 | Dec. 04, 2012 | Dec. 03, 2013 |
| LISN (Support Unit) | SCHWARZBECK MESS-ELEKTRONIK | Schwarzbeck 8127 | 8127-666 | Dec. 04, 2012 | Dec. 03, 2013 |
| ISN | TESEQ | ISN T800 | 34406 | Apr. 08, 2013 | Apr. 07, 2014 |
| ISN | TESEQ | ISN T200A | 30494 | Apr. 09, 2013 | Apr. 08, 2014 |
| ISN | TESEQ | ISN T8-Cat6 | 27262 | Sep. 17, 2012 | Sep. 16, 2013 |
| ISN | TESEQ | ISN ST08 | 22589 | Jan. 24, 2013 | Jan. 23, 2014 |
| RF Current Probe | FCC | F-33-4 | 121630 | Dec. 04, 2012 | Dec. 03, 2013 |
| RF Cable-CON | Woken | CFD200-NL | CFD200-NL-001 | Dec. 25, 2012 | Dec. 24, 2013 |
| ESH3-Z6 V-Network(+) | R&S | ESH3-Z6 | 100920 | Nov. 21, 2012 | Nov. 20, 2013 |
| ESH3-Z6 V-Network(-) | R&S | ESH3-Z6 | 100951 | Jan. 30, 2013 | Jan. 29, 2014 |
| Two-Line V-Network | R&S | ENV216 | 101579 | Jan. 07, 2013 | Jan. 06, 2014 |
| 50 ohm terminal | NA | 50 | 01 | Apr. 22, 2013 | Apr. 21, 2014 |
| 50 ohm terminal | NA | 50 | 02 | Apr. 22, 2013 | Apr. 21, 2014 |
| 50 ohm terminal | NA | 50 | 03 | Apr. 22, 2013 | Apr. 21, 2014 |
| 50 ohm terminal (Support Unit) | NA | 50 | 04 | Apr. 22, 2013 | Apr. 21, 2014 |

Note: Calibration Interval of instruments listed above is one year.



| | | | | | |
|---|------------------------------|------------------|-------------------|-------------------------|--------------------------|
| Test Item | Radiated Emission above 1GHz | | | | |
| Test Site | 966 chamber 2 / (03CH02-WS) | | | | |
| Instrument | Manufacturer | Model No. | Serial No. | Calibration Date | Calibration Until |
| 3m semi-anechoic chamber | CHAMPRO | SAC-03 | 03CH02-WS | Jan. 02, 2013 | Jan. 01, 2014 |
| Spectrum Analyzer | R&S | FSV40 | 101499 | Jan. 28, 2013 | Jan. 27, 2014 |
| Receiver | R&S | ESR3 | 101657 | Jan. 30, 2013 | Jan. 29, 2014 |
| Bilog Antenna | Schwarzbeck | VULB9168 | VULB9168-524 | Jan. 11, 2013 | Jan. 10, 2014 |
| Horn Antenna 1G-18G | SCHWARZBECK | BBHA 9120D | BBHA 9120 D 1095 | Jan. 29, 2013 | Jan. 28, 2014 |
| Horn Antenna 18G-40G | SCHWARZBECK | BBHA 9170 | BBHA 9170517 | Jan. 14, 2013 | Jan. 13, 2014 |
| Amplifier | Burgeon | BPA-530 | 100218 | Dec. 14, 2012 | Dec. 13, 2013 |
| Amplifier | Agilent | 83017A | MY39501309 | Dec. 18, 2012 | Dec. 17, 2013 |
| RF Cable | HUBER+SUHNER | SUCOFLEX104 | MY16140/4 | Dec. 25, 2012 | Dec. 24, 2013 |
| RF Cable | HUBER+SUHNER | SUCOFLEX104 | MY16018/4 | Dec. 25, 2012 | Dec. 24, 2013 |
| RF Cable | HUBER+SUHNER | SUCOFLEX104 | MY16015/4 | Dec. 25, 2012 | Dec. 24, 2013 |
| RF Cable-R03m | Woken | CFD400NL-LW | CFD400NL-003 | Dec. 25, 2012 | Dec. 24, 2013 |
| RF Cable-R10m | Woken | CFD400NL-LW | CFD400NL-004 | Dec. 25, 2012 | Dec. 24, 2013 |
| control | EM Electronics | EM1000 | 060608 | N/A | N/A |
| Note: Calibration Interval of instruments listed above is one year. | | | | | |

| | | | | | |
|---|-------|---------------|---------|---------------|---------------|
| Loop Antenna | R&S | HFH2-Z2 | 100330 | Nov. 15, 2012 | Nov. 14, 2014 |
| Amplifier | MITEQ | AMF-6F-260400 | 9121372 | Apr. 19, 2013 | Apr. 18, 2015 |
| Note: Calibration Interval of instruments listed above is two year. | | | | | |



| Test Item | RF Conducted | | | | |
|-------------------------------------|--------------|------------------|-------------|------------------|-------------------|
| Test Site | (TH01-WS) | | | | |
| Instrument | Manufacturer | Model No. | Serial No. | Calibration Date | Calibration Until |
| Spectrum Analyzer | R&S | FSV 40 | 101063 | Feb. 18, 2013 | Feb. 17, 2014 |
| TEMP&HUMIDITY CHAMBER | GIANT FORCE | GCT-225-40-SP-SD | MAF1212-002 | Nov. 29, 2012 | Nov. 28, 2013 |
| Power Meter | Anritsu | ML2495A | 1241002 | Oct. 15, 2012 | Oct. 14, 2013 |
| Power Sensor | Anritsu | MA2411B | 1027366 | Oct. 24, 2012 | Oct. 23, 2013 |
| Signal Generator | R&S | SMB100A | 175727 | Jan. 14, 2013 | Jan. 13, 2014 |
| Radio Communication Analyzer | Anritsu | MT8820C | 6201240341 | Mar. 13, 2013 | Mar. 12, 2014 |
| Wideband Radio Communication Tester | R&S | CMW500 | 106070 | Jan. 29, 2013 | Jan. 28, 2014 |
| Bluetooth Tester | R&S | CBT | 100959 | Jan. 09, 2013 | Jan. 08, 2014 |
| MXG-B RF Vector Signal Generator | Agilent | N5182B | MY53050081 | Apr. 19, 2013 | Apr. 18, 2014 |
| Mobile WiMAX test set | Agilent | E6651A | MY47310158 | Oct. 09 ,2012 | Oct .09 , 2013 |

Note: Calibration Interval of instruments listed above is one year.

1.5 Test Standards

According to the specification of EUT, the EUT must comply with following standards and KDB documents.

47 CFR FCC Part 15.247

ANSI C63.10-2009

FCC KDB 558074 D01 DTS Meas Guidance v03r01

FCC KDB 662911 D01 Multiple Transmitter Output v02

Note: The EUT has been tested and complied with FCC part 15B requirement. FCC Part 15B test results are issued to another report.



1.6 Measurement Uncertainty

ISO/IEC 17025 requires that an estimate of the measurement uncertainties associated with the emissions test results be included in the report. The measurement uncertainties given below are based on a 95% confidence level (based on a coverage factor (k=2))

| Measurement Uncertainty | |
|-------------------------|-------------|
| Parameters | Uncertainty |
| Bandwidth | ±35.286 Hz |
| Conducted power | ±0.536 dB |
| Frequency error | ±35.286 Hz |
| Temperature | ±0.3 °C |
| Conducted emission | ±2.946 dB |
| AC conducted emission | ±2.43 dB |
| Radiated emission | ±2.49 dB |



2 Test Configuration

2.1 Testing Condition

| Test Item | Test Site | Ambient Condition | Tested By |
|--------------------|-----------|--------------------------|----------------------------|
| AC Conduction | CO01-WS | 23°C / 55% | Skys Huang |
| Radiated Emissions | 03CH02-WS | 24°C / 67% 26°C / 64% | Anderson Hong Mark Liao |
| RF Conducted | TH01-WS | 24°C / 63% | Felix Sung |

➤ FCC site registration No.: 657002

➤ IC site registration No.: 10807A-2

2.2 The Worst Test Modes and Channel Details

| Test item | Modulation Mode | Test Frequency (MHz) | Data rate (Mbps) / MCS | Test Configuration |
|-----------------------------------|-----------------|----------------------|------------------------|--------------------|
| Conducted Emissions | 11g | 2437 | MCS 0 | --- |
| Radiated Emissions (below 1GHz) | 11g | 2437 | MCS 0 | --- |
| Radiated Emissions (above 1GHz) | 11b | 2412 / 2437 / 2462 | 1 | --- |
| | 11g | 2412 / 2437 / 2462 | 6 | |
| | HT20 | 2412 / 2437 / 2462 | MCS 0 | |
| | HT40 | 2422 / 2437 / 2452 | MCS 0 | |
| Fundamental Emission Output Power | 11b | 2412 / 2437 / 2462 | 1 | --- |
| 6dB bandwidth | 11g | 2412 / 2437 / 2462 | 6 | |
| Power spectral density | HT20 | 2412 / 2437 / 2462 | MCS 0 | |
| | HT40 | 2422 / 2437 / 2452 | MCS 0 | |

NOTE:

- The EUT was pretested with 3 orientations placed on the table for the radiated emission measurement – X, Y, and Z-plane. The **Y-plane** results were found as the worst case and were shown in this report.



3 Transmitter Test Results

3.1 Conducted Emissions

3.1.1 Limit of Conducted Emissions

| Conducted Emissions Limit | | |
|---------------------------|------------|-----------|
| Frequency Emission (MHz) | Quasi-Peak | Average |
| 0.15-0.5 | 66 - 56 * | 56 - 46 * |
| 0.5-5 | 56 | 46 |
| 5-30 | 60 | 50 |

Note 1: * Decreases with the logarithm of the frequency.

3.1.2 Test Procedures

1. The device is placed on a test table, raised 80 cm above the reference ground plane. The vertical conducting plane is located 40 cm to the rear of the device.
2. The device is connected to line impedance stabilization network (LISN) and other accessories are connected to other LISN. Measured levels of AC power line conducted emission are across the 50 Ω LISN port.
3. AC conducted emission measurements is made over frequency range from 150 kHz to 30 MHz.
4. This measurement was performed with AC 120V / 60Hz.

3.1.3 Test Setup

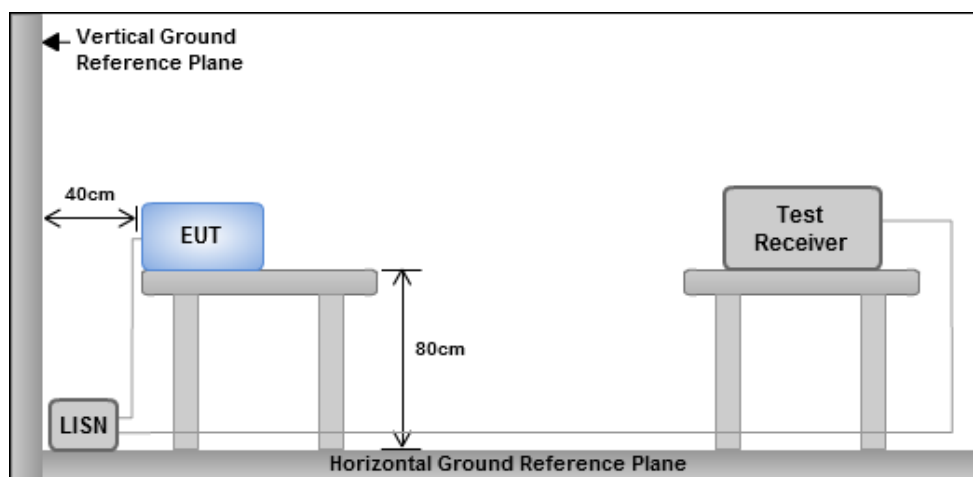

Note: 1. Support units were connected to second LISN.

2. Both of LISNs (AMN) are 80 cm from EUT and at least 80 cm from other units and other metal planes



3.1.4 Test Result of Conducted Emissions

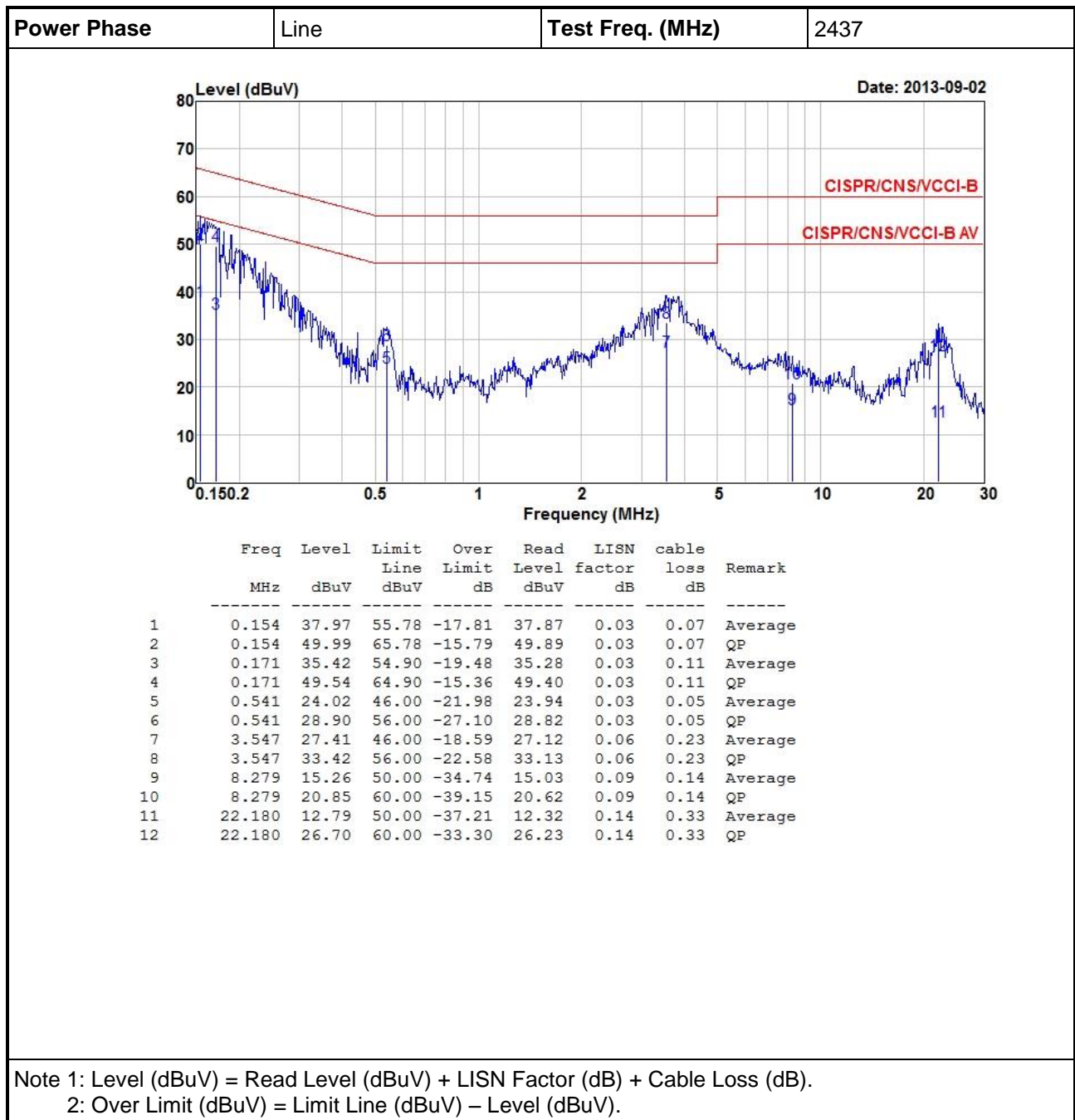

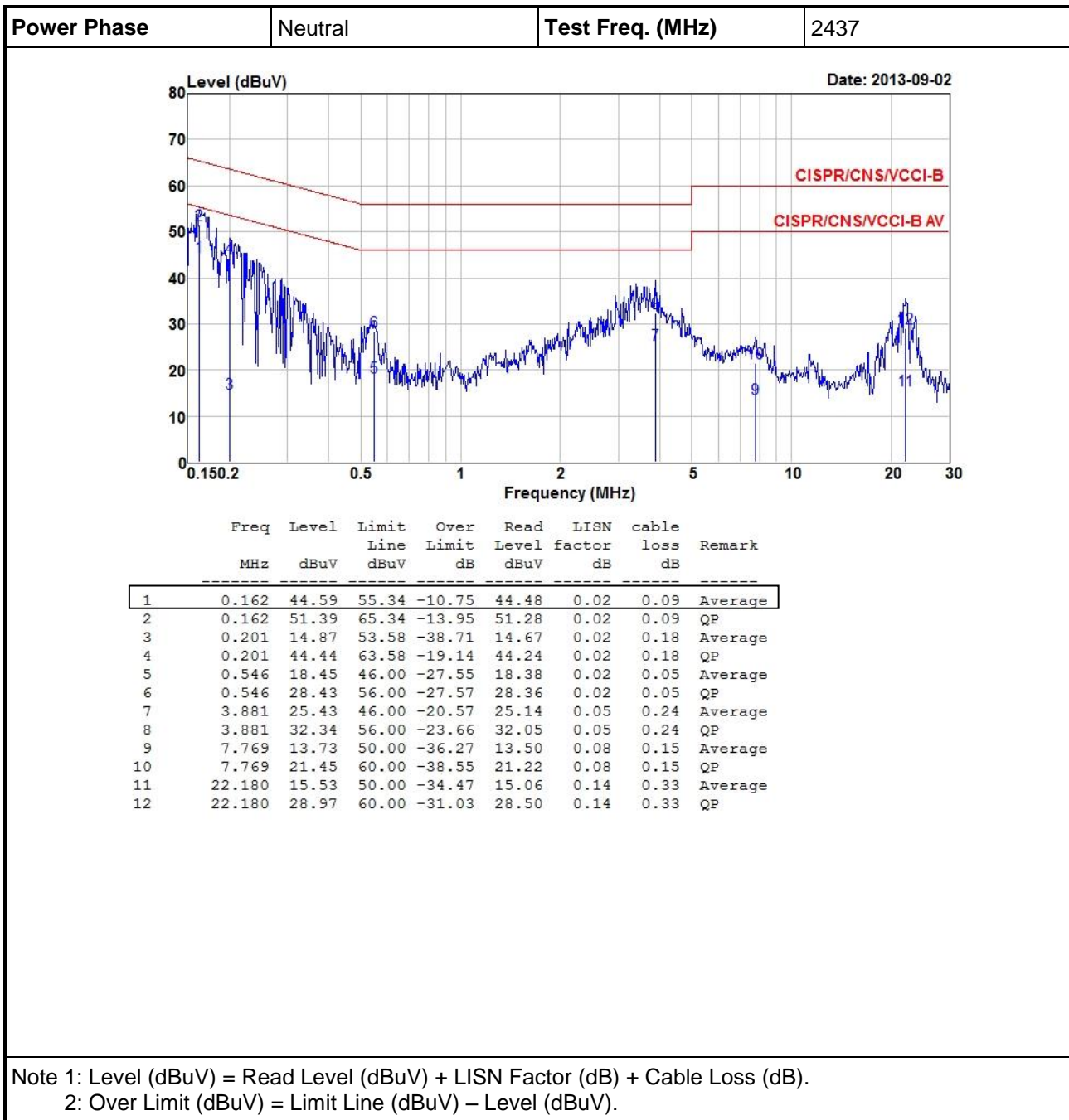



3.2 6dB and Occupied Bandwidth

3.2.1 Limit of 6dB Bandwidth

The minimum 6dB bandwidth shall be at least 500 kHz.

3.2.2 Test Procedures

1. Set resolution bandwidth (RBW) = 100 kHz, Video bandwidth = 300 kHz.
2. Detector = Peak, Trace mode = max hold.
3. Sweep = auto couple, Allow the trace to stabilize.
4. Measure the maximum width of the emission that is constrained by the frequencies associated with the two outermost amplitude points (upper and lower) that are attenuated by 6dB relative to the maximum level measured in the fundamental emission.

3.2.3 Test Setup

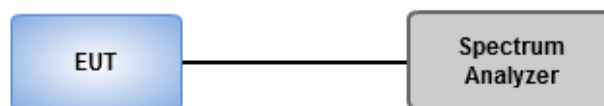



3.2.4 Test Result of 6dB and Occupied Bandwidth

| Modulation Mode | N _{TX} | Freq. (MHz) | 6dB Bandwidth (MHz) | | | | Limit (kHz) |
|-----------------|-----------------|-------------|---------------------|---------|---------|---------|-------------|
| | | | Chain 0 | Chain 1 | Chain 2 | Chain 3 | |
| 11b | 1 | 2412 | 8.06 | --- | --- | --- | 500 |
| 11b | 1 | 2437 | 8.06 | --- | --- | --- | 500 |
| 11b | 1 | 2462 | 8.06 | --- | --- | --- | 500 |
| 11g | 2 | 2412 | 15.07 | 13.86 | --- | --- | 500 |
| 11g | 2 | 2437 | 15.13 | 15.30 | --- | --- | 500 |
| 11g | 2 | 2462 | 15.94 | 15.13 | --- | --- | 500 |
| HT20 | 2 | 2412 | 15.07 | 17.57 | --- | --- | 500 |
| HT20 | 2 | 2437 | 15.13 | 15.65 | --- | --- | 500 |
| HT20 | 2 | 2462 | 17.57 | 14.72 | --- | --- | 500 |
| HT40 | 2 | 2422 | 35.13 | 35.13 | --- | --- | 500 |
| HT40 | 2 | 2437 | 35.25 | 35.13 | --- | --- | 500 |
| HT40 | 2 | 2452 | 35.13 | 35.13 | --- | --- | 500 |

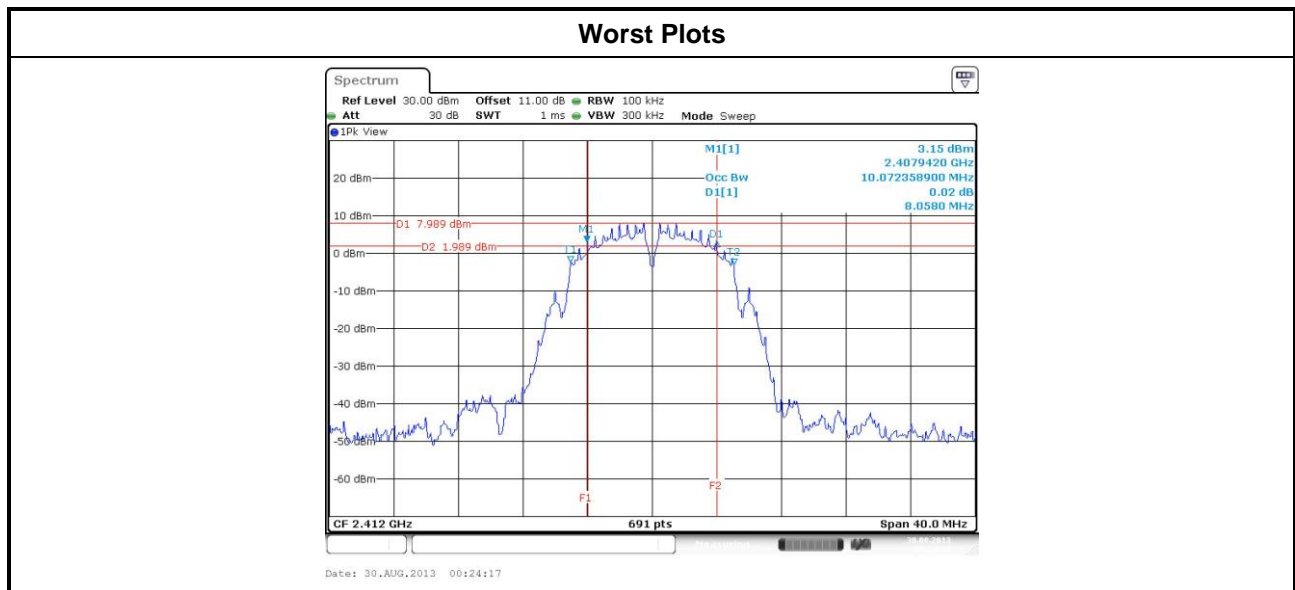



| Modulation Mode | N _{TX} | Freq. (MHz) | 99% Occupied Bandwidth (MHz) | | | |
|-----------------|-----------------|-------------|------------------------------|---------|---------|---------|
| | | | Chain 0 | Chain 1 | Chain 2 | Chain 3 |
| 11b | 1 | 2412 | 10.19 | --- | --- | --- |
| 11b | 1 | 2437 | 10.25 | --- | --- | --- |
| 11b | 1 | 2462 | 10.25 | --- | --- | --- |
| 11g | 2 | 2412 | 16.61 | 16.50 | --- | --- |
| 11g | 2 | 2437 | 16.90 | 16.79 | --- | --- |
| 11g | 2 | 2462 | 16.61 | 16.50 | --- | --- |
| HT20 | 2 | 2412 | 17.66 | 17.60 | --- | --- |
| HT20 | 2 | 2437 | 17.77 | 17.66 | --- | --- |
| HT20 | 2 | 2462 | 17.66 | 17.60 | --- | --- |
| HT40 | 2 | 2422 | 35.66 | 35.66 | --- | --- |
| HT40 | 2 | 2437 | 35.77 | 35.77 | --- | --- |
| HT40 | 2 | 2452 | 35.66 | 35.66 | --- | --- |

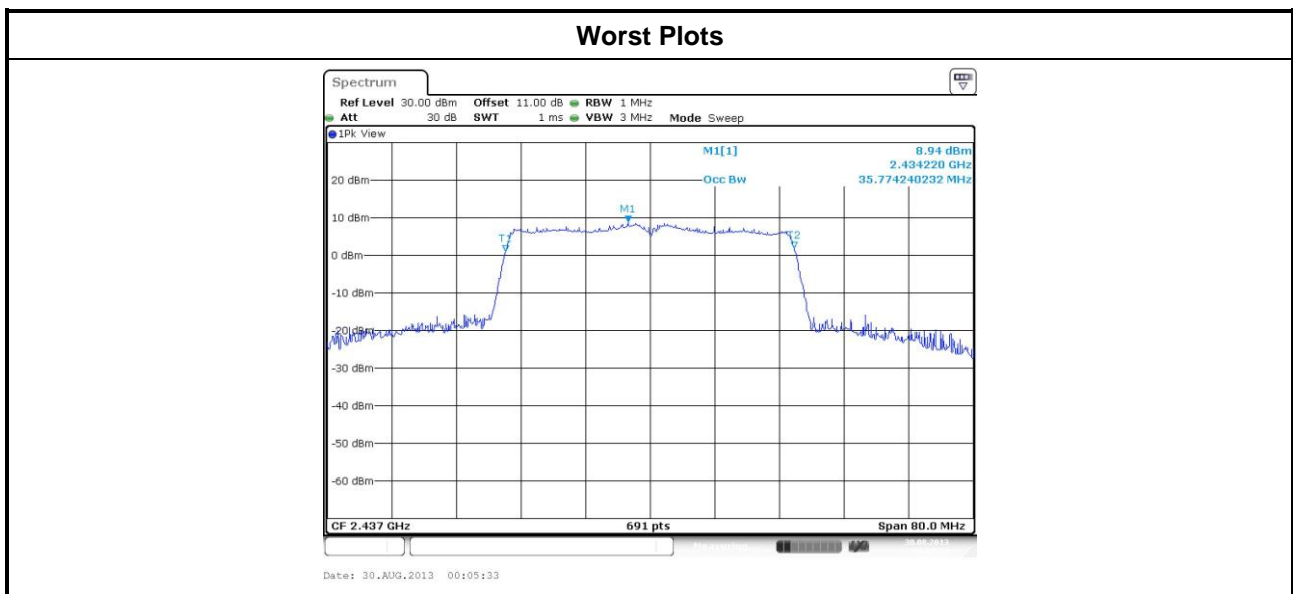



3.3 RF Output Power

3.3.1 Limit of RF Output Power

Conducted power shall not exceed 1Watt.

- Antenna gain \leq 6dBi, no any corresponding reduction is in output power limit.
- Antenna gain $>$ 6dBi
 - Non Fixed, point to point operations.
The conducted output power from the intentional radiator shall be reduced by the amount in dB that the directional gain of the antenna exceeds 6 dB
 - Fixed, point to point operations
Systems operating in the 2400–2483.5 MHz band that are used exclusively for fixed, point-to-point Operations, maximum peak output power of the intentional radiator is reduced by 1 dB for every 3 dB that the directional gain of the antenna exceeds 6 dBi.

Systems operating in the 5725–5850 MHz band that are used exclusively for fixed, point-to-point operations ,no any corresponding reduction is in transmitter peak output power

3.3.2 Test Procedures

- Maximum Peak Conducted Output Power
 - Spectrum analyzer**
 1. Set RBW = 1MHz, VBW = 3MHz, Detector = Peak.
 2. Sweep time = auto, Trace mode = max hold, Allow trace to fully stabilize.
 3. Use the spectrum analyzer channel power measurement function with the band limits set equal to the DTS bandwidth edges.
 - Power meter**
 1. A broadband Peak RF power meter is used for output power measurement. The video bandwidth of power meter is greater than DTS bandwidth of EUT. If duty cycle of test signal is not 100 %, trigger and gating function of power meter will be enabled to capture transmission burst for measuring output power.
- Maximum Conducted Output Power (For reference only)
 - Spectrum analyzer**
 1. Set RBW = 1MHz, VBW = 3MHz, Detector = RMS.
 2. Set the sweep time to: $\geq 10 \times$ (number of measurement points in sweep) \times (maximum data rate per stream).
 3. Perform the measurement over a single sweep.
 4. Use the spectrum analyzer's band power measurement function with band limits set equal to the EBW(26dBc) band edges.
 - Power meter**
 1. A broadband Average RF power meter is used for output power measurement. The video bandwidth of power meter is greater than DTS bandwidth of EUT. If duty cycle of test signal is not 100 %, trigger and gating function of power meter will be enabled to capture transmission burst for measuring output power.



3.3.3 Test Setup

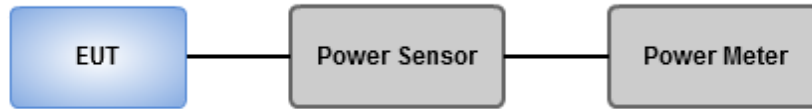



3.3.4 Test Result of Maximum Output Power

| Modulation Mode | N _{TX} | Freq. (MHz) | Peak conducted output power (dBm) | | | | Total Power (mW) | Total Power (dBm) | Limit (dBm) |
|-----------------|-----------------|-------------|-----------------------------------|---------|---------|---------|------------------|-------------------|-------------|
| | | | Chain 0 | Chain 1 | Chain 2 | Chain 3 | | | |
| 11b | 1 | 2412 | 20.19 | --- | --- | --- | 104.47 | 20.19 | 30 |
| 11b | 1 | 2437 | 22.26 | --- | --- | --- | 168.27 | 22.26 | 30 |
| 11b | 1 | 2462 | 21.90 | --- | --- | --- | 154.88 | 21.90 | 30 |
| 11g | 2 | 2412 | 21.48 | 21.21 | --- | --- | 272.73 | 24.36 | 30 |
| 11g | 2 | 2437 | 24.52 | 23.89 | --- | --- | 528.05 | 27.23 | 30 |
| 11g | 2 | 2462 | 22.20 | 21.59 | --- | --- | 310.17 | 24.92 | 30 |
| HT20 | 2 | 2412 | 21.06 | 20.83 | --- | --- | 248.70 | 23.96 | 30 |
| HT20 | 2 | 2437 | 24.14 | 23.34 | --- | --- | 475.19 | 26.77 | 30 |
| HT20 | 2 | 2462 | 21.38 | 21.19 | --- | --- | 268.93 | 24.30 | 30 |
| HT40 | 2 | 2422 | 20.41 | 19.28 | --- | --- | 194.62 | 22.89 | 30 |
| HT40 | 2 | 2437 | 22.15 | 21.92 | --- | --- | 319.66 | 25.05 | 30 |
| HT40 | 2 | 2452 | 20.58 | 20.23 | --- | --- | 219.73 | 23.42 | 30 |

| Modulation Mode | N _{TX} | Freq. (MHz) | Conducted (average) output power (dBm) | | | | Total Power (mW) | Total Power (dBm) | Limit (dBm) |
|-----------------|-----------------|-------------|--|---------|---------|---------|------------------|-------------------|-------------|
| | | | Chain 0 | Chain 1 | Chain 2 | Chain 3 | | | |
| 11b | 1 | 2412 | 16.64 | --- | --- | --- | 46.13 | 16.64 | 30 |
| 11b | 1 | 2437 | 18.70 | --- | --- | --- | 74.13 | 18.70 | 30 |
| 11b | 1 | 2462 | 18.42 | --- | --- | --- | 69.50 | 18.42 | 30 |
| 11g | 2 | 2412 | 12.78 | 12.51 | --- | --- | 36.79 | 15.66 | 30 |
| 11g | 2 | 2437 | 17.68 | 16.50 | --- | --- | 103.28 | 20.14 | 30 |
| 11g | 2 | 2462 | 13.65 | 12.89 | --- | --- | 42.63 | 16.30 | 30 |
| HT20 | 2 | 2412 | 12.26 | 11.94 | --- | --- | 32.46 | 15.11 | 30 |
| HT20 | 2 | 2437 | 16.65 | 15.89 | --- | --- | 85.05 | 19.30 | 30 |
| HT20 | 2 | 2462 | 12.52 | 12.40 | --- | --- | 35.24 | 15.47 | 30 |
| HT40 | 2 | 2422 | 11.56 | 10.89 | --- | --- | 26.60 | 14.25 | 30 |
| HT40 | 2 | 2437 | 13.89 | 13.54 | --- | --- | 47.09 | 16.73 | 30 |
| HT40 | 2 | 2452 | 11.65 | 11.28 | --- | --- | 28.05 | 14.48 | 30 |

Note: Conducted average output power is for reference only.



3.4 Power Spectral Density

3.4.1 Limit of Power Spectral Density

Power spectral density shall not be greater than 8 dBm in any 3 kHz band.

3.4.2 Test Procedures

- Maximum peak conducted output power was used to demonstrate compliance to the fundamental output power limit.
 1. Set the RBW = 30kHz, VBW = 100kHz.
 2. Detector = Peak, Sweep time = auto couple.
 3. Trace mode = max hold, allow trace to fully stabilize.
 4. Use the peak marker function to determine the maximum amplitude level.
- Maximum (average) conducted output power was used to demonstrate compliance to the fundamental output power limit.
 1. Set the RBW = 100kHz, VBW = 300 kHz.
 2. Detector = RMS, Sweep time = auto couple.
 3. Set the sweep time to: $\geq 10 \times (\text{number of measurement points in sweep}) \times (\text{maximum data rate per stream})$.
 4. Perform the measurement over a single sweep.
 5. Use the peak marker function to determine the maximum amplitude level.\

3.4.3 Test Setup

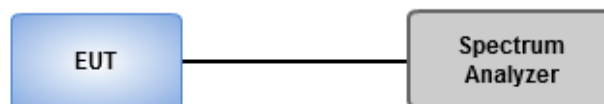



3.4.4 Test Result of Power Spectral Density

| Modulation Mode | N _{TX} | Freq. (MHz) | Total Power Spectral Density (dBm/30kHz) | Limit (dBm/3kHz) |
|-----------------|-----------------|-------------|--|------------------|
| 11b | 1 | 2412 | 4.62 | 7.86 |
| 11b | 1 | 2437 | 6.00 | 7.86 |
| 11b | 1 | 2462 | 5.47 | 7.86 |
| 11g | 2 | 2412 | 1.14 | 7.86 |
| 11g | 2 | 2437 | 5.21 | 7.86 |
| 11g | 2 | 2462 | 1.78 | 7.86 |
| HT20 | 2 | 2412 | 0.18 | 7.86 |
| HT20 | 2 | 2437 | 4.22 | 7.86 |
| HT20 | 2 | 2462 | 1.21 | 7.86 |
| HT40 | 2 | 2422 | -4.67 | 7.86 |
| HT40 | 2 | 2437 | -1.57 | 7.86 |
| HT40 | 2 | 2452 | -3.80 | 7.86 |

Note:

1. Test result for 11g / HT20 / HT40 is bin-by-bin summing measured value of each TX port.
2. Directional gain = $10 * \log((10^{3.97/20} + 10^{2.27/20})^2 / 2) = 6.14\text{dBi} > 6\text{dBi}$
Limit shall be reduced to 8 dBm – (6.14 dBi – 6 dBi) = 7.86 dBm

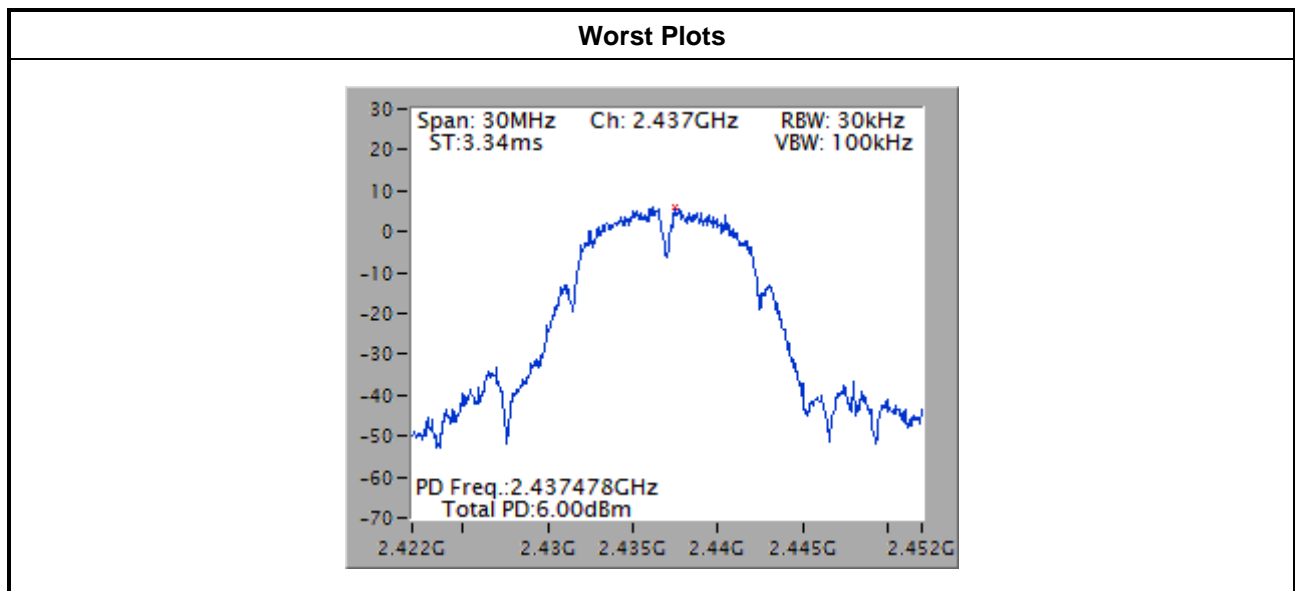



3.5 Unwanted Emissions into Restricted Frequency Bands

3.5.1 Limit of Unwanted Emissions into Restricted Frequency Bands

| Restricted Band Emissions Limit | | | |
|---------------------------------|-----------------------|-------------------------|----------------------|
| Frequency Range (MHz) | Field Strength (uV/m) | Field Strength (dBuV/m) | Measure Distance (m) |
| 0.009~0.490 | 2400/F(kHz) | 48.5 - 13.8 | 300 |
| 0.490~1.705 | 24000/F(kHz) | 33.8 - 23 | 30 |
| 1.705~30.0 | 30 | 29 | 30 |
| 30~88 | 100 | 40 | 3 |
| 88~216 | 150 | 43.5 | 3 |
| 216~960 | 200 | 46 | 3 |
| Above 960 | 500 | 54 | 3 |

Note 1:
Qusai-Peak value is measured for frequency below 1GHz except for 9–90 kHz, 110–490 kHz frequency band. Peak and average value are measured for frequency above 1GHz. The limit on average radio frequency emission is as above table. The limit on peak radio frequency emissions is 20 dB above the maximum permitted average emission limit

Note 2:
Measurements may be performed at a distance other than what is specified provided. When performing measurements at a distance other than that specified, the results shall be extrapolated to the specified distance using an extrapolation factor as below, Frequency at or above 30 MHz: 20 dB/decade Frequency below 30 MHz: 40 dB/decade.

3.5.2 Test Procedures

1. Measurement is made at a semi-anechoic chamber that incorporates a turntable allowing a EUT rotation of 360°. A continuously-rotating, remotely-controlled turntable is installed at the test site to support the EUT and facilitate determination of the direction of maximum radiation for each EUT emission frequency. The EUT is placed at a height of 0.8 m test table above the ground plane.
2. Measurement is made with the antenna positioned in both the horizontal and vertical planes of polarization. The measurement antenna is varied in height (1m ~ 4m) above the reference ground plane to obtain the maximum signal strength. Distance between EUT and antenna is 3 m.
3. This investigation is performed with the EUT rotated 360°, the antenna height scanned between 1 m and 4 m, and the antenna rotated to repeat the measurements for both the horizontal and vertical antenna polarizations.

Note:

1. 120kHz measurement bandwidth of test receiver and Quasi-peak detector is for radiated emission below 1GHz.
2. RBW=1MHz, VBW=3MHz and Peak detector is for peak measured value of radiated emission above 1GHz.
3. RBW=1MHz, VBW=1/T and Peak detector is for average measured value of radiated emission above 1GHz.



3.5.3 Test Setup

Radiated Emissions below 1 GHz

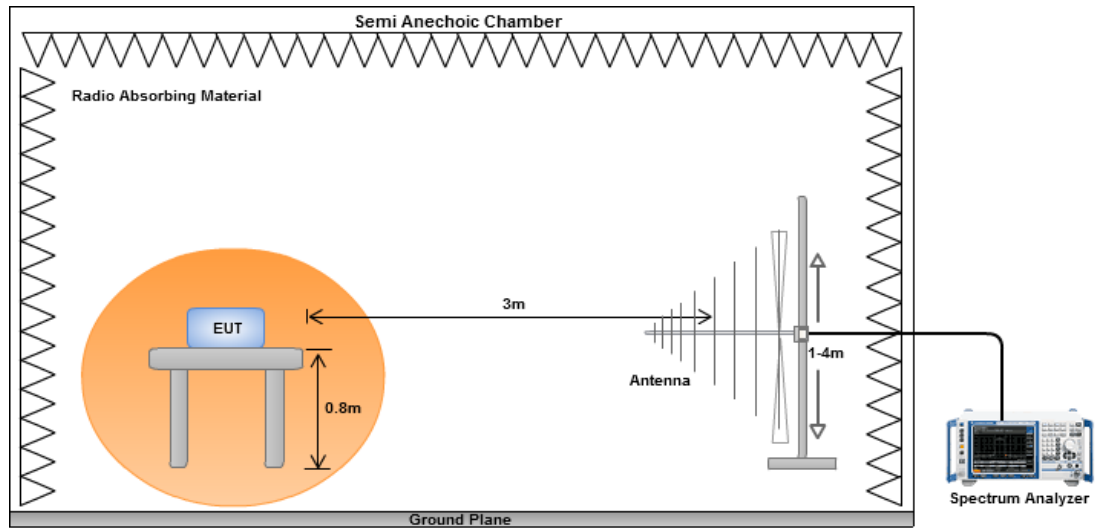

Radiated Emissions above 1 GHz

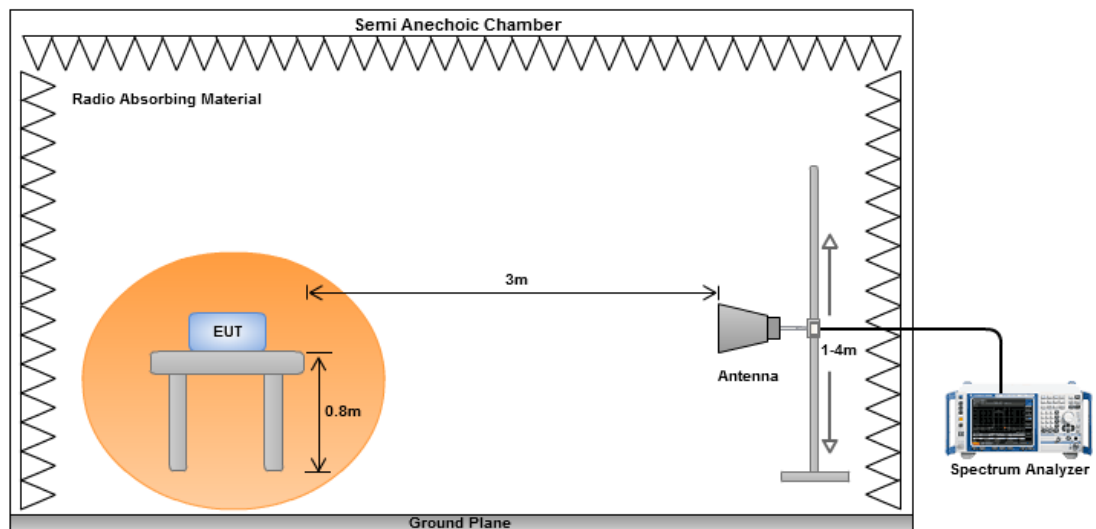



3.5.4 Transmitter Radiated Unwanted Emissions (Below 1GHz)

| Polarization | Horizontal | | | Test Freq. (MHz) | 2437 | | | | |
|--------------|------------|----------------|--------|------------------|------------|--------|--------|-------------|----------------|
| | | | | | | | | | |
| | Freq. | Emission level | Limit | Margin | SA reading | Factor | Remark | ANT High cm | Turn Table deg |
| | MHz | dBuV/m | dBuV/m | dB | dBuV | dB | | | |
| 1 | 54.25 | 36.92 | 40.00 | -3.08 | 53.17 | -16.25 | Peak | --- | --- |
| 2 | 158.04 | 34.52 | 43.50 | -8.98 | 50.86 | -16.34 | Peak | --- | --- |
| 3 | 239.52 | 33.56 | 46.00 | -12.44 | 51.07 | -17.51 | Peak | --- | --- |
| 4 | 474.26 | 35.52 | 46.00 | -10.48 | 46.90 | -11.38 | Peak | --- | --- |
| 5 | 795.33 | 43.16 | 46.00 | -2.84 | 49.29 | -6.13 | Peak | --- | --- |
| 6 | 899.12 | 42.08 | 46.00 | -3.92 | 47.01 | -4.93 | Peak | --- | --- |

Note 1: Emission Level (dBuV/m) = SA Reading (dBuV/m) + Factor* (dB)

*Factor includes antenna factor , cable loss and amplifier gain

Note 2: Margin (dB) = Emission level (dBuV/m) – Limit (dBuV/m).



| | | | |
|---------------------|----------|-------------------------|------|
| Polarization | Vertical | Test Freq. (MHz) | 2437 |
|---------------------|----------|-------------------------|------|

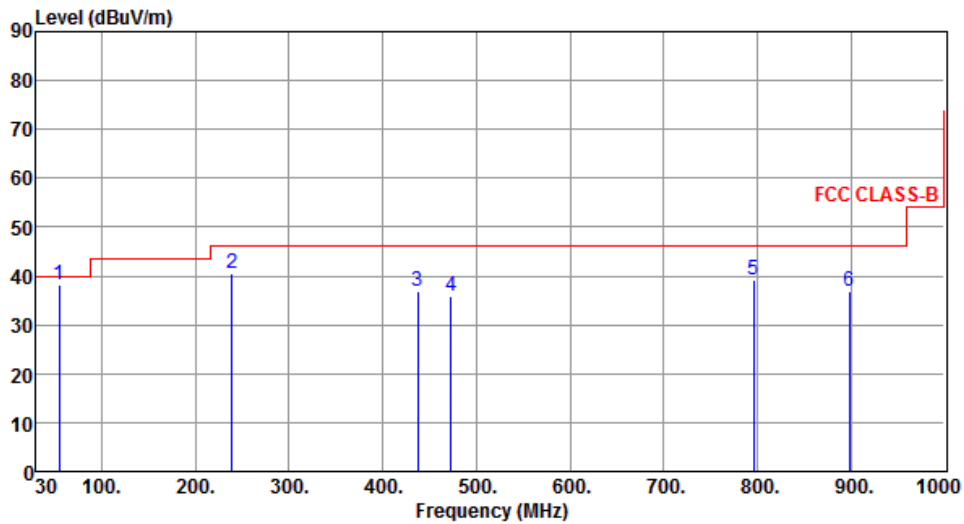

| | Freq. MHz | Emission level dBuV/m | Limit dBuV/m | Margin dB | SA reading dBuV | Factor dB | Remark | ANT High cm | Turn Table deg |
|---|--------------|-----------------------------|-----------------|--------------|-----------------------|--------------|--------|-------------------|----------------------|
| 1 | 54.25 | 38.11 | 40.00 | -1.89 | 54.36 | -16.25 | Peak | --- | --- |
| 2 | 239.52 | 40.66 | 46.00 | -5.34 | 58.17 | -17.51 | Peak | --- | --- |
| 3 | 437.40 | 36.94 | 46.00 | -9.06 | 49.05 | -12.11 | Peak | --- | --- |
| 4 | 473.29 | 35.79 | 46.00 | -10.21 | 47.18 | -11.39 | Peak | --- | --- |
| 5 | 796.30 | 39.08 | 46.00 | -6.92 | 45.20 | -6.12 | Peak | --- | --- |
| 6 | 898.15 | 37.02 | 46.00 | -8.98 | 41.96 | -4.94 | Peak | --- | --- |

Note 1: Emission Level (dBuV/m) = SA Reading (dBuV/m) + Factor* (dB)

*Factor includes antenna factor , cable loss and amplifier gain

Note 2: Margin (dB) = Emission level (dBuV/m) – Limit (dBuV/m).



3.5.5 Transmitter Radiated Unwanted Emissions (Above 1GHz) for 11b

| Polarization | Horizontal | Test Freq. (MHz) | 2412 | | | | | | | | | | | | | | | | | | | | | | | | | | | | | | | | | | | | | | | | | | | | | | | | | | | | | | | | | | | | | |
|---|---|------------------|-----------------------|-----------------|-----------|-----------------|-------------|----------------|-------------|----------------|---|---------|-------|-------|-------|-------|-------|---------|-----|---|---------|-------|-------|--------|-------|-------|------|-----|---|---------|-------|-------|-------|-------|------|---------|-----|---|---------|-------|-------|--------|-------|------|------|-----|---|---------|-------|-------|--------|-------|------|---------|-----|---|---------|-------|-------|--------|-------|------|------|-----|
| | | | | | | | | | | | | | | | | | | | | | | | | | | | | | | | | | | | | | | | | | | | | | | | | | | | | | | | | | | | | | | | | |
| | <table border="1"> <thead> <tr> <th>Freq. MHz</th> <th>Emission level dBuV/m</th> <th>Limit dBuV/m</th> <th>Margin dB</th> <th>SA reading dBuV</th> <th>Factor dB</th> <th>Remark</th> <th>ANT High cm</th> <th>Turn Table deg</th> </tr> </thead> <tbody> <tr> <td>1</td> <td>2390.00</td> <td>52.55</td> <td>54.00</td> <td>-1.45</td> <td>55.45</td> <td>-2.90</td> <td>Average</td> <td>---</td> </tr> <tr> <td>2</td> <td>2390.00</td> <td>62.22</td> <td>74.00</td> <td>-11.78</td> <td>65.12</td> <td>-2.90</td> <td>Peak</td> <td>---</td> </tr> <tr> <td>3</td> <td>4824.00</td> <td>50.73</td> <td>54.00</td> <td>-3.27</td> <td>46.04</td> <td>4.69</td> <td>Average</td> <td>---</td> </tr> <tr> <td>4</td> <td>4824.00</td> <td>53.12</td> <td>74.00</td> <td>-20.88</td> <td>48.43</td> <td>4.69</td> <td>Peak</td> <td>---</td> </tr> <tr> <td>5</td> <td>7500.00</td> <td>41.18</td> <td>54.00</td> <td>-12.82</td> <td>31.31</td> <td>9.87</td> <td>Average</td> <td>---</td> </tr> <tr> <td>6</td> <td>7500.00</td> <td>51.51</td> <td>74.00</td> <td>-22.49</td> <td>41.64</td> <td>9.87</td> <td>Peak</td> <td>---</td> </tr> </tbody> </table> | Freq. MHz | Emission level dBuV/m | Limit dBuV/m | Margin dB | SA reading dBuV | Factor dB | Remark | ANT High cm | Turn Table deg | 1 | 2390.00 | 52.55 | 54.00 | -1.45 | 55.45 | -2.90 | Average | --- | 2 | 2390.00 | 62.22 | 74.00 | -11.78 | 65.12 | -2.90 | Peak | --- | 3 | 4824.00 | 50.73 | 54.00 | -3.27 | 46.04 | 4.69 | Average | --- | 4 | 4824.00 | 53.12 | 74.00 | -20.88 | 48.43 | 4.69 | Peak | --- | 5 | 7500.00 | 41.18 | 54.00 | -12.82 | 31.31 | 9.87 | Average | --- | 6 | 7500.00 | 51.51 | 74.00 | -22.49 | 41.64 | 9.87 | Peak | --- |
| Freq. MHz | Emission level dBuV/m | Limit dBuV/m | Margin dB | SA reading dBuV | Factor dB | Remark | ANT High cm | Turn Table deg | | | | | | | | | | | | | | | | | | | | | | | | | | | | | | | | | | | | | | | | | | | | | | | | | | | | | | | | |
| 1 | 2390.00 | 52.55 | 54.00 | -1.45 | 55.45 | -2.90 | Average | --- | | | | | | | | | | | | | | | | | | | | | | | | | | | | | | | | | | | | | | | | | | | | | | | | | | | | | | | | |
| 2 | 2390.00 | 62.22 | 74.00 | -11.78 | 65.12 | -2.90 | Peak | --- | | | | | | | | | | | | | | | | | | | | | | | | | | | | | | | | | | | | | | | | | | | | | | | | | | | | | | | | |
| 3 | 4824.00 | 50.73 | 54.00 | -3.27 | 46.04 | 4.69 | Average | --- | | | | | | | | | | | | | | | | | | | | | | | | | | | | | | | | | | | | | | | | | | | | | | | | | | | | | | | | |
| 4 | 4824.00 | 53.12 | 74.00 | -20.88 | 48.43 | 4.69 | Peak | --- | | | | | | | | | | | | | | | | | | | | | | | | | | | | | | | | | | | | | | | | | | | | | | | | | | | | | | | | |
| 5 | 7500.00 | 41.18 | 54.00 | -12.82 | 31.31 | 9.87 | Average | --- | | | | | | | | | | | | | | | | | | | | | | | | | | | | | | | | | | | | | | | | | | | | | | | | | | | | | | | | |
| 6 | 7500.00 | 51.51 | 74.00 | -22.49 | 41.64 | 9.87 | Peak | --- | | | | | | | | | | | | | | | | | | | | | | | | | | | | | | | | | | | | | | | | | | | | | | | | | | | | | | | | |
| <p>Note 1: Emission Level (dBuV/m) = SA Reading (dBuV/m) + Factor* (dB) *Factor includes antenna factor , cable loss and amplifier gain Note 2: Margin (dB) = Emission level (dBuV/m) – Limit (dBuV/m).</p> | | | | | | | | | | | | | | | | | | | | | | | | | | | | | | | | | | | | | | | | | | | | | | | | | | | | | | | | | | | | | | | | |



| | | | |
|---------------------|----------|-------------------------|------|
| Polarization | Vertical | Test Freq. (MHz) | 2412 |
|---------------------|----------|-------------------------|------|

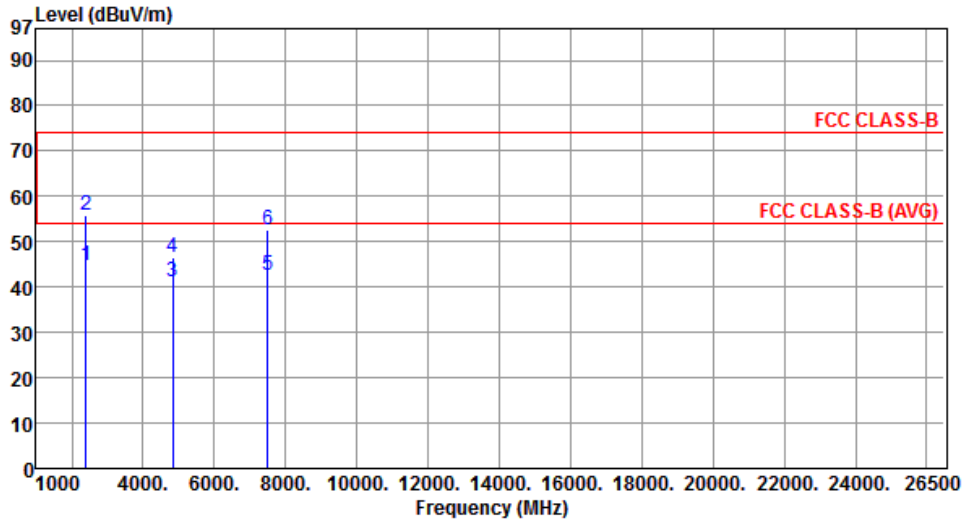

| | Freq. MHz | Emission level dBuV/m | Limit dBuV/m | Margin dB | SA reading dBuV | Factor dB | Remark | ANT High cm | Turn Table deg |
|---|--------------|-----------------------------|-----------------|--------------|-----------------------|--------------|---------|-------------------|----------------------|
| 1 | 2390.00 | 44.86 | 54.00 | -9.14 | 47.76 | -2.90 | Average | --- | --- |
| 2 | 2390.00 | 56.01 | 74.00 | -17.99 | 58.91 | -2.90 | Peak | --- | --- |
| 3 | 4824.00 | 41.01 | 54.00 | -12.99 | 36.32 | 4.69 | Average | --- | --- |
| 4 | 4824.00 | 46.60 | 74.00 | -27.40 | 41.91 | 4.69 | Peak | --- | --- |
| 5 | 7500.00 | 42.53 | 54.00 | -11.47 | 32.66 | 9.87 | Average | --- | --- |
| 6 | 7500.00 | 52.46 | 74.00 | -21.54 | 42.59 | 9.87 | Peak | --- | --- |

Note 1: Emission Level (dBuV/m) = SA Reading (dBuV/m) + Factor* (dB)

*Factor includes antenna factor , cable loss and amplifier gain

Note 2: Margin (dB) = Emission level (dBuV/m) – Limit (dBuV/m).



| | | | |
|---------------------|------------|-------------------------|------|
| Polarization | Horizontal | Test Freq. (MHz) | 2437 |
|---------------------|------------|-------------------------|------|

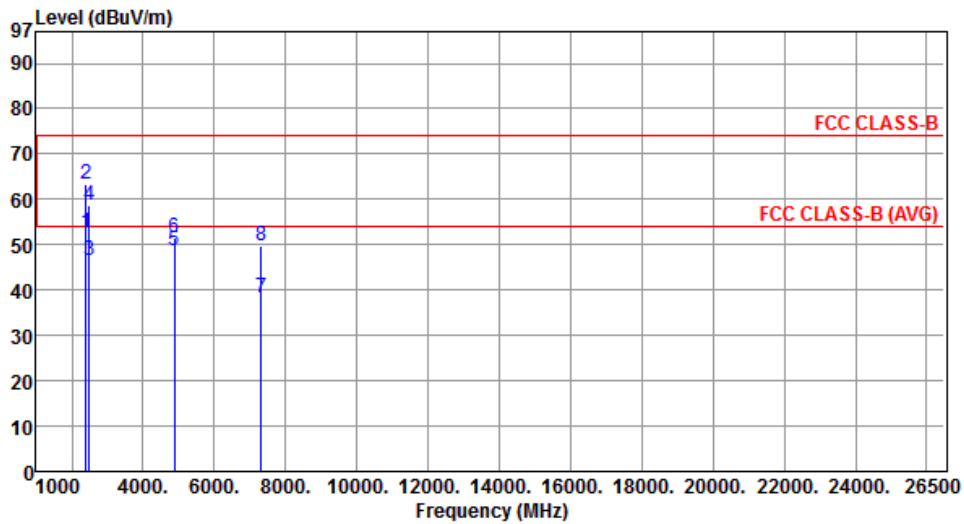

| | Freq. MHz | Emission level dBuV/m | Limit dBuV/m | Margin dB | SA reading dBuV | Factor dB | Remark | ANT High cm | Turn Table deg |
|---|--------------|-----------------------------|-----------------|--------------|-----------------------|--------------|---------|-------------------|----------------------|
| 1 | 2390.00 | 52.77 | 54.00 | -1.23 | 55.67 | -2.90 | Average | --- | --- |
| 2 | 2390.00 | 63.35 | 74.00 | -10.65 | 66.25 | -2.90 | Peak | --- | --- |
| 3 | 2483.50 | 46.57 | 54.00 | -7.43 | 48.99 | -2.42 | Average | --- | --- |
| 4 | 2483.50 | 58.65 | 74.00 | -15.35 | 61.07 | -2.42 | Peak | --- | --- |
| 5 | 4874.00 | 48.64 | 54.00 | -5.36 | 43.87 | 4.77 | Average | --- | --- |
| 6 | 4874.00 | 51.62 | 74.00 | -22.38 | 46.85 | 4.77 | Peak | --- | --- |
| 7 | 7311.00 | 38.30 | 54.00 | -15.70 | 28.73 | 9.57 | Average | --- | --- |
| 8 | 7311.00 | 49.59 | 74.00 | -24.41 | 40.02 | 9.57 | Peak | --- | --- |

Note 1: Emission Level (dBuV/m) = SA Reading (dBuV/m) + Factor* (dB)

*Factor includes antenna factor , cable loss and amplifier gain

Note 2: Margin (dB) = Emission level (dBuV/m) – Limit (dBuV/m).



| | | | |
|---------------------|----------|-------------------------|------|
| Polarization | Vertical | Test Freq. (MHz) | 2437 |
|---------------------|----------|-------------------------|------|

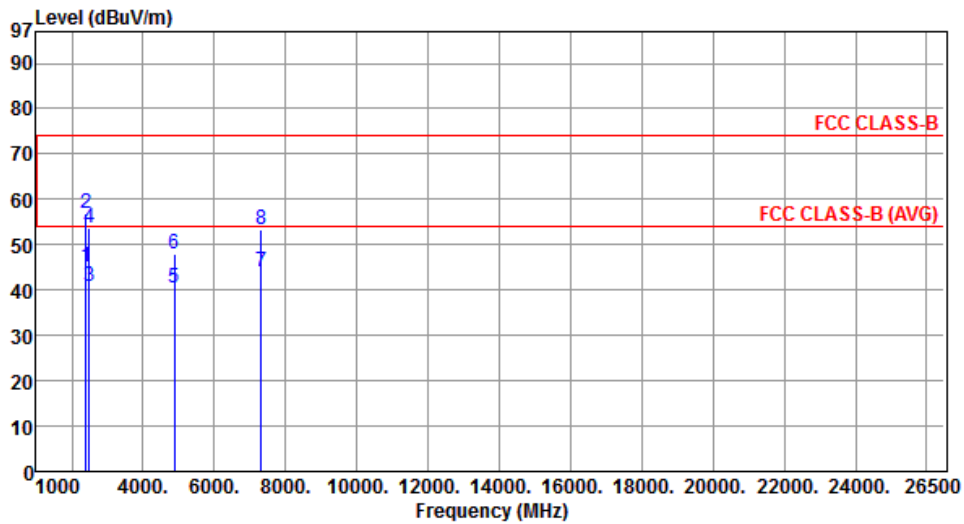

| | Freq. MHz | Emission level dBuV/m | Limit dBuV/m | Margin dB | SA reading dBuV | Factor dB | Remark | ANT High cm | Turn Table deg |
|---|--------------|-----------------------------|-----------------|--------------|-----------------------|--------------|---------|-------------------|----------------------|
| 1 | 2390.00 | 45.22 | 54.00 | -8.78 | 48.12 | -2.90 | Average | --- | --- |
| 2 | 2390.00 | 56.96 | 74.00 | -17.04 | 59.86 | -2.90 | Peak | --- | --- |
| 3 | 2483.50 | 40.87 | 54.00 | -13.13 | 43.29 | -2.42 | Average | --- | --- |
| 4 | 2483.50 | 53.71 | 74.00 | -20.29 | 56.13 | -2.42 | Peak | --- | --- |
| 5 | 4874.00 | 40.59 | 54.00 | -13.41 | 35.82 | 4.77 | Average | --- | --- |
| 6 | 4874.00 | 47.95 | 74.00 | -26.05 | 43.18 | 4.77 | Peak | --- | --- |
| 7 | 7311.00 | 44.18 | 54.00 | -9.82 | 34.61 | 9.57 | Average | --- | --- |
| 8 | 7311.00 | 53.26 | 74.00 | -20.74 | 43.69 | 9.57 | Peak | --- | --- |

Note 1: Emission Level (dBuV/m) = SA Reading (dBuV/m) + Factor* (dB)

*Factor includes antenna factor , cable loss and amplifier gain

Note 2: Margin (dB) = Emission level (dBuV/m) – Limit (dBuV/m).



| | | | |
|---------------------|------------|-------------------------|------|
| Polarization | Horizontal | Test Freq. (MHz) | 2462 |
|---------------------|------------|-------------------------|------|

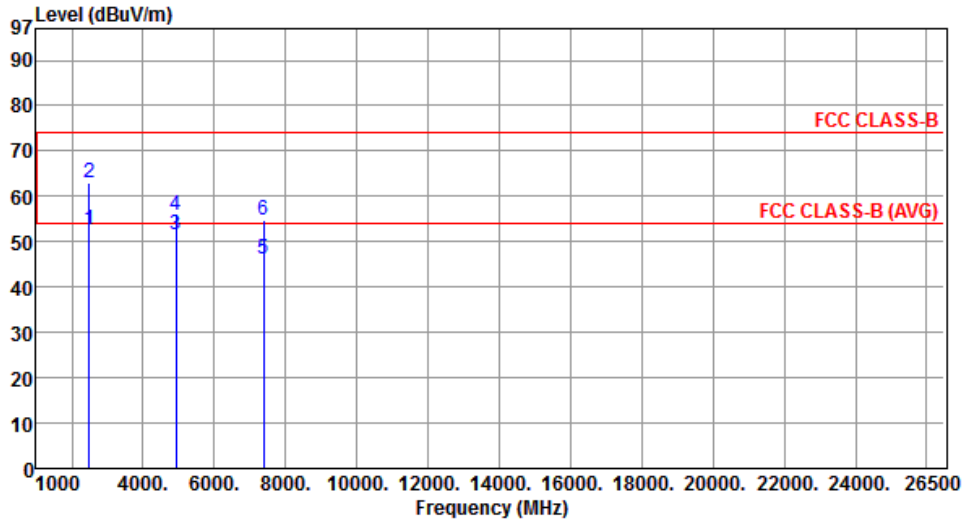

| | Freq. MHz | Emission level dBuV/m | Limit dBuV/m | Margin dB | SA reading dBuV | Factor dB | Remark | ANT High cm | Turn Table deg |
|---|--------------|-----------------------------|-----------------|--------------|-----------------------|--------------|---------|-------------------|----------------------|
| 1 | 2483.50 | 52.52 | 54.00 | -1.48 | 54.94 | -2.42 | Average | --- | --- |
| 2 | 2483.50 | 63.08 | 74.00 | -10.92 | 65.50 | -2.42 | Peak | --- | --- |
| 3 | 4924.00 | 51.58 | 54.00 | -2.42 | 46.72 | 4.86 | Average | --- | --- |
| 4 | 4924.00 | 55.69 | 74.00 | -18.31 | 50.83 | 4.86 | Peak | --- | --- |
| 5 | 7386.00 | 46.05 | 54.00 | -7.95 | 36.37 | 9.68 | Average | --- | --- |
| 6 | 7386.00 | 54.83 | 74.00 | -19.17 | 45.15 | 9.68 | Peak | --- | --- |

Note 1: Emission Level (dBuV/m) = SA Reading (dBuV/m) + Factor* (dB)

*Factor includes antenna factor , cable loss and amplifier gain

Note 2: Margin (dB) = Emission level (dBuV/m) – Limit (dBuV/m).



| | | | |
|---------------------|----------|-------------------------|------|
| Polarization | Vertical | Test Freq. (MHz) | 2462 |
|---------------------|----------|-------------------------|------|

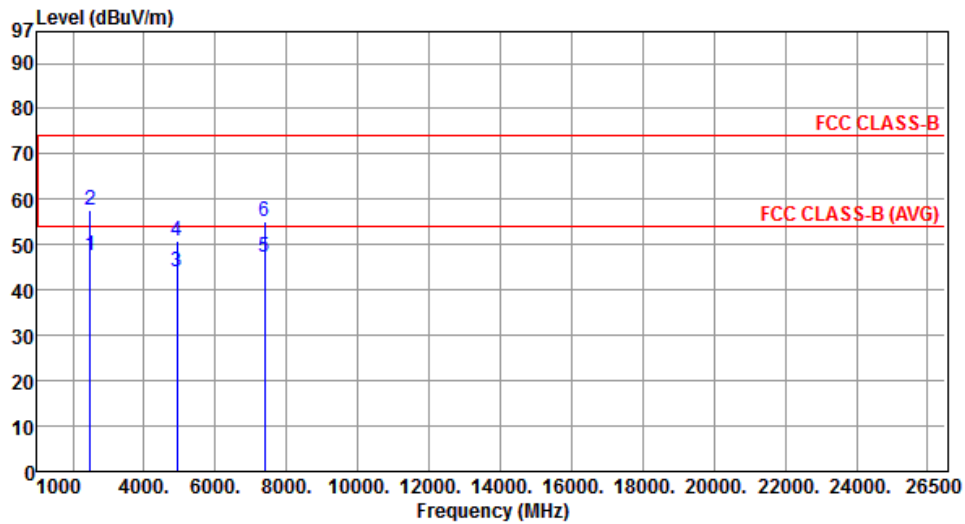

| | Freq. MHz | Emission level dBuV/m | Limit dBuV/m | Margin dB | SA reading dBuV | Factor dB | Remark | ANT High cm | Turn Table deg |
|---|--------------|-----------------------------|-----------------|--------------|-----------------------|--------------|---------|-------------------|----------------------|
| 1 | 2483.50 | 47.57 | 54.00 | -6.43 | 49.99 | -2.42 | Average | --- | --- |
| 2 | 2483.50 | 57.77 | 74.00 | -16.23 | 60.19 | -2.42 | Peak | --- | --- |
| 3 | 4924.00 | 44.11 | 54.00 | -9.89 | 39.25 | 4.86 | Average | --- | --- |
| 4 | 4924.00 | 50.71 | 74.00 | -23.29 | 45.85 | 4.86 | Peak | --- | --- |
| 5 | 7386.00 | 47.23 | 54.00 | -6.77 | 37.55 | 9.68 | Average | --- | --- |
| 6 | 7386.00 | 55.00 | 74.00 | -19.00 | 45.32 | 9.68 | Peak | --- | --- |

Note 1: Emission Level (dBuV/m) = SA Reading (dBuV/m) + Factor* (dB)

*Factor includes antenna factor , cable loss and amplifier gain

Note 2: Margin (dB) = Emission level (dBuV/m) – Limit (dBuV/m).



3.5.6 Transmitter Radiated Unwanted Emissions (Above 1GHz) for 11g

| Polarization | Horizontal | Test Freq. (MHz) | 2412 | | | | | | |
|--------------|------------|-----------------------|--------------|-----------|-----------------|-----------|---------|-------------|----------------|
| | | | | | | | | | |
| | Freq. MHz | Emission level dBuV/m | Limit dBuV/m | Margin dB | SA reading dBuV | Factor dB | Remark | ANT High cm | Turn Table deg |
| 1 | 2390.00 | 50.51 | 54.00 | -3.49 | 53.41 | -2.90 | Average | --- | --- |
| 2 | 2390.00 | 72.91 | 74.00 | -1.09 | 75.81 | -2.90 | Peak | --- | --- |
| 3 | 4824.00 | 36.51 | 54.00 | -17.49 | 31.82 | 4.69 | Average | --- | --- |
| 4 | 4824.00 | 46.89 | 74.00 | -27.11 | 42.20 | 4.69 | Peak | --- | --- |
| 5 | 7500.00 | 40.89 | 54.00 | -13.11 | 31.02 | 9.87 | Average | --- | --- |
| 6 | 7500.00 | 50.43 | 74.00 | -23.57 | 40.56 | 9.87 | Peak | --- | --- |

Note 1: Emission Level (dBuV/m) = SA Reading (dBuV/m) + Factor* (dB)
 *Factor includes antenna factor , cable loss and amplifier gain
 Note 2: Margin (dB) = Emission level (dBuV/m) – Limit (dBuV/m).



| | | | |
|---------------------|----------|-------------------------|------|
| Polarization | Vertical | Test Freq. (MHz) | 2412 |
|---------------------|----------|-------------------------|------|

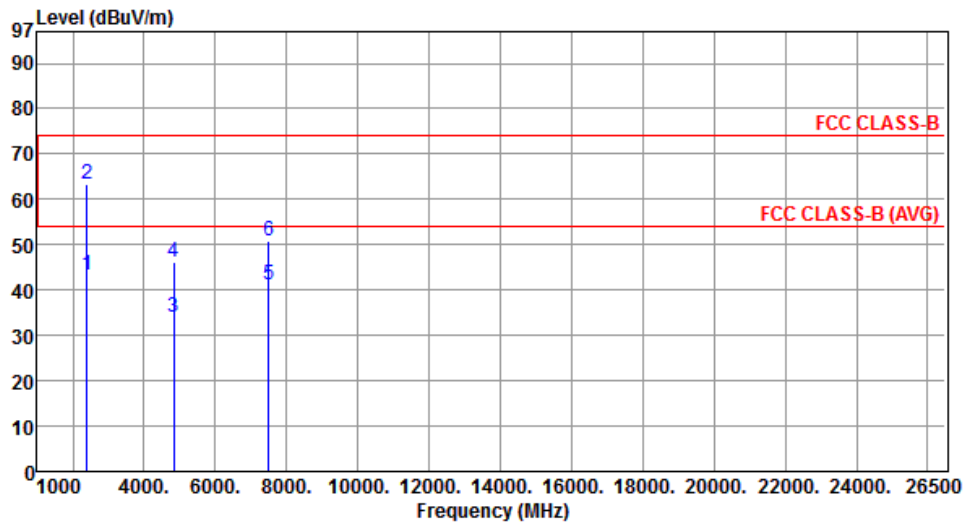

| | Freq. MHz | Emission level dBuV/m | Limit dBuV/m | Margin dB | SA reading dBuV | Factor dB | Remark | ANT High cm | Turn Table deg |
|---|--------------|-----------------------------|-----------------|--------------|-----------------------|--------------|---------|-------------------|----------------------|
| 1 | 2390.00 | 43.21 | 54.00 | -10.79 | 46.11 | -2.90 | Average | --- | --- |
| 2 | 2390.00 | 63.24 | 74.00 | -10.76 | 66.14 | -2.90 | Peak | --- | --- |
| 3 | 4824.00 | 33.92 | 54.00 | -20.08 | 29.23 | 4.69 | Average | --- | --- |
| 4 | 4824.00 | 46.23 | 74.00 | -27.77 | 41.54 | 4.69 | Peak | --- | --- |
| 5 | 7500.00 | 41.16 | 54.00 | -12.84 | 31.29 | 9.87 | Average | --- | --- |
| 6 | 7500.00 | 50.98 | 74.00 | -23.02 | 41.11 | 9.87 | Peak | --- | --- |

Note 1: Emission Level (dBuV/m) = SA Reading (dBuV/m) + Factor* (dB)

*Factor includes antenna factor , cable loss and amplifier gain

Note 2: Margin (dB) = Emission level (dBuV/m) – Limit (dBuV/m).



| | | | |
|---------------------|------------|-------------------------|------|
| Polarization | Horizontal | Test Freq. (MHz) | 2437 |
|---------------------|------------|-------------------------|------|

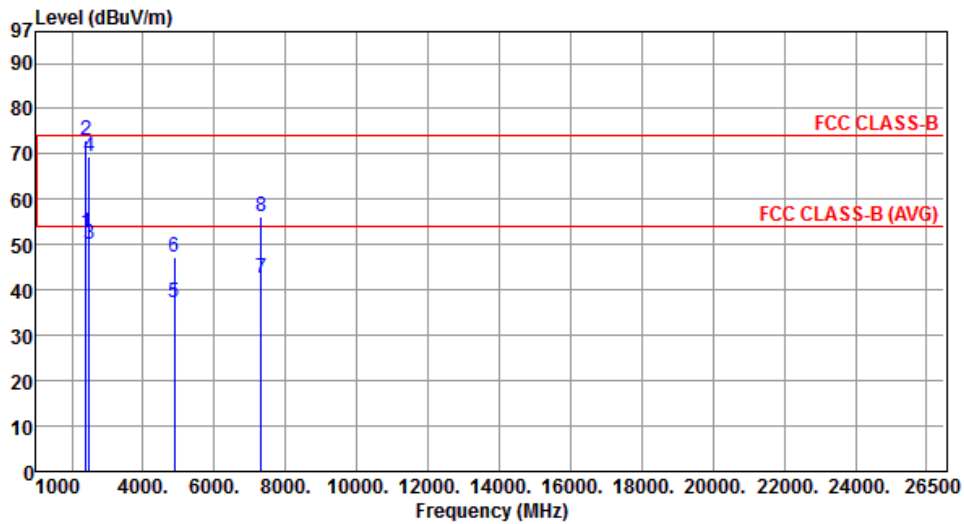

| | Freq. MHz | Emission level dBuV/m | Limit dBuV/m | Margin dB | SA reading dBuV | Factor dB | Remark | ANT High cm | Turn Table deg |
|---|--------------|-----------------------------|-----------------|--------------|-----------------------|--------------|---------|-------------------|----------------------|
| 1 | 2390.00 | 52.51 | 54.00 | -1.49 | 55.41 | -2.90 | Average | --- | --- |
| 2 | 2390.00 | 72.86 | 74.00 | -1.14 | 75.76 | -2.90 | Peak | --- | --- |
| 3 | 2483.50 | 50.18 | 54.00 | -3.82 | 52.60 | -2.42 | Average | --- | --- |
| 4 | 2483.50 | 69.28 | 74.00 | -4.72 | 71.70 | -2.42 | Peak | --- | --- |
| 5 | 4874.00 | 37.07 | 54.00 | -16.93 | 32.30 | 4.77 | Average | --- | --- |
| 6 | 4874.00 | 47.22 | 74.00 | -26.78 | 42.45 | 4.77 | Peak | --- | --- |
| 7 | 7311.00 | 42.66 | 54.00 | -11.34 | 33.09 | 9.57 | Average | --- | --- |
| 8 | 7311.00 | 56.26 | 74.00 | -17.74 | 46.69 | 9.57 | Peak | --- | --- |

Note 1: Emission Level (dBuV/m) = SA Reading (dBuV/m) + Factor* (dB)

*Factor includes antenna factor , cable loss and amplifier gain

Note 2: Margin (dB) = Emission level (dBuV/m) – Limit (dBuV/m).



| | | | |
|---------------------|----------|-------------------------|------|
| Polarization | Vertical | Test Freq. (MHz) | 2437 |
|---------------------|----------|-------------------------|------|

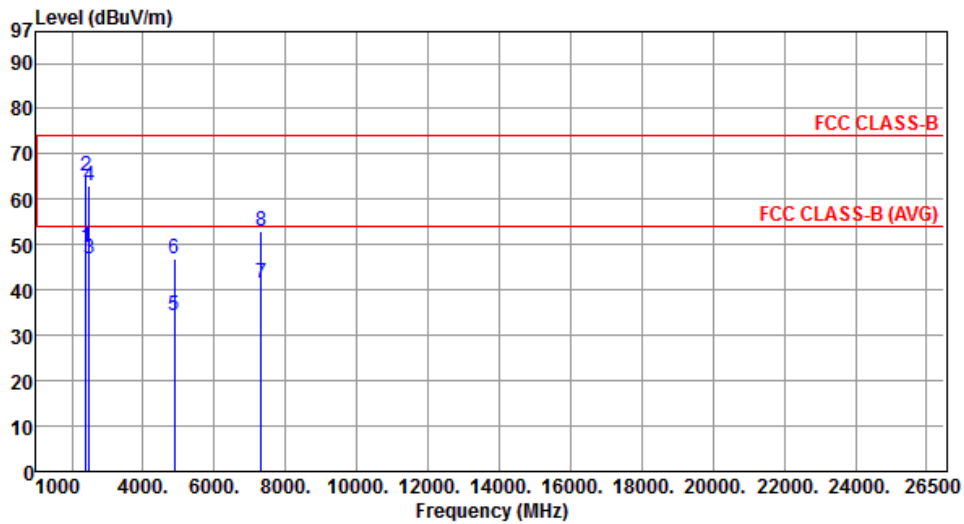

| | Freq. MHz | Emission level dBuV/m | Limit dBuV/m | Margin dB | SA reading dBuV | Factor dB | Remark | ANT High cm | Turn Table deg |
|---|--------------|-----------------------------|-----------------|--------------|-----------------------|--------------|---------|-------------------|----------------------|
| 1 | 2390.00 | 49.51 | 54.00 | -4.49 | 52.41 | -2.90 | Average | --- | --- |
| 2 | 2390.00 | 65.21 | 74.00 | -8.79 | 68.11 | -2.90 | Peak | --- | --- |
| 3 | 2483.50 | 46.78 | 54.00 | -7.22 | 49.20 | -2.42 | Average | --- | --- |
| 4 | 2483.50 | 62.88 | 74.00 | -11.12 | 65.30 | -2.42 | Peak | --- | --- |
| 5 | 4874.00 | 34.37 | 54.00 | -19.63 | 29.60 | 4.77 | Average | --- | --- |
| 6 | 4874.00 | 46.87 | 74.00 | -27.13 | 42.10 | 4.77 | Peak | --- | --- |
| 7 | 7311.00 | 41.66 | 54.00 | -12.34 | 32.09 | 9.57 | Average | --- | --- |
| 8 | 7311.00 | 52.86 | 74.00 | -21.14 | 43.29 | 9.57 | Peak | --- | --- |

Note 1: Emission Level (dBuV/m) = SA Reading (dBuV/m) + Factor* (dB)

*Factor includes antenna factor , cable loss and amplifier gain

Note 2: Margin (dB) = Emission level (dBuV/m) – Limit (dBuV/m).



| | | | |
|---------------------|------------|-------------------------|------|
| Polarization | Horizontal | Test Freq. (MHz) | 2462 |
|---------------------|------------|-------------------------|------|

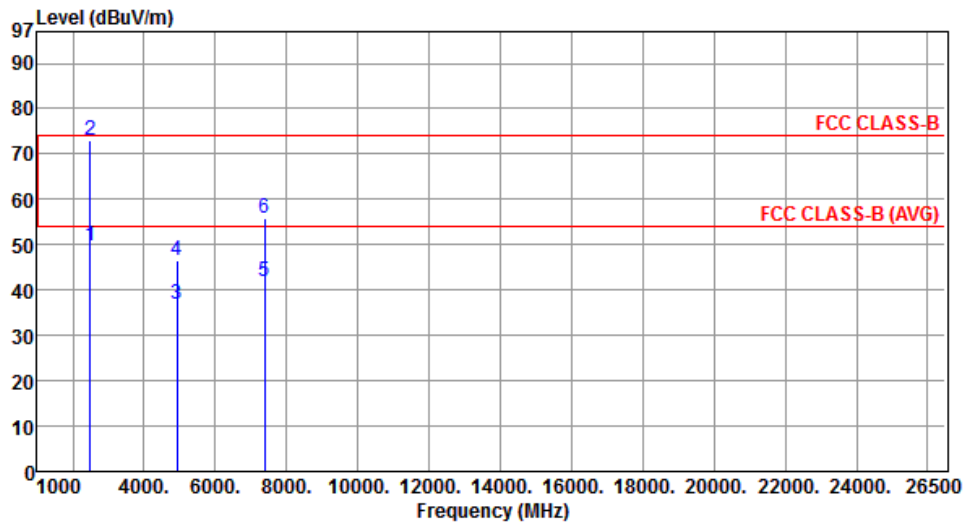

| | Freq. MHz | Emission level dBuV/m | Limit dBuV/m | Margin dB | SA reading dBuV | Factor dB | Remark | ANT High cm | Turn Table deg |
|---|--------------|-----------------------------|-----------------|--------------|-----------------------|--------------|---------|-------------------|----------------------|
| 1 | 2483.50 | 49.68 | 54.00 | -4.32 | 52.10 | -2.42 | Average | --- | --- |
| 2 | 2483.50 | 72.98 | 74.00 | -1.02 | 75.40 | -2.42 | Peak | --- | --- |
| 3 | 4924.00 | 36.76 | 54.00 | -17.24 | 31.90 | 4.86 | Average | --- | --- |
| 4 | 4924.00 | 46.66 | 74.00 | -27.34 | 41.80 | 4.86 | Peak | --- | --- |
| 5 | 7386.00 | 41.99 | 54.00 | -12.01 | 32.31 | 9.68 | Average | --- | --- |
| 6 | 7386.00 | 55.83 | 74.00 | -18.17 | 46.15 | 9.68 | Peak | --- | --- |

Note 1: Emission Level (dBuV/m) = SA Reading (dBuV/m) + Factor* (dB)

*Factor includes antenna factor , cable loss and amplifier gain

Note 2: Margin (dB) = Emission level (dBuV/m) – Limit (dBuV/m).



| | | | |
|---------------------|----------|-------------------------|------|
| Polarization | Vertical | Test Freq. (MHz) | 2462 |
|---------------------|----------|-------------------------|------|

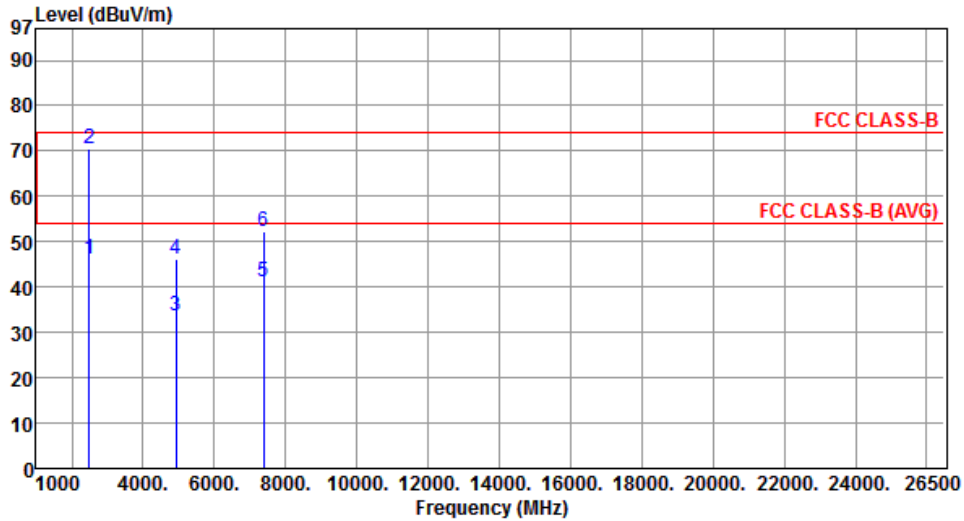

| | Freq. MHz | Emission level dBuV/m | Limit dBuV/m | Margin dB | SA reading dBuV | Factor dB | Remark | ANT High cm | Turn Table deg |
|---|--------------|-----------------------------|-----------------|--------------|-----------------------|--------------|---------|-------------------|----------------------|
| 1 | 2483.50 | 46.18 | 54.00 | -7.82 | 48.60 | -2.42 | Average | --- | --- |
| 2 | 2483.50 | 70.48 | 74.00 | -3.52 | 72.90 | -2.42 | Peak | --- | --- |
| 3 | 4924.00 | 33.72 | 54.00 | -20.28 | 28.86 | 4.86 | Average | --- | --- |
| 4 | 4924.00 | 46.02 | 74.00 | -27.98 | 41.16 | 4.86 | Peak | --- | --- |
| 5 | 7386.00 | 41.04 | 54.00 | -12.96 | 31.36 | 9.68 | Average | --- | --- |
| 6 | 7386.00 | 52.23 | 74.00 | -21.77 | 42.55 | 9.68 | Peak | --- | --- |

Note 1: Emission Level (dBuV/m) = SA Reading (dBuV/m) + Factor* (dB)

*Factor includes antenna factor , cable loss and amplifier gain

Note 2: Margin (dB) = Emission level (dBuV/m) – Limit (dBuV/m).



3.5.7 Transmitter Radiated Unwanted Emissions (Above 1GHz) for HT20

| Polarization | Horizontal | Test Freq. (MHz) | 2412 | | | | | | |
|---|--------------|-----------------------------|-----------------|--------------|-----------------------|--------------|--------|-------------------|----------------------|
| | | | | | | | | | |
| | Freq. MHz | Emission level dBuV/m | Limit dBuV/m | Margin dB | SA reading dBuV | Factor dB | Remark | ANT High cm | Turn Table deg |
| | 1 | 2390.00 | 49.71 | 54.00 | -4.29 | 52.61 | -2.90 | Average | --- |
| | 2 | 2390.00 | 73.00 | 74.00 | -1.00 | 75.90 | -2.90 | Peak | --- |
| | 3 | 4824.00 | 36.05 | 54.00 | -17.95 | 31.36 | 4.69 | Average | --- |
| | 4 | 4824.00 | 46.54 | 74.00 | -27.46 | 41.85 | 4.69 | Peak | --- |
| | 5 | 7500.00 | 41.08 | 54.00 | -12.92 | 31.21 | 9.87 | Average | --- |
| | 6 | 7500.00 | 50.75 | 74.00 | -23.25 | 40.88 | 9.87 | Peak | --- |
| <p>Note 1: Emission Level (dBuV/m) = SA Reading (dBuV/m) + Factor* (dB) *Factor includes antenna factor , cable loss and amplifier gain Note 2: Margin (dB) = Emission level (dBuV/m) – Limit (dBuV/m).</p> | | | | | | | | | |



| | | | |
|---------------------|----------|-------------------------|------|
| Polarization | Vertical | Test Freq. (MHz) | 2412 |
|---------------------|----------|-------------------------|------|

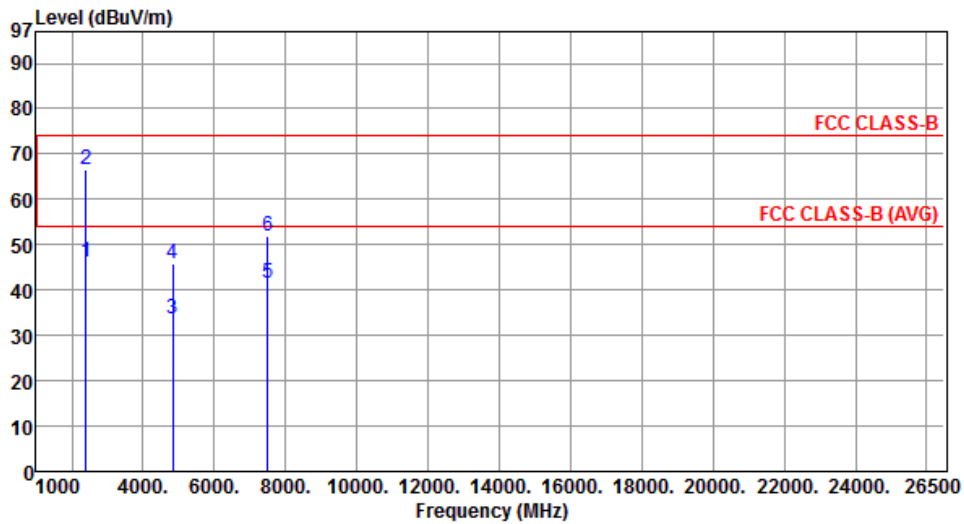

| | Freq. MHz | Emission level dBuV/m | Limit dBuV/m | Margin dB | SA reading dBuV | Factor dB | Remark | ANT High cm | Turn Table deg |
|---|--------------|-----------------------------|-----------------|--------------|-----------------------|--------------|---------|-------------------|----------------------|
| 1 | 2390.00 | 46.01 | 54.00 | -7.99 | 48.91 | -2.90 | Average | --- | --- |
| 2 | 2390.00 | 66.61 | 74.00 | -7.39 | 69.51 | -2.90 | Peak | --- | --- |
| 3 | 4824.00 | 33.51 | 54.00 | -20.49 | 28.82 | 4.69 | Average | --- | --- |
| 4 | 4824.00 | 45.97 | 74.00 | -28.03 | 41.28 | 4.69 | Peak | --- | --- |
| 5 | 7500.00 | 41.56 | 54.00 | -12.44 | 31.69 | 9.87 | Average | --- | --- |
| 6 | 7500.00 | 51.84 | 74.00 | -22.16 | 41.97 | 9.87 | Peak | --- | --- |

Note 1: Emission Level (dBuV/m) = SA Reading (dBuV/m) + Factor* (dB)

*Factor includes antenna factor , cable loss and amplifier gain

Note 2: Margin (dB) = Emission level (dBuV/m) – Limit (dBuV/m).



| | | | |
|---------------------|------------|-------------------------|------|
| Polarization | Horizontal | Test Freq. (MHz) | 2437 |
|---------------------|------------|-------------------------|------|

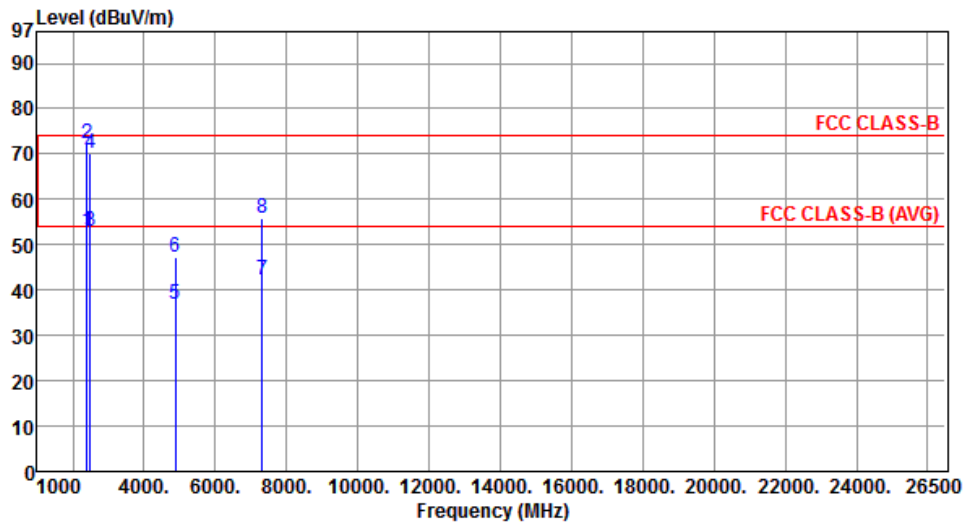

| | Freq. MHz | Emission level dBuV/m | Limit dBuV/m | Margin dB | SA reading dBuV | Factor dB | Remark | ANT High cm | Turn Table deg |
|---|--------------|-----------------------------|-----------------|--------------|-----------------------|--------------|---------|-------------------|----------------------|
| 1 | 2390.00 | 53.00 | 54.00 | -1.00 | 55.90 | -2.90 | Average | --- | --- |
| 2 | 2390.00 | 72.21 | 74.00 | -1.79 | 75.11 | -2.90 | Peak | --- | --- |
| 3 | 2483.50 | 52.88 | 54.00 | -1.12 | 55.30 | -2.42 | Average | --- | --- |
| 4 | 2483.50 | 70.28 | 74.00 | -3.72 | 72.70 | -2.42 | Peak | --- | --- |
| 5 | 4874.00 | 36.88 | 54.00 | -17.12 | 32.11 | 4.77 | Average | --- | --- |
| 6 | 4874.00 | 47.12 | 74.00 | -26.88 | 42.35 | 4.77 | Peak | --- | --- |
| 7 | 7311.00 | 42.31 | 54.00 | -11.69 | 32.74 | 9.57 | Average | --- | --- |
| 8 | 7311.00 | 55.99 | 74.00 | -18.01 | 46.42 | 9.57 | Peak | --- | --- |

Note 1: Emission Level (dBuV/m) = SA Reading (dBuV/m) + Factor* (dB)

*Factor includes antenna factor , cable loss and amplifier gain

Note 2: Margin (dB) = Emission level (dBuV/m) – Limit (dBuV/m).



| | | | |
|---------------------|----------|-------------------------|------|
| Polarization | Vertical | Test Freq. (MHz) | 2437 |
|---------------------|----------|-------------------------|------|

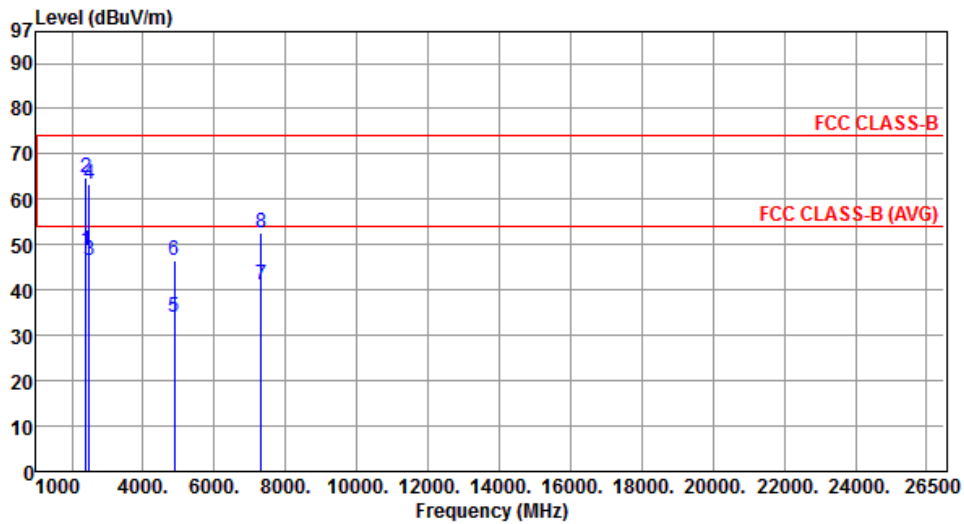

| | Freq. MHz | Emission level dBuV/m | Limit dBuV/m | Margin dB | SA reading dBuV | Factor dB | Remark | ANT High cm | Turn Table deg |
|---|--------------|-----------------------------|-----------------|--------------|-----------------------|--------------|---------|-------------------|----------------------|
| 1 | 2390.00 | 48.61 | 54.00 | -5.39 | 51.51 | -2.90 | Average | --- | --- |
| 2 | 2390.00 | 64.71 | 74.00 | -9.29 | 67.61 | -2.90 | Peak | --- | --- |
| 3 | 2483.50 | 46.38 | 54.00 | -7.62 | 48.80 | -2.42 | Average | --- | --- |
| 4 | 2483.50 | 63.48 | 74.00 | -10.52 | 65.90 | -2.42 | Peak | --- | --- |
| 5 | 4874.00 | 34.12 | 54.00 | -19.88 | 29.35 | 4.77 | Average | --- | --- |
| 6 | 4874.00 | 46.51 | 74.00 | -27.49 | 41.74 | 4.77 | Peak | --- | --- |
| 7 | 7311.00 | 41.33 | 54.00 | -12.67 | 31.76 | 9.57 | Average | --- | --- |
| 8 | 7311.00 | 52.54 | 74.00 | -21.46 | 42.97 | 9.57 | Peak | --- | --- |

Note 1: Emission Level (dBuV/m) = SA Reading (dBuV/m) + Factor* (dB)

*Factor includes antenna factor , cable loss and amplifier gain

Note 2: Margin (dB) = Emission level (dBuV/m) – Limit (dBuV/m).



| | | | |
|---------------------|------------|-------------------------|------|
| Polarization | Horizontal | Test Freq. (MHz) | 2462 |
|---------------------|------------|-------------------------|------|

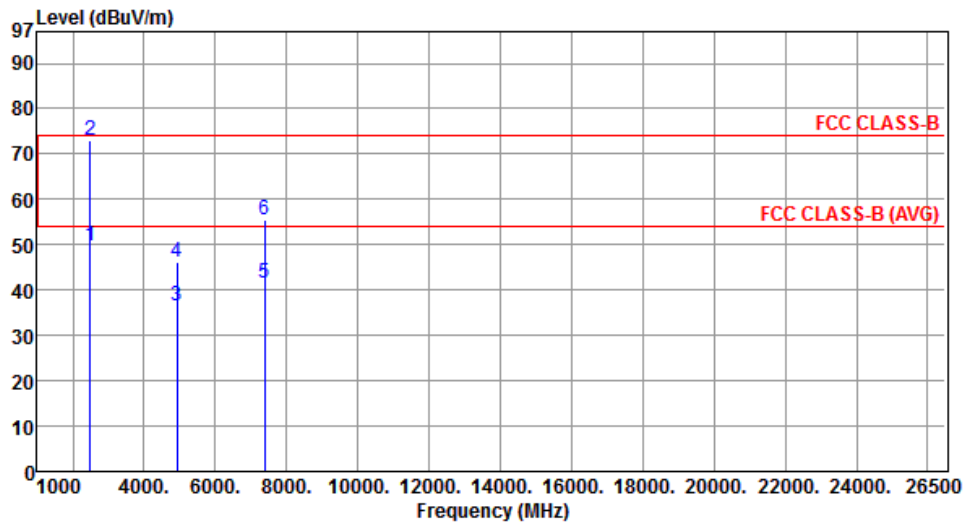

| | Freq. MHz | Emission level dBuV/m | Limit dBuV/m | Margin dB | SA reading dBuV | Factor dB | Remark | ANT High cm | Turn Table deg |
|---|--------------|-----------------------------|-----------------|--------------|-----------------------|--------------|---------|-------------------|----------------------|
| 1 | 2483.50 | 49.62 | 54.00 | -4.38 | 52.04 | -2.42 | Average | --- | --- |
| 2 | 2483.50 | 72.93 | 74.00 | -1.07 | 75.35 | -2.42 | Peak | --- | --- |
| 3 | 4924.00 | 36.52 | 54.00 | -17.48 | 31.66 | 4.86 | Average | --- | --- |
| 4 | 4924.00 | 46.29 | 74.00 | -27.71 | 41.43 | 4.86 | Peak | --- | --- |
| 5 | 7386.00 | 41.38 | 54.00 | -12.62 | 31.70 | 9.68 | Average | --- | --- |
| 6 | 7386.00 | 55.62 | 74.00 | -18.38 | 45.94 | 9.68 | Peak | --- | --- |

Note 1: Emission Level (dBuV/m) = SA Reading (dBuV/m) + Factor* (dB)

*Factor includes antenna factor , cable loss and amplifier gain

Note 2: Margin (dB) = Emission level (dBuV/m) – Limit (dBuV/m).



| | | | |
|---------------------|----------|-------------------------|------|
| Polarization | Vertical | Test Freq. (MHz) | 2462 |
|---------------------|----------|-------------------------|------|

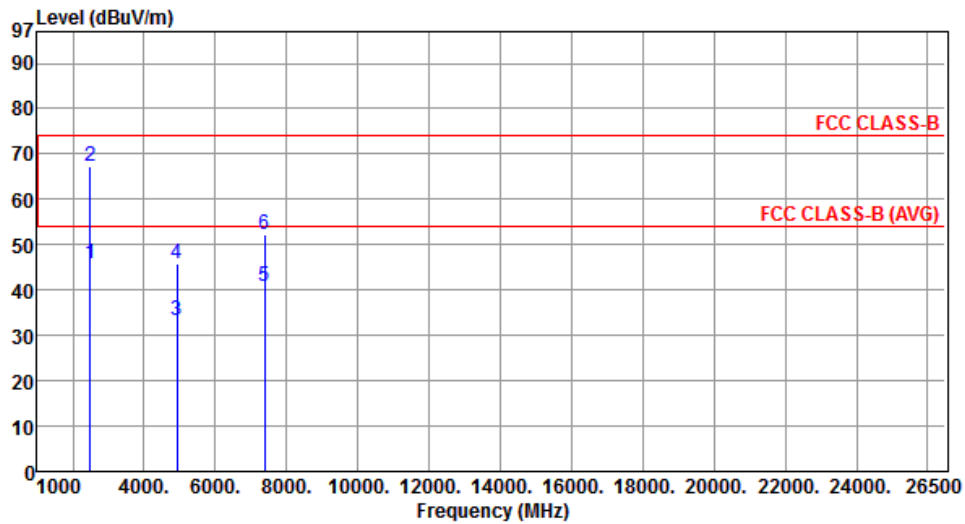

| | Freq. MHz | Emission level dBuV/m | Limit dBuV/m | Margin dB | SA reading dBuV | Factor dB | Remark | ANT High cm | Turn Table deg |
|---|--------------|-----------------------------|-----------------|--------------|-----------------------|--------------|---------|-------------------|----------------------|
| 1 | 2483.50 | 45.88 | 54.00 | -8.12 | 48.30 | -2.42 | Average | --- | --- |
| 2 | 2483.50 | 67.28 | 74.00 | -6.72 | 69.70 | -2.42 | Peak | --- | --- |
| 3 | 4924.00 | 33.43 | 54.00 | -20.57 | 28.57 | 4.86 | Average | --- | --- |
| 4 | 4924.00 | 45.83 | 74.00 | -28.17 | 40.97 | 4.86 | Peak | --- | --- |
| 5 | 7386.00 | 40.95 | 54.00 | -13.05 | 31.27 | 9.68 | Average | --- | --- |
| 6 | 7386.00 | 52.10 | 74.00 | -21.90 | 42.42 | 9.68 | Peak | --- | --- |

Note 1: Emission Level (dBuV/m) = SA Reading (dBuV/m) + Factor* (dB)

*Factor includes antenna factor , cable loss and amplifier gain

Note 2: Margin (dB) = Emission level (dBuV/m) – Limit (dBuV/m).



3.5.8 Transmitter Radiated Unwanted Emissions (Above 1GHz) for HT40

| Polarization | Horizontal | Test Freq. (MHz) | 2422 | | | | | | | | | | | | | | | | | | | | | | | | | | | | | | | | | | | | | | | | | | | | | | | | | | | | | | | | | | | | | |
|---|---|------------------|-----------------------|-----------------|-----------|-----------------|-------------|----------------|-------------|----------------|---|---------|-------|-------|-------|-------|-------|---------|-----|---|---------|-------|-------|-------|-------|-------|------|-----|---|---------|-------|-------|--------|-------|------|---------|-----|---|---------|-------|-------|--------|-------|------|------|-----|---|---------|-------|-------|--------|-------|------|---------|-----|---|---------|-------|-------|--------|-------|------|------|-----|
| | | | | | | | | | | | | | | | | | | | | | | | | | | | | | | | | | | | | | | | | | | | | | | | | | | | | | | | | | | | | | | | | |
| | <table border="1"> <thead> <tr> <th>Freq. MHz</th> <th>Emission level dBuV/m</th> <th>Limit dBuV/m</th> <th>Margin dB</th> <th>SA reading dBuV</th> <th>Factor dB</th> <th>Remark</th> <th>ANT High cm</th> <th>Turn Table deg</th> </tr> </thead> <tbody> <tr> <td>1</td> <td>2390.00</td> <td>52.56</td> <td>54.00</td> <td>-1.44</td> <td>55.46</td> <td>-2.90</td> <td>Average</td> <td>---</td> </tr> <tr> <td>2</td> <td>2390.00</td> <td>72.45</td> <td>74.00</td> <td>-1.55</td> <td>75.35</td> <td>-2.90</td> <td>Peak</td> <td>---</td> </tr> <tr> <td>3</td> <td>4844.00</td> <td>35.88</td> <td>54.00</td> <td>-18.12</td> <td>31.17</td> <td>4.71</td> <td>Average</td> <td>---</td> </tr> <tr> <td>4</td> <td>4844.00</td> <td>46.21</td> <td>74.00</td> <td>-27.79</td> <td>41.50</td> <td>4.71</td> <td>Peak</td> <td>---</td> </tr> <tr> <td>5</td> <td>7500.00</td> <td>40.26</td> <td>54.00</td> <td>-13.74</td> <td>30.39</td> <td>9.87</td> <td>Average</td> <td>---</td> </tr> <tr> <td>6</td> <td>7500.00</td> <td>50.59</td> <td>74.00</td> <td>-23.41</td> <td>40.72</td> <td>9.87</td> <td>Peak</td> <td>---</td> </tr> </tbody> </table> | Freq. MHz | Emission level dBuV/m | Limit dBuV/m | Margin dB | SA reading dBuV | Factor dB | Remark | ANT High cm | Turn Table deg | 1 | 2390.00 | 52.56 | 54.00 | -1.44 | 55.46 | -2.90 | Average | --- | 2 | 2390.00 | 72.45 | 74.00 | -1.55 | 75.35 | -2.90 | Peak | --- | 3 | 4844.00 | 35.88 | 54.00 | -18.12 | 31.17 | 4.71 | Average | --- | 4 | 4844.00 | 46.21 | 74.00 | -27.79 | 41.50 | 4.71 | Peak | --- | 5 | 7500.00 | 40.26 | 54.00 | -13.74 | 30.39 | 9.87 | Average | --- | 6 | 7500.00 | 50.59 | 74.00 | -23.41 | 40.72 | 9.87 | Peak | --- |
| Freq. MHz | Emission level dBuV/m | Limit dBuV/m | Margin dB | SA reading dBuV | Factor dB | Remark | ANT High cm | Turn Table deg | | | | | | | | | | | | | | | | | | | | | | | | | | | | | | | | | | | | | | | | | | | | | | | | | | | | | | | | |
| 1 | 2390.00 | 52.56 | 54.00 | -1.44 | 55.46 | -2.90 | Average | --- | | | | | | | | | | | | | | | | | | | | | | | | | | | | | | | | | | | | | | | | | | | | | | | | | | | | | | | | |
| 2 | 2390.00 | 72.45 | 74.00 | -1.55 | 75.35 | -2.90 | Peak | --- | | | | | | | | | | | | | | | | | | | | | | | | | | | | | | | | | | | | | | | | | | | | | | | | | | | | | | | | |
| 3 | 4844.00 | 35.88 | 54.00 | -18.12 | 31.17 | 4.71 | Average | --- | | | | | | | | | | | | | | | | | | | | | | | | | | | | | | | | | | | | | | | | | | | | | | | | | | | | | | | | |
| 4 | 4844.00 | 46.21 | 74.00 | -27.79 | 41.50 | 4.71 | Peak | --- | | | | | | | | | | | | | | | | | | | | | | | | | | | | | | | | | | | | | | | | | | | | | | | | | | | | | | | | |
| 5 | 7500.00 | 40.26 | 54.00 | -13.74 | 30.39 | 9.87 | Average | --- | | | | | | | | | | | | | | | | | | | | | | | | | | | | | | | | | | | | | | | | | | | | | | | | | | | | | | | | |
| 6 | 7500.00 | 50.59 | 74.00 | -23.41 | 40.72 | 9.87 | Peak | --- | | | | | | | | | | | | | | | | | | | | | | | | | | | | | | | | | | | | | | | | | | | | | | | | | | | | | | | | |
| <p>Note 1: Emission Level (dBuV/m) = SA Reading (dBuV/m) + Factor* (dB) *Factor includes antenna factor , cable loss and amplifier gain Note 2: Margin (dB) = Emission level (dBuV/m) – Limit (dBuV/m).</p> | | | | | | | | | | | | | | | | | | | | | | | | | | | | | | | | | | | | | | | | | | | | | | | | | | | | | | | | | | | | | | | | |



| | | | |
|---------------------|----------|-------------------------|------|
| Polarization | Vertical | Test Freq. (MHz) | 2422 |
|---------------------|----------|-------------------------|------|

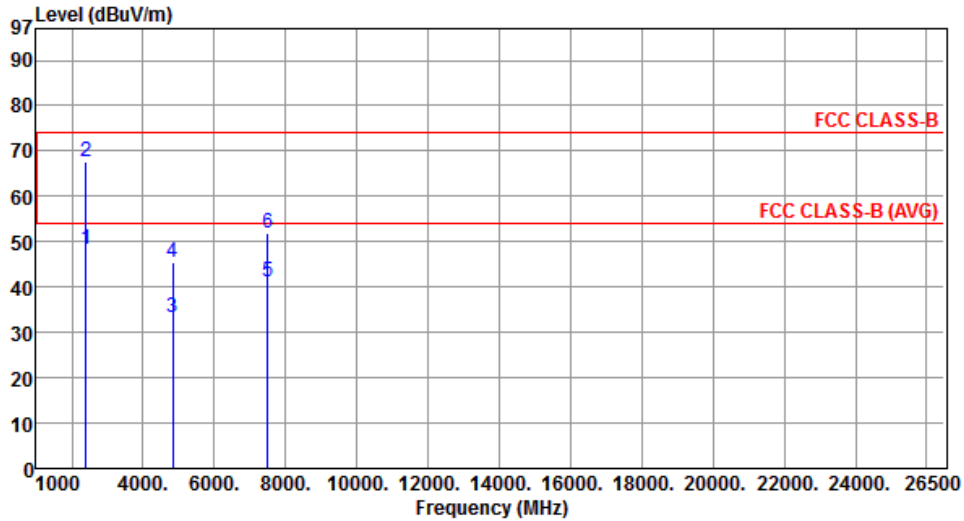

| | Freq. MHz | Emission level dBuV/m | Limit dBuV/m | Margin dB | SA reading dBuV | Factor dB | Remark | ANT High cm | Turn Table deg |
|---|--------------|-----------------------------|-----------------|--------------|-----------------------|--------------|---------|-------------------|----------------------|
| 1 | 2390.00 | 48.17 | 54.00 | -5.83 | 51.07 | -2.90 | Average | --- | --- |
| 2 | 2390.00 | 67.67 | 74.00 | -6.33 | 70.57 | -2.90 | Peak | --- | --- |
| 3 | 4844.00 | 33.15 | 54.00 | -20.85 | 28.44 | 4.71 | Average | --- | --- |
| 4 | 4844.00 | 45.52 | 74.00 | -28.48 | 40.81 | 4.71 | Peak | --- | --- |
| 5 | 7500.00 | 41.04 | 54.00 | -12.96 | 31.17 | 9.87 | Average | --- | --- |
| 6 | 7500.00 | 51.75 | 74.00 | -22.25 | 41.88 | 9.87 | Peak | --- | --- |

Note 1: Emission Level (dBuV/m) = SA Reading (dBuV/m) + Factor* (dB)

*Factor includes antenna factor , cable loss and amplifier gain

Note 2: Margin (dB) = Emission level (dBuV/m) – Limit (dBuV/m).



| | | | |
|---------------------|------------|-------------------------|------|
| Polarization | Horizontal | Test Freq. (MHz) | 2437 |
|---------------------|------------|-------------------------|------|

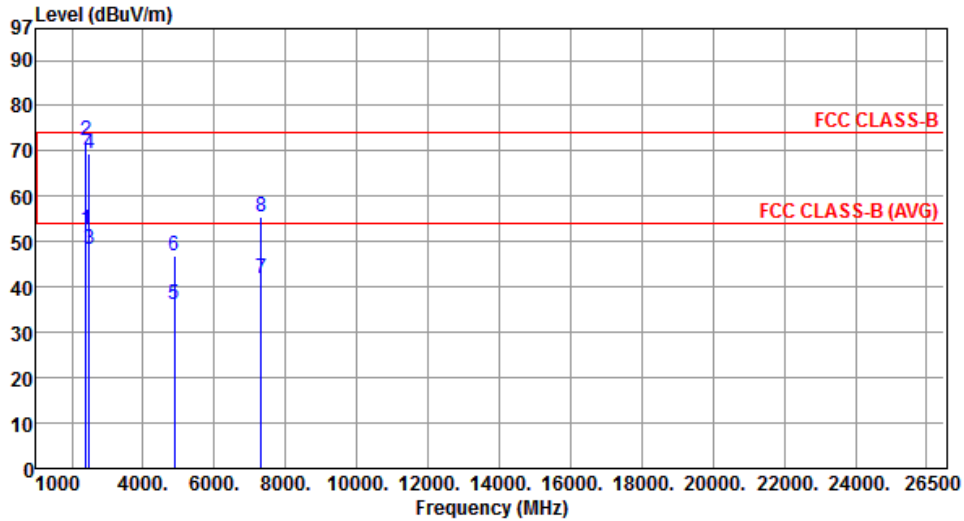

| | Freq. MHz | Emission level dBuV/m | Limit dBuV/m | Margin dB | SA reading dBuV | Factor dB | Remark | ANT High cm | Turn Table deg |
|---|--------------|-----------------------------|-----------------|--------------|-----------------------|--------------|---------|-------------------|----------------------|
| 1 | 2390.00 | 52.71 | 54.00 | -1.29 | 55.61 | -2.90 | Average | --- | --- |
| 2 | 2390.00 | 72.31 | 74.00 | -1.69 | 75.21 | -2.90 | Peak | --- | --- |
| 3 | 2483.50 | 48.48 | 54.00 | -5.52 | 50.90 | -2.42 | Average | --- | --- |
| 4 | 2483.50 | 69.28 | 74.00 | -4.72 | 71.70 | -2.42 | Peak | --- | --- |
| 5 | 4874.00 | 36.21 | 54.00 | -17.79 | 31.44 | 4.77 | Average | --- | --- |
| 6 | 4874.00 | 46.85 | 74.00 | -27.15 | 42.08 | 4.77 | Peak | --- | --- |
| 7 | 7311.00 | 41.79 | 54.00 | -12.21 | 32.22 | 9.57 | Average | --- | --- |
| 8 | 7311.00 | 55.43 | 74.00 | -18.57 | 45.86 | 9.57 | Peak | --- | --- |

Note 1: Emission Level (dBuV/m) = SA Reading (dBuV/m) + Factor* (dB)

*Factor includes antenna factor , cable loss and amplifier gain

Note 2: Margin (dB) = Emission level (dBuV/m) – Limit (dBuV/m).



| | | | |
|---------------------|----------|-------------------------|------|
| Polarization | Vertical | Test Freq. (MHz) | 2437 |
|---------------------|----------|-------------------------|------|

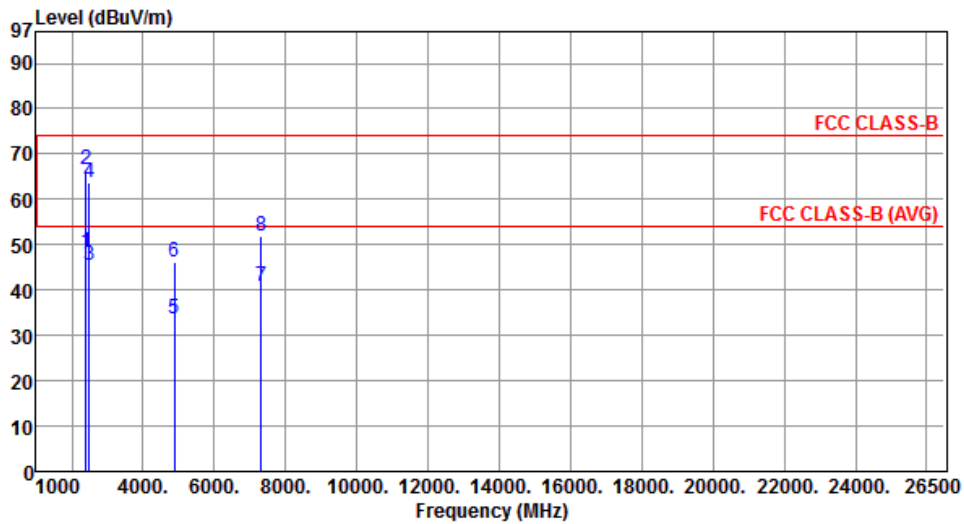

| | Freq. MHz | Emission level dBuV/m | Limit dBuV/m | Margin dB | SA reading dBuV | Factor dB | Remark | ANT High cm | Turn Table deg |
|---|--------------|-----------------------------|-----------------|--------------|-----------------------|--------------|---------|-------------------|----------------------|
| 1 | 2390.00 | 48.23 | 54.00 | -5.77 | 51.13 | -2.90 | Average | --- | --- |
| 2 | 2390.00 | 66.51 | 74.00 | -7.49 | 69.41 | -2.90 | Peak | --- | --- |
| 3 | 2483.50 | 45.48 | 54.00 | -8.52 | 47.90 | -2.42 | Average | --- | --- |
| 4 | 2483.50 | 63.88 | 74.00 | -10.12 | 66.30 | -2.42 | Peak | --- | --- |
| 5 | 4874.00 | 33.56 | 54.00 | -20.44 | 28.79 | 4.77 | Average | --- | --- |
| 6 | 4874.00 | 46.19 | 74.00 | -27.81 | 41.42 | 4.77 | Peak | --- | --- |
| 7 | 7311.00 | 40.87 | 54.00 | -13.13 | 31.30 | 9.57 | Average | --- | --- |
| 8 | 7311.00 | 52.06 | 74.00 | -21.94 | 42.49 | 9.57 | Peak | --- | --- |

Note 1: Emission Level (dBuV/m) = SA Reading (dBuV/m) + Factor* (dB)

*Factor includes antenna factor , cable loss and amplifier gain

Note 2: Margin (dB) = Emission level (dBuV/m) – Limit (dBuV/m).



| | | | |
|---------------------|------------|-------------------------|------|
| Polarization | Horizontal | Test Freq. (MHz) | 2452 |
|---------------------|------------|-------------------------|------|

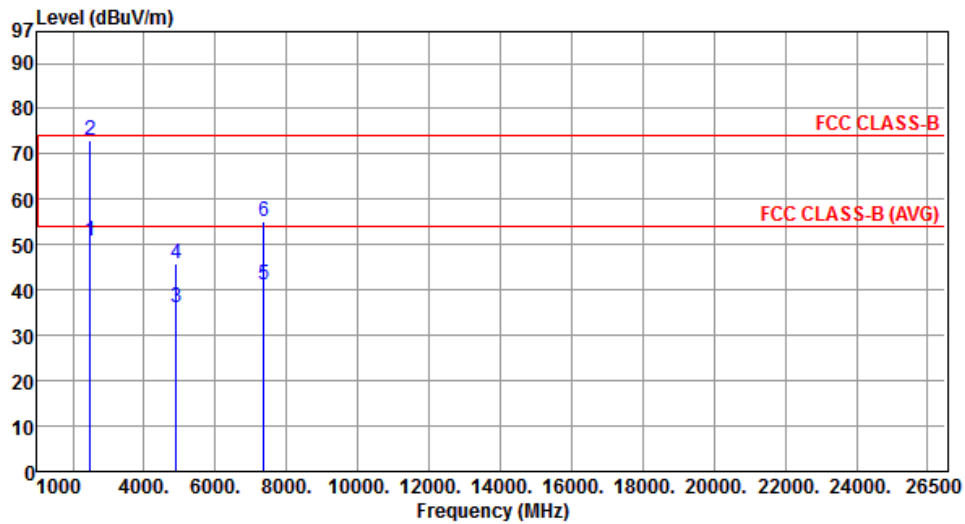

| | Freq. MHz | Emission level dBuV/m | Limit dBuV/m | Margin dB | SA reading dBuV | Factor dB | Remark | ANT High cm | Turn Table deg |
|---|--------------|-----------------------------|-----------------|--------------|-----------------------|--------------|---------|-------------------|----------------------|
| 1 | 2483.50 | 50.98 | 54.00 | -3.02 | 53.40 | -2.42 | Average | --- | --- |
| 2 | 2483.50 | 72.88 | 74.00 | -1.12 | 75.30 | -2.42 | Peak | --- | --- |
| 3 | 4904.00 | 36.22 | 54.00 | -17.78 | 31.40 | 4.82 | Average | --- | --- |
| 4 | 4904.00 | 45.88 | 74.00 | -28.12 | 41.06 | 4.82 | Peak | --- | --- |
| 5 | 7356.00 | 41.15 | 54.00 | -12.85 | 31.52 | 9.63 | Average | --- | --- |
| 6 | 7356.00 | 55.24 | 74.00 | -18.76 | 45.61 | 9.63 | Peak | --- | --- |

Note 1: Emission Level (dBuV/m) = SA Reading (dBuV/m) + Factor* (dB)

*Factor includes antenna factor , cable loss and amplifier gain

Note 2: Margin (dB) = Emission level (dBuV/m) – Limit (dBuV/m).



| | | | |
|---------------------|----------|-------------------------|------|
| Polarization | Vertical | Test Freq. (MHz) | 2452 |
|---------------------|----------|-------------------------|------|

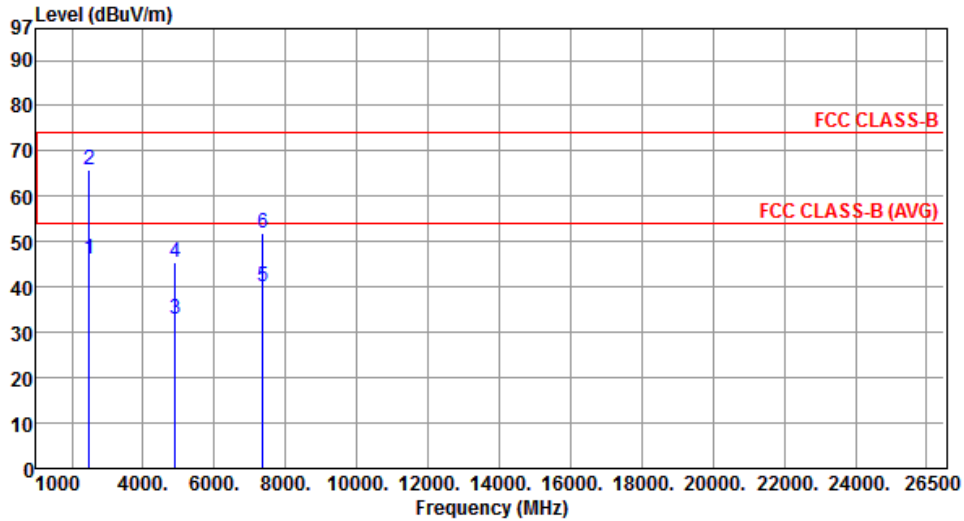

| | Freq. MHz | Emission level dBuV/m | Limit dBuV/m | Margin dB | SA reading dBuV | Factor dB | Remark | ANT High cm | Turn Table deg |
|---|--------------|-----------------------------|-----------------|--------------|-----------------------|--------------|---------|-------------------|----------------------|
| 1 | 2483.50 | 46.08 | 54.00 | -7.92 | 48.50 | -2.42 | Average | --- | --- |
| 2 | 2483.50 | 65.98 | 74.00 | -8.02 | 68.40 | -2.42 | Peak | --- | --- |
| 3 | 4904.00 | 33.02 | 54.00 | -20.98 | 28.20 | 4.82 | Average | --- | --- |
| 4 | 4904.00 | 45.43 | 74.00 | -28.57 | 40.61 | 4.82 | Peak | --- | --- |
| 5 | 7356.00 | 40.23 | 54.00 | -13.77 | 30.60 | 9.63 | Average | --- | --- |
| 6 | 7356.00 | 51.76 | 74.00 | -22.24 | 42.13 | 9.63 | Peak | --- | --- |

Note 1: Emission Level (dBuV/m) = SA Reading (dBuV/m) + Factor* (dB)

*Factor includes antenna factor , cable loss and amplifier gain

Note 2: Margin (dB) = Emission level (dBuV/m) – Limit (dBuV/m).



3.6 Emissions in non-restricted frequency bands

3.6.1 Emissions in non-restricted frequency bands limit

Peak power in any 100 kHz bandwidth outside of the authorized frequency band shall be attenuated by at least 30 dB relative to the maximum in-band peak PSD level in 100 kHz

3.6.2 Measuring Instruments

Refer a test equipment and calibration data table in this test report.

3.6.3 Test Procedures

Reference level measurement

1. Set RBW=100kHz, VBW = 300kHz , Detector = Peak, Sweep time = Auto
2. Trace = max hold , Allow Trace to fully stabilize
3. Use the peak marker function to determine the maximum PSD level

Emission level measurement

1. Set RBW=100kHz, VBW = 300kHz , Detector = Peak, Sweep time = Auto
2. Trace = max hold , Allow Trace to fully stabilize
3. Scan Frequency range is up to 26.5GHz
4. Use the peak marker function to determine the maximum amplitude level

3.6.4 Test Setup

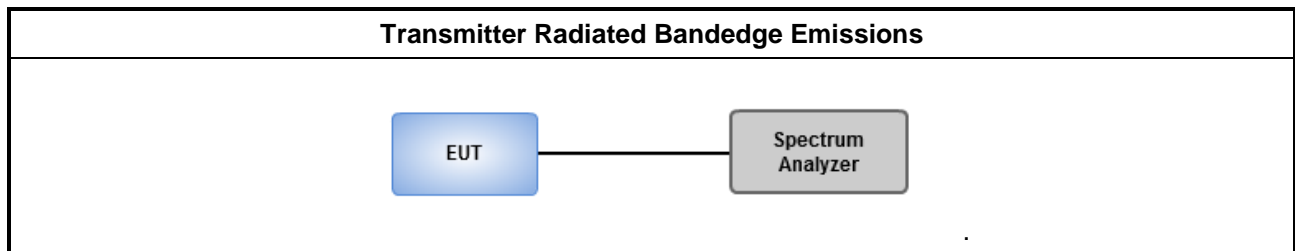

3.6.5 Test Result of Emissions in non-restricted frequency bands

This test item is performed on each TX output individually without summing or adding $10 \log(N_{ANT})$ since measurements are made relative to the in-band emissions on the individual outputs. Only worst test result of each operating mode is presented.



802.11b

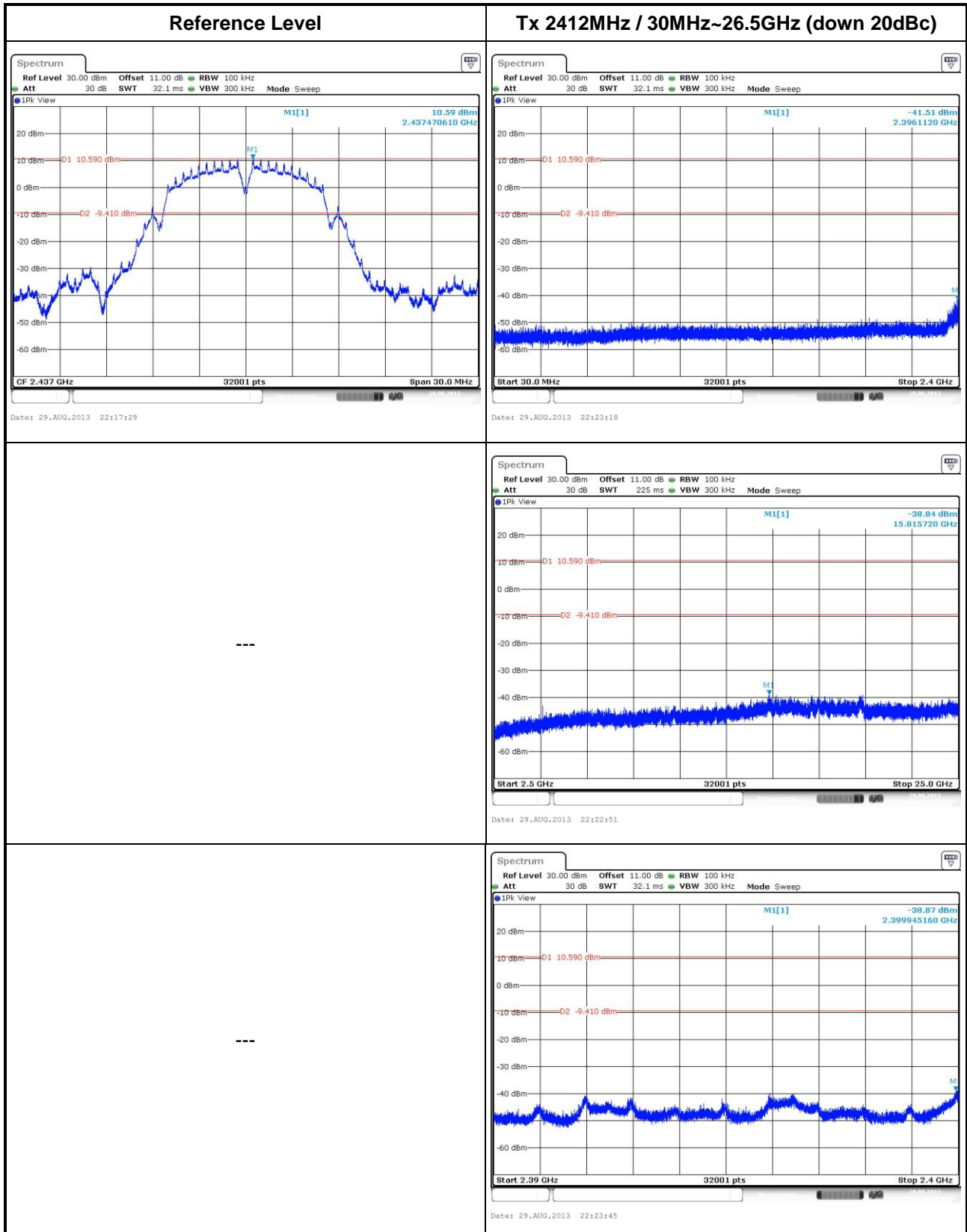

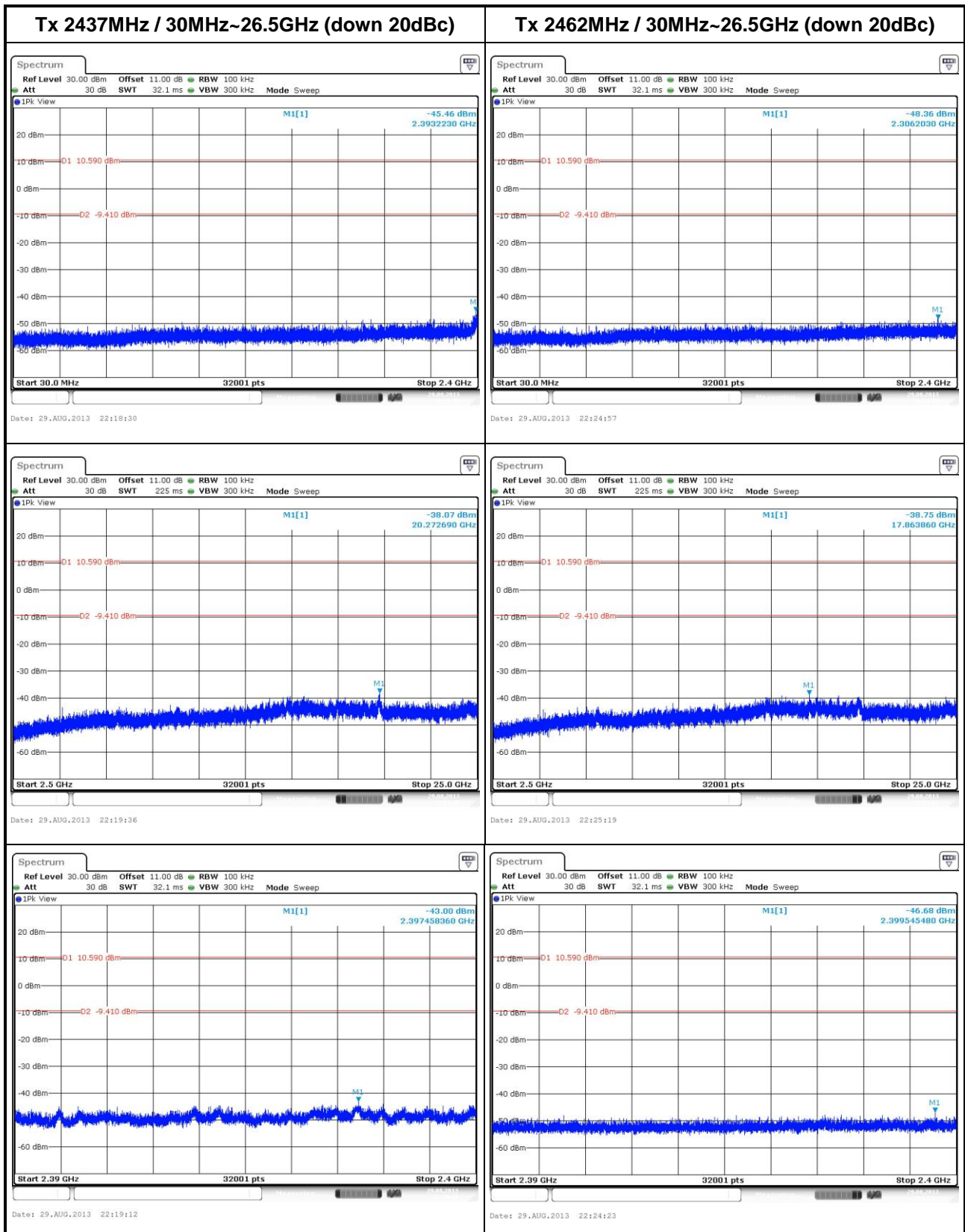



802.11g

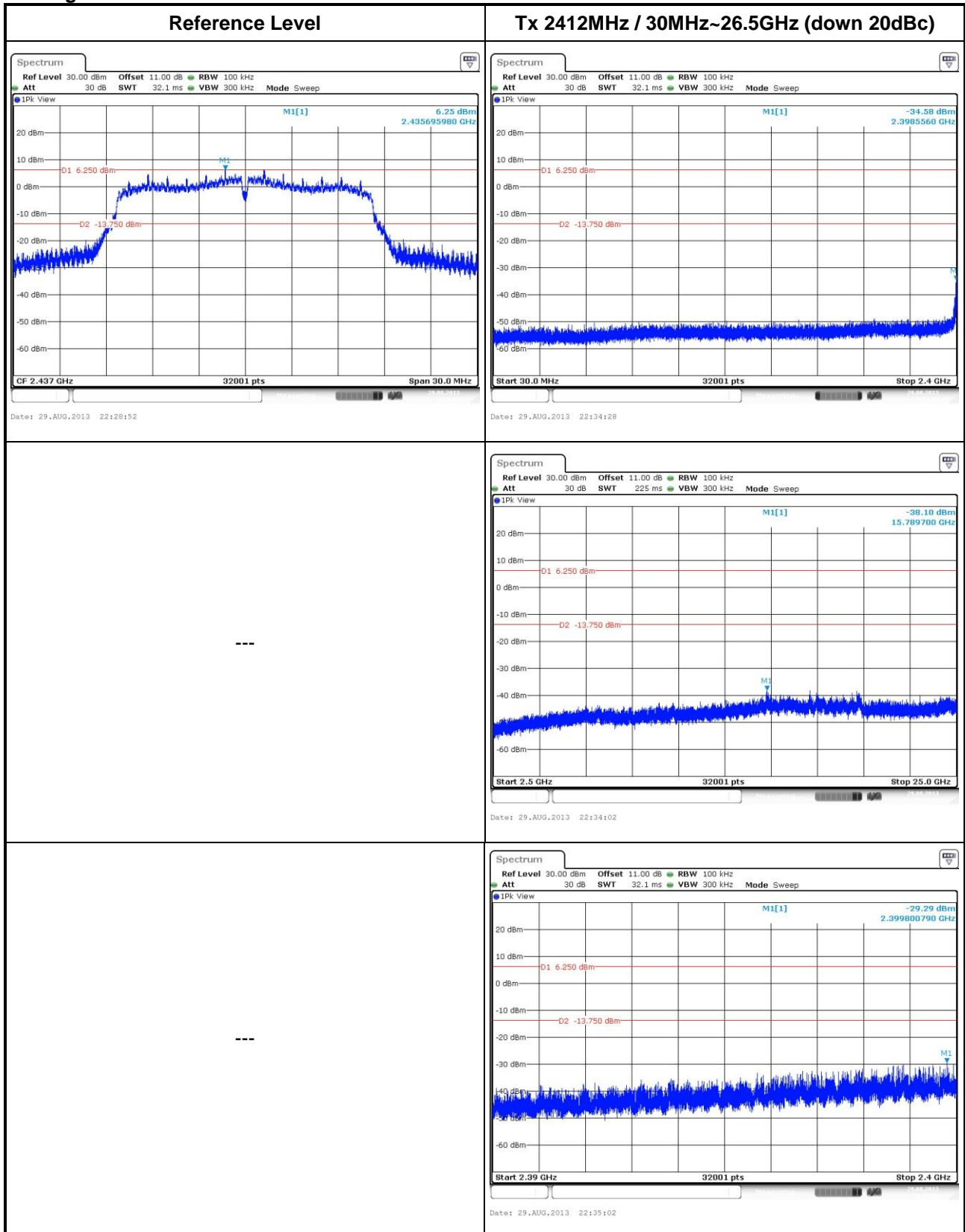

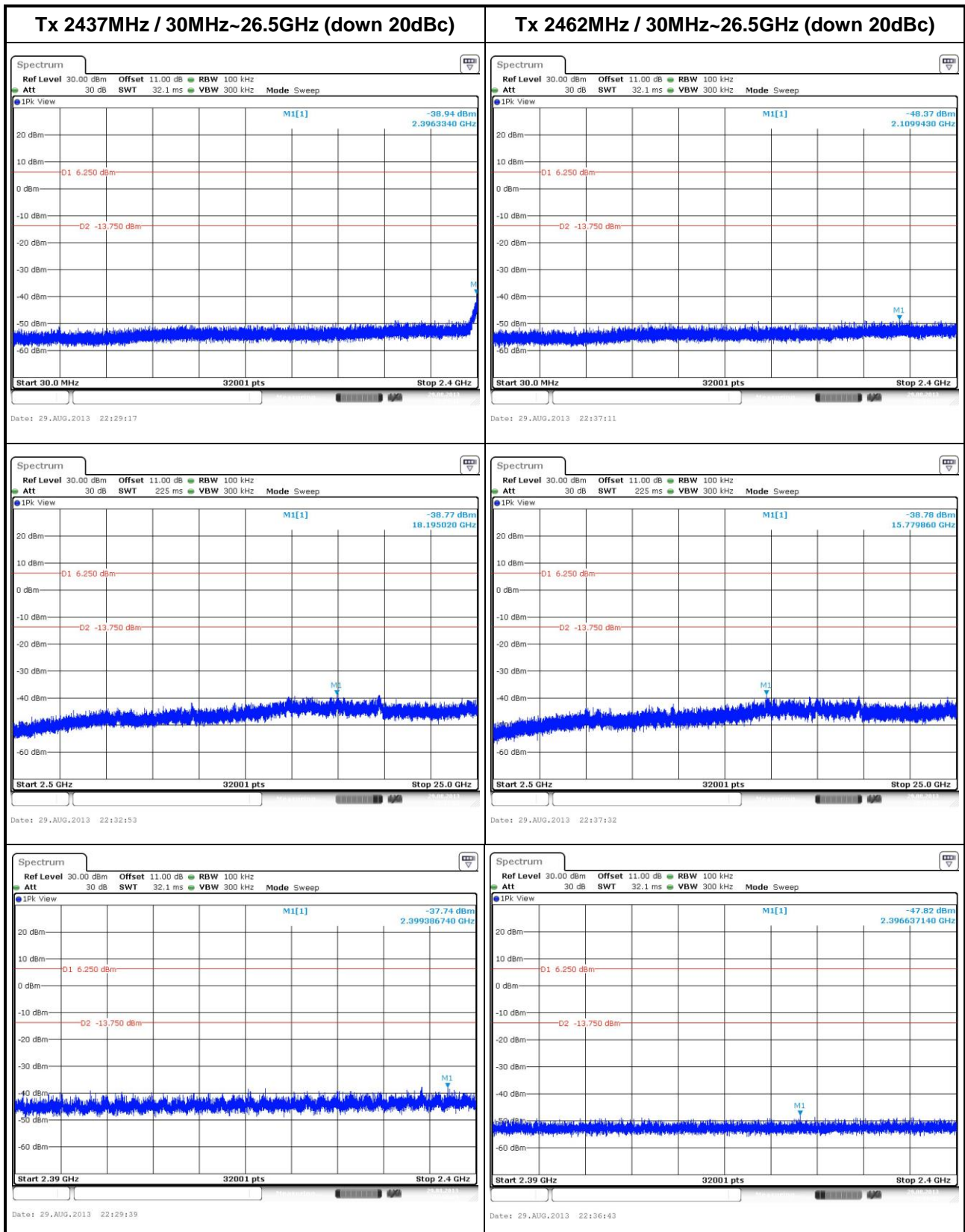



802.11n HT20

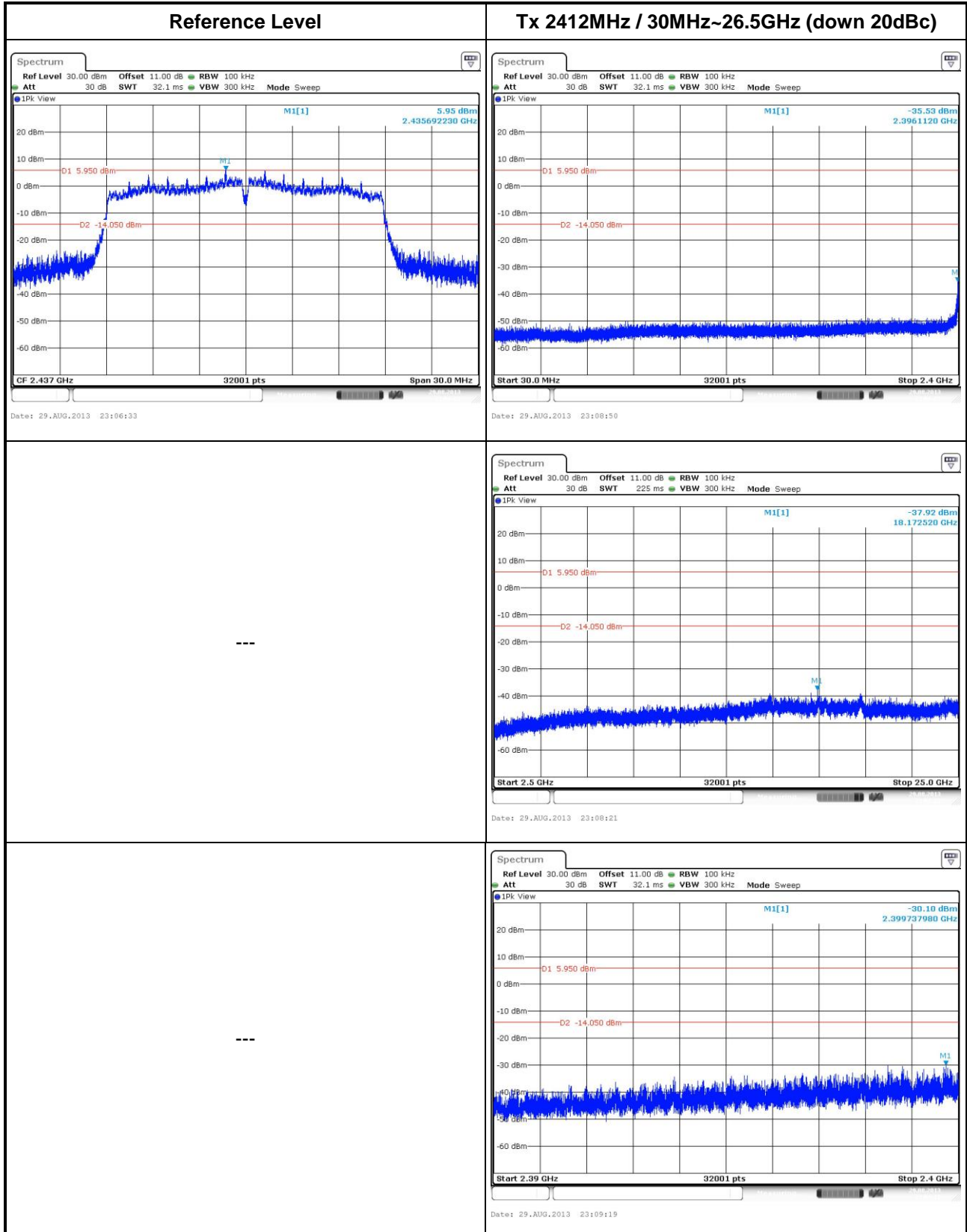

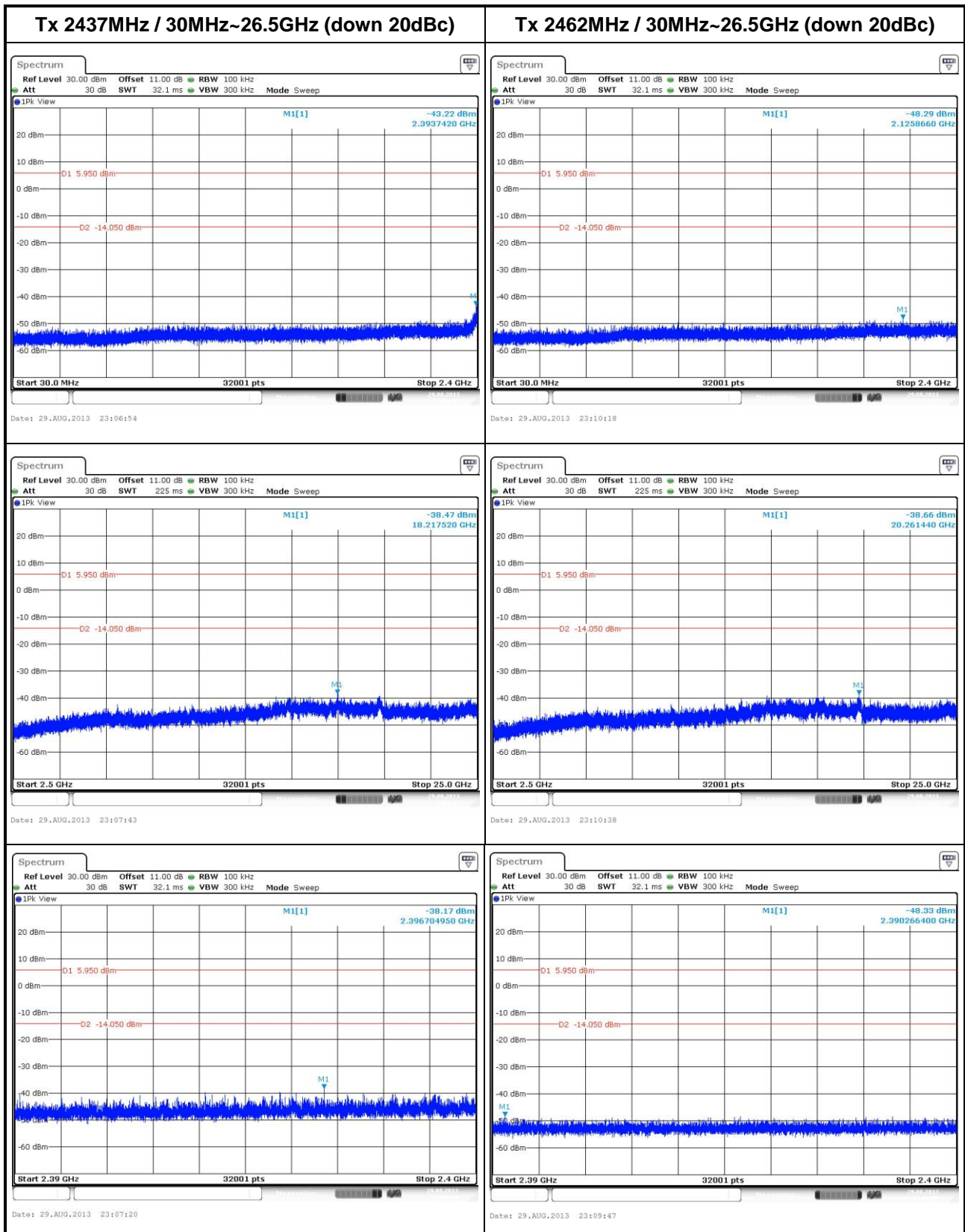



802.11n HT40

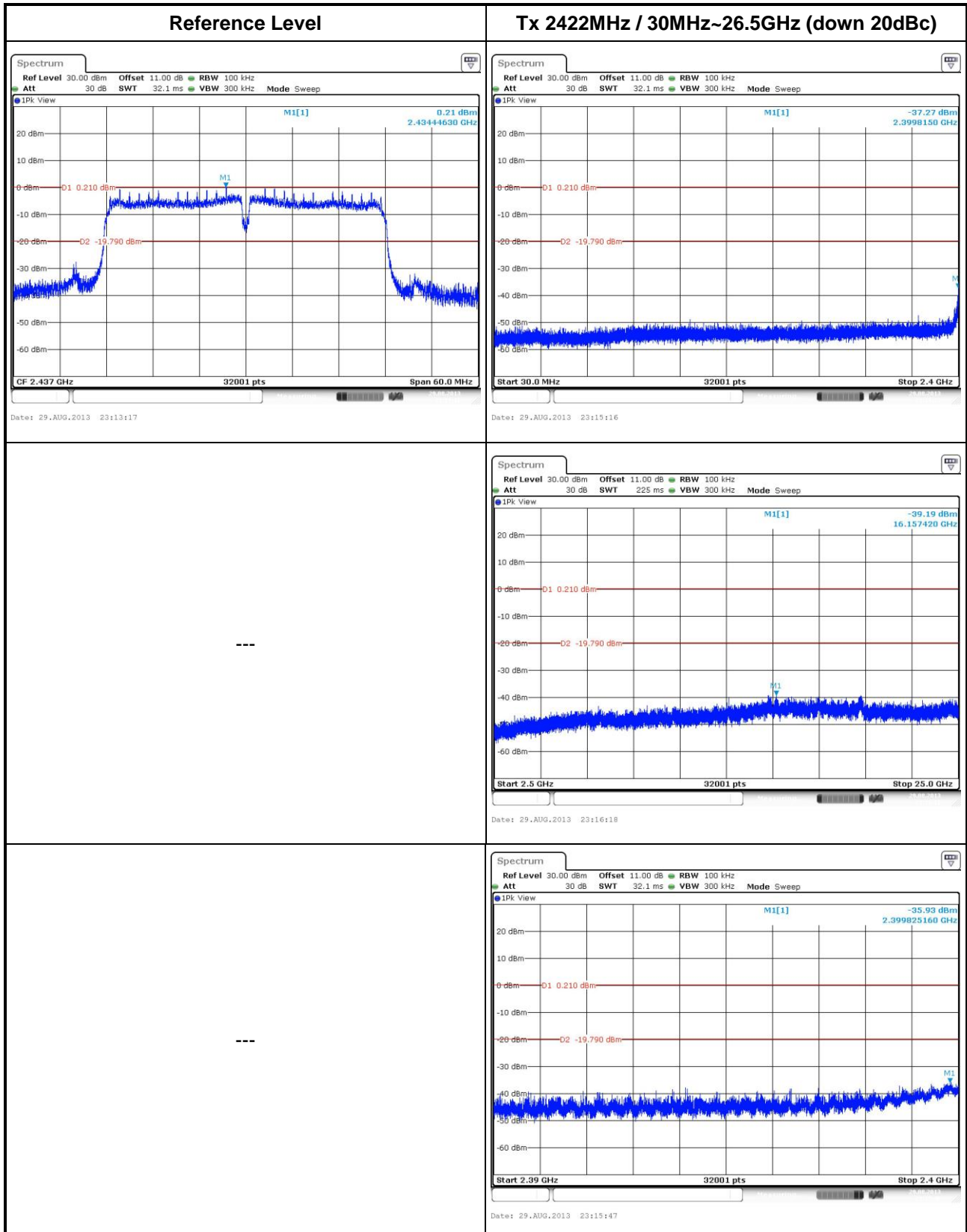

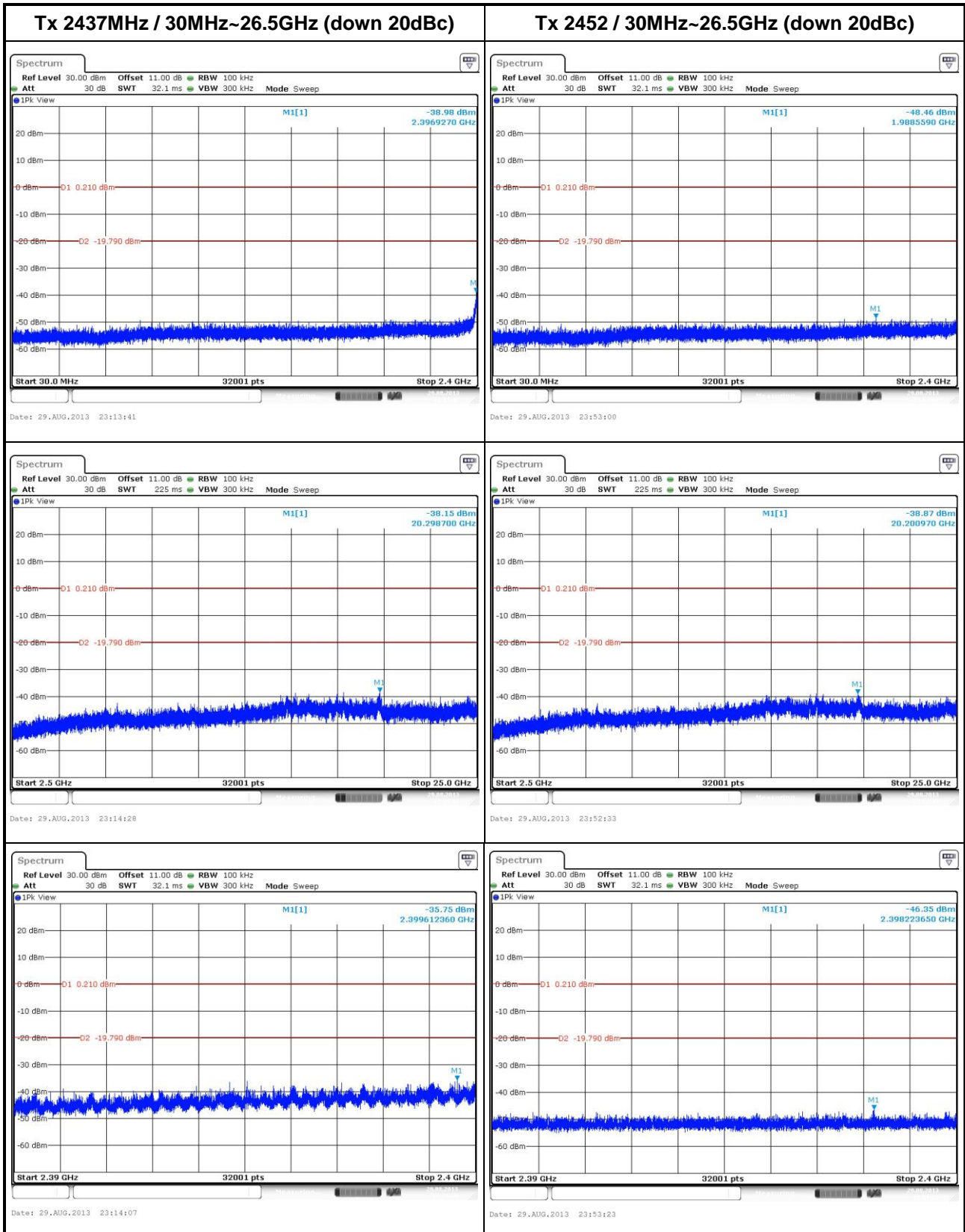

==END==