

FCC Test Report

Report No.: RF180123D04A

FCC ID: NKR-RI03

Test Model: UMD-RI03

Series Model: UMD-RI03-L, UMD-RI03-R

Received Date: Jan. 23, 2018

Test Date: Feb. 02 to 12, 2018

Issued Date: Feb. 27, 2018

Applicant: Wistron NeWeb Corporation

Address: 20 Park Avenue II, Hsinchu Science Park, Hsinchu 308, Taiwan, R.O.C.

Issued By: Bureau Veritas Consumer Products Services (H.K.) Ltd., Taoyuan Branch
Hsin Chu Laboratory

Lab Address: E-2, No.1, Li Hsin 1st Road, Hsinchu Science Park, Hsinchu City 300,
Taiwan R.O.C.

Test Location : E-2, No.1, Li Hsin 1st Road, Hsinchu Science Park, Hsinchu City 300,
Taiwan R.O.C.

**FCC Registration /
Designation Number:** 723255 / TW2022



This report is for your exclusive use. Any copying or replication of this report to or for any other person or entity, or use of our name or trademark, is permitted only with our prior written permission. This report sets forth our findings solely with respect to the test samples identified herein. The results set forth in this report are not indicative or representative of the quality or characteristics of the lot from which a test sample was taken or any similar or identical product unless specifically and expressly noted. Our report includes all of the tests requested by you and the results thereof based upon the information that you provided to us. You have 60 days from date of issuance of this report to notify us of any material error or omission caused by our negligence, provided, however, that such notice shall be in writing and shall specifically address the issue you wish to raise. A failure to raise such issue within the prescribed time shall constitute your unqualified acceptance of the completeness of this report, the tests conducted and the correctness of the report contents. Unless specific mention, the uncertainty of measurement has been explicitly taken into account to declare the compliance or non-compliance to the specification. The report must not be used by the client to claim product certification, approval, or endorsement by TAF or any government agencies.

Table of Contents

Release Control Record	3
1 Certificate of Conformity	4
2 Summary of Test Results	5
2.1 Measurement Uncertainty	5
2.2 Modification Record	5
3 General Information	6
3.1 General Description of EUT	6
3.2 Description of Test Modes	7
3.2.1 Test Mode Applicability and Tested Channel Detail	8
3.3 Description of Support Units	10
3.3.1 Configuration of System under Test	11
3.4 General Description of Applied Standards	12
4 Test Types and Results	13
4.1 Radiated Emission and Bandedge Measurement	13
4.1.1 Limits of Radiated Emission and Bandedge Measurement	13
4.1.2 Test Instruments	14
4.1.3 Test Procedures	16
4.1.4 Deviation from Test Standard	18
4.1.5 Test Setup	18
4.1.6 EUT Operating Conditions	19
4.1.7 Test Results	20
4.2 Conducted Emission Measurement	32
4.2.1 Limits of Conducted Emission Measurement	32
4.2.2 Test Instruments	32
4.2.3 Test Procedures	33
4.2.4 Deviation from Test Standard	33
4.2.5 Test Setup	33
4.2.6 EUT Operating Conditions	33
4.2.7 Test Results	34
4.3 20dB bandwidth	36
4.3.1 Limits of 20dB bandwidth Measurement	36
4.3.2 Test Setup	36
4.3.3 Test Instruments	36
4.3.4 Test Procedures	36
4.3.5 Deviation from Test Standard	36
4.3.6 EUT Operating Conditions	36
4.3.7 Test Results	37
5 Pictures of Test Arrangements	38
Appendix – Information on the Testing Laboratories	39

Release Control Record

Issue No.	Description	Date Issued
RF180123D04A	Original release.	Feb. 27, 2018

1 Certificate of Conformity

Product: 24GHZ Blind spot warning system

Brand: WNC

Test Model: UMD-RI03

Series Model: UMD-RI03-L, UMD-RI03-R

Sample Status: ENGINEERING SAMPLE

Applicant: Wistron NeWeb Corporation

Test Date: Feb. 02 to 12, 2018

Standards: 47 CFR FCC Part 15, Subpart C (Section 15.249)
ANSI C63.10: 2013

The above equipment has been tested by **Bureau Veritas Consumer Products Services (H.K.) Ltd., Taoyuan Branch**, and found compliance with the requirement of the above standards. The test record, data evaluation & Equipment Under Test (EUT) configurations represented herein are true and accurate accounts of the measurements of the sample's EMC characteristics under the conditions specified in this report.

Prepared by : Wendy Wu , **Date:** Feb. 27, 2018
Wendy Wu / Specialist

Approved by : May Chen , **Date:** Feb. 27, 2018
May Chen / Manager

2 Summary of Test Results

47 CFR FCC Part 15, Subpart C (SECTION 15.249)			
FCC Clause	Test Item	Result	Remarks
15.207	AC Power Conducted Emission	PASS	Meet the requirement of limit. Minimum passing margin is -37.40dB at 20.80859MHz.
15.209 15.249 15.249 (d)	Radiated Emission Test Band Edge Measurement Limit: 50dB less than the peak value of fundamental frequency or meet radiated emission limit in section 15.209	PASS	Meet the requirement of limit. Minimum passing margin is -3.9dB at 24250.00MHz.

2.1 Measurement Uncertainty

Where relevant, the following measurement uncertainty levels have been estimated for tests performed on the EUT as specified in CISPR 16-4-2:

Measurement	Frequency	Expanded Uncertainty (k=2) (\pm)
Conducted Emissions at mains ports	150kHz ~ 30MHz	1.84 dB
Radiated Emissions up to 1 GHz	30MHz ~ 1GHz	5.33 dB
Radiated Emissions above 1 GHz	1GHz ~ 6GHz	5.08 dB
	6GHz ~ 18GHz	4.98 dB
	18GHz ~ 40GHz	5.19 dB

2.2 Modification Record

There were no modifications required for compliance.

3 General Information

3.1 General Description of EUT

Product	24GHZ Blind spot warning system
Brand	WNC
Test Model	UMD-RI03
Series Model	UMD-RI03-L, UMD-RI03-R
Status of EUT	ENGINEERING SAMPLE
Power Supply Rating	DC 12V
Modulation Type	FMCW
Operating Frequency	24.065 ~ 24.225GHz
Number of Channel	3
Antenna Type	Refer to Note
Antenna Connector	Refer to Note
Accessory Device	NA
Data Cable Supplied	DC cable x 1 (shielded, 1.6m)

Note:

1. The EUT has below model names, which are identical to each other in all aspects except for the following:

Model	Frequency range	Difference
UMD-RI03	24.065 ~ 24.225GHz	Hardware are the same, only the software to control the frequency range
UMD-RI03-L	24.075 ~ 24.225GHz	
UMD-RI03-R	24.065 ~ 24.215GHz	

From the above models, model: **UMD-RI03** was selected as representative model for the test and its data was recorded in this report.

2. The antenna provided to the EUT, please refer to the following table:

Brand	Model	Antenna Gain (dBi)	Antenna Type	Connector Type
WNC	NA	14	PCB printed (Patch)	NA

3. The above EUT information is declared by manufacturer and for more detailed features description, please refer to the manufacturer's specifications or user's manual.

3.2 Description of Test Modes

3 channels are provided in EUT for test:

Channel	Frequency
1	24.065GHz
2	24.145GHz
3	24.225GHz

3.2.1 Test Mode Applicability and Tested Channel Detail

EUT CONFIGURE MODE	APPLICABLE TO				DESCRIPTION
	RE \geq 1G	RE<1G	PLC	EB	
-	√	√	√	√	-

Where **RE \geq 1G**: Radiated Emission above 1GHz & Bandedge Measurement
RE<1G: Radiated Emission below 1GHz
PLC: Power Line Conducted Emission
EB: 20dB Bandwidth

NOTE: The EUT had been pre-tested on the positioned of each 3 axis. The worst case was found when positioned on Y-plane.

Radiated Emission Test (Above 1GHz):

- Pre-Scan has been conducted to determine the worst-case mode from all possible combinations between available modulations, data rates and antenna ports (if EUT with antenna diversity architecture).
- Following channel(s) was (were) selected for the final test as listed below.

TESTED CHANNEL	MODULATION TYPE
1, 2, 3	FMCW

Radiated Emission Test (Below 1GHz):

- Pre-Scan has been conducted to determine the worst-case mode from all possible combinations between available modulations, data rates and antenna ports (if EUT with antenna diversity architecture).
- Following channel(s) was (were) selected for the final test as listed below.

TESTED CHANNEL	MODULATION TYPE
1, 2, 3	FMCW

Power Line Conducted Emission Test:

- Pre-Scan has been conducted to determine the worst-case mode from all possible combinations between available modulations, data rates and antenna ports (if EUT with antenna diversity architecture).
- Following channel(s) was (were) selected for the final test as listed below.

TESTED CHANNEL	MODULATION TYPE
1	FMCW

20dB Bandwidth:

- This item includes all test value of each mode, but only includes spectrum plot of worst value of each mode.
- Pre-Scan has been conducted to determine the worst-case mode from all possible combinations between available modulations, data rates and antenna ports (if EUT with antenna diversity architecture).
- Following channel(s) was (were) selected for the final test as listed below.

TESTED CHANNEL	MODULATION TYPE
1	FMCW

Test Condition:

APPLICABLE TO	ENVIRONMENTAL CONDITIONS	INPUT POWER	TESTED BY
RE \geq 1G	22deg. C, 63%RH	DC 12V	Robert Cheng
RE<1G	23deg. C, 63%RH	DC 12V	Weiwei Lo
PLC	25deg. C, 75%RH	120Vac, 60Hz (system)	Andy Ho
EB	25deg. C, 60%RH	DC 12V	Jyunchun Lin

3.3 Description of Support Units

The EUT has been tested as an independent unit together with other necessary accessories or support units. The following support units or accessories were used to form a representative test configuration during the tests.

ID	Product	Brand	Model No.	Serial No.	FCC ID	Remarks
A	Adapter	Topward	6603D	795558	NA	Provided by Lab

Note:

1. All power cords of the above support units are non-shielded (1.8m).

ID	Descriptions	Qty.	Length (m)	Shielding (Yes/No)	Cores (Qty.)	Remarks
1	DC cable	1	1.6	No	0	Supplied by client

3.3.1 Configuration of System under Test

For conducted emission

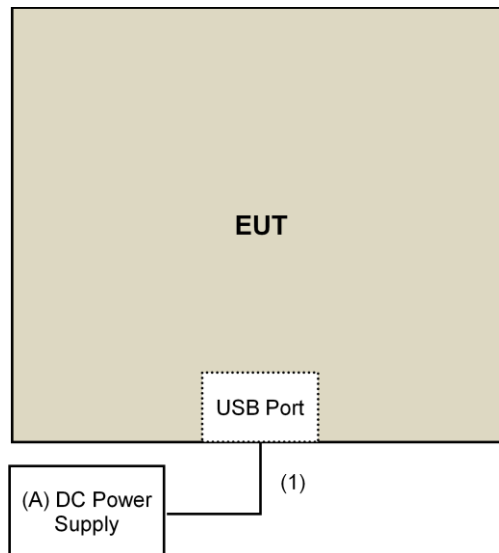

For radiated emission

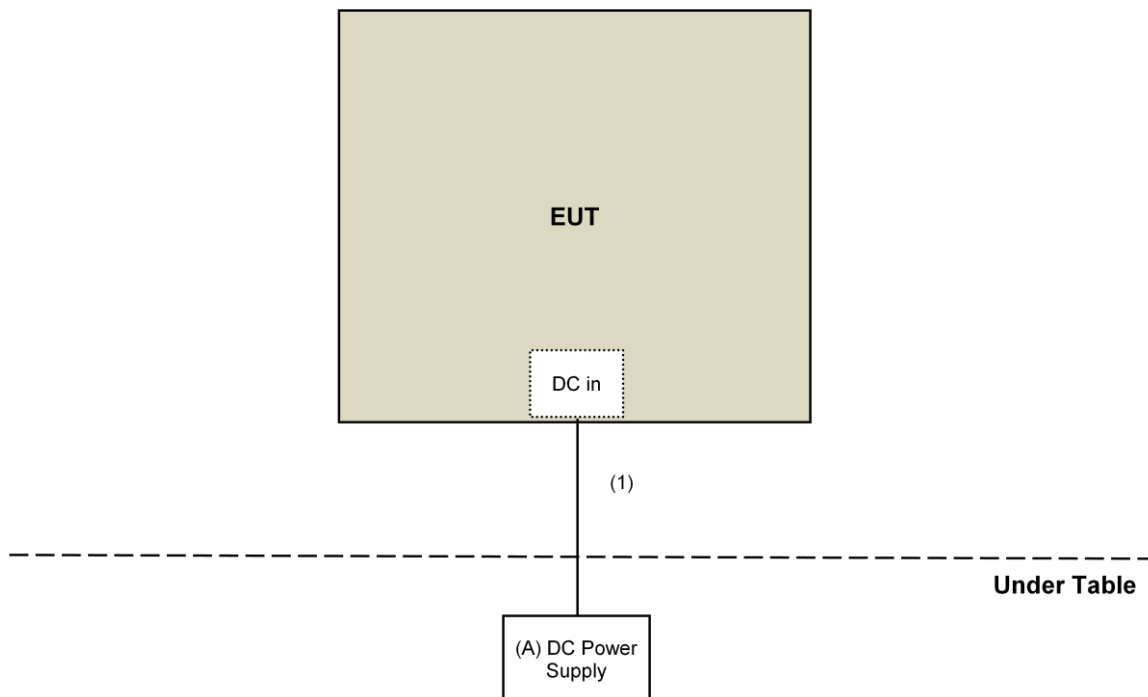

3.4 General Description of Applied Standards

The EUT is a RF Product. According to the specifications of the manufacturer, it must comply with the requirements of the following standards:

FCC Part 15, Subpart C (15.249)

ANSI C63.10-2013

All test items have been performed and recorded as per the above standards.

4 Test Types and Results

4.1 Radiated Emission and Bandedge Measurement

4.1.1 Limits of Radiated Emission and Bandedge Measurement

The field strength of emissions from intentional radiators operated within these frequency bands shall comply with the following

Fundamental Frequency	Field Strength of Fundamental (millivolts/meter)	Field Strength of Harmonics (microvolts/meter)
902 ~ 928 MHz	50	500
2400 ~ 2483.5 MHz	50	500
5725 ~ 5875 MHz	50	500
24 ~ 24.25 GHz	250	2500

Emissions radiated outside of the specified frequency bands, except for harmonics, shall be attenuated by at least 50 dB below the level of the fundamental or to the general radiated emission limits as below table, whichever is the lesser attenuation

Frequencies (MHz)	Field Strength (microvolts/meter)	Measurement Distance (meters)
0.009 ~ 0.490	2400/F(kHz)	300
0.490 ~ 1.705	24000/F(kHz)	30
1.705 ~ 30.0	30	30
30 ~ 88	100	3
88 ~ 216	150	3
216 ~ 960	200	3
Above 960	500	3

NOTE:

1. The lower limit shall apply at the transition frequencies.
2. Emission level (dBuV/m) = 20 log Emission level (uV/m).
3. For frequencies above 1000MHz, the field strength limits are based on average detector, however, the peak field strength of any emission shall not exceed the maximum permitted average limits, specified above by more than 20dB under any condition of modulation.

4.1.2 Test Instruments

Below 40GHz test:

DESCRIPTION & MANUFACTURER	MODEL NO.	SERIAL NO.	CALIBRATED DATE	CALIBRATED UNTIL
Test Receiver Agilent	N9038A	MY50010156	July 12, 2017	July 11, 2018
Loop Antenna ^(*) TESEQ	HLA 6121	45745	May 19, 2017	May 18, 2018
Pre-Amplifier Mini-Circuits	ZFL-1000VH2B	AMP-ZFL-05	May 06, 2017	May 05, 2018
Trilog Broadband Antenna SCHWARZBECK	VULB 9168	9168-361	Nov. 29, 2017	Nov. 28, 2018
RF Cable	8D	966-3-1 966-3-2 966-3-3	Apr. 01, 2017	Mar. 31, 2018
Fixed attenuator Mini-Circuits	UNAT-5+	PAD-3m-3-01	Oct. 03, 2017	Oct. 02, 2018
Horn_Antenna SCHWARZBECK	BBHA9120-D	9120D-406	Dec. 12, 2017	Dec. 11, 2018
Pre-Amplifier EMCI	EMC12630SE	980384	Jan. 29, 2018	Jan. 28, 2019
RF Cable	EMC104-SM-SM-1200 EMC104-SM-SM-2000 EMC104-SM-SM-5000	160922 150317 150322	Jan. 29, 2018 Jan. 29, 2018 Jan. 29, 2018	Jan. 28, 2019 Jan. 28, 2019 Jan. 28, 2019
Spectrum Analyzer Keysight	N9030A	MY54490679	July 25, 2017	July 24, 2018
Pre-Amplifier EMCI	EMC184045SE	980386	Jan. 29, 2018	Jan. 28, 2019
Horn_Antenna SCHWARZBECK	BBHA 9170	BBHA9170608	Dec. 14, 2017	Dec. 13, 2018
RF Cable	EMC102-KM-KM-1200	160924	Jan. 29, 2018	Jan. 28, 2019
Software	ADT_Radiated_V8.7.08	NA	NA	NA
Antenna Tower & Turn Table Max-Full	MF-7802	MF780208406	NA	NA
Boresight Antenna Fixture	FBA-01	FBA-SIP01	NA	NA

Note:

1. The calibration interval of the above test instruments is 12 months and the calibrations are traceable to NML/ROC and NIST/USA.
2. *The calibration interval of the above test instruments is 24 months and the calibrations are traceable to NML/ROC and NIST/USA.
3. The test was performed in 966 Chamber No. 3.
4. The CANADA Site Registration No. is 20331-1
5. Loop antenna was used for all emissions below 30 MHz.
6. Tested Date: Feb. 05 to 10, 2018

Above 40GHz test:

DESCRIPTION & MANUFACTURER	MODEL NO.	SERIAL NO.	CALIBRATED DATE	CALIBRATED UNTIL
Spectrum Analyzer Agilent	E4446A	MY48250254	Nov. 21, 2017	Nov. 20, 2018
*Harmonic Mixer (33~55GHz) OML	M22HWD	110215-1	Oct. 17, 2017	Oct. 16, 2019
*Horn Antenna (33~55GHz) OML	M22RH	110215-1	Oct. 17, 2017	Oct. 16, 2019
*Harmonic Mixer (50~75GHz) OML	M15RH	110215-1	Oct. 17, 2017	Oct. 16, 2019
*Horn Antenna (50~75GHz) OML	M15HWD	110215-1	Oct. 17, 2017	Oct. 16, 2019
*Harmonic Mixer (75~110GHz) OML	M10HWD	110215-1	Oct. 17, 2017	Oct. 16, 2019
*Horn Antenna (75~110GHz) OML	M10RH	110215-1	Oct. 17, 2017	Oct. 16, 2019
*Diplexer EMCI	DPL26	DPL26_01	Oct. 17, 2017	Oct. 16, 2019
*Diplexer EMCI	DPL26	DPL26_02	Oct. 17, 2017	Oct. 16, 2019
*Precision 30dB Attenuator Keysight	11708A	MY55260015	Oct. 17, 2017	Oct. 16, 2019
*Zero-Bias Detector (50~75GHz) Vdi	WR15ZBD	WR15R5 1-30	Oct. 17, 2017	Oct. 16, 2019
4CH Infiniivision Oscilloscope Keysight	DSOX6004A	MY55190202	Dec. 13, 2017	Dec. 12, 2018
*WR15CH Conical Horn Keysight	WR15CH	WR15CH-01	Oct. 17, 2017	Oct. 16, 2019
*WR10CH Conical Horn Keysight	WR10CH	WR10CH-01	Oct. 17, 2017	Oct. 16, 2019
*Millimeter-Wave Signal Generator Frequency Extension Module (50~75 GHz) Keysight	E8257DV15	US54250106	Oct. 17, 2017	Oct. 16, 2019
*Millimeter-Wave Signal Generator Frequency Extension Module (75~110 GHz) Keysight	E8257DV10	US53250009	Oct. 17, 2017	Oct. 16, 2019
Antenna Tower & Turn Table CT	NA	NA	NA	NA

Note:

1. The calibration interval of the above test instruments is 12 months and the calibrations are traceable to NML/ROC and NIST/USA.
2. *The calibration interval of the above test instruments is 24 months and the calibrations are traceable to NML/ROC and NIST/USA.
3. The test was performed in 966 Chamber No. 3
4. The CANADA Site Registration No. is 20331-2
5. Tested Date: Feb. 02, 2018

4.1.3 Test Procedures

For Radiated emission: Below 30MHz

- a. The EUT was placed on the top of a rotating table 0.8 meters above the ground at a 3 meter chamber room. The table was rotated 360 degrees to determine the position of the highest radiation.
- b. The EUT was set 3 meters away from the interference-receiving antenna, which was mounted on the top of a variable-height antenna tower.
- c. Both X and Y axes of the antenna are set to make the measurement.
- d. For each suspected emission, the EUT was arranged to its worst case and the rotatable table was turned from 0 degrees to 360 degrees to find the maximum reading.
- e. The test-receiver system was set to Quasi-Peak Detect Function and Specified Bandwidth with Maximum Hold Mode.

NOTE:

1. The resolution bandwidth and video bandwidth of test receiver/spectrum analyzer is 9kHz at frequency below 30MHz.

For Radiated emission: 30MHz ~ 40GHz

- a. The EUT was placed on the top of a rotating table 0.8 meters (for 30MHz ~ 1GHz) / 1.5 meters (for above 1GHz) above the ground at 3 meter chamber room for test. The table was rotated 360 degrees to determine the position of the highest radiation.
- b. The EUT was set 3 meters away from the interference-receiving antenna, which was mounted on the top of a variable-height antenna tower.
- c. The height of antenna is varied from one meter to four meters above the ground to determine the maximum value of the field strength. Both horizontal and vertical polarizations of the antenna are set to make the measurement.
- d. For each suspected emission, the EUT was arranged to its worst case and then the antenna was tuned to heights from 1 meter to 4 meters and the rotatable table was turned from 0 degrees to 360 degrees to find the maximum reading.
- e. The test-receiver system was set to quasi-peak detect function and specified bandwidth with maximum hold mode when the test frequency is below 1 GHz.
- f. The test-receiver system was set to peak and average detect function and specified bandwidth with maximum hold mode when the test frequency is above 1 GHz. If the peak reading value also meets average limit, measurement with the average detector is unnecessary.

Note:

1. The resolution bandwidth and video bandwidth of test receiver/spectrum analyzer is 120kHz for Quasi-peak detection (QP) at frequency below 1GHz.
2. The resolution bandwidth is 1MHz and video bandwidth of test receiver/spectrum analyzer is 3MHz for Peak detection (PK) at frequency from 1GHz to 40GHz.
3. The resolution bandwidth is 1MHz and video bandwidth of test receiver/spectrum analyzer is 3MHz for Average detection (AV) at frequency from 1GHz to 40GHz.
4. All modes of operation were investigated and the worst-case emissions are reported.

For Radiated emission: Above 40GHz

External harmonic mixers are utilized.

- a. The EUT was placed on the top of a rotating table 1.5 meters above the ground at a 3 meters chamber room. The table was rotated 360 degrees to determine the position of the highest radiation.
- b. The distance at which limits are typically specified is 3 meter; however, closer measurement distances may be utilized.
- c. Begin handheld measurements with the test antenna (horn) at a distance of 1 meter from the EUT, in a horizontally polarized position. Slowly adjust its position, entirely covering the plane 1 meter from the EUT.
- d. Repeat (b) with the horn in a vertically polarized position.
- e. If the emission cannot be detected at 1 meter, reduce the RBW in order to increase system sensitivity. Note the value. If the emission still cannot be detected, move the horn closer to the EUT, noting the distance at which a measurement is made.
- f. Note the maximum level indicated on the Spectrum Analyzer.
- g. Based on the distance at which the measurement was made and the calculated distance to the edge of the far field, determine the appropriate distance attenuation factor. Apply this factor to the calculated field strength in order to determine the equivalent field strength at the distance at which the regulatory limit is specified. Compare to the appropriate limits
- h. Repeat (a) - (f) for every emission that must be measured, up through the required frequency range of investigation

NOTE:

1. The resolution bandwidth is 1MHz and video bandwidth of test receiver/spectrum analyzer is 3MHz for Peak and Average detection at frequency above 40GHz.
2. Shorter measurement distances may be used to improve the measurement system's noise floor. As ANSI C63.10 description is based on the measurement in distance of 3 meters, the data obtained at 1 meter distance was extrapolate results to the 3-m distance:

Test value at 3-meter distance (dBuV)

= Test value at 1 meter distance (dBuV) -20log(3/1)(dB)

= Test value at 1 meter distance (dBuV) -9.5(dB).

* Measurements made at 1 meter distance. Test value converted to account for 3-meter measurement distance.

FAR FIELD BOUNDARY CALCULATIONS

The far-field boundary is given as:

$$R \text{ far field} = (2 * L^2) / \lambda$$

where: L = Largest Antenna Dimension, including the reflector, in meters

λ = wavelength in meters

FREQUENCY (GHz)	L (m)	Lambda (m)	R (Far Field) (m)
24.065	0.03	0.0125	0.144
24.145	0.03	0.0124	0.1452
24.225	0.03	0.0124	0.1452

4.1.4 Deviation from Test Standard

No deviation.

4.1.5 Test Setup

For Radiated emission below 30MHz

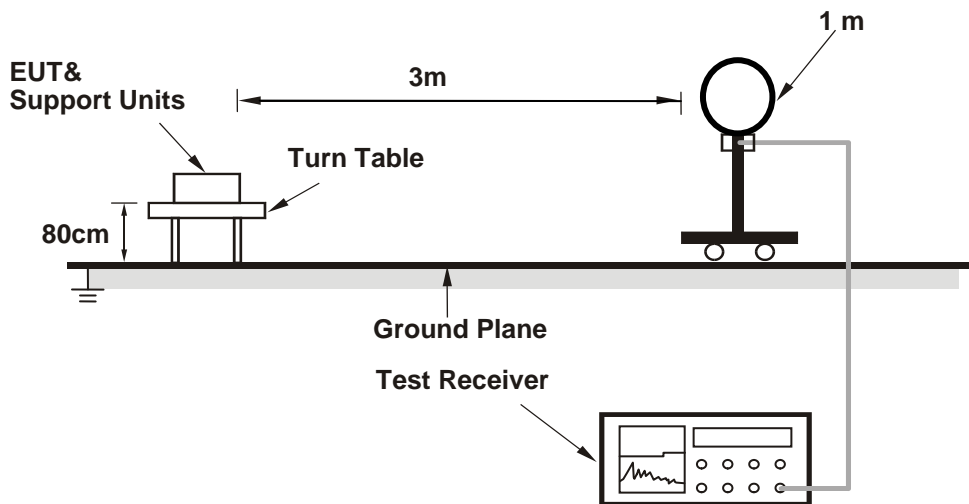

For Radiated emission 30MHz to 1GHz

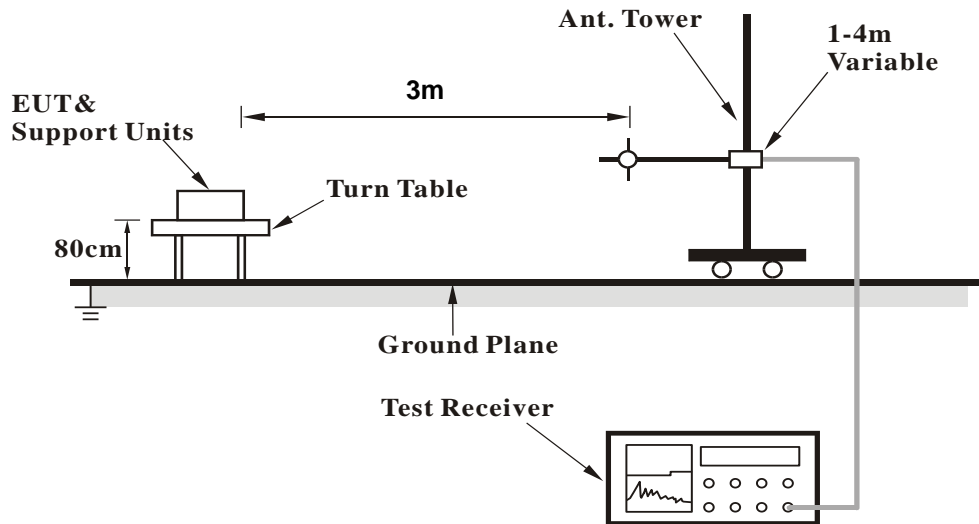

For Radiated emission above 1GHz

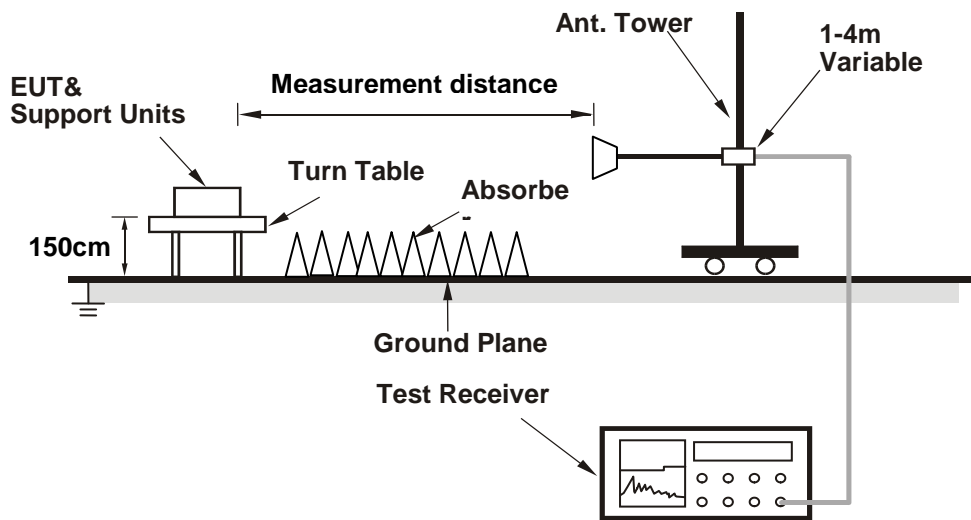

For the actual test configuration, please refer to the attached file (Test Setup Photo).

4.1.6 EUT Operating Conditions

Set the EUT under transmission condition continuously at specific channel frequency.

4.1.7 Test Results

Above 1GHz Data

CHANNEL	TX Channel 1	DETECTOR FUNCTION	Peak (PK)
FREQUENCY RANGE	1GHz ~ 18GHz		Average (AV)

ANTENNA POLARITY & TEST DISTANCE: HORIZONTAL AT 3 M

NO.	FREQ. (MHz)	EMISSION LEVEL (dBuV/m)	LIMIT (dBuV/m)	MARGIN (dB)	ANTENNA HEIGHT (m)	TABLE ANGLE (Degree)	RAW VALUE (dBuV)	CORRECTION FACTOR (dB/m)
1	6170.80	56.2 PK	74.0	-17.8	1.75 H	40	50.8	5.4
2	6170.80	38.8 AV	54.0	-15.2	1.75 H	40	33.4	5.4
3	11303.42	64.2 PK	74.0	-9.8	1.85 H	66	50.4	13.8
4	11303.42	46.5 AV	54.0	-7.5	1.85 H	66	32.7	13.8

ANTENNA POLARITY & TEST DISTANCE: VERTICAL AT 3 M

NO.	FREQ. (MHz)	EMISSION LEVEL (dBuV/m)	LIMIT (dBuV/m)	MARGIN (dB)	ANTENNA HEIGHT (m)	TABLE ANGLE (Degree)	RAW VALUE (dBuV)	CORRECTION FACTOR (dB/m)
1	6169.70	55.8 PK	74.0	-18.2	1.65 V	34	50.4	5.4
2	6169.70	38.2 AV	54.0	-15.8	1.65 V	34	32.8	5.4
3	11302.01	63.9 PK	74.0	-10.1	1.20 V	65	50.1	13.8
4	11302.01	46.3 AV	54.0	-7.7	1.20 V	65	32.5	13.8

REMARKS:

1. Emission Level(dBuV/m) = Raw Value(dBuV) + Correction Factor(dB/m)
2. Correction Factor(dB/m) = Antenna Factor(dB/m) + Cable Factor(dB) – Pre-Amplifier Factor(dB)
3. The other emission levels were very low against the limit.
4. Margin value = Emission Level – Limit value

CHANNEL	TX Channel 2	DETECTOR FUNCTION	Peak (PK)
FREQUENCY RANGE	1GHz ~ 18GHz		Average (AV)

ANTENNA POLARITY & TEST DISTANCE: HORIZONTAL AT 3 M

NO.	FREQ. (MHz)	EMISSION LEVEL (dBuV/m)	LIMIT (dBuV/m)	MARGIN (dB)	ANTENNA HEIGHT (m)	TABLE ANGLE (Degree)	RAW VALUE (dBuV)	CORRECTION FACTOR (dB/m)
1	6730.55	56.5 PK	74.0	-17.5	1.45 H	85	49.1	7.4
2	6730.55	39.8 AV	54.0	-14.2	1.45 H	85	32.4	7.4
3	11386.50	64.5 PK	74.0	-9.5	1.65 H	85	50.6	13.9
4	11386.50	47.2 AV	54.0	-6.8	1.65 H	85	33.3	13.9

ANTENNA POLARITY & TEST DISTANCE: VERTICAL AT 3 M

NO.	FREQ. (MHz)	EMISSION LEVEL (dBuV/m)	LIMIT (dBuV/m)	MARGIN (dB)	ANTENNA HEIGHT (m)	TABLE ANGLE (Degree)	RAW VALUE (dBuV)	CORRECTION FACTOR (dB/m)
1	6729.40	56.3 PK	74.0	-17.7	1.74 V	65	48.9	7.4
2	6729.40	39.4 AV	54.0	-14.6	1.74 V	65	32.0	7.4
3	11384.60	64.2 PK	74.0	-9.8	1.75 V	99	50.3	13.9
4	11384.60	46.9 AV	54.0	-7.1	1.75 V	99	33.0	13.9

REMARKS:

1. Emission Level(dBuV/m) = Raw Value(dBuV) + Correction Factor(dB/m)
2. Correction Factor(dB/m) = Antenna Factor(dB/m) + Cable Factor(dB) – Pre-Amplifier Factor(dB)
3. The other emission levels were very low against the limit.
4. Margin value = Emission Level – Limit value

CHANNEL	TX Channel 3	DETECTOR FUNCTION	Peak (PK)
FREQUENCY RANGE	1GHz ~ 18GHz		Average (AV)

ANTENNA POLARITY & TEST DISTANCE: HORIZONTAL AT 3 M

NO.	FREQ. (MHz)	EMISSION LEVEL (dBuV/m)	LIMIT (dBuV/m)	MARGIN (dB)	ANTENNA HEIGHT (m)	TABLE ANGLE (Degree)	RAW VALUE (dBuV)	CORRECTION FACTOR (dB/m)
1	6775.40	57.5 PK	74.0	-16.5	1.85 H	60	50.3	7.2
2	6775.40	40.1 AV	54.0	-13.9	1.85 H	60	32.9	7.2
3	11414.50	64.9 PK	74.0	-9.1	1.85 H	99	51.0	13.9
4	11414.50	48.1 AV	54.0	-5.9	1.85 H	99	34.2	13.9

ANTENNA POLARITY & TEST DISTANCE: VERTICAL AT 3 M

NO.	FREQ. (MHz)	EMISSION LEVEL (dBuV/m)	LIMIT (dBuV/m)	MARGIN (dB)	ANTENNA HEIGHT (m)	TABLE ANGLE (Degree)	RAW VALUE (dBuV)	CORRECTION FACTOR (dB/m)
1	6769.50	56.8 PK	74.0	-17.2	1.75 V	88	49.4	7.4
2	6769.50	39.8 AV	54.0	-14.2	1.75 V	88	32.4	7.4
3	11404.50	64.7 PK	74.0	-9.3	2.01 V	88	50.8	13.9
4	11404.50	47.6 AV	54.0	-6.4	2.01 V	88	33.7	13.9

REMARKS:

1. Emission Level(dBuV/m) = Raw Value(dBuV) + Correction Factor(dB/m)
2. Correction Factor(dB/m) = Antenna Factor(dB/m) + Cable Factor(dB) – Pre-Amplifier Factor(dB)
3. The other emission levels were very low against the limit.
4. Margin value = Emission Level – Limit value

CHANNEL	TX Channel 1	DETECTOR FUNCTION	Peak (PK)
FREQUENCY RANGE	18GHz ~ 40GHz		Average (AV)

ANTENNA POLARITY & TEST DISTANCE: HORIZONTAL AT 3 M

NO.	FREQ. (MHz)	EMISSION LEVEL (dBuV/m)	LIMIT (dBuV/m)	MARGIN (dB)	ANTENNA HEIGHT (m)	TABLE ANGLE (Degree)	RAW VALUE (dBuV)	CORRECTION FACTOR (dB/m)
1	24000.00	68.5 PK	74.0	-5.5	1.49 H	351	86.7	-18.2
2	24000.00	33.7 AV	54.0	-20.3	1.49 H	351	51.9	-18.2
3	*24065.00	87.9 PK		-40.0	1.49 H	351	106.1	-18.2
4	*24065.00	53.1 AV		-54.8	1.49 H	351	71.3	-18.2

ANTENNA POLARITY & TEST DISTANCE: VERTICAL AT 3 M

NO.	FREQ. (MHz)	EMISSION LEVEL (dBuV/m)	LIMIT (dBuV/m)	MARGIN (dB)	ANTENNA HEIGHT (m)	TABLE ANGLE (Degree)	RAW VALUE (dBuV)	CORRECTION FACTOR (dB/m)
1	24000.00	69.8 PK	74.0	-4.2	1.29 V	359	88.0	-18.2
2	24000.00	35.0 AV	54.0	-19.0	1.29 V	359	53.2	-18.2
3	24065.00	105.3 PK		-22.6	1.29 V	359	123.5	-18.2
4	24065.00	70.5 AV		-37.4	1.29 V	359	88.7	-18.2

REMARKS:

1. Emission Level(dBuV/m) = Raw Value(dBuV) + Correction Factor(dB/m)
2. Correction Factor(dB/m) = Antenna Factor(dB/m) + Cable Factor(dB) – Pre-Amplifier Factor(dB)
3. The other emission levels were very low against the limit.
4. Margin value = Emission Level – Limit value
5. " * ": Fundamental frequency.

CHANNEL	TX Channel 2	DETECTOR FUNCTION	Peak (PK)
FREQUENCY RANGE	18GHz ~ 40GHz		Average (AV)

ANTENNA POLARITY & TEST DISTANCE: HORIZONTAL AT 3 M

NO.	FREQ. (MHz)	EMISSION LEVEL (dBuV/m)	LIMIT (dBuV/m)	MARGIN (dB)	ANTENNA HEIGHT (m)	TABLE ANGLE (Degree)	RAW VALUE (dBuV)	CORRECTION FACTOR (dB/m)
1	*24145.00	87.7 PK		-40.2	1.50 H	350	105.8	-18.1
2	*24145.00	52.9 AV		-55.0	1.50 H	350	71.0	-18.1

ANTENNA POLARITY & TEST DISTANCE: VERTICAL AT 3 M

NO.	FREQ. (MHz)	EMISSION LEVEL (dBuV/m)	LIMIT (dBuV/m)	MARGIN (dB)	ANTENNA HEIGHT (m)	TABLE ANGLE (Degree)	RAW VALUE (dBuV)	CORRECTION FACTOR (dB/m)
1	*24145.00	105.1 PK		-22.8	1.28 V	356	123.2	-18.1
2	*24145.00	70.3 AV		-37.6	1.28 V	356	88.4	-18.1

REMARKS:

1. Emission Level(dBuV/m) = Raw Value(dBuV) + Correction Factor(dB/m)
2. Correction Factor(dB/m) = Antenna Factor(dB/m) + Cable Factor(dB) – Pre-Amplifier Factor(dB)
3. The other emission levels were very low against the limit.
4. Margin value = Emission Level – Limit value
5. " * ": Fundamental frequency.

CHANNEL	TX Channel 3	DETECTOR FUNCTION	Peak (PK)
FREQUENCY RANGE	18GHz ~ 40GHz		Average (AV)

ANTENNA POLARITY & TEST DISTANCE: HORIZONTAL AT 3 M

NO.	FREQ. (MHz)	EMISSION LEVEL (dBuV/m)	LIMIT (dBuV/m)	MARGIN (dB)	ANTENNA HEIGHT (m)	TABLE ANGLE (Degree)	RAW VALUE (dBuV)	CORRECTION FACTOR (dB/m)
1	*24225.00	87.5 PK		-40.4	1.51 H	346	105.6	-18.1
2	*24225.00	52.7 AV		-55.2	1.51 H	346	70.8	-18.1
3	24250.00	69.2 PK	74.0	-4.8	1.51 H	346	87.1	-17.9
4	24250.00	34.4 AV	54.0	-19.6	1.51 H	346	52.3	-17.9

ANTENNA POLARITY & TEST DISTANCE: VERTICAL AT 3 M

NO.	FREQ. (MHz)	EMISSION LEVEL (dBuV/m)	LIMIT (dBuV/m)	MARGIN (dB)	ANTENNA HEIGHT (m)	TABLE ANGLE (Degree)	RAW VALUE (dBuV)	CORRECTION FACTOR (dB/m)
1	*24225.00	104.8 PK		-23.1	1.25 V	354	122.9	-18.1
2	*24225.00	70.0 AV		-37.9	1.25 V	354	88.1	-18.1
3	24250.00	70.1 PK	74.0	-3.9	1.25 V	354	88.0	-17.9
4	24250.00	35.3 AV	54.0	-18.7	1.25 V	354	53.2	-17.9

REMARKS:

1. Emission Level(dBuV/m) = Raw Value(dBuV) + Correction Factor(dB/m)
2. Correction Factor(dB/m) = Antenna Factor(dB/m) + Cable Factor(dB) – Pre-Amplifier Factor(dB)
3. The other emission levels were very low against the limit.
4. Margin value = Emission Level – Limit value
5. " * ": Fundamental frequency.

CHANNEL	TX Channel 1	DETECTOR FUNCTION	Peak (PK)
FREQUENCY RANGE	40GHz ~ 100GHz		Average (AV)

ANTENNA POLARITY & TEST DISTANCE: HORIZONTAL AT 3 M

NO.	FREQ. (GHz)	EMISSION LEVEL (dBuV/m)	LIMIT (dBuV/m)	MARGIN (dB)	EIRP Level (dBm)	Measured Power (dBm)	Receiver Antenna Gain (dBi)
1	48.13	76.9 PK	87.9	-11.0	-18.4	-60.2	24.3
2	48.13	62.6 AV	67.9	-5.3	-32.7	-74.5	24.3
3	72.195	78.7 PK	87.9	-9.2	-16.6	-62.1	24.1
4	72.195	64.7 AV	67.9	-3.2	-30.6	-76.1	24.1

ANTENNA POLARITY & TEST DISTANCE: VERTICAL AT 3 M

NO.	FREQ. (GHz)	EMISSION LEVEL (dBuV/m)	LIMIT (dBuV/m)	MARGIN (dB)	EIRP Level (dBm)	Measured Power (dBm)	Receiver Antenna Gain (dBi)
1	48.13	77.9 PK	87.9	-10.0	-17.4	-59.2	24.3
2	48.13	64 AV	67.9	-3.9	-31.3	-73.1	24.3
3	72.195	78.9 PK	87.9	-9.0	-16.4	-61.9	24.1
4	72.195	64.6 AV	67.9	-3.3	-30.7	-76.2	24.1

REMARKS:

1. The measured power level is converted to EIRP using the Friis equation:

$$EIRP = P_T * G_T = (P_R / G_R) * (4 * \pi * D / \lambda)^2$$

where:

PR is the power of the receive measurement

GR is the gain of the receive measurement antenna

D is the measurement distance

λ is the wavelength

2. Field strength is then converted to EIRP as follows:

$$EIRP = ((E * D)^2) / 30$$

Working in dB units, the above equation is equivalent to:

$$EIRP[dBm] = E[dBuV/m] + 20 \log(D[meters]) - 104.8$$

$$E = EIRP - 20 * \log(D) + 104.8$$

3. " - ": The emission levels were too low to be detected.

4. Shorter measurement distances may be used to improve the measurement system's noise floor. As ANSI C63.10 description is based on the measurement in distance of 3 meters, the data obtained at 1 meter distance was extrapolate results to the 3-m distance:

Test value at 3-meter distance (dBuV)

$$= \text{Test value at 1 meter distance (dBuV)} - 20 \log(3/1)(dB)$$

$$= \text{Test value at 1 meter distance (dBuV)} - 9.5(dB).$$

*Measurements made at 1 meter distance. Test value converted to account for 3-meter measurement distance.

CHANNEL	TX Channel 2	DETECTOR FUNCTION	Peak (PK)
FREQUENCY RANGE	40GHz ~ 100GHz		Average (AV)

ANTENNA POLARITY & TEST DISTANCE: HORIZONTAL AT 3 M

NO.	FREQ. (GHz)	EMISSION LEVEL (dBuV/m)	LIMIT (dBuV/m)	MARGIN (dB)	EIRP Level (dBm)	Measured Power (dBm)	Receiver Antenna Gain (dBi)
1	48.29	76.6 PK	87.9	-11.3	-18.7	-60.5	24.3
2	48.29	62.3 AV	67.9	-5.6	-33.0	-74.8	24.3
3	72.435	78.3 PK	87.9	-9.6	-17.0	-62.5	24.1
4	72.435	64.2 AV	67.9	-3.7	-31.1	-76.6	24.1

ANTENNA POLARITY & TEST DISTANCE: VERTICAL AT 3 M

NO.	FREQ. (GHz)	EMISSION LEVEL (dBuV/m)	LIMIT (dBuV/m)	MARGIN (dB)	EIRP Level (dBm)	Measured Power (dBm)	Receiver Antenna Gain (dBi)
1	48.29	77.6 PK	87.9	-10.3	-17.7	-59.5	24.3
2	48.29	63.7 AV	67.9	-4.2	-31.6	-73.4	24.3
3	72.435	78.6 PK	87.9	-9.3	-16.7	-62.2	24.1
4	72.435	64.5 AV	67.9	-3.4	-30.8	-76.3	24.1

REMARKS:

1. The measured power level is converted to EIRP using the Friis equation:

$$EIRP = P_T * G_T = (P_R / G_R) * (4 * \pi * D / \lambda)^2$$

where:

PR is the power of the receive measurement

GR is the gain of the receive measurement antenna

D is the measurement distance

λ is the wavelength

2. Field strength is then converted to EIRP as follows:

$$EIRP = ((E * D)^2) / 30$$

Working in dB units, the above equation is equivalent to:

$$EIRP[dBm] = E[dBuV/m] + 20 \log(D[meters]) - 104.8$$

$$E = EIRP - 20 * \log(D) + 104.8$$

3. " - ": The emission levels were too low to be detected.

4. Shorter measurement distances may be used to improve the measurement system's noise floor. As ANSI C63.10 description is based on the measurement in distance of 3 meters, the data obtained at 1 meter distance was extrapolate results to the 3-m distance:

Test value at 3-meter distance (dBuV)

$$= \text{Test value at 1 meter distance (dBuV)} - 20 \log(3/1)(dB)$$

$$= \text{Test value at 1 meter distance (dBuV)} - 9.5(dB).$$

*Measurements made at 1 meter distance. Test value converted to account for 3-meter measurement distance.

CHANNEL	TX Channel 3	DETECTOR FUNCTION	Peak (PK)
FREQUENCY RANGE	40GHz ~ 100GHz		Average (AV)

ANTENNA POLARITY & TEST DISTANCE: HORIZONTAL AT 3 M

NO.	FREQ. (GHz)	EMISSION LEVEL (dBuV/m)	LIMIT (dBuV/m)	MARGIN (dB)	EIRP Level (dBm)	Measured Power (dBm)	Receiver Antenna Gain (dBi)
1	48.45	76.2 PK	87.9	-11.7	-19.1	-60.9	24.3
2	48.45	61.9 AV	67.9	-6.0	-33.4	-75.2	24.3
3	72.675	77.9 PK	87.9	-10.0	-17.4	-62.9	24.2
4	72.675	63.9 AV	67.9	-4.0	-31.4	-76.9	24.2

ANTENNA POLARITY & TEST DISTANCE: VERTICAL AT 3 M

NO.	FREQ. (GHz)	EMISSION LEVEL (dBuV/m)	LIMIT (dBuV/m)	MARGIN (dB)	EIRP Level (dBm)	Measured Power (dBm)	Receiver Antenna Gain (dBi)
1	48.45	77.4 PK	87.9	-10.5	-17.9	-59.7	24.3
2	48.45	63.6 AV	67.9	-4.3	-31.7	-73.5	24.3
3	72.675	78.3 PK	87.9	-9.6	-17.0	-62.5	24.2
4	72.675	64.2 AV	67.9	-3.7	-31.1	-76.6	24.2

REMARKS:

1. The measured power level is converted to EIRP using the Friis equation:

$$EIRP = P_T * G_T = (P_R / G_R) * (4 * \pi * D / \lambda)^2$$

where:

PR is the power of the receive measurement

GR is the gain of the receive measurement antenna

D is the measurement distance

λ is the wavelength

2. Field strength is then converted to EIRP as follows:

$$EIRP = ((E * D)^2) / 30$$

Working in dB units, the above equation is equivalent to:

$$EIRP[dBm] = E[dBuV/m] + 20 \log(D[meters]) - 104.8$$

$$E = EIRP - 20 * \log(D) + 104.8$$

3. " - ": The emission levels were too low to be detected.

4. Shorter measurement distances may be used to improve the measurement system's noise floor. As ANSI C63.10 description is based on the measurement in distance of 3 meters, the data obtained at 1 meter distance was extrapolate results to the 3-m distance:

Test value at 3-meter distance (dBuV)

$$= \text{Test value at 1 meter distance (dBuV)} - 20 \log(3/1)(dB)$$

$$= \text{Test value at 1 meter distance (dBuV)} - 9.5(dB).$$

*Measurements made at 1 meter distance. Test value converted to account for 3-meter measurement distance.

Below 1GHz Data

CHANNEL	TX Channel 1	DETECTOR FUNCTION	Quasi-Peak (QP)
FREQUENCY RANGE	9kHz ~ 1GHz		

ANTENNA POLARITY & TEST DISTANCE: HORIZONTAL AT 3 M								
NO.	FREQ. (MHz)	EMISSION LEVEL (dBuV/m)	LIMIT (dBuV/m)	MARGIN (dB)	ANTENNA HEIGHT (m)	TABLE ANGLE (Degree)	RAW VALUE (dBuV)	CORRECTION FACTOR (dB/m)
1	160.13	25.1 QP	43.5	-18.4	2.00 H	290	33.2	-8.1
2	313.92	27.4 QP	46.0	-18.6	1.00 H	310	34.2	-6.8
3	412.86	27.8 QP	46.0	-18.2	2.00 H	318	32.5	-4.7
4	528.70	31.2 QP	46.0	-14.8	1.50 H	27	33.4	-2.2
5	691.03	30.5 QP	46.0	-15.5	1.00 H	90	29.8	0.7
6	819.00	32.4 QP	46.0	-13.6	2.00 H	303	29.8	2.6

ANTENNA POLARITY & TEST DISTANCE: VERTICAL AT 3 M								
NO.	FREQ. (MHz)	EMISSION LEVEL (dBuV/m)	LIMIT (dBuV/m)	MARGIN (dB)	ANTENNA HEIGHT (m)	TABLE ANGLE (Degree)	RAW VALUE (dBuV)	CORRECTION FACTOR (dB/m)
1	50.18	28.0 QP	40.0	-12.0	1.50 V	357	35.9	-7.9
2	151.93	24.6 QP	43.5	-18.9	2.00 V	32	32.5	-7.9
3	324.37	27.8 QP	46.0	-18.2	1.00 V	21	34.1	-6.3
4	524.80	30.2 QP	46.0	-15.8	1.00 V	71	32.4	-2.2
5	644.37	31.1 QP	46.0	-14.9	2.00 V	3	30.9	0.2
6	840.53	32.4 QP	46.0	-13.6	1.00 V	209	29.6	2.8

REMARKS:

1. Emission Level(dBuV/m) = Raw Value(dBuV) + Correction Factor(dB/m)
2. Correction Factor(dB/m) = Antenna Factor(dB/m) + Cable Factor(dB) – Pre-Amplifier Factor(dB)
3. The other emission levels were very low against the limit.
4. Margin value = Emission Level – Limit value

CHANNEL	TX Channel 2	DETECTOR FUNCTION	Quasi-Peak (QP)
FREQUENCY RANGE	9kHz ~ 1GHz		

ANTENNA POLARITY & TEST DISTANCE: HORIZONTAL AT 3 M

NO.	FREQ. (MHz)	EMISSION LEVEL (dBuV/m)	LIMIT (dBuV/m)	MARGIN (dB)	ANTENNA HEIGHT (m)	TABLE ANGLE (Degree)	RAW VALUE (dBuV)	CORRECTION FACTOR (dB/m)
1	48.48	27.7 QP	40.0	-12.3	1.00 H	247	35.7	-8.0
2	311.64	27.4 QP	46.0	-18.6	1.00 H	306	34.3	-6.9
3	381.16	27.9 QP	46.0	-18.1	1.00 H	313	33.3	-5.4
4	528.85	31.2 QP	46.0	-14.8	2.00 H	360	33.4	-2.2
5	774.33	31.6 QP	46.0	-14.4	1.00 H	360	29.2	2.4
6	919.27	33.5 QP	46.0	-12.5	1.00 H	138	29.6	3.9

ANTENNA POLARITY & TEST DISTANCE: VERTICAL AT 3 M

NO.	FREQ. (MHz)	EMISSION LEVEL (dBuV/m)	LIMIT (dBuV/m)	MARGIN (dB)	ANTENNA HEIGHT (m)	TABLE ANGLE (Degree)	RAW VALUE (dBuV)	CORRECTION FACTOR (dB/m)
1	49.18	28.1 QP	40.0	-11.9	1.00 V	0	36.1	-8.0
2	318.07	27.6 QP	46.0	-18.4	1.00 V	0	34.1	-6.5
3	522.28	29.3 QP	46.0	-16.7	1.00 V	156	31.5	-2.2
4	644.37	30.8 QP	46.0	-15.2	1.00 V	0	30.6	0.2
5	805.56	32.5 QP	46.0	-13.5	1.00 V	352	30.1	2.4
6	940.20	33.6 QP	46.0	-12.4	1.50 V	29	29.5	4.1

REMARKS:

1. Emission Level(dBuV/m) = Raw Value(dBuV) + Correction Factor(dB/m)
2. Correction Factor(dB/m) = Antenna Factor(dB/m) + Cable Factor(dB) – Pre-Amplifier Factor(dB)
3. The other emission levels were very low against the limit.
4. Margin value = Emission Level – Limit value

CHANNEL	TX Channel 3	DETECTOR FUNCTION	Quasi-Peak (QP)
FREQUENCY RANGE	9kHz ~ 1GHz		

ANTENNA POLARITY & TEST DISTANCE: HORIZONTAL AT 3 M

NO.	FREQ. (MHz)	EMISSION LEVEL (dBuV/m)	LIMIT (dBuV/m)	MARGIN (dB)	ANTENNA HEIGHT (m)	TABLE ANGLE (Degree)	RAW VALUE (dBuV)	CORRECTION FACTOR (dB/m)
1	139.83	24.4 QP	43.5	-19.1	1.00 H	26	32.8	-8.4
2	313.87	27.3 QP	46.0	-18.7	1.00 H	311	34.1	-6.8
3	362.35	26.9 QP	46.0	-19.1	1.00 H	293	32.8	-5.9
4	524.48	31.2 QP	46.0	-14.8	1.50 H	32	33.4	-2.2
5	657.20	30.5 QP	46.0	-15.5	1.50 H	164	30.3	0.2
6	837.26	32.7 QP	46.0	-13.3	1.50 H	55	29.9	2.8

ANTENNA POLARITY & TEST DISTANCE: VERTICAL AT 3 M

NO.	FREQ. (MHz)	EMISSION LEVEL (dBuV/m)	LIMIT (dBuV/m)	MARGIN (dB)	ANTENNA HEIGHT (m)	TABLE ANGLE (Degree)	RAW VALUE (dBuV)	CORRECTION FACTOR (dB/m)
1	40.52	27.0 QP	40.0	-13.0	1.00 V	201	35.2	-8.2
2	148.92	24.7 QP	43.5	-18.8	2.00 V	360	32.6	-7.9
3	368.80	27.0 QP	46.0	-19.0	1.00 V	335	32.8	-5.8
4	444.51	27.5 QP	46.0	-18.5	1.50 V	200	31.0	-3.5
5	518.15	30.1 QP	46.0	-15.9	1.00 V	60	32.4	-2.3
6	644.30	31.0 QP	46.0	-15.0	2.00 V	334	30.8	0.2

REMARKS:

1. Emission Level(dBuV/m) = Raw Value(dBuV) + Correction Factor(dB/m)
2. Correction Factor(dB/m) = Antenna Factor(dB/m) + Cable Factor(dB) – Pre-Amplifier Factor(dB)
3. The other emission levels were very low against the limit.
4. Margin value = Emission Level – Limit value

4.2 Conducted Emission Measurement

4.2.1 Limits of Conducted Emission Measurement

Frequency (MHz)	Conducted Limit (dBuV)	
	Quasi-peak	Average
0.15 - 0.5	66 - 56	56 - 46
0.50 - 5.0	56	46
5.0 - 30.0	60	50

Note: 1. The lower limit shall apply at the transition frequencies.

2. The limit decreases in line with the logarithm of the frequency in the range of 0.15 to 0.50MHz.

4.2.2 Test Instruments

DESCRIPTION & MANUFACTURER	MODEL NO.	SERIAL NO.	CALIBRATED DATE	CALIBRATED UNTIL
Test Receiver R&S	ESCS 30	847124/029	Nov. 01, 2017	Oct. 31, 2018
Line-Impedance Stabilization Network (for EUT) R&S	ESH3-Z5	848773/004	Nov. 15, 2017	Nov. 14, 2018
Line-Impedance Stabilization Network (for Peripheral) R&S	ENV216	100072	June 03, 2017	June 02, 2018
50 ohms Terminator	N/A	EMC-02	Sep. 22, 2017	Sep. 21, 2018
RF Cable	5D-FB	COCCAB-001	Sep. 29, 2017	Sep. 28, 2018
10 dB PAD Mini-Circuits	HAT-10+	CONATT-004	June 18, 2017	June 17, 2018
Software BVADT	BVADT_Cond_ V7.3.7.4	NA	NA	NA

Note:

1. The calibration interval of the above test instruments are 12 months and the calibrations are traceable to NML/ROC and NIST/USA.
2. The test was performed in Shielded Room No. 1.
3. Tested Date: Feb. 09, 2018

4.2.3 Test Procedures

- The EUT was placed 0.4 meters from the conducting wall of the shielded room with EUT being connected to the power mains through a line impedance stabilization network (LISN). Other support units were connected to the power mains through another LISN. The two LISNs provide 50 ohm/ 50uH of coupling impedance for the measuring instrument.
- Both lines of the power mains connected to the EUT were checked for maximum conducted interference.
- The frequency range from 150kHz to 30MHz was searched. Emission levels under (Limit - 20dB) was not recorded.

NOTE: The resolution bandwidth and video bandwidth of test receiver is 9kHz for quasi-peak detection (QP) and average detection (AV) at frequency 0.15MHz-30MHz.

4.2.4 Deviation from Test Standard

No deviation.

4.2.5 Test Setup

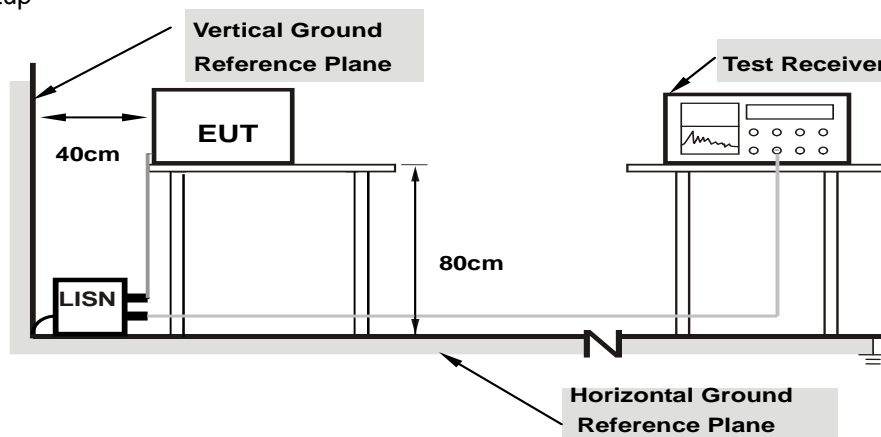

Note: 1.Support units were connected to second LISN.

For the actual test configuration, please refer to the attached file (Test Setup Photo).

4.2.6 EUT Operating Conditions

Same as 4.1.6.

4.2.7 Test Results

Phase	Line (L)	Detector Function	Quasi-Peak (QP) / Average (AV)
-------	----------	-------------------	--------------------------------

Phase Of Power : Line (L)										
No	Frequency (MHz)	Correction Factor (dB)	Reading Value (dBuV)		Emission Level (dBuV)		Limit (dBuV)		Margin (dB)	
			Q.P.	AV.	Q.P.	AV.	Q.P.	AV.	Q.P.	AV.
1	0.15000	10.13	14.06	-3.52	24.19	6.61	66.00	56.00	-41.81	-49.39
2	0.22422	10.15	2.15	-11.36	12.30	-1.21	62.66	52.66	-50.36	-53.87
3	0.98203	10.23	-2.76	-11.25	7.47	-1.02	56.00	46.00	-48.53	-47.02
4	5.54688	10.44	-9.78	-13.61	0.66	-3.17	60.00	50.00	-59.34	-53.17
5	12.64844	10.80	8.93	2.60	19.73	13.40	60.00	50.00	-40.27	-36.60
6	24.18359	11.26	-7.18	-11.51	4.08	-0.25	60.00	50.00	-55.92	-50.25

Remarks:

1. Q.P. and AV. are abbreviations of quasi-peak and average individually.
2. The emission levels of other frequencies were very low against the limit.
3. Margin value = Emission level – Limit value
4. Correction factor = Insertion loss + Cable loss
5. Emission Level = Correction Factor + Reading Value

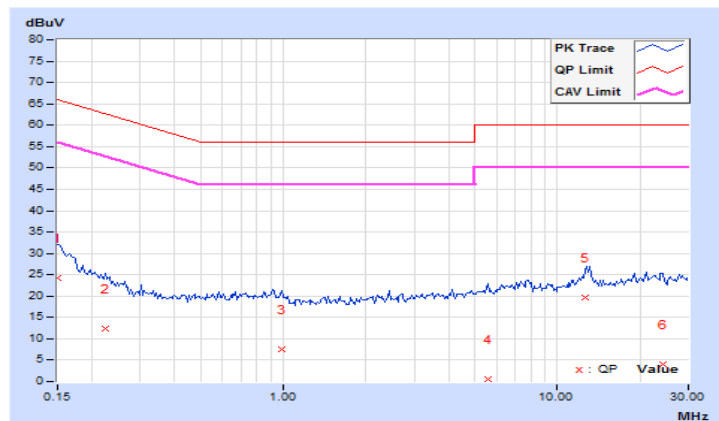

Phase	Neutral (N)	Detector Function	Quasi-Peak (QP) / Average (AV)
-------	-------------	-------------------	--------------------------------

Phase Of Power : Neutral (N)										
No	Frequency (MHz)	Correction Factor (dB)	Reading Value (dBuV)		Emission Level (dBuV)		Limit (dBuV)		Margin (dB)	
			Q.P.	AV.	Q.P.	AV.	Q.P.	AV.	Q.P.	AV.
1	0.15000	10.04	13.55	-3.99	23.59	6.05	66.00	56.00	-42.41	-49.95
2	0.22422	10.04	1.76	-11.44	11.80	-1.40	62.66	52.66	-50.86	-54.06
3	1.38281	10.13	-10.87	-14.33	-0.74	-4.20	56.00	46.00	-56.74	-50.20
4	7.98828	10.41	-7.40	-11.71	3.01	-1.30	60.00	50.00	-56.99	-51.30
5	12.13281	10.61	3.19	-3.04	13.80	7.57	60.00	50.00	-46.20	-42.43
6	20.80859	11.02	7.15	1.58	18.17	12.60	60.00	50.00	-41.83	-37.40

Remarks:

1. Q.P. and AV. are abbreviations of quasi-peak and average individually.
2. The emission levels of other frequencies were very low against the limit.
3. Margin value = Emission level – Limit value
4. Correction factor = Insertion loss + Cable loss
5. Emission Level = Correction Factor + Reading Value

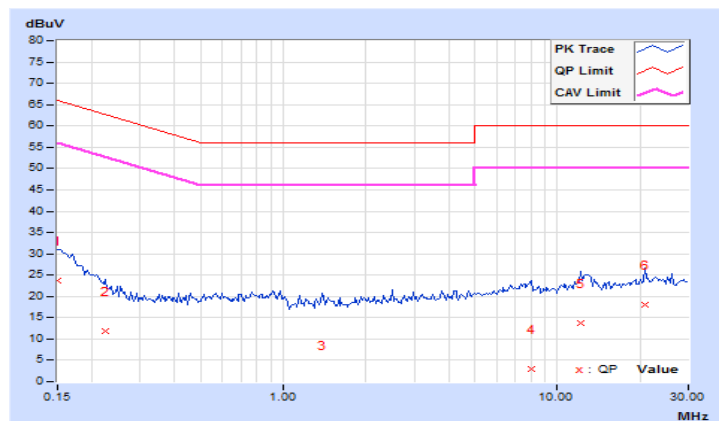

4.3 20dB bandwidth

4.3.1 Limits of 20dB bandwidth Measurement

The 20dB bandwidth shall be specified in operating frequency band.

4.3.2 Test Setup

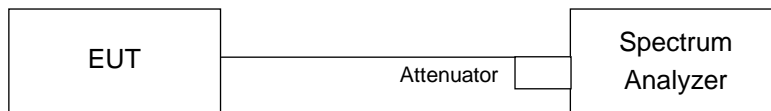

4.3.3 Test Instruments

DESCRIPTION & MANUFACTURER	MODEL NO.	SERIAL NO.	CALIBRATED DATE	CALIBRATED UNTIL
Spectrum Analyzer R&S	FSV40	100964	July 1, 2017	June 30, 2018

- NOTE:**
1. The test was performed in Oven room 2.
 2. The calibration interval of the above test instruments is 12 months and the calibrations are traceable to NML/ROC and NIST/USA.
 3. Tested Date: Feb. 12, 2018

4.3.4 Test Procedures

The bandwidth of the fundamental frequency was measured by spectrum analyzer with 3MHz RBW and 10MHz VBW. The 20dB bandwidth is defined as the total spectrum the power of which is higher than peak power minus 20dB.

4.3.5 Deviation from Test Standard

No deviation.

4.3.6 EUT Operating Conditions

Same as Item 4.1.6.

4.3.7 Test Results

Channel	Frequency (MHz)	20dB Bandwidth (MHz)
1	24145	172.44

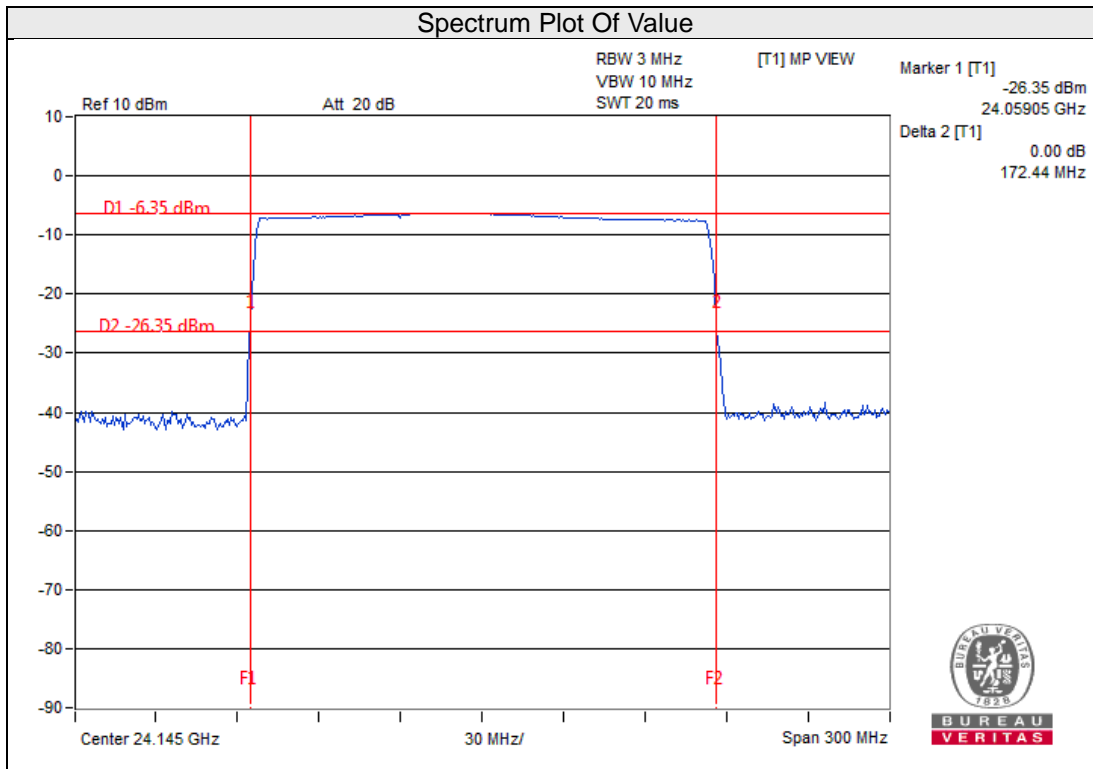

5 Pictures of Test Arrangements

Please refer to the attached file (Test Setup Photo).

Appendix – Information on the Testing Laboratories

We, Bureau Veritas Consumer Products Services (H.K.) Ltd., Taoyuan Branch, were founded in 1988 to provide our best service in EMC, Radio, Telecom and Safety consultation. Our laboratories are accredited and approved according to ISO/IEC 17025.

If you have any comments, please feel free to contact us at the following:

Linko EMC/RF Lab

Tel: 886-2-26052180

Fax: 886-2-26051924

Hsin Chu EMC/RF/Telecom Lab

Tel: 886-3-6668565

Fax: 886-3-6668323

Hwa Ya EMC/RF/Safety Lab

Tel: 886-3-3183232

Fax: 886-3-3270892

Email: service.adt@tw.bureauveritas.com

Web Site: www.bureauveritas-adt.com

The address and road map of all our labs can be found in our web site also.

--- END ---