

FCC RF Test Report

APPLICANT : Wistron NeWeb Corporation
EQUIPMENT : Mini board wi-fi edition
BRAND NAME : WNC
MODEL NAME : PW8Q7
FCC ID : NKR-PW8Q7A
STANDARD : FCC Part 15 Subpart C §15.247
CLASSIFICATION : (DTS) Digital Transmission System

The product was received on Dec. 09, 2013 and testing was completed on Dec. 19, 2013. We, SPORTON INTERNATIONAL (KUNSHAN) INC., would like to declare that the tested sample has been evaluated in accordance with the procedures and shown to be compliant with the applicable technical standards.

The test results in this report apply exclusively to the tested model / sample. Without written approval of SPORTON INTERNATIONAL (KUNSHAN) INC., the test report shall not be reproduced except in full.



Reviewed by: Joseph Lin / Supervisor



Approved by: Jones Tsai / Manager



SPORTON INTERNATIONAL (KUNSHAN) INC.
No. 3-2, PingXiang Road, Kunshan, Jiangsu Province, P.R.C.



TABLE OF CONTENTS

REVISION HISTORY..... 3

SUMMARY OF TEST RESULT 4

1 GENERAL DESCRIPTION..... 5

 1.1 Applicant 5

 1.2 Manufacturer..... 5

 1.3 Feature of Equipment Under Test 5

 1.4 Product Specification of Equipment Under Test..... 5

 1.5 Modification of EUT 6

 1.6 Testing Site..... 6

 1.7 Applied Standards 6

2 TEST CONFIGURATION OF EQUIPMENT UNDER TEST..... 7

 2.1 Descriptions of Test Mode 7

 2.2 Test Mode..... 7

 2.3 Connection Diagram of Test System..... 8

 2.4 Support Unit used in test configuration and system 8

 2.5 EUT Operation Test Setup 8

 2.6 Measurement Results Explanation Example..... 9

3 TEST RESULT 10

 3.1 6dB Bandwidth Measurement 10

 3.2 Peak Output Power Measurement 13

 3.3 Power Spectral Density Measurement 15

 3.4 Conducted Band Edges and Spurious Emission Measurement 21

 3.5 Radiated Band Edges and Spurious Emission Measurement 29

 3.6 Antenna Requirements..... 38

4 LIST OF MEASURING EQUIPMENT..... 39

5 UNCERTAINTY OF EVALUATION..... 40

APPENDIX A. SETUP PHOTOGRAPHS



SUMMARY OF TEST RESULT

Report Section	FCC Rule	Description	Limit	Result	Remark
3.1	15.247(a)(2)	6dB Bandwidth	$\geq 0.5\text{MHz}$	Pass	-
3.2	15.247(b)(1)	Peak Output Power	$\leq 30\text{dBm}$	Pass	-
3.3	15.247(e)	Power Spectral Density	$\leq 8\text{dBm}$	Pass	-
3.4	15.247(d)	Conducted Band Edges and Spurious Emission	$\leq 20\text{dBc}$	Pass	-
3.5	15.247(d)	Radiated Band Edges and Spurious Emission	15.209(a) & 15.247(d)	Pass	Under limit 4.97 dB at 201.690 MHz
3.6	15.203 & 15.247(b)	Antenna Requirement	N/A	Pass	-

1 General Description

1.1 Applicant

Wistron NeWeb Corporation

20 Park Avenue II, Hsinchu Science Park, Hsinchu 308, Taiwan, R.O.C

1.2 Manufacturer

Wistron NeWeb Corporation

20 Park Avenue II, Hsinchu Science Park, Hsinchu 308, Taiwan, R.O.C

1.3 Feature of Equipment Under Test

Product Feature	
Equipment	Mini board wi-fi edition
Brand Name	WNC
Model Name	PW8Q7
FCC ID	NKR-PW8Q7A
EUT supports Radios application	WLAN 2.4GHz 802.11b/g/n (HT20), WLAN 5GHz 802.11a/n (HT20/HT40), Bluetooth v3.0 + EDR/Bluetooth v4.0
HW Version	B1
SW Version	msm8960-eng 4.3 test-keys Px8Q7_v10.00.140040_2310025.20140102.034452
EUT Stage	Production Unit

Remark: The above EUT's information was declared by manufacturer. Please refer to the specifications or user's manual for more detailed description.

1.4 Product Specification of Equipment Under Test

Product Specification subjective to this standard	
Tx/Rx Frequency Range	2402 MHz ~ 2480 MHz
Number of Channels	40
Carrier Frequency of Each Channel	40 Channel(37 hopping + 3 advertising channel)
Maximum Output Power to Antenna	2.34 dBm (0.0017 W)
Antenna Type	Monopole Antenna with gain 0 dBi
Type of Modulation	Bluetooth 4.0 - LE : GFSK



1.5 Modification of EUT

No modifications are made to the EUT during all test items.

1.6 Testing Site

Test Site	SPORTON INTERNATIONAL (KUNSHAN) INC.		
Test Site Location	No. 3-2, PingXiang Road, Kunshan, Jiangsu Province, P.R.C. TEL: +86-0512-5790-0158 FAX: +86-0512-5790-0958		
Test Site No.	Sporton Site No.		FCC Registration No.
	TH01-KS	03CH01-KS	149928

Note: The test site complies with ANSI C63.4 2003 requirement.

1.7 Applied Standards

According to the specifications of the manufacturer, the EUT must comply with the requirements of the following standards:

- ♦ FCC Part 15 Subpart C §15.247
- ♦ FCC KDB Publication No. 558074 D01 DTS Meas. Guidance v03r01
- ♦ ANSI C63.4-2003

Remark:

1. All test items were verified and recorded according to the standards and without any deviation during the test.
2. This EUT has also been tested and complied with the requirements of FCC Part 15, Subpart B, recorded in a separate test report.

2 Test Configuration of Equipment Under Test

2.1 Descriptions of Test Mode

The RF output power was recorded in the following table:

Channel	Frequency	Bluetooth 4.0 – LE RF Output Power	
		Data Rate / Modulation	
		GFSK	
		1Mbps	
Ch00	2402MHz	2.34 dBm	
Ch19	2440MHz	1.77 dBm	
Ch39	2480MHz	1.91 dBm	

- a. The EUT has been associated with peripherals and configuration operated in a manner tended to maximize its emission characteristics in a typical application. Frequency range investigated: radiation (9 kHz to the 10th harmonic of the highest fundamental frequency or to 40 GHz, whichever is lower).

2.2 Test Mode

The following summary table is showing all test modes to demonstrate in compliance with the standard.

Summary table of Test Cases	
Test Item	Data Rate / Modulation
	Bluetooth 4.0 – LE / GFSK
Conducted TCs	Mode 1: Bluetooth Tx CH00_2402 MHz_1Mbps
	Mode 2: Bluetooth Tx CH19_2440 MHz_1Mbps
	Mode 3: Bluetooth Tx CH39_2480 MHz_1Mbps
Radiated TCs	Mode 1: Bluetooth Tx CH00_2402 MHz_1Mbps
	Mode 2: Bluetooth Tx CH19_2440 MHz_1Mbps
	Mode 3: Bluetooth Tx CH39_2480 MHz_1Mbps

2.3 Connection Diagram of Test System

<Bluetooth 4.0 – LE Tx Mode>

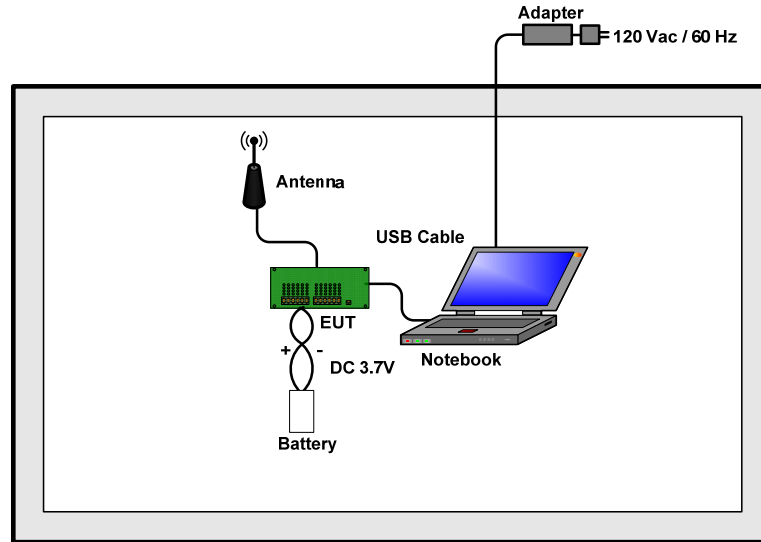

2.4 Support Unit used in test configuration and system

Item	Equipment	Trade Name	Model Name	FCC ID	Data Cable	Power Cord
1.	DC Power Supply	GWINSTEK	GPS-3030D	N/A	N/A	Unshielded, 1.8 m
2.	Test Jig	N/A	N/A	N/A	N/A	N/A
3.	Notebook	Lenovo	G480	N/A	N/A	AC I/P: Unshielded, 1.2 m DC O/P: Shielded, 1.8 m

2.5 EUT Operation Test Setup

For Bluetooth 4.0 – LE function, the engineering test program was provided and enabled to make EUT continuous transmit/receive.

2.6 Measurement Results Explanation Example

For all conducted test items:

The offset level is set in the spectrum analyzer to compensate the RF cable loss and attenuator factor between EUT conducted output port and spectrum analyzer. With the offset compensation, the spectrum analyzer reading level is exactly the EUT RF output level.

Example:

The spectrum analyzer offset is derived from RF cable loss and attenuator factor.

Offset = RF cable loss + attenuator factor.

Following shows an offset computation example with cable loss 5.6 dB and 10dB attenuator.

$$\begin{aligned} \text{Offset (dB)} &= \text{RF cable loss(dB)} + \text{attenuator factor(dB)}. \\ &= 5.6 + 10 = 15.6 \text{ (dB)} \end{aligned}$$

3 Test Result

3.1 6dB Bandwidth Measurement

3.1.1 Limit of 6dB Bandwidth

The minimum 6 dB bandwidth shall be at least 500 kHz.

3.1.2 Measuring Instruments

The section 4.0 of List of Measuring Equipment of this test report is used for test.

3.1.3 Test Procedures

1. The testing follows FCC KDB Publication No. 558074 D01 DTS Meas. Guidance v03r01.
2. The RF output of EUT was connected to the spectrum analyzer by RF cable and attenuator. The path loss was compensated to the results for each measurement.
3. Set to the maximum power setting and enable the EUT transmit continuously.
4. Make the measurement with the spectrum analyzer's resolution bandwidth (RBW) = 100 kHz. Set the Video bandwidth (VBW) = 300 kHz. In order to make an accurate measurement. The 6 dB bandwidth must be greater than 500 kHz.
5. Measure and record the results in the test report.

3.1.4 Test Setup

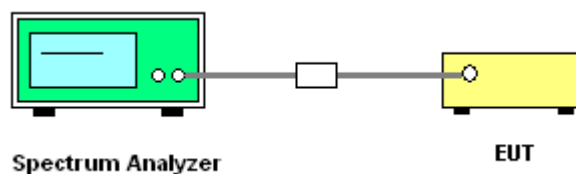

3.1.5 Test Result of 6dB Bandwidth

Test Mode :	Bluetooth 4.0 - LE	Temperature :	23~24°C
Test Engineer :	Adonis Li	Relative Humidity :	47~48%

Channel	Frequency (MHz)	6dB Bandwidth (MHz)	6dB Bandwidth Min. Limit (MHz)	Pass/Fail
00	2402	0.664	0.5	Pass
19	2440	0.672	0.5	Pass
39	2480	0.668	0.5	Pass

6 dB Bandwidth Plot on Channel 00

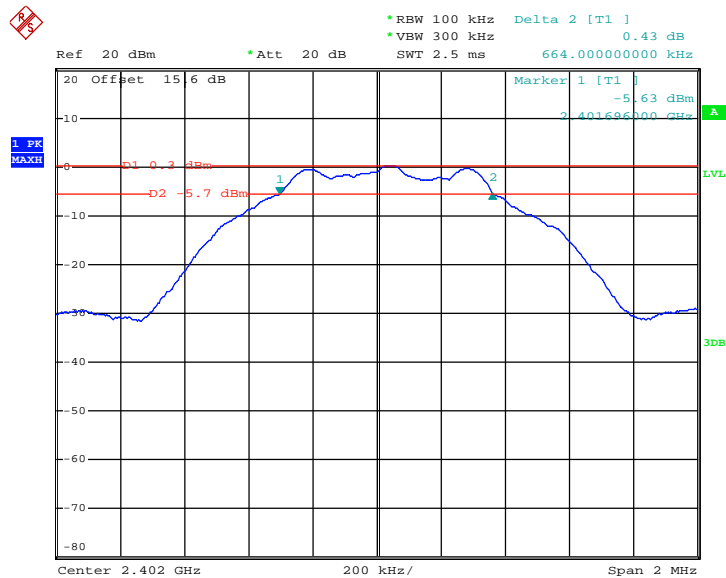

Date: 16.DEC.2013 21:05:51



6 dB Bandwidth Plot on Channel 19

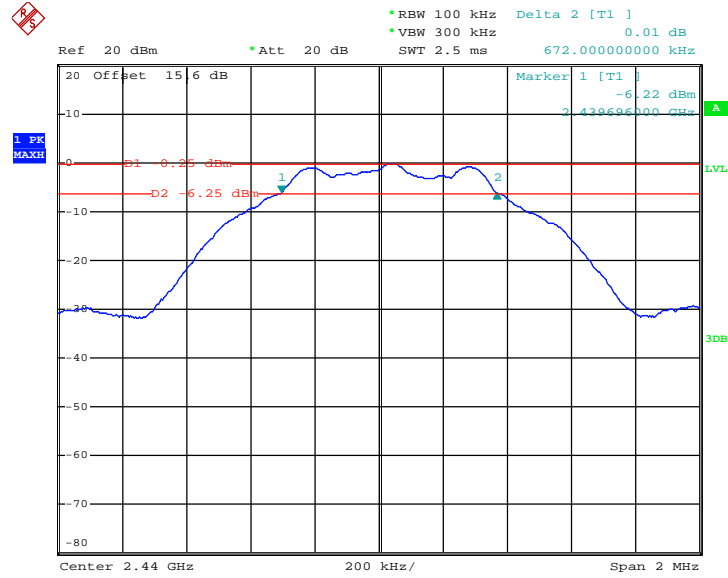

Date: 16.DEC.2013 21:06:53

6 dB Bandwidth Plot on Channel 39

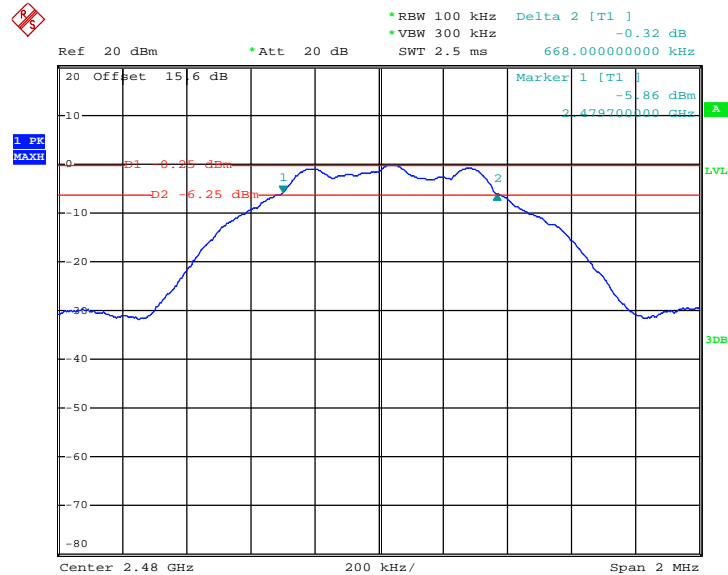

Date: 16.DEC.2013 21:07:42

3.2 Peak Output Power Measurement

3.2.1 Limit of Peak Output Power

For systems using digital modulation in the 2400-2483.5MHz, the limit for peak output power is 30dBm. If transmitting antenna of directional gain greater than 6dBi is used, the peak output power from the intentional radiator shall be reduced below the above stated value by the amount in dB that the directional gain of the antenna exceeds 6 dBi. In case of point-to-point operation, the limit has to be reduced by 1dB for every 3dB that the directional gain of the antenna exceeds 6dBi.

3.2.2 Measuring Instruments

The section 4.0 of List of Measuring Equipment of this test report is used for test.

3.2.3 Test Procedures

1. The testing follows the Measurement Procedure of FCC KDB No. 558074 DTS D01 Meas. Guidance v03r01.
2. The RF output of EUT was connected to the power meter by RF cable and attenuator. The path loss was compensated to the results for each measurement.
3. Set to the maximum power setting and enable the EUT transmit continuously.
4. Measure the conducted output power and record the results in the test report.

3.2.4 Test Setup

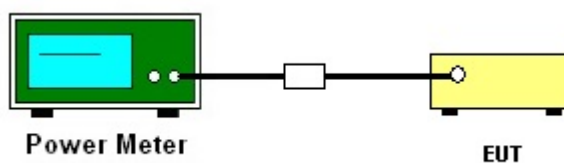



3.2.5 Test Result of Peak Output Power

Test Mode :	Bluetooth 4.0 - LE	Temperature :	23~24°C
Test Engineer :	Adonis Li	Relative Humidity :	47~48%

Channel	Frequency (MHz)	RF Power (dBm)		
		GFSK	Max. Limits (dBm)	Pass/Fail
		1 Mbps		
00	2402	2.34	30.00	Pass
19	2440	1.77	30.00	Pass
39	2480	1.91	30.00	Pass

3.3 Power Spectral Density Measurement

3.3.1 Limit of Power Spectral Density

The peak power spectral density shall not be greater than 8dBm in any 3kHz band at any time interval of continuous transmission.

3.3.2 Measuring Instruments

The section 4.0 of List of Measuring Equipment of this test report is used for test.

3.3.3 Test Procedures

1. The testing follows Measurement Procedure 10.2 Method PKPSD of FCC KDB Publication No. 558074 D01 DTS Meas. Guidance v03r01
2. The RF output of EUT was connected to the spectrum analyzer by RF cable and attenuator. The path loss was compensated to the results for each measurement.
3. Set to the maximum power setting and enable the EUT transmit continuously.
4. Make the measurement with the spectrum analyzer's resolution bandwidth (RBW) = 3 kHz. Video bandwidth VBW = 10 kHz In order to make an accurate measurement, set the span to 1.5 times DTS Channel Bandwidth. (6dB BW)
5. Detector = peak, Sweep time = auto couple, Trace mode = max hold, Allow trace to fully stabilize. Use the peak marker function to determine the maximum power level.
6. Measure and record the results in the test report.
7. The Measured power density (dBm)/ 100kHz is a reference level and used as 20dBc down limit line for Conducted Band Edges and Conducted Spurious Emission.

3.3.4 Test Setup

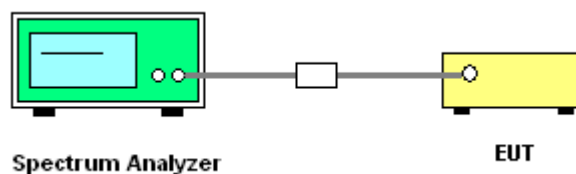

3.3.5 Test Result of Power Spectral Density

Test Mode :	Bluetooth 4.0 - LE	Temperature :	23~24°C
Test Engineer :	Adonis Li	Relative Humidity :	47~48%

Channel	Frequency (MHz)	Power Density		Max. Limits (dBm/3kHz)	Pass/Fail
		PSD/100kHz (dBm)	PSD/3kHz (dBm)		
00	2402	0.44	-14.61	8	Pass
19	2440	-0.35	-15.21	8	Pass
39	2480	-0.41	-15.44	8	Pass

Note:

1. Measured power density (dBm) has offset with cable loss.
2. The Measured power density (dBm)/ 100kHz is reference level and used as 20dBc down for Conducted Band Edges and Conducted Spurious Emission limit line.



3.3.6 Test Result of Power Spectral Density Plots (100kHz)

PSD 100kHz Plot on Channel 00

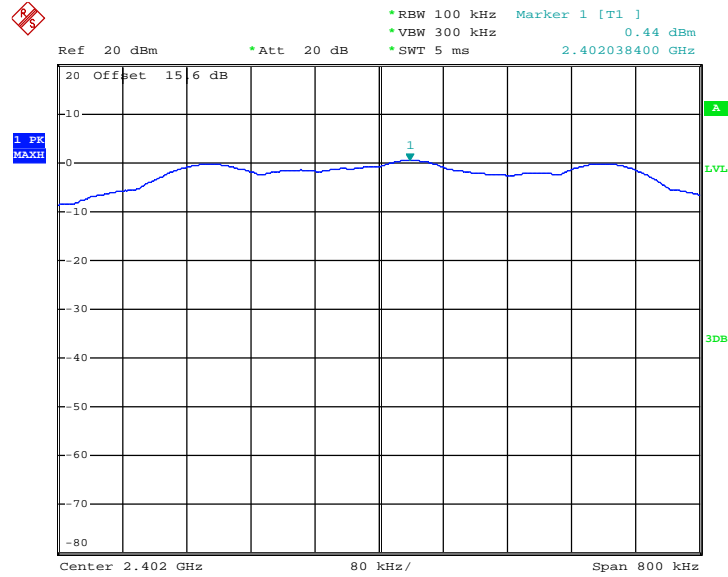

Date: 16.DEC.2013 21:18:02



PSD 100kHz Plot on Channel 19

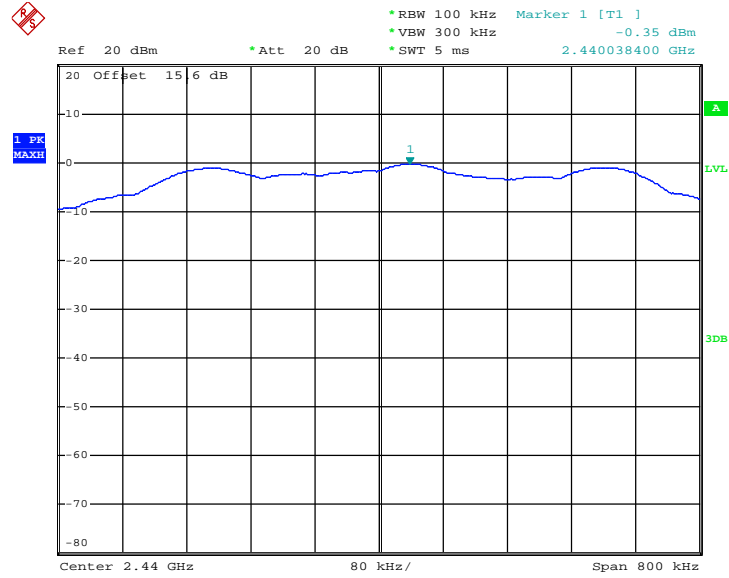

Date: 16.DEC.2013 21:18:38

PSD 100kHz Plot on Channel 39

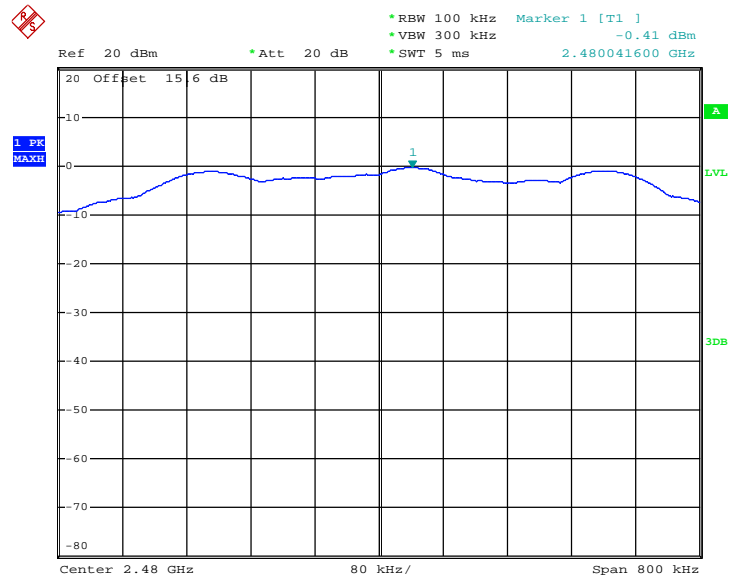

Date: 16.DEC.2013 21:19:09



3.3.7 Test Result of Power Spectral Density Plots (3kHz)

PSD 3kHz Plot on Channel 00

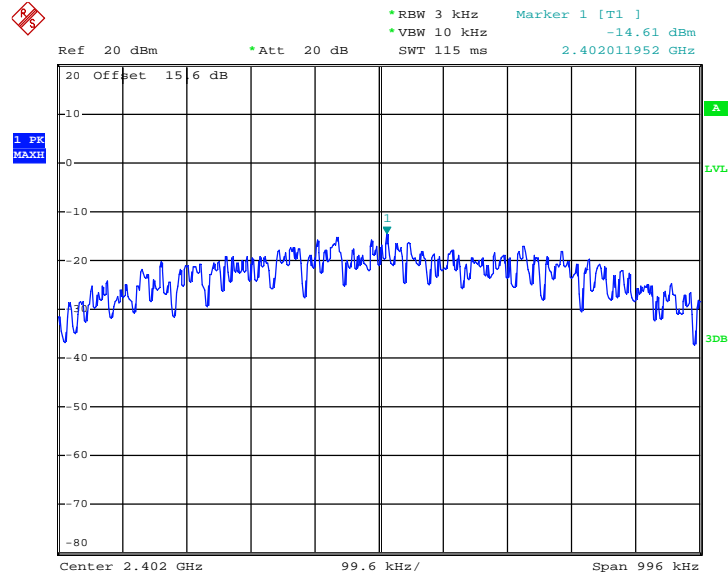

Date: 16.DEC.2013 21:16:49



PSD 3kHz Plot on Channel 19

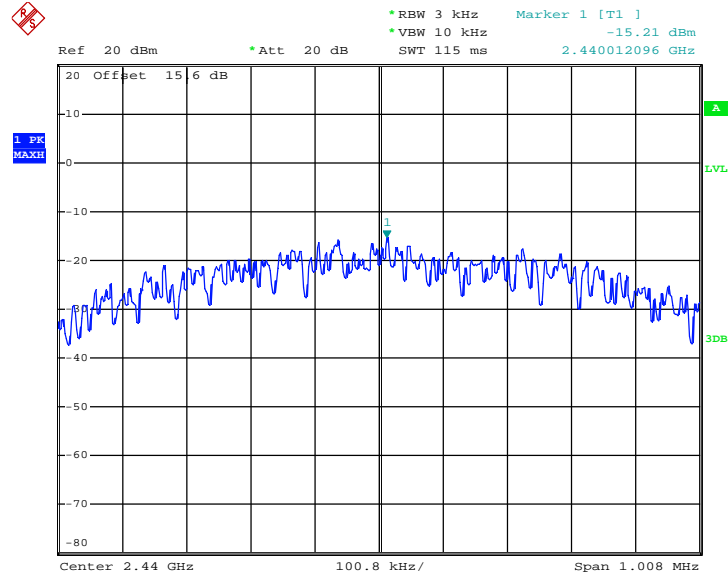

Date: 16.DEC.2013 21:16:14

PSD 3kHz Plot on Channel 39

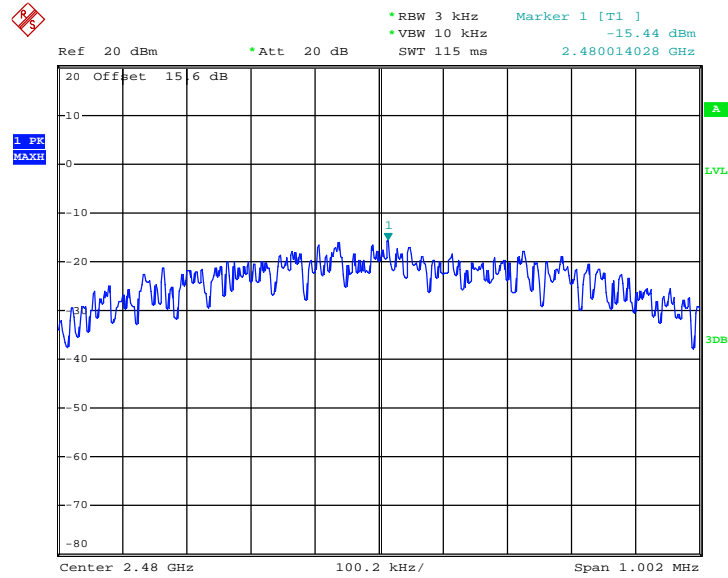

Date: 16.DEC.2013 21:15:28

3.4 Conducted Band Edges and Spurious Emission Measurement

3.4.1 Limit of Conducted Band Edges and Spurious Emission

All harmonics/spurious must be at least 20 dB down from the highest emission level within the authorized band.

3.4.2 Measuring Instruments

The section 4.0 of List of Measuring Equipment of this test report is used for test.

3.4.3 Test Procedure

1. The testing follows FCC KDB Publication No. 558074 D01 DTS Meas. Guidance v03r01.
2. The RF output of EUT was connected to the spectrum analyzer by RF cable and attenuator. The path loss was compensated to the results for each measurement.
3. Set to the maximum power setting and enable the EUT transmit continuously.
4. Set RBW = 100 kHz, VBW=300 kHz, Peak Detector. Unwanted Emissions measured in any 100 kHz bandwidth outside of the authorized frequency band shall be attenuated by at least 20 dB relative to the maximum in-band peak PSD level in 100 kHz when maximum peak conducted output power procedure is used. If the transmitter complies with the conducted power limits based on the use of RMS averaging over a time interval, the attenuation required under this paragraph shall be 30 dB instead of 20 dB per 15.247(d).
5. Measure and record the results in the test report.
6. The RF fundamental frequency should be excluded against the limit line in the operating frequency band.

3.4.4 Test Setup

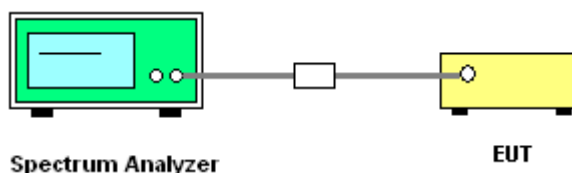

3.4.5 Test Result of Conducted Band Edges

Test Mode :	Bluetooth 4.0 - LE	Temperature :	23~24°C
Test Channel :	00 and 39	Relative Humidity :	47~48%
		Test Engineer :	Adonis Li

Low Band Edge Plot on Channel 00

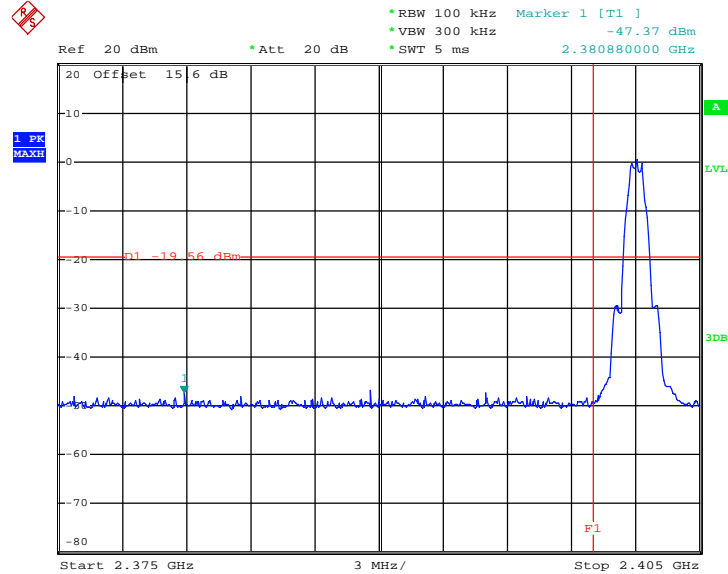

Date: 16.DEC.2013 21:25:00

High Band Edge Plot on Channel 39

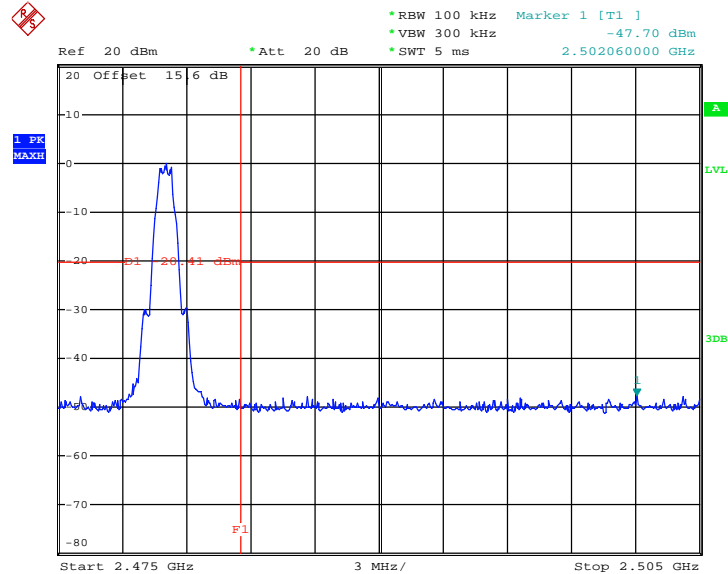

Date: 16.DEC.2013 21:26:01



3.4.6 Test Result of Conducted Spurious Emission

Test Mode :	Bluetooth 4.0 - LE	Temperature :	23~24°C
Test Channel :	00	Relative Humidity :	47~48%
		Test Engineer :	Adonis Li

Conducted Spurious Emission Plot on Bluetooth LE 1Mbps GFSK Channel 00

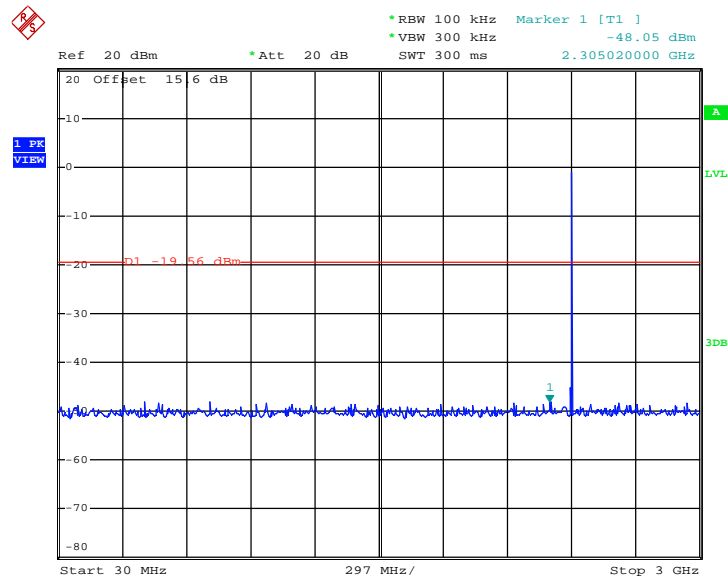

Date: 16.DEC.2013 21:31:39



Conducted Spurious Emission Plot on Bluetooth LE 1Mbps GFSK Channel 00

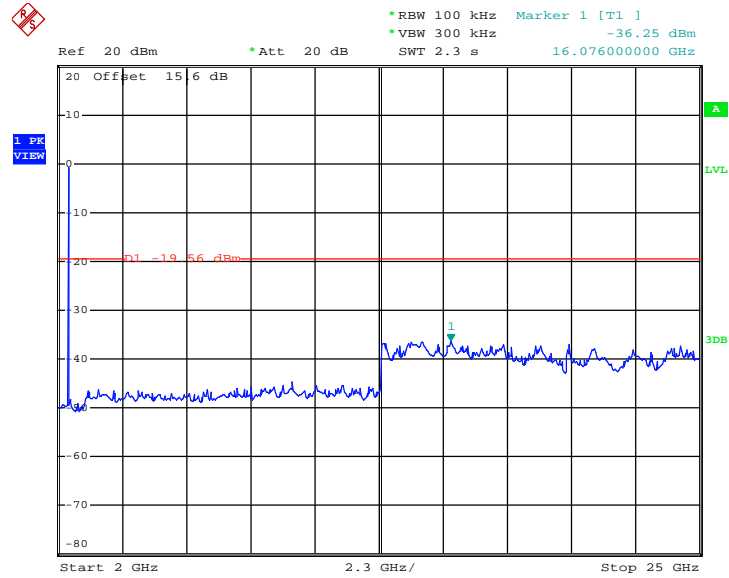

Date: 16.DEC.2013 21:32:17



Test Mode :	Bluetooth 4.0 - LE	Temperature :	23~24°C
Test Channel :	19	Relative Humidity :	47~48%
		Test Engineer :	Adonis Li

Conducted Spurious Emission Plot on Bluetooth LE 1Mbps
GFSK Channel 19

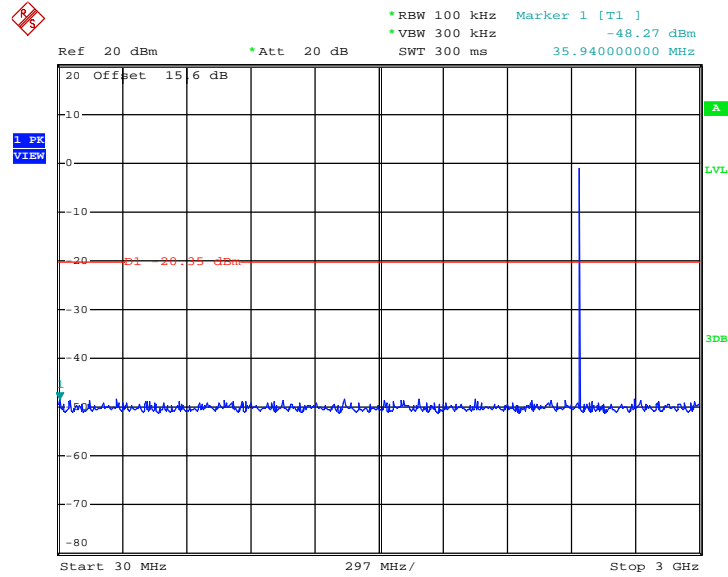

Date: 16.DEC.2013 21:29:55



Conducted Spurious Emission Plot on Bluetooth LE 1Mbps
GFSK Channel 19

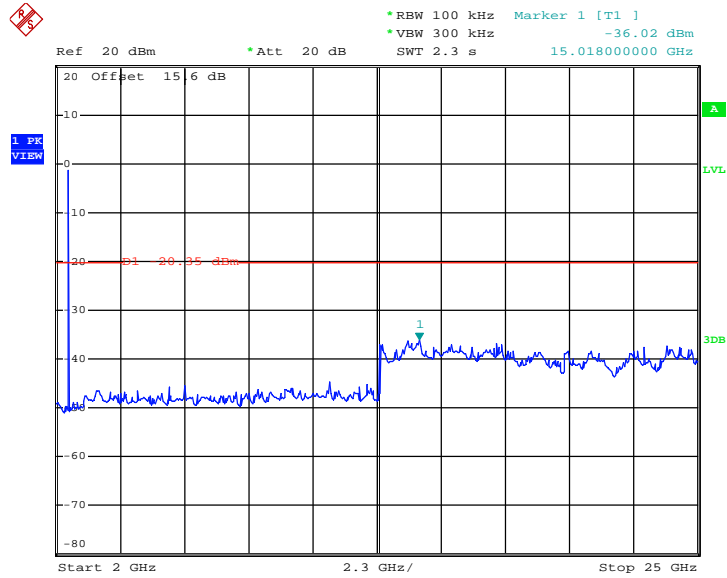

Date: 16.DEC.2013 21:30:35



Test Mode :	Bluetooth 4.0 - LE	Temperature :	23~24°C
Test Channel :	39	Relative Humidity :	47~48%
		Test Engineer :	Adonis Li

Conducted Spurious Emission Plot on Bluetooth LE 1Mbps
GFSK Channel 39

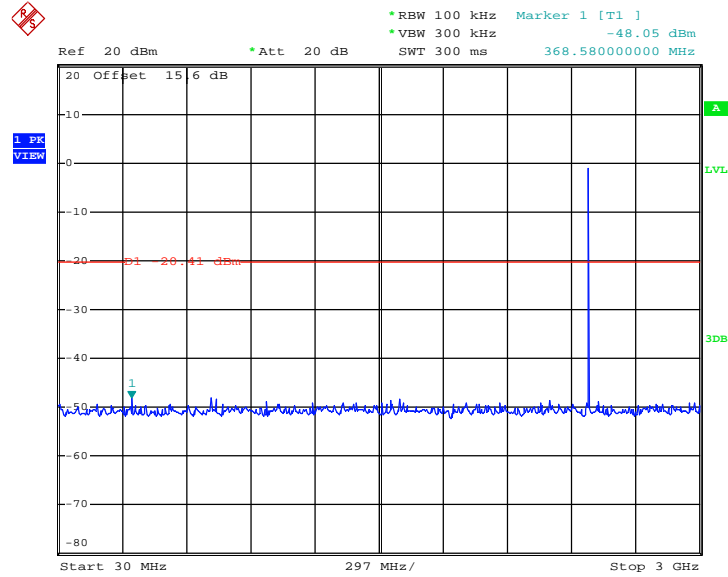

Date: 16.DEC.2013 21:28:23



Conducted Spurious Emission Plot on Bluetooth LE 1Mbps GFSK Channel 39

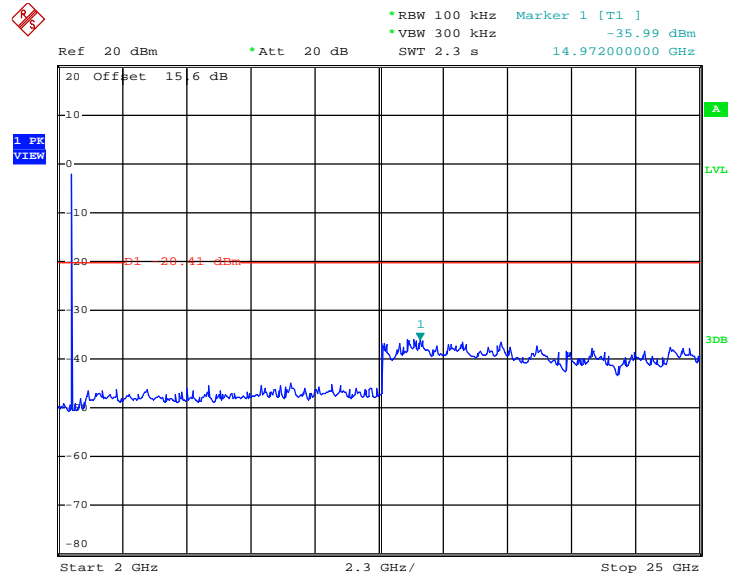

Date: 16.DEC.2013 21:29:04

3.5 Radiated Band Edges and Spurious Emission Measurement

3.5.1 Limit of Radiated Band Edges and Spurious Emission

In any 100 kHz bandwidth outside the intentional radiator frequency band, all harmonics/spurious must be at least 20 dB below the highest emission level within the authorized band. If the output power of this device was measured by spectrum analyzer, the attenuation under this paragraph shall be 30 dB instead of 20 dB. In addition, radiated emissions which fall in the restricted bands must also comply with the FCC section 15.209 limits as below.

Frequency (MHz)	Field Strength (microvolts/meter)	Measurement Distance (meters)
0.009 – 0.490	2400/F(kHz)	300
0.490 – 1.705	24000/F(kHz)	30
1.705 – 30.0	30	30
30 – 88	100	3
88 – 216	150	3
216 - 960	200	3
Above 960	500	3

3.5.2 Measuring Instruments

The section 4.0 of List of Measuring Equipment of this test report is used for test.



3.5.3 Test Procedures

1. The testing follows FCC KDB Publication No. 558074 D01 DTS Meas. Guidance v03r01.
2. The EUT was arranged to its worst case and then tune the antenna tower (from 1 m to 4 m) and turntable (from 0 degree to 360 degrees) to find the maximum reading. A pre-amp and a high pass filter are used for the test in order to get better signal level.
3. The EUT was placed on a turntable with 0.8 meter above ground.
4. The EUT was set 3 meters from the interference receiving antenna, which was mounted on the top of a variable height antenna tower.
5. Corrected Reading: Antenna Factor + Cable Loss + Read Level - Preamp Factor = Level
6. For measurement below 1GHz, If the emission level of the EUT measured by the peak detector is 3 dB lower than the applicable limit, the peak emission level will be reported. Otherwise, the emission measurement will be repeated using the quasi-peak detector and reported.
7. Use the following spectrum analyzer settings:
 - (1) Span shall wide enough to fully capture the emission being measured;
 - (2) Set RBW=100 kHz for $f < 1$ GHz; $VBW \geq RBW$; Sweep = auto; Detector function = peak; Trace = max hold;
 - (3) Set RBW = 1 MHz, VBW= 3MHz for $f \geq 1$ GHz for peak measurement.
For average measurement:
 - $VBW = 10$ Hz, when duty cycle is no less than 98 percent.
 - $VBW \geq 1/T$, when duty cycle is less than 98 percent where T is the minimum transmission duration over which the transmitter is on and is transmitting at its maximum power control level for the tested mode of operation.

Band	Duty Cycle(%)	T(ms)	1/T(kHz)	VBW Setting
Bluetooth 4.0 - LE	62.42	0.39	2.56	3kHz

3.5.4 Test Setup

For radiated emissions below 30MHz

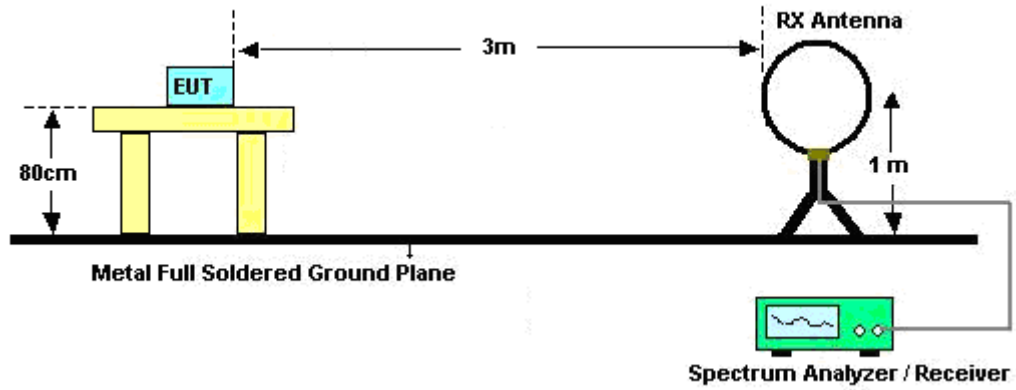

For radiated emissions from 30MHz to 1GHz

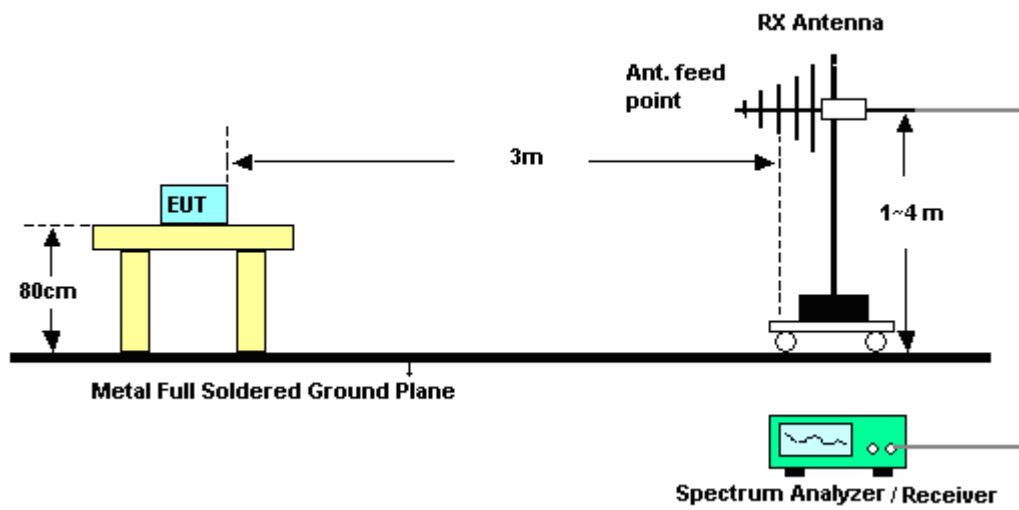

For radiated emissions above 1GHz

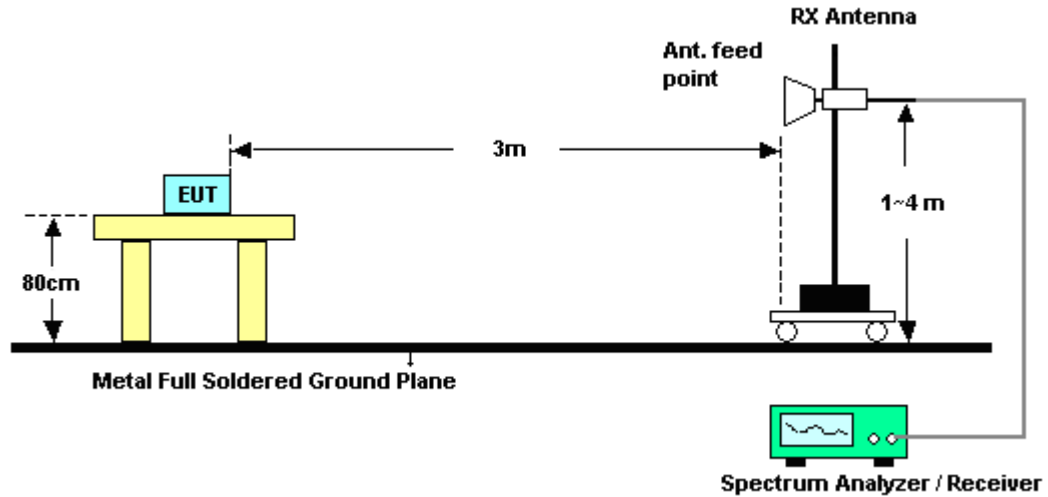

3.5.5 Test Results of Radiated Spurious Emissions (9 kHz ~ 30 MHz)

The low frequency, which started from 9 kHz to 30MHz, was pre-scanned and the result which was 20dB lower than the limit line per 15.31(o) was not reported.



3.5.6 Test Result of Radiated Spurious at Band Edges

Test Mode :	Mode 1	Temperature :	24~25°C
Test Channel :	00	Relative Humidity :	43~44%
		Test Engineer :	Stone Gu

ANTENNA POLARITY : HORIZONTAL										
Frequency (MHz)	Level (dBμV /m)	Over Limit (dB)	Limit Line (dBμV /m)	Read Level (dBμV)	Antenna Factor (dB)	Cable Loss (dB)	Preamp Factor (dB)	Ant Pos (cm)	Table Pos (deg)	Remark
2374.26	46.26	-27.74	74	43.11	32.83	3.58	33.26	100	263	Peak
2387.94	34.62	-19.38	54	31.43	32.86	3.59	33.26	100	263	Average

ANTENNA POLARITY : VERTICAL										
Frequency (MHz)	Level (dBμV /m)	Over Limit (dB)	Limit Line (dBμV /m)	Read Level (dBμV)	Antenna Factor (dB)	Cable Loss (dB)	Preamp Factor (dB)	Ant Pos (cm)	Table Pos (deg)	Remark
2387.76	46.94	-27.06	74	43.75	32.86	3.59	33.26	164	245	Peak
2389.65	35.27	-18.73	54	32.08	32.86	3.59	33.26	164	245	Average

Test Mode :	Mode 3	Temperature :	24~25°C
Test Channel :	39	Relative Humidity :	43~44%
		Test Engineer :	Stone Gu

ANTENNA POLARITY : HORIZONTAL										
Frequency (MHz)	Level (dBμV /m)	Over Limit (dB)	Limit Line (dBμV /m)	Read Level (dBμV)	Antenna Factor (dB)	Cable Loss (dB)	Preamp Factor (dB)	Ant Pos (cm)	Table Pos (deg)	Remark
2483.5	54.57	-19.43	74	51.2	33.01	3.65	33.29	106	283	Peak
2483.5	35.76	-18.24	54	32.39	33.01	3.65	33.29	106	283	Average

ANTENNA POLARITY : VERTICAL										
Frequency (MHz)	Level (dBμV /m)	Over Limit (dB)	Limit Line (dBμV /m)	Read Level (dBμV)	Antenna Factor (dB)	Cable Loss (dB)	Preamp Factor (dB)	Ant Pos (cm)	Table Pos (deg)	Remark
2483.5	65.86	-8.14	74	62.49	33.01	3.65	33.29	161	233	Peak
2483.5	46.43	-7.57	54	43.06	33.01	3.65	33.29	161	233	Average

3.5.7 Test Result of Radiated Spurious Emission (30MHz ~ 10th Harmonic)

Note: Pre-scanned all test modes and only choose the worst case mode recorded in the test report for radiated spurious emission below 1GHz.

Test Mode :	Mode 1	Temperature :	24~25°C
Test Channel :	00	Relative Humidity :	43~44%
Test Engineer :	Stone Gu	Polarization :	Horizontal
Remark :	1. 2402 MHz is fundamental signal which can be ignored. 2. Average measurement was not performed if peak level went lower than the average limit.		

Frequency (MHz)	Level (dBμV/m)	Over Limit (dB)	Limit Line (dBμV/m)	Read Level (dBμV)	Antenna Factor (dB)	Cable Loss (dB)	Preamp Factor (dB)	Ant Pos (cm)	Table Pos (deg)	Remark
2402	95.84	-	-	92.65	32.86	3.59	33.26	100	269	Peak
2402	93.47	-	-	90.28	32.86	3.59	33.26	100	269	Average
4804	46.93	-27.07	74	40.32	35.17	5.24	33.8	100	151	Peak

Note: Other harmonics are lower than background noise.

Test Mode :	Mode 1	Temperature :	24~25°C
Test Channel :	00	Relative Humidity :	43~44%
Test Engineer :	Stone Gu	Polarization :	Vertical
Remark :	1. 2402 MHz is fundamental signal which can be ignored. 2. Average measurement was not performed if peak level went lower than the average limit.		

Frequency (MHz)	Level (dBμV/m)	Over Limit (dB)	Limit Line (dBμV/m)	Read Level (dBμV)	Antenna Factor (dB)	Cable Loss (dB)	Preamp Factor (dB)	Ant Pos (cm)	Table Pos (deg)	Remark
2402	103.95	-	-	100.76	32.86	3.59	33.26	164	245	Peak
2402	103.14	-	-	99.95	32.86	3.59	33.26	164	245	Average
4804	46.43	-27.57	74	39.82	35.17	5.24	33.8	100	151	Peak

Note: Other harmonics are lower than background noise.



Test Mode :	Mode 2	Temperature :	24~25°C
Test Channel :	19	Relative Humidity :	43~44%
Test Engineer :	Stone Gu	Polarization :	Horizontal
Remark :	1. 2440 MHz is fundamental signal which can be ignored. 2. Average measurement was not performed if peak level went lower than the average limit.		

Frequency (MHz)	Level (dBμV/m)	Over Limit (dB)	Limit Line (dBμV/m)	Read Level (dBμV)	Antenna Factor (dB)	Cable Loss (dB)	Preamp Factor (dB)	Ant Pos (cm)	Table Pos (deg)	Remark
2440	94.12	-	-	90.82	32.95	3.63	33.28	100	272	Peak
2440	93.25	-	-	89.95	32.95	3.63	33.28	100	272	Average
4880	47.41	-26.59	74	40.75	35.18	5.28	33.8	100	214	Peak
7320	49.21	-24.79	74	40.5	36.21	6.63	34.13	200	100	Peak

Note: Other harmonics are lower than background noise.

Test Mode :	Mode 2	Temperature :	24~25°C
Test Channel :	19	Relative Humidity :	43~44%
Test Engineer :	Stone Gu	Polarization :	Vertical
Remark :	1. 2440 MHz is fundamental signal which can be ignored. 2. Average measurement was not performed if peak level went lower than the average limit.		

Frequency (MHz)	Level (dBμV/m)	Over Limit (dB)	Limit Line (dBμV/m)	Read Level (dBμV)	Antenna Factor (dB)	Cable Loss (dB)	Preamp Factor (dB)	Ant Pos (cm)	Table Pos (deg)	Remark
2440	104.77	-	-	101.47	32.95	3.63	33.28	139	231	Peak
2440	103.93	-	-	100.63	32.95	3.63	33.28	139	231	Average
4880	46.66	-27.34	74	40	35.18	5.28	33.8	100	151	Peak
7320	48.8	-25.2	74	40.09	36.21	6.63	34.13	115	360	Peak

Note: Other harmonics are lower than background noise.



Test Mode :	Mode 3	Temperature :	24~25°C
Test Channel :	39	Relative Humidity :	43~44%
Test Engineer :	Stone Gu	Polarization :	Horizontal
Remark :	1. 2480 MHz is fundamental signal which can be ignored. 2. Average measurement was not performed if peak level went lower than the average limit.		

Frequency (MHz)	Level (dBμV/m)	Over Limit (dB)	Limit Line (dBμV/m)	Read Level (dBμV)	Antenna Factor (dB)	Cable Loss (dB)	Preamp Factor (dB)	Ant Pos (cm)	Table Pos (deg)	Remark
156.1	26.9	-16.6	43.5	49.58	9.76	1.14	33.58	-	-	Peak
199.75	26.62	-16.88	43.5	49.88	9	1.3	33.56	-	-	Peak
298.69	28.75	-17.25	46	47.54	12.99	1.6	33.38	-	-	Peak
480.08	32.24	-13.76	46	46.53	16.87	2	33.16	120	87	Peak
720.64	31.65	-14.35	46	42.53	19.53	2.43	32.84	-	-	Peak
800.18	29.9	-16.1	46	40.11	19.85	2.56	32.62	-	-	Peak
2480	92.37	-	-	89	33.01	3.65	33.29	106	283	Peak
2480	91.25	-	-	87.88	33.01	3.65	33.29	106	283	Average
4960	46.28	-27.72	74	39.55	35.2	5.33	33.8	122	151	Peak
7440	49.65	-24.35	74	40.81	36.27	6.75	34.18	145	200	Peak

Note: Other harmonics are lower than background noise.



Test Mode :	Mode 3	Temperature :	24~25°C
Test Channel :	39	Relative Humidity :	43~44%
Test Engineer :	Stone Gu	Polarization :	Vertical
Remark :	1. 2480 MHz is fundamental signal which can be ignored. 2. Average measurement was not performed if peak level went lower than the average limit.		

Frequency (MHz)	Level (dBμV/m)	Over Limit (dB)	Limit Line (dBμV/m)	Read Level (dBμV)	Antenna Factor (dB)	Cable Loss (dB)	Preamp Factor (dB)	Ant Pos (cm)	Table Pos (deg)	Remark
46.49	33.46	-6.54	40	57.55	8.88	0.64	33.61	-	-	Peak
201.69	38.53	-4.97	43.5	61.7	9.08	1.31	33.56	115	236	Peak
299.66	28.5	-17.5	46	47.28	13	1.6	33.38	-	-	Peak
482.02	27.26	-18.74	46	41.5	16.91	2	33.15	-	-	Peak
722.58	32.66	-13.34	46	43.51	19.56	2.43	32.84	-	-	Peak
810.85	30.5	-15.5	46	40.58	19.96	2.6	32.64	-	-	Peak
2480	104.05	-	-	100.68	33.01	3.65	33.29	161	233	Peak
2480	103.24	-	-	99.87	33.01	3.65	33.29	161	233	Average
4960	45.96	-28.04	74	39.23	35.2	5.33	33.8	142	200	Peak
7440	49.62	-24.38	74	40.78	36.27	6.75	34.18	100	189	Peak

Note: Other harmonics are lower than background noise.

3.6 Antenna Requirements

3.6.1 Standard Applicable

If directional gain of transmitting antennas is greater than 6dBi, the power shall be reduced by the same level in dB comparing to gain minus 6dBi. The use of a permanently attached antenna or of an antenna that uses a unique coupling to the intentional radiator shall be considered sufficient to comply with the FCC rule.

3.6.2 Antenna Anti-Replacement Construction

An embedded-in antenna design is used.

3.6.3 Antenna Gain

The antenna peak gain of EUT is less than 6 dBi. Therefore, it is not necessary to reduce maximum peak output power limit.

4 List of Measuring Equipment

Instrument	Manufacturer	Model No.	Serial No.	Characteristics	Calibration Date	Test Date	Due Date	Remark
Spectrum Analyzer	R&S	FSP40	100319	9kHz~40GHz	Dec. 29, 2012	Dec. 16, 2013	Dec. 28, 2013	Conducted (TH01-KS)
Pulse Power Sensor	Anritsu	MA2411B	0917070	N/A	Feb. 28, 2013	Dec. 16, 2013	Feb. 27, 2014	Conducted (TH01-KS)
Power Meter	Anritsu	ML2495A	1005002	N/A	Feb. 28, 2013	Dec. 16, 2013	Feb. 27, 2014	Conducted (TH01-KS)
EMI Test Receiver	R&S	ESCI	100534	9kHz~3GHz / Max-input30dBm	Nov. 05, 2013	Dec. 19, 2013	Nov. 04, 2014	Radiation (03CH01-KS)
Spectrum Analyzer	R&S	FSP30	101399	9kHz~30GHz;Max-intput 30dBm	May 23, 2013	Dec. 19, 2013	May 22, 2014	Radiation (03CH01-KS)
Loop Antenna	R&S	HFH2-Z2	100321	9kHz~30MHz	Oct. 09, 2013	Dec. 19, 2013	Oct. 08, 2014	Radiation (03CH01-KS)
Bilog Antenna	SCHAFFNER	CBL6112D	23182	25MHz~2GHz	Dec. 06, 2013	Dec. 19, 2013	Dec. 05, 2014	Radiation (03CH01-KS)
Double Ridge Horn Antenna	EMCO	3117	00075959	1GHz~18GHz	Dec. 06, 2013	Dec. 19, 2013	Dec. 05, 2014	Radiation (03CH01-KS)
SHF-EHF Horn	Schwarzbeck	BBHA 9170	BBHA170249	15GHz~40GHz	Nov. 22, 2013	Dec. 19, 2013	Nov. 21, 2014	Radiation (03CH01-KS)
Active Horn Antenna	com-power	AHA-118	701030	1GHz~18GHz /AMP 25dB +/- 2	Nov. 18, 2013	Dec. 19, 2013	Nov. 17, 2014	Radiation (03CH01-KS)
Amplifier	com-power	PA-103A	161069	1MHz~1GHz /32 dB	May 23, 2013	Dec. 19, 2013	May 22, 2014	Radiation (03CH01-KS)
Amplifier	Agilent	8449B	3008A02370	1GHz~26.5GHz >23dB	Dec. 29, 2012	Dec. 19, 2013	Dec. 28, 2013	Radiation (03CH01-KS)
Turn Table	MF	MF7802	N/A	0~360 degree	NCR	Dec. 19, 2013	NCR	Radiation (03CH01-KS)
Antenna Mast	MF	MF7802	N/A	1 m~4 m	NCR	Dec. 19, 2013	NCR	Radiation (03CH01-KS)



5 Uncertainty of Evaluation

Uncertainty of Radiated Emission Measurement (30MHz ~ 1000MHz)

Measuring Uncertainty for a Level of Confidence of 95% ($U = 2Uc(y)$)	2.54
---	------