

FCC C2PC Test Report

FCC ID : NKR-MB43
Equipment : Wireless module
Model No. : DHSC-MB43
Brand Name : WNC
Applicant : Wistron NeWeb Corporation
Address : 20 Park Avenue II, Hsinchu Science Park,
Hsinchu 308,Taiwan,R.O.C.
Standard : 47 CFR FCC Part 15.247
Received Date : Nov. 27, 2023
Tested Date : Nov. 30, 2023

We, International Certification Corporation, would like to declare that the tested sample has been evaluated and in compliance with the requirement of the above standards. The test results contained in this report refer exclusively to the product. It shall not be reproduced except in full without the written approval of our laboratory.

Reviewed by:

Approved by:



Along Chen / Assistant Manager



Gary Chang / Manager

Table of Contents

1	GENERAL DESCRIPTION	5
1.1	Information.....	5
1.2	Local Support Equipment List	7
1.3	Test Setup Chart	7
1.4	Test Equipment List and Calibration Data.....	8
1.5	Test Standards	9
1.6	Reference Guidance	9
1.7	Deviation from Test Standard and Measurement Procedure.....	9
1.8	Measurement Uncertainty	9
2	TEST CONFIGURATION	10
2.1	Testing Facility.....	10
2.2	The Worst Test Modes and Channel Details	10
3	TRANSMITTER TEST RESULTS.....	11
3.1	Unwanted Emissions in Restricted Frequency Bands	11
3.2	AC Power Line Conducted Emissions	13
4	TEST LABORATORY INFORMATION	14

Appendix A. Unwanted Emissions into Restricted Frequency Bands

Appendix B. AC Power Line Conducted Emissions

Release Record

Report No.	Version	Description	Issued Date
FR271305-02AE	Rev. 01	Initial issue	Dec. 15, 2023

Summary of Test Results

FCC Rules	Test Items	Measured	Result
15.207	AC Power Line Conducted Emissions	[dBuV]: 0.535MHz 28.14 (Margin -17.86dB) - AV	Pass
15.247(d) 15.209	Unwanted Emissions	[dBuV/m at 3m]: 71.71MHz 33.18 (Margin -6.82dB) - PK	Pass

Declaration of Conformity:

The test results with all measurement uncertainty excluded are presented in accordance with the regulation limits or requirements declared by manufacturers.

Comments and Explanations:

The declared of product specification for EUT presented in the report are provided by the manufacturer, and the manufacturer takes all the responsibilities for the accuracy of product specification.

1 General Description

1.1 Information

This is a Class II Permissive Change report. (C2PC).

This report is issued as a supplementary report to the original report no. FR271305-01AE.

The change of the EUT is listed as the following of hardware modification of non-RF section:

1. Add a Schottky diode to protect LDO voltage regulator.
2. Add a level shifter on UART6_RX
3. Add a 5V net to connector
4. PCB layout is modified for above change

In this report, all related test items had been re-tested and presented in the following sections.

1.1.1 Specification of the Equipment under Test (EUT)

RF General Information				
Frequency Range (MHz)	Bluetooth Mode	Ch. Freq. (MHz)	Channel Number	Data Rate
2400-2483.5	LE	2402-2480	0-39 [40]	1 Mbps
Note: Bluetooth LE (Low energy) uses GFSK modulation.				

1.1.2 Antenna Details

Ant. No.	Type	Connector	Gain (dBi)
1	PIFA	No	2.6

1.1.3 Power Supply Type of Equipment under Test (EUT)

Power Supply Type	12.7Vdc from host
-------------------	-------------------

1.1.4 Accessories

N/A

1.1.5 Channel List

Frequency band (MHz)				2400~2483.5			
Channel	Frequency (MHz)	Channel	Frequency (MHz)	Channel	Frequency (MHz)	Channel	Frequency (MHz)
37	2402	9	2422	18	2442	28	2462
0	2404	10	2424	19	2444	29	2464
1	2406	38	2426	20	2446	30	2466
2	2408	11	2428	21	2448	31	2468
3	2410	12	2430	22	2450	32	2470
4	2412	13	2432	23	2452	33	2472
5	2414	14	2434	24	2454	34	2474
6	2416	15	2436	25	2456	35	2476
7	2418	16	2438	26	2458	36	2478
8	2420	17	2440	27	2460	39	2480

1.2 Local Support Equipment List

Support Equipment List					
No.	Equipment	Brand	Model	FCC ID	Remarks
1	Notebook	DELL	Latitude 5400	DoC	---
2	Fixture	---	---	---	Provided by applicant.

1.3 Test Setup Chart

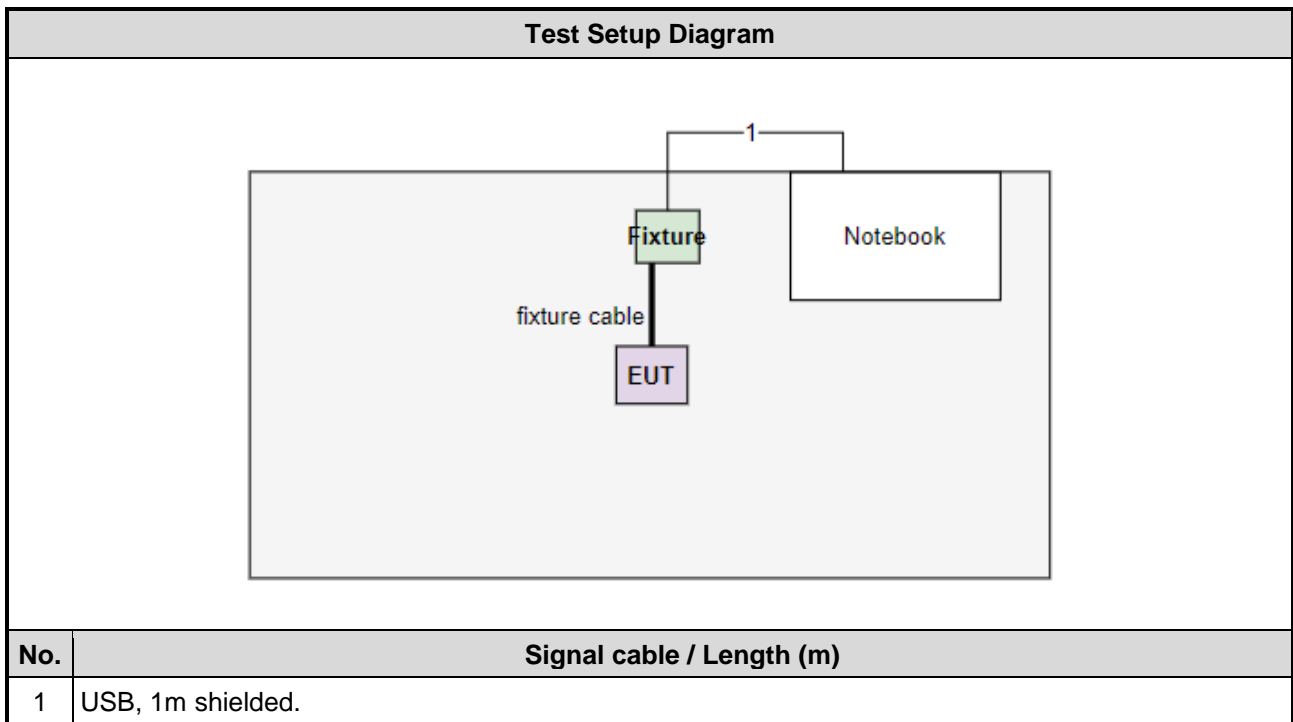

1.4 Test Equipment List and Calibration Data

Test Item	Conducted Emission				
Test Site	Conduction room 1 / (CO01-WS)				
Tested Date	Nov. 30, 2023				
Instrument	Brand	Model No.	Serial No.	Calibration Date	Calibration Until
Receiver	R&S	ESR3	101658	Feb. 17, 2023	Feb. 16, 2024
LISN	R&S	ENV216	101579	May 09, 2023	May 08, 2024
LISN (Support Unit)	SCHWARZBECK	Schwarzbeck 8127	8127667	Jan .03, 2023	Jan .02, 2024
RF Cable-CON	Woken	CFD200-NL	CFD200-NL-001	Oct. 11, 2023	Oct. 10, 2024
50 ohm terminal (Support Unit)	NA	50	01	Jun. 14, 2023	Jun. 13, 2024
Measurement Software	AUDIX	e3	6.120210k	NA	NA
Note: Calibration Interval of instruments listed above is one year.					

Test Item	Radiated Emission				
Test Site	966 chamber1 / (03CH01-WS)				
Tested Date	Nov. 30, 2023				
Instrument	Brand	Model No.	Serial No.	Calibration Date	Calibration Until
Receiver	R&S	ESR3	101657	Mar. 03, 2023	Mar. 02, 2024
Loop Antenna	R&S	HFH2-Z2	100330	Oct. 31, 2023	Oct. 30, 2024
Bilog Antenna	SCHWARZBECK	VULB9168	VULB9168-522	Jul. 31, 2023	Jul. 30, 2024
Preamplifier	EMC	EMC02325	980225	Jun. 28, 2023	Jun. 27, 2024
Loop Antenna Cable	KOAX KABEL	101354-BW	101354-BW	Oct. 03, 2023	Oct. 02, 2024
LF cable 3M	Woken	CFD400NL-LW	CFD400NL-001	Oct. 03, 2023	Oct. 02, 2024
LF cable 11M	EMC	EMCCFD400-NW-N W-11000	200801	Oct. 03, 2023	Oct. 02, 2024
LF cable 1M	EMC	EMCCFD400-NM-N M-1000	160502	Oct. 03, 2023	Oct. 02, 2024
Measurement Software	AUDIX	e3	6.120210g	NA	NA
Note: Calibration Interval of instruments listed above is one year.					

1.5 Test Standards

47 CFR FCC Part 15.247

ANSI C63.10-2013

1.6 Reference Guidance

FCC KDB 558074 D01 15.247 Meas Guidance v05r02

1.7 Deviation from Test Standard and Measurement Procedure

None

1.8 Measurement Uncertainty

The measurement uncertainties given below are based on a 95% confidence level (based on a coverage factor ($k=2$)).

Measurement Uncertainty	
Parameters	Uncertainty
AC conducted emission	± 2.92 dB
Unwanted Emission ≤ 1 GHz	± 3.41 dB

2 Test Configuration

2.1 Testing Facility

Test Laboratory	International Certification Corporation
Test Site	CO01-WS, 03CH01-WS
Address of Test Site	No.3-1, Lane 6, Wen San 3rd St., Kwei Shan Dist., Tao Yuan City 33381, Taiwan (R.O.C.)

- FCC Designation No.: TW2732
- FCC site registration No.: 181692
- ISED#: 10807A
- CAB identifier: TW2732

2.2 The Worst Test Modes and Channel Details

Test item	Modulation Mode	Test Frequency (MHz)	Test Configuration
AC Power Line Conducted Emissions	BT-LE(1Mbps)	2440	---
Unwanted Emissions ≤ 1GHz	BT-LE(1Mbps)	2440	---

NOTE:

- The EUT was pretested with 3 orientations placed on the table for the radiated emission measurement – X, Y, and Z-plane. The **X-plane** results were found as the worst case and were shown in this report.

3 Transmitter Test Results

3.1 Unwanted Emissions in Restricted Frequency Bands

3.1.1 Limit of Unwanted Emissions in Restricted Frequency Bands

Restricted Band Emissions Limit			
Frequency Range (MHz)	Field Strength (uV/m)	Field Strength (dBuV/m)	Measure Distance (m)
0.009~0.490	2400/F(kHz)	48.5 - 13.8	300
0.490~1.705	24000/F(kHz)	33.8 - 23	30
1.705~30.0	30	29	30
30~88	100	40	3
88~216	150	43.5	3
216~960	200	46	3
Above 960	500	54	3

Note 1:
 Qusai-Peak value is measured for frequency below 1GHz except for 9–90 kHz, 110–490 kHz frequency band. Peak and average value are measured for frequency above 1GHz. The limit on average radio frequency emission is as above table. The limit on peak radio frequency emissions is 20 dB above the maximum permitted average emission limit

Note 2:
 Measurements may be performed at a distance other than what is specified provided. When performing measurements at a distance other than that specified, the results shall be extrapolated to the specified distance using an extrapolation factor as below, Frequency at or above 30 MHz: 20 dB/decade Frequency below 30 MHz: 40 dB/decade.

3.1.2 Test Procedures

1. Measurement is made at a semi-anechoic chamber that incorporates a turntable allowing a EUT rotation of 360°. A continuously-rotating, remotely-controlled turntable is installed at the test site to support the EUT and facilitate determination of the direction of maximum radiation for each EUT emission frequency. The EUT is placed at test table. For emissions testing at or below 1 GHz, the table height is 80 cm above the reference ground plane.
2. Measurement is made with the antenna positioned in both the horizontal and vertical planes of polarization. The measurement antenna is varied in height (1m ~ 4m) above the reference ground plane to obtain the maximum signal strength. Distance between EUT and antenna is 3 m.
3. This investigation is performed with the EUT rotated 360°, the antenna height scanned between 1 m and 4 m, and the antenna rotated to repeat the measurements for both the horizontal and vertical antenna polarizations.

Note:

1. 120kHz measurement bandwidth of test receiver and Quasi-peak detector is for radiated emission below 1GHz.

3.1.3 Test Setup

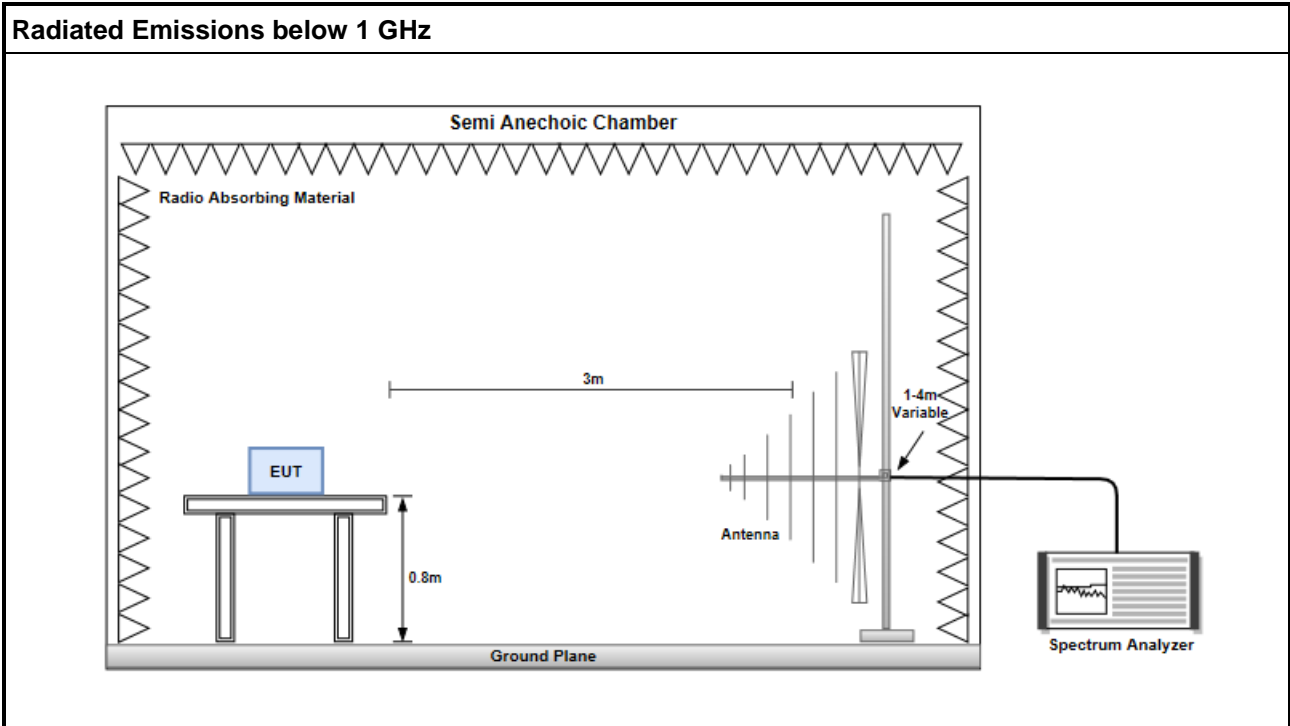

3.1.4 Test Results

Refer to Appendix A.

3.2 AC Power Line Conducted Emissions

3.2.1 Limit of AC Power Line Conducted Emissions

Conducted Emissions Limit		
Frequency Emission (MHz)	Quasi-Peak	Average
0.15-0.5	66 - 56 *	56 - 46 *
0.5-5	56	46
5-30	60	50

Note 1: * Decreases with the logarithm of the frequency.

3.2.2 Test Procedures

1. The device is placed on a test table, raised 80 cm above the reference ground plane. The vertical conducting plane is located 40 cm to the rear of the device.
2. The device is connected to line impedance stabilization network (LISN) and other accessories are connected to other LISN. Measured levels of AC power line conducted emission are across the 50 Ω LISN port.
3. AC conducted emission measurements is made over frequency range from 150 kHz to 30 MHz.
4. This measurement was performed with AC 120V/60Hz

3.2.3 Test Setup

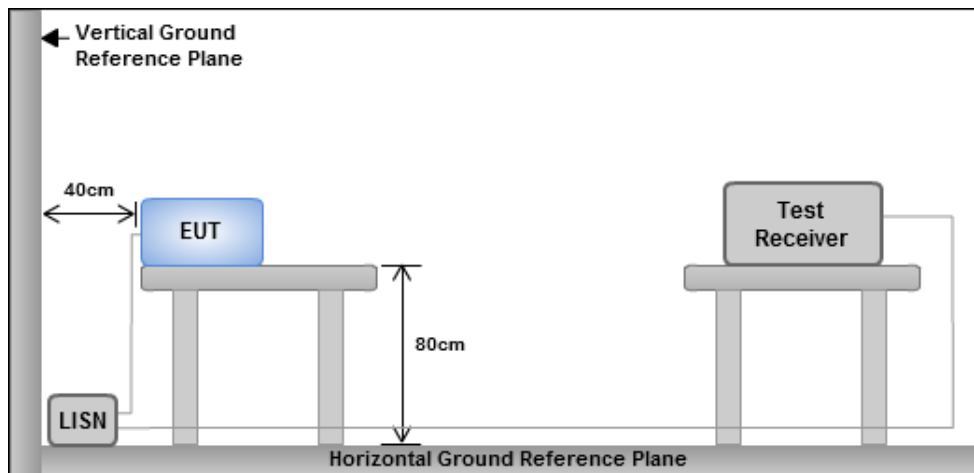

- Note: 1. Support units were connected to second LISN.
2. Both of LISNs (AMN) are 80 cm from EUT and at least 80 cm from other units and other metal planes

3.2.4 Test Results

Refer to Appendix B.

4 Test laboratory information

Established in 2012, ICC provides foremost EMC & RF Testing and advisory consultation services by our skilled engineers and technicians. Our services employ a wide variety of advanced edge test equipment and one of the widest certification extents in the business.

International Certification Corporation (EMC and Wireless Communication Laboratory), it is our definitive objective is to institute long term, trust-based associations with our clients. The expectation we set up with our clients is based on outstanding service, practical expertise and devotion to a certified value structure. Our passion is to grant our clients with best EMC / RF services by oriented knowledgeable and accommodating staff.

Our Test sites are located at Linkou District and Kwei Shan District. Location map can be found on our website <http://www.icertifi.com.tw>.

Linkou

Tel: 886-2-2601-1640

No.30-2, Ding Fwu Tsuen, Lin Kou
District, New Taipei City, Taiwan
(R.O.C.)

Kwei Shan

Tel: 886-3-271-8666

No.3-1, Lane 6, Wen San 3rd
St., Kwei Shan Dist., Tao Yuan
City 33381, Taiwan (R.O.C.)
No.2-1, Lane 6, Wen San 3rd
St., Kwei Shan Dist., Tao Yuan
City 33381, Taiwan (R.O.C.)

Kwei Shan Site II

Tel: 886-3-271-8640

No.14-1, Lane 19, Wen San 3rd
St., Kwei Shan Dist., Tao Yuan
City 33381, Taiwan (R.O.C.)

If you have any suggestion, please feel free to contact us as below information.

Tel: 886-3-271-8666

Fax: 886-3-318-0155

Email: ICC_Service@icertifi.com.tw

==END==



Unwanted Emissions (Below 1GHz)

Modulation	BT-LE (1Mbps)	Test Freq. (MHz)	2440
Polarization	Horizontal		

Test By :Brad Wu Temperature(°C):23 Humidity(%):64

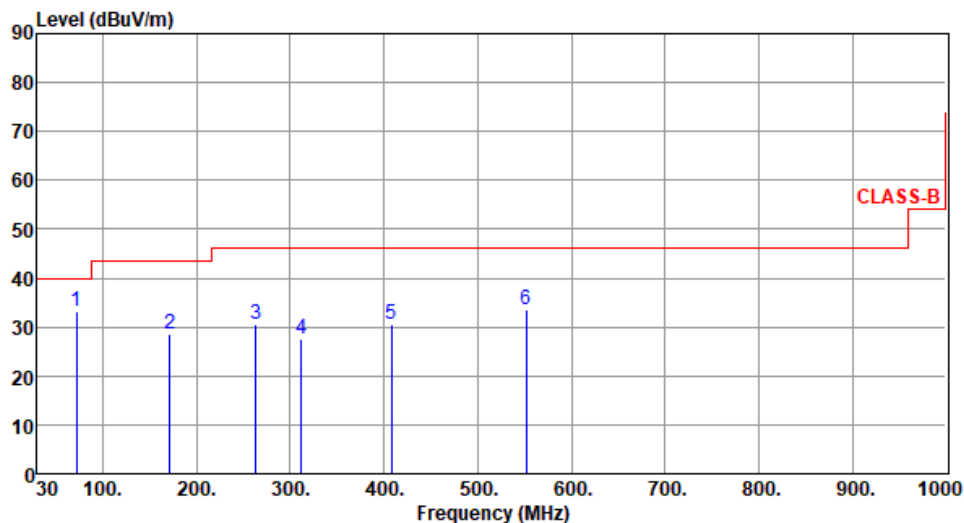

	Freq. MHz	Emission level dBuV/m	Limit dBuV/m	Margin dB	SA reading dBuV	Factor dB/m	Remark	ANT High cm	Turn Table deg
1	71.71	33.18	40.00	-6.82	44.43	-11.25	Peak	---	---
2	171.62	28.70	43.50	-14.80	38.05	-9.35	Peak	---	---
3	263.77	30.65	46.00	-15.35	40.00	-9.35	Peak	---	---
4	312.27	27.67	46.00	-18.33	35.31	-7.64	Peak	---	---
5	408.30	30.41	46.00	-15.59	35.53	-5.12	Peak	---	---
6	551.86	33.64	46.00	-12.36	35.81	-2.17	Peak	---	---

Note 1: Emission Level (dBuV/m) = SA Reading (dBuV) + Factor* (dB/m)

*Factor includes antenna factor , cable loss and amplifier gain

Note 2: Margin (dB) = Emission level (dBuV/m) – Limit (dBuV/m).

Note 3: All spurious emissions below 30MHz are more than 20 dB below the limit.



Modulation	BT-LE (1Mbps)	Test Freq. (MHz)	2440
------------	---------------	------------------	------

Polarization	Vertical
--------------	----------

Test By :Brad Wu Temperature(°C):23 Humidity(%):64

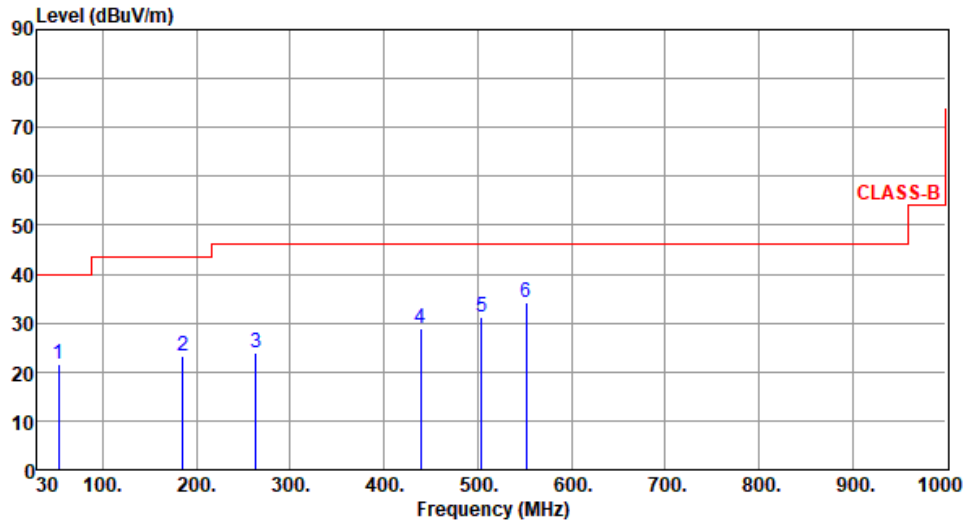

	Freq. MHz	Emission level dBuV/m	Limit dBuV/m	Margin dB	SA reading dBuV	Factor dB/m	Remark	ANT High cm	Turn Table deg
1	53.28	21.59	40.00	-18.41	29.57	-7.98	Peak	---	---
2	185.20	23.36	43.50	-20.14	34.22	-10.86	Peak	---	---
3	263.77	23.87	46.00	-22.13	33.22	-9.35	Peak	---	---
4	439.34	28.77	46.00	-17.23	33.01	-4.24	Peak	---	---
5	504.33	31.06	46.00	-14.94	33.95	-2.89	Peak	---	---
6	551.86	34.35	46.00	-11.65	36.52	-2.17	Peak	---	---

Note 1: Emission Level (dBuV/m) = SA Reading (dBuV) + Factor* (dB/m)

*Factor includes antenna factor , cable loss and amplifier gain

Note 2: Margin (dB) = Emission level (dBuV/m) – Limit (dBuV/m).

Note 3: All spurious emissions below 30MHz are more than 20 dB below the limit.



Modulation	BT-LE(1Mbps)	Test Freq. (MHz)	2440
Power Phase	Line		

Test by : Brad Wu Temperature: 23°C Humidity: 64%

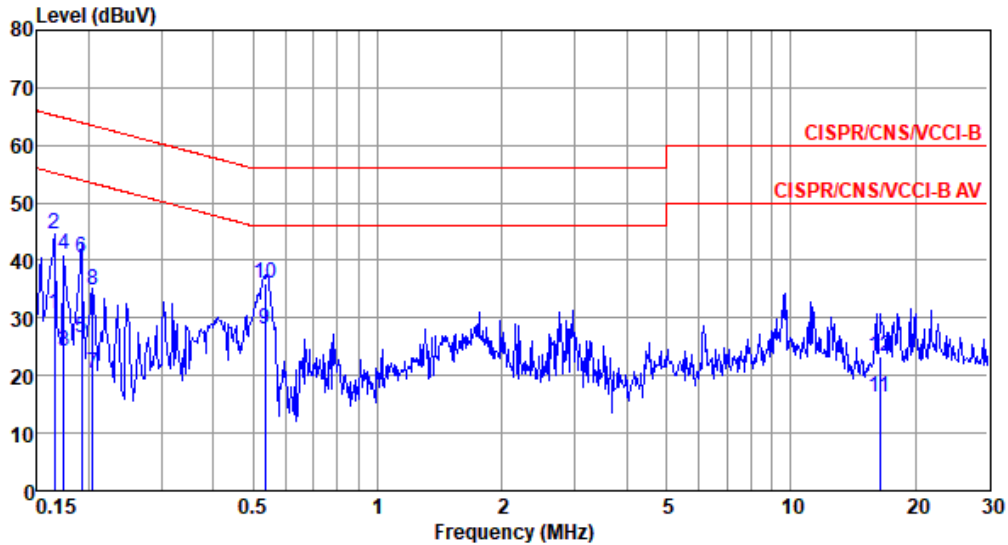

	Freq MHz	Level dBuV	Limit Line dBuV	Over Limit dB	Read Level dBuV	Factor dB	Cable loss dB	Aux dB	Remark
1	0.165	30.67	55.21	-24.54	20.97	9.63	0.07	0.00	Average
2	0.165	44.60	65.21	-20.61	34.90	9.63	0.07	0.00	QP
3	0.174	24.29	54.77	-30.48	14.60	9.62	0.07	0.00	Average
4	0.174	40.98	64.77	-23.79	31.29	9.62	0.07	0.00	QP
5	0.192	26.46	53.93	-27.47	16.78	9.62	0.06	0.00	Average
6	0.192	40.33	63.93	-23.60	30.65	9.62	0.06	0.00	QP
7	0.204	20.51	53.45	-32.94	10.83	9.62	0.06	0.00	Average
8	0.204	34.82	63.45	-28.63	25.14	9.62	0.06	0.00	QP
9*	0.535	28.14	46.00	-17.86	18.44	9.62	0.08	0.00	Average
10	0.535	36.11	56.00	-19.89	26.41	9.62	0.08	0.00	QP
11	16.398	16.32	50.00	-33.68	6.18	9.68	0.46	0.00	Average
12	16.398	23.19	60.00	-36.81	13.05	9.68	0.46	0.00	QP

Note 1: Level (dBuV) = Read Level (dBuV) + LISN Factor (dB) + Cable Loss (dB) + Aux (dB).
 Note 2: Over Limit (dB) = Level (dBuV) - Limit Line (dBuV).



Modulation	BT-LE(1Mbps)	Test Freq. (MHz)	2440
Power Phase	Neutral		

Test by : Brad Wu Temperature: 23°C Humidity: 64%

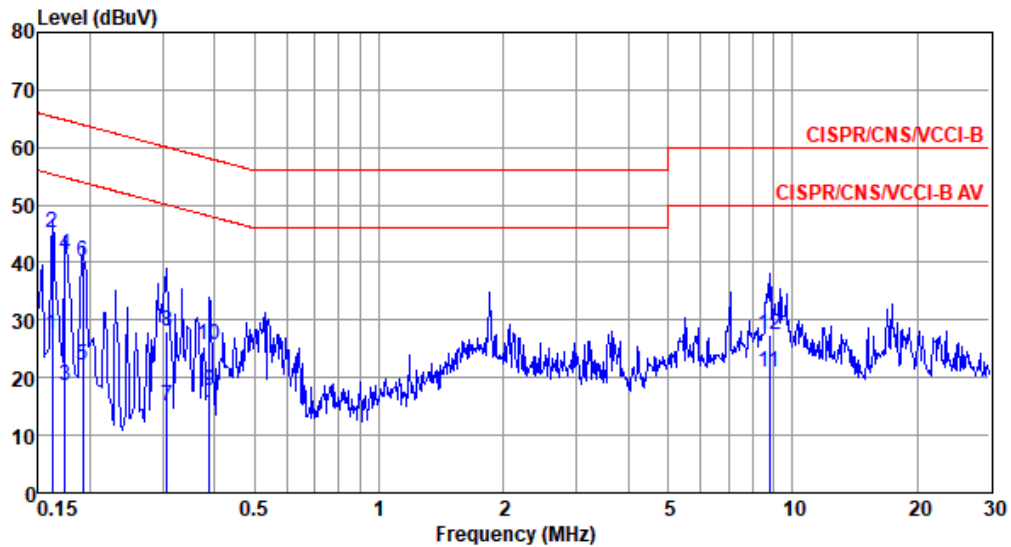

	Freq MHz	Level dBuV	Limit Line dBuV	Over Limit dB	Read Level dBuV	Factor dB	Cable loss dB	Aux dB	Remark
1	0.162	27.51	55.34	-27.83	17.81	9.63	0.07	0.00	Average
2*	0.162	45.04	65.34	-20.30	35.34	9.63	0.07	0.00	QP
3	0.174	18.55	54.77	-36.22	8.85	9.63	0.07	0.00	Average
4	0.174	41.21	64.77	-23.56	31.51	9.63	0.07	0.00	QP
5	0.192	22.08	53.93	-31.85	12.39	9.63	0.06	0.00	Average
6	0.192	40.06	63.93	-23.87	30.37	9.63	0.06	0.00	QP
7	0.307	15.11	50.06	-34.95	5.42	9.62	0.07	0.00	Average
8	0.307	28.03	60.06	-32.03	18.34	9.62	0.07	0.00	QP
9	0.389	17.70	48.08	-30.38	8.00	9.62	0.08	0.00	Average
10	0.389	25.77	58.08	-32.31	16.07	9.62	0.08	0.00	QP
11	8.776	20.93	50.00	-29.07	10.91	9.70	0.32	0.00	Average
12	8.776	27.41	60.00	-32.59	17.39	9.70	0.32	0.00	QP

Note 1: Level (dBuV) = Read Level (dBuV) + LISN Factor (dB) + Cable Loss (dB) + Aux (dB).
 2: Over Limit (dB) = Level (dBuV) – Limit Line (dBuV).