

FCC Test Report

(PART 24)

Report No.: RF190606E05-1

FCC ID: NKR-LVSK-P1

Test Model: LVP1

Received Date: Jun. 06, 2019

Test Date: Jul. 05, 2019 ~ Jul. 08, 2019

Issued Date: Jul. 18, 2019

Applicant: Wistron NeWeb Corporation

Address: 20 Park Avenue II, Hsinchu Science Park, Hsinchu 308, Taiwan, R.O.C.

Issued By: Bureau Veritas Consumer Products Services (H.K.) Ltd., Taoyuan Branch

Lab Address: No. 47-2, 14th Ling, Chia Pau Vil., Lin Kou Dist., New Taipei City, Taiwan
(R.O.C)

Test Location: No. 19, Hwa Ya 2nd Rd, Wen Hwa Vil, Kwei Shan Dist., Taoyuan City
33383, Taiwan (R.O.C)

**FCC Registration /
Designation Number:** 788550 / TW0003



This report is for your exclusive use. Any copying or replication of this report to or for any other person or entity, or use of our name or trademark, is permitted only with our prior written permission. This report sets forth our findings solely with respect to the test samples identified herein. The results set forth in this report are not indicative or representative of the quality or characteristics of the lot from which a test sample was taken or any similar or identical product unless specifically and expressly noted. Our report includes all of the tests requested by you and the results thereof based upon the information that you provided to us. You have 60 days from date of issuance of this report to notify us of any material error or omission caused by our negligence, provided, however, that such notice shall be in writing and shall specifically address the issue you wish to raise. A failure to raise such issue within the prescribed time shall constitute your unqualified acceptance of the completeness of this report, the tests conducted and the correctness of the report contents. Unless specifically mentioned, the uncertainty of measurement has been explicitly taken into account to declare the compliance or non-compliance to the specification. The report must not be used by the client to claim product certification, approval, or endorsement by TAF or any government agencies.

Table of Contents

Release Control Record	3
1 Certificate of Conformity	4
2 Summary of Test Results	5
2.1 Measurement Uncertainty	5
2.2 Test Site and Instruments	6
3 General Information	7
3.1 General Description of EUT	7
3.2 Configuration of System under Test	8
3.2.1 Description of Support Units	8
3.3 Test Mode Applicability and Tested Channel Detail	9
3.4 EUT Operating Conditions	9
3.5 General Description of Applied Standards	10
4 Test Types and Results	11
4.1 Output Power Measurement	11
4.1.1 Limits of Output Power Measurement	11
4.1.2 Test Procedures	11
4.1.3 Test Setup	12
4.1.4 Test Results	13
4.2 Radiated Emission Measurement	18
4.2.1 Limits of Radiated Emission Measurement	18
4.2.2 Test Procedure	18
4.2.3 Deviation from Test Standard	18
4.2.4 Test Setup	19
4.2.5 Test Results	20
5 Pictures of Test Arrangements	38
Appendix – Information of the Testing Laboratories	39

Release Control Record

Issue No.	Description	Date Issued
RF190606E05-1	Original Release	Jul. 18, 2019

1 Certificate of Conformity

Product: Home Phone Base
Brand: WNC
Test Model: LVP1
Sample Status: Engineering Sample
Applicant: Wistron NeWeb Corporation
Test Date: Jul. 05, 2019 ~ Jul. 08, 2019
Standards: FCC Part 24, Subpart E

The above equipment has been tested by **Bureau Veritas Consumer Products Services (H.K.) Ltd., Taoyuan Branch**, and found compliance with the requirement of the above standards. The test record, data evaluation & Equipment Under Test (EUT) configurations represented herein are true and accurate accounts of the measurements of the sample's RF characteristics under the conditions specified in this report.

Prepared by : Rona Chen, **Date:** Jul. 18, 2019
Rona Chen / Specialist

Approved by : Dylan Chiou, **Date:** Jul. 18, 2019
Dylan Chiou / Project Engineer

2 Summary of Test Results

Applied Standard: FCC Part 24 & Part 2			
FCC Clause	Test Item	Result	Remarks
2.1046 24.232	Effective Isotropic Radiated Power	Pass	Meet the requirement of limit.
2.1047	Modulation Characteristics	N/A	Refer to Note
2.1046 24.232(d)	Peak to Average Ratio	N/A	Refer to Note
2.1055 24.235	Frequency Stability	N/A	Refer to Note
2.1049	Occupied Bandwidth	N/A	Refer to Note
24.238	Band Edge Measurements	N/A	Refer to Note
2.1051 24.238	Conducted Spurious Emissions	N/A	Refer to Note
2.1053 24.238	Radiated Spurious Emissions	Pass	Meet the requirement of limit. Minimum passing margin is -26.67 dB at 88.20 MHz.

Note:

1. This is a partial report. Only test item of Effective Isotropic Radiated Power and Radiated Spurious Emissions tests were performed for this report. Other testing data please refer to BV CPS report no.: RF180504E08-1 for module (Brand: Wistron NeWeb Corporation, Model: IMG2)
2. Determining compliance based on the results of the compliance measurement, not taking into account measurement instrumentation uncertainty.

2.1 Measurement Uncertainty

Where relevant, the following measurement uncertainty levels have been estimated for tests performed on the EUT as specified in CISPR 16-4-2:

Measurement	Frequency	Expanded Uncertainty (k=2) (±)
Radiated Emissions up to 1 GHz	9 kHz ~ 30 MHz	3.0400 dB
	30 MHz ~ 200 MHz	2.0153 dB
	200 MHz ~ 1000 MHz	2.0224 dB
Radiated Emissions above 1 GHz	1 GHz ~ 18 GHz	1.0121 dB
	18 GHz ~ 40 GHz	1.1508 dB

2.2 Test Site and Instruments

Description & Manufacturer	Model No.	Serial No.	Date of Calibration	Due Date of Calibration
Test Receiver Agilent	N9038A	MY51210203	Mar. 18, 2019	Mar. 17, 2020
Spectrum Analyzer Agilent	N9010A	MY52220314	Dec. 13, 2018	Dec. 12, 2019
Spectrum Analyzer ROHDE & SCHWARZ	FSU43	101261	Apr. 15, 2019	Apr. 14, 2020
Spectrum Analyzer ROHDE & SCHWARZ	FSW26	102023	Oct. 11, 2018	Oct. 10, 2019
HORN Antenna SCHWARZBECK	BBHA 9120D	9120D-969	Nov. 25, 2018	Nov. 24, 2019
BILOG Antenna SCHWARZBECK	VULB9168	9168-472	Nov. 23, 2018	Nov. 22, 2019
Horn Antenna SCHWARZBECK	BBHA 9170	148	Nov. 25, 2018	Nov. 24, 2019
Fixed Attenuator Mini-Circuits	MDCS18N-10	MDCS18N-10-01	Apr. 15, 2019	Apr. 14, 2020
MXG Vector signal generator Agilent	N5182B	MY53050430	Nov. 19, 2018	Nov. 18, 2019
Preamplifier EMCI	EMC 012645	980115	Oct. 12, 2018	Oct. 11, 2019
Preamplifier EMCI	EMC 330H	980112	Oct. 12, 2018	Oct. 11, 2019
RF Coaxial Cable HUBER+SUHNNER	EMC104-SM-SM-800 0&3000	140811+170717	Oct. 12, 2018	Oct. 11, 2019
RF Coaxial Cable HUBER+SUHNNER	SUCOFLEX 104	EMC104-SM-SM-1 000(140807)	Oct. 12, 2018	Oct. 11, 2019
RF Coaxial Cable WOKEN	8D-FB	Cable-Ch10-01	Oct. 12, 2018	Oct. 11, 2019
Boresight Antenna Fixture	FBA-01	FBA-SIP01	NA	NA
Software BV ADT	E3 6.120103	NA	NA	NA
Antenna Tower MF	MFA-440H	NA	NA	NA
Turn Table MF	MFT-201SS	NA	NA	NA
Antenna Tower & Turn Table Controller MF	MF-7802	NA	NA	NA
Communications Tester-Wireless Agilent	8960 Series 10	MY53201073	Jul. 01, 2019	Jun. 30, 2020
Radio Communication Analyzer Anritsu	MT8820C	6201300640	Aug. 16, 2017	Aug. 15, 2019
Temperature & Humidity Chamber	GTH-120-40-CP-AR	MAA1306-019	Sep. 05, 2018	Sep. 04, 2019
DC Power Supply Topward	33010D	807748	NA	NA

- Note: 1. The calibration interval of the above test instruments is 12 / 24 months and the calibrations are traceable to NML/ROC and NIST/USA.
2. The test was performed in HwaYa Chamber 10.

3 General Information

3.1 General Description of EUT

Product	Home Phone Base	
Brand	WNC	
Test Model	LVP1	
Status of EUT	Engineering Sample	
Power Supply Rating	5.0 Vdc (Adapter) 3.6 Vdc (Li-ion battery)	
Modulation Type	LTE	QPSK, 16QAM
Frequency Range	LTE Band 2 (Channel Bandwidth: 1.4 MHz)	1850.7 ~ 1909.3 MHz
	LTE Band 2 (Channel Bandwidth: 3 MHz)	1851.5 ~ 1908.5 MHz
	LTE Band 2 (Channel Bandwidth: 5 MHz)	1852.5 ~ 1907.5 MHz
	LTE Band 2 (Channel Bandwidth: 10 MHz)	1855.0 ~ 1905.0 MHz
	LTE Band 2 (Channel Bandwidth: 15 MHz)	1857.5 ~ 1902.5 MHz
	LTE Band 2 (Channel Bandwidth: 20 MHz)	1860.0 ~ 1900.0 MHz
Max. EIRP Power	LTE Band 2 (Channel Bandwidth: 1.4 MHz)	335.74 mW
	LTE Band 2 (Channel Bandwidth: 3 MHz)	359.75 mW
	LTE Band 2 (Channel Bandwidth: 5 MHz)	381.94 mW
	LTE Band 2 (Channel Bandwidth: 10 MHz)	403.65 mW
	LTE Band 2 (Channel Bandwidth: 15 MHz)	425.60 mW
	LTE Band 2 (Channel Bandwidth: 20 MHz)	448.75 mW
Antenna Type	PIFA Antenna	
Antenna Gain	3.11 dBi (Main) / 3.85 dBi (Aux.)	
Accessory Device	Refer to Note as below	
Data Cable Supplied	1m shielded USB cable without core	

Note:

1. The module (Brand: Wistron NeWeb Corporation, FCC ID: NKR-IMG2, Model: IMG2) was installed in EUT. The EUT has different antenna with module.
2. The EUT contains following accessory devices.

Product	Brand	Model	Description
Adapter	Lucent Trans	1A52-US0502	I/P: 100-240 Vac, 50-60 Hz, 0.4 A O/P: 5.0 Vdc, 2 A
Battery	WNC	BTY-LRV5000	3.6 Vdc, 2330 mAh

3. The above EUT information is declared by manufacturer and for more detailed features description, please refers to the manufacturer's specifications or user's manual.

3.2 Configuration of System under Test

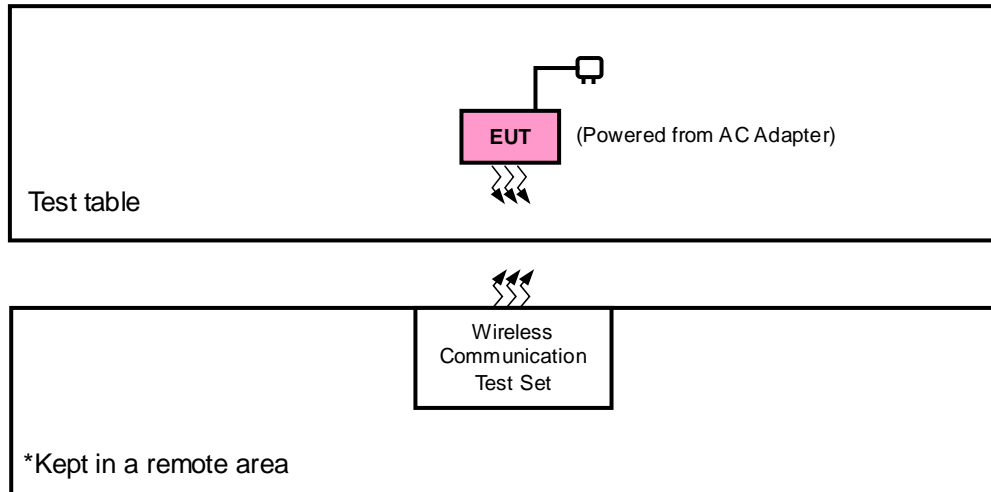

3.2.1 Description of Support Units

The EUT has been tested as an independent unit together with other necessary accessories or support units.

3.3 Test Mode Applicability and Tested Channel Detail

Pre-Scan has been conducted to determine the worst-case mode from all possible combinations between available modulations, data rates, and antenna ports.

The worst case was found when positioned as the table below. Following channel(s) was (were) selected for the final test as listed below:

Band	EIRP	Radiated Emission
LTE Band 2	X-plane	X-plane

LTE Band 2

EUT Configure Mode	Test Item	Available Channel	Tested Channel	Channel Bandwidth	Modulation	Mode
-	EIRP	18607 to 19193	18607, 18900, 19193	1.4 MHz	QPSK, 16QAM	1 RB / 0 RB Offset
		18615 to 19185	18615, 18900, 19185	3 MHz	QPSK, 16QAM	1 RB / 0 RB Offset
		18625 to 19175	18625, 18900, 19175	5 MHz	QPSK, 16QAM	1 RB / 0 RB Offset
		18650 to 19150	18650, 18900, 19150	10 MHz	QPSK, 16QAM	1 RB / 0 RB Offset
		18675 to 19125	18675, 18900, 19125	15 MHz	QPSK, 16QAM	1 RB / 0 RB Offset
		18700 to 19100	18700, 18900, 19100	20 MHz	QPSK, 16QAM	1 RB / 0 RB Offset
-	Radiated Emission	18607 to 19193	18607, 18900, 19193	1.4 MHz	QPSK	1 RB / 0 RB Offset
		18650 to 19150	18650, 18900, 19150	10 MHz	QPSK	1 RB / 0 RB Offset
		18700 to 19100	18700, 18900, 19100	20 MHz	QPSK	1 RB / 0 RB Offset

Note:

1. This device was tested under all bandwidths, RB configurations and modulations. The worst case was found in QPSK modulation.
2. For radiated emission above 1 GHz, according to 3GPP 36.521 Section 6.6.3.1.4, choose the lowest, 5 MHz & highest channel bandwidth for final test.

Test Condition:

Test Item	Environmental Conditions	Input Power	Tested By
EIRP	26 deg. C, 58 % RH	120 Vac, 60 Hz	Getaz Yang
Radiated Emission	25 deg. C, 65 % RH	120 Vac, 60 Hz	Getaz Yang

3.4 EUT Operating Conditions

The EUT makes a call to the communication simulator. The communication simulator station system controlled a EUT to export maximum output power under transmission mode and specific channel frequency

3.5 General Description of Applied Standards

The EUT is a RF Product. According to the specifications of the manufacturer, it must comply with the requirements of the following standards:

FCC 47 CFR Part 2

FCC 47 CFR Part 24

KDB 971168 D01 Power Meas License Digital Systems v03r01

ANSI/TIA/EIA-603-E 2016

ANSI 63.26-2015

NOTE: All test items have been performed and recorded as per the above standards.

4 Test Types and Results

4.1 Output Power Measurement

4.1.1 Limits of Output Power Measurement

Mobile / Portable station are limited to 2 watts e.i.r.p.

4.1.2 Test Procedures

EIRP / ERP Measurement:

- a. All measurements were done at low, middle and high operational frequency range. RBW and VBW is 5 MHz for WCDMA and 10 MHz for LTE mode.
- b. Substitution method is used for E.I.R.P measurement. In the semi-anechoic chamber, EUT placed on the 0.8 m (below or equal 1 GHz) and/or 1.5 m (above 1 GHz) height of Turn Table, rotated the table around 360 degrees to search the maximum radiation power and receiver antenna shall be rotated vertical and horizontal polarization and moved height from 1 m to 4 m to find the maximum polar radiated power. The "Read Value" is the spectrum reading the maximum power value.
- c. The substitution horn antenna is substituted for EUT at the same position and signals generator export the CW signal to the substitution antenna via a tx cable. Rotated the Turn Table and moved receiving antenna to find the maximum radiation power. Adjust output power level of S.G to get a Value of spectrum reading equal to "Read Value" of step b. Record the power level of S.G.
- d. $EIRP = \text{Output power level of S.G} - \text{TX cable loss} + \text{Antenna gain of substitution horn}$. E.R.P power can be calculated form E.I.R.P power by subtracting the gain of dipole, $E.R.P \text{ power} = E.I.R.P \text{ power} - 2.15 \text{ dB}$.

Conducted Power Measurement:

The EUT was set up for the maximum power with LTE link data modulation and link up with simulator. Set the EUT to transmit under low, middle and high channel and record the power level shown on simulator.

4.1.3 Test Setup

EIRP / ERP Measurement:

<Radiated Emission below or equal 1 GHz>

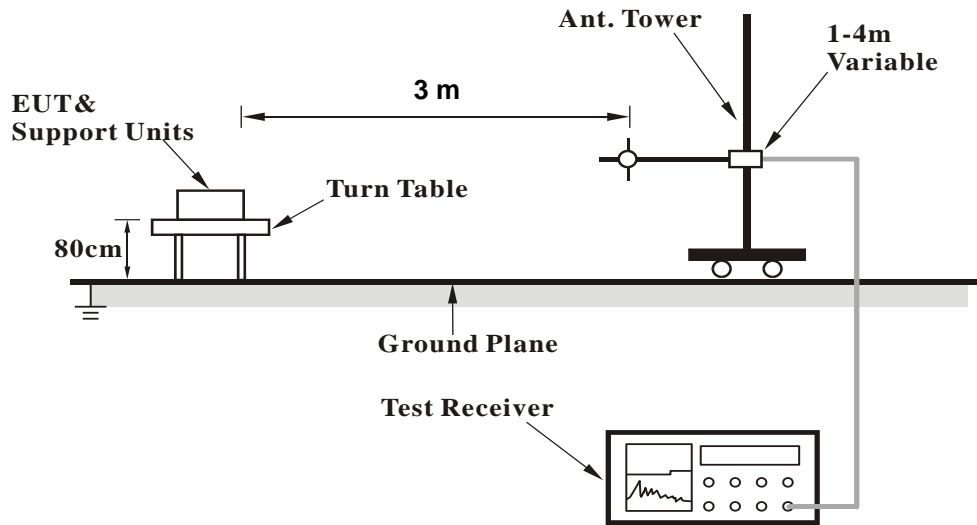

<Radiated Emission above 1 GHz>

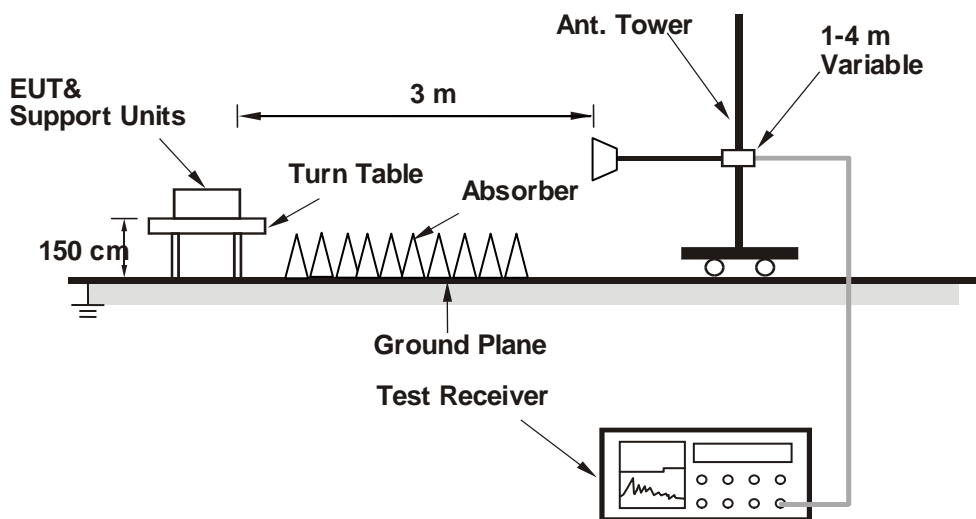

For the actual test configuration, please refer to the attached file (Test Setup Photo).

Conducted Power Measurement:



4.1.4 Test Results

Conducted Output Power (dBm)

Band / BW	RB Size	RB Offset	QPSK			3GPP MPR (dB)	16QAM			3GPP MPR (dB)
			Low Ch 18607	Mid Ch 18900	High Ch 19193		Low Ch 18607	Mid Ch 18900	High Ch 19193	
			1850.7 MHz	1880.0 MHz	1909.3 MHz		1850.7 MHz	1880.0 MHz	1909.3 MHz	
2 / 1.4M	1	0	22.70	23.20	23.14	0	21.61	22.23	22.17	1
	1	2	22.61	23.15	23.03	0	21.56	22.18	22.05	1
	1	5	22.56	22.95	22.89	0	21.45	22.12	22.01	1
	3	0	22.67	23.18	23.15	0	21.51	22.03	22.16	1
	3	1	22.71	23.14	22.91	0	21.50	22.01	22.03	1
	3	3	22.54	22.97	22.71	0	21.60	22.00	22.01	1
	6	0	21.78	22.00	21.92	1	21.03	21.07	20.84	2

Band / BW	RB Size	RB Offset	QPSK			3GPP MPR (dB)	16QAM			3GPP MPR (dB)
			Low Ch 18615	Mid Ch 18900	High Ch 19185		Low Ch 18615	Mid Ch 18900	High Ch 19185	
			1851.5 MHz	1880.0 MHz	1908.5 MHz		1851.5 MHz	1880.0 MHz	1908.5 MHz	
2 / 3M	1	0	23.05	23.35	23.23	0	22.25	22.21	21.93	1
	1	7	23.01	23.25	23.14	0	22.12	22.12	22.06	1
	1	14	23.03	23.07	23.04	0	22.09	21.93	21.84	1
	8	0	22.34	22.24	22.09	1	22.19	20.99	20.98	2
	8	3	22.25	22.09	21.96	1	21.09	20.98	20.82	2
	8	7	22.11	21.98	21.87	1	21.03	20.97	20.85	2
	15	0	22.38	21.89	21.91	1	21.29	20.91	20.93	2

Band / BW	RB Size	RB Offset	QPSK			3GPP MPR (dB)	16QAM			3GPP MPR (dB)
			Low Ch 18625	Mid Ch 18900	High Ch 19175		Low Ch 18625	Mid Ch 18900	High Ch 19175	
			1852.5 MHz	1880.0 MHz	1907.5 MHz		1852.5 MHz	1880.0 MHz	1907.5 MHz	
2 / 5M	1	0	23.11	23.41	23.09	0	22.21	22.23	22.00	1
	1	12	23.05	23.28	23.17	0	22.21	22.12	22.14	1
	1	24	23.01	23.13	22.90	0	22.12	22.05	21.82	1
	12	0	22.40	22.29	22.16	1	21.26	21.18	20.96	2
	12	6	22.25	22.11	21.96	1	21.20	21.06	20.85	2
	12	13	22.08	22.08	21.93	1	21.05	20.94	20.80	2
	25	0	22.47	22.28	22.07	1	21.42	21.11	21.04	2

Band / BW	RB Size	RB Offset	QPSK			3GPP MPR (dB)	16QAM			3GPP MPR (dB)
			Low Ch 18650	Mid Ch 18900	High Ch 19150		Low Ch 18650	Mid Ch 18900	High Ch 19150	
			1855.0 MHz	1880.0 MHz	1905.0 MHz		1855.0 MHz	1880.0 MHz	1905.0 MHz	
2 / 10M	1	0	23.53	23.47	23.35	0	22.38	22.37	22.15	1
	1	24	23.51	23.39	23.26	0	22.32	22.25	22.14	1
	1	49	23.31	23.17	23.02	0	22.22	22.12	22.06	1
	25	0	22.31	22.30	22.29	1	21.29	21.23	21.19	2
	25	12	22.30	22.15	22.04	1	21.29	21.13	21.00	2
	25	25	22.21	22.00	22.00	1	21.30	20.95	20.99	2
	50	0	22.42	22.31	22.23	1	21.40	21.27	21.13	2

Band / BW	RB Size	RB Offset	QPSK			3GPP MPR (dB)	16QAM			3GPP MPR (dB)
			Low Ch 18675	Mid Ch 18900	High Ch 19125		Low Ch 18675	Mid Ch 18900	High Ch 19125	
			1857.5 MHz	1880.0 MHz	1902.5 MHz		1857.5 MHz	1880.0 MHz	1902.5 MHz	
2 / 15M	1	0	23.65	23.53	23.40	0	22.58	22.36	22.28	1
	1	37	23.49	23.44	23.25	0	22.49	22.36	22.18	1
	1	74	23.34	23.21	23.04	0	22.33	22.14	22.05	1
	36	0	22.54	22.41	22.23	1	21.38	21.21	21.16	2
	36	19	22.36	22.22	22.06	1	21.29	21.19	21.01	2
	36	39	22.29	22.11	21.96	1	21.19	21.18	20.95	2
	75	0	22.48	22.41	22.25	1	21.40	21.39	21.17	2

Band / BW	RB Size	RB Offset	QPSK			3GPP MPR (dB)	16QAM			3GPP MPR (dB)
			Low Ch 18700	Mid Ch 18900	High Ch 19100		Low Ch 18700	Mid Ch 18900	High Ch 19100	
			1860.0 MHz	1880.0 MHz	1900.0 MHz		1860.0 MHz	1880.0 MHz	1900.0 MHz	
2 / 20M	1	0	23.73	23.58	23.46	0	22.69	22.49	22.44	1
	1	50	23.60	23.42	23.30	0	22.52	22.41	22.25	1
	1	99	23.36	23.32	23.16	0	22.37	22.24	22.05	1
	50	0	22.57	22.46	22.37	1	21.54	21.26	21.25	2
	50	25	22.37	22.27	22.19	1	21.32	21.18	21.12	2
	50	50	22.24	22.19	22.11	1	21.20	21.04	21.04	2
	100	0	22.55	22.39	22.37	1	21.49	21.40	21.23	2

EIRP Power (dBm)

LTE Band 2							
Channel Bandwidth: 1.4 MHz / QPSK							
Plane	Channel	Frequency (MHz)	Reading (dBm)	Correction Factor (dB)	EIRP (dBm)	EIRP (mW)	Polarization (H/V)
X	18607	1850.7	-11.31	36.57	25.26	335.74	H
	18900	1880.0	-12.08	37.22	25.14	326.59	
	19193	1909.3	-12.14	37.18	25.04	319.15	
	18607	1850.7	-19.11	37.65	18.54	71.45	V
	18900	1880.0	-19.44	37.58	18.14	65.16	
	19193	1909.3	-19.42	37.48	18.06	63.97	
Channel Bandwidth: 1.4 MHz / 16QAM							
X	18607	1850.7	-12.39	36.57	24.18	261.82	H
	18900	1880.0	-13.32	37.22	23.90	245.47	
	19193	1909.3	-13.41	37.18	23.77	238.23	
	18607	1850.7	-20.46	37.65	17.19	52.36	V
	18900	1880.0	-20.47	37.58	17.11	51.40	
	19193	1909.3	-20.56	37.48	16.92	49.20	

Note: EIRP (dBm) = Reading (dBm) + Correction Factor (dB)

LTE Band 2							
Channel Bandwidth: 3 MHz / QPSK							
Plane	Channel	Frequency (MHz)	Reading (dBm)	Correction Factor (dB)	EIRP (dBm)	EIRP (mW)	Polarization (H/V)
X	18615	1851.5	-11.01	36.57	25.56	359.75	H
	18900	1880.0	-11.79	37.22	25.43	349.14	
	19185	1908.5	-11.89	37.18	25.29	338.06	
	18615	1851.5	-18.89	37.65	18.76	75.16	V
	18900	1880.0	-19.09	37.58	18.49	70.63	
	19185	1908.5	-19.09	37.48	18.39	69.02	
Channel Bandwidth: 3 MHz / 16QAM							
X	18615	1851.5	-12.15	36.57	24.42	276.69	H
	18900	1880.0	-13.02	37.22	24.20	263.03	
	19185	1908.5	-13.17	37.18	24.01	251.77	
	18615	1851.5	-20.15	37.65	17.50	56.23	V
	18900	1880.0	-20.15	37.58	17.43	55.34	
	19185	1908.5	-20.29	37.48	17.19	52.36	

Note: EIRP (dBm) = Reading (dBm) + Correction Factor (dB)

LTE Band 2							
Channel Bandwidth: 5 MHz / QPSK							
Plane	Channel	Frequency (MHz)	Reading (dBm)	Correction Factor (dB)	EIRP (dBm)	EIRP (mW)	Polarization (H/V)
X	18625	1852.5	-10.75	36.57	25.82	381.94	H
	18900	1880.0	-11.59	37.22	25.63	365.59	
	19175	1907.5	-11.60	37.18	25.58	361.41	
	18625	1852.5	-18.65	37.65	19.00	79.43	V
	18900	1880.0	-18.77	37.58	18.81	76.03	
	19175	1907.5	-18.83	37.48	18.65	73.28	
Channel Bandwidth: 5 MHz / 16QAM							
X	18625	1852.5	-11.91	36.57	24.66	292.42	H
	18900	1880.0	-12.70	37.22	24.52	283.14	
	19175	1907.5	-12.92	37.18	24.26	266.69	
	18625	1852.5	-19.87	37.65	17.78	59.98	V
	18900	1880.0	-19.87	37.58	17.71	59.02	
	19175	1907.5	-19.97	37.48	17.51	56.36	

Note: EIRP (dBm) = Reading (dBm) + Correction Factor (dB)

LTE Band 2							
Channel Bandwidth: 10 MHz / QPSK							
Plane	Channel	Frequency (MHz)	Reading (dBm)	Correction Factor (dB)	EIRP (dBm)	EIRP (mW)	Polarization (H/V)
X	18650	1855.0	-10.51	36.57	26.06	403.65	H
	18900	1880.0	-11.27	37.22	25.95	393.55	
	19150	1905.0	-11.35	37.18	25.83	382.82	
	18650	1855.0	-18.43	37.65	19.22	83.56	V
	18900	1880.0	-18.57	37.58	19.01	79.62	
	19150	1905.0	-18.52	37.48	18.96	78.70	
Channel Bandwidth: 10 MHz / 16QAM							
X	18650	1855.0	-11.64	36.57	24.93	311.17	H
	18900	1880.0	-12.45	37.22	24.77	299.92	
	19150	1905.0	-12.61	37.18	24.57	286.42	
	18650	1855.0	-19.62	37.65	18.03	63.53	V
	18900	1880.0	-19.66	37.58	17.92	61.94	
	19150	1905.0	-19.73	37.48	17.75	59.57	

Note: EIRP (dBm) = Reading (dBm) + Correction Factor (dB)

LTE Band 2							
Channel Bandwidth: 15 MHz / QPSK							
Plane	Channel	Frequency (MHz)	Reading (dBm)	Correction Factor (dB)	EIRP (dBm)	EIRP (mW)	Polarization (H/V)
X	18675	1857.5	-10.28	36.57	26.29	425.60	H
	18900	1880.0	-11.03	37.22	26.19	415.91	
	19125	1902.5	-11.08	37.18	26.10	407.38	
	18675	1857.5	-18.20	37.65	19.45	88.10	V
	18900	1880.0	-18.26	37.58	19.32	85.51	
	19125	1902.5	-18.22	37.48	19.26	84.33	
Channel Bandwidth: 15 MHz / 16QAM							
X	18675	1857.5	-11.38	36.57	25.19	330.37	H
	18900	1880.0	-12.13	37.22	25.09	322.85	
	19125	1902.5	-12.34	37.18	24.84	304.79	
	18675	1857.5	-19.29	37.65	18.36	68.55	V
	18900	1880.0	-19.41	37.58	18.17	65.61	
	19125	1902.5	-19.47	37.48	18.01	63.24	

Note: EIRP (dBm) = Reading (dBm) + Correction Factor (dB)

LTE Band 2							
Channel Bandwidth: 20 MHz / QPSK							
Plane	Channel	Frequency (MHz)	Reading (dBm)	Correction Factor (dB)	EIRP (dBm)	EIRP (mW)	Polarization (H/V)
X	18700	1860.0	-10.05	36.57	26.52	448.75	H
	18900	1880.0	-10.76	37.22	26.46	442.59	
	19100	1900.0	-10.81	37.18	26.37	433.51	
	18700	1860.0	-17.94	37.65	19.71	93.54	V
	18900	1880.0	-17.96	37.58	19.62	91.62	
	19100	1900.0	-17.93	37.48	19.55	90.16	
Channel Bandwidth: 20 MHz / 16QAM							
X	18700	1860.0	-11.17	36.57	25.40	346.74	H
	18900	1880.0	-11.90	37.22	25.32	340.41	
	19100	1900.0	-12.06	37.18	25.12	325.09	
	18700	1860.0	-19.08	37.65	18.57	71.94	V
	18900	1880.0	-19.14	37.58	18.44	69.82	
	19100	1900.0	-19.17	37.48	18.31	67.76	

Note: EIRP (dBm) = Reading (dBm) + Correction Factor (dB)

4.2 Radiated Emission Measurement

4.2.1 Limits of Radiated Emission Measurement

The power of any emission outside of the authorized operating frequency ranges must be attenuated below the transmitting power (P) by a factor of at least $43 + 10 \log(P)$ dB. The emission limit is equal to -13 dBm.

4.2.2 Test Procedure

- a. Substitution method is used for E.I.R.P measurement. In the semi-anechoic chamber, EUT placed on the 0.8 m (below or equal 1 GHz) and/or 1.5 m (above 1 GHz) height of Turn Table, rotated the table around 360 degrees to search the maximum radiation power and receiver antenna shall be rotated vertical and horizontal polarization and moved height from 1 m to 4 m to find the maximum polar radiated power. The "Read Value" is the spectrum reading the maximum power value.
- b. The substitution horn antenna is substituted for EUT at the same position and signals generator export the CW signal to the substitution antenna via a TX cable. Rotated the Turn Table and moved receiving antenna to find the maximum radiation power. Adjust output power level of S.G to get a Value of spectrum reading equal to "Read Value" of step a. Record the power level of S.G.
- c. EIRP = Output power level of S.G – TX cable loss + Antenna gain of substitution horn.
- d. E.R.P power can be calculated form E.I.R.P power by subtracting the gain of dipole, E.R.P power = E.I.R.P power - 2.15 dB.

NOTE: The resolution bandwidth and video bandwidth of test receiver/spectrum analyzer is 1 MHz/3 MHz.

4.2.3 Deviation from Test Standard

No deviation.

4.2.4 Test Setup

<Radiated Emission below or equal 1 GHz>

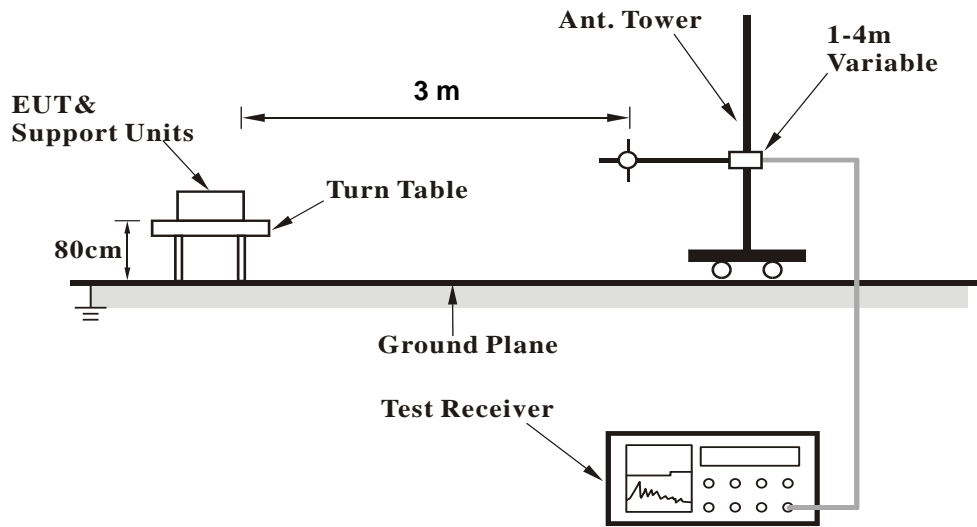

<Radiated Emission above 1 GHz>

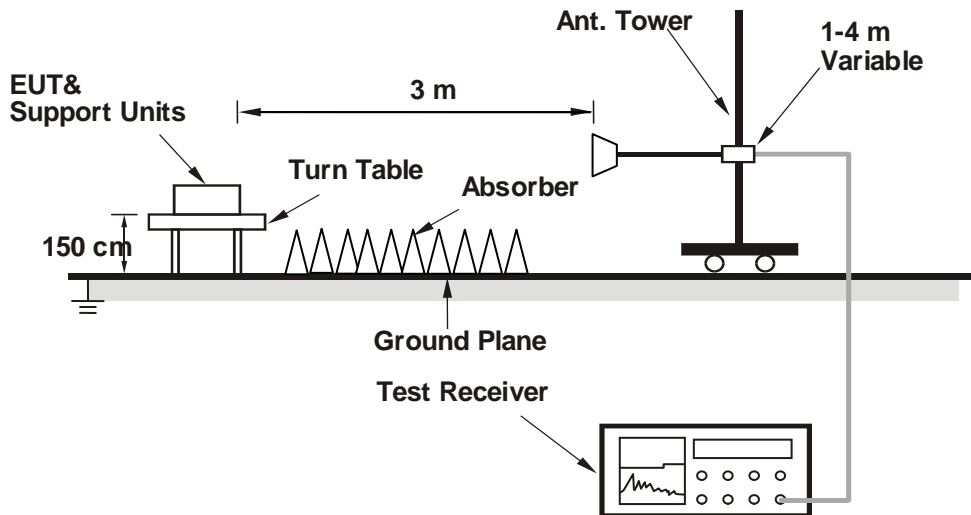

For the actual test configuration, please refer to the attached file (Test Setup Photo).

4.2.5 Test Results

LTE Band 2

Channel Bandwidth: 1.4 MHz / QPSK

Low Channel



Bureau Veritas Consumer Products Services Ltd., Taoyuan Branch

A D T

Data: 3

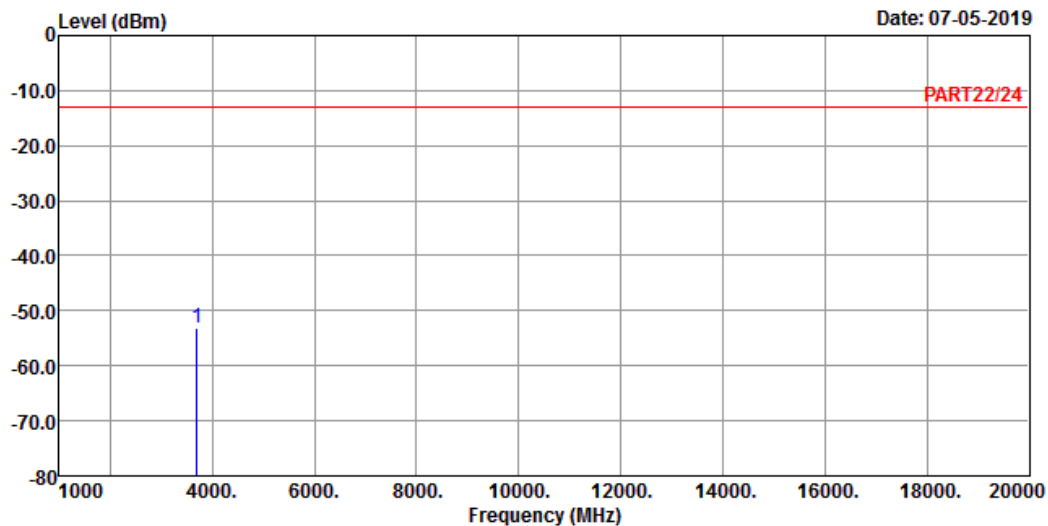

Site : 966 Chamber 5
 Condition: PART22/24 HORIZONTAL
 Remak : LTE Band 2 QPSK_1.4M Link_L-CH
 Tested by: Getaz Yang

Freq	Level	Read Level	Limit	Line Factor	Over Limit	Remark
MHz	dBm	dBm	dBm	dB	dB	
1 pp 3701.40	-53.25	-46.32	-13.00	-6.93	-40.25	Peak



Bureau Veritas Consumer Products Services Ltd., Taoyuan Branch

A D T

Data: 4

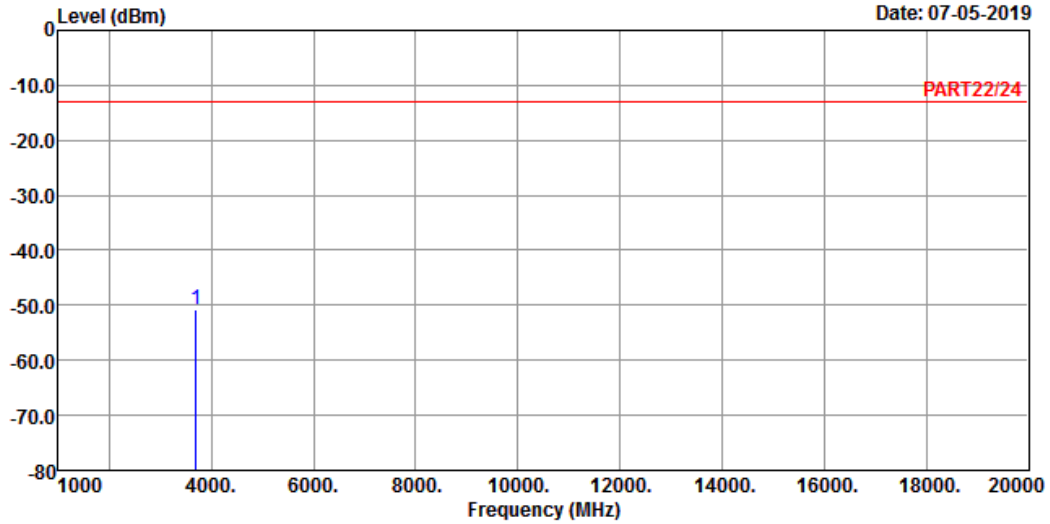

Site : 966 Chamber 5
 Condition: PART22/24 VERTICAL
 Remak : LTE Band 2 QPSK_1.4M Link_L-CH
 Tested by: Getaz Yang

Freq	Level	Read Level	Limit	Line Factor	Over Limit	Remark
MHz	dBm	dBm	dBm	dB	dB	
1 pp 3701.40	-50.65	-43.72	-13.00	-6.93	-37.65	Peak

Middle Channel



Bureau Veritas Consumer Products Services Ltd., Taoyuan Branch

A D T

Data: 3

Date: 07-05-2019

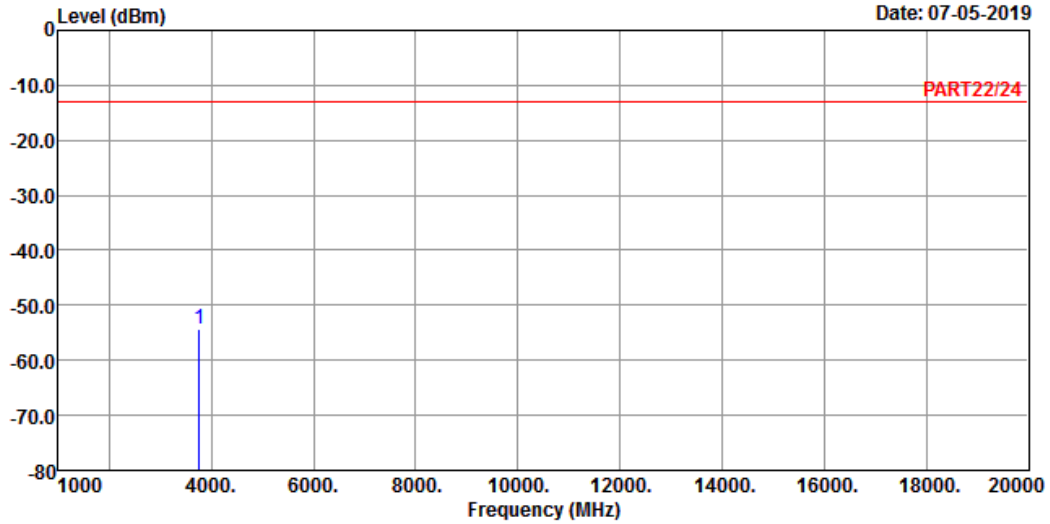

Site : 966 Chamber 5
 Condition: PART22/24 HORIZONTAL
 Remak : LTE Band 2 QPSK_1.4M Link_M-CH
 Tested by: Getaz Yang

Freq	Level	Read Level	Limit	Line Factor	Over Limit	Remark
MHz	dBm	dBm	dBm	dB	dB	

1 pp 3760.00 -54.19 -47.54 -13.00 -6.65 -41.19 Peak



Bureau Veritas Consumer Products Services Ltd., Taoyuan Branch

A D T

Data: 4

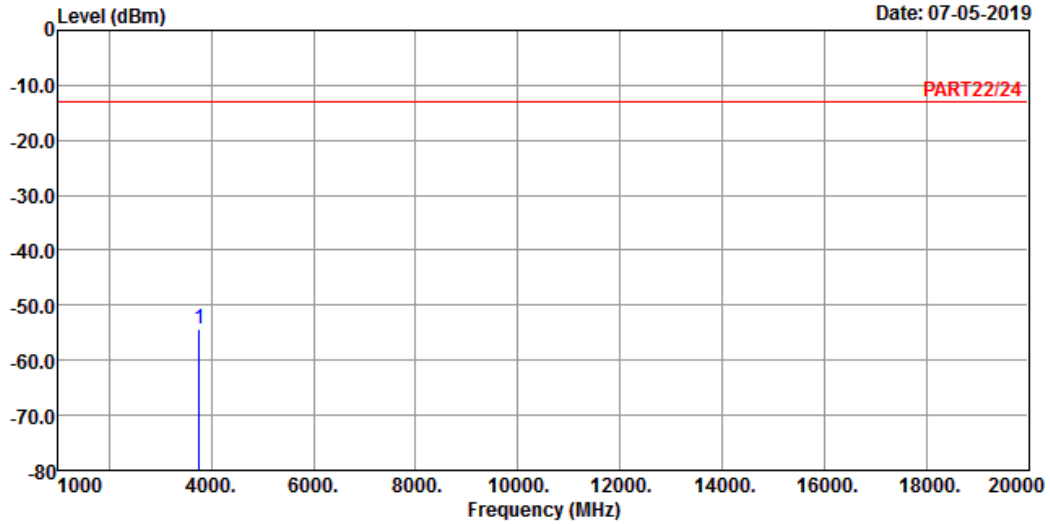

Site : 966 Chamber 5
 Condition: PART22/24 VERTICAL
 Remak : LTE Band 2 QPSK_1.4M Link_M-CH
 Tested by: Getaz Yang

Freq	Level	Read Level	Limit	Line Factor	Over Limit	Remark
MHz	dBm	dBm	dBm	dB	dB	
1 pp 3760.00	-54.17	-47.52	-13.00	-6.65	-41.17	Peak

High Channel



Bureau Veritas Consumer Products Services Ltd., Taoyuan Branch

A D T

Data: 3

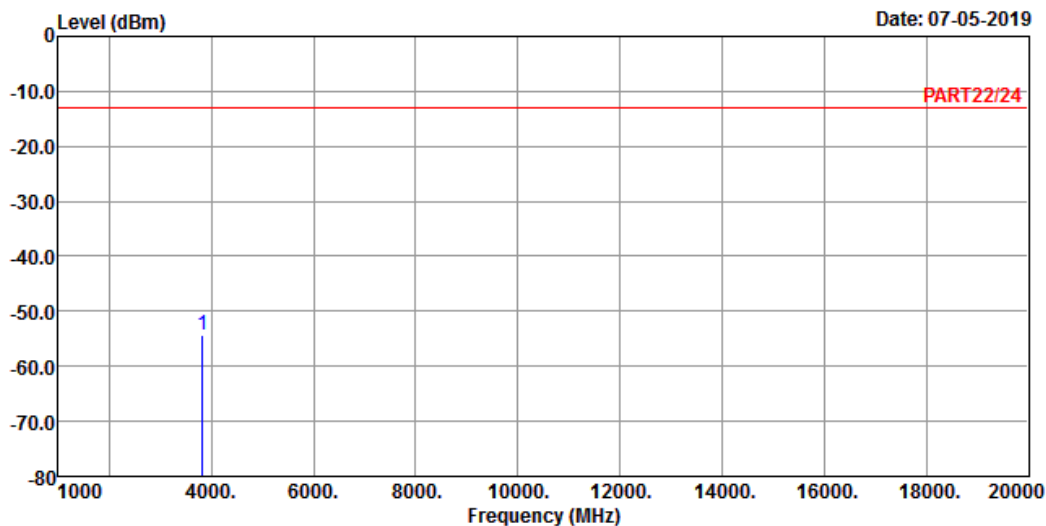

Site : 966 Chamber 5
 Condition: PART22/24 HORIZONTAL
 Remak : LTE Band 2 QPSK_1.4M Link_H-CH
 Tested by: Getaz Yang

Freq	Level	Read Level	Limit	Line Factor	Over Limit	Remark
MHz	dBm	dBm	dBm	dB	dB	

1 pp 3818.60 -54.40 -48.00 -13.00 -6.40 -41.40 Peak



Bureau Veritas Consumer Products Services Ltd., Taoyuan Branch

A D T

Data: 4

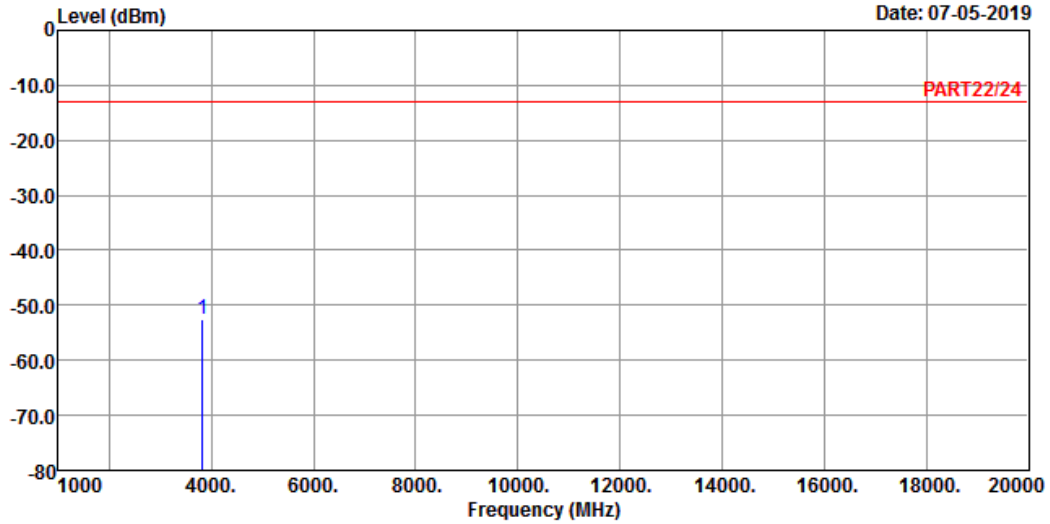

Site : 966 Chamber 5
 Condition: PART22/24 VERTICAL
 Remak : LTE Band 2 QPSK_1.4M Link_H-CH
 Tested by: Getaz Yang

Freq	Level	Read Level	Limit	Line Factor	Over Limit	Remark
MHz	dBm	dBm	dBm	dB	dB	
1 pp 3818.60	-52.57	-46.17	-13.00	-6.40	-39.57	Peak

Channel Bandwidth: 10 MHz / QPSK
Low Channel



Bureau Veritas Consumer Products Services Ltd., Taoyuan Branch

A D T

Data: 3

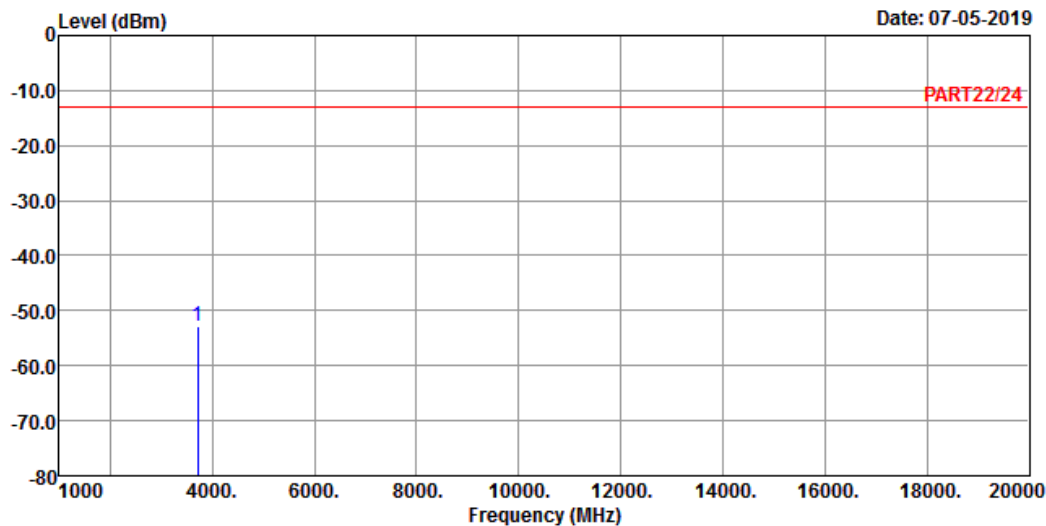

Site : 966 Chamber 5
Condition: PART22/24 HORIZONTAL
Remak : LTE Band 2 QPSK_10M Link_L-CH
Tested by: Getaz Yang

Freq	Level	Read Level	Limit	Line Factor	Over Limit	Remark
MHz	dBm	dBm	dBm	dB	dB	
1 pp 3710.00	-52.90	-46.03	-13.00	-6.87	-39.90	Peak



Bureau Veritas Consumer Products Services Ltd., Taoyuan Branch

A D T

Data: 4

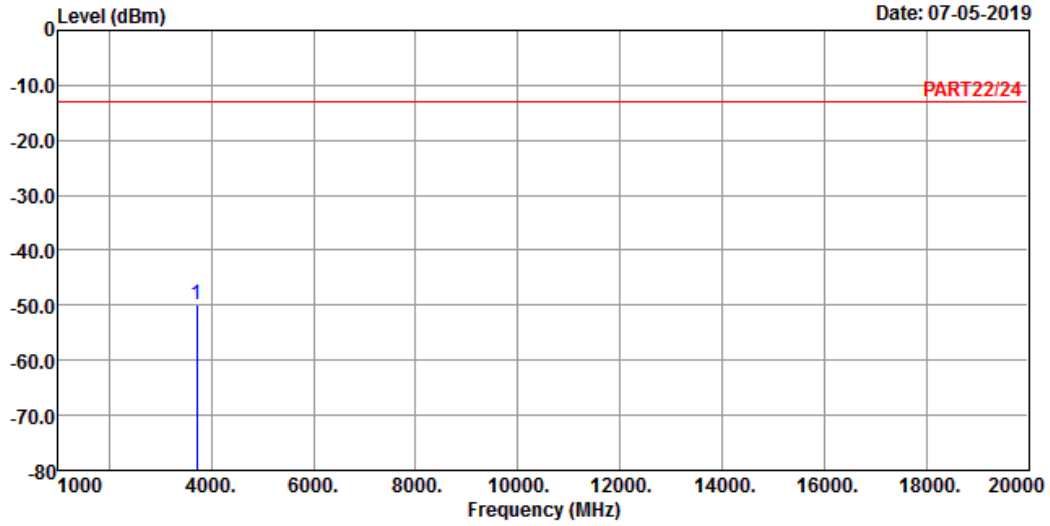

Site : 966 Chamber 5
 Condition: PART22/24 VERTICAL
 Remak : LTE Band 2 QPSK_10M Link_L-CH
 Tested by: Getaz Yang

Freq	Level	Read Level	Limit	Line Factor	Over Limit	Remark
MHz	dBm	dBm	dBm	dB	dB	
1 pp 3710.00	-49.85	-42.98	-13.00	-6.87	-36.85	Peak

Middle Channel



Bureau Veritas Consumer Products Services Ltd., Taoyuan Branch

A D T

Data: 3

Date: 07-05-2019

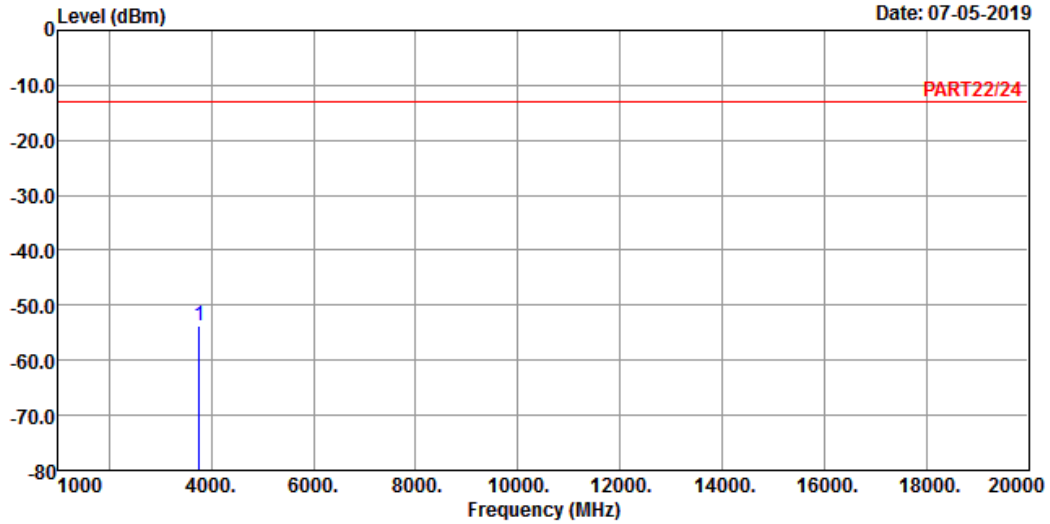

Site : 966 Chamber 5
 Condition: PART22/24 HORIZONTAL
 Remak : LTE Band 2 QPSK_10M Link_M-CH
 Tested by: Getaz Yang

Freq	Level	Read Level	Limit	Line Factor	Over Limit	Remark
MHz	dBm	dBm	dBm	dB	dB	
1 pp 3760.00	-53.85	-47.20	-13.00	-6.65	-40.85	Peak



Bureau Veritas Consumer Products Services Ltd., Taoyuan Branch

A D T

Data: 4

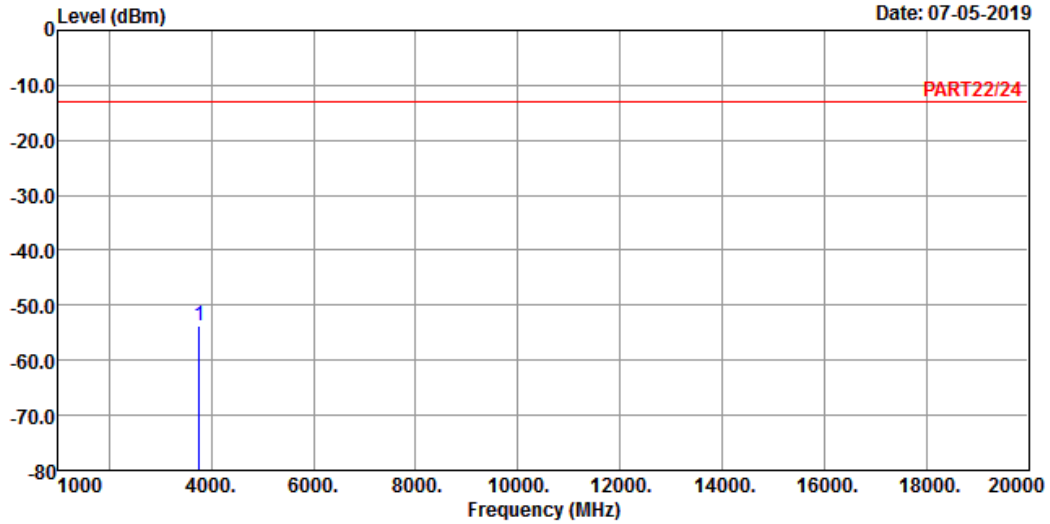

Site : 966 Chamber 5
 Condition: PART22/24 VERTICAL
 Remak : LTE Band 2 QPSK_10M Link_M-CH
 Tested by: Getaz Yang

Freq	Level	Read Level	Limit	Line Factor	Over Limit	Remark
MHz	dBm	dBm	dBm	dB	dB	
1 pp 3760.00	-53.83	-47.18	-13.00	-6.65	-40.83	Peak

High Channel



Bureau Veritas Consumer Products Services Ltd., Taoyuan Branch

A D T

Data: 3

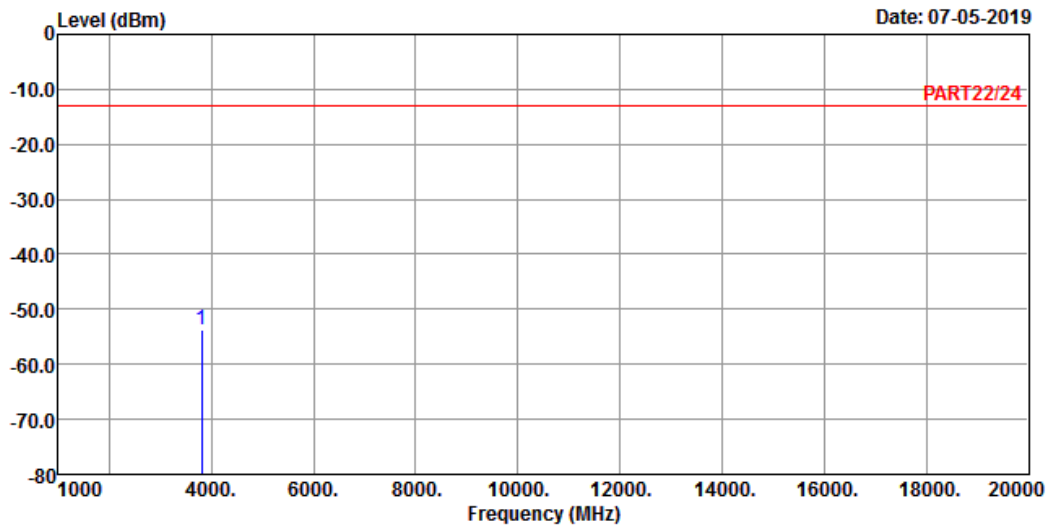

Site : 966 Chamber 5
 Condition: PART22/24 HORIZONTAL
 Remak : LTE Band 2 QPSK_10M Link_H-CH
 Tested by: Getaz Yang

Freq	Level	Read Level	Limit	Line Factor	Over Limit	Remark
MHz	dBm	dBm	dBm	dB	dB	
1 pp 3810.00	-53.81	-47.41	-13.00	-6.40	-40.81	Peak



Bureau Veritas Consumer Products Services Ltd., Taoyuan Branch

A D T

Data: 4

Date: 07-05-2019

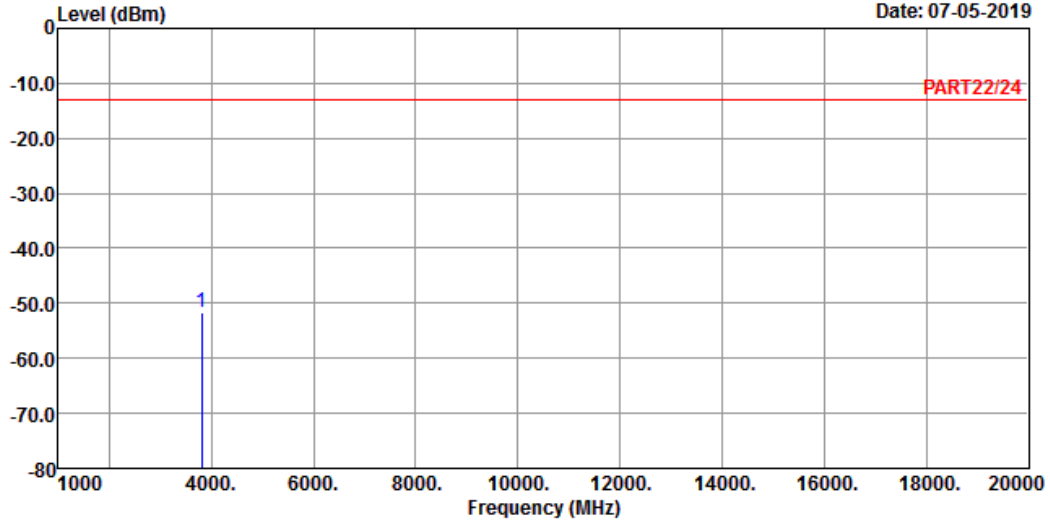

Site : 966 Chamber 5
 Condition: PART22/24 VERTICAL
 Remak : LTE Band 2 QPSK_10M Link_H-CH
 Tested by: Getaz Yang

Freq	Level	Read Level	Limit	Line Factor	Over Limit	Remark
MHz	dBm	dBm	dBm	dB	dB	
1 pp 3810.00	-51.71	-45.31	-13.00	-6.40	-38.71	Peak

Channel Bandwidth: 20 MHz / QPSK
Low Channel



Bureau Veritas Consumer Products Services Ltd., Taoyuan Branch

A D T

Data: 5

Date: 07-05-2019

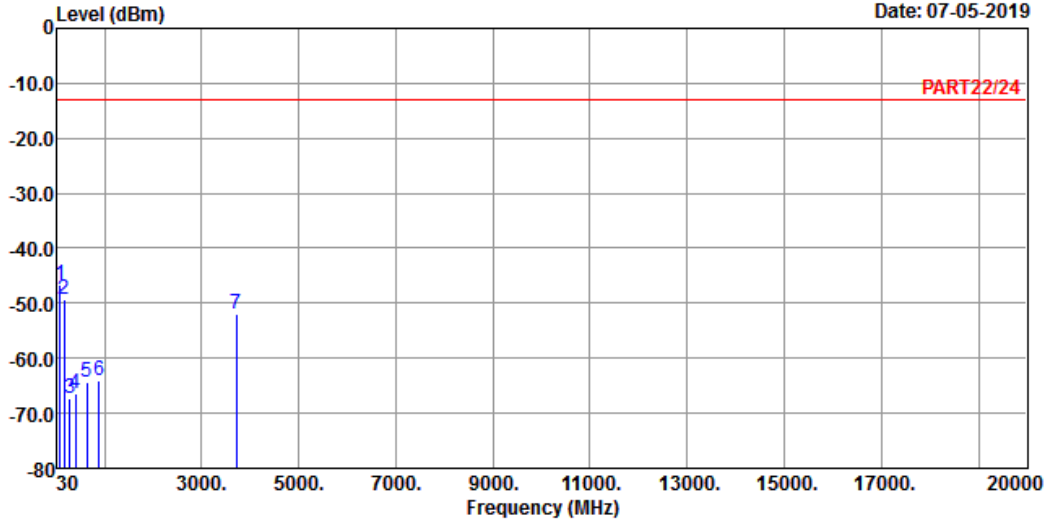

Site : 966 Chamber 5
Condition: PART22/24 HORIZONTAL
Remak : LTE Band 2 QPSK_20M Link_L-CH
Tested by: Getaz Yang

	Freq	Level	Read Level	Limit	Line Factor	Over Limit	Remark
	MHz	dBm	dBm	dBm	dB	dB	
1 pp	93.05	-46.61	-35.66	-13.00	-10.95	-33.61	Peak
2	160.95	-49.32	-44.41	-13.00	-4.91	-36.32	Peak
3	288.02	-67.43	-60.66	-13.00	-6.77	-54.43	Peak
4	399.57	-66.38	-60.43	-13.00	-5.95	-53.38	Peak
5	629.46	-64.24	-63.41	-13.00	-0.83	-51.24	Peak
6	896.21	-64.07	-64.62	-13.00	0.55	-51.07	Peak
7	3720.00	-52.01	-45.19	-13.00	-6.82	-39.01	Peak



Bureau Veritas Consumer Products Services Ltd., Taoyuan Branch

A D T

Data: 6

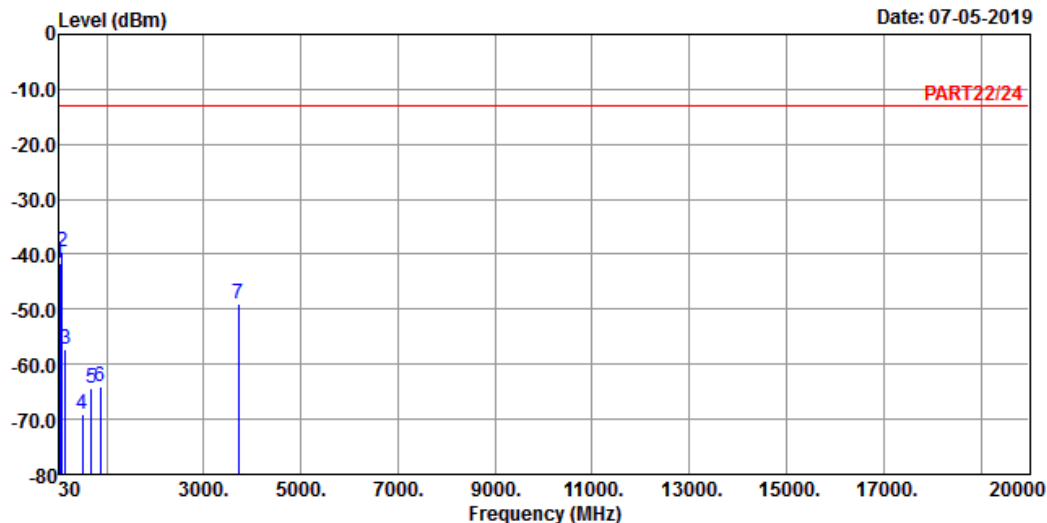

Site : 966 Chamber 5
 Condition: PART22/24 VERTICAL
 Remak : LTE Band 2 QPSK_20M Link_L-CH
 Tested by: Getaz Yang

	Freq	Level	Read Level	Limit Line	Factor	Over Limit	Remark
	MHz	dBm	dBm	dBm	dB	dB	
1	40.67	-41.76	-41.88	-13.00	0.12	-28.76	Peak
2 pp	88.20	-39.67	-28.61	-13.00	-11.06	-26.67	Peak
3	151.25	-57.30	-50.00	-13.00	-7.30	-44.30	Peak
4	509.18	-68.97	-64.67	-13.00	-4.30	-55.97	Peak
5	688.63	-64.31	-64.03	-13.00	-0.28	-51.31	Peak
6	876.81	-64.15	-64.59	-13.00	0.44	-51.15	Peak
7	3720.00	-49.11	-42.29	-13.00	-6.82	-36.11	Peak

Middle Channel



Bureau Veritas Consumer Products Services Ltd., Taoyuan Branch

A D T

Data: 3

Date: 07-05-2019

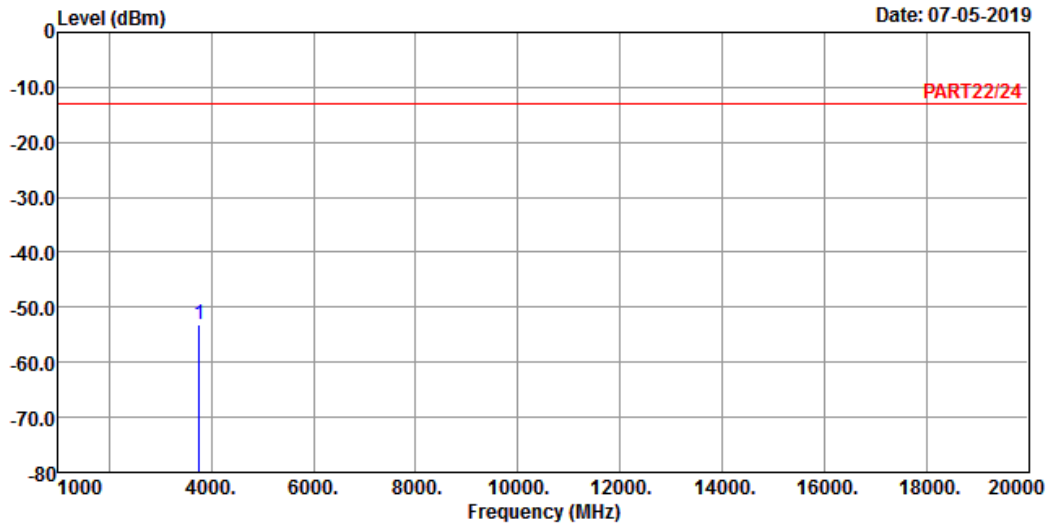

Site : 966 Chamber 5
 Condition: PART22/24 HORIZONTAL
 Remak : LTE Band 2 QPSK_20M Link_M-CH
 Tested by: Getaz Yang

Freq	Level	Read Level	Limit	Line Factor	Over Limit	Remark
MHz	dBm	dBm	dBm	dB	dB	

1 pp 3760.00 -53.14 -46.49 -13.00 -6.65 -40.14 Peak



Bureau Veritas Consumer Products Services Ltd., Taoyuan Branch

A D T

Data: 4

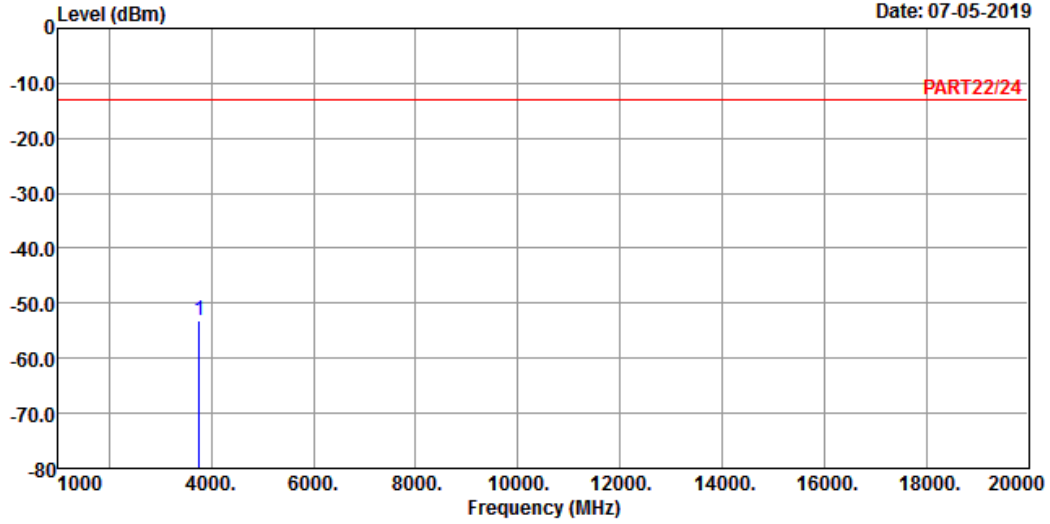

Site : 966 Chamber 5
 Condition: PART22/24 VERTICAL
 Remak : LTE Band 2 QPSK_20M Link_M-CH
 Tested by: Getaz Yang

Freq	Level	Read Level	Limit	Line Factor	Over Limit	Remark
MHz	dBm	dBm	dBm	dB	dB	
1 pp 3760.00	-53.04	-46.39	-13.00	-6.65	-40.04	Peak

High Channel



Bureau Veritas Consumer Products Services Ltd., Taoyuan Branch

A D T

Data: 3

Date: 07-05-2019

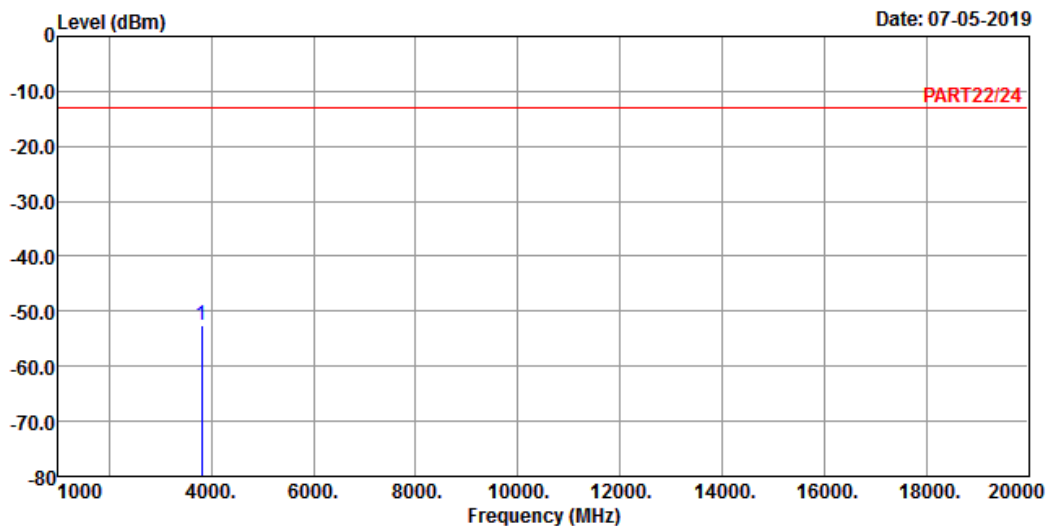

Site : 966 Chamber 5
 Condition: PART22/24 HORIZONTAL
 Remak : LTE Band 2 QPSK_20M Link_H-CH
 Tested by: Getaz Yang

Freq	Level	Read Level	Limit	Line Factor	Over Limit	Remark
MHz	dBm	dBm	dBm	dB	dB	
1 pp 3800.00	-52.53	-46.10	-13.00	-6.43	-39.53	Peak



Bureau Veritas Consumer Products Services Ltd., Taoyuan Branch

A D T

Data: 4

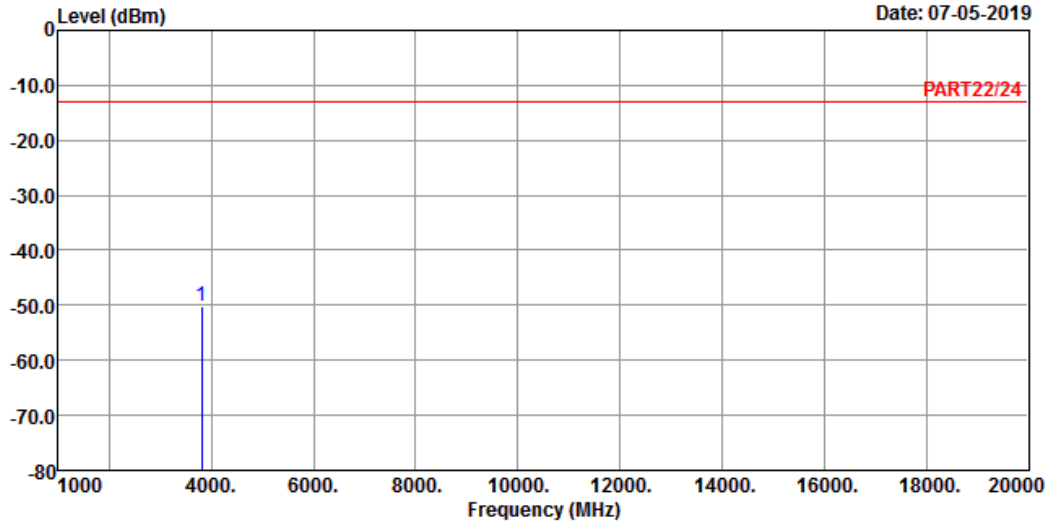

Site : 966 Chamber 5
 Condition: PART22/24 VERTICAL
 Remak : LTE Band 2 QPSK_20M Link_H-CH
 Tested by: Getaz Yang

Freq	Level	Read Level	Limit	Line Factor	Over Limit	Remark
MHz	dBm	dBm	dBm	dB	dB	
1 pp 3800.00	-50.12	-43.69	-13.00	-6.43	-37.12	Peak

5 Pictures of Test Arrangements

Please refer to the attached file (Test Setup Photo).

Appendix – Information of the Testing Laboratories

We, Bureau Veritas Consumer Products Services (H.K.) Ltd., Taoyuan Branch, were founded in 1988 to provide our best service in EMC, Radio, Telecom and Safety consultation. Our laboratories are FCC recognized accredited test firms and accredited according to ISO/IEC 17025.

If you have any comments, please feel free to contact us at the following:

Lin Kou EMC/RF Lab

Tel: 886-2-26052180

Fax: 886-2-26051924

Hsin Chu EMC/RF/Telecom Lab

Tel: 886-3-6668565

Fax: 886-3-6668323

Hwa Ya EMC/RF/Safety Lab

Tel: 886-3-3183232

Fax: 886-3-3270892

Email: service.adt@tw.bureauveritas.com

Web Site: www.bureauveritas-adt.com

The address and road map of all our labs can be found in our web site also.

--- END ---