

# **User Guide**

**5G CPE**

## **Federal Communication Commission Interference Statement**

This device complies with Part 15 of the FCC Rules. Operation is subject to the following two conditions: (1) This device may not cause harmful interference, and (2) this device must accept any interference received, including interference that may cause undesired operation.

This equipment has been tested and found to comply with the limits for a Class B digital device, pursuant to Part 15 of the FCC Rules. These limits are designed to provide reasonable protection against harmful interference in a residential installation. This equipment generates, uses and can radiate radio frequency energy and, if not installed and used in accordance with the instructions, may cause harmful interference to radio communications. However, there is no guarantee that interference will not occur in a particular installation. If this equipment does cause harmful interference to radio or television reception, which can be determined by turning the equipment off and on, the user is encouraged to try to correct the interference by one of the following measures:

- Reorient or relocate the receiving antenna.
- Increase the separation between the equipment and receiver.
- Connect the equipment into an outlet on a circuit different from that to which the receiver is connected.
- Consult the dealer or an experienced radio/TV technician for help.

FCC Caution: Any changes or modifications not expressly approved by the party responsible for compliance could void the user's authority to operate this equipment.

This transmitter must not be co-located or operating in conjunction with any other antenna or transmitter.

This device meets all the other requirements specified in Part 15E, Section 15.407 of the FCC Rules.

## **Radiation Exposure Statement**

This equipment complies with FCC radiation exposure limits set forth for an uncontrolled environment. This equipment should be installed and operated with minimum distance 20cm between the radiator & your body.

## **Safety Warnings**

### **Adapter**

Do not use any other power adapter except the one that accompanies this unit or a power adapter identified in the list below.

Use of another adapter could result in damage to the unit.

The following power adapter is qualified for use with this Verizon 5G Home Router:

This unit must be powered by Delta, model ADP-48GR BA or equivalent UL listed power source rated @ output 12Vdc, Maximum 4.0A.

### **Battery**

Do not use any other battery. There is a risk of explosion if the battery is replaced by an incorrect type. Please follow the warnings on the battery label.

The following battery is qualified for use with this Verizon 5G CPE:

Shenzhen Rishengzhi Electronics Technology Co., Ltd, model LV21 (3.6Vdc, 3450mAh, 12.42Wh)

### **Cradle**

1. Cradle(battery pack) should be stored at cool and dry area with temperature between -20 ~ 30 degree C
2. Cradle(battery pack) should not be used with any other product except Verizon 5G CPE device
3. Recommend to charge the battery every six month

# Table of Contents

FEDERAL COMMUNICATION COMMISSION INTERFERENCE STATEMENT .....	I
RADIATION EXPOSURE STATEMENT .....	I
SAFETY WARNINGS .....	II
<b>CHAPTER 1 INTRODUCTION .....</b>	<b>1</b>
1.1 PACKAGE CONTENTS .....	1
1.2 SYSTEM REQUIREMENTS .....	1
1.3 FEATURES .....	1
1.4 GETTING TO KNOW THE CPE .....	1
<b>CHAPTER 2 CONNECTING THE CPE – TYPE #1 .....</b>	<b>6</b>
2.1 CONFIGURATION #1 5G CPE INSTALLATION OVERVIEW .....	6
2.2 OPEN BOX – FULL SET CPE .....	6
2.3 SITE SURVEY .....	6
2.4 INSTALL 5G CPE AT THE WINDOW .....	7
2.5 CONNECT TO FCL HOME ROUTER .....	7
<b>CHAPTER 3 CONNECTING THE CPE – TYPE 2 .....</b>	<b>8</b>
3.1 CONFIGURATION #2 5G CPE INSTALLATION OVERVIEW .....	8
3.2 TO ASSEMBLE LVSKODJ WITH LVPK .....	8
3.3 TO DECIDE GOOD LOCATION FOR INSTALLATION .....	8
3.4 INSTALL BRACKET AND DEVICE .....	8
3.5 TO CONNECT TO FCL ROUTER .....	9
<b>APPENDIX: SPECIFICATIONS .....</b>	<b>10</b>

# Chapter 1

## Introduction

This chapter includes a list of items included with the CPE, the minimum system requirements for using the Verizon 5G CPE, and an overview of the CPE's features.

---

### 1.1 Package Contents

The product package of LVSK should contain the following items:

- 5G CPE LVSK Assembly (LVSKODU + LVSKIDU + LVSKCRA) x 1 set
  - LVSKODU is an outdoor unit
  - LVSKIDU is an indoor unit
  - LVSKCRA is the cradle to support LVSKODU and LVSKIDU before formal operation.
- Window bracket with window wipe x 2 set
- Power Adapter & AC Power cord x 1 set
- Cable clip x 2,
- window wedge with Velcro strip x 2

The product package of LVPK should contain the following items:

- LVPK & Outer Housing & Heatsink x 1 set
- PSE & AC power cord x 1 set
- SPU x 1 pcs

### 1.2 System Requirements

The Verizon 5G CPE requires the following systems and software:

- Computers or smart devices with Wi-Fi or Ethernet capability
- TCP/IP network protocol installed on each computer

### 1.3 Features

- One hour battery life for 5G installation
- Support 5G N260/N261
- Support 4G B2/B4/B5/B13/B66
- Support 4G/5G CA
- Remote Device Management/FOTA/OMADM
- Administration website
- Support WiFi 11ax
- 60W PSE PoE injector

### 1.4 Getting to Know the CPE

LVSKIDU

Below contains a description of LED on the LVSKIDU's front panel, and the LED and buttons on its side panel.

- 1: Power button** (discreetly placed on side)
  - Power ON
  - Reboot / Power cycle
- 2: Pair button with LED** (discreetly placed on side) *Side LED*
  - Pair - WiFi and Bluetooth
  - LED shows pairing connectivity status
  - LED glows with **Blue** and **Red** colors
- 3: 5G Connection LED** (clearly visible from front) *Front LED*
  - **Green** glow to show passing signal.
  - **Amber** glow to show poor signal.
  - **Red** glow to show no signal or error.
  - **White** glow to show regular functions.
- 4: Audible tone buzzer**
  - **Success** sound to show 5G connectivity and pairing
  - **Error** sound to indicate fault in system or device
  - **Click** sound for button press feedback
  - *The tone sounds, frequencies and durations can be found in the separate sample code sheet.*

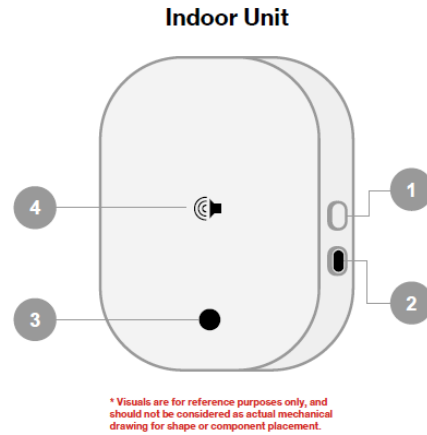

Below describe the connectors on LVSKIDU



### Power Jack

The Power Jack connects the LVSKIDU to an electrical outlet via the power cord.







### Ethernet Ports



















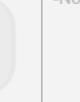



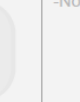

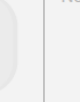



The Ethernet Port enable you to connect devices to the FCL Router via Ethernet cable with class better than CAT5e.

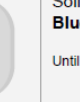



### USB type C port

This USB port connect LVSKIDU to LVSKODU to provide communication.

## CPE LED and Buzzer functions

Status	Front LED	Side LED (On Sync/Pair button)	Sound
<b>1 Power ON</b> <b>INSTALLATION MODE</b> Single press power button.	Solid <b>White</b>  Until Activation mode begins, then it starts to soft blink.	Solid <b>Red</b>  Until pairing mode is triggered or status change.	<b>Click</b> sound plays once on turning on. 
<b>2 Reboot (Power cycle)</b> <b>INSTALLATION MODE</b> Long press power button.	Fast Blink <b>White</b>  Blinks for 1~2 seconds before turning off.	-Not Applicable-	<b>Click</b> sound plays once on button press. 
<b>3 Pairing mode (default - automatic)</b> <b>INSTALLATION MODE</b> Starts automatically on power ON, and stops after 8~10 seconds if not paired to via WPS or Bluetooth.	-Not Applicable-	Hard Blink Alternating <b>Blue &amp; Red</b>  <b>Temporarily removed from requirements</b> Until paired or pairing mode turns off.	-Not Applicable-

<p><b>3 Bluetooth Pairing mode (manual option)</b> <b>INSTALLATION MODE</b></p> <p>Long press Pair button to connect via bluetooth.</p>	<p>-Not Applicable-</p>	<p>Hard Blink Alternating Blue &amp; Red <b>Temporarily removed from requirements</b></p>   <p>Until paired or pairing mode turns off.</p>	<p><b>Click sound</b></p> <p>plays once on button press.</p> 
<p><b>4 Paired to Phone</b> <b>INSTALLATION MODE</b></p> <p>Phone has successfully connected to Receiver via bluetooth.</p>	<p>-Not Applicable-</p>	<p>Hard Blink Blue <b>Temporarily removed from requirements</b></p>   <p>Until status change, phone disconnects automatically after installation is complete.</p>	<p><b>Click sound</b></p> <p>plays once immediately after establishing bluetooth connection.</p> 
<p><b>5 Activating Receiver</b> <b>INSTALLATION MODE</b></p> <p>Receiver starts searching for LTE signal after power ON.</p>	<p>Fast Blink White <b>Temporarily removed from requirements</b></p>   <p>Until Receiver is activated. <b>Until installation mode is done</b></p>	<p>-Not Applicable-</p>	<p>-Not Applicable-</p>
<p>Status</p>	<p>Front LED</p>	<p>Side LED (On Sync/Pair button)</p>	<p>Sound</p>
<p><b>6 Activation complete</b> <b>INSTALLATION MODE</b></p> <p>Receiver is successfully connected to LTE and is activated, to start searching for 5G signal.</p>	<p>Solid White <b>Temporarily removed from requirements</b></p>   <p>Stays White for 30 seconds until 5G signal search starts.</p>	<p>-Not Applicable-</p>	<p><b>Click sound</b></p> <p>plays once immediately after activation.</p> 
<p><b>7 No 5G signal</b> <b>INSTALLATION MODE</b></p> <p>Receiver does not detect 5G signal immediately after activation.</p>	<p>Solid Red <b>Temporarily removed from requirements</b></p>   <p>Until Receiver detects poor or passing signal.</p>	<p>-Not Applicable-</p>	<p>-Not Applicable-</p>
<p><b>8 Poor 5G signal</b> <b>INSTALLATION MODE</b></p> <p>5G signal is detected after activation but is inadequate.</p>	<p>Solid Amber <b>Temporarily removed from requirements</b></p>   <p>Until Receiver detects passing or no signal.</p>	<p>-Not Applicable-</p>	<p>-Not Applicable-</p>
<p><b>9 Passing 5G signal</b> <b>INSTALLATION MODE</b></p> <p>Detected 5G signal is good for installation.</p>	<p>Solid Green <b>Temporarily removed from requirements</b></p>   <p>Until Receiver detects good signal.</p>	<p>-Not Applicable-</p>	<p><b>Success sound</b></p> <p>Plays once immediately after finding passing signal.</p> 
<p><b>10 Router Pairing mode (Manual)</b> <b>REGULAR USAGE MODE</b></p> <p>Single press Pair button to start pairing to router via WPS.</p>	<p>-Not Applicable-</p>	<p>Hard Blink Alternating Blue &amp; Red</p>   <p>Until paired or pairing mode turns off.</p>	<p><b>Click sound</b></p> <p>Plays once on button press.</p> 
<p><b>11 Paired to Router</b> <b>REGULAR USAGE MODE</b></p> <p>Receiver is successfully paired to Router.</p>	<p>Solid White</p>   <p>Stays white for 30 seconds, then turns off until status change.</p>	<p>Solid Blue</p>   <p>Until status change.</p>	<p><b>Success sound</b></p> <p>Plays once immediately after connecting.</p> 
<p><b>12 Error (Fault)</b> <b>REGULAR USAGE MODE</b></p> <p>Hardware or Software issue Examples:</p> <ul style="list-style-type: none"> <li>• ODU is broken.</li> <li>• Firmware has fault.</li> <li>• Lose 4G connectivity.</li> </ul>	<p>Hard Blink Red</p>   <p>Until Power cycle or change of status.</p>	<p>-Not Applicable-</p>	<p><b>Error sound</b></p> <p>Plays once immediately after incident.</p> 
<p><b>13 Firmware update</b> <b>REGULAR USAGE MODE</b></p> <p>Receiver software is updating.</p>	<p>Fast Blink White</p>   <p>Until software is fully installed, or change of status.</p>	<p>-Not Applicable-</p>	<p>-Not Applicable-</p>







<p><b>14 Disconnected to Router</b> <b>REGULAR USAGE MODE</b></p> <ul style="list-style-type: none"> <li>Receiver fails pairing to Router after pressing pair button.</li> <li>Receiver loses connection to Router.</li> </ul>	<p>-Not Applicable-</p>	<p><b>Solid Red</b></p> <p>Until status change.</p> 	<p><b>Error sound</b></p> <p>Plays once immediately after incident.</p> 
<p><b>15 Working as advertised</b> <b>REGULAR USAGE MODE</b></p> <p>Receiver has passing 5G signal and is connected to the Router. When installation is complete there will be no LED indication for 5G signal strength.</p>	<p>OFF</p> <p>Until status change.</p> 	<p><b>Solid Blue</b></p> <p>Until status change.</p> 	<p>-Not Applicable-</p>

## Battery Cradle

Below contains a description of LED and button on the bottom of cradle.

### 1: Battery life indicator LED

(discreetly placed somewhere on side or bottom of device)

1	Cradle battery fully <b>discharged</b>	off	
2	Cradle <b>connected to power supply</b> , not fully charged	Red	
3	Cradle <b>connected to power supply</b> , fully charged	Green	
4	Cradle <b>not connected to power supply</b> , CPE powered OFF with cradle attached	off	
5	Cradle <b>not connected to power supply</b> , CPE powered ON with cradle attached, battery condition is good	Green	
6	Cradle <b>not connected to power supply</b> , CPE powered ON with cradle attached, battery close to discharge or battery discharged	off	

### CPE Cradle / Stand

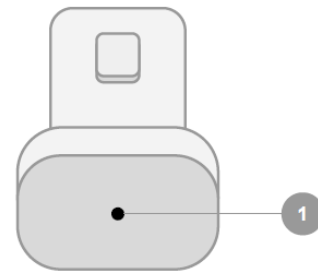







\* Visuals are for reference purposes only, and should not be considered as actual mechanical drawing for shape or component placement.

## LVPK

Below contains a short description of LED on the bottom of LVPK

### 1: Status indicator LED

(discreetly placed on bottom corner)

1	Power ON	<b>Installation mode starts</b>	Blue	
2	4G Activation in progress	Starts Immediately after power ON Keeps blinking until 4G is activated	Hard blink Blue	
3	No 5G signal	No 5G connection at all	Red	
4	Poor 5G signal	Below passing signal threshold	Amber	
5	Passing 5G signal	Above passing signal threshold (Good for installation)	Green	
6	Working as advertised	<b>Regular usage mode starts</b> after consistent Passing signal is achieved and installation is successful	off	
7	Fault / Error	Lose 4G connectivity Hardware / Firmware has fault	Red	

### Outdoor Unit

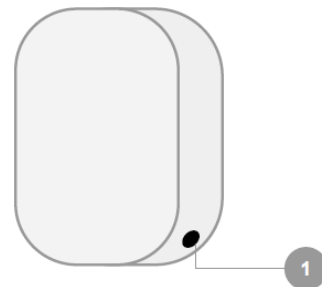

\* Visuals are for reference purposes only, and should not be considered as actual mechanical drawing for shape or component placement.

Below describe the location of connectors on LVPK

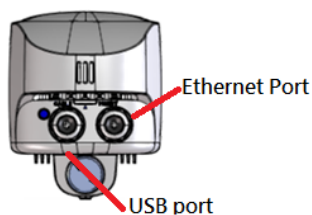



### PoE Port

The PoE Port enable you to connect LVPK device to the FCL Router via shielded Ethernet cable with PoE power injector and surge protection boxes in series.

### USB type C port

This USB port connect LVPK to LVSKODU to provide communication in between.

Below describe the USB cable on LVSKODU

### USB cable

This USB cable attached to LVSKODU to provide communication with LVSKIDU or LVPK when cable plug in.

# Chapter 2

## Connecting the CPE – Type #1

This section describes how to install 5G CPE as Type #1 configuration.

---

### 2.1 Configuration #1 5G CPE Installation Overview

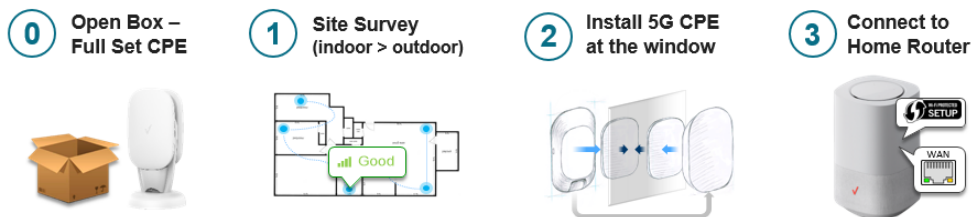

### 2.2 Open Box – Full Set CPE

1. User open box and see both units with the cradle as a whole set
2. USB cable is plugged in and collected at central retention bar
3. DC cable is plugged in and routing from the bottom
4. There is a label on IDU with message “Indoor Receiver Face this inside (towards you). Please be sure to follow up the instruction when installation.
5. Press the battery button under cradle to enable battery power.
6. Please check the LED on the bottom of cradle.
7. Please plug the power adapter to charge battery till green LED on.
8. Go to next step if Green LED is on.



### 2.3 Site Survey

1. To power up CPE to enter the installation mode by default
2. Connect your phone & the CPE via Bluetooth
3. Please be sure to follow up the instruction to have IDU toward you and ODU face to outside. Then hold the Cradle, walk around and look for signal
4. Single press pair button to connect to installation AP via BL
5. Follow below procedures to survey 5G signal, and then go to section 2.4.



6. Please go to section 3 if no good 5G signal can be achieved.

## 2.4 Install 5G CPE at the window

1. Unload CPE From The Cradle



2. Install on the Window

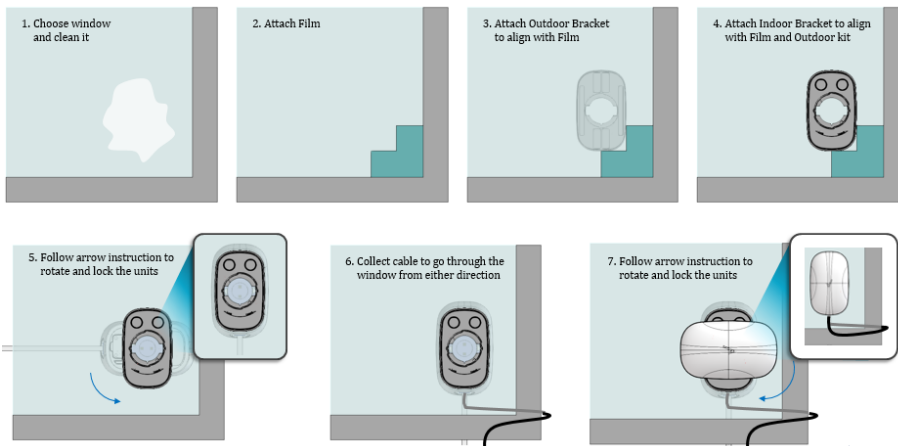

## 2.5 Connect to FCL Home Router

1. Connect by WPS of Wi-Fi

**LVSKIDU:** Short Press Mode/WPS button, IDU will start WPS as an AP.

**FCL Router:** Long press WPS button, FCL will start WPS as a client.

IDU and FCL Router will connect by the backhaul SSID

2. Connect by Ethernet cable

**Connect Ethernet cable between IDU and FCL WAN port**

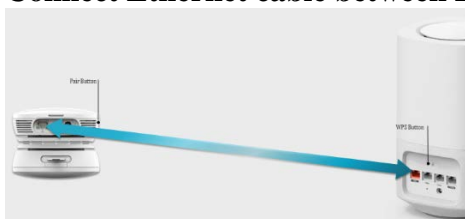

# Chapter 3

## Connecting the CPE – Type 2

This section describes how to install 5G CPE as Type #2 configuration, when Type #1 configuration can't provide good communication quality. Please be noticed that this installation need to be done by well trained technicians.

---

### 3.1 Configuration #2 5G CPE Installation Overview

1. To assemble LVSKODU with LVPK
2. To decide good location with good signal quality for device installation
3. To install bracket and device
4. To connect to FCL router

### 3.2 To Assemble LVSKODJ with LVPK

1. To assemble heatsink with ODU.
2. To plug ODU to bottom housing.
3. To put top housing on and fix the housing by screw
4. USB cable from ODU through cable gland, then plug into USB port of LVPK, fasten cable gland.

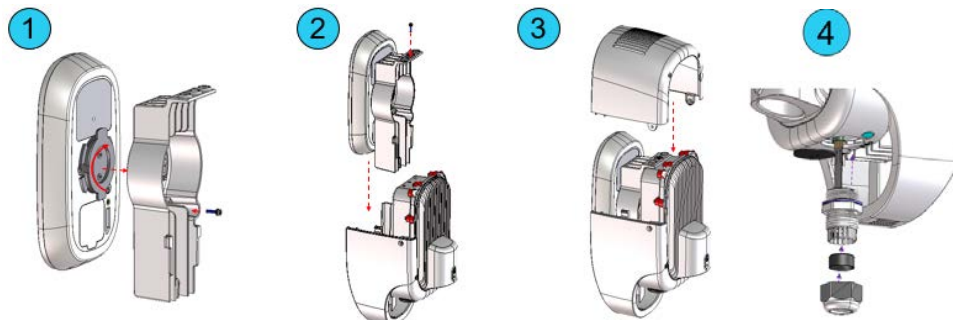

### 3.3 To decide good location for installation

To select the location for device installation that as close to 5G base station as possible. It will be better that the location for device installation can see the 5G base station directly without any obstacle (light of sight).

### 3.4 Install bracket and device

1. To fix bracket on wall.
2. To adjust the angle of bracket
3. To put the device on bracket.
4. To plug Ethernet cable to PoE port of LVPK and assemble the cable grand.
5. To route Ethernet cable
6. To connect grounding wire.

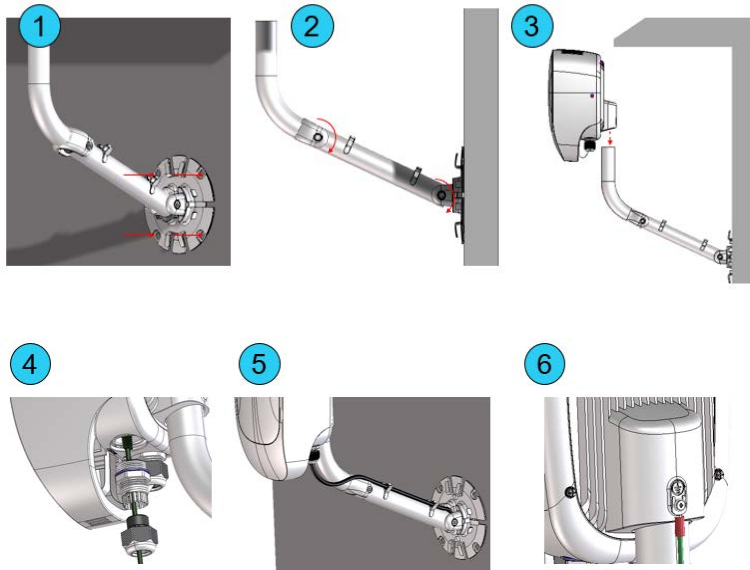

### 3.5 To connect to FCL router

1. To connect Ethernet cable between PSE (Ethernet input port) and FCL (Ethernet WAN port).
2. To connect shielded Ethernet cable between SPU and PSE (PoE power injector) Ethernet output port. PSE power cord need to plug in.
3. To mount SPU (surge protection device) on wall and do grounding.
4. To connect 5G CPE and SPU by shielded Ethernet cable (Cat5e or better).

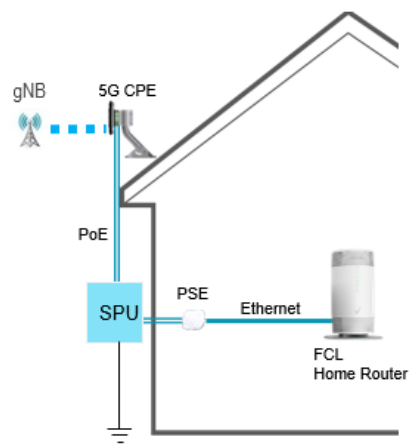

# Appendix: Specifications

---

## Product specifications

Cradle

Battery  
3.6V 3450mAh

LVSKIDU

Wi-Fi  
5G 802.11 ax MIMO 4 × 4  
WPS, WPA, WPA2, WPA3

Ethernet  
CAT6 2.5Gbps

Memory  
DDR3: 512MB  
NAND: 256MB

Embedded Antenna  
5G WiFi x 4

LVSKODU

5G  
5G MIMO 2 × 2  
Support N260, N261

LTE  
LTE CAT16, Band 2/4/5/13/66  
Supports downlink inter and intra 2-Carrier Aggregation

Memory  
RAM- LPDDR4: 6GB  
Flash- UFS: 64GB

Embedded Antenna  
5G mmW NR module x 3 (1x4 antenna array in each module)  
LTE x 4  
BLE x 1

LVPK

PoE  
802.3bt 60W 2.5Gbps

Memory  
DDR3: 512MB  
NAND: 256MB

## **Mechanical Specifications**

### Cradle

LED x 1  
DC jack x 1  
Battery button x 1  
Cable with DC plug x 1

### LVSKIDU

LED for 5G signal quality indication × 1 (Tri LED)  
LED for router status indication × 1 (Dual LED)  
Buzzer x 1  
2.5G Ethernet RJ-45 port with LED × 1  
USB type C connector x 1  
Reset button × 1  
WPS button × 1  
DC Jack × 1

### LVSKODU

USB cable x 1  
SIM x 1

### LVPK

LED for 5G signal status indication × 1 (Tri LED)  
RJ-45 port with LED × 1  
FPC Type C connector x 1

## **Environmental**

Power  
LVSKIDU: 12V/4A  
LVPK & PSE: 56V/1.1A

Operating Ambient Temperature  
LVSKIDU 5°C to 40°C  
LVSKODU & LVPK -30°C to 55°C

Operation Relative Humidity  
5% to 90% non-condensing

Storage Temperature

–45°C to 70°C

Shipping and Storage Relative Humidity

5% to 85%