

FCC Test Report (Part 96: LTE Band 48)

Report No.: RF200605C31

FCC ID: NKR-LVSK-IHP

Test Model: LVSKIHP

Received Date: Jun. 05, 2020

Test Date: Jun. 19 ~ Jul. 06, 2020

Issued Date: Jul. 06, 2020

Applicant: Wistron NeWeb Corporation

Address: 20 Park Avenue II, Hsinchu Science Park, Hsinchu 308, Taiwan

Issued By: Bureau Veritas Consumer Products Services (H.K.) Ltd., Taoyuan Branch
Lin Kou Laboratories

Lab Address: No. 47-2, 14th Ling, Chia Pau Vil., Lin Kou Dist., New Taipei City, Taiwan

Test Location: No. 19, Hwa Ya 2nd Rd., Wen Hwa Vil., Kwei Shan Dist., Taoyuan City
33383, TAIWAN

**FCC Registration/
Designation Number:** 788550 / TW0003



This report is for your exclusive use. Any copying or replication of this report to or for any other person or entity, or use of our name or trademark, is permitted only with our prior written permission. This report sets forth our findings solely with respect to the test samples identified herein. The results set forth in this report are not indicative or representative of the quality or characteristics of the lot from which a test sample was taken or any similar or identical product unless specifically and expressly noted. Our report includes all of the tests requested by you and the results thereof based upon the information that you provided to us. You have 60 days from date of issuance of this report to notify us of any material error or omission caused by our negligence, provided, however, that such notice shall be in writing and shall specifically address the issue you wish to raise. A failure to raise such issue within the prescribed time shall constitute your unqualified acceptance of the completeness of this report, the tests conducted and the correctness of the report contents. Unless specific mention, the uncertainty of measurement has been explicitly taken into account to declare the compliance or non-compliance to the specification. This report should not be used by the client to claim any endorsement by TAF.

Table of Contents

Release Control Record	4
1 Certificate of Conformity	5
2 Summary of Test Results	6
2.1 Measurement Uncertainty	6
2.2 Modification Record	6
3 General Information	7
3.1 General Description of EUT	7
3.2 Test Mode Applicability and Tested Channel Detail	8
3.3 Description of Support Units	10
3.3.1 Configuration of System under Test	10
3.4 General Description of Applied Standards and References.....	11
4 Test Types and Results	12
4.1 Maximum Output Power Measurement	12
4.1.1 Limits of Maximum Output Power Measurement	12
4.1.2 Test Setup.....	12
4.1.3 Test Instruments	12
4.1.4 Test Procedures.....	13
4.1.5 Deviation from Test Standard	13
4.1.6 EUT Operating Conditions.....	13
4.1.7 Test Results	14
4.2 Modulation Characteristics Measurement.....	22
4.2.1 Limits of Modulation Characteristics.....	22
4.2.2 Test Procedure	22
4.2.3 Test Setup.....	22
4.2.4 Test Results	23
4.3 Frequency Stability Measurement.....	24
4.3.1 Limits of Frequency Stability Measurement.....	24
4.3.2 Test Instruments	24
4.3.3 Test Procedure	24
4.3.4 Test Setup.....	24
4.3.5 Test Results	25
4.4 Emission Bandwidth Measurement.....	29
4.4.1 Emission Bandwidth Measurement.....	29
4.4.2 Test Setup.....	29
4.4.3 Test Instruments	29
4.4.4 Test Procedure	29
4.4.5 Deviation from Test Standard	29
4.4.6 EUT Operating Conditions.....	29
4.4.7 Test Result (-26dB Bandwidth).....	30
4.4.8 Test Result (Occupied Bandwidth)	32
4.5 Peak to Average Ratio Measurement	34
4.5.1 Limits of Peak to Average Ratio Measurement	34
4.5.2 Test Setup.....	34
4.5.3 Test Procedures.....	34
4.5.4 Test Results	35
4.6 Conducted Spurious Emissions	37
4.6.1 Limits of Conducted Spurious Emissions Measurement.....	37
4.6.2 Test Setup.....	37
4.6.3 Test Procedure	37
4.6.4 Test Results	38
4.7 Radiated Emission Measurement	62
4.7.1 Limits of Radiated Emission Measurement.....	62

4.7.2 Test Instruments	62
4.7.3 Test Procedures.....	63
4.7.4 Deviation from Test Standard	63
4.7.5 Test Set Up	64
4.7.6 Test Results	65
5 Pictures of Test Arrangements.....	71
Appendix – Information of the Testing Laboratories	72

Release Control Record

Issue No.	Description	Date Issued
RF200605C31	Original release.	Jul. 06, 2020

1 Certificate of Conformity

Product: LV55
Brand: WNC
Test Model: LVSKIHP
Sample Status: Engineering sample
Applicant: Wistron NeWeb Corporation
Test Date: Jun. 19 ~ Jul. 06, 2020
Standards: 47 CFR FCC Part 96

The above equipment has been tested by **Bureau Veritas Consumer Products Services (H.K.) Ltd., Taoyuan Branch**, and found compliance with the requirement of the above standards. The test record, data evaluation & Equipment Under Test (EUT) configurations represented herein are true and accurate accounts of the measurements of the sample's RF characteristics under the conditions specified in this report.

Prepared by : Polly Chien , **Date:** Jul. 06, 2020
Polly Chien / Specialist

Approved by : Bruce Chen , **Date:** Jul. 06, 2020
Bruce Chen / Senior Project Engineer

2 Summary of Test Results

47 CFR FCC Part 96			
FCC Clause	Test Item	Result	Remarks
2.1046 96.41(b)	Maximum Peak Output Power	Pass	Meet the requirement of limit.
2.1046 96.41(b)	Maximum Power Spectral Density	Pass	Meet the requirement of limit.
96.41(g)	Peak to Average Ration	Pass	Meet the requirement of limit.
2.1049	Emission Bandwidth	Pass	Meet the requirement of limit.
2.1055	Frequency Stability	Pass	Meet the requirement of limit.
2.1051 96.41(e)	Conducted Spurious Emissions	Pass	Meet the requirement of limit.
2.1053 96.41(e)	Radiated Spurious Emissions	Pass	Meet the requirement of limit. Minimum passing margin is -3.3dB at 7380.00MHz.

Note: Determining compliance based on the results of the compliance measurement, not taking into account measurement instrumentation uncertainty.

2.1 Measurement Uncertainty

Where relevant, the following measurement uncertainty levels have been estimated for tests performed on the EUT as specified in CISPR 16-4-2:

Measurement	Frequency	Expanded Uncertainty (k=2) (\pm)
Radiated Emissions up to 1 GHz	9 kHz ~ 30MHz	3.04 dB
	30 MHz ~ 200 MHz	3.59 dB
	200 MHz ~ 1000 MHz	3.60 dB
Radiated Emissions above 1 GHz	1 GHz ~ 18 GHz	2.29 dB
	18 GHz ~ 40 GHz	2.29 dB

2.2 Modification Record

There were no modifications required for compliance.

3 General Information

3.1 General Description of EUT

Product	LV55				
Brand	WNC				
Test Model	LVSKIHP				
Status of EUT	Engineering sample				
Operating Voltage	20Vdc (form adapter)				
Modulation Type	QPSK, 16QAM, 64QAM				
Operating Frequency	LTE Band 48	Channel Bandwidth 5MHz	TX: 3552.5 ~ 3697.5 MHz RX: 3552.5 ~ 3697.5 MHz		
		Channel Bandwidth 10MHz	TX: 3555 ~ 3695 MHz RX: 3555 ~ 3695 MHz		
		Channel Bandwidth 15MHz	TX: 3557.5 ~ 3692.5 MHz RX: 3557.5 ~ 3692.5 MHz		
		Channel Bandwidth 20MHz	TX: 3560 ~ 3690 MHz RX: 3560 ~ 3690 MHz		
Max. EIRP Power	LTE Band 48		QPSK	16QAM	64QAM
		Channel Bandwidth 5MHz	195.434mW (22.91dBm)	165.196mW (22.18dBm)	123.027mW (20.90dBm)
		Channel Bandwidth 10MHz	198.609mW (22.98dBm)	159.221mW (22.02dBm)	121.339mW (20.84dBm)
		Channel Bandwidth 15MHz	195.434mW (22.91dBm)	166.341mW (22.21dBm)	124.165mW (20.94dBm)
		Channel Bandwidth 20MHz	196.789mW (22.94dBm)	162.555mW (22.11dBm)	125.603mW (20.99dBm)
Emission Designator	LTE Band 48	Channel Bandwidth 5MHz	4M47G7D	4M46D7W	4M46D7W
		Channel Bandwidth 10MHz	8M92G7D	8M92D7W	8M92D7W
		Channel Bandwidth 15MHz	13M4G7D	13M4D7W	13M4D7W
		Channel Bandwidth 20MHz	17M8G7D	17M8D7W	17M8D7W
Antenna Type	Monopole antenna with 4.19dBi gain				
Antenna Connector	i-pex(MHF)				
Accessory Device	Adapter				
Data Cable Supplied	NA				

Note:

1. The EUT provides 1 completed transmitter and 4 receivers.
2. The EUT used following adapter.

Adapter	
Brand	Delta
Model	ADP-120VH D
Input Power	100-240Vac, 50-60Hz, 2.5A
Output Power	20Vdc, 6A
Power Cord	Cable Out: Non-shielded, 3.0m Power Cord: Non-shielded, 2m

3. The above Antenna information is declared by manufacturer and for more detailed features description, please refer to the manufacturer's specifications, the laboratory shall not be held responsible.

3.2 Test Mode Applicability and Tested Channel Detail

Pre-Scan has been conducted to determine the worst-case mode from all possible combinations between available modulations, data rates, XYZ axis and antenna ports

The worst case was found when positioned on X-plane. Following channel(s) was (were) selected for the final test as listed below:

Test Item	Available Channel	Tested Channel	Channel Bandwidth	Modulation
Maximum Output Power	55265 to 56715	55265 (3552.5MHz), 55990 (3625.0MHz), 56715 (3697.5MHz)	5MHz	QPSK, 16QAM, 64QAM
	55290 to 56690	55290 (3555.0MHz), 55990 (3625.0MHz), 56690 (3695.0MHz)	10MHz	QPSK, 16QAM, 64QAM
	55315 to 56665	55315 (3557.5MHz), 55990 (3625.0MHz), 56665 (3692.5MHz)	15MHz	QPSK, 16QAM, 64QAM
	55340 to 56640	55340 (3560.0MHz), 55990 (3625.0MHz), 56640 (3690.0MHz)	20MHz	QPSK, 16QAM, 64QAM
Modulation Characteristics	55340 to 56640	55990 (3625.0MHz)	20MHz	QPSK, 16QAM, 64QAM
Frequency Stability	55265 to 56715	55265 (3552.5MHz), 56715 (3697.5MHz)	5MHz	QPSK
	55290 to 56690	55290 (3555.0MHz), 56690 (3695.0MHz)	10MHz	QPSK
	55315 to 56665	55315 (3557.5MHz), 56665 (3692.5MHz)	15MHz	QPSK
	55340 to 56640	55340 (3560.0MHz), 56640 (3690.0MHz)	20MHz	QPSK
Occupied Bandwidth	55265 to 56715	55265 (3552.5MHz), 55990 (3625.0MHz), 56715 (3697.5MHz)	5MHz	QPSK, 16QAM, 64QAM
	55290 to 56690	55290 (3555.0MHz), 55990 (3625.0MHz), 56690 (3695.0MHz)	10MHz	QPSK, 16QAM, 64QAM
	55315 to 56665	55315 (3557.5MHz), 55990 (3625.0MHz), 56665 (3692.5MHz)	15MHz	QPSK, 16QAM, 64QAM
	55340 to 56640	55340 (3560.0MHz), 55990 (3625.0MHz), 56640 (3690.0MHz)	20MHz	QPSK, 16QAM, 64QAM
Peak to Average Ratio	55265 to 56715	55265 (3552.5MHz), 55990 (3625.0MHz), 56715 (3697.5MHz)	5MHz	QPSK, 16QAM, 64QAM
	55290 to 56690	55290 (3555.0MHz), 55990 (3625.0MHz), 56690 (3695.0MHz)	10MHz	QPSK, 16QAM, 64QAM
	55315 to 56665	55315 (3557.5MHz), 55990 (3625.0MHz), 56665 (3692.5MHz)	15MHz	QPSK, 16QAM, 64QAM
	55340 to 56640	55340 (3560.0MHz), 55990 (3625.0MHz), 56640 (3690.0MHz)	20MHz	QPSK, 16QAM, 64QAM

Test Item	Available Channel	Tested Channel	Channel Bandwidth	Modulation
Conducted Emission	55265 to 56715	55265 (3552.5MHz), 55990 (3625.0MHz), 56715 (3697.5MHz)	5MHz	QPSK
	55290 to 56690	55290 (3555.0MHz), 55990 (3625.0MHz), 56690 (3695.0MHz)	10MHz	QPSK
	55315 to 56665	55315 (3557.5MHz), 55990 (3625.0MHz), 56665 (3692.5MHz)	15MHz	QPSK
	55340 to 56640	55340 (3560.0MHz), 55990 (3625.0MHz), 56640 (3690.0MHz)	20MHz	QPSK
Radiated Emission Below 1GHz	55340 to 56640	56640 (3690.0MHz)	20MHz	QPSK
Radiated Emission Above 1GHz	55265 to 56715	55265 (3552.5MHz), 55990 (3625.0MHz), 56715 (3697.5MHz)	5MHz	QPSK
	55340 to 56640	55340 (3560.0MHz), 55990 (3625.0MHz), 56640 (3690.0MHz)	20MHz	QPSK

Note:

1. This device was tested under all bandwidths, RB configurations and modulations. The worst case was found in QPSK modulation. Therefore, only EIRP, modulation characteristics, occupied bandwidth and peak to average ratio items had been tested under QPSK, 16QAM and 64QAM mode, the other items were performed under QPSK mode only.
2. For radiated emission above 1GHz, according to 3GPP 36.521 Section 6.6.3.1.4, choose the lowest, 5MHz & highest channel bandwidth for final test. For radiated emissions below 1 GHz, select the worst radiated emission channel for final testing.

Test Condition:

Test Item	Environmental Conditions	Input Power	Tested By
Maximum Output Power	22deg. C, 66%RH	120Vac, 60Hz	Han Wu
Modulation Characteristics	25deg. C, 63%RH	120Vac, 60Hz	James Yang
Frequency Stability	25deg. C, 63%RH	120Vac, 60Hz	James Yang
Occupied Bandwidth	25deg. C, 63%RH	120Vac, 60Hz	James Yang
Peak to Average Ratio	25deg. C, 63%RH	120Vac, 60Hz	James Yang
Condcudeted Emission	25deg. C, 63%RH	120Vac, 60Hz	James Yang
Radiated Emission	22deg. C, 66%RH	120Vac, 60Hz	Han Wu

3.3 Description of Support Units

The EUT has been tested as an independent unit together with other necessary accessories or support units. The following support units or accessories were used to form a representative test configuration during the tests.

ID	Product	Brand	Model No.	Serial No.	FCC ID	Remarks
A.	Radio Communication Analyzer	Anritsu	MT8821C	6261806803	N/A	-

Note:

1. All power cords of the above support units are non-shielded (1.8m).
2. Items A acted as communication partners to transfer data.

3.3.1 Configuration of System under Test

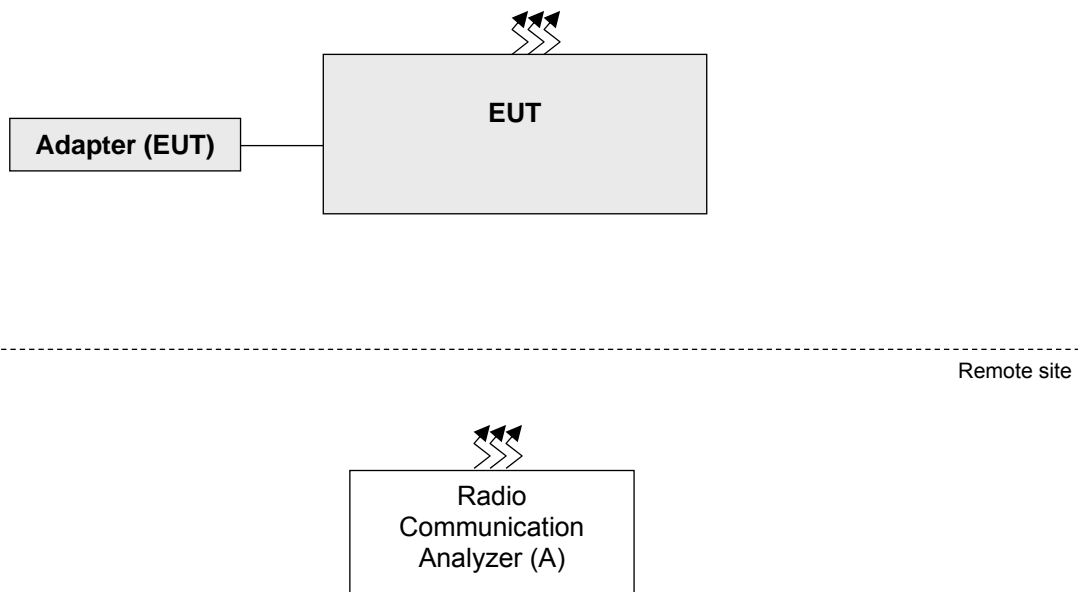

3.4 General Description of Applied Standards and References

The EUT is a RF Product. According to the specifications of the manufacturer, it must comply with the requirements of the following standards:

Test standard:

FCC 47 CFR Part 2

FCC 47 CFR Part 96

All test items have been performed and recorded as per the above standards.

References Test Guidance:

KDB 971168 D01 Power Meas License Digital Systems v03r01

KDB 940660 D01 Part 96 CBRS Eqpt v02

ANSI/TIA/EIA-603-D-2010

All test items have been performed as a reference to the above KDB test guidance.

4 Test Types and Results

4.1 Maximum Output Power Measurement

4.1.1 Limits of Maximum Output Power Measurement

Device		Maximum EIRP (dBm/10 MHz)
<input checked="" type="checkbox"/>	End User Device	23
<input type="checkbox"/>	Category A CBSD	30
<input type="checkbox"/>	Category B CBSD	47

4.1.2 Test Setup

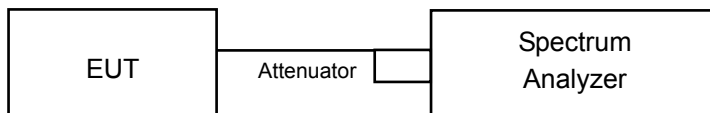

4.1.3 Test Instruments

Description & Manufacturer	Model No.	Serial No.	Cal. Date	Cal. Due
Spectrum Analyzer KEYSIGHT	N9030A	MY53120770	Feb. 07, 2020	Feb. 06, 2021
Radio Communication Analyzer Anritsu	MT8821C	6261806803	Jan. 08, 2020	Jan. 07, 2021
RF cable	JB200	Cable-OVEN-02	NA	NA
DC-6GHz 20dB 50W Fixed attenuator Woken	MDC9331N-20	0724	Jun. 19, 2018	Jun. 18, 2020
			Jun. 24, 2020	Jun. 23, 2022

Note: 1. The calibration interval of the above test instruments is 12/24 months and the calibrations are traceable to NML/ROC and NIST/USA.

4.1.4 Test Procedures

Conducted output power measurement

1. Connect the DUT transmitter output to the spectrum analyzer via coaxial cable while ensuring proper impedance matching.
2. Set span to at least 1.5 times the OBW.
3. Set RBW = 1-5% of the OBW, not to exceed 1 MHz.
4. Set VBW $\geq 3 \times$ RBW.
5. Set number of points in sweep $\geq 2 \times$ span / RBW.
6. Sweep time = auto-couple.
7. Detector = RMS (power averaging).
8. If the EUT can be configured to transmit continuously (i.e., burst duty cycle $\geq 98\%$), then set the trigger to free run.
9. If the EUT cannot be configured to transmit continuously (i.e., burst duty cycle $< 98\%$), then use a sweep trigger with the level set to enable triggering only on full power bursts and configure the EUT to transmit at full power for the entire duration of each sweep. Ensure that the sweep time is less than or equal to the transmission burst duration.
10. Trace average at least 100 traces in power averaging (i.e., RMS) mode.
11. Compute the power by integrating the spectrum across the OBW of the signal using the instrument's band or channel power measurement function, with the band/channel limits set equal to the OBW band edges. If the instrument does not have a band or channel power function, then sum the spectrum levels (in linear power units) at intervals equal to the RBW extending across the entire OBW of the spectrum.

Maximum EIRP

The relevant equation for determining the maximum ERP or EIRP from the measured RF output power is given in Equation as follows:

$$\text{ERP or EIRP} = P_{\text{Meas}} + G_{\text{T}}$$

where

ERP or EIRP effective radiated power or equivalent isotropically radiated power, respectively
(expressed in the same units as P_{Meas} , e.g., dBm or dBW)

P_{Meas} measured transmitter output power or PSD, in dBm or dBW

G_{T} gain of the transmitting antenna, in dBd (ERP) or dBi (EIRP)

4.1.5 Deviation from Test Standard

No deviation.

4.1.6 EUT Operating Conditions

The software provided by client to enable the EUT under transmission condition continuously at lowest, middle and highest channel frequencies individually.

4.1.7 Test Results

Conducted Output Power (dBm / 10MHz)

Band / BW	RB Size	RB Offset	QPSK			16QAM			64QAM		
			Low CH	Mid CH	High CH	Low CH	Mid CH	High CH	Low CH	Mid CH	High CH
			55265	55990	56715	55265	55990	56715	55265	55990	56715
			3552.5	3625	3697.5	3552.5	3625	3697.5	3552.5	3625	3697.5
			MHz	MHz	MHz	MHz	MHz	MHz	MHz	MHz	MHz
48 / 5M	1	0	18.18	18.57	18.72	17.35	17.85	17.90	16.22	16.69	16.71
	1	12	18.29	18.66	18.51	17.32	17.84	17.99	16.18	16.51	16.63
	1	24	18.12	18.67	18.58	17.59	17.61	17.76	16.37	16.65	16.65
	12	0	17.32	17.75	17.80	16.50	16.81	17.15	15.35	15.78	15.97
	12	6	17.47	17.80	17.91	16.61	16.95	17.11	15.46	15.76	15.91
	12	13	17.45	17.68	18.00	16.54	17.10	17.10	15.55	15.69	15.99
	25	0	17.43	17.80	17.99	16.56	16.85	17.17	15.41	15.66	15.95

Band / BW	RB Size	RB Offset	QPSK			16QAM			64QAM		
			Low CH	Mid CH	High CH	Low CH	Mid CH	High CH	Low CH	Mid CH	High CH
			55290	55990	56690	55290	55990	56690	55290	55990	56690
			3555	3625	3695	3555	3625	3695	3555	3625	3695
			MHz	MHz	MHz	MHz	MHz	MHz	MHz	MHz	MHz
48 / 10M	1	0	18.21	18.56	18.56	17.33	17.61	17.72	16.23	16.60	16.55
	1	24	18.15	18.61	18.79	17.54	17.82	17.82	16.10	16.61	16.55
	1	49	18.37	18.53	18.57	17.43	17.60	17.83	16.37	16.65	16.61
	25	0	17.59	17.62	17.84	16.73	16.88	17.09	15.34	15.84	15.91
	25	12	17.36	17.61	17.87	16.57	16.95	17.14	15.48	15.80	15.94
	25	25	17.38	17.78	17.87	16.79	16.83	17.09	15.40	15.85	15.97
	50	0	17.54	17.87	17.83	16.73	16.85	17.17	15.35	15.71	15.94

Band / BW	RB Size	RB Offset	QPSK			16QAM			64QAM		
			Low CH	Mid CH	High CH	Low CH	Mid CH	High CH	Low CH	Mid CH	High CH
			55315	55990	56665	55315	55990	56665	55315	55990	56665
			3557.5	3625	3692.5	3557.5	3625	3692.5	3557.5	3625	3692.5
			MHz	MHz	MHz	MHz	MHz	MHz	MHz	MHz	MHz
48 / 15M	1	0	18.17	18.58	18.52	17.47	17.76	17.98	16.31	16.68	16.54
	1	37	18.39	18.43	18.61	17.31	17.76	17.97	16.31	16.43	16.64
	1	74	18.37	18.65	18.54	17.45	17.80	18.00	16.32	16.62	16.64
	36	0	17.57	17.89	18.00	16.75	17.04	17.11	15.60	15.74	15.83
	36	19	17.54	17.60	17.91	16.72	16.81	17.17	15.35	15.78	15.93
	36	39	17.38	17.79	18.00	16.61	16.93	17.01	15.52	15.60	15.98
	75	0	15.01	15.26	15.41	14.21	14.43	14.58	12.80	13.19	13.33

Band / BW	RB Size	RB Offset	QPSK			16QAM			64QAM		
			Low CH	Mid CH	High CH	Low CH	Mid CH	High CH	Low CH	Mid CH	High CH
			55340	55990	56640	55340	55990	56640	55340	55990	56640
			3560	3625	3690	3560	3625	3690	3560	3625	3690
			MHz	MHz	MHz	MHz	MHz	MHz	MHz	MHz	MHz
48 / 20M	1	0	18.29	18.40	18.66	17.51	17.71	17.89	16.14	16.62	16.56
	1	50	18.13	18.68	18.65	17.51	17.83	17.79	16.16	16.64	16.75
	1	99	18.23	18.47	18.54	17.42	17.87	17.78	16.37	16.42	16.65
	50	0	17.38	17.70	17.85	16.63	17.08	17.02	15.56	15.78	15.95
	50	25	17.46	17.72	17.99	16.73	17.07	17.18	15.37	15.87	15.81
	50	50	17.33	17.71	17.80	16.80	16.97	17.14	15.43	15.87	15.84
	100	0	14.38	14.78	14.92	13.62	13.95	14.16	12.45	12.79	15.81

Spectrum Plot of Worst Value

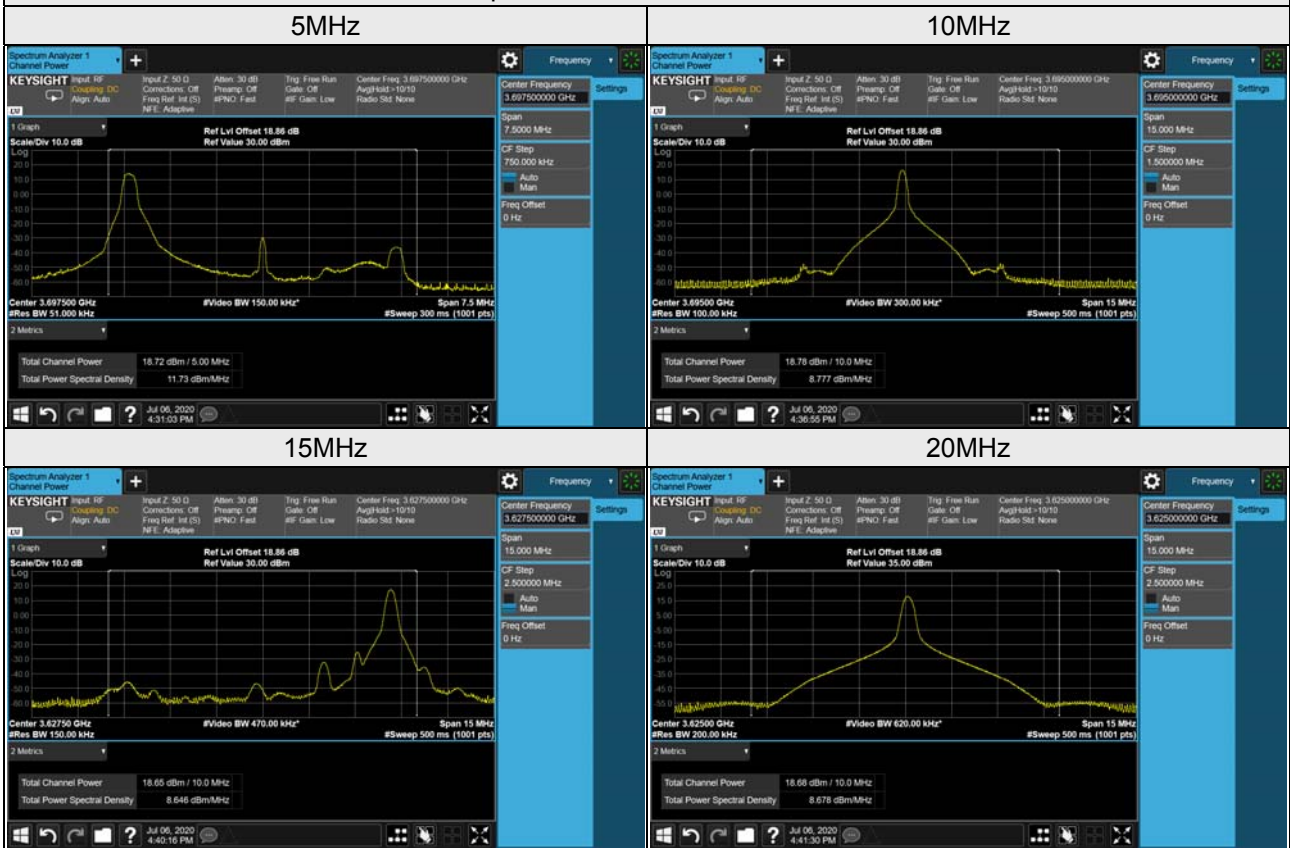

Maximum EIRP (dBm/ 10MHz)

Band / BW	RB Size	RB Offset	QPSK			16QAM			64QAM		
			Low CH	Mid CH	High CH	Low CH	Mid CH	High CH	Low CH	Mid CH	High CH
			55265	55990	56715	55265	55990	56715	55265	55990	56715
			3552.5	3625	3697.5	3552.5	3625	3697.5	3552.5	3625	3697.5
			MHz	MHz	MHz	MHz	MHz	MHz	MHz	MHz	MHz
48 / 5M	1	0	22.37	22.76	22.91	21.54	22.04	22.09	20.41	20.88	20.90
	1	12	22.48	22.85	22.70	21.51	22.03	22.18	20.37	20.70	20.82
	1	24	22.31	22.86	22.77	21.78	21.80	21.95	20.56	20.84	20.84
	12	0	21.51	21.94	21.99	20.69	21.00	21.34	19.54	19.97	20.16
	12	6	21.66	21.99	22.10	20.80	21.14	21.30	19.65	19.95	20.10
	12	13	21.64	21.87	22.19	20.73	21.29	21.29	19.74	19.88	20.18
	25	0	21.62	21.99	22.18	20.75	21.04	21.36	19.60	19.85	20.14

*Note: EIRP (dBm / 10MHz) = Conducted Output Power (dBm / 10MHz) + Antenna Gain (4.19dBi)

Band / BW	RB Size	RB Offset	QPSK			16QAM			64QAM		
			Low CH	Mid CH	High CH	Low CH	Mid CH	High CH	Low CH	Mid CH	High CH
			55290	55990	56690	55290	55990	56690	55290	55990	56690
			3555	3625	3695	3555	3625	3695	3555	3625	3695
			MHz	MHz	MHz	MHz	MHz	MHz	MHz	MHz	MHz
48 / 10M	1	0	22.40	22.75	22.75	21.52	21.80	21.91	20.42	20.79	20.74
	1	24	22.34	22.80	22.98	21.73	22.01	22.01	20.29	20.80	20.74
	1	49	22.56	22.72	22.76	21.62	21.79	22.02	20.56	20.84	20.80
	25	0	21.78	21.81	22.03	20.92	21.07	21.28	19.53	20.03	20.10
	25	12	21.55	21.80	22.06	20.76	21.14	21.33	19.67	19.99	20.13
	25	25	21.57	21.97	22.06	20.98	21.02	21.28	19.59	20.04	20.16
	50	0	21.73	22.06	22.02	20.92	21.04	21.36	19.54	19.90	20.13

*Note: EIRP (dBm / 10MHz) = Conducted Output Power (dBm / 10MHz) + Antenna Gain (4.19dBi)

Band / BW	RB Size	RB Offset	QPSK			16QAM			64QAM		
			Low CH	Mid CH	High CH	Low CH	Mid CH	High CH	Low CH	Mid CH	High CH
			55315	55990	56665	55315	55990	56665	55315	55990	56665
			3557.5	3625	3692.5	3557.5	3625	3692.5	3557.5	3625	3692.5
			MHz	MHz	MHz	MHz	MHz	MHz	MHz	MHz	MHz
48 / 15M	1	0	22.36	22.77	22.71	21.66	21.95	22.17	20.50	20.87	20.73
	1	37	22.58	22.62	22.80	21.50	21.95	22.16	20.50	20.62	20.83
	1	74	22.56	22.84	22.73	21.64	21.99	22.19	20.51	20.81	20.83
	36	0	21.76	22.08	22.19	20.94	21.23	21.30	19.79	19.93	20.02
	36	19	21.73	21.79	22.10	20.91	21.00	21.36	19.54	19.97	20.12
	36	39	21.57	21.98	22.19	20.80	21.12	21.20	19.71	19.79	20.17
	75	0	19.20	19.45	19.60	18.40	18.62	18.77	16.99	17.38	17.52

*Note: EIRP (dBm / 10MHz) = Conducted Output Power (dBm / 10MHz) + Antenna Gain (4.19dBi)

Band / BW	RB Size	RB Offset	QPSK			16QAM			64QAM		
			Low CH	Mid CH	High CH	Low CH	Mid CH	High CH	Low CH	Mid CH	High CH
			55340	55990	56640	55340	55990	56640	55340	55990	56640
			3560 MHz	3625 MHz	3690 MHz	3560 MHz	3625 MHz	3690 MHz	3560 MHz	3625 MHz	3690 MHz
48 / 20M	1	0	22.48	22.59	22.85	21.70	21.90	22.08	20.33	20.81	20.75
	1	50	22.32	22.87	22.84	21.70	22.02	21.98	20.35	20.83	20.94
	1	99	22.42	22.66	22.73	21.61	22.06	21.97	20.56	20.61	20.84
	50	0	21.57	21.89	22.04	20.82	21.27	21.21	19.75	19.97	20.14
	50	25	21.65	21.91	22.18	20.92	21.26	21.37	19.56	20.06	20.00
	50	50	21.52	21.90	21.99	20.99	21.16	21.33	19.62	20.06	20.03
	100	0	18.57	18.97	19.11	17.81	18.14	18.35	16.64	16.98	20.00

*Note: EIRP (dBm / 10MHz) = Conducted Output Power (dBm / 10MHz) + Antenna Gain (4.19dBi)

Full Conducted Output Power (dBm / 10MHz)

Band / BW	RB Size	RB Offset	QPSK			16QAM			64QAM		
			Low CH	Mid CH	High CH	Low CH	Mid CH	High CH	Low CH	Mid CH	High CH
			55265	55990	56715	55265	55990	56715	55265	55990	56715
			3552.5	3625	3697.5	3552.5	3625	3697.5	3552.5	3625	3697.5
			MHz	MHz	MHz	MHz	MHz	MHz	MHz	MHz	MHz
48 / 5M	1	0	18.18	18.57	18.72	17.35	17.85	17.90	16.22	16.69	16.71
	1	12	18.29	18.66	18.51	17.32	17.84	17.99	16.18	16.51	16.63
	1	24	18.12	18.67	18.58	17.59	17.61	17.76	16.37	16.65	16.65
	12	0	17.32	17.75	17.80	16.50	16.81	17.15	15.35	15.78	15.97
	12	6	17.47	17.80	17.91	16.61	16.95	17.11	15.46	15.76	15.91
	12	13	17.45	17.68	18.00	16.54	17.10	17.10	15.55	15.69	15.99
	25	0	17.43	17.80	17.99	16.56	16.85	17.17	15.41	15.66	15.95

Full Conducted Output Power (dBm / 10MHz)

Band / BW	RB Size	RB Offset	QPSK			16QAM			64QAM		
			Low CH	Mid CH	High CH	Low CH	Mid CH	High CH	Low CH	Mid CH	High CH
			55290	55990	56690	55290	55990	56690	55290	55990	56690
			3555	3625	3695	3555	3625	3695	3555	3625	3695
			MHz	MHz	MHz	MHz	MHz	MHz	MHz	MHz	MHz
48 / 10M	1	0	18.21	18.56	18.56	17.33	17.61	17.72	16.23	16.60	16.55
	1	24	18.15	18.61	18.79	17.54	17.82	17.82	16.10	16.61	16.55
	1	49	18.37	18.53	18.57	17.43	17.60	17.83	16.37	16.65	16.61
	25	0	17.59	17.62	17.84	16.73	16.88	17.09	15.34	15.84	15.91
	25	12	17.36	17.61	17.87	16.57	16.95	17.14	15.48	15.80	15.94
	25	25	17.38	17.78	17.87	16.79	16.83	17.09	15.40	15.85	15.97
	50	0	17.54	17.87	17.83	16.73	16.85	17.17	15.35	15.71	15.94

Full Conducted Output Power (dBm / 15MHz)

Band / BW	RB Size	RB Offset	QPSK			16QAM			64QAM		
			Low CH	Mid CH	High CH	Low CH	Mid CH	High CH	Low CH	Mid CH	High CH
			55315	55990	56665	55315	55990	56665	55315	55990	56665
			3557.5	3625	3692.5	3557.5	3625	3692.5	3557.5	3625	3692.5
			MHz	MHz	MHz	MHz	MHz	MHz	MHz	MHz	MHz
48 / 15M	1	0	18.11	18.67	18.67	17.54	17.65	18.02	16.18	16.52	16.70
	1	37	18.20	18.59	18.72	17.39	17.81	17.73	16.13	16.47	16.75
	1	74	18.24	18.69	18.72	17.48	17.73	17.86	16.21	16.59	16.66
	36	0	17.58	17.82	17.98	16.53	16.96	17.15	15.44	15.68	15.96
	36	19	17.34	17.63	17.80	16.75	16.85	17.04	15.45	15.71	15.91
	36	39	17.38	17.63	17.83	16.64	17.03	17.10	15.43	15.68	15.92
	75	0	17.40	17.87	17.80	16.80	17.06	17.15	15.52	15.82	15.89

Full Conducted Output Power (dBm / 20MHz)

Band / BW	RB Size	RB Offset	QPSK			16QAM			64QAM		
			Low CH	Mid CH	High CH	Low CH	Mid CH	High CH	Low CH	Mid CH	High CH
			55340	55990	56640	55340	55990	56640	55340	55990	56640
			3560	3625	3690	3560	3625	3690	3560	3625	3690
			MHz	MHz	MHz	MHz	MHz	MHz	MHz	MHz	MHz
48 / 20M	1	0	18.40	18.64	18.59	17.37	17.82	17.86	16.39	16.45	16.50
	1	50	18.37	18.43	18.53	17.35	17.65	17.92	16.22	16.51	16.62
	1	99	18.36	18.75	18.63	17.47	17.63	17.77	16.15	16.64	16.80
	50	0	17.31	17.80	17.84	16.76	17.03	17.13	15.39	15.64	15.91
	50	25	17.35	17.85	17.94	16.62	16.84	17.08	15.52	15.85	15.82
	50	50	17.37	17.87	17.80	16.65	16.98	17.05	15.41	15.80	15.90
	100	0	17.55	17.63	17.95	16.75	16.92	17.05	15.37	15.68	15.88

Spectrum Plot of Worst Value

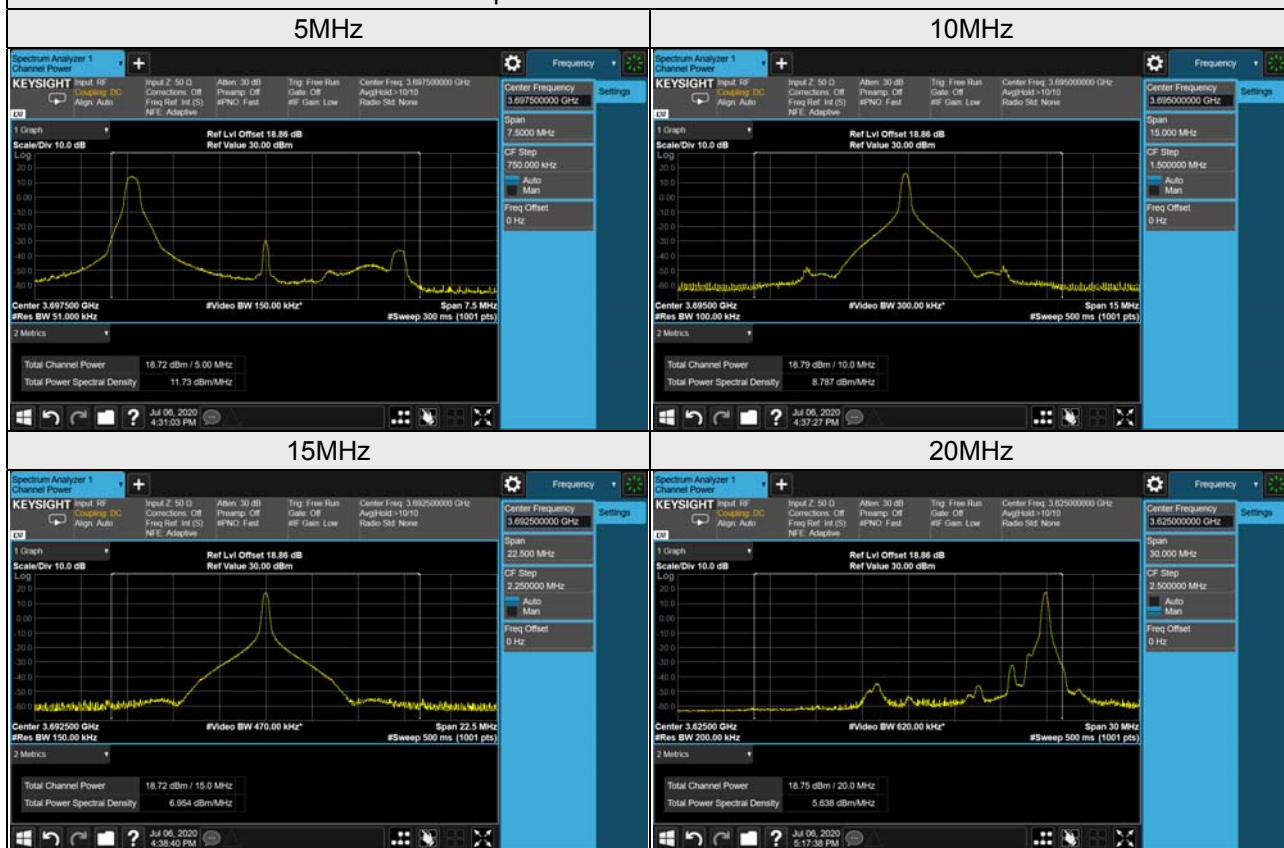

Full EIRP (dBm / 10MHz)

Band / BW	RB Size	RB Offset	QPSK			16QAM			64QAM		
			Low CH	Mid CH	High CH	Low CH	Mid CH	High CH	Low CH	Mid CH	High CH
			55265	55990	56715	55265	55990	56715	55265	55990	56715
			3552.5	3625	3697.5	3552.5	3625	3697.5	3552.5	3625	3697.5
			MHz	MHz	MHz	MHz	MHz	MHz	MHz	MHz	MHz
48 / 5M	1	0	22.37	22.76	22.91	21.54	22.04	22.09	20.41	20.88	20.90
	1	12	22.48	22.85	22.70	21.51	22.03	22.18	20.37	20.70	20.82
	1	24	22.31	22.86	22.77	21.78	21.80	21.95	20.56	20.84	20.84
	12	0	21.51	21.94	21.99	20.69	21.00	21.34	19.54	19.97	20.16
	12	6	21.66	21.99	22.10	20.80	21.14	21.30	19.65	19.95	20.10
	12	13	21.64	21.87	22.19	20.73	21.29	21.29	19.74	19.88	20.18
	25	0	21.62	21.99	22.18	20.75	21.04	21.36	19.60	19.85	20.14

*Note: Full EIRP = Full Conducted Output Power (dBm / 10MHz) + Antenna Gain (4.19dBi)

Full EIRP (dBm / 10MHz)

Band / BW	RB Size	RB Offset	QPSK			16QAM			64QAM		
			Low CH	Mid CH	High CH	Low CH	Mid CH	High CH	Low CH	Mid CH	High CH
			55290	55990	56690	55290	55990	56690	55290	55990	56690
			3555	3625	3695	3555	3625	3695	3555	3625	3695
			MHz	MHz	MHz	MHz	MHz	MHz	MHz	MHz	MHz
48 / 10M	1	0	22.40	22.75	22.75	21.52	21.80	21.91	20.42	20.79	20.74
	1	24	22.34	22.80	22.98	21.73	22.01	22.01	20.29	20.80	20.74
	1	49	22.56	22.72	22.76	21.62	21.79	22.02	20.56	20.84	20.80
	25	0	21.78	21.81	22.03	20.92	21.07	21.28	19.53	20.03	20.10
	25	12	21.55	21.80	22.06	20.76	21.14	21.33	19.67	19.99	20.13
	25	25	21.57	21.97	22.06	20.98	21.02	21.28	19.59	20.04	20.16
	50	0	21.73	22.06	22.02	20.92	21.04	21.36	19.54	19.90	20.13

*Note: Full EIRP = Full Conducted Output Power (dBm / 10MHz) + Antenna Gain (4.19dBi)

Full EIRP (dBm / 15MHz)

Band / BW	RB Size	RB Offset	QPSK			16QAM			64QAM		
			Low CH	Mid CH	High CH	Low CH	Mid CH	High CH	Low CH	Mid CH	High CH
			55315	55990	56665	55315	55990	56665	55315	55990	56665
			3557.5	3625	3692.5	3557.5	3625	3692.5	3557.5	3625	3692.5
			MHz	MHz	MHz	MHz	MHz	MHz	MHz	MHz	MHz
48 / 15M	1	0	22.30	22.86	22.86	21.73	21.84	22.21	20.37	20.71	20.89
	1	37	22.39	22.78	22.91	21.58	22.00	21.92	20.32	20.66	20.94
	1	74	22.43	22.88	22.91	21.67	21.92	22.05	20.40	20.78	20.85
	36	0	21.77	22.01	22.17	20.72	21.15	21.34	19.63	19.87	20.15
	36	19	21.53	21.82	21.99	20.94	21.04	21.23	19.64	19.90	20.10
	36	39	21.57	21.82	22.02	20.83	21.22	21.29	19.62	19.87	20.11
	75	0	21.59	22.06	21.99	20.99	21.25	21.34	19.71	20.01	20.08

*Note: Full EIRP = Full Conducted Output Power (dBm / 15MHz) + Antenna Gain (4.19dBi)

Full EIRP (dBm / 20MHz)

Band / BW	RB Size	RB Offset	QPSK			16QAM			64QAM		
			Low CH	Mid CH	High CH	Low CH	Mid CH	High CH	Low CH	Mid CH	High CH
			55340	55990	56640	55340	55990	56640	55340	55990	56640
			3560	3625	3690	3560	3625	3690	3560	3625	3690
			MHz	MHz	MHz	MHz	MHz	MHz	MHz	MHz	MHz
48 / 20M	1	0	22.59	22.83	22.78	21.56	22.01	22.05	20.58	20.64	20.69
	1	50	22.56	22.62	22.72	21.54	21.84	22.11	20.41	20.70	20.81
	1	99	22.55	22.94	22.82	21.66	21.82	21.96	20.34	20.83	20.99
	50	0	21.50	21.99	22.03	20.95	21.22	21.32	19.58	19.83	20.10
	50	25	21.54	22.04	22.13	20.81	21.03	21.27	19.71	20.04	20.01
	50	50	21.56	22.06	21.99	20.84	21.17	21.24	19.60	19.99	20.09
	100	0	21.74	21.82	22.14	20.94	21.11	21.24	19.56	19.87	20.07

*Note: Full EIRP = Full Conducted Output Power (dBm / 20MHz) + Antenna Gain (4.19dBi)

4.2 Modulation Characteristics Measurement

4.2.1 Limits of Modulation Characteristics

N/A

4.2.2 Test Procedure

Connect the EUT to Communication Simulator via the antenna connector, The frequency band is set as EUT supported Modulation and Channels, the EUT output is matched with 50 ohm load, the waveform quality and constellation of the EUT was tested.

4.2.3 Test Setup



4.2.4 Test Results

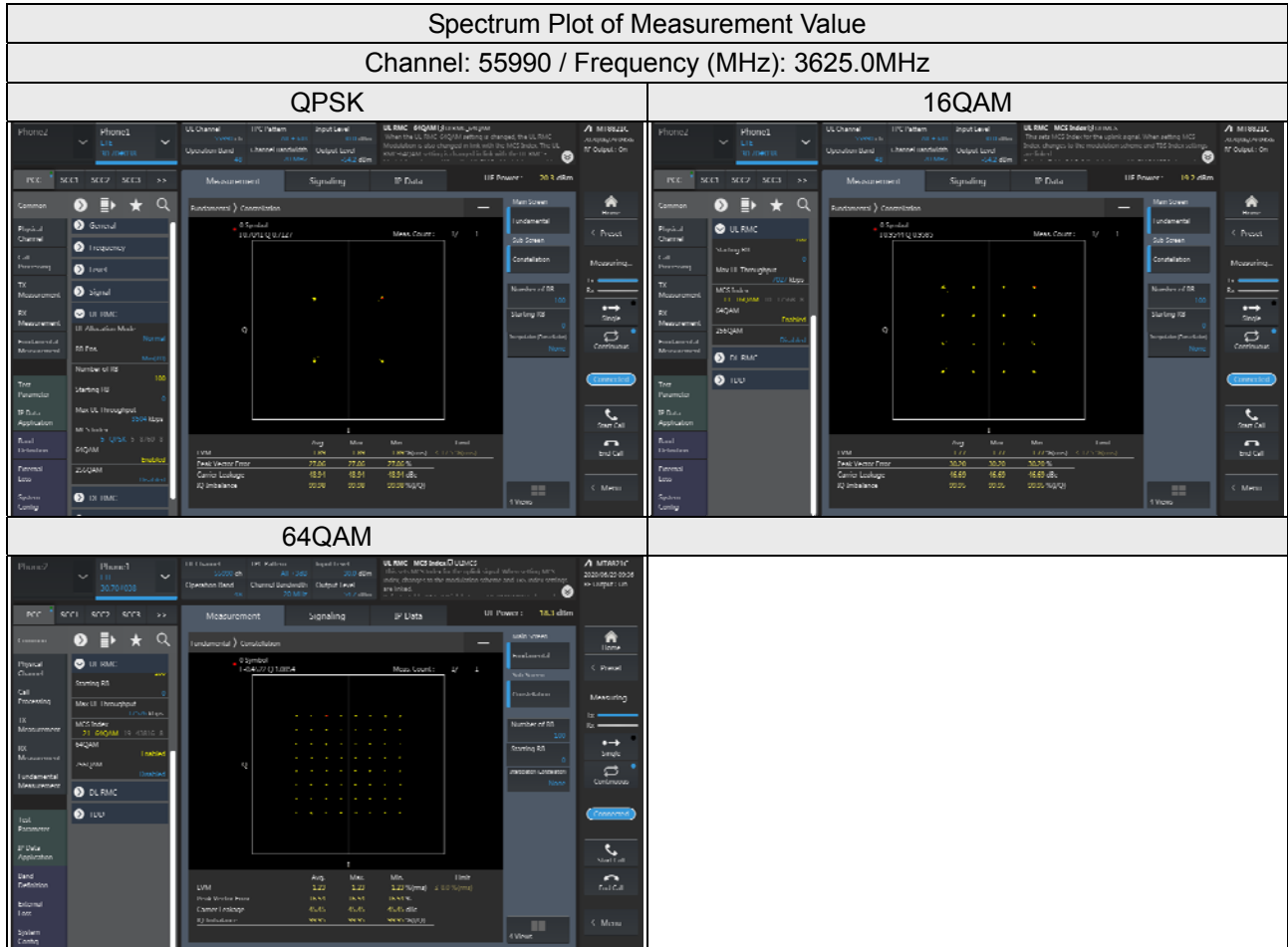

4.3 Frequency Stability Measurement

4.3.1 Limits of Frequency Stability Measurement

The frequency stability shall be sufficient to ensure that the fundamental emission stays within the authorized frequency band.

4.3.2 Test Instruments

Refer to 4.7.2

4.3.3 Test Procedure

- Device is placed at the oven room. The oven room could control the temperatures and humidity. Power warm up is at least 15 min and power applied should perform before recording frequency error.
- EUT is connected the external power supply to control the AC input power. The test voltage range is from minimum to maximum working voltage. Each step shall be record the frequency error rate.
- The temperature range step is 10 degrees in this test items. All temperature levels shall be hold the ± 0.5 °C during the measurement testing. The each temperature step shall be at least 0.5 hours, consider the EUT could be test under the stability condition.

Note: The frequency error was recorded frequency error from the communication simulator.

4.3.4 Test Setup

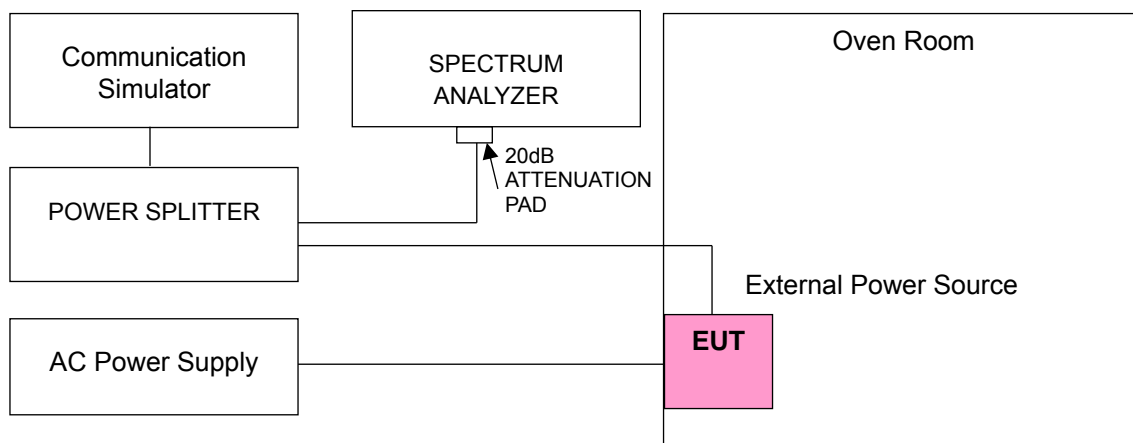

4.3.5 Test Results

Frequency Error vs. Voltage

Voltage (Volts)	LTE Band 48, Channel Bandwidth: 5MHz			
	Low Channel		High Channel	
	Frequency (MHz)	Frequency Error (ppm)	Frequency (MHz)	Frequency Error (ppm)
110.0	3552.500003	0.001	3697.500002	0.000
93.5	3552.500002	0.001	3697.500001	0.000
126.5	3552.500004	0.001	3697.500004	0.001

Note: The applicant defined the normal working voltage is from 93.5Vac to 126.5Vac.

Frequency Error vs. Temperature

Temp. (°C)	LTE Band 48, Channel Bandwidth: 5MHz			
	Low Channel		High Channel	
	Frequency (MHz)	Frequency Error (ppm)	Frequency (MHz)	Frequency Error (ppm)
-30	3552.500001	0.000	3697.500003	0.001
-20	3552.500002	0.001	3697.500001	0.000
-10	3552.500003	0.001	3697.500004	0.001
0	3552.500003	0.001	3697.500004	0.001
10	3552.500003	0.001	3697.500003	0.001
20	3552.499997	-0.001	3697.499999	0.000
30	3552.499999	0.000	3697.499996	-0.001
40	3552.499997	-0.001	3697.499996	-0.001
50	3552.499999	0.000	3697.499998	0.000
55	3552.499997	-0.001	3697.499997	-0.001

Frequency Error vs. Voltage

Voltage (Volts)	LTE Band 48, Channel Bandwidth: 10MHz			
	Low Channel		High Channel	
	Frequency (MHz)	Frequency Error (ppm)	Frequency (MHz)	Frequency Error (ppm)
110.0	3555.000004	0.001	3695.000001	0.000
93.5	3555.000002	0.001	3695.000004	0.001
126.5	3555.000003	0.001	3695.000003	0.001

Note: The applicant defined the normal working voltage is from 93.5Vac to 126.5Vac.

Frequency Error vs. Temperature

Temp. (°C)	LTE Band 48, Channel Bandwidth: 10MHz			
	Low Channel		High Channel	
	Frequency (MHz)	Frequency Error (ppm)	Frequency (MHz)	Frequency Error (ppm)
-30	3555.000002	0.001	3695.000004	0.001
-20	3555.000002	0.001	3695.000001	0.000
-10	3555.000002	0.001	3695.000002	0.001
0	3555.000003	0.001	3695.000001	0.000
10	3555.000001	0.000	3695.000002	0.000
20	3554.999998	-0.001	3694.999996	-0.001
30	3554.999998	0.000	3694.999997	-0.001
40	3554.999997	-0.001	3694.999998	-0.001
50	3554.999996	-0.001	3694.999997	-0.001
55	3554.999996	-0.001	3694.999998	0.000

Frequency Error vs. Voltage

Voltage (Volts)	LTE Band 48, Channel Bandwidth: 15MHz			
	Low Channel		High Channel	
	Frequency (MHz)	Frequency Error (ppm)	Frequency (MHz)	Frequency Error (ppm)
110.0	3557.500004	0.001	3692.500002	0.001
93.5	3557.500002	0.000	3692.500004	0.001
126.5	3557.500002	0.001	3692.500003	0.001

Note: The applicant defined the normal working voltage is from 93.5Vac to 126.5Vac.

Frequency Error vs. Temperature

Temp. (°C)	LTE Band 48, Channel Bandwidth: 15MHz			
	Low Channel		High Channel	
	Frequency (MHz)	Frequency Error (ppm)	Frequency (MHz)	Frequency Error (ppm)
-30	3557.500003	0.001	3692.500002	0.001
-20	3557.500003	0.001	3692.500002	0.000
-10	3557.500003	0.001	3692.500003	0.001
0	3557.500001	0.000	3692.500001	0.000
10	3557.500004	0.001	3692.500001	0.000
20	3557.499998	0.000	3692.499996	-0.001
30	3557.499996	-0.001	3692.499998	-0.001
40	3557.499999	0.000	3692.499998	-0.001
50	3557.499998	-0.001	3692.499997	-0.001
55	3557.499999	0.000	3692.499998	0.000

Frequency Error vs. Voltage

Voltage (Volts)	LTE Band 48, Channel Bandwidth: 20MHz			
	Low Channel		High Channel	
	Frequency (MHz)	Frequency Error (ppm)	Frequency (MHz)	Frequency Error (ppm)
110.0	3560.000004	0.001	3690.000001	0.000
93.5	3560.000003	0.001	3690.000004	0.001
126.5	3560.000003	0.001	3690.000003	0.001

Note: The applicant defined the normal working voltage is from 93.5Vac to 126.5Vac.

Frequency Error vs. Temperature

Temp. (°C)	LTE Band 48, Channel Bandwidth: 20MHz			
	Low Channel		High Channel	
	Frequency (MHz)	Frequency Error (ppm)	Frequency (MHz)	Frequency Error (ppm)
-30	3560.000002	0.001	3690.000004	0.001
-20	3560.000002	0.001	3690.000002	0.000
-10	3560.000003	0.001	3690.000001	0.000
0	3560.000004	0.001	3690.000003	0.001
10	3560.000003	0.001	3690.000003	0.001
20	3559.999997	-0.001	3689.999997	-0.001
30	3559.999999	0.000	3689.999997	-0.001
40	3559.999999	0.000	3689.999997	-0.001
50	3559.999999	0.000	3689.999998	-0.001
55	3559.999999	0.000	3689.999997	-0.001

4.4 Emission Bandwidth Measurement

4.4.1 Emission Bandwidth Measurement

Reference only

4.4.2 Test Setup

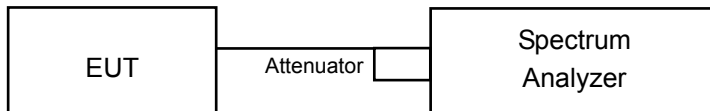

4.4.3 Test Instruments

Refer to section 4.1.3 to get information of above instrument.

4.4.4 Test Procedure

Occupied Bandwidth & 26dBc Bandwidth

1. The spectrum analyzer center frequency is set to the nominal EUT channel center frequency. The span range for the spectrum analyzer shall be wide enough to see sufficient roll off of the signal to make the measurement.
2. The nominal RBW shall be in the range of 1% to 5% of the anticipated OBW, and the VBW shall be set $\geq 3 \times$ RBW.
3. Set the reference level of the instrument as required to prevent the signal amplitude from exceeding the maximum spectrum analyzer input mixer level for linear operation.
NOTE—Step 1), step 2), and step 3) may require iteration to adjust within the specified tolerances.
4. The dynamic range of the spectrum analyzer at the selected RBW shall be more than 10 dB below the target “-X dB” requirement, i.e., if the requirement calls for measuring the -26 dB OBW, the spectrum analyzer noise floor at the selected RBW shall be at least 36 dB below the reference level.
5. Set spectrum analyzer detection mode to peak, and the trace mode to max hold.
6. Determine the reference value by either of the following:
 - a) Set the EUT to transmit a modulated signal. Allow the trace to stabilize. Set the spectrum analyzer marker to the highest level of the displayed trace (this is the reference value).
 - b) Set the EUT to transmit an unmodulated carrier. Set the spectrum analyzer marker to the level of the carrier.
7. Determine the “-X dB amplitude” as equal to (Reference Value - X). Alternatively, this calculation can be performed on the spectrum analyzer using the delta-marker measurement function.

4.4.5 Deviation from Test Standard

No deviation.

4.4.6 EUT Operating Conditions

The software provided by client to enable the EUT under transmission condition continuously at lowest, middle and highest channel frequencies individually.

4.4.7 Test Result (-26dB Bandwidth)

LTE Band 48, Channel Bandwidth 5MHz				
Channel	Frequency (MHz)	26dB Bandwidth (MHz)		
		QPSK	16QAM	64QAM
55265	3552.5	4.76	4.70	4.70
55990	3625.0	4.75	4.71	4.72
56715	3697.5	4.76	4.75	4.76
LTE Band 48, Channel Bandwidth 10MHz				
Channel	Frequency (MHz)	26dB Bandwidth (MHz)		
		QPSK	16QAM	64QAM
55290	3555.0	9.30	9.32	9.37
55990	3625.0	9.34	9.32	9.36
56690	3695.0	9.32	9.32	9.36
LTE Band 48, Channel Bandwidth 15MHz				
Channel	Frequency (MHz)	26dB Bandwidth (MHz)		
		QPSK	16QAM	64QAM
55315	3557.5	13.95	14.03	14.02
55990	3625.0	13.94	13.92	14.05
56665	3692.5	13.96	14.01	13.96
LTE Band 48, Channel Bandwidth 20MHz				
Channel	Frequency (MHz)	26dB Bandwidth (MHz)		
		QPSK	16QAM	64QAM
55340	3560.0	18.50	18.54	18.56
55990	3625.0	18.53	18.55	18.55
56640	3690.0	18.55	18.54	18.54

Spectrum Plot of Worst Value

5MHz / QPSK

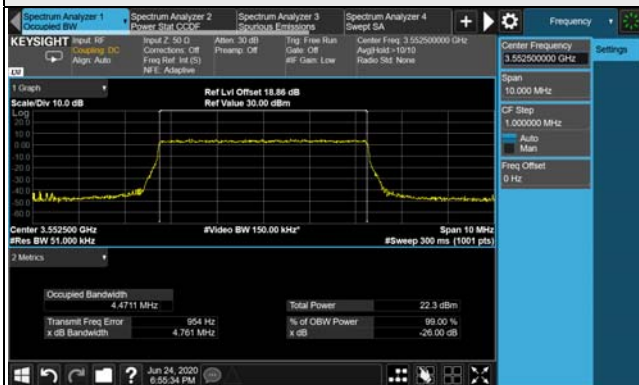

10MHz / 64QAM



15MHz / 64QAM

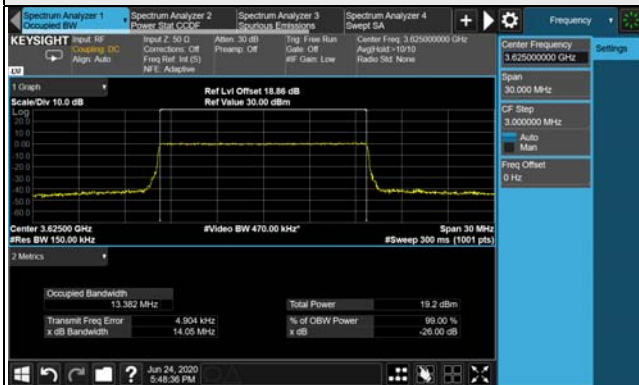

20MHz / 64QAM

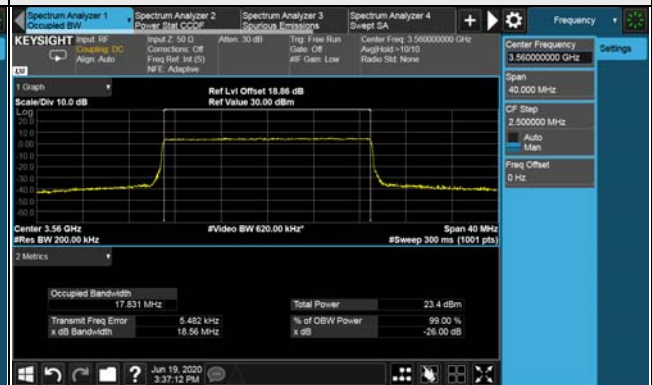

4.4.8 Test Result (Occupied Bandwidth)

LTE Band 48, Channel Bandwidth 5MHz				
Channel	Frequency (MHz)	99% Occupied Bandwidth (MHz)		
		QPSK	16QAM	64QAM
55265	3552.5	4.47	4.45	4.46
55990	3625.0	4.47	4.46	4.46
56715	3697.5	4.46	4.46	4.46
LTE Band 48, Channel Bandwidth 10MHz				
Channel	Frequency (MHz)	99% Occupied Bandwidth (MHz)		
		QPSK	16QAM	64QAM
55290	3555.0	8.92	8.92	8.92
55990	3625.0	8.91	8.92	8.92
56690	3695.0	8.91	8.92	8.92
LTE Band 48, Channel Bandwidth 15MHz				
Channel	Frequency (MHz)	99% Occupied Bandwidth (MHz)		
		QPSK	16QAM	64QAM
55315	3557.5	13.38	13.37	13.37
55990	3625.0	13.38	13.38	13.38
56665	3692.5	13.38	13.38	13.39
LTE Band 48, Channel Bandwidth 20MHz				
Channel	Frequency (MHz)	99% Occupied Bandwidth (MHz)		
		QPSK	16QAM	64QAM
55340	3560.0	17.84	17.82	17.83
55990	3625.0	17.83	17.81	17.83
56640	3690.0	17.83	17.80	17.83

Spectrum Plot of Worst Value

5MHz / QPSK

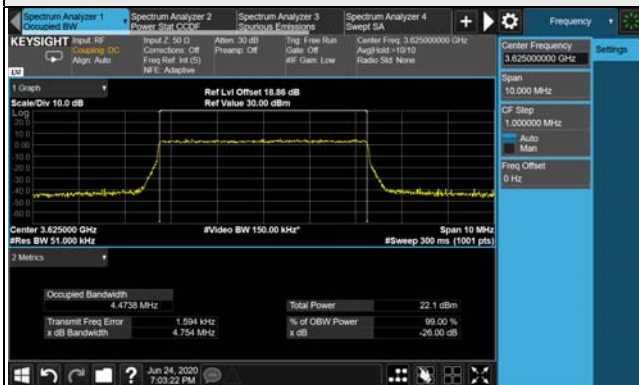

10MHz / 16QAM



15MHz / 64QAM

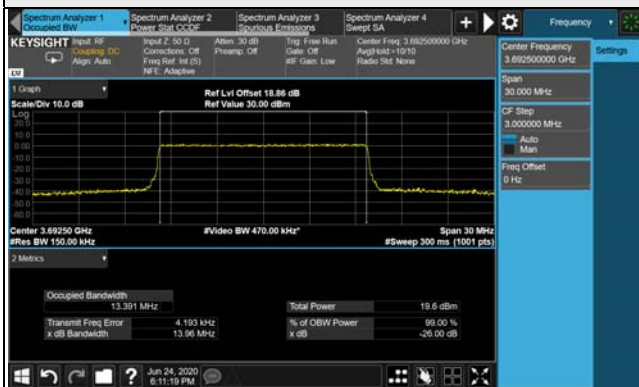

20MHz / QPSK



4.5 Peak to Average Ratio Measurement

4.5.1 Limits of Peak to Average Ratio Measurement

In measuring transmissions in this band using an average power technique, the peak to-average ratio (PAR) of the transmission may not exceed 13 dB

4.5.2 Test Setup

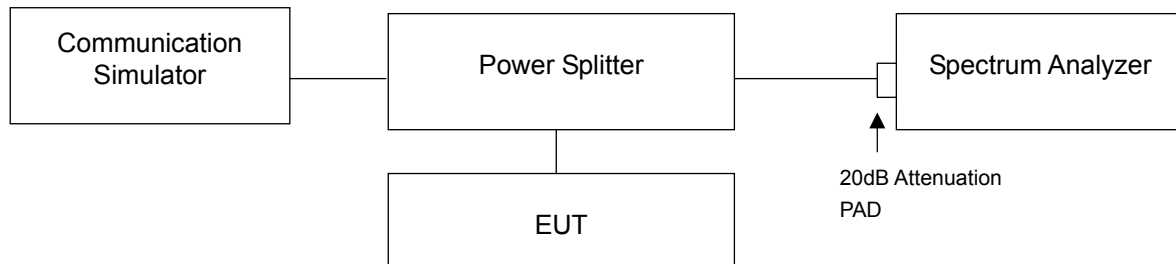

4.5.3 Test Procedures

- Set resolution/measurement bandwidth \geq signal's occupied bandwidth;
- Set the number of counts to a value that stabilizes the measured CCDF curve;
- Record the maximum PAPR level associated with a probability of 0.1%.

4.5.4 Test Results

LTE Band 48, Channel Bandwidth 5MHz				
Channel	Frequency (MHz)	Peak To Average Ratio (dB)		
		QPSK	16QAM	64QAM
55265	3552.5	3.87	6.04	7.04
55990	3625.0	3.80	5.79	7.20
56715	3697.5	3.93	6.28	7.02
LTE Band 48, Channel Bandwidth 10MHz				
Channel	Frequency (MHz)	Peak To Average Ratio (dB)		
		QPSK	16QAM	64QAM
55290	3555.0	3.89	5.67	7.14
55990	3625.0	3.81	5.29	6.99
56690	3695.0	4.10	5.74	7.58
LTE Band 48, Channel Bandwidth 15MHz				
Channel	Frequency (MHz)	Peak To Average Ratio (dB)		
		QPSK	16QAM	64QAM
55315	3557.5	3.92	5.86	7.09
55990	3625.0	3.85	5.38	6.66
56665	3692.5	3.97	5.84	7.26
LTE Band 48, Channel Bandwidth 20MHz				
Channel	Frequency (MHz)	Peak To Average Ratio (dB)		
		QPSK	16QAM	64QAM
55340	3560.0	5.68	6.63	7.04
55990	3625.0	5.58	6.39	6.86
56640	3690.0	5.31	6.13	6.79

Spectrum Plot of Worst Value

5MHz / 64QAM



10MHz / 64QAM

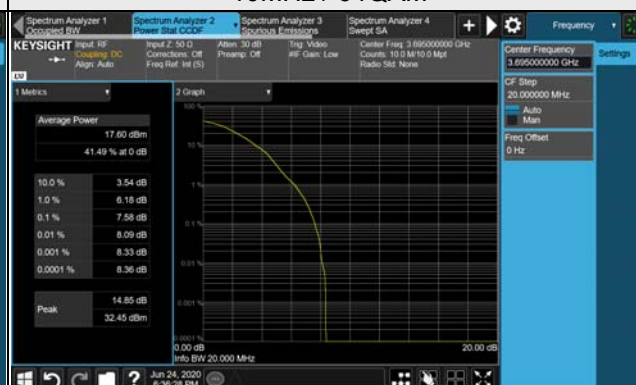

15MHz / 64QAM



20MHz / 64QAM



4.6 Conducted Spurious Emissions

4.6.1 Limits of Conducted Spurious Emissions Measurement

Power of any emissions outside the Fundamental	Limit
Within 0-10MHz above the Assigned Channel	-13 dBm/MHz
Within 0-10MHz below the Assigned Channel	
Greater than 10MHz above the Assigned Channel	-25 dBm/MHz
Greater than 10MHz below the Assigned Channel	
Power of any emission below 3530MHz	-40 dBm/MHz
Power of any emission above 3720MHz	

4.6.2 Test Setup

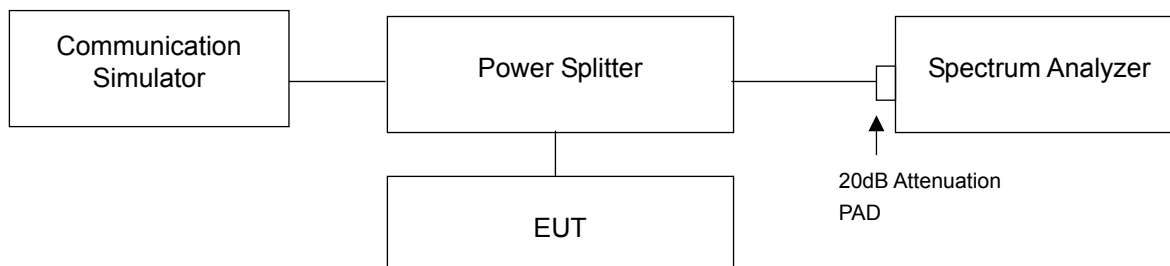

4.6.3 Test Procedure

- The EUT makes a phone call to the communication simulator. All measurements were done at low, middle and high operational frequency range.
- Measuring frequency range are from 9 kHz to 40GHz. 20dB attenuation pad is connected with spectrum. RBW=1MHz and VBW=3MHz is used for conducted emission measurement.
- Measuring frequency band edge, 20dB attenuation pad is connected with spectrum. 1% of the fundamental emission bandwidth is used for conducted emission measurement.
- For 5 MHz and 10 MHz channel BW mode, extend the 1% range from 1M to 2M above and below the channel edge and then reduce the limit further by $10 \log (1000/100)=10\text{dB}$ (i.e. total $-13 + -10=-23\text{dB}$) to compensate for the integration from 100k to 1M.

4.6.4 Test Results

LTE Band 48, Channel Bandwidth 5MHz
 Channel 55265 (3552.5MHz)

1RB



Full RB



Channel 55990 (3625.0MHz)

1RB



Full RB



Channel 56715 (3697.5MHz)

1RB



Full RB



LTE Band 48, Channel Bandwidth 5MHz

Channel 55265 (3552.5MHz)

Frequency Range : 9kHz~1GHz

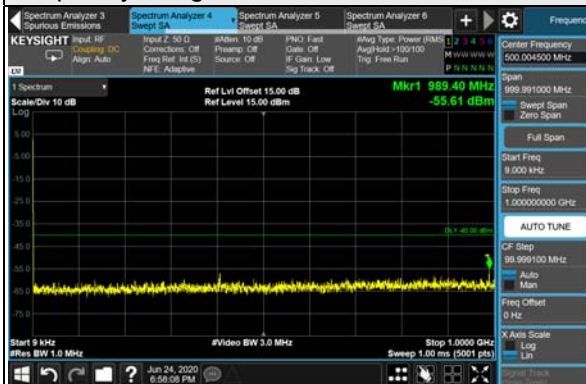

Frequency Range : 1GHz~18GHz



Frequency Range : 18GHz~40GHz

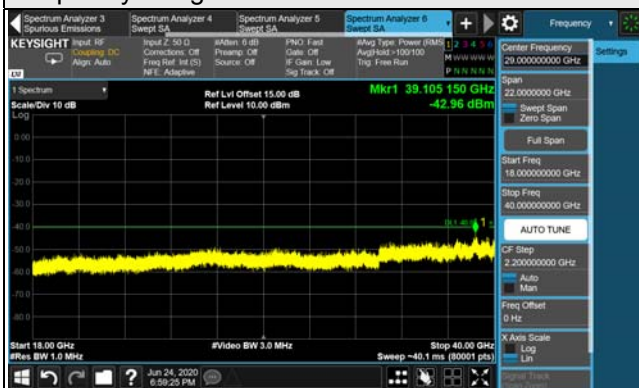

Note: The signal at 9 kHz is IF signal from spectrum analyzer.

LTE Band 48, Channel Bandwidth 5MHz

Channel 55990 (3625.0MHz)

Frequency Range : 9kHz~1GHz

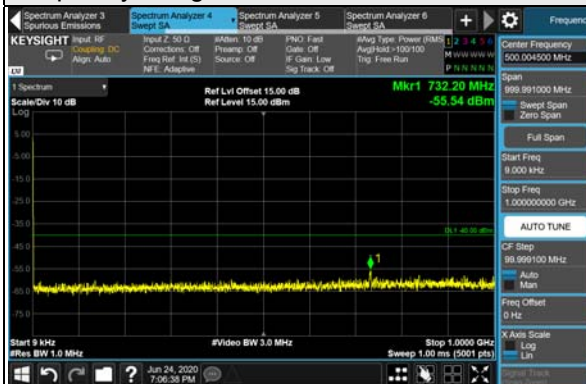

Frequency Range : 1GHz~18GHz

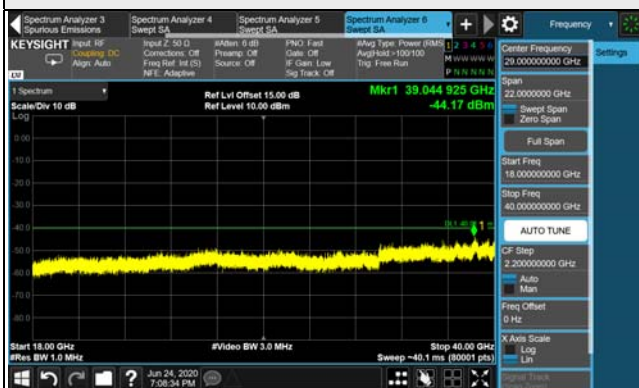
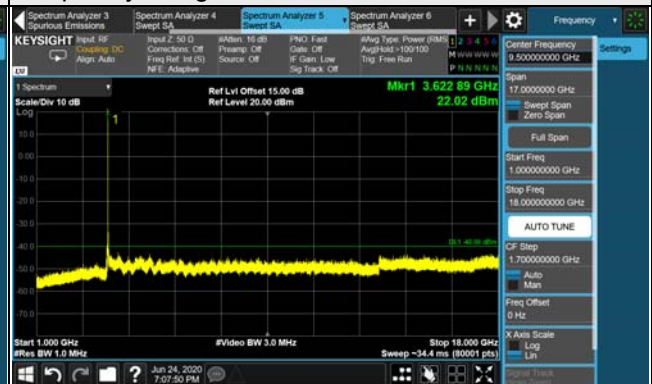

Note: The signal at 9 kHz is IF signal from spectrum analyzer.

LTE Band 48, Channel Bandwidth 5MHz

Channel 56715 (3697.50MHz)

Frequency Range : 9kHz~1GHz



Frequency Range : 1GHz~18GHz



Frequency Range : 18GHz~40GHz

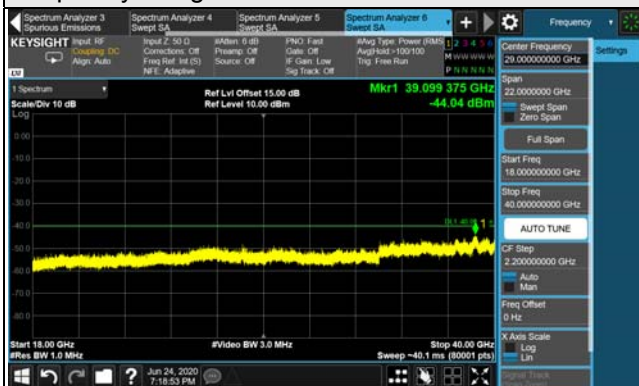

Note: The signal at 9 kHz is IF signal from spectrum analyzer.

LTE Band 48, Channel Bandwidth 10MHz

Channel 55290 (3555.0MHz)

1RB



Full RB



Channel 55990 (3625.00MHz)

1RB



Full RB



Channel 56690 (3695.0MHz)

1RB

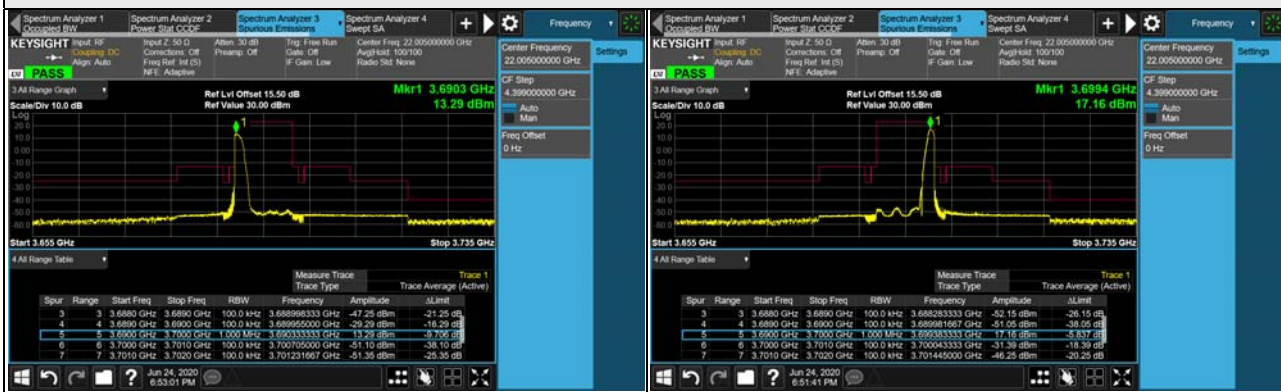

Full RB



LTE Band 48, Channel Bandwidth 10MHz

Channel 55290 (3555.0MHz)

Frequency Range : 9kHz~1GHz

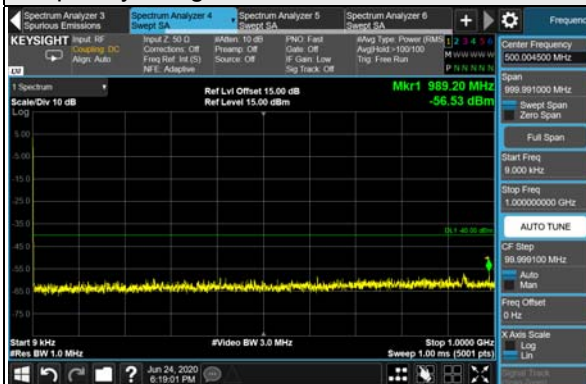

Frequency Range : 1GHz~18GHz

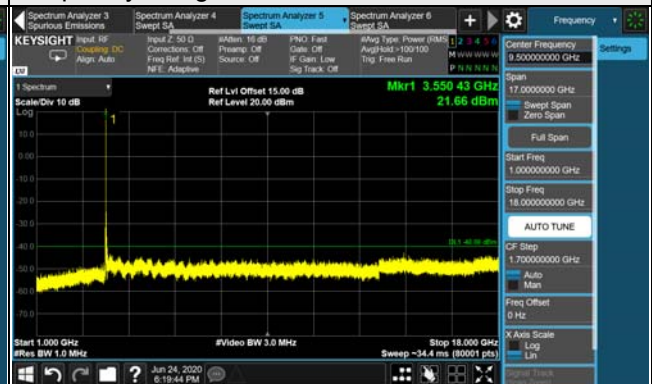

Frequency Range : 18GHz~40GHz

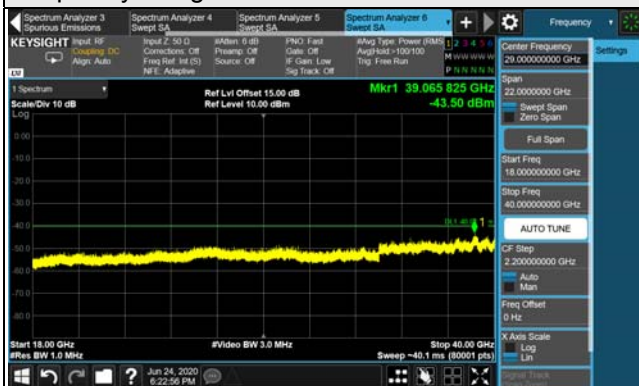

Note: The signal at 9 kHz is IF signal from spectrum analyzer.

LTE Band 48, Channel Bandwidth 10MHz

Channel 55990 (3625.00MHz)

Frequency Range : 9kHz~1GHz

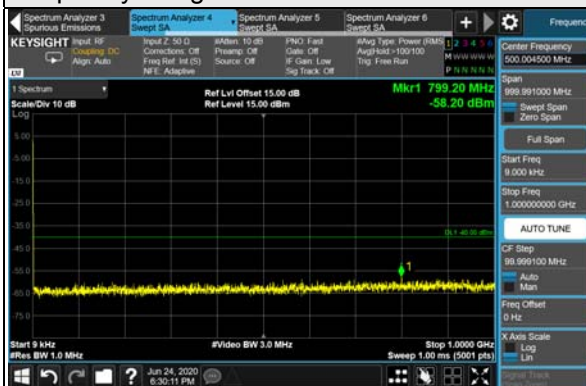

Frequency Range : 1GHz~18GHz

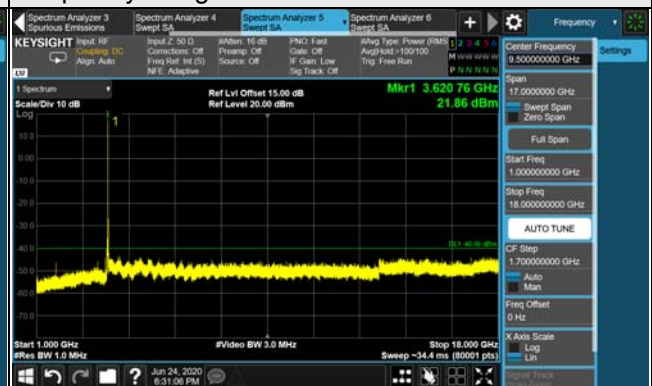

Frequency Range : 18GHz~40GHz

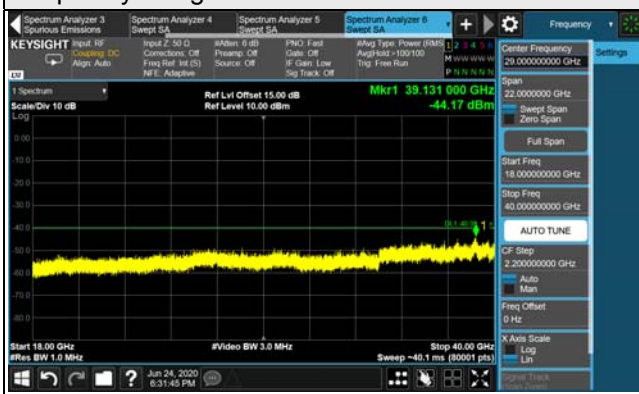

Note: The signal at 9 kHz is IF signal from spectrum analyzer.

LTE Band 48, Channel Bandwidth 10MHz

Channel 56690 (3695.0MHz)

Frequency Range : 9kHz~1GHz

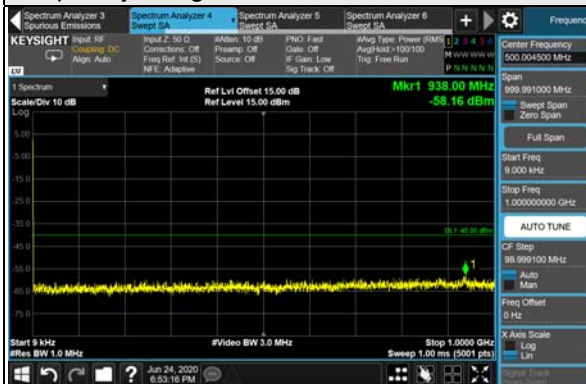

Frequency Range : 1GHz~18GHz

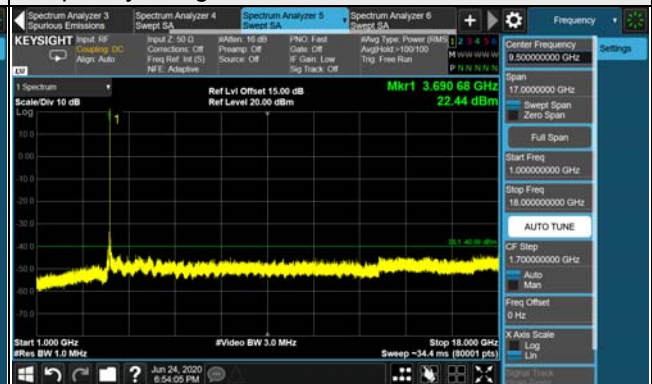

Frequency Range : 18GHz~40GHz

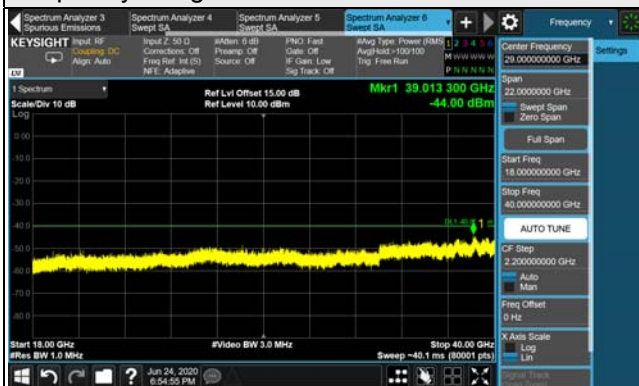

Note: The signal at 9 kHz is IF signal from spectrum analyzer.

LTE Band 48, Channel Bandwidth 15MHz

Channel 55315 (3557.50MHz)

1RB



Full RB



Channel 55990 (3625.0MHz)

1RB



Full RB



Channel 56665 (3692.5MHz)

1RB



Full RB



LTE Band 48, Channel Bandwidth 15MHz

Channel 55315 (3557.50MHz)

Frequency Range : 9kHz~1GHz

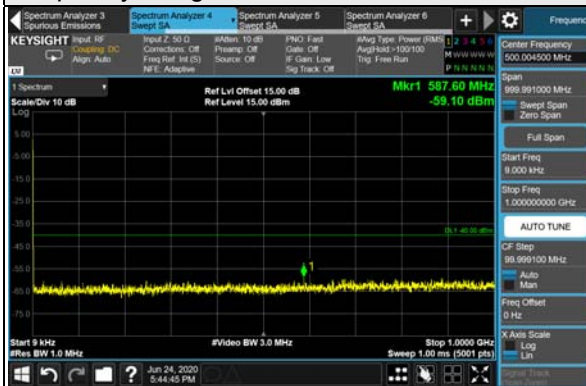

Frequency Range : 1GHz~18GHz



Frequency Range : 18GHz~40GHz

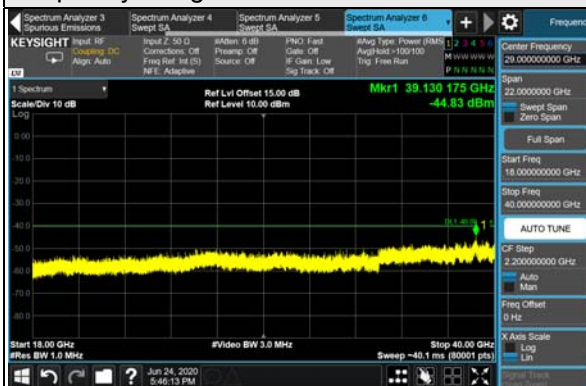

Note: The signal at 9 kHz is IF signal from spectrum analyzer.

LTE Band 48, Channel Bandwidth 15MHz

Channel 55990 (3625.0MHz)

Frequency Range : 9kHz~1GHz

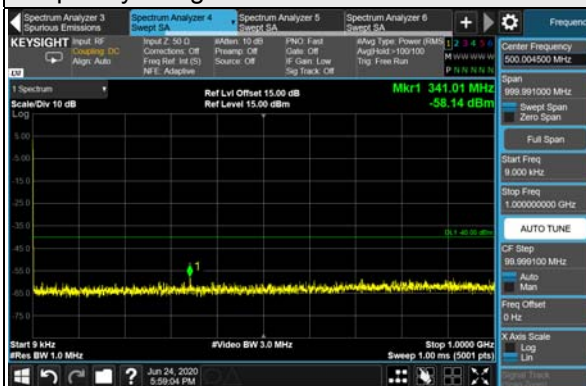

Frequency Range : 1GHz~18GHz

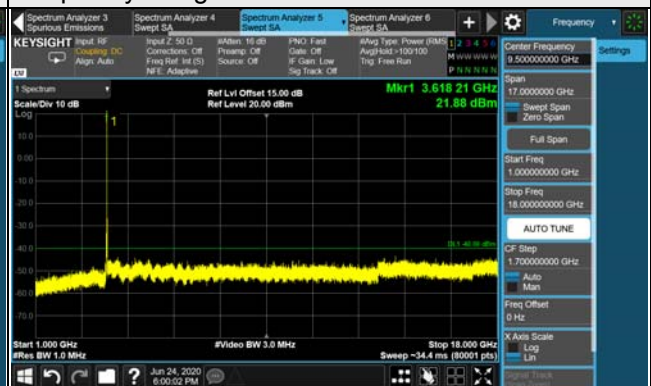

Frequency Range : 18GHz~40GHz

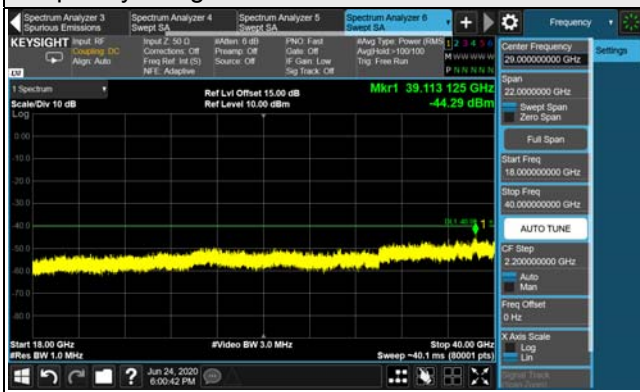

Note: The signal at 9 kHz is IF signal from spectrum analyzer.

LTE Band 48, Channel Bandwidth 15MHz

Channel 56665 (3692.50MHz)

Frequency Range : 9kHz~1GHz



Frequency Range : 1GHz~18GHz



Frequency Range : 18GHz~40GHz

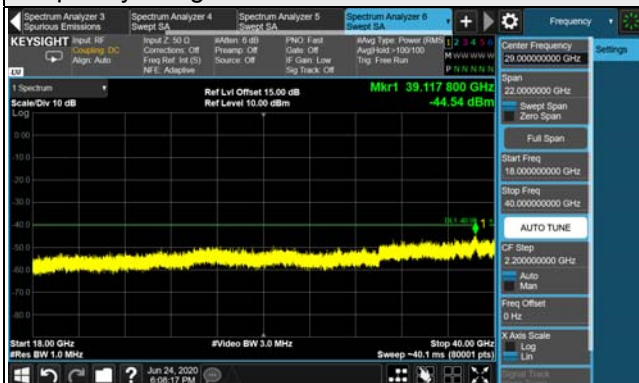

Note: The signal at 9 kHz is IF signal from spectrum analyzer.

LTE Band 48, Channel Bandwidth 20MHz

Channel 55340 (3560.0MHz)

1RB



Full RB



Channel 55990 (3625.0MHz)

1RB



Full RB



Channel 56640 (3690.0MHz)

1RB

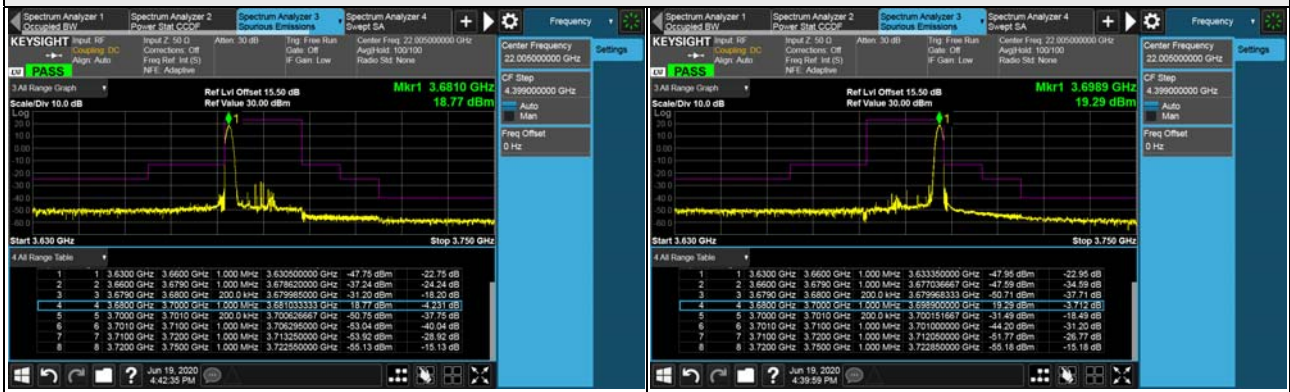

Full RB



LTE Band 48, Channel Bandwidth 20MHz

Channel 55340 (3560.0MHz)

Frequency Range : 9kHz~1GHz



Frequency Range : 1GHz~18GHz

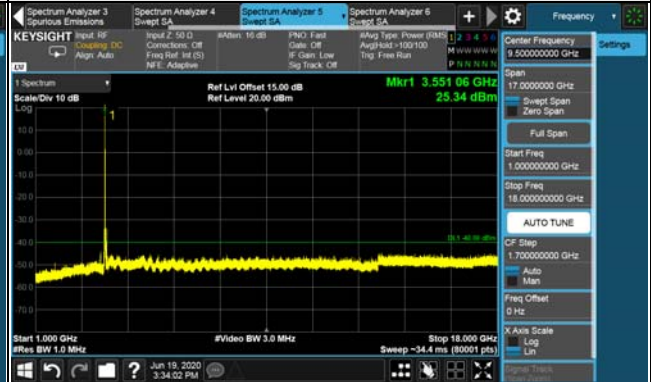

Frequency Range : 18GHz~40GHz

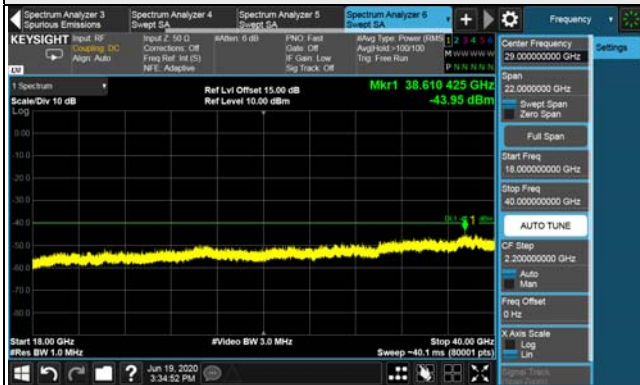

Note: The signal at 9 kHz is IF signal from spectrum analyzer.

LTE Band 48, Channel Bandwidth 20MHz

Channel 55990 (3625.0MHz)

Frequency Range : 9kHz~1GHz

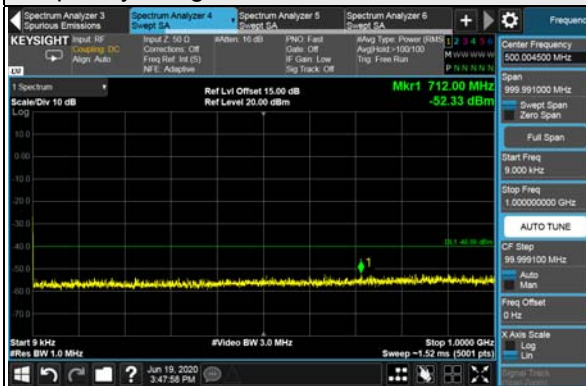

Frequency Range : 1GHz~18GHz

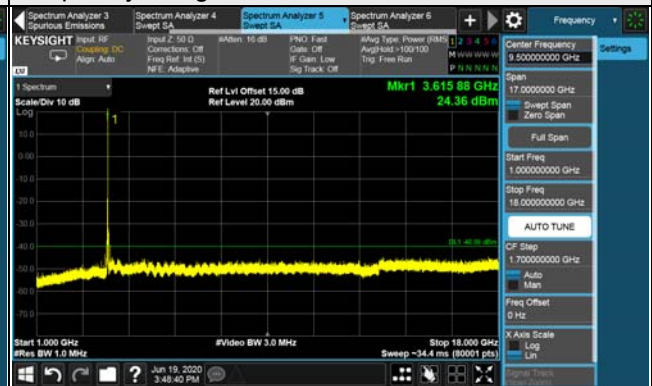

Frequency Range : 18GHz~40GHz

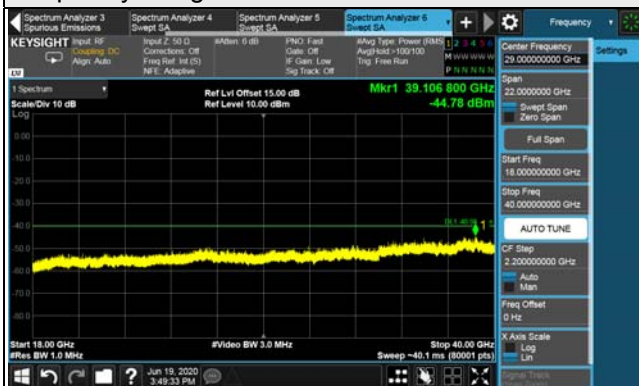

Note: The signal at 9 kHz is IF signal from spectrum analyzer.

LTE Band 48, Channel Bandwidth 20MHz

Channel 56640 (3690.0MHz)

Frequency Range : 9kHz~1GHz

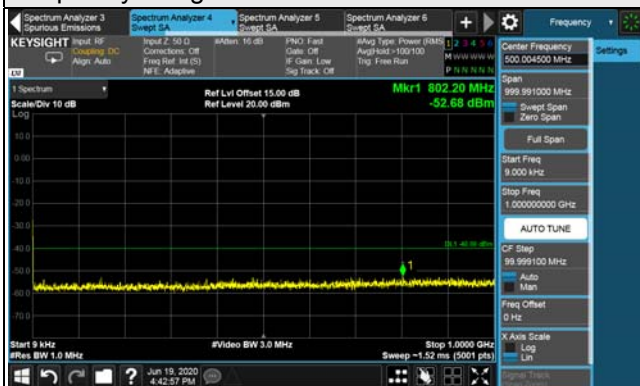

Frequency Range : 1GHz~18GHz

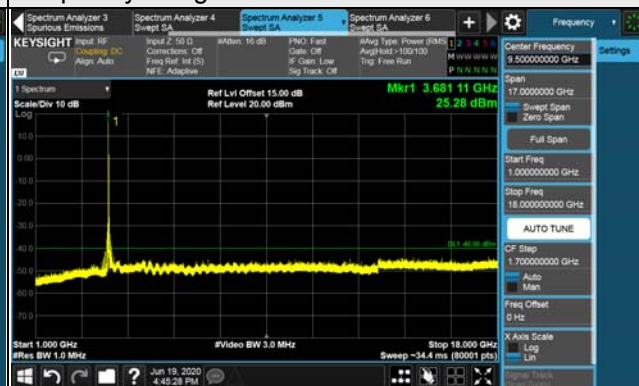

Frequency Range : 18GHz~40GHz

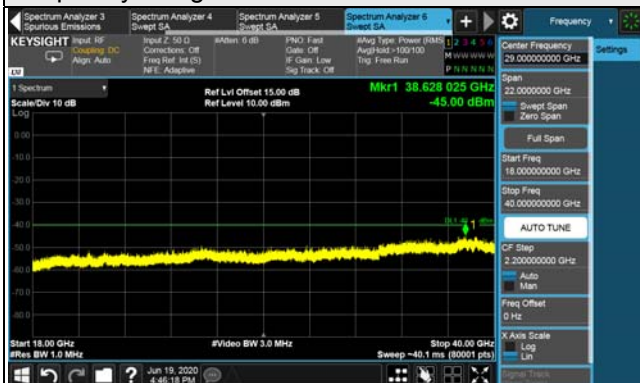

Note: The signal at 9 kHz is IF signal from spectrum analyzer.

4.7 Radiated Emission Measurement

4.7.1 Limits of Radiated Emission Measurement

The power of any emissions below 3530 MHz or above 3720 MHz shall not exceed -40dBm/MHz.

4.7.2 Test Instruments

Tested date: Jul. 03, 2020

Description & Manufacturer	Model No.	Serial No.	Cal. Date	Cal. Due
Test Receiver KEYSIGHT	N9038A	MY55420137	Apr. 16, 2020	Apr. 15, 2021
Spectrum Analyzer ROHDE & SCHWARZ	FSP40	100039	Jun. 12, 2020	Jun. 11, 2021
Spectrum Analyzer ROHDE & SCHWARZ	FSW43	101582	Mar. 31, 2020	Mar. 30, 2021
BILOG Antenna SCHWARZBECK	VULB9168	9168-160	Nov. 07, 2019	Nov. 06, 2020
HORN Antenna SCHWARZBECK	BBHA 9120 D	9120D-1169	Nov. 24, 2019	Nov. 23, 2020
HORN Antenna SCHWARZBECK	BBHA 9170	BBHA9170241	Nov. 24, 2019	Nov. 23, 2020
Preamplifier Agilent (Below 1GHz)	8447D	2944A10638	Jul. 11, 2019	Jul. 10, 2020
Preamplifier Agilent (Above 1GHz)	8449B	3008A02367	Feb. 18, 2020	Feb. 17, 2021
RF signal cable HUBER+SUHNER&EMCI	SUCOFLEX 104 & EMC104-SM-SM80 00	CABLE-CH9-02 (248780+171006)	Jan. 18, 2020	Jan. 17, 2021
RF signal cable HUBER+SUHNER	SUCOFLEX 104	CABLE-CH9-(250795/4)	Jul. 11, 2019	Jul. 10, 2020
RF signal cable Woken	8D-FB	Cable-CH9-01	Jul. 30, 2019	Jul. 29, 2020
Software BV ADT	ADT_Radiated_ V7.6.15.9.5	NA	NA	NA
Antenna Tower EMCO	2070/2080	512.835.4684	NA	NA
Turn Table EMCO	2087-2.03	NA	NA	NA
Antenna Tower & Turn BV ADT	AT100	AT93021705	NA	NA
Turn Table BV ADT	TT100	TT93021705	NA	NA
Turn Table Controller BV ADT	SC100	SC93021705	NA	NA
Boresight Antenna Fixture	FBA-01	FBA-SIP01	NA	NA
Pre-amplifier (18GHz-40GHz) EMC	EMC184045B	980175	Sep. 05, 2019	Sep. 04, 2020
Temperature And Humidity Chamber TERCHY	HRM-120RF	931022	Dec. 12, 2019	Dec. 11, 2020
JFW 20dB attenuation	50HF-020-SMA	NA	NA	NA
True RMS Clamp Meter Fluke	325	31130711WS	Jun. 06, 2020	Jun. 05, 2021
AC Power Source EEC	6905S	1991553	NA	NA

- Note: 1. The calibration interval of the above test instruments is 12 months and the calibrations are traceable to NML/ROC and NIST/USA.
2. The test was performed in HwaYa Chamber 9.

4.7.3 Test Procedures

- a. Substitution method is used for EIRP measurement. In the semi-anechoic chamber, EUT placed on the 0.8m (below or equal 1 GHz) and/or 1.5 m (above 1 GHz) height of Turn Table, rotated the table around 360 degrees to search the maximum radiation power and receiver antenna shall be rotated vertical and horizontal polarization and moved height from 1m to 4m to find the maximum polar radiated power. The "Read Value" is the spectrum reading the maximum power value.
- b. The substitution antenna is substituted for EUT at the same position and signals generator export the CW signal to the substitution antenna via a TX cable. Rotated the Turn Table and moved receiving antenna to find the maximum radiation power. Adjust output power level of S.G to get a Value of spectrum reading equal to "Read Value" of step a. Record the power level of S.G
- c. $EIRP = \text{Output power level of S.G} - \text{TX cable loss} + \text{Antenna gain of substitution horn}$.
- d. ERP power can be calculated form EIRP power by subtracting the gain of dipole, $ERP \text{ power} = EIRP \text{ power} - 2.15dBi$.

Note: The resolution bandwidth of spectrum analyzer is 1 MHz and the video bandwidth is 3 MHz.

4.7.4 Deviation from Test Standard

No deviation.

4.7.5 Test Set Up

<Frequency Range below 1GHz>

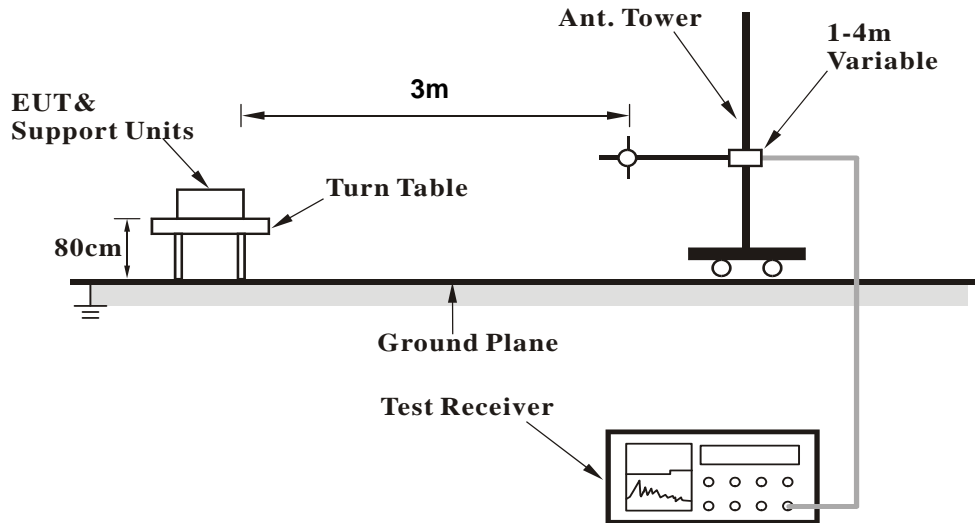

<Frequency Range above 1GHz>

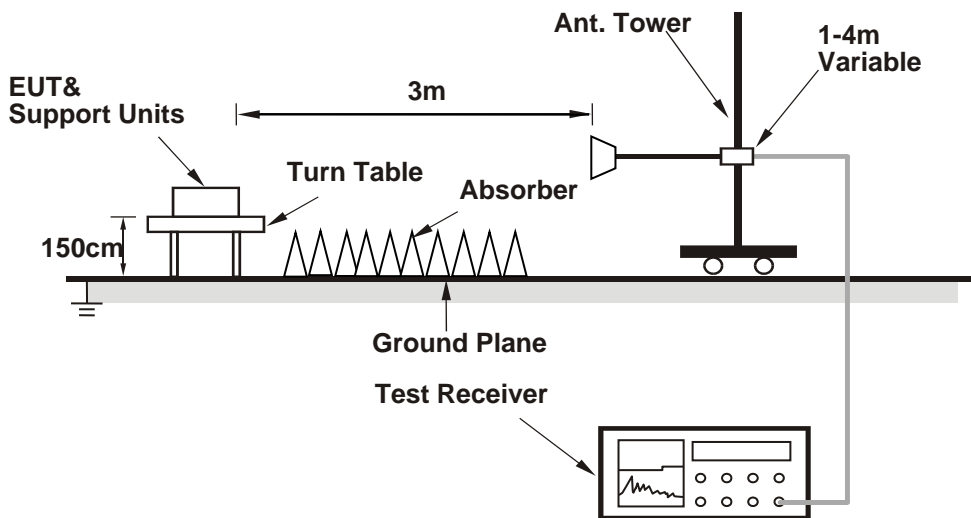

For the actual test configuration, please refer to the attached file (Test Setup Photo).

4.7.6 Test Results

Test was done with 50ohm terminator on antenna port.

Below 1GHz Data

LTE Band 48, Channel Bandwidth 20MHz

Mode	TX channel 56640 (3690.0MHz)	Frequency Range	Below 1000 MHz
Environmental Conditions	22deg. C, 66%RH	Input Power	120Vac, 60Hz
Tested By	Han Wu		

Antenna Polarity & Test Distance: Horizontal at 3 M							
No.	Freq. (MHz)	Reading (dBm)	S.G Power Value (dBm)	Correction Factor (dB)	EIRP (dBm)	Limit (dBm)	Margin (dB)
1	86.26	-40.6	-47.5	0.1	-47.4	-40.0	-7.4
2	97.90	-51.1	-58.4	-1.4	-59.8	-40.0	-19.8
3	111.48	-53.1	-58.3	-2.5	-60.8	-40.0	-20.8
4	134.76	-58.3	-61.1	-3.2	-64.3	-40.0	-24.3
5	266.68	-60.7	-63.4	-1.6	-65.0	-40.0	-25.0
6	621.70	-69.3	-71.0	3.7	-67.3	-40.0	-27.3

Remarks:

1. EIRP (dBm) = S.G Value (dBm) + Correction Factor (dB).
2. Correction Factor (dB) = Substitution Antenna Gain (dB) + Cable Loss (dB).

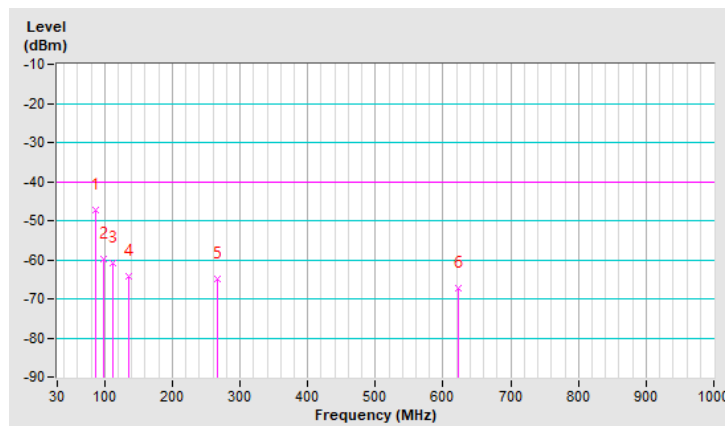

Mode	TX channel 55265 (3552.5MHz)	Frequency Range	Below 1000 MHz
Environmental Conditions	22deg. C, 66%RH	Input Power	120Vac, 60Hz
Tested By	Han Wu		

Antenna Polarity & Test Distance: Vertical at 3 M							
No.	Freq. (MHz)	Reading (dBm)	S.G Power Value (dBm)	Correction Factor (dB)	EIRP (dBm)	Limit (dBm)	Margin (dB)
1	92.08	-47.5	-53.8	-0.6	-54.4	-40.0	-14.4
2	169.68	-51.0	-51.4	-2.8	-54.2	-40.0	-14.2
3	194.90	-54.8	-53.3	-2.6	-55.9	-40.0	-15.9
4	243.40	-58.0	-58.0	-1.4	-59.4	-40.0	-19.4
5	274.44	-64.2	-59.8	-1.6	-61.4	-40.0	-21.4
6	317.12	-64.7	-68.8	4.1	-64.7	-40.0	-24.7

Remarks:

1. EIRP (dBm) = S.G Value (dBm) + Correction Factor (dB).
2. Correction Factor (dB) = Substitution Antenna Gain (dB) + Cable Loss (dB).

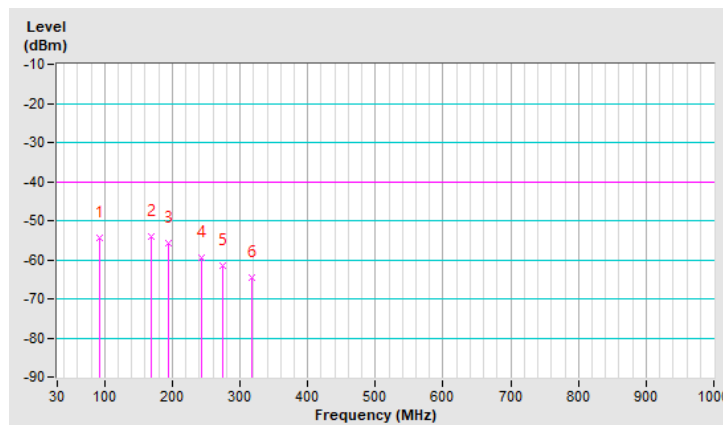

Above 1GHz

LTE Band 48, Channel Bandwidth 5MHz

Mode	TX channel 55265 (3552.5MHz)	Frequency Range	1GHz ~ 40GHz
Environmental Conditions	22deg. C, 66%RH	Input Power	120Vac, 60Hz
Tested By	Han Wu		

Antenna Polarity & Test Distance: Horizontal at 3 M							
No.	Freq. (MHz)	Reading (dBm)	S.G Power Value (dBm)	Correction Factor (dB)	EIRP (dBm)	Limit (dBm)	Margin (dB)
1	7105.00	-63.0	-44.9	0.7	-44.2	-40.0	-4.2
Antenna Polarity & Test Distance: Vertical at 3 M							
No.	Freq. (MHz)	Reading (dBm)	S.G Power Value (dBm)	Correction Factor (dB)	EIRP (dBm)	Limit (dBm)	Margin (dB)
1	7105.00	-64.3	-46.6	0.7	-45.9	-40.0	-5.9

Remarks:

1. EIRP (dBm) = S.G Value (dBm) + Correction Factor (dB).
2. Correction Factor (dB) = Substitution Antenna Gain (dB) + Cable Loss (dB).

Mode	TX channel 55990 (3625.0MHz)	Frequency Range	1GHz ~ 40GHz
Environmental Conditions	22deg. C, 66%RH	Input Power	120Vac, 60Hz
Tested By	Han Wu		

Antenna Polarity & Test Distance: Horizontal at 3 M							
No.	Freq. (MHz)	Reading (dBm)	S.G Power Value (dBm)	Correction Factor (dB)	EIRP (dBm)	Limit (dBm)	Margin (dB)
1	7250.00	-62.9	-45.1	0.9	-44.2	-40.0	-4.2
Antenna Polarity & Test Distance: Vertical at 3 M							
No.	Freq. (MHz)	Reading (dBm)	S.G Power Value (dBm)	Correction Factor (dB)	EIRP (dBm)	Limit (dBm)	Margin (dB)
1	7250.00	-64.0	-46.1	0.9	-45.2	-40.0	-5.2

Remarks:

1. EIRP (dBm) = S.G Value (dBm) + Correction Factor (dB).
2. Correction Factor (dB) = Substitution Antenna Gain (dB) + Cable Loss (dB).

Mode	TX channel 56715 (3697.5MHz)	Frequency Range	1GHz ~ 40GHz
Environmental Conditions	22deg. C, 66%RH	Input Power	120Vac, 60Hz
Tested By	Han Wu		

Antenna Polarity & Test Distance: Horizontal at 3 M							
No.	Freq. (MHz)	Reading (dBm)	S.G Power Value (dBm)	Correction Factor (dB)	EIRP (dBm)	Limit (dBm)	Margin (dB)
1	7395.00	-63.1	-44.5	0.9	-43.6	-40.0	-3.6
Antenna Polarity & Test Distance: Vertical at 3 M							
No.	Freq. (MHz)	Reading (dBm)	S.G Power Value (dBm)	Correction Factor (dB)	EIRP (dBm)	Limit (dBm)	Margin (dB)
1	7395.00	-64.0	-46.3	0.9	-45.4	-40.0	-5.4

Remarks:

1. EIRP (dBm) = S.G Value (dBm) + Correction Factor (dB).
2. Correction Factor (dB) = Substitution Antenna Gain (dB) + Cable Loss (dB).

LTE Band 48, Channel Bandwidth 20MHz

Mode	TX channel 55340 (3560.0MHz)	Frequency Range	1GHz ~ 40GHz
Environmental Conditions	22deg. C, 66%RH	Input Power	120Vac, 60Hz
Tested By	Han Wu		

Antenna Polarity & Test Distance: Horizontal at 3 M

No.	Freq. (MHz)	Reading (dBm)	S.G Power Value (dBm)	Correction Factor (dB)	EIRP (dBm)	Limit (dBm)	Margin (dB)
1	7120.00	-63.2	-45.2	0.7	-44.5	-40.0	-4.5

Antenna Polarity & Test Distance: Vertical at 3 M

No.	Freq. (MHz)	Reading (dBm)	S.G Power Value (dBm)	Correction Factor (dB)	EIRP (dBm)	Limit (dBm)	Margin (dB)
1	7120.00	-64.3	-46.6	0.7	-45.9	-40.0	-5.9

Remarks:

1. EIRP (dBm) = S.G Value (dBm) + Correction Factor (dB).
2. Correction Factor (dB) = Substitution Antenna Gain (dB) + Cable Loss (dB).

Mode	TX channel 55990 (3625.00MHz)	Frequency Range	1GHz ~ 40GHz
Environmental Conditions	22deg. C, 66%RH	Input Power	120Vac, 60Hz
Tested By	Han Wu		

Antenna Polarity & Test Distance: Horizontal at 3 M

No.	Freq. (MHz)	Reading (dBm)	S.G Power Value (dBm)	Correction Factor (dB)	EIRP (dBm)	Limit (dBm)	Margin (dB)
1	7250.00	-63.4	-45.6	0.9	-44.7	-40.0	-4.7

Antenna Polarity & Test Distance: Vertical at 3 M

No.	Freq. (MHz)	Reading (dBm)	S.G Power Value (dBm)	Correction Factor (dB)	EIRP (dBm)	Limit (dBm)	Margin (dB)
1	7250.00	-64.5	-46.6	0.9	-45.7	-40.0	-5.7

Remarks:

1. EIRP (dBm) = S.G Value (dBm) + Correction Factor (dB).
2. Correction Factor (dB) = Substitution Antenna Gain (dB) + Cable Loss (dB).

Mode	TX channel 56640 (3690.00MHz)	Frequency Range	1GHz ~ 40GHz
Environmental Conditions	22deg. C, 66%RH	Input Power	120Vac, 60Hz
Tested By	Han Wu		

Antenna Polarity & Test Distance: Horizontal at 3 M							
No.	Freq. (MHz)	Reading (dBm)	S.G Power Value (dBm)	Correction Factor (dB)	EIRP (dBm)	Limit (dBm)	Margin (dB)
1	7380.00	-62.7	-44.2	0.9	-43.3	-40.0	-3.3
Antenna Polarity & Test Distance: Vertical at 3 M							
No.	Freq. (MHz)	Reading (dBm)	S.G Power Value (dBm)	Correction Factor (dB)	EIRP (dBm)	Limit (dBm)	Margin (dB)
1	7380.00	-64.4	-46.7	0.9	-45.8	-40.0	-5.8

Remarks:

1. EIRP (dBm) = S.G Value (dBm) + Correction Factor (dB).
2. Correction Factor (dB) = Substitution Antenna Gain (dB) + Cable Loss (dB).

5 Pictures of Test Arrangements

Please refer to the attached file (Test Setup Photo).

Appendix – Information of the Testing Laboratories

We, Bureau Veritas Consumer Products Services (H.K.) Ltd., Taoyuan Branch, were founded in 1988 to provide our best service in EMC, Radio, Telecom and Safety consultation. Our laboratories are FCC recognized accredited test firms and accredited and approved according to ISO/IEC 17025.

If you have any comments, please feel free to contact us at the following:

Lin Kou EMC/RF Lab

Tel: 886-2-26052180

Fax: 886-2-26051924

Hsin Chu EMC/RF Lab/Telecom Lab

Tel: 886-3-6668565

Fax: 886-3-6668323

Hwa Ya EMC/RF/Safety Lab

Tel: 886-3-3183232

Fax: 886-3-3270892

Email: service.adt@tw.bureauveritas.com

Web Site: www.bureauveritas-adt.com

The address and road map of all our labs can be found in our web site also.

--- END ---