

FCC Test Report

Report No.: RF190319E02

FCC ID: NKR-LVSK-IDU

Test Model: LVSKIDU

Received Date: Mar. 19, 2019

Test Date: May 05 to 08, 2019

Issued Date: June 12, 2019

Applicant: Wistron NeWeb Corp.

Address: 20 Park Avenue II, Hsinchu Science Park, Hsinchu 308, Taiwan, R.O.C.

Issued By: Bureau Veritas Consumer Products Services (H.K.) Ltd., Taoyuan Branch
Hsin Chu Laboratory

Lab Address: E-2, No.1, Li Hsin 1st Road, Hsinchu Science Park, Hsinchu City 300,
Taiwan R.O.C.

Test Location: E-2, No.1, Li Hsin 1st Road, Hsinchu Science Park, Hsinchu City 300,
Taiwan R.O.C.

**FCC Registration /
Designation Number:** 723255 / TW2022



This report is for your exclusive use. Any copying or replication of this report to or for any other person or entity, or use of our name or trademark, is permitted only with our prior written permission. This report sets forth our findings solely with respect to the test samples identified herein. The results set forth in this report are not indicative or representative of the quality or characteristics of the lot from which a test sample was taken or any similar or identical product unless specifically and expressly noted. Our report includes all of the tests requested by you and the results thereof based upon the information that you provided to us. You have 60 days from date of issuance of this report to notify us of any material error or omission caused by our negligence, provided, however, that such notice shall be in writing and shall specifically address the issue you wish to raise. A failure to raise such issue within the prescribed time shall constitute your unqualified acceptance of the completeness of this report, the tests conducted and the correctness of the report contents. Unless specific mention, the uncertainty of measurement has been explicitly taken into account to declare the compliance or non-compliance to the specification. The report must not be used by the client to claim product certification, approval, or endorsement by TAF or any government agencies.

Table of Contents

Release Control Record	4
1 Certificate of Conformity	5
2 Summary of Test Results	6
2.1 Measurement Uncertainty	6
2.2 Modification Record	6
3 General Information	7
3.1 General Description of EUT	7
3.2 Description of Test Modes	9
3.2.1 Test Mode Applicability and Tested Channel Detail	10
3.3 Duty Cycle of Test Signal	12
3.4 Description of Support Units	14
3.4.1 Configuration of System under Test	15
3.5 General Description of Applied Standard	16
4 Test Types and Results	17
4.1 Radiated Emission and Bandedge Measurement.....	17
4.1.1 Limits of Radiated Emission and Bandedge Measurement	17
4.1.2 Test Instruments	18
4.1.3 Test Procedure	19
4.1.4 Deviation from Test Standard	19
4.1.5 Test Setup.....	20
4.1.6 EUT Operating Condition	21
4.1.7 Test Results	22
4.2 Conducted Emission Measurement	33
4.2.1 Limits of Conducted Emission Measurement	33
4.2.2 Test Instruments	33
4.2.3 Test Procedure	34
4.2.4 Deviation from Test Standard	34
4.2.5 Test Setup.....	34
4.2.6 EUT Operating Condition	34
4.2.7 Test Results	35
4.3 Transmit Power Measurement	37
4.3.1 Limits of Transmit Power Measurement	37
4.3.2 Test Setup.....	37
4.3.3 Test Instruments	37
4.3.4 Test Procedure	37
4.3.5 Deviation from Test Standard	37
4.3.6 EUT Operating Condition	37
4.3.7 Test Results	38
4.4 Occupied Bandwidth Measurement	42
4.4.1 Test Setup.....	42
4.4.2 Test Instruments	42
4.4.3 Test Procedure	42
4.4.4 Test Results	43
4.5 Peak Power Spectral Density Measurement	47
4.5.1 Limits of Peak Power Spectral Density Measurement	47
4.5.2 Test Setup.....	47
4.5.3 Test Instruments	47
4.5.4 Test Procedure	47
4.5.5 Deviation from Test Standard	47
4.5.6 EUT Operating Condition	47
4.5.7 Test Results	48
4.6 Frequency Stability Measurement	52
4.6.1 Limits of Frequency Stability Measurement	52

4.6.2 Test Setup.....	52
4.6.3 Test Instruments	52
4.6.4 Test Procedure	52
4.6.5 Deviation from Test Standard	52
4.6.6 EUT Operating Condition	52
4.6.7 Test Results	53
4.7 6dB Bandwidth Measurement.....	54
4.7.1 Limits of 6dB Bandwidth Measurement.....	54
4.7.2 Test Setup.....	54
4.7.3 Test Instruments	54
4.7.4 Test Procedure	54
4.7.5 Deviation from Test Standard	54
4.7.6 EUT Operating Condition	54
4.7.7 Test Results	55
5 Pictures of Test Arrangements.....	57
Annex A- Radiated Out of Band Emission (OOBE) Measurement (For U-NII-3 band).....	58
Appendix – Information of the Testing Laboratories	61

Release Control Record

Issue No.	Description	Date Issued
RF190319E02	Original release.	June 12, 2019

1 Certificate of Conformity

Product: LVSKIDU
Brand: WNC
Test Model: LVSKIDU
Sample Status: ENGINEERING SAMPLE
Applicant: Wistron NeWeb Corp.
Test Date: May 05 to 08, 2019
Standard: 47 CFR FCC Part 15, Subpart E (Section 15.407)
ANSI C63.10: 2013

The above equipment has been tested by **Bureau Veritas Consumer Products Services (H.K.) Ltd., Taoyuan Branch**, and found compliance with the requirement of the above standards. The test record, data evaluation & Equipment Under Test (EUT) configurations represented herein are true and accurate accounts of the measurements of the sample's EMC characteristics under the conditions specified in this report.

Prepared by : Phoenix Huang , **Date:** June 12, 2019
Phoenix Huang / Specialist

Approved by : May Chen , **Date:** June 12, 2019
May Chen / Manager

2 Summary of Test Results

47 CFR FCC Part 15, Subpart E (Section 15.407)			
FCC Clause	Test Item	Result	Remarks
15.407(b)(6)	AC Power Conducted Emissions	Pass	Meet the requirement of limit. Minimum passing margin is -24.64dB at 0.40000MHz.
15.407(b) (1/2/3/4(i/ii)/6)	Radiated Emissions & Band Edge Measurement*	Pass	Meet the requirement of limit. Minimum passing margin is -0.1dB at 11490.00MHz.
15.407(a)(1/2/3)	Max Average Transmit Power	Pass	Meet the requirement of limit.
---	Occupied Bandwidth Measurement	-	Reference only.
15.407(a)(1/2/3)	Peak Power Spectral Density	Pass	Meet the requirement of limit.
15.407(e)	6dB bandwidth	Pass	Meet the requirement of limit. (U-NII-3 Band only)
15.407(g)	Frequency Stability	Pass	Meet the requirement of limit.
15.203	Antenna Requirement	Pass	Antenna connector is i-pex(MHF) not a standard connector.

*For U-NII-3 band compliance with rule part 15.407(b)(4)(i), the OOB test plots were recorded in Annex A.

Note:

Determining compliance based on the results of the compliance measurement, not taking into account measurement instrumentation uncertainty.

2.1 Measurement Uncertainty

Where relevant, the following measurement uncertainty levels have been estimated for tests performed on the EUT as specified in CISPR 16-4-2:

Measurement	Frequency	Expanded Uncertainty (k=2) (±)
Conducted Emissions at mains ports	150kHz ~ 30MHz	1.8 dB
Radiated Emissions up to 1 GHz	30MHz ~ 1GHz	4.9 dB
Radiated Emissions above 1 GHz	1GHz ~ 6GHz	5.1 dB
	6GHz ~ 18GHz	4.9 dB
	18GHz ~ 40GHz	5.2 dB

2.2 Modification Record

There were no modifications required for compliance.

3 General Information

3.1 General Description of EUT

Product	LVSKIDU
Brand	WNC
Test Model	LVSKIDU
Status of EUT	ENGINEERING SAMPLE
Power Supply Rating	12Vdc from power adapter
Modulation Type	64QAM, 16QAM, QPSK, BPSK for OFDM 256QAM for OFDM in 11ac mode 1024QAM for OFDMA in 11ax HE mode
Modulation Technology	OFDM, OFDMA
Transfer Rate	802.11a: up to 54Mbps 802.11n: up to 600Mbps 802.11ac: up to 1733.3Mbps 802.11ax: up to 2401.9Mbps
Operating Frequency	5.745GHz ~ 5.825GHz
Number of Channel	802.11a, 802.11n (HT20), 802.11ac (VHT20), 802.11ax (HE20): 5 802.11n (HT40), 802.11ac (VHT40), 802.11ax (HE40): 2 802.11ac (VHT80), 802.11ax (HE80): 1
Output Power	Non-Beamforming Mode: 992.471mW Beamforming Mode: 992.471mW
Antenna Type	Refer to Note
Antenna Connector	Refer to Note
Accessory Device	Refer to Note
Data Cable Supplied	NA

Note:

1. The associated devices of EUT information are as below:

For LVSKIDU					
No.	Product	Brand	Model No.	Remark	
1	Adapter	DELTA	ADP-48GR B	Input: 100-240Vac, 1A, 50-60Hz AC input cable: Unshielded, 1.7m Output: 12Vdc, 4A DC output cable: Unshielded, 2.9m	
2	Battery Cradle	WNC	LVSKCRA	Battery Cradle Input: 12Vdc, 4A Battery Cradle Include Battery Battery Output: 3.6Vdc, 3450mAh, 12.42Wh	
For LVSKODU					
No.	Product	Brand	Model No.	FCC ID	Remark
3	LVSKODU	WNC	LVSKODU	NKR-LVSK-ODU	USB Cable (0.38m), shielded
4	LVPKROU	WNC	LVPK	-	Input: 56Vdc, 1.1A (power from POE Adpater)
5	POE Adpater	DELTA	ADP-60HR B	-	AC Input: 100-240V, 2.0A, 50-60Hz DC Output: 56Vdc, 1.1A AC input cable: Unshielded, 1.7m
6	Surge protection box	CITEL	CRMJ8-POE-C6	-	Metal case
7	Surge protection box	CITEL	CRMJ8-POE-C6/WNC	-	Plastic case

2. The antennas provided to the EUT, please refer to the following table:

Frequency (MHz)	5745		5785		5825		Antenna Type	Antenna Connector
	Directional Antenna Gain (dBi)							
Vertical-Pol	XZ	4.69	XZ	4.84	XZ	4.79	PCB	i-pex(MHF)
	YZ	2.93	YZ	2.60	YZ	2.49		
	XY	4.12	XY	4.08	XY	4.20		
Horizontal-pol	XZ	4.41	XZ	4.67	XZ	4.36	PCB	i-pex(MHF)
	YZ	1.24	YZ	1.43	YZ	1.51		
	XY	4.94	XY	5.09	XY	4.73		

Note: More detailed information, please refer to operating description.

3. The EUT was pre-tested under the following modes:

For Radiated Emission test	
Pre-test Mode	Description
Mode A	Power from adapter
Mode B	Power from Battery Cradle (Battery mode)
Mode C	Power from Battery Cradle (Adapter mode)

From the above modes, the worst case was found in **Mode A**. Therefore only the test data of the mode was recorded in this report.

For AC Power Conducted Emission test	
Pre-test Mode	Description
Mode D	Power from adapter
Mode E	Power from Battery Cradle (Adapter mode)

From the above modes, the worst case was found in **Mode D**. Therefore only the test data of the mode was recorded in this report.

4. The EUT incorporates a MIMO function:

MODULATION MODE	TX & RX CONFIGURATION	
802.11a	4TX	4RX
802.11n (HT20)	4TX	4RX
802.11n (HT40)	4TX	4RX
802.11ac (VHT20)	4TX	4RX
802.11ac (VHT40)	4TX	4RX
802.11ac (VHT80)	4TX	4RX
802.11ax (HE20)	4TX	4RX
802.11ax (HE40)	4TX	4RX
802.11ax (HE80)	4TX	4RX

Note:

- All of modulation mode support beamforming function except 802.11a modulation mode.
- The EUT support Beamforming and non-beamforming mode, therefore both mode were investigated and the worst case scenario was identified. The worst case data were presented in test report.
- The modulation and bandwidth are similar for 802.11n mode for 20MHz (40MHz) and 802.11ac mode for 20MHz (40MHz), therefore investigated worst case to representative mode in test report. (Final test mode refer section 3.2.1)

5. The above EUT information is declared by manufacturer and for more detailed features description, please refers to the manufacturer's specifications or user's manual.

3.2 Description of Test Modes

5 channels are provided for 802.11a, 802.11n (HT20), 802.11ac (VHT20), 802.11ax (HE20):

Channel	Frequency	Channel	Frequency
149	5745 MHz	161	5805 MHz
153	5765 MHz	165	5825 MHz
157	5785 MHz		

2 channels are provided for 802.11n (HT40), 802.11ac (VHT40), 802.11ax (HE40):

Channel	Frequency	Channel	Frequency
151	5755 MHz	159	5795 MHz

1 channel is provided for 802.11ac (VHT80), 802.11ax (HE80):

Channel	Frequency
155	5775 MHz

3.2.1 Test Mode Applicability and Tested Channel Detail

EUT Configure Mode	Applicable To				Description
	RE \geq 1G	RE $<$ 1G	PLC	APCM	
-	√	√	√	√	-

Where **RE \geq 1G**: Radiated Emission above 1GHz
RE $<$ 1G: Radiated Emission below 1GHz
PLC: Power Line Conducted Emission
APCM: Antenna Port Conducted Measurement

Radiated Emission Test (Above 1GHz):

- Pre-Scan has been conducted to determine the worst-case mode from all possible combinations between available modulations, data rates and antenna ports (if EUT with antenna diversity architecture).
- Following channel(s) was (were) selected for the final test as listed below.

Non-Beamforming Mode						
Mode	FREQ. Band (MHz)	Available Channel	Tested Channel	Modulation Technology	Modulation Type	Data Rate Parameter
802.11a	5745-5825	149 to 165	149, 157, 165	OFDM	BPSK	6Mb/s
802.11ax (HE20)		149 to 165	149, 157, 165	OFDMA	BPSK	MCS0
802.11ax (HE40)		151 to 159	151, 159	OFDMA	BPSK	MCS0
802.11ax (HE80)		155	155	OFDMA	BPSK	MCS0

Radiated Emission Test (Below 1GHz):

- Pre-Scan has been conducted to determine the worst-case mode from all possible combinations between available modulations, data rates and antenna ports (if EUT with antenna diversity architecture).
- Following channel(s) was (were) selected for the final test as listed below.

Non-Beamforming Mode						
Mode	FREQ. Band (MHz)	Available Channel	Tested Channel	Modulation Technology	Modulation Type	Data Rate Parameter
802.11ax (HE40)	5500-5720, 5745-5825	100 to 144, 149 to 165	159	OFDMA	BPSK	MCS0

Power Line Conducted Emission Test:

- Pre-Scan has been conducted to determine the worst-case mode from all possible combinations between available modulations, data rates and antenna ports (if EUT with antenna diversity architecture).
- Following channel(s) was (were) selected for the final test as listed below.

Non-Beamforming Mode						
Mode	FREQ. Band (MHz)	Available Channel	Tested Channel	Modulation Technology	Modulation Type	Data Rate Parameter
802.11ax (HE40)	5500-5720, 5745-5825	100 to 144, 149 to 165	159	OFDMA	BPSK	MCS0

Antenna Port Conducted Measurement:

- This item includes all test value of each mode, but only includes spectrum plot of worst value of each mode.
- Pre-Scan has been conducted to determine the worst-case mode from all possible combinations between available modulations, data rates and antenna ports (if EUT with antenna diversity architecture).
- Following channel(s) was (were) selected for the final test as listed below. (802.11ac modulation mode test only for Power and power density test items)

Non-Beamforming Mode						
Mode	FREQ. Band (MHz)	Available Channel	Tested Channel	Modulation Technology	Modulation Type	Data Rate Parameter
802.11a	5745-5825	149 to 165	149, 157, 165	OFDM	BPSK	6Mb/s
802.11ac (VHT20)		149 to 165	149, 157, 165	OFDM	BPSK	MCS0
802.11ac (VHT40)		151 to 159	151, 159	OFDM	BPSK	MCS0
802.11ac (VHT80)		155	155	OFDM	BPSK	MCS0
802.11ax (HE20)		149 to 165	149, 157, 165	OFDMA	BPSK	MCS0
802.11ax (HE40)		151 to 159	151, 159	OFDMA	BPSK	MCS0
802.11ax (HE80)		155	155	OFDMA	BPSK	MCS0
Beamforming Mode (output power only)						
Mode	FREQ. Band (MHz)	Available Channel	Tested Channel	Modulation Technology	Modulation Type	Data Rate Parameter
802.11ac (VHT20)	5745-5825	149 to 165	149, 157, 165	OFDM	BPSK	MCS0
802.11ac (VHT40)		151 to 159	151, 159	OFDM	BPSK	MCS0
802.11ac (VHT80)		155	155	OFDM	BPSK	MCS0
802.11ax (HE20)		149 to 165	149, 157, 165	OFDMA	BPSK	MCS0
802.11ax (HE40)		151 to 159	151, 159	OFDMA	BPSK	MCS0
802.11ax (HE80)		155	155	OFDMA	BPSK	MCS0

Test Condition:

Applicable To	Environmental Conditions	Input Power	Tested By
RE \geq 1G	25deg. C, 65%RH	120Vac, 60Hz	Andy Ho
RE<1G	21deg. C, 70%RH	120Vac, 60Hz	Ryan Chen
PLC	24deg. C, 75%RH	120Vac, 60Hz	Andy Ho
APCM	25deg. C, 60%RH	120Vac, 60Hz	Anderson Chen

3.3 Duty Cycle of Test Signal

Duty cycle of test signal is < 98%, duty factor shall be considered.

802.11a: Duty cycle = 1.426 ms/1.784 ms = 0.799, Duty factor = $10 \cdot \log(1/\text{Duty cycle}) = 0.97$
 802.11ac (VHT20): Duty cycle = 5.402 ms/5.747 ms = 0.94, Duty factor = $10 \cdot \log(1/\text{Duty cycle}) = 0.27$
 802.11ac (VHT40): Duty cycle = 5.413 ms/5.733 ms = 0.944, Duty factor = $10 \cdot \log(1/\text{Duty cycle}) = 0.25$
 802.11ac (VHT80): Duty cycle = 5.423 ms/5.643 ms = 0.961, Duty factor = $10 \cdot \log(1/\text{Duty cycle}) = 0.17$

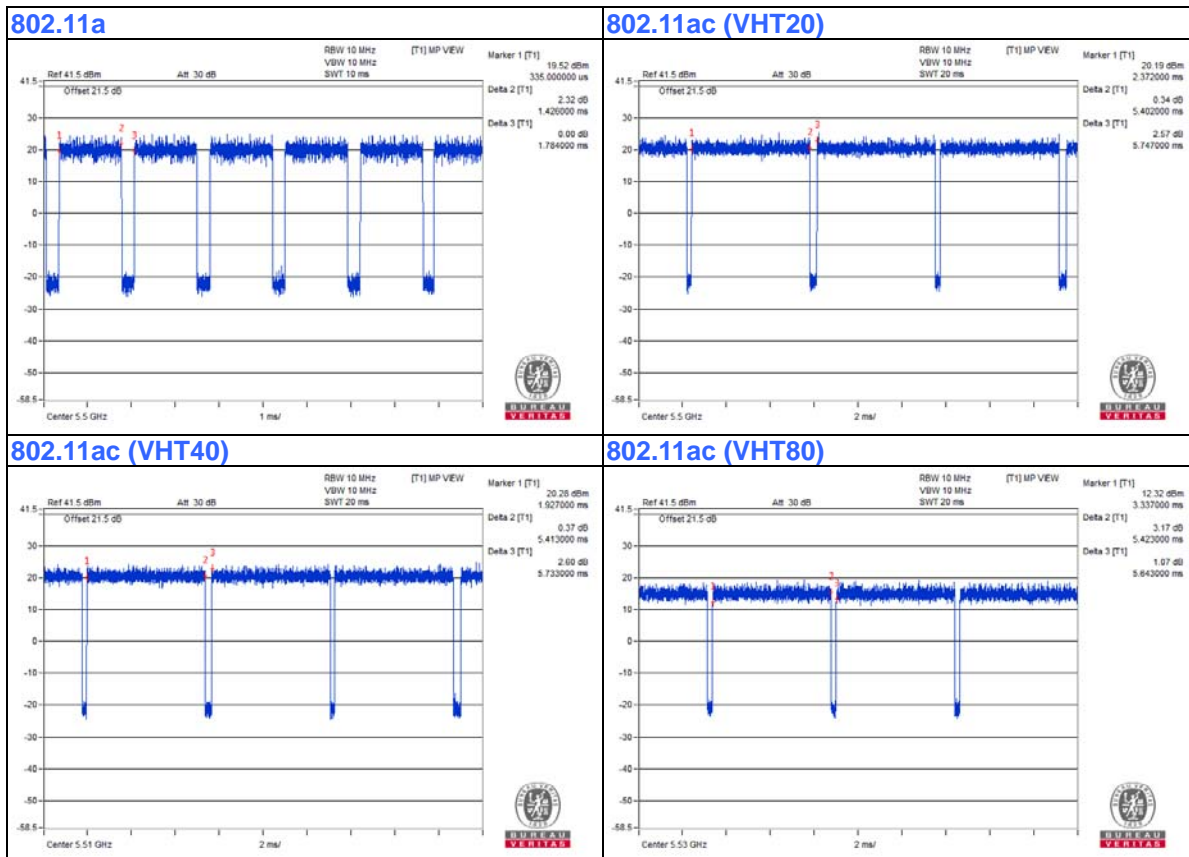

Duty cycle of test signal is < 98%, duty factor shall be considered.

802.11ax (HE20): Duty cycle = 5.441 ms/5.721 ms = 0.951, Duty factor = $10 * \log (1/\text{Duty cycle}) = 0.22$

802.11ax (HE40): Duty cycle = 5.431 ms/5.708 ms = 0.951, Duty factor = $10 * \log (1/\text{Duty cycle}) = 0.22$

802.11ax (HE80): Duty cycle = 5.437 ms/5.672 ms = 0.959, Duty factor = $10 * \log (1/\text{Duty cycle}) = 0.18$

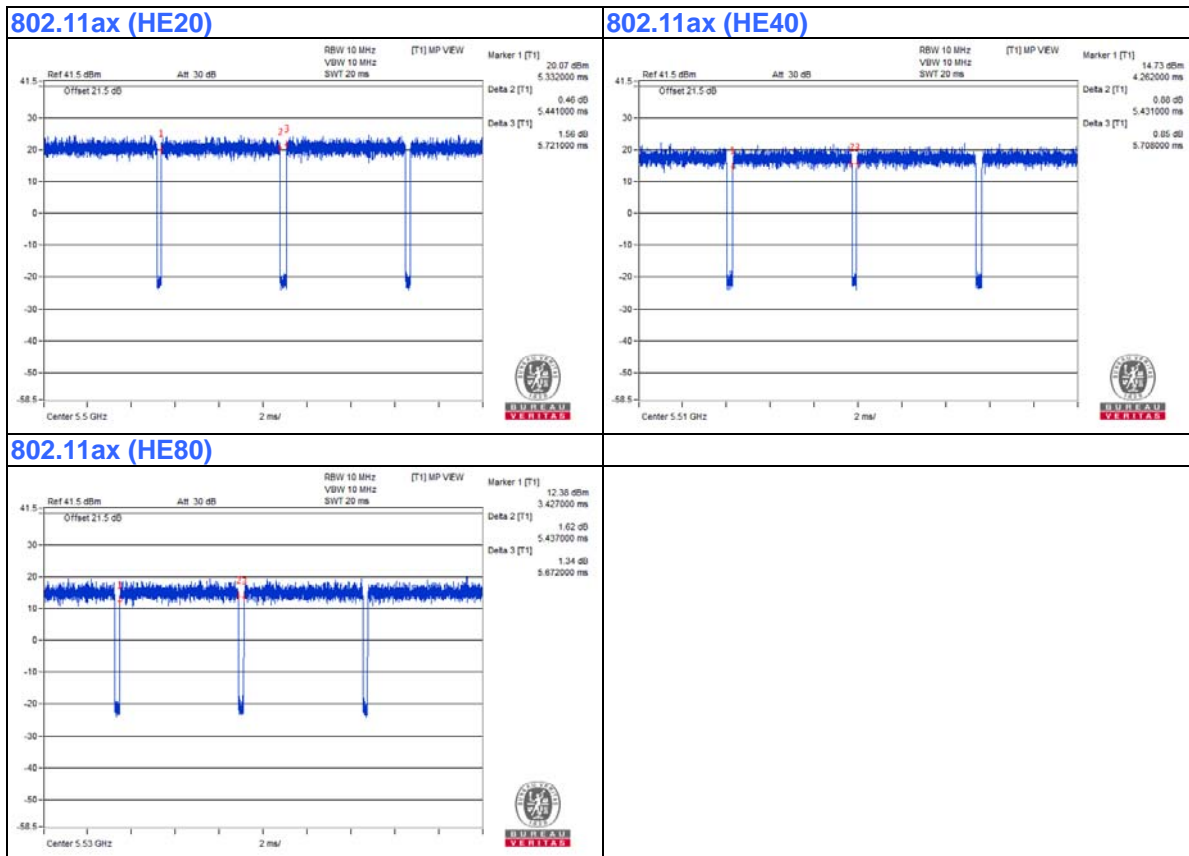

3.4 Description of Support Units

The EUT has been tested as an independent unit together with other necessary accessories or support units. The following support units or accessories were used to form a representative test configuration during the tests.

ID	Product	Brand	Model No.	Serial No.	FCC ID	Remarks
A.	Laptop	DELL	E6420	B92T3R1	FCC DoC	Provided by Lab

Note:

- All power cords of the above support units are non-shielded (1.8m).

ID	Descriptions	Qty.	Length (m)	Shielding (Yes/No)	Cores (Qty.)	Remarks
1.	AC Cable	1	1.7	No	0	Supplied by client
2.	DC Cable	1	2.9	No	0	Supplied by client
3.	RJ-45 Cable	1	10	No	0	Provided by Lab
4.	USB Type C Cable	1	0.4	No	0	Supplied by client
5.	GND Cable	1	3	No	0	Provided by Lab

3.4.1 Configuration of System under Test

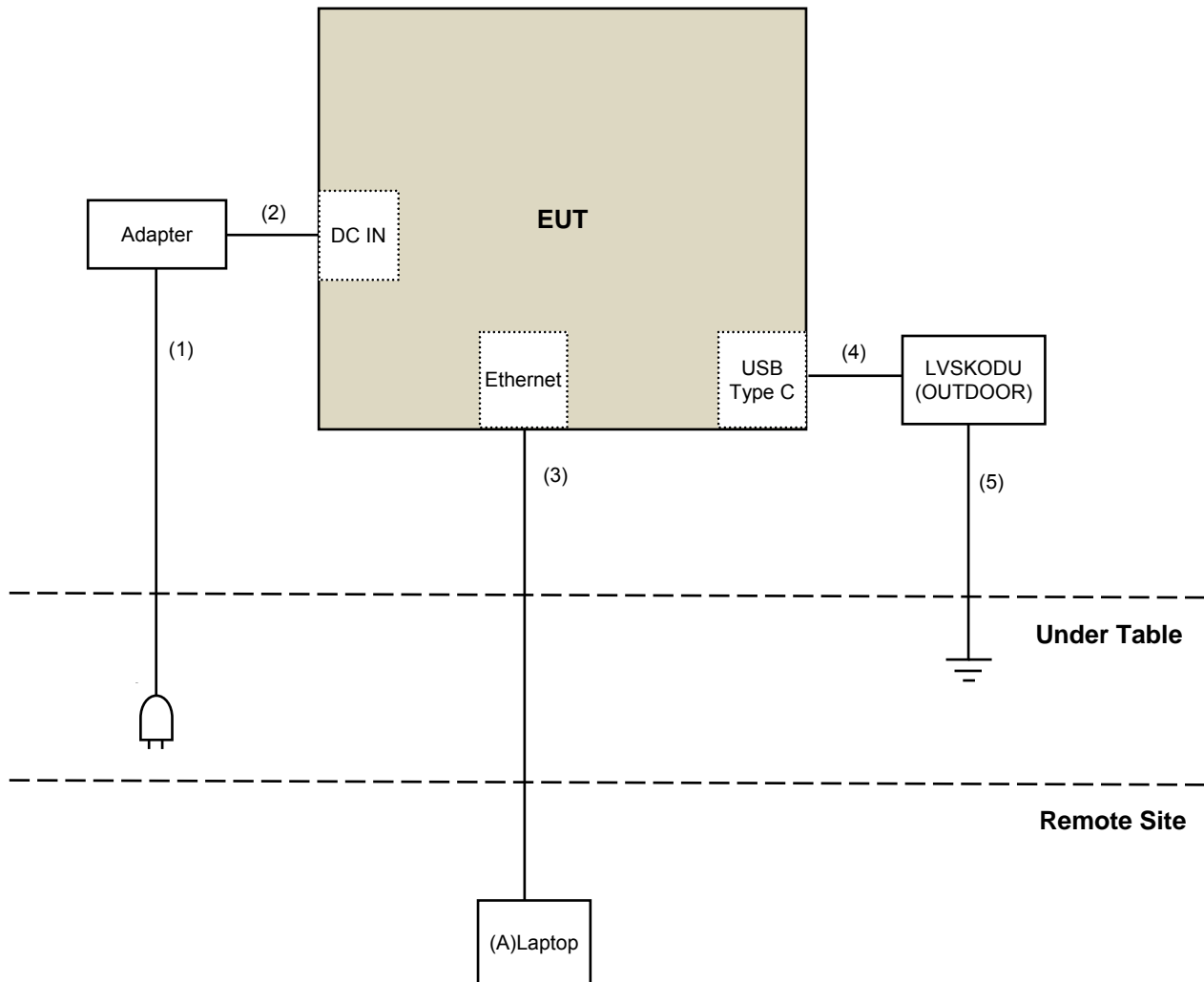

3.5 General Description of Applied Standard

The EUT is a RF Product. According to the specifications of the manufacturer, it must comply with the requirements of the following standards:

FCC Part 15, Subpart E (15.407)

KDB 789033 D02 General UNII Test Procedure New Rules v02r01

KDB 662911 D01 Multiple Transmitter Output v02r01

ANSI C63.10-2013

All test items have been performed and recorded as per the above standards.

4 Test Types and Results

4.1 Radiated Emission and Bandedge Measurement

4.1.1 Limits of Radiated Emission and Bandedge Measurement

Radiated emissions which fall in the restricted bands must comply with the radiated emission limits specified as below table.

Frequencies (MHz)	Field Strength (microvolts/meter)	Measurement Distance (meters)
0.009 ~ 0.490	2400/F(kHz)	300
0.490 ~ 1.705	24000/F(kHz)	30
1.705 ~ 30.0	30	30
30 ~ 88	100	3
88 ~ 216	150	3
216 ~ 960	200	3
Above 960	500	3

NOTE:

1. The lower limit shall apply at the transition frequencies.
2. Emission level (dBuV/m) = 20 log Emission level (uV/m).
3. For frequencies above 1000MHz, the field strength limits are based on average detector, however, the peak field strength of any emission shall not exceed the maximum permitted average limits, specified above by more than 20dB under any condition of modulation.

Limits of unwanted emission out of the restricted bands

Applicable To		Limit	
789033 D02 General UNII Test Procedure New Rules v02r01		Field Strength at 3m	
		PK:74 (dBuV/m)	AV:54 (dBuV/m)
Frequency Band	Applicable To	EIRP Limit	Equivalent Field Strength at 3m
5150~5250 MHz	15.407(b)(1)	PK:-27 (dBm/MHz)	PK:68.2(dBuV/m)
5250~5350 MHz	15.407(b)(2)		
5470~5725 MHz	15.407(b)(3)		
5725~5850 MHz	<input checked="" type="checkbox"/> 15.407(b)(4)(i)	PK:-27 (dBm/MHz) ^{*1} PK:10 (dBm/MHz) ^{*2} PK:15.6 (dBm/MHz) ^{*3} PK:27 (dBm/MHz) ^{*4}	PK: 68.2(dBuV/m) ^{*1} PK:105.2 (dBuV/m) ^{*2} PK: 110.8(dBuV/m) ^{*3} PK:122.2 (dBuV/m) ^{*4}
	<input type="checkbox"/> 15.407(b)(4)(ii)	Emission limits in section 15.247(d)	
*1 beyond 75 MHz or more above of the band edge.		*2 below the band edge increasing linearly to 10 dBm/MHz at 25 MHz above.	
*3 below the band edge increasing linearly to a level of 15.6 dBm/MHz at 5 MHz above.		*4 from 5 MHz above or below the band edge increasing linearly to a level of 27 dBm/MHz at the band edge.	

Note:

The following formula is used to convert the equipment isotropic radiated power (eirp) to field strength:

$$E = \frac{1000000\sqrt{30P}}{3} \mu\text{V/m, where } P \text{ is the eirp (Watts).}$$

4.1.2 Test Instruments

DESCRIPTION & MANUFACTURER	MODEL NO.	SERIAL NO.	CALIBRATED DATE	CALIBRATED UNTIL
Test Receiver Keysight	N9038A	MY54450088	July 05, 2018	July 04, 2019
Pre-Amplifier EMC1	EMC001340	980142	Jan. 25, 2019	Jan. 24, 2020
Loop Antenna Electro-Metrics	EM-6879	269	Sep. 07, 2018	Sep. 06, 2019
RF Cable	NA	LOOPCAB-001	Jan. 14, 2019	Jan. 13, 2020
RF Cable	NA	LOOPCAB-002	Jan. 14, 2019	Jan. 13, 2020
Pre-Amplifier Mini-Circuits	ZFL-1000VH2B	AMP-ZFL-01	Oct. 30, 2018	Oct. 29, 2019
Trilog Broadband Antenna SCHWARZBECK	VULB 9168	9168-406	Nov. 22, 2018	Nov. 21, 2019
RF Cable	8D	966-4-1	Mar. 19, 2019	Mar. 18, 2020
RF Cable	8D	966-4-2	Mar. 19, 2019	Mar. 18, 2020
RF Cable	8D	966-4-3	Mar. 19, 2019	Mar. 18, 2020
Fixed attenuator Mini-Circuits	UNAT-5+	PAD-3m-4-01	Sep. 27, 2018	Sep. 26, 2019
Horn_Antenna SCHWARZBECK	BBHA 9120D	9120D-783	Nov. 25, 2018	Nov. 24, 2019
Pre-Amplifier EMC1	EMC12630SE	980385	Aug. 16, 2018	Aug. 15, 2019
RF Cable	EMC104-SM-SM-1200	160923	Jan. 28, 2019	Jan. 27, 2020
RF Cable	104 RF cable	131215	Jan. 10, 2019	Jan. 09, 2020
RF Cable	EMC104-SM-SM-6000	180418	May 03, 2019	May 02, 2020
Pre-Amplifier EMC1	EMC184045SE	980387	Jan. 28, 2019	Jan. 27, 2020
Horn_Antenna SCHWARZBECK	BBHA 9170	BBHA9170519	Nov. 25, 2018	Nov. 24, 2019
RF Cable	EMC102-KM-KM-1200	160924	Jan. 28, 2019	Jan. 27, 2020
RF Cable	EMC102-KM-KM-1200	160925	Jan. 28, 2019	Jan. 27, 2020
Software	ADT_Radiated_V8.7.08	NA	NA	NA
Boresight Antenna Tower & Turn Table Max-Full	MF-7802BS	MF780208530	NA	NA
Spectrum Analyzer R&S	FSV40	100964	June 20, 2018	June 19, 2019
Power meter Anritsu	ML2495A	1014008	May 09, 2018	May 08, 2019
Power sensor Anritsu	MA2411B	0917122	May 09, 2018	May 08, 2019
Fixed Attenuator Mini-Circuits	MDCS18N-10	MDCS18N-10-01	Apr. 15, 2019	Apr. 14, 2020
AC Power Source Extech Electronics	6205	1440452	NA	NA
Temperature & Humidity Chamber Giant Force	GTH-150-40-SP-AR	MAA0812-008	Jan. 09, 2019	Jan. 08, 2020
True RMS Clamp Meter FLUKE	325	31130711WS	May 22, 2018	May 21, 2019

Note:

1. The calibration interval of the above test instruments is 12 months and the calibrations are traceable to NML/ROC and NIST/USA.
2. The test was performed in 966 Chamber No. 4.
3. Loop antenna was used for all emissions below 30 MHz.
4. Tested Date: May 05 to 07, 2019

4.1.3 Test Procedure

For Radiated emission below 30MHz

- a. The EUT was placed on the top of a rotating table 0.8 meters above the ground at a 3 meter chamber room. The table was rotated 360 degrees to determine the position of the highest radiation.
- b. The EUT was set 3 meters away from the interference-receiving antenna, which was mounted on the top of a variable-height antenna tower.
- c. Parallel, perpendicular, and ground-parallel orientations of the antenna are set to make the measurement.
- d. For each suspected emission, the EUT was arranged to its worst case and the rotatable table was turned from 0 degrees to 360 degrees to find the maximum reading.
- e. The test-receiver system was set to Quasi-Peak Detect Function and Specified Bandwidth with Maximum Hold Mode.

Note:

1. The resolution bandwidth and video bandwidth of test receiver/spectrum analyzer is 9kHz at frequency below 30MHz.

For Radiated emission above 30MHz

- a. The EUT was placed on the top of a rotating table 0.8 meters (for 30MHz ~ 1GHz) / 1.5 meters (for above 1GHz) above the ground at 3 meter chamber room for test. The table was rotated 360 degrees to determine the position of the highest radiation.
- b. The EUT was set 3 meters away from the interference-receiving antenna, which was mounted on the top of a variable-height antenna tower.
- c. The height of antenna is varied from one meter to four meters above the ground to determine the maximum value of the field strength. Both horizontal and vertical polarizations of the antenna are set to make the measurement.
- d. For each suspected emission, the EUT was arranged to its worst case and then the antenna was tuned to heights from 1 meter to 4 meters and the rotatable table was turned from 0 degrees to 360 degrees to find the maximum reading.
- e. The test-receiver system was set to quasi-peak detect function and specified bandwidth with maximum hold mode when the test frequency is below 1 GHz.
- f. The test-receiver system was set to peak and average detects function and specified bandwidth with maximum hold mode when the test frequency is above 1 GHz. If the peak reading value also meets average limit, measurement with the average detector is unnecessary.

Note:

1. The resolution bandwidth and video bandwidth of test receiver/spectrum analyzer is 120kHz for Quasi-peak detection (QP) at frequency below 1GHz.
2. The resolution bandwidth of test receiver/spectrum analyzer is 1 MHz and the video bandwidth is 3 MHz for Peak detection (PK) at frequency above 1GHz.
3. The resolution bandwidth of test receiver/spectrum analyzer is 1MHz and the video bandwidth is $\geq 1/T$ (Duty cycle $< 98\%$) or 10Hz (Duty cycle $\geq 98\%$) for Average detection (AV) at frequency above 1GHz.
4. All modes of operation were investigated and the worst-case emissions are reported.

4.1.4 Deviation from Test Standard

No deviation.

4.1.5 Test Setup

For Radiated emission below 30MHz

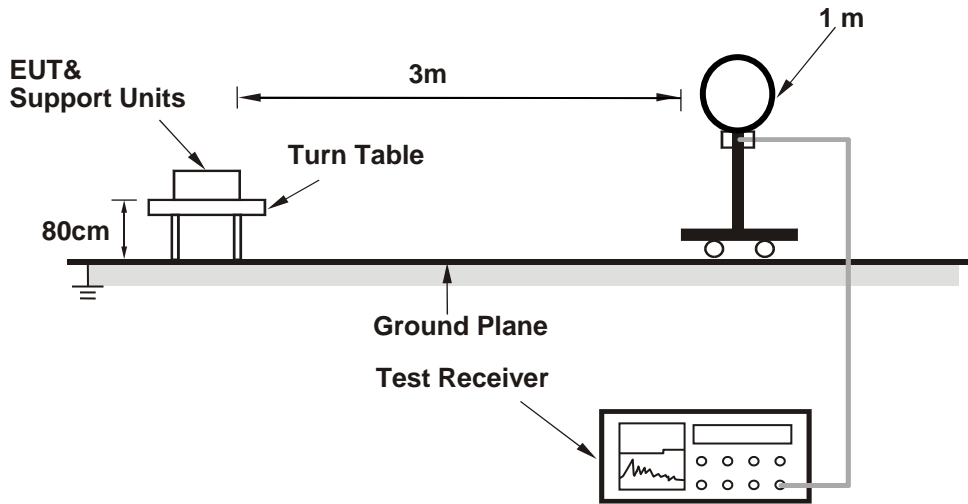

For Radiated emission 30MHz to 1GHz

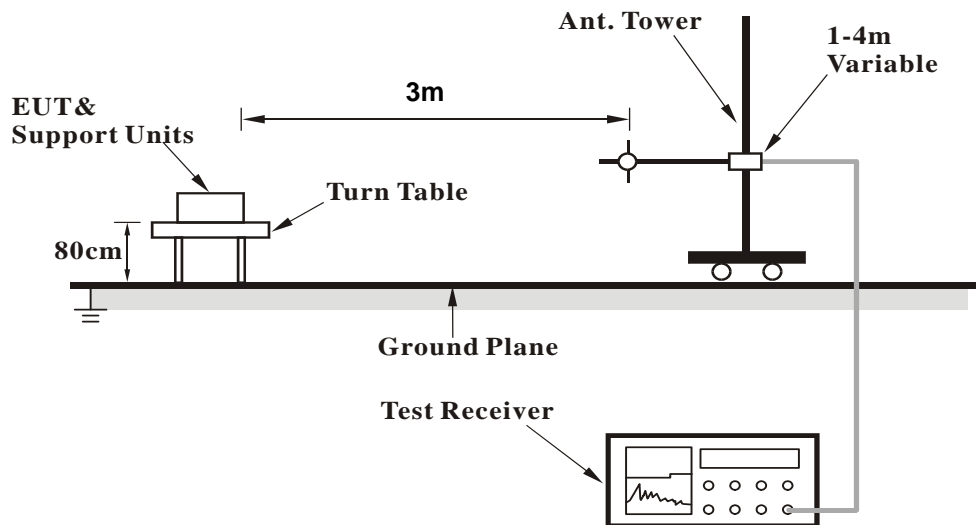

For Radiated emission above 1GHz

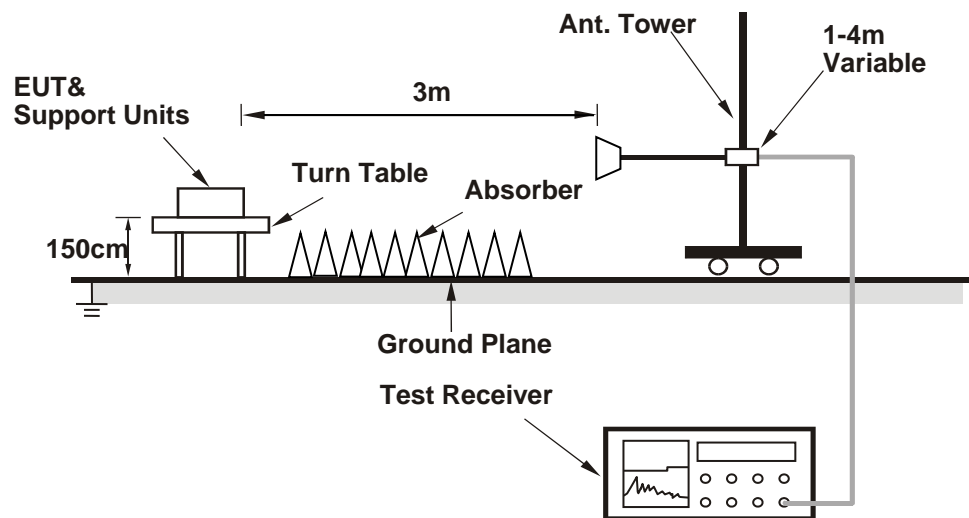

For the actual test configuration, please refer to the attached file (Test Setup Photo).

4.1.6 EUT Operating Condition

- a. Placed the EUT on the testing table.
- b. Controlling software (QSPR (5.0-00160)) has been activated to set the EUT under transmission condition continuously.

4.1.7 Test Results

Above 1GHz Data:

802.11a

CHANNEL	TX Channel 149	DETECTOR FUNCTION	Peak (PK)
FREQUENCY RANGE	1GHz ~ 40GHz		Average (AV)

ANTENNA POLARITY & TEST DISTANCE: HORIZONTAL AT 3 M

NO.	FREQ. (MHz)	EMISSION LEVEL (dBuV/m)	LIMIT (dBuV/m)	MARGIN (dB)	ANTENNA HEIGHT (m)	TABLE ANGLE (Degree)	RAW VALUE (dBuV)	CORRECTION FACTOR (dB/m)
1	#5596.10	59.8 PK	68.2	-8.4	1.90 H	260	56.9	2.9
2	*5745.00	122.5 PK			1.90 H	260	119.2	3.3
3	*5745.00	111.5 AV			1.90 H	260	108.2	3.3
4	#5971.18	61.0 PK	68.2	-7.2	1.90 H	260	57.4	3.6
5	11490.00	61.0 PK	74.0	-13.0	1.60 H	12	47.7	13.3
6	11490.00	48.5 AV	54.0	-5.5	1.60 H	12	35.2	13.3
7	#17235.00	50.4 PK	68.2	-17.8	2.05 H	188	33.9	16.5

ANTENNA POLARITY & TEST DISTANCE: VERTICAL AT 3 M

NO.	FREQ. (MHz)	EMISSION LEVEL (dBuV/m)	LIMIT (dBuV/m)	MARGIN (dB)	ANTENNA HEIGHT (m)	TABLE ANGLE (Degree)	RAW VALUE (dBuV)	CORRECTION FACTOR (dB/m)
1	#5644.66	59.9 PK	68.2	-8.3	2.88 V	183	57.0	2.9
2	*5745.00	121.0 PK			2.88 V	183	117.7	3.3
3	*5745.00	112.2 AV			2.88 V	183	108.9	3.3
4	#5974.92	58.4 PK	68.2	-9.8	2.88 V	183	54.8	3.6
5	11490.00	67.6 PK	74.0	-6.4	3.92 V	353	54.3	13.3
6	11490.00	53.5 AV	54.0	-0.5	3.92 V	353	40.2	13.3
7	#17235.00	50.7 PK	68.2	-17.5	1.18 V	315	34.2	16.5

REMARKS:

1. Emission Level(dBuV/m) = Raw Value(dBuV) + Correction Factor(dB/m)
2. Correction Factor(dB/m) = Antenna Factor(dB/m) + Cable Factor(dB) – Pre-Amplifier Factor(dB)
3. Margin value = Emission Level – Limit value
4. The other emission levels were very low against the limit.
5. " * ": Fundamental frequency.
6. " # ": The radiated frequency is out of the restricted band.

CHANNEL	TX Channel 157	DETECTOR FUNCTION	Peak (PK)
FREQUENCY RANGE	1GHz ~ 40GHz		Average (AV)

ANTENNA POLARITY & TEST DISTANCE: HORIZONTAL AT 3 M

NO.	FREQ. (MHz)	EMISSION LEVEL (dBuV/m)	LIMIT (dBuV/m)	MARGIN (dB)	ANTENNA HEIGHT (m)	TABLE ANGLE (Degree)	RAW VALUE (dBuV)	CORRECTION FACTOR (dB/m)
1	#5649.48	59.5 PK	68.2	-8.7	1.91 H	266	56.6	2.9
2	*5785.00	122.0 PK			1.91 H	266	118.6	3.4
3	*5785.00	110.7 AV			1.91 H	266	107.3	3.4
4	#5962.69	61.1 PK	68.2	-7.1	1.91 H	266	57.5	3.6
5	11570.00	61.7 PK	74.0	-12.3	1.58 H	11	48.7	13.0
6	11570.00	48.9 AV	54.0	-5.1	1.58 H	11	35.9	13.0
7	#17355.00	50.3 PK	68.2	-17.9	2.09 H	193	33.2	17.1

ANTENNA POLARITY & TEST DISTANCE: VERTICAL AT 3 M

NO.	FREQ. (MHz)	EMISSION LEVEL (dBuV/m)	LIMIT (dBuV/m)	MARGIN (dB)	ANTENNA HEIGHT (m)	TABLE ANGLE (Degree)	RAW VALUE (dBuV)	CORRECTION FACTOR (dB/m)
1	#5637.31	61.2 PK	68.2	-7.0	2.86 V	184	58.3	2.9
2	*5785.00	120.2 PK			2.86 V	184	116.8	3.4
3	*5785.00	112.0 AV			2.86 V	184	108.6	3.4
4	#5961.09	59.4 PK	68.2	-8.8	2.86 V	184	55.8	3.6
5	11570.00	67.3 PK	74.0	-6.7	3.91 V	353	54.3	13.0
6	11570.00	53.4 AV	54.0	-0.6	3.91 V	353	40.4	13.0
7	#17355.00	50.8 PK	68.2	-17.4	1.22 V	331	33.7	17.1

REMARKS:

1. Emission Level(dBuV/m) = Raw Value(dBuV) + Correction Factor(dB/m)
2. Correction Factor(dB/m) = Antenna Factor(dB/m) + Cable Factor(dB) – Pre-Amplifier Factor(dB)
3. Margin value = Emission Level – Limit value
4. The other emission levels were very low against the limit.
5. " * ": Fundamental frequency.
6. " # ": The radiated frequency is out of the restricted band.

CHANNEL	TX Channel 165	DETECTOR FUNCTION	Peak (PK)
FREQUENCY RANGE	1GHz ~ 40GHz		Average (AV)

ANTENNA POLARITY & TEST DISTANCE: HORIZONTAL AT 3 M

NO.	FREQ. (MHz)	EMISSION LEVEL (dBuV/m)	LIMIT (dBuV/m)	MARGIN (dB)	ANTENNA HEIGHT (m)	TABLE ANGLE (Degree)	RAW VALUE (dBuV)	CORRECTION FACTOR (dB/m)
1	#5595.84	59.7 PK	68.2	-8.5	2.21 H	203	56.8	2.9
2	*5825.00	121.4 PK			2.21 H	203	117.8	3.6
3	*5825.00	112.2 AV			2.21 H	203	108.6	3.6
4	#5974.09	61.3 PK	68.2	-6.9	2.21 H	203	57.7	3.6
5	11650.00	62.8 PK	74.0	-11.2	1.53 H	6	49.9	12.9
6	11650.00	51.5 AV	54.0	-2.5	1.53 H	6	38.6	12.9
7	#17475.00	51.4 PK	68.2	-16.8	2.09 H	203	33.0	18.4

ANTENNA POLARITY & TEST DISTANCE: VERTICAL AT 3 M

NO.	FREQ. (MHz)	EMISSION LEVEL (dBuV/m)	LIMIT (dBuV/m)	MARGIN (dB)	ANTENNA HEIGHT (m)	TABLE ANGLE (Degree)	RAW VALUE (dBuV)	CORRECTION FACTOR (dB/m)
1	#5626.15	59.8 PK	68.2	-8.4	2.85 V	185	56.9	2.9
2	*5825.00	120.2 PK			2.85 V	185	116.6	3.6
3	*5825.00	111.5 AV			2.85 V	185	107.9	3.6
4	#5925.86	60.7 PK	68.2	-7.5	2.85 V	185	57.1	3.6
5	11650.00	67.8 PK	74.0	-6.2	3.92 V	355	54.9	12.9
6	11650.00	53.6 AV	54.0	-0.4	3.92 V	355	40.7	12.9
7	#17475.00	50.2 PK	68.2	-18.0	1.20 V	340	31.8	18.4

REMARKS:

1. Emission Level(dBuV/m) = Raw Value(dBuV) + Correction Factor(dB/m)
2. Correction Factor(dB/m) = Antenna Factor(dB/m) + Cable Factor(dB) – Pre-Amplifier Factor(dB)
3. Margin value = Emission Level – Limit value
4. The other emission levels were very low against the limit.
5. " * ": Fundamental frequency.
6. " # ": The radiated frequency is out of the restricted band.

802.11ax (HE20)

CHANNEL	TX Channel 149	DETECTOR FUNCTION	Peak (PK)
FREQUENCY RANGE	1GHz ~ 40GHz		Average (AV)

ANTENNA POLARITY & TEST DISTANCE: HORIZONTAL AT 3 M

NO.	FREQ. (MHz)	EMISSION LEVEL (dBuV/m)	LIMIT (dBuV/m)	MARGIN (dB)	ANTENNA HEIGHT (m)	TABLE ANGLE (Degree)	RAW VALUE (dBuV)	CORRECTION FACTOR (dB/m)
1	#5601.44	59.6 PK	68.2	-8.6	2.80 H	208	56.6	3.0
2	*5745.00	123.5 PK			2.80 H	208	120.2	3.3
3	*5745.00	111.3 AV			2.80 H	208	108.0	3.3
4	#5996.44	60.2 PK	68.2	-8.0	2.80 H	208	56.6	3.6
5	11490.00	60.6 PK	74.0	-13.4	1.50 H	6	47.3	13.3
6	11490.00	48.9 AV	54.0	-5.1	1.50 H	6	35.6	13.3
7	#17235.00	49.8 PK	68.2	-18.4	1.50 H	6	33.3	16.5

ANTENNA POLARITY & TEST DISTANCE: VERTICAL AT 3 M

NO.	FREQ. (MHz)	EMISSION LEVEL (dBuV/m)	LIMIT (dBuV/m)	MARGIN (dB)	ANTENNA HEIGHT (m)	TABLE ANGLE (Degree)	RAW VALUE (dBuV)	CORRECTION FACTOR (dB/m)
1	#5642.47	61.1 PK	68.2	-7.1	2.64 V	173	58.2	2.9
2	*5745.00	122.9 PK			2.64 V	173	119.6	3.3
3	*5745.00	111.5 AV			2.64 V	173	108.2	3.3
4	#5956.29	59.1 PK	68.2	-9.1	2.64 V	173	55.5	3.6
5	11490.00	67.8 PK	74.0	-6.2	3.96 V	356	54.5	13.3
6	11490.00	53.9 AV	54.0	-0.1	3.96 V	356	40.6	13.3
7	#17235.00	51.1 PK	68.2	-17.1	1.18 V	311	34.6	16.5

REMARKS:

1. Emission Level(dBuV/m) = Raw Value(dBuV) + Correction Factor(dB/m)
2. Correction Factor(dB/m) = Antenna Factor(dB/m) + Cable Factor(dB) – Pre-Amplifier Factor(dB)
3. Margin value = Emission Level – Limit value
4. The other emission levels were very low against the limit.
5. " * ": Fundamental frequency.
6. " # ": The radiated frequency is out of the restricted band.

CHANNEL	TX Channel 157	DETECTOR FUNCTION	Peak (PK)
FREQUENCY RANGE	1GHz ~ 40GHz		Average (AV)

ANTENNA POLARITY & TEST DISTANCE: HORIZONTAL AT 3 M

NO.	FREQ. (MHz)	EMISSION LEVEL (dBuV/m)	LIMIT (dBuV/m)	MARGIN (dB)	ANTENNA HEIGHT (m)	TABLE ANGLE (Degree)	RAW VALUE (dBuV)	CORRECTION FACTOR (dB/m)
1	#5644.42	60.4 PK	68.2	-7.8	2.68 H	168	57.5	2.9
2	*5785.00	123.3 PK			2.68 H	168	119.9	3.4
3	*5785.00	112.9 AV			2.68 H	168	109.5	3.4
4	#5997.50	60.2 PK	68.2	-8.0	2.68 H	168	56.6	3.6
5	11570.00	61.0 PK	74.0	-13.0	1.56 H	15	48.0	13.0
6	11570.00	48.2 AV	54.0	-5.8	1.56 H	15	35.2	13.0
7	#17355.00	51.0 PK	68.2	-17.2	2.09 H	172	33.9	17.1

ANTENNA POLARITY & TEST DISTANCE: VERTICAL AT 3 M

NO.	FREQ. (MHz)	EMISSION LEVEL (dBuV/m)	LIMIT (dBuV/m)	MARGIN (dB)	ANTENNA HEIGHT (m)	TABLE ANGLE (Degree)	RAW VALUE (dBuV)	CORRECTION FACTOR (dB/m)
1	#5642.93	59.5 PK	68.2	-8.7	2.66 V	174	56.6	2.9
2	*5785.00	122.5 PK			2.66 V	174	119.1	3.4
3	*5785.00	111.4 AV			2.66 V	174	108.0	3.4
4	#5933.97	58.8 PK	68.2	-9.4	2.66 V	174	55.2	3.6
5	11570.00	67.4 PK	74.0	-6.6	3.93 V	1	54.4	13.0
6	11570.00	53.5 AV	54.0	-0.5	3.93 V	1	40.5	13.0
7	#17355.00	50.4 PK	68.2	-17.8	1.26 V	309	33.3	17.1

REMARKS:

1. Emission Level(dBuV/m) = Raw Value(dBuV) + Correction Factor(dB/m)
2. Correction Factor(dB/m) = Antenna Factor(dB/m) + Cable Factor(dB) – Pre-Amplifier Factor(dB)
3. Margin value = Emission Level – Limit value
4. The other emission levels were very low against the limit.
5. " * ": Fundamental frequency.
6. " # ": The radiated frequency is out of the restricted band.

CHANNEL	TX Channel 165	DETECTOR FUNCTION	Peak (PK)
FREQUENCY RANGE	1GHz ~ 40GHz		Average (AV)

ANTENNA POLARITY & TEST DISTANCE: HORIZONTAL AT 3 M

NO.	FREQ. (MHz)	EMISSION LEVEL (dBuV/m)	LIMIT (dBuV/m)	MARGIN (dB)	ANTENNA HEIGHT (m)	TABLE ANGLE (Degree)	RAW VALUE (dBuV)	CORRECTION FACTOR (dB/m)
1	#5617.77	59.8 PK	68.2	-8.4	2.58 H	170	56.8	3.0
2	*5825.00	123.9 PK			2.58 H	170	120.3	3.6
3	*5825.00	112.6 AV			2.58 H	170	109.0	3.6
4	#5928.10	61.1 PK	68.2	-7.1	2.58 H	170	57.5	3.6
5	11650.00	61.3 PK	74.0	-12.7	1.59 H	20	48.4	12.9
6	11650.00	48.8 AV	54.0	-5.2	1.59 H	20	35.9	12.9
7	#17475.00	50.5 PK	68.2	-17.7	2.07 H	172	32.1	18.4

ANTENNA POLARITY & TEST DISTANCE: VERTICAL AT 3 M

NO.	FREQ. (MHz)	EMISSION LEVEL (dBuV/m)	LIMIT (dBuV/m)	MARGIN (dB)	ANTENNA HEIGHT (m)	TABLE ANGLE (Degree)	RAW VALUE (dBuV)	CORRECTION FACTOR (dB/m)
1	#5632.02	59.3 PK	68.2	-8.9	2.62 V	175	56.4	2.9
2	*5825.00	122.3 PK			2.62 V	175	118.7	3.6
3	*5825.00	111.2 AV			2.62 V	175	107.6	3.6
4	#5928.85	60.1 PK	68.2	-8.1	2.62 V	175	56.5	3.6
5	11650.00	67.4 PK	74.0	-6.6	3.91 V	3	54.5	12.9
6	11650.00	53.4 AV	54.0	-0.6	3.91 V	3	40.5	12.9
7	#17475.00	50.9 PK	68.2	-17.3	1.15 V	324	32.5	18.4

REMARKS:

1. Emission Level(dBuV/m) = Raw Value(dBuV) + Correction Factor(dB/m)
2. Correction Factor(dB/m) = Antenna Factor(dB/m) + Cable Factor(dB) – Pre-Amplifier Factor(dB)
3. Margin value = Emission Level – Limit value
4. The other emission levels were very low against the limit.
5. " * ": Fundamental frequency.
6. " # ": The radiated frequency is out of the restricted band.

802.11ax (HE40)

CHANNEL	TX Channel 151	DETECTOR FUNCTION	Peak (PK)
FREQUENCY RANGE	1GHz ~ 40GHz		Average (AV)

ANTENNA POLARITY & TEST DISTANCE: HORIZONTAL AT 3 M

NO.	FREQ. (MHz)	EMISSION LEVEL (dBuV/m)	LIMIT (dBuV/m)	MARGIN (dB)	ANTENNA HEIGHT (m)	TABLE ANGLE (Degree)	RAW VALUE (dBuV)	CORRECTION FACTOR (dB/m)
1	#5579.88	60.8 PK	68.2	-7.4	2.60 H	155	57.9	2.9
2	*5755.00	119.5 PK			2.60 H	155	116.2	3.3
3	*5755.00	109.5 AV			2.60 H	155	106.2	3.3
4	#5971.35	60.3 PK	68.2	-7.9	2.60 H	155	56.7	3.6
5	11510.00	61.2 PK	74.0	-12.8	1.54 H	20	47.9	13.3
6	11510.00	48.5 AV	54.0	-5.5	1.54 H	20	35.2	13.3
7	#17265.00	51.1 PK	68.2	-17.1	2.06 H	165	34.7	16.4

ANTENNA POLARITY & TEST DISTANCE: VERTICAL AT 3 M

NO.	FREQ. (MHz)	EMISSION LEVEL (dBuV/m)	LIMIT (dBuV/m)	MARGIN (dB)	ANTENNA HEIGHT (m)	TABLE ANGLE (Degree)	RAW VALUE (dBuV)	CORRECTION FACTOR (dB/m)
1	#5639.06	60.1 PK	68.2	-8.1	2.51 V	189	57.2	2.9
2	*5755.00	121.0 PK			2.51 V	189	117.7	3.3
3	*5755.00	110.0 AV			2.51 V	189	106.7	3.3
4	#5965.77	57.8 PK	68.2	-10.4	2.51 V	189	54.2	3.6
5	11510.00	64.7 PK	74.0	-9.3	2.58 V	16	51.4	13.3
6	11510.00	52.2 AV	54.0	-1.8	2.58 V	16	38.9	13.3
7	#17265.00	50.8 PK	68.2	-17.4	1.24 V	315	34.4	16.4

REMARKS:

1. Emission Level(dBuV/m) = Raw Value(dBuV) + Correction Factor(dB/m)
2. Correction Factor(dB/m) = Antenna Factor(dB/m) + Cable Factor(dB) – Pre-Amplifier Factor(dB)
3. Margin value = Emission Level – Limit value
4. The other emission levels were very low against the limit.
5. " * ": Fundamental frequency.
6. " # ": The radiated frequency is out of the restricted band.

CHANNEL	TX Channel 159	DETECTOR FUNCTION	Peak (PK)
FREQUENCY RANGE	1GHz ~ 40GHz		Average (AV)

ANTENNA POLARITY & TEST DISTANCE: HORIZONTAL AT 3 M

NO.	FREQ. (MHz)	EMISSION LEVEL (dBuV/m)	LIMIT (dBuV/m)	MARGIN (dB)	ANTENNA HEIGHT (m)	TABLE ANGLE (Degree)	RAW VALUE (dBuV)	CORRECTION FACTOR (dB/m)
1	#5620.52	60.2 PK	68.2	-8.0	2.57 H	142	57.2	3.0
2	*5795.00	118.6 PK			2.57 H	142	115.2	3.4
3	*5795.00	108.7 AV			2.57 H	142	105.3	3.4
4	#5996.64	60.7 PK	68.2	-7.5	2.57 H	142	57.1	3.6
5	11590.00	61.3 PK	74.0	-12.7	1.55 H	10	48.4	12.9
6	11590.00	48.4 AV	54.0	-5.6	1.55 H	10	35.5	12.9
7	#17385.00	50.8 PK	68.2	-17.4	2.12 H	163	33.4	17.4

ANTENNA POLARITY & TEST DISTANCE: VERTICAL AT 3 M

NO.	FREQ. (MHz)	EMISSION LEVEL (dBuV/m)	LIMIT (dBuV/m)	MARGIN (dB)	ANTENNA HEIGHT (m)	TABLE ANGLE (Degree)	RAW VALUE (dBuV)	CORRECTION FACTOR (dB/m)
1	#5645.97	59.3 PK	68.2	-8.9	2.54 V	187	56.4	2.9
2	*5795.00	120.8 PK			2.54 V	187	117.4	3.4
3	*5795.00	109.9 AV			2.54 V	187	106.5	3.4
4	#5960.39	58.5 PK	68.2	-9.7	2.54 V	187	54.9	3.6
5	11590.00	64.0 PK	74.0	-10.0	3.88 V	349	51.1	12.9
6	11590.00	50.5 AV	54.0	-3.5	3.88 V	349	37.6	12.9
7	#17385.00	50.7 PK	68.2	-17.5	1.27 V	332	33.3	17.4

REMARKS:

1. Emission Level(dBuV/m) = Raw Value(dBuV) + Correction Factor(dB/m)
2. Correction Factor(dB/m) = Antenna Factor(dB/m) + Cable Factor(dB) – Pre-Amplifier Factor(dB)
3. Margin value = Emission Level – Limit value
4. The other emission levels were very low against the limit.
5. " * ": Fundamental frequency.
6. " # ": The radiated frequency is out of the restricted band.

802.11ax (HE80)

CHANNEL	TX Channel 155	DETECTOR FUNCTION	Peak (PK)
FREQUENCY RANGE	1GHz ~ 40GHz		Average (AV)

ANTENNA POLARITY & TEST DISTANCE: HORIZONTAL AT 3 M

NO.	FREQ. (MHz)	EMISSION LEVEL (dBuV/m)	LIMIT (dBuV/m)	MARGIN (dB)	ANTENNA HEIGHT (m)	TABLE ANGLE (Degree)	RAW VALUE (dBuV)	CORRECTION FACTOR (dB/m)
1	#5637.59	67.4 PK	68.2	-0.8	2.70 H	163	64.5	2.9
2	*5775.00	119.3 PK			2.70 H	163	116.0	3.3
3	*5775.00	106.9 AV			2.70 H	163	103.6	3.3
4	#5938.60	60.9 PK	68.2	-7.3	2.70 H	163	57.3	3.6
5	11550.00	61.0 PK	74.0	-13.0	1.54 H	12	48.0	13.0
6	11550.00	48.3 AV	54.0	-5.7	1.54 H	12	35.3	13.0
7	#17325.00	50.3 PK	68.2	-17.9	2.05 H	180	33.5	16.8

ANTENNA POLARITY & TEST DISTANCE: VERTICAL AT 3 M

NO.	FREQ. (MHz)	EMISSION LEVEL (dBuV/m)	LIMIT (dBuV/m)	MARGIN (dB)	ANTENNA HEIGHT (m)	TABLE ANGLE (Degree)	RAW VALUE (dBuV)	CORRECTION FACTOR (dB/m)
1	#5649.31	68.0 PK	68.2	-0.2	3.71 V	170	65.1	2.9
2	#5657.79	68.8 PK	74.0	-5.2	3.71 V	170	65.7	3.1
3	*5775.00	118.1 PK			3.71 V	170	114.8	3.3
4	*5775.00	106.6 AV			3.71 V	170	103.3	3.3
5	#5929.68	62.4 PK	68.2	-5.8	3.71 V	170	58.8	3.6
6	11550.00	64.5 PK	74.0	-9.5	3.94 V	356	51.5	13.0
7	11550.00	51.1 AV	54.0	-2.9	3.94 V	356	38.1	13.0
8	#17325.00	50.3 PK	68.2	-17.9	1.21 V	309	33.5	16.8

REMARKS:

1. Emission Level(dBuV/m) = Raw Value(dBuV) + Correction Factor(dB/m)
2. Correction Factor(dB/m) = Antenna Factor(dB/m) + Cable Factor(dB) – Pre-Amplifier Factor(dB)
3. Margin value = Emission Level – Limit value
4. The other emission levels were very low against the limit.
5. " * ": Fundamental frequency.
6. " # ": The radiated frequency is out of the restricted band.

Below 1GHz Data:

802.11ax (HE40)

CHANNEL	TX Channel 159	DETECTOR FUNCTION	Quasi-Peak (QP)
FREQUENCY RANGE	9kHz ~ 1GHz		

ANTENNA POLARITY & TEST DISTANCE: HORIZONTAL AT 3 M

NO.	FREQ. (MHz)	EMISSION LEVEL (dBuV/m)	LIMIT (dBuV/m)	MARGIN (dB)	ANTENNA HEIGHT (m)	TABLE ANGLE (Degree)	RAW VALUE (dBuV)	CORRECTION FACTOR (dB/m)
1	30.92	26.4 QP	40.0	-13.6	1.00 H	279	36.1	-9.7
2	99.69	31.0 QP	43.5	-12.5	4.00 H	126	43.0	-12.0
3	179.28	26.0 QP	43.5	-17.5	3.00 H	268	35.2	-9.2
4	256.52	24.8 QP	46.0	-21.2	1.00 H	306	33.3	-8.5
5	311.81	31.5 QP	46.0	-14.5	1.00 H	321	38.1	-6.6
6	625.90	30.6 QP	46.0	-15.4	3.00 H	84	29.5	1.1

REMARKS:

1. Emission Level(dBuV/m) = Raw Value(dBuV) + Correction Factor(dB/m)
2. Correction Factor(dB/m) = Antenna Factor(dB/m) + Cable Factor(dB) – Pre-Amplifier Factor(dB)
3. Margin value = Emission Level – Limit value
4. The other emission levels were very low against the limit of frequency range 30MHz~1000MHz.
5. The emission levels were very low against the limit of frequency range 9kHz~30MHz: the amplitude of spurious emissions attenuated more than 20 dB below the permissible value to be report.

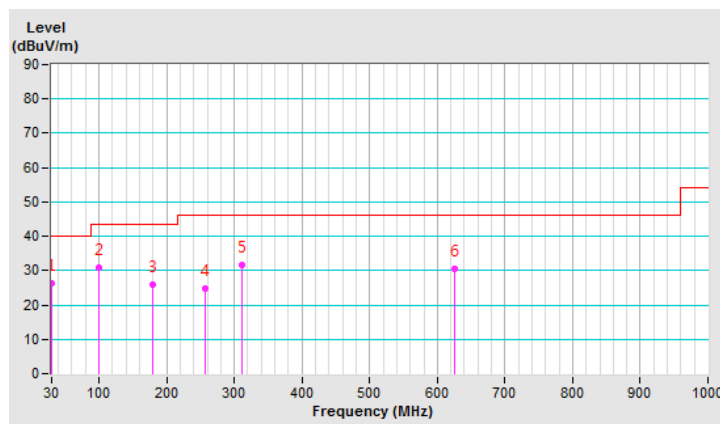

CHANNEL	TX Channel 159	DETECTOR FUNCTION	Quasi-Peak (QP)
FREQUENCY RANGE	9kHz ~ 1GHz		

ANTENNA POLARITY & TEST DISTANCE: VERTICAL AT 3 M								
NO.	FREQ. (MHz)	EMISSION LEVEL (dBuV/m)	LIMIT (dBuV/m)	MARGIN (dB)	ANTENNA HEIGHT (m)	TABLE ANGLE (Degree)	RAW VALUE (dBuV)	CORRECTION FACTOR (dB/m)
1	39.65	32.4 QP	40.0	-7.6	1.00 V	357	41.1	-8.7
2	82.74	28.1 QP	40.0	-11.9	1.50 V	0	41.4	-13.3
3	124.99	26.0 QP	43.5	-17.5	1.00 V	211	35.4	-9.4
4	203.24	24.0 QP	43.5	-19.5	1.00 V	225	34.3	-10.3
5	312.12	27.7 QP	46.0	-18.3	2.00 V	360	34.3	-6.6
6	576.04	27.9 QP	46.0	-18.1	3.00 V	0	28.0	-0.1

REMARKS:

1. Emission Level(dBuV/m) = Raw Value(dBuV) + Correction Factor(dB/m)
2. Correction Factor(dB/m) = Antenna Factor(dB/m) + Cable Factor(dB) – Pre-Amplifier Factor(dB)
3. Margin value = Emission Level – Limit value
4. The other emission levels were very low against the limit of frequency range 30MHz~1000MHz.
5. The emission levels were very low against the limit of frequency range 9kHz~30MHz: the amplitude of spurious emissions attenuated more than 20 dB below the permissible value to be report.

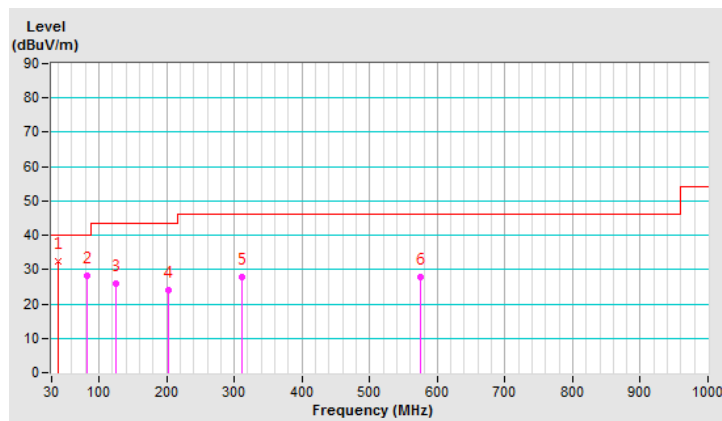

4.2 Conducted Emission Measurement

4.2.1 Limits of Conducted Emission Measurement

Frequency (MHz)	Conducted Limit (dBuV)	
	Quasi-peak	Average
0.15 - 0.5	66 - 56	56 - 46
0.50 - 5.0	56	46
5.0 - 30.0	60	50

Note: 1. The lower limit shall apply at the transition frequencies.

2. The limit decreases in line with the logarithm of the frequency in the range of 0.15 to 0.50MHz.

4.2.2 Test Instruments

DESCRIPTION & MANUFACTURER	MODEL NO.	SERIAL NO.	CALIBRATED DATE	CALIBRATED UNTIL
Test Receiver R&S	ESCS 30	847124/029	Oct. 24, 2018	Oct. 23, 2019
Line-Impedance Stabilization Network (for EUT) R&S	ESH3-Z5	848773/004	Oct. 22, 2018	Oct. 21, 2019
Line-Impedance Stabilization Network (for Peripheral) R&S	ESH3-Z5	835239/001	Mar. 17, 2019	Mar. 16, 2020
50 ohms Terminator	N/A	3	Oct. 22, 2018	Oct. 21, 2019
RF Cable	5D-FB	COCCAB-001	Sep. 28, 2018	Sep. 27, 2019
Fixed attenuator EMCI	STI02-2200-10	003	Mar. 14, 2019	Mar. 13, 2020
Software BVADT	BVADT_Cond_V7.3.7.4	NA	NA	NA

Note:

1. The calibration interval of the above test instruments are 12 months and the calibrations are traceable to NML/ROC and NIST/USA.
2. The test was performed in Conduction 1.
3. Tested Date: May 08, 2019

4.2.3 Test Procedure

- The EUT was placed 0.4 meters from the conducting wall of the shielded room with EUT being connected to the power mains through a line impedance stabilization network (LISN). Other support units were connected to the power mains through another LISN. The two LISNs provide 50 ohm/ 50uH of coupling impedance for the measuring instrument.
- Both lines of the power mains connected to the EUT were checked for maximum conducted interference.
- The frequency range from 150kHz to 30MHz was searched. Emission levels under (Limit - 20dB) was not recorded.

Note: All modes of operation were investigated and the worst-case emissions are reported.

4.2.4 Deviation from Test Standard

No deviation.

4.2.5 Test Setup

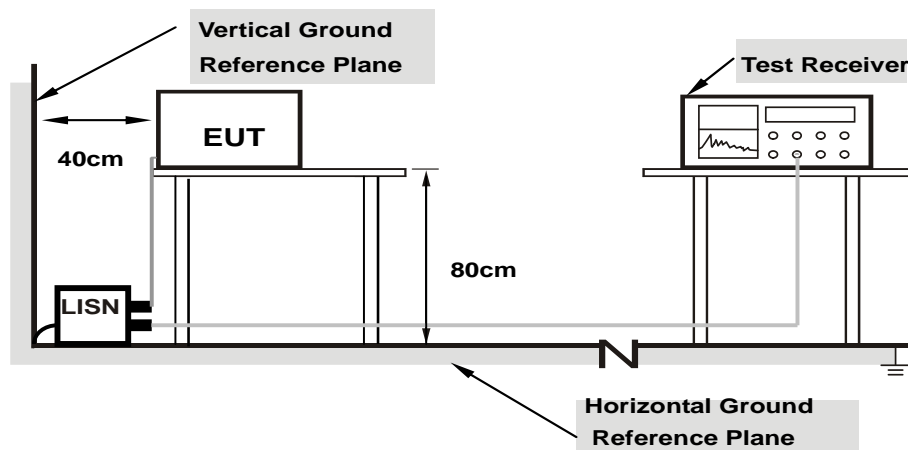

Note: 1.Support units were connected to second LISN.

For the actual test configuration, please refer to the attached file (Test Setup Photo).

4.2.6 EUT Operating Condition

Same as 4.1.6.

4.2.7 Test Results

Phase	Line (L)	Detector Function	Quasi-Peak (QP) / Average (AV)
-------	----------	-------------------	--------------------------------

No	Freq. [MHz]	Corr. Factor	Reading Value [dB (uV)]		Emission Level [dB (uV)]		Limit [dB (uV)]		Margin (dB)	
		(dB)	Q.P.	AV.	Q.P.	AV.	Q.P.	AV.	Q.P.	AV.
	1	0.15000	10.02	29.04	13.58	39.06	23.60	66.00	56.00	-26.94
2	0.16953	10.03	23.76	8.80	33.79	18.83	64.98	54.98	-31.19	-36.15
3	0.40000	10.07	18.18	13.14	28.25	23.21	57.85	47.85	-29.60	-24.64
4	2.05078	10.16	11.37	4.77	21.53	14.93	56.00	46.00	-34.47	-31.07
5	9.77734	10.52	18.91	11.34	29.43	21.86	60.00	50.00	-30.57	-28.14
6	15.78906	10.84	9.06	1.76	19.90	12.60	60.00	50.00	-40.10	-37.40

Remarks:

1. Q.P. and AV. are abbreviations of quasi-peak and average individually.
2. The emission levels of other frequencies were very low against the limit.
3. Margin value = Emission level – Limit value
4. Correction factor = Insertion loss + Cable loss
5. Emission Level = Correction Factor + Reading Value

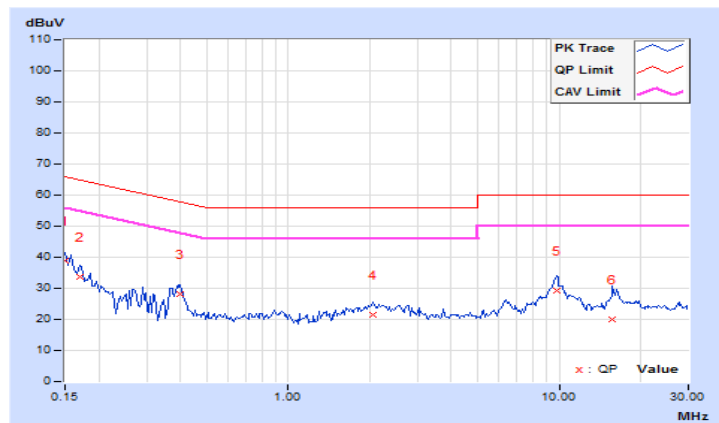

Phase	Neutral (N)	Detector Function	Quasi-Peak (QP) / Average (AV)
-------	-------------	-------------------	--------------------------------

No	Freq. [MHz]	Corr. Factor	Reading Value [dB (uV)]		Emission Level [dB (uV)]		Limit [dB (uV)]		Margin (dB)	
		(dB)	Q.P.	AV.	Q.P.	AV.	Q.P.	AV.	Q.P.	AV.
	1	0.15000	9.93	27.28	12.83	37.21	22.76	66.00	56.00	-28.79
2	0.18906	9.94	20.93	5.71	30.87	15.65	64.08	54.08	-33.21	-38.43
3	0.39219	9.96	15.07	11.30	25.03	21.26	58.02	48.02	-32.99	-26.76
4	2.05078	10.04	13.43	7.24	23.47	17.28	56.00	46.00	-32.53	-28.72
5	9.75391	10.37	19.52	12.33	29.89	22.70	60.00	50.00	-30.11	-27.30
6	16.36328	10.69	15.46	8.47	26.15	19.16	60.00	50.00	-33.85	-30.84

Remarks:

1. Q.P. and AV. are abbreviations of quasi-peak and average individually.
2. The emission levels of other frequencies were very low against the limit.
3. Margin value = Emission level – Limit value
4. Correction factor = Insertion loss + Cable loss
5. Emission Level = Correction Factor + Reading Value

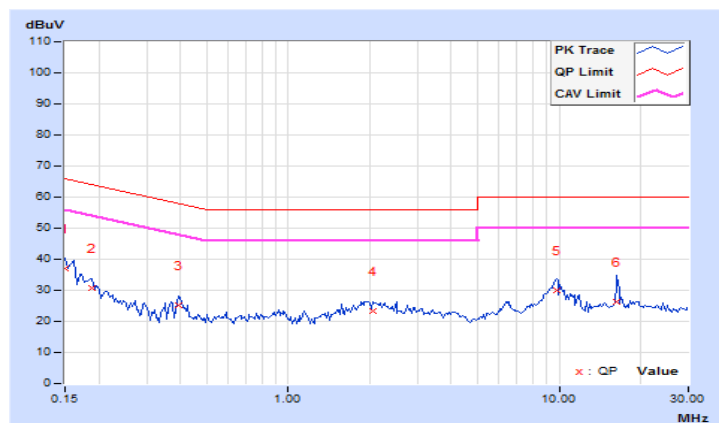

4.3 Transmit Power Measurement

4.3.1 Limits of Transmit Power Measurement

Operation Band	EUT Category		Limit
U-NII-1		Outdoor Access Point	1 Watt (30 dBm) (Max. e.i.r.p \leq 125mW(21 dBm) at any elevation angle above 30 degrees as measured from the horizon)
		Fixed point-to-point Access Point	1 Watt (30 dBm)
		Indoor Access Point	1 Watt (30 dBm)
		Client device	250mW (24 dBm)
U-NII-2A			250mW (24 dBm) or 11 dBm+10 log B*
U-NII-2C			250mW (24 dBm) or 11 dBm+10 log B*
U-NII-3	√		1 Watt (30 dBm)

*B is the 26 dB emission bandwidth in megahertz

Per KDB 662911 Method of conducted output power measurement on IEEE 802.11 devices,

Array Gain = 0 dB (i.e., no array gain) for $N_{ANT} \leq 4$;

Array Gain = 0 dB (i.e., no array gain) for channel widths ≥ 40 MHz for any N_{ANT} ;

Array Gain = $5 \log(N_{ANT}/N_{SS})$ dB or 3 dB, whichever is less for 20-MHz channel widths with $N_{ANT} \geq 5$.

For power measurements on all other devices: Array Gain = $10 \log(N_{ANT}/N_{SS})$ dB.

4.3.2 Test Setup

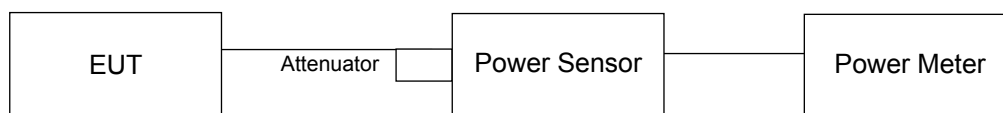

4.3.3 Test Instruments

Refer to section 4.1.2 to get information of above instrument.

4.3.4 Test Procedure

Method PM is used to perform output power measurement, trigger and gating function of wide band power meter is enabled to measure max output power of TX on burst. Duty factor is not added to measured value.

4.3.5 Deviation from Test Standard

No deviation.

4.3.6 EUT Operating Condition

The software provided by client to enable the EUT under transmission condition continuously at lowest, middle and highest channel frequencies individually.

4.3.7 Test Results

Non-Beamforming Mode

802.11a

Chan.	Chan. Freq. (MHz)	Maximum Conducted Power (dBm)				Total Power (mW)	Total Power (dBm)	Limit (dBm)	Pass / Fail
		Chain 0	Chain 1	Chain 2	Chain 3				
149	5745	23.75	23.71	24.12	24.11	987.958	29.95	30.00	Pass
157	5785	23.88	23.76	24.06	24.06	991.393	29.96	30.00	Pass
165	5825	23.52	23.78	23.86	24.05	961.003	29.83	30.00	Pass

802.11ac (VHT20)

Chan.	Chan. Freq. (MHz)	Maximum Conducted Power (dBm)				Total Power (mW)	Total Power (dBm)	Limit (dBm)	Pass / Fail
		Chain 0	Chain 1	Chain 2	Chain 3				
149	5745	23.38	23.49	23.64	24.01	924.102	29.66	30.00	Pass
157	5785	23.42	23.50	23.64	24.05	928.961	29.68	30.00	Pass
165	5825	23.32	23.34	23.50	23.80	894.312	29.51	30.00	Pass

802.11ac (VHT40)

Chan.	Chan. Freq. (MHz)	Maximum Conducted Power (dBm)				Total Power (mW)	Total Power (dBm)	Limit (dBm)	Pass / Fail
		Chain 0	Chain 1	Chain 2	Chain 3				
151	5755	23.42	23.71	24.01	24.02	958.865	29.82	30.00	Pass
159	5795	23.46	23.73	23.93	23.98	955.075	29.80	30.00	Pass

802.11ac (VHT80)

Chan.	Chan. Freq. (MHz)	Maximum Conducted Power (dBm)				Total Power (mW)	Total Power (dBm)	Limit (dBm)	Pass / Fail
		Chain 0	Chain 1	Chain 2	Chain 3				
155	5775	22.59	22.90	23.01	22.93	772.858	28.88	30.00	Pass

802.11ax (HE20)

Chan.	Chan. Freq. (MHz)	Maximum Conducted Power (dBm)				Total Power (mW)	Total Power (dBm)	Limit (dBm)	Pass / Fail
		Chain 0	Chain 1	Chain 2	Chain 3				
149	5745	23.52	23.61	23.78	24.12	951.527	29.78	30.00	Pass
157	5785	23.56	23.67	23.84	24.16	962.513	29.83	30.00	Pass
165	5825	23.50	23.53	23.68	23.98	932.677	29.70	30.00	Pass

802.11ax (HE40)

Chan.	Chan. Freq. (MHz)	Maximum Conducted Power (dBm)				Total Power (mW)	Total Power (dBm)	Limit (dBm)	Pass / Fail
		Chain 0	Chain 1	Chain 2	Chain 3				
151	5755	23.56	23.84	24.11	24.13	985.542	29.94	30.00	Pass
159	5795	23.65	23.92	24.04	24.16	992.471	29.97	30.00	Pass

802.11ax (HE80)

Chan.	Chan. Freq. (MHz)	Maximum Conducted Power (dBm)				Total Power (mW)	Total Power (dBm)	Limit (dBm)	Pass / Fail
		Chain 0	Chain 1	Chain 2	Chain 3				
155	5775	22.78	23.06	23.15	23.03	799.42	29.03	30.00	Pass

Beamforming Mode

802.11ac (VHT20)

Chan.	Chan. Freq. (MHz)	Maximum Conducted Power (dBm)				Total Power (mW)	Total Power (dBm)	Limit (dBm)	Pass / Fail
		Chain 0	Chain 1	Chain 2	Chain 3				
149	5745	23.38	23.49	23.64	24.01	924.102	29.66	30.00	Pass
157	5785	23.42	23.50	23.64	24.05	928.961	29.68	30.00	Pass
165	5825	23.32	23.34	23.50	23.80	894.312	29.51	30.00	Pass

Note: For U-NII-3 band: The directional gain is 5.09dBi < 6dBi, so the power limit shall not be reduced to "Determined Conducted Limit".

802.11ac (VHT40)

Chan.	Chan. Freq. (MHz)	Maximum Conducted Power (dBm)				Total Power (mW)	Total Power (dBm)	Limit (dBm)	Pass / Fail
		Chain 0	Chain 1	Chain 2	Chain 3				
151	5755	23.42	23.71	24.01	24.02	958.865	29.82	30.00	Pass
159	5795	23.46	23.73	23.93	23.98	955.075	29.80	30.00	Pass

Note: For U-NII-3 band: The directional gain is 5.09dBi < 6dBi, so the power limit shall not be reduced to "Determined Conducted Limit".

802.11ac (VHT80)

Chan.	Chan. Freq. (MHz)	Maximum Conducted Power (dBm)				Total Power (mW)	Total Power (dBm)	Limit (dBm)	Pass / Fail
		Chain 0	Chain 1	Chain 2	Chain 3				
155	5775	22.59	22.90	23.01	22.93	772.858	28.88	30.00	Pass

Note: For U-NII-3 band: The directional gain is 5.09dBi < 6dBi, so the power limit shall not be reduced to "Determined Conducted Limit".

802.11ax (HE20)

Chan.	Chan. Freq. (MHz)	Maximum Conducted Power (dBm)				Total Power (mW)	Total Power (dBm)	Limit (dBm)	Pass / Fail
		Chain 0	Chain 1	Chain 2	Chain 3				
149	5745	23.52	23.61	23.78	24.12	951.527	29.78	30.00	Pass
157	5785	23.56	23.67	23.84	24.16	962.513	29.83	30.00	Pass
165	5825	23.50	23.53	23.68	23.98	932.677	29.70	30.00	Pass

Note: For U-NII-3 band: The directional gain is 5.09dBi < 6dBi, so the power limit shall not be reduced to "Determined Conducted Limit".

802.11ax (HE40)

Chan.	Chan. Freq. (MHz)	Maximum Conducted Power (dBm)				Total Power (mW)	Total Power (dBm)	Limit (dBm)	Pass / Fail
		Chain 0	Chain 1	Chain 2	Chain 3				
151	5755	23.56	23.84	24.11	24.13	985.542	29.94	30.00	Pass
159	5795	23.65	23.92	24.04	24.16	992.471	29.97	30.00	Pass

Note: For U-NII-3 band: The directional gain is 5.09dBi < 6dBi, so the power limit shall not be reduced to "Determined Conducted Limit".

802.11ax (HE80)

Chan.	Chan. Freq. (MHz)	Maximum Conducted Power (dBm)				Total Power (mW)	Total Power (dBm)	Limit (dBm)	Pass / Fail
		Chain 0	Chain 1	Chain 2	Chain 3				
155	5775	22.78	23.06	23.15	23.03	799.42	29.03	30.00	Pass

Note: For U-NII-3 band: The directional gain is 5.09dBi < 6dBi, so the power limit shall not be reduced to "Determined Conducted Limit".

4.4 Occupied Bandwidth Measurement

4.4.1 Test Setup

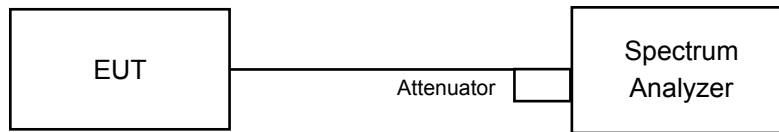

4.4.2 Test Instruments

Refer to section 4.1.2 to get information of above instrument.

4.4.3 Test Procedure

The transmitter output was connected to the spectrum analyzer through an attenuator. The bandwidth of the fundamental frequency was measured by spectrum analyzer with resolution bandwidth in the range of 1% to 5% of the anticipated emission bandwidth, and a video bandwidth at least 3x the resolution bandwidth and set the detector to SAMPLE. The width of a frequency band such that, below the lower and above the upper frequency limits, the mean powers emitted are each equal to a specified percentage 0.5% of the total mean power of a given emission.

4.4.4 Test Results

Non-Beamforming Mode

802.11a

Channel	Channel Frequency (MHz)	Occupied Bandwidth (MHz)			
		Chain 0	Chain 1	Chain 2	Chain 3
149	5745	16.87	17.04	17.04	16.95
157	5785	17.04	17.40	17.16	17.04
165	5825	17.04	17.52	17.16	17.16

802.11ax (HE20)

Channel	Channel Frequency (MHz)	Occupied Bandwidth (MHz)			
		Chain 0	Chain 1	Chain 2	Chain 3
149	5745	19.05	18.96	19.14	18.96
157	5785	18.96	18.96	19.20	19.08
165	5825	18.96	19.08	19.44	19.08

802.11ax (HE40)

Channel	Channel Frequency (MHz)	Occupied Bandwidth (MHz)			
		Chain 0	Chain 1	Chain 2	Chain 3
151	5755	38.16	38.16	38.16	38.16
159	5795	38.16	38.16	38.16	38.16

802.11ax (HE80)

Channel	Channel Frequency (MHz)	Occupied Bandwidth (MHz)			
		Chain 0	Chain 1	Chain 2	Chain 3
155	5775	77.28	77.28	77.57	76.80

Spectrum Plot of Max. Value

802.11a_Chain 1 / CH165

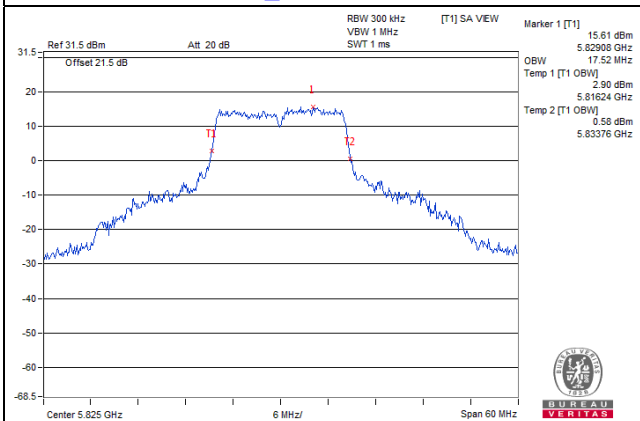

802.11ax (HE20)_Chain 2 / CH165

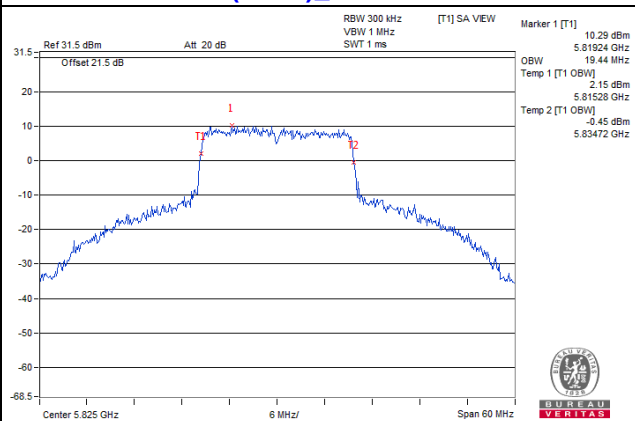

802.11ax (HE40)_Chain 0 / CH151

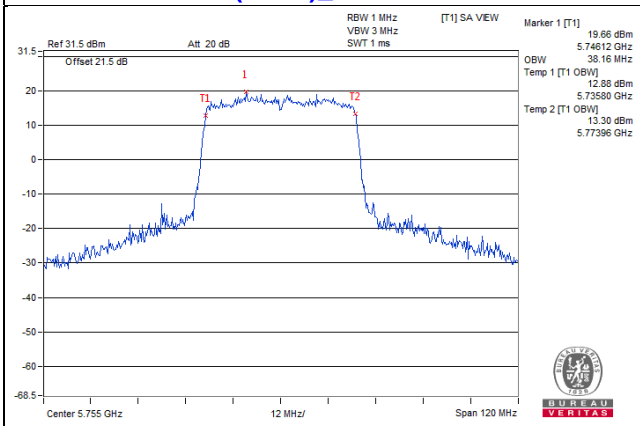

802.11ax (HE80)_Chain 2 / CH155

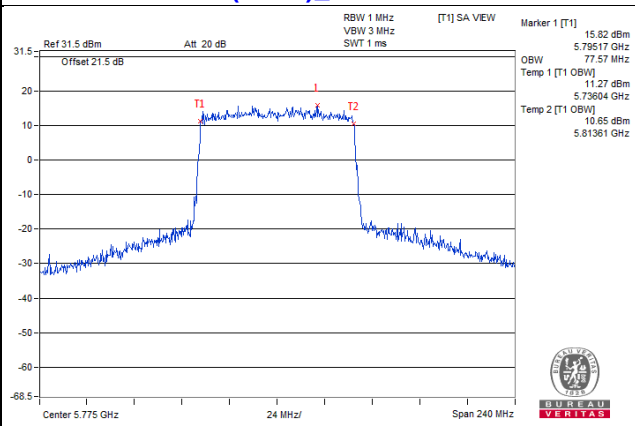

Spectrum Plot for near by DFS band
(DFS is required, if 99% OCP straddle into U-NII-2C band)

802.11a_Chain 0 / CH149

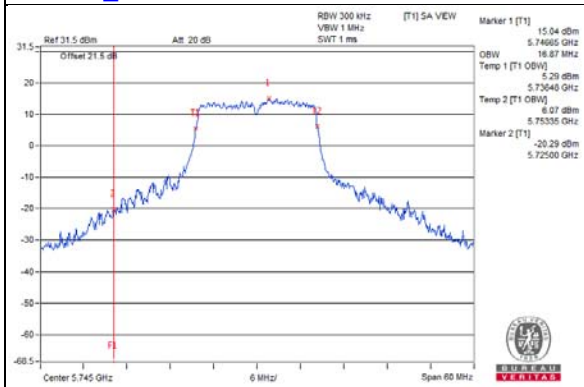

802.11a_Chain 1 / CH149

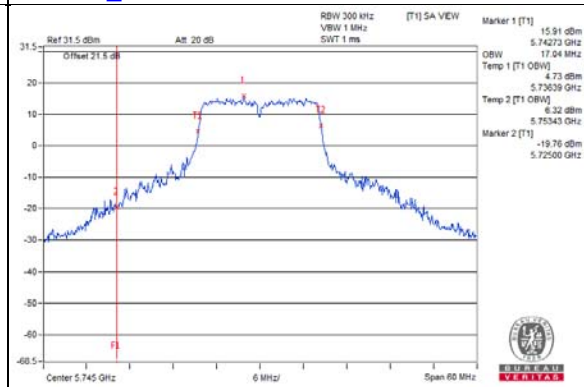

802.11a_Chain 2 / CH149

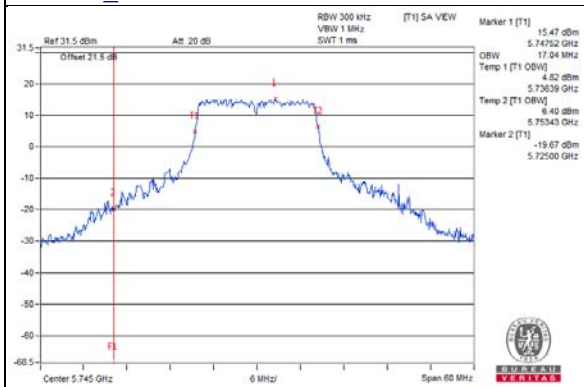

802.11a_Chain 3 / CH149

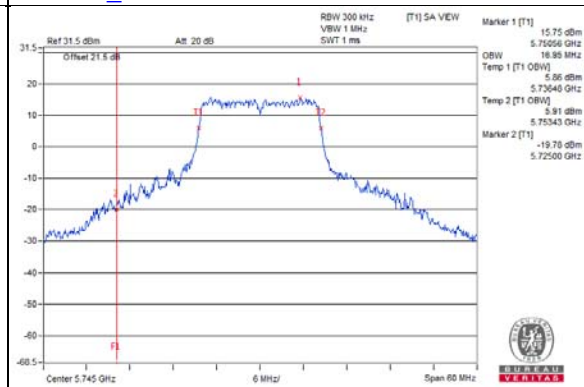

802.11ax (HE20)_Chain 0 / CH149

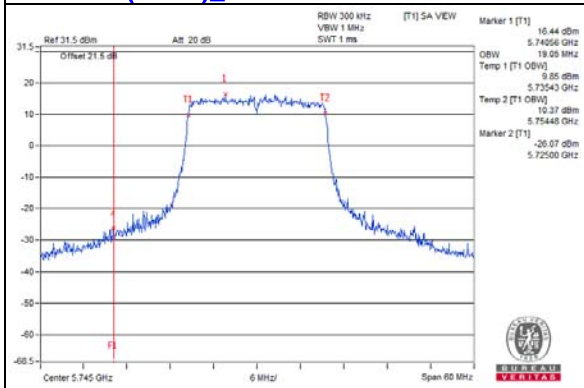

802.11ax (HE20)_Chain 1 / CH149

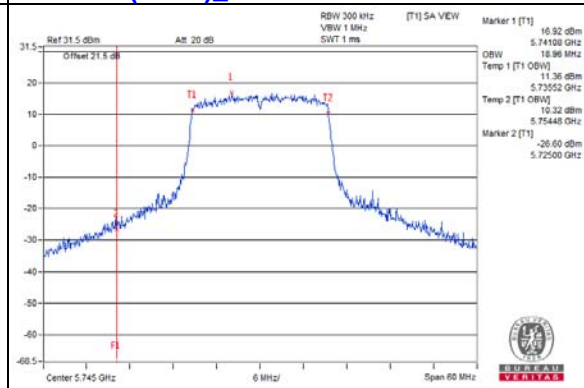

802.11ax (HE20)_Chain 2 / CH149

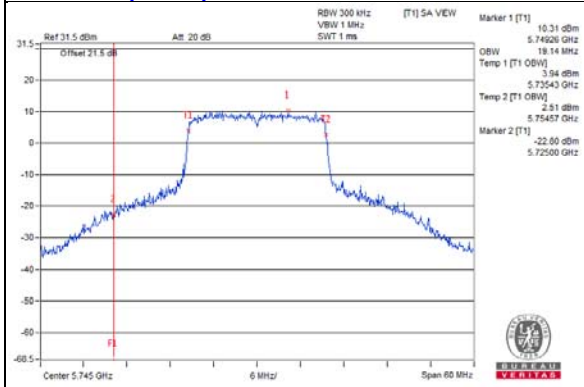

802.11ax (HE20)_Chain 3 / CH149

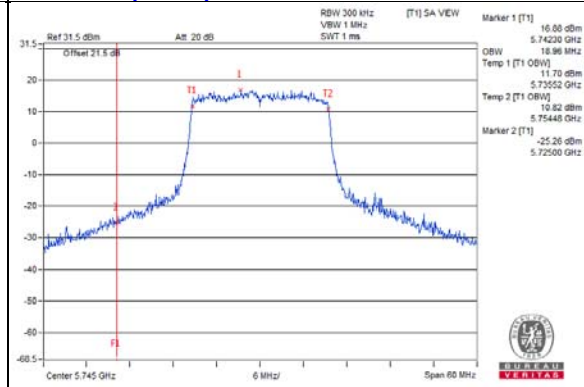

**Spectrum Plot for near by DFS band
(DFS is required, if 99% OCP straddle into U-NII-2C band)**

802.11ax (HE40) Chain 0 / CH151

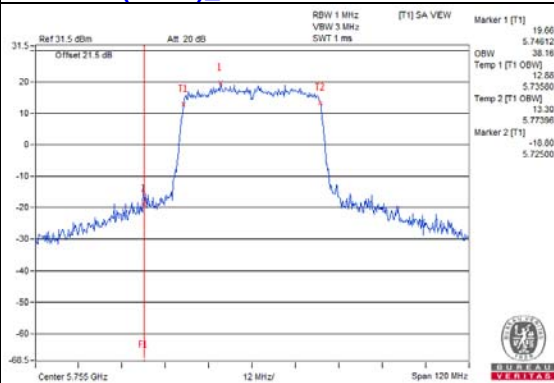

802.11ax (HE40) Chain 1 / CH151

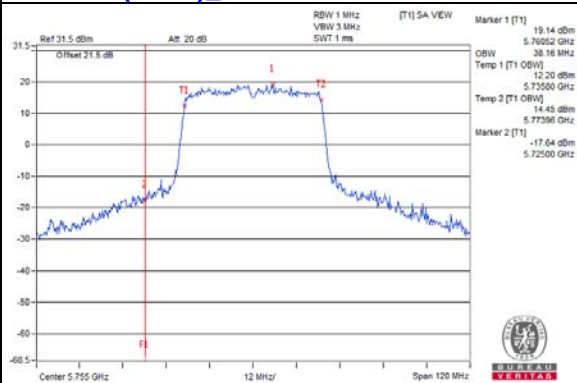

802.11ax (HE40) Chain 2 / CH151

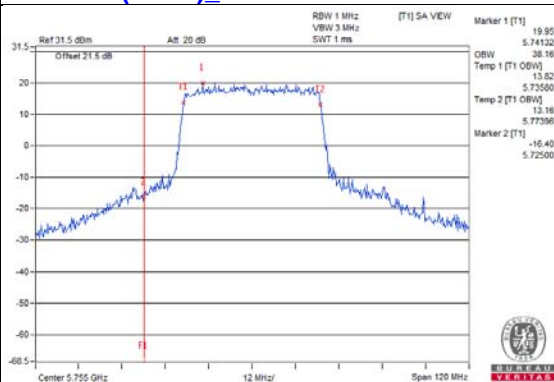

802.11ax (HE40) Chain 3 / CH151

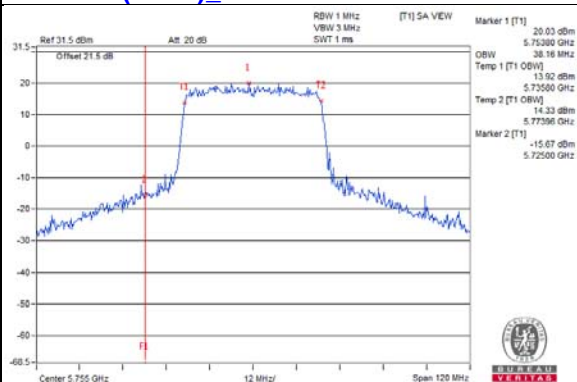

802.11ax (HE80) Chain 0 / CH155

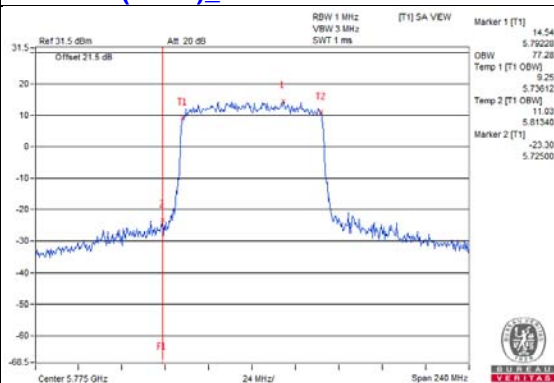

802.11ax (HE80) Chain 1 / CH155

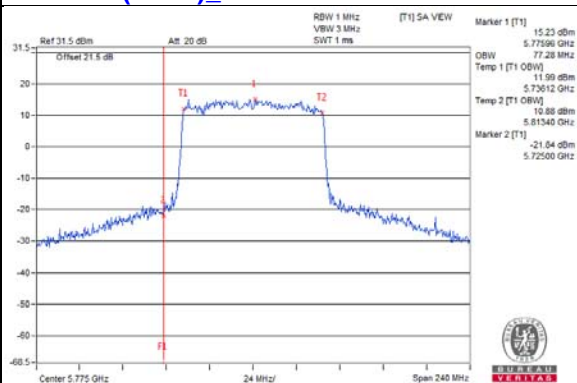

802.11ax (HE80) Chain 2 / CH155

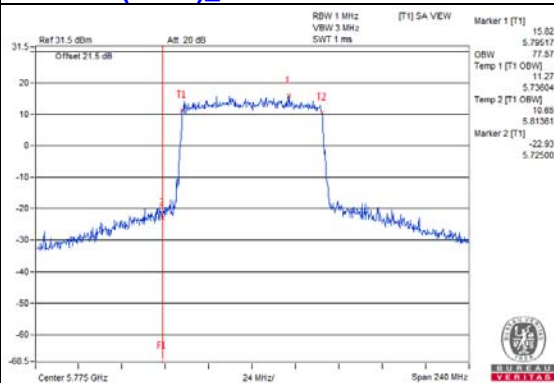

802.11ax (HE80) Chain 3 / CH155

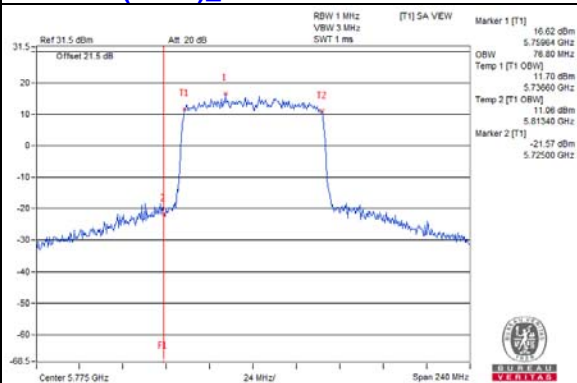

4.5 Peak Power Spectral Density Measurement

4.5.1 Limits of Peak Power Spectral Density Measurement

Operation Band	EUT Category		Limit
U-NII-1		Outdoor Access Point	17dBm/ MHz
		Fixed point-to-point Access Point	
		Indoor Access Point	
		Client device	11dBm/ MHz
U-NII-2A			11dBm/ MHz
U-NII-2C			11dBm/ MHz
U-NII-3		√	30dBm/ 500kHz

4.5.2 Test Setup

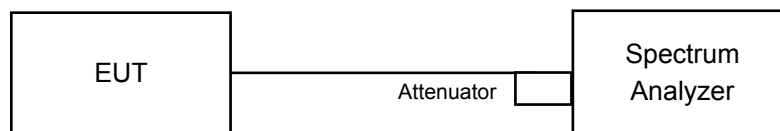

4.5.3 Test Instruments

Refer to section 4.1.2 to get information of above instrument.

4.5.4 Test Procedure

1. Set span to encompass the entire emission bandwidth (EBW) of the signal.
2. Set RBW = 300 kHz, Set VBW \geq 1 MHz, Detector = RMS
3. Use the peak marker function to determine the maximum power level in any 300 kHz band segment within the fundamental EBW.
4. Scale the observed power level to an equivalent value in 500 kHz by adjusting (reducing) the measured power by a bandwidth correction factor (BWCF) where $BWCF = 10\log(500\text{kHz}/300\text{kHz})$
5. Sweep time = auto, trigger set to "free run".
6. Trace average at least 100 traces in power averaging mode.
7. Record the max value and add $10 \log (1/\text{duty cycle})$

4.5.5 Deviation from Test Standard

No deviation.

4.5.6 EUT Operating Condition

Same as Item 4.3.6.

4.5.7 Test Results

Non-Beamforming Mode

802.11a

Chan.	Freq. (MHz)	PSD W/O Duty Factor (dBm/300kHz)				Duty Factor (dB)	Total PSD With Duty Factor		Limit (dBm/500kHz)	Pass /Fail
		Chain 0	Chain 1	Chain 2	Chain 3		dBm/300kHz	dBm/500kHz		
149	5745	-2.06	-2.83	-2.32	-1.94	0.97	4.72	6.94	30.00	Pass
157	5785	-2.27	-0.04	-3.16	-2.33	0.97	5.21	7.43	30.00	Pass
165	5825	-3.17	-0.51	-0.71	-1.28	0.97	5.69	7.91	30.00	Pass

- Note: 1. Method b) Measure and sum spectral maxima across the outputs of KDB 662911 is using for calculating total power density.
 2. The directional gain = 5.09dBi < 6dBi, so the power density limit shall not be reduced.
 3. Refer to section 3.3 for duty cycle spectrum plot.

802.11ac (VHT20)

Chan.	Freq. (MHz)	PSD W/O Duty Factor (dBm/300kHz)				Duty Factor (dB)	Total PSD With Duty Factor		Limit (dBm/500kHz)	Pass /Fail
		Chain 0	Chain 1	Chain 2	Chain 3		dBm/300kHz	dBm/500kHz		
149	5745	0.46	1.47	1.22	1.74	0.27	7.54	9.76	30.00	Pass
157	5785	1.03	1.47	1.26	1.58	0.27	7.63	9.85	30.00	Pass
165	5825	1.21	1.85	1.27	1.64	0.27	7.79	10.01	30.00	Pass

- Note: 1. Method b) Measure and sum spectral maxima across the outputs of KDB 662911 is using for calculating total power density.
 2. The directional gain = 5.09dBi < 6dBi, so the power density limit shall not be reduced.
 3. Refer to section 3.3 for duty cycle spectrum plot.

802.11ac (VHT40)

Chan.	Freq. (MHz)	PSD W/O Duty Factor (dBm/300kHz)				Duty Factor (dB)	Total PSD With Duty Factor		Limit (dBm/500kHz)	Pass /Fail
		Chain 0	Chain 1	Chain 2	Chain 3		dBm/300kHz	dBm/500kHz		
151	5755	-2.04	-1.68	-1.67	-2.03	0.25	4.42	6.64	30.00	Pass
159	5795	-2.43	-0.94	-1.07	-1.77	0.25	4.76	6.98	30.00	Pass

- Note: 1. Method b) Measure and sum spectral maxima across the outputs of KDB 662911 is using for calculating total power density.
 2. The directional gain = 5.09dBi < 6dBi, so the power density limit shall not be reduced.
 3. Refer to section 3.3 for duty cycle spectrum plot.

802.11ac (VHT80)

Chan.	Freq. (MHz)	PSD W/O Duty Factor (dBm/300kHz)				Duty Factor (dB)	Total PSD With Duty Factor		Limit (dBm/500kHz)	Pass /Fail
		Chain 0	Chain 1	Chain 2	Chain 3		dBm/300kHz	dBm/500kHz		
155	5775	-6.41	-5.39	-4.90	-5.36	0.17	0.71	2.93	30.00	Pass

- Note: 1. Method b) Measure and sum spectral maxima across the outputs of KDB 662911 is using for calculating total power density.
 2. The directional gain = 5.09dBi < 6dBi, so the power density limit shall not be reduced.
 3. Refer to section 3.3 for duty cycle spectrum plot.

802.11ax (HE20)

Chan.	Freq. (MHz)	PSD W/O Duty Factor (dBm/300kHz)				Duty Factor (dB)	Total PSD With Duty Factor		Limit (dBm/500kHz)	Pass /Fail
		Chain 0	Chain 1	Chain 2	Chain 3		dBm/300kHz	dBm/500kHz		
149	5745	-0.34	0.52	-5.86	0.92	0.22	5.72	7.94	30.00	Pass
157	5785	0.24	1.51	-5.26	0.66	0.22	6.17	8.39	30.00	Pass
165	5825	0.42	0.96	-4.63	0.78	0.22	6.12	8.34	30.00	Pass

- Note: 1. Method b) Measure and sum spectral maxima across the outputs of KDB 662911 is using for calculating total power density.
 2. The directional gain = 5.09dBi < 6dBi, so the power density limit shall not be reduced.
 3. Refer to section 3.3 for duty cycle spectrum plot.

802.11ax (HE40)

Chan.	Freq. (MHz)	PSD W/O Duty Factor (dBm/300kHz)				Duty Factor (dB)	Total PSD With Duty Factor		Limit (dBm/500kHz)	Pass /Fail
		Chain 0	Chain 1	Chain 2	Chain 3		dBm/300kHz	dBm/500kHz		
151	5755	-2.40	-2.16	-2.06	-1.67	0.22	4.17	6.39	30.00	Pass
159	5795	-2.35	-1.94	-1.81	-1.64	0.22	4.31	6.53	30.00	Pass

- Note: 1. Method b) Measure and sum spectral maxima across the outputs of KDB 662911 is using for calculating total power density.
 2. The directional gain = 5.09dBi < 6dBi, so the power density limit shall not be reduced.
 3. Refer to section 3.3 for duty cycle spectrum plot.

802.11ax (HE80)

Chan.	Freq. (MHz)	PSD W/O Duty Factor (dBm/300kHz)				Duty Factor (dB)	Total PSD With Duty Factor		Limit (dBm/500kHz)	Pass /Fail
		Chain 0	Chain 1	Chain 2	Chain 3		dBm/300kHz	dBm/500kHz		
155	5775	-5.58	-5.15	-5.08	-4.89	0.18	1.04	3.26	30.00	Pass

- Note: 1. Method b) Measure and sum spectral maxima across the outputs of KDB 662911 is using for calculating total power density.
 2. The directional gain = 5.09dBi < 6dBi, so the power density limit shall not be reduced.
 3. Refer to section 3.3 for duty cycle spectrum plot.

Spectrum Plot of Worst Value

802.11a_Chain 1 / CH157

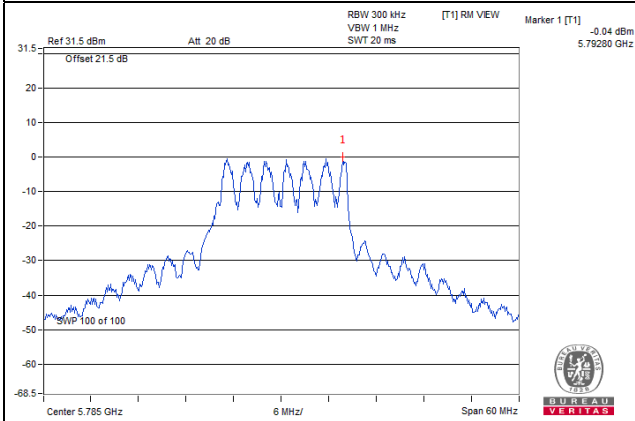

802.11ac (VHT20)_Chain 1 / CH165

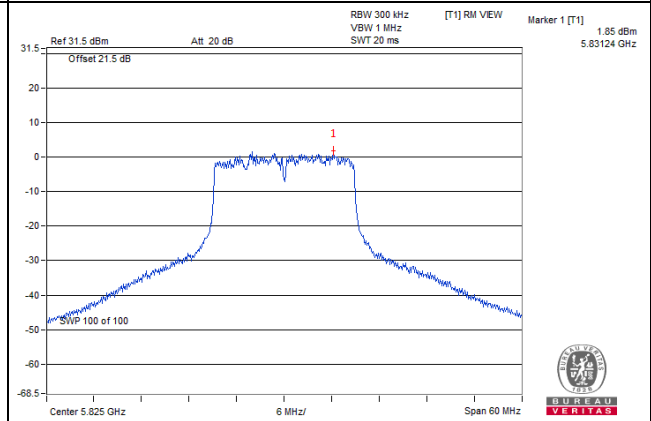

802.11ac (VHT40)_Chain 1 / CH159

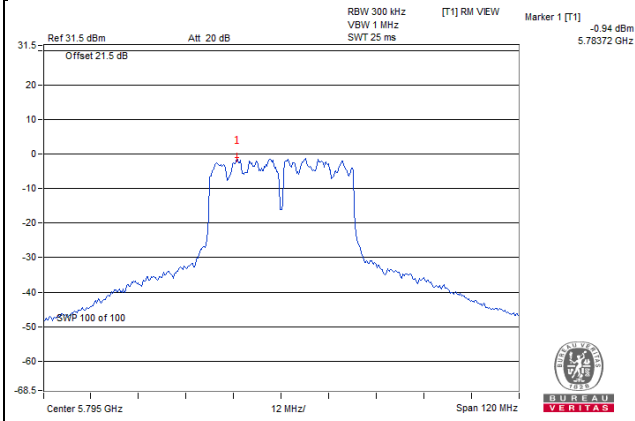

802.11ac (VHT80)_Chain 2 / CH155

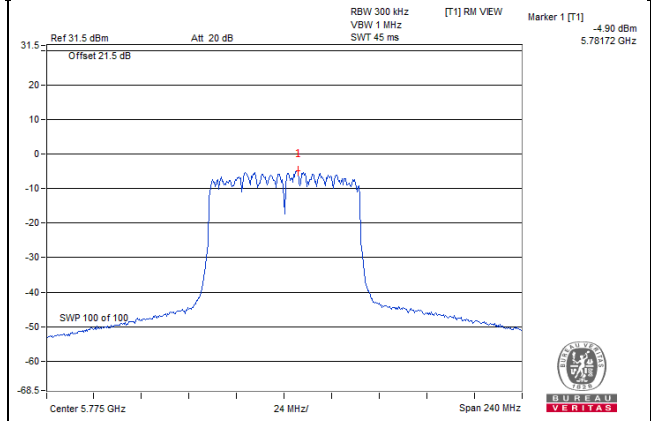

Spectrum Plot of Worst Value

802.11ax (HE20)_Chain 1 / CH157

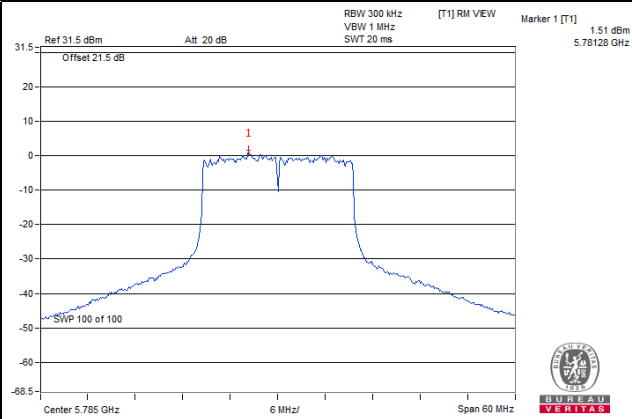

802.11ax (HE40)_Chain 3 / CH159

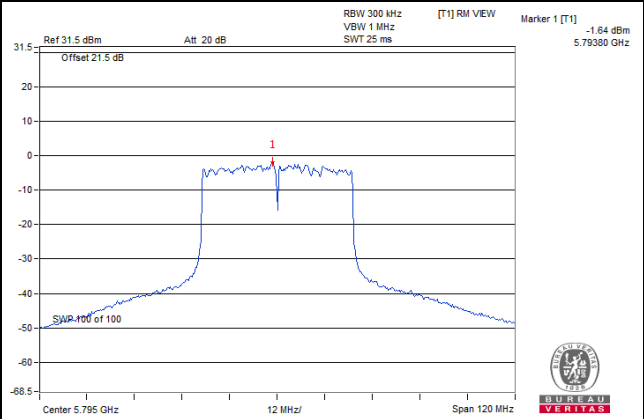

802.11ax (HE80)_Chain 3 / CH155

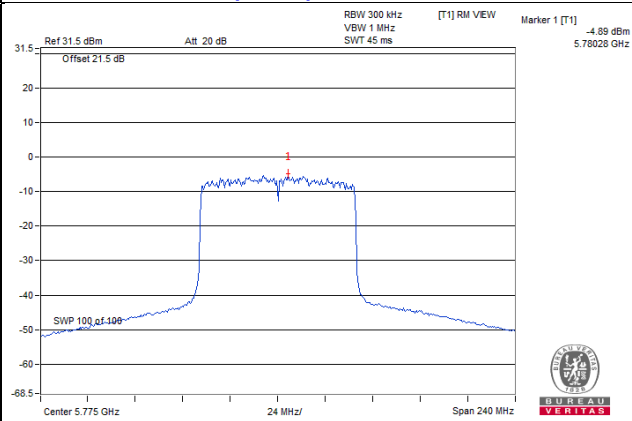

4.6 Frequency Stability Measurement

4.6.1 Limits of Frequency Stability Measurement

The frequency of the carrier signal shall be maintained within band of operation

4.6.2 Test Setup

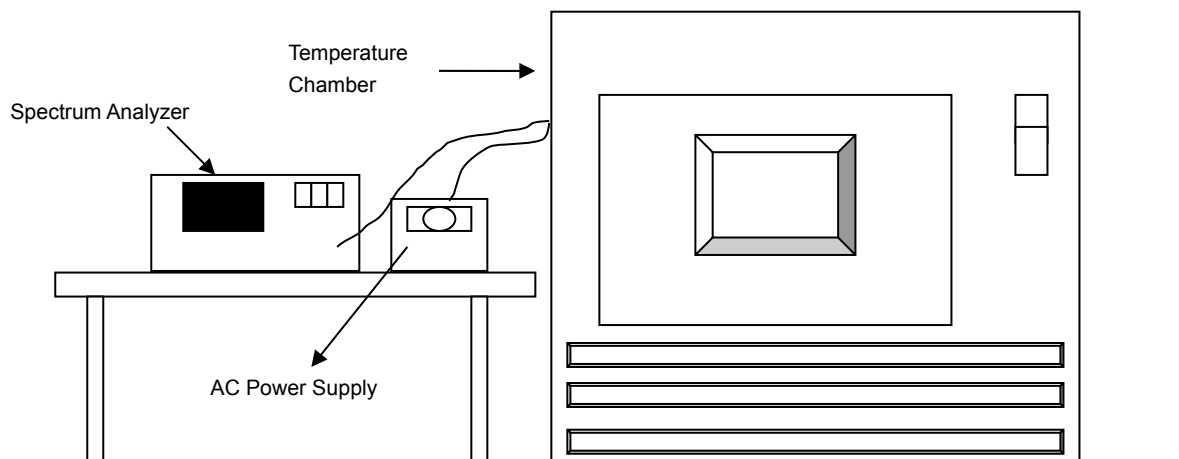

4.6.3 Test Instruments

Refer to section 4.1.2 to get information of above instrument.

4.6.4 Test Procedure

- The EUT was placed inside the environmental test chamber and powered by nominal AC voltage.
- Turn the EUT on and couple its output to a spectrum analyzer.
- Turn the EUT off and set the chamber to the highest temperature specified.
- Allow sufficient time (approximately 30 min) for the temperature of the chamber to stabilize, turn the EUT on and measure the operating frequency after 2, 5, and 10 Minutes.
- Repeat step (d) with the temperature chamber set to the next desired temperature until measurements down to the lowest specified temperature have been completed.
- The test chamber was allowed to stabilize at +20 degree C for a minimum of 30 Minutes. The supply voltage was then adjusted on the EUT from 85% to 115% and the frequency record.

4.6.5 Deviation from Test Standard

No deviation.

4.6.6 EUT Operating Condition

Set the EUT transmit at un-modulation mode to test frequency stability.

4.6.7 Test Results

Frequency Stability Versus Temp.									
Operating Frequency: 5745 MHz									
TEMP. (°C)	Power Supply (Vac)	0 Minute		2 Minutes		5 Minutes		10 Minutes	
		Measured Frequency (MHz)	Pass/Fail	Measured Frequency (MHz)	Pass/Fail	Measured Frequency (MHz)	Pass/Fail	Measured Frequency (MHz)	Pass/Fail
50	120	5745.0093	Pass	5745.0096	Pass	5745.0071	Pass	5745.006	Pass
40	120	5745.0264	Pass	5745.0262	Pass	5745.0307	Pass	5745.0284	Pass
30	120	5744.9742	Pass	5744.976	Pass	5744.9714	Pass	5744.9722	Pass
20	120	5744.9744	Pass	5744.9736	Pass	5744.975	Pass	5744.9708	Pass
10	120	5744.9735	Pass	5744.9699	Pass	5744.9707	Pass	5744.9735	Pass
0	120	5745.0004	Pass	5745	Pass	5745.0015	Pass	5745.0013	Pass
-10	120	5744.9963	Pass	5744.9971	Pass	5744.9921	Pass	5744.9927	Pass
-20	120	5745.0163	Pass	5745.0171	Pass	5745.0175	Pass	5745.016	Pass
-30	120	5744.9806	Pass	5744.9782	Pass	5744.981	Pass	5744.978	Pass

Frequency Stability Versus Voltage									
Operating Frequency: 5745 MHz									
TEMP. (°C)	Power Supply (Vac)	0 Minute		2 Minutes		5 Minutes		10 Minutes	
		Measured Frequency (MHz)	Pass/Fail	Measured Frequency (MHz)	Pass/Fail	Measured Frequency (MHz)	Pass/Fail	Measured Frequency (MHz)	Pass/Fail
20	138	5744.9734	Pass	5744.974	Pass	5744.9755	Pass	5744.9718	Pass
	120	5744.9744	Pass	5744.9736	Pass	5744.975	Pass	5744.9708	Pass
	102	5744.9733	Pass	5744.974	Pass	5744.975	Pass	5744.9701	Pass

4.7 6dB Bandwidth Measurement

4.7.1 Limits of 6dB Bandwidth Measurement

The minimum of 6dB Bandwidth Measurement is 0.5MHz.

4.7.2 Test Setup

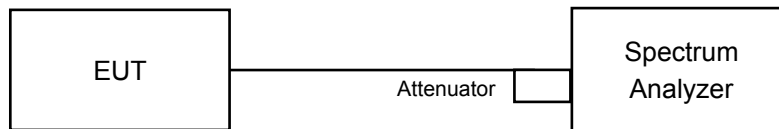

4.7.3 Test Instruments

Refer to section 4.1.2 to get information of above instrument.

4.7.4 Test Procedure

MEASUREMENT PROCEDURE REF

- Set resolution bandwidth (RBW) = 100kHz
- Set the video bandwidth (VBW) $\geq 3 \times$ RBW, Detector = Peak.
- Trace mode = max hold.
- Sweep = auto couple.
- Measure the maximum width of the emission that is constrained by the frequencies associated with the two amplitude points (upper and lower) that are attenuated by 6 dB relative to the maximum level measured in the fundamental emission

4.7.5 Deviation from Test Standard

No deviation.

4.7.6 EUT Operating Condition

The software provided by client to enable the EUT under transmission condition continuously at lowest, middle and highest channel frequencies individually.

4.7.7 Test Results

Non-Beamforming Mode

802.11a

Channel	Frequency (MHz)	6dB Bandwidth (MHz)				Minimum Limit (MHz)	Pass / Fail
		Chain 0	Chain 1	Chain 2	Chain 3		
149	5745	16.38	16.38	16.39	16.40	0.5	Pass
157	5785	16.42	16.39	16.41	16.41	0.5	Pass
165	5825	16.37	16.39	16.39	16.39	0.5	Pass

802.11ax (HE20)

Channel	Frequency (MHz)	6dB Bandwidth (MHz)				Minimum Limit (MHz)	Pass / Fail
		Chain 0	Chain 1	Chain 2	Chain 3		
149	5745	19.01	18.50	18.61	18.76	0.5	Pass
157	5785	18.69	18.75	18.66	18.95	0.5	Pass
165	5825	18.63	18.61	18.75	18.70	0.5	Pass

802.11ax (HE40)

Channel	Frequency (MHz)	6dB Bandwidth (MHz)				Minimum Limit (MHz)	Pass / Fail
		Chain 0	Chain 1	Chain 2	Chain 3		
151	5755	37.91	37.96	37.92	37.68	0.5	Pass
159	5795	37.95	37.77	38.00	37.81	0.5	Pass

802.11ax (HE80)

Channel	Frequency (MHz)	6dB Bandwidth (MHz)				Minimum Limit (MHz)	Pass / Fail
		Chain 0	Chain 1	Chain 2	Chain 3		
155	5775	76.97	77.93	77.32	77.92	0.5	Pass

Spectrum Plot of Worst Value

802.11a_Chain 0 / CH165

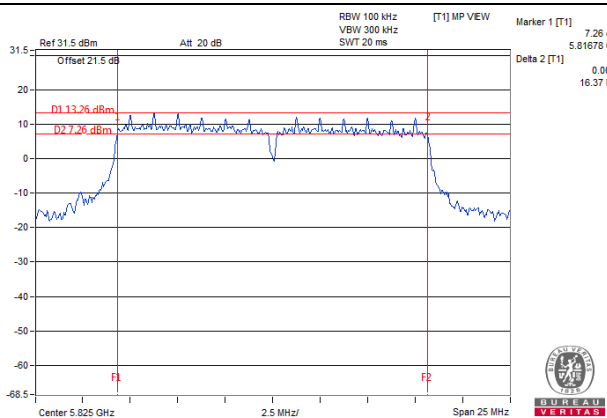

802.11ax (HE20)_Chain 1 / CH149

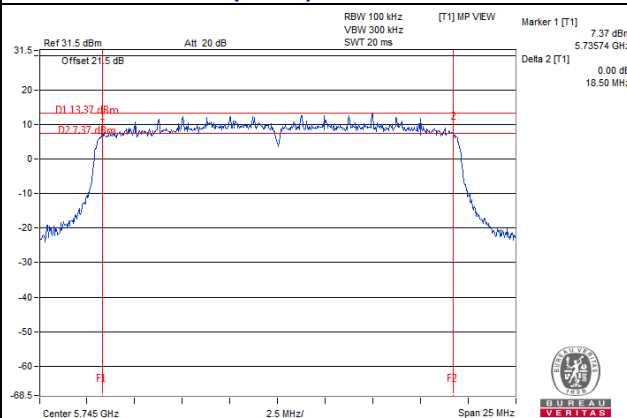

802.11ax (HE40)_Chain 3 / CH151

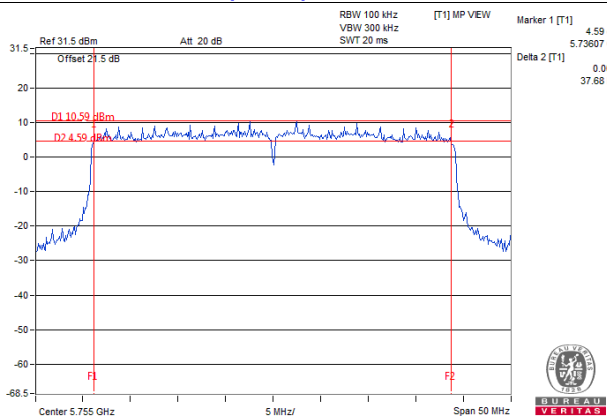

802.11ax (HE80)_Chain 0 / CH155

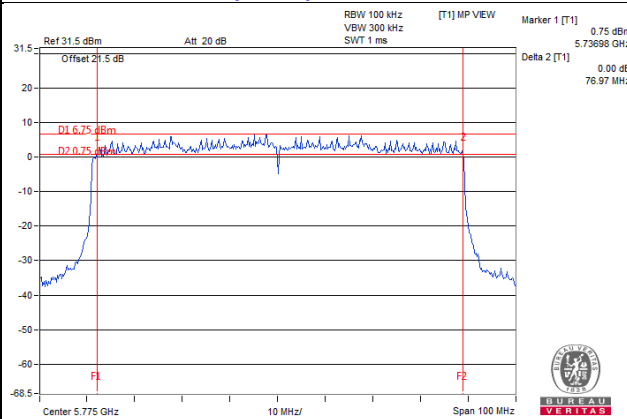

5 Pictures of Test Arrangements

Please refer to the attached file (Test Setup Photo).

Annex A- Radiated Out of Band Emission (OOBE) Measurement (For U-NII-3 band)

802.11a

CH 149 5745 MHz

Horizontal

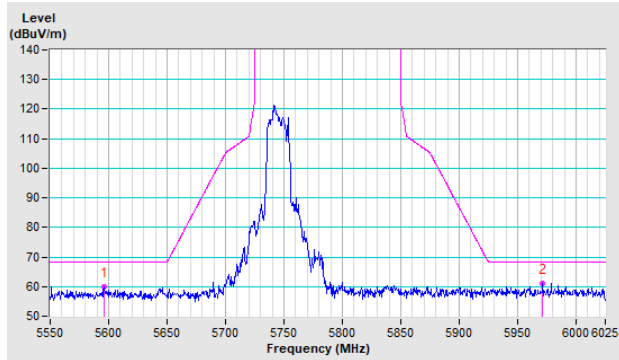

Vertical

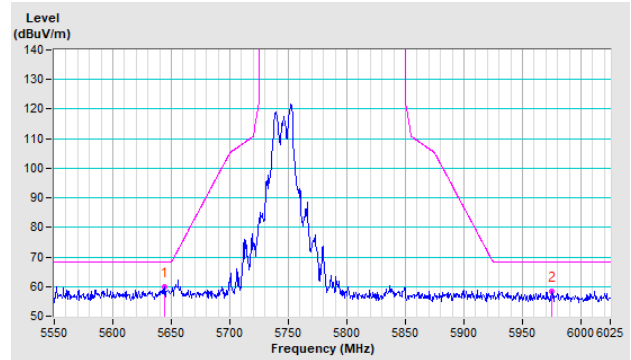

CH 157 5785 MHz

Horizontal

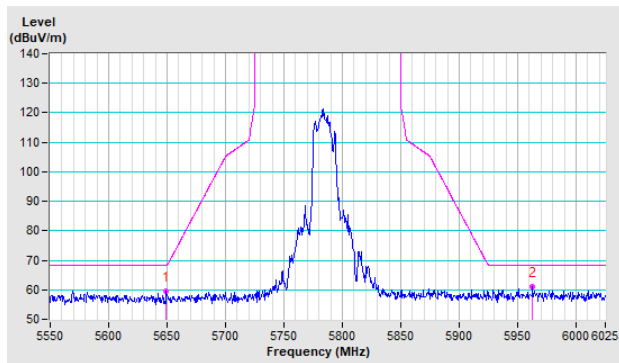

Vertical

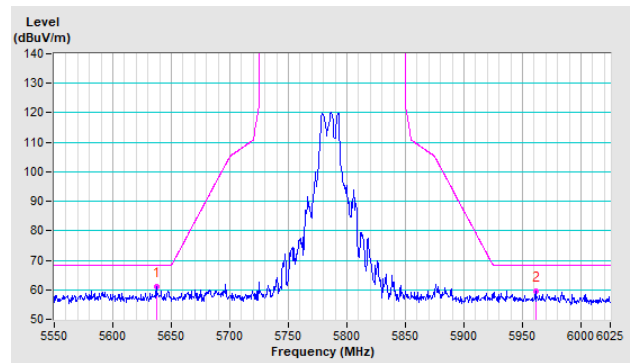

CH 165 5825 MHz

Horizontal

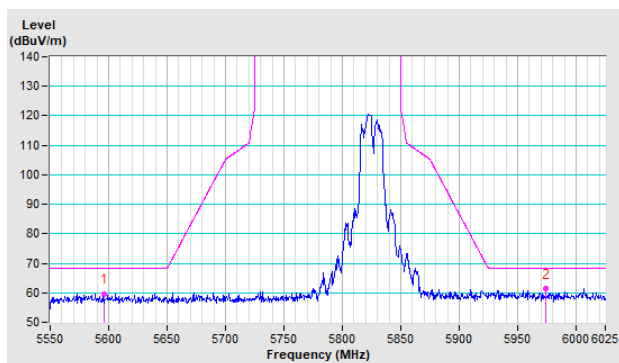

Vertical

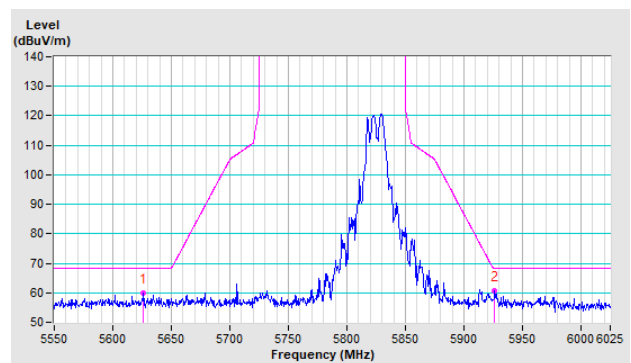

802.11ac (VHT20)

CH 149 5745 MHz

Horizontal

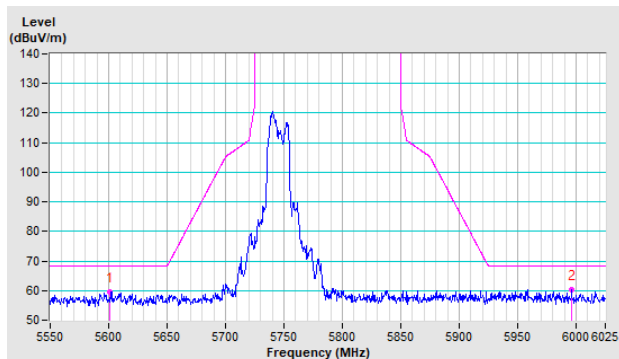

Vertical

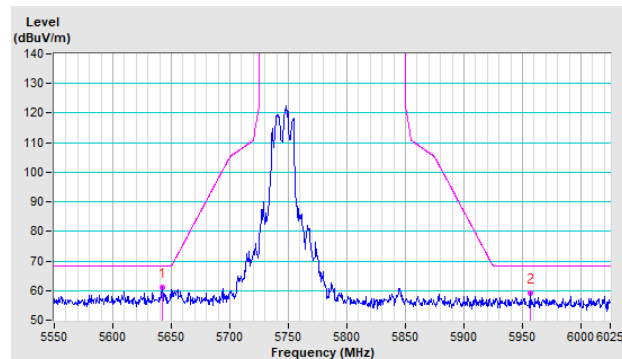

CH 157 5785 MHz

Horizontal

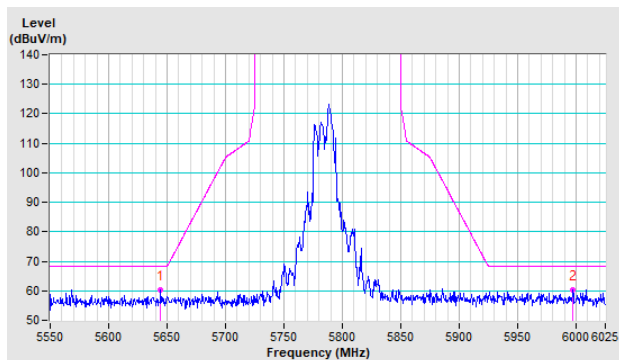

Vertical

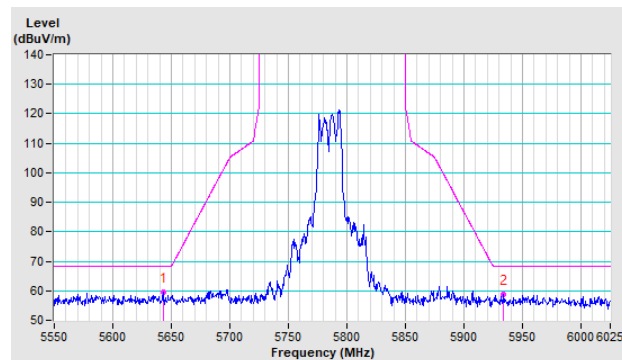

CH 165 5825 MHz

Horizontal

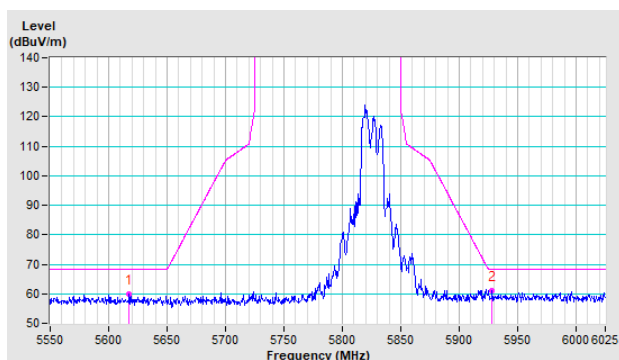

Vertical

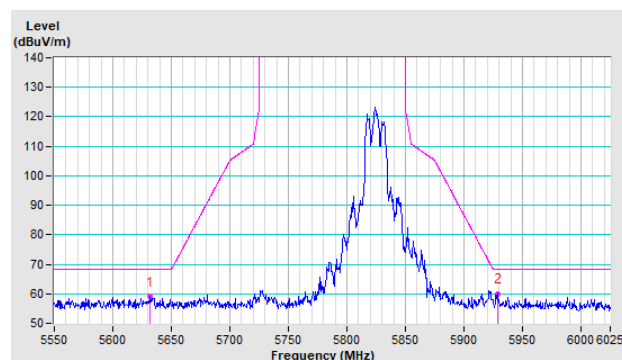

802.11ac (VHT40)

CH 151 5755 MHz

Horizontal

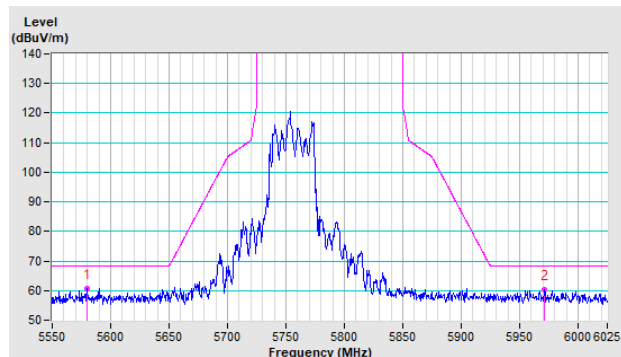

Vertical

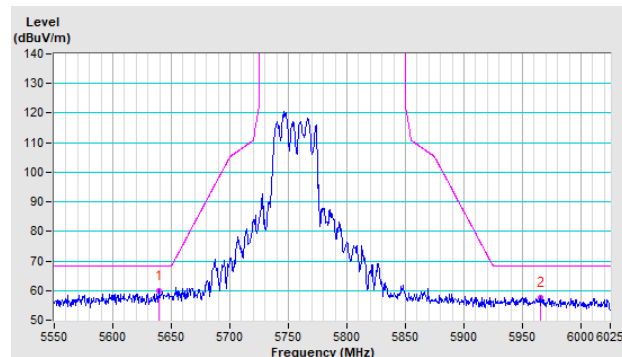

CH 159 5795 MHz

Horizontal

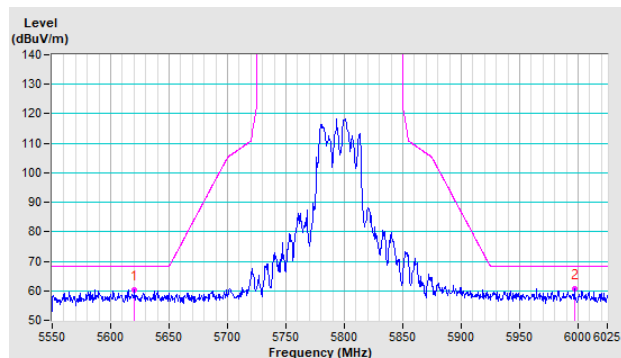

Vertical

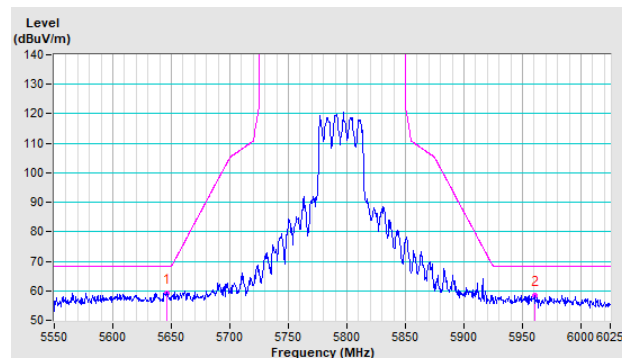

802.11ac (VHT80)

CH 155 5775 MHz

Horizontal

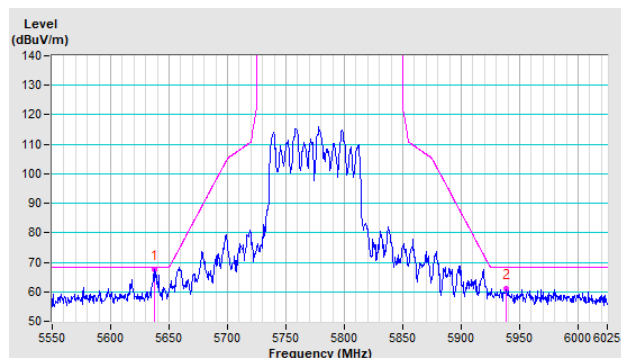

Vertical

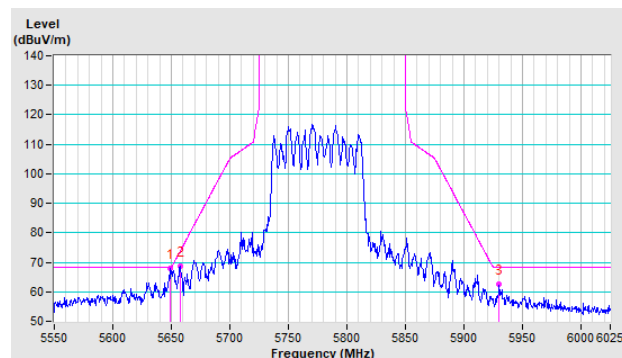

Appendix – Information of the Testing Laboratories

We, Bureau Veritas Consumer Products Services (H.K.) Ltd., Taoyuan Branch, were founded in 1988 to provide our best service in EMC, Radio, Telecom and Safety consultation. Our laboratories are FCC recognized accredited test firms and accredited according to ISO/IEC 17025.

If you have any comments, please feel free to contact us at the following:

Lin Kou EMC/RF Lab

Tel: 886-2-26052180

Fax: 886-2-26051924

Hsin Chu EMC/RF/Telecom Lab

Tel: 886-3-6668565

Fax: 886-3-6668323

Hwa Ya EMC/RF/Safety Lab

Tel: 886-3-3183232

Fax: 886-3-3270892

Email: service.adt@tw.bureauveritas.com

Web Site: www.bureauveritas-adt.com

The address and road map of all our labs can be found in our web site also.

--- END ---