

TEST REPORT

CERTIFICATE OF CONFORMITY

Standard: 47 CFR FCC Part 15, Subpart C (Section 15.247)

Report No.: RFBCKS-WTW-P23020728-2

FCC ID: NKR-LS06

Product: Touchscreen

Brand: ADT

Model No.: STS5R0-01

Received Date: 2023/3/7

Test Date: 2023/3/20 ~ 2023/4/20

Issued Date: 2023/5/2

Applicant: Wistron NeWeb Corporation

Address: 20 Park Avenue II, Hsinchu Science Park, Hsinchu 308, Taiwan, R.O.C.

Issued By: Bureau Veritas Consumer Products Services (H.K.) Ltd., Taoyuan Branch
Hsin Chu Laboratory

Lab Address: E-2, No.1, Li Hsin 1st Road, Hsinchu Science Park, Hsinchu City 300, Taiwan

Test Location: E-2, No.1, Li Hsin 1st Road, Hsinchu Science Park, Hsinchu City 300, Taiwan

FCC Registration / 723255 / TW2022

Designation Number:

Approved by:  _____, **Date:** 2023/5/2

May Chen / Manager

This test report consists of 52 pages in total. It may be duplicated completely for legal use with the approval of the applicant. It should not be reproduced except in full, without the written approval of our laboratory. The test results in the report only apply to the tested sample. The test results in this report are traceable to the national or international standards.



Prepared by : Vito Lung / Specialist

This report is governed by, and incorporates by reference, the Conditions of Testing as posted at the date of issuance of this report at <http://www.bureauveritas.com/home/about-us/our-business/cps/about-us/terms-conditions/> and is intended for your exclusive use. Any copying or replication of this report to or for any other person or entity, or use of our name or trademark, is permitted only with our prior written permission. This report sets forth our findings solely with respect to the test samples identified herein. The results set forth in this report are not indicative or representative of the quality or characteristics of the lot from which a test sample was taken or any similar or identical product unless specifically and expressly noted. Our report includes all of the tests requested by you and the results thereof based upon the information that you provided to us. Measurement uncertainty is only provided upon request for accredited tests. Statements of conformity are based on simple acceptance criteria without taking measurement uncertainty into account, unless otherwise requested in writing. You have 60 days from date of issuance of this report to notify us of any material error or omission caused by our negligence or if you require measurement uncertainty; provided, however, that such notice shall be in writing and shall specifically address the issue you wish to raise. A failure to raise such issue within the prescribed time shall constitute your unqualified acceptance of the completeness of this report, the tests conducted and the correctness of the report contents.

Table of Contents

Release Control Record	4
1 Certificate	5
2 Summary of Test Results	6
2.1 Measurement Uncertainty	6
2.2 Supplementary Information	6
3 General Information	7
3.1 General Description	7
3.2 Antenna Description of EUT	8
3.3 Channel List	9
3.4 Test Mode Applicability and Tested Channel Detail	10
3.5 Duty Cycle of Test Signal	11
3.6 Test Program Used and Operation Descriptions	12
3.7 Connection Diagram of EUT and Peripheral Devices	12
3.8 Configuration of Peripheral Devices and Cable Connections	12
4 Test Instruments	13
4.1 RF Output Power	13
4.2 Number of Hopping Frequency Used	13
4.3 Dwell Time on Each Channel	13
4.4 Hopping Channel Separation	13
4.5 20 dB Bandwidth	13
4.6 Conducted Out of Band Emissions	13
4.7 AC Power Conducted Emissions	14
4.8 Unwanted Emissions below 1 GHz	14
4.9 Unwanted Emissions above 1 GHz	15
5 Limits of Test Items	16
5.1 RF Output Power	16
5.2 Number of Hopping Frequency Used	16
5.3 Dwell Time on Each Channel	16
5.4 Hopping Channel Separation	16
5.5 20 dB Bandwidth	16
5.6 Conducted Out of Band Emissions	16
5.7 AC Power Conducted Emissions	16
5.8 Unwanted Emissions below 1 GHz	17
5.9 Unwanted Emissions above 1 GHz	17
6 Test Arrangements	18
6.1 RF Output Power	18
6.1.1 Test Setup	18
6.1.2 Test Procedure	18
6.2 Number of Hopping Frequency Used	18
6.2.1 Test Setup	18
6.2.2 Test Procedure	18
6.3 Dwell Time on Each Channel	19
6.3.1 Test Setup	19
6.3.2 Test Procedure	19
6.4 Hopping Channel Separation	19
6.4.1 Test Setup	19
6.4.2 Test Procedure	19
6.5 20 dB Bandwidth	20
6.5.1 Test Setup	20
6.5.2 Test Procedure	20
6.6 Conducted Out of Band Emissions	20
6.6.1 Test Setup	20
6.6.2 Test Procedure	20
6.7 AC Power Conducted Emissions	21



6.7.1	Test Setup	21
6.7.2	Test Procedure.....	21
6.8	Unwanted Emissions below 1 GHz	22
6.8.1	Test Setup	22
6.8.2	Test Procedure.....	23
6.9	Unwanted Emissions above 1 GHz.....	24
6.9.1	Test Setup	24
6.9.2	Test Procedure.....	24
7	Test Results of Test Item	25
7.1	RF Output Power.....	25
7.2	Number of Hopping Frequency Used.....	26
7.3	Dwell Time on Each Channel	27
7.4	Hopping Channel Separation	29
7.5	20 dB Bandwidth	30
7.6	Conducted Out of Band Emissions	31
7.7	AC Power Conducted Emissions	33
7.8	Unwanted Emissions below 1 GHz	35
7.9	Unwanted Emissions above 1 GHz.....	37
8	Pictures of Test Arrangements	51
9	Information of the Testing Laboratories	52



Release Control Record

Issue No.	Description	Date Issued
RFBCKS-WTW-P23020728-2	Original release.	2023/5/2

1 Certificate

Product: Touchscreen

Brand: ADT

Test Model: STS5R0-01

Sample Status: Engineering sample

Applicant: Wistron NeWeb Corporation

Test Date: 2023/3/20 ~ 2023/4/20

Standard: 47 CFR FCC Part 15, Subpart C (Section 15.247)

Measurement ANSI C63.10-2013

procedure: KDB 558074 D01 15.247 Meas Guidance v05r02

The above equipment has been tested by **Bureau Veritas Consumer Products Services (H.K.) Ltd., Taoyuan Branch**, and found compliance with the requirement of the above standards. The test record, data evaluation & Equipment Under Test (EUT) configurations represented herein are true and accurate accounts of the measurements of the sample's RF characteristics under the conditions specified in this report.

2 Summary of Test Results

47 CFR FCC Part 15, Subpart C (Section 15.247)			
Standard / Clause	Test Item	Result	Remark
15.247 (a)(1)	RF Output Power	Pass	Meet the requirement of limit.
15.247(a)(1) (iii)	Number of Hopping Frequency Used	Pass	Meet the requirement of limit.
15.247(a)(1) (iii)	Dwell Time on Each Channel	Pass	Meet the requirement of limit.
15.247(a)(1)	Hopping Channel Separation	Pass	Meet the requirement of limit.
15.247(a)(1)	20 dB Bandwidth	-	Refer to Note 1
15.247(d)	Conducted Out of Band Emissions	Pass	Meet the requirement of limit.
15.207	AC Power Conducted Emissions	Pass	Minimum passing margin is -16.75 dB at 26.75781 MHz
15.205 / 15.209 / 15.247(d)	Unwanted Emissions below 1 GHz	Pass	Minimum passing margin is -9.9 dB at 44.48 MHz
15.205 / 15.209 / 15.247(d)	Unwanted Emissions above 1 GHz	Pass	Minimum passing margin is -8.6 dB at 2483.50 MHz
15.203	Antenna Requirement	Pass	Antenna connector is ipex(MHF) not a standard connector.

Notes:

1. If the Frequency Hopping System operating in 2400-2483.5 MHz band and the output power less than 125 mW. The hopping channel carrier frequencies separated by a minimum of 25 kHz or two-thirds of the 20 dB bandwidth of hopping channel whichever is greater.
2. Determining compliance based on the results of the compliance measurement, not taking into account measurement instrumentation uncertainty.

2.1 Measurement Uncertainty

Where relevant, the following measurement uncertainty levels have been estimated for tests performed on the EUT as specified in CISPR 16-4-2:

Measurement	Specification	Expanded Uncertainty (k=2) (±)
Conducted Out of Band Emissions	9 kHz ~ 40 GHz	2.5 dB
AC Power Conducted Emissions	150 kHz ~ 30 MHz	1.9 dB
Unwanted Emissions below 1 GHz	9 kHz ~ 30 MHz	3.1 dB
	30 MHz ~ 1 GHz	5.1 dB
Unwanted Emissions above 1 GHz	1 GHz ~ 18 GHz	5.0 dB
	18 GHz ~ 40 GHz	5.3 dB

The other instruments specified are routine verified to remain within the calibrated levels, no measurement uncertainty is required to be calculated.

2.2 Supplementary Information

There is not any deviation from the test standards for the test method, and no modifications required for compliance.

3 General Information

3.1 General Description

Product	Touchscreen
Brand	ADT
Test Model	STS5R0-01
Status of EUT	Engineering sample
Power Supply Rating	12 Vdc from adapter 3.8 Vdc from battery
Modulation Type	GFSK, $\pi/4$ -DQPSK, 8DPSK
Modulation Technology	FHSS
Transfer Rate	Up to 3 Mbps
Operating Frequency	2.402 GHz ~ 2.48 GHz
Number of Channel	79
Output Power	27.861 mW (14.45 dBm)

Note:

1. The EUT must be supplied with battery and following table:

Battery 1		
Brand	Model	Specification
Tenergy	34434	Power Rating : 3.8-4.35Vdc, 2100mAh 7.98Wh

2. The EUT uses following accessories.

AC Adapter 1		
Brand	Model	Specification
ADT	1A101-1215-02	AC Input : 100-120V, 500mA, 50-60Hz DC Output : 12V, 1.5A DC Output Cable : 1.5m Plug : US
AC Adapter 2		
Brand	Model	Specification
ADT	1A102-1215	AC Input : 100-120V, 500mA, 50-60Hz DC Output : 12V, 1.5A DC Output Cable : 0.5m Plug : US

3. Simultaneously transmission condition.

Condition	Technology			
1	WLAN (2.4 GHz)	WLAN (5 GHz)	Bluetooth	DECT

Note: The emission of the simultaneous operation has been evaluated and no non-compliance was found.

4. The above EUT information is declared by manufacturer and for more detailed features description, please refer to the manufacturer's specifications or user's manual.

3.2 Antenna Description of EUT

1. The antenna information is listed as below.

Antenna NO.	RF Chain NO.	Brand	Model	Antenna Net Gain(dBi)	Frequency range	Antenna Type	Connector Type
WLAN1	ANT0	WNC	LS06	2.07	2.4~2.4835GHz	PIFA	ipex(MHF)
				3.62	5.15~5.25GHz		
				3.62	5.25~5.35GHz		
				3.41	5.47~5.725GHz		
				3.41	5.725~5.85GHz		
WLAN2/BT	ANT1	WNC	LS06	2.07	2.4~2.4835GHz	PIFA	ipex(MHF)
				3.95	5.15~5.25GHz		
				3.95	5.25~5.35GHz		
				3.42	5.47~5.725GHz		
				3.42	5.725~5.85GHz		

* Detail antenna specification please refer to antenna datasheet and/or antenna measurement report.

3.3 Channel List

79 channels are provided for BT-EDR:

Channel	Frequency (MHz)	Channel	Frequency (MHz)	Channel	Frequency (MHz)	Channel	Frequency (MHz)
0	2402	20	2422	40	2442	60	2462
1	2403	21	2423	41	2443	61	2463
2	2404	22	2424	42	2444	62	2464
3	2405	23	2425	43	2445	63	2465
4	2406	24	2426	44	2446	64	2466
5	2407	25	2427	45	2447	65	2467
6	2408	26	2428	46	2448	66	2468
7	2409	27	2429	47	2449	67	2469
8	2410	28	2430	48	2450	68	2470
9	2411	29	2431	49	2451	69	2471
10	2412	30	2432	50	2452	70	2472
11	2413	31	2433	51	2453	71	2473
12	2414	32	2434	52	2454	72	2474
13	2415	33	2435	53	2455	73	2475
14	2416	34	2436	54	2456	74	2476
15	2417	35	2437	55	2457	75	2477
16	2418	36	2438	56	2458	76	2478
17	2419	37	2439	57	2459	77	2479
18	2420	38	2440	58	2460	78	2480
19	2421	39	2441	59	2461		

3.4 Test Mode Applicability and Tested Channel Detail

Pre-Scan:	<p>1. The Power Source have the following models: Adapter (1A101-1215-02) / Adapter (1A101-1215-02) / Battery (34434). Pre-scan these models of AC Adapters and find the worst case as a representative test condition.</p> <p>2. EUT can be used in the following ways: X-axis/ Y-axis/ Z-axis. Pre-scan these ways and find the worst case as a representative test condition.</p> <p>3. Pre-Scan has been conducted to determine the worst-case mode from all possible combinations between available modulations, data rates and antenna ports (if EUT with antenna diversity architecture).</p>
Worst Case:	<p>1. Power Source Worst Condition: Adapter (1A101-1215-02)</p> <p>2. X-axis/ Y-axis/ Z-axis Worst Condition: For Unwanted Emissions Above 1GHz : X-axis, For Unwanted Emissions below 1GHz : X-axis</p>

Following channel(s) was (were) selected for the final test as listed below:

Test Item	Tested Channel	Modulation	Data Rate Parameter
RF Output Power	0, 39, 78	GFSK	DH5
		8DPSK	3DH5
Number of Hopping Frequency Used	Hopping	GFSK	DH5
		8DPSK	3DH5
Dwell Time on Each Channel	Hopping	GFSK	DH1/DH3/DH5
		8DPSK	3DH1/3DH3/3DH5
Hopping Channel Separation / 20 dB Bandwidth	0, 39, 78	GFSK	DH5
		8DPSK	3DH5
Conducted Out of Band Emissions	Hopping 0, 78	GFSK	DH5
		8DPSK	3DH5
AC Power Conducted Emissions	78	GFSK	DH5
Unwanted Emissions below 1 GHz	78	GFSK	DH5
Unwanted Emissions above 1 GHz	0, 39, 78	GFSK	DH5

3.5 Duty Cycle of Test Signal

GFSK: Duty cycle = 2.89 ms / 100 ms x 100% = 2.9%

8DPSK: Duty cycle = 2.9 ms / 100 ms x 100% = 2.9%

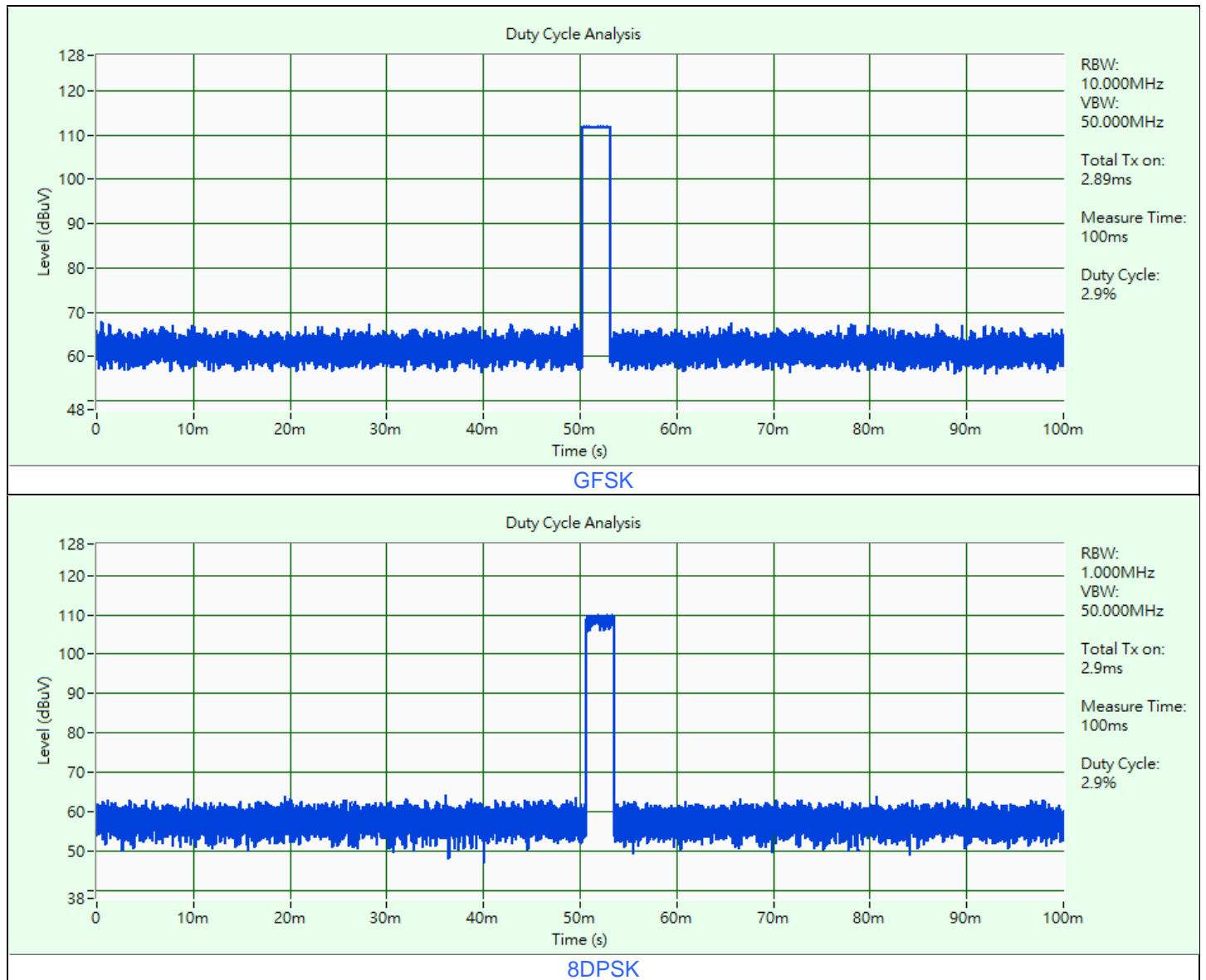

3.6 Test Program Used and Operation Descriptions

Controlling software (adb paste LS06_BT command) has been activated to set the EUT under transmission condition continuously at specific channel frequency.

3.7 Connection Diagram of EUT and Peripheral Devices

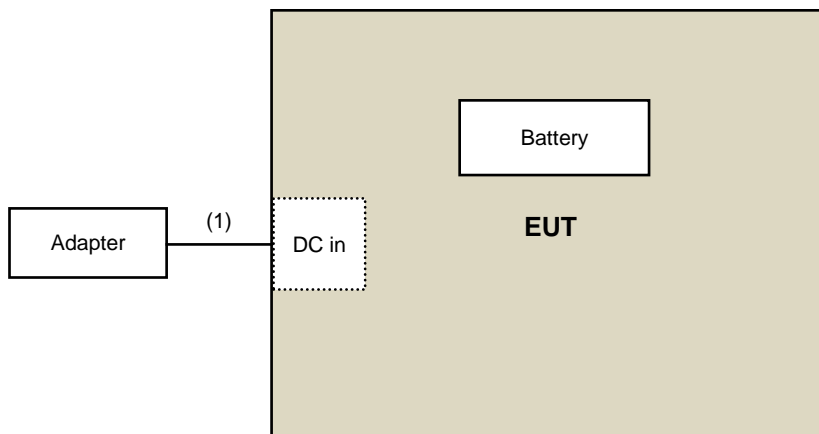

3.8 Configuration of Peripheral Devices and Cable Connections

ID	Cable Descriptions	Qty.	Length (m)	Shielding (Yes/No)	Cores (Qty.)	Remarks
1	DC Cable	1	1.5	No	0	Supplied by applicant

4 Test Instruments

The calibration interval of the all test instruments are 12 months and the calibrations are traceable to NML/ROC and NIST/USA.

4.1 RF Output Power

Description Manufacturer	Model No.	Serial No.	Calibrated Date	Calibrated Until
Power Meter Anritsu	ML2495A	1529002	2022/6/22	2023/6/21
Pulse Power Sensor Anritsu	MA2411B	1726434	2022/6/22	2023/6/21

Notes:

1. The test was performed in Oven room 2.
2. Tested Date: 2023/4/11

4.2 Number of Hopping Frequency Used

Description Manufacturer	Model No.	Serial No.	Calibrated Date	Calibrated Until
Attenuator WOKEN	MDCS18N-10	MDCS18N-10-01	2023/3/27	2024/3/26
Software	ADT_RF Test Software V6.6.5.4	N/A	N/A	N/A
Spectrum Analyzer Keysight	N9020B	MY60112409	2023/2/18	2024/2/17

Notes:

1. The test was performed in Oven room 2.
2. Tested Date: 2023/4/11

4.3 Dwell Time on Each Channel

Refer to section 4.2 to get information of the instruments.

4.4 Hopping Channel Separation

Refer to section 4.2 to get information of the instruments.

4.5 20 dB Bandwidth

Refer to section 4.2 to get information of the instruments.

4.6 Conducted Out of Band Emissions

Refer to section 4.2 to get information of the instruments.

4.7 AC Power Conducted Emissions

Description Manufacturer	Model No.	Serial No.	Calibrated Date	Calibrated Until
50 ohm terminal resistance	N/A	EMC-01	2022/9/27	2023/9/26
Fixed attenuator STI	STI02-2200-10	005	2022/8/24	2023/8/23
LISN R&S	ESH3-Z5	848773/004	2022/10/18	2023/10/17
RF Coaxial Cable JYEBO	5D-FB	COCCAB-001	2022/8/24	2023/8/23
Software BVADT	BVADT_Cond_V7.3.7.4	N/A	N/A	N/A
TEST RECEIVER R&S	ESCS 30	847124/029	2022/10/14	2023/10/13

Notes:

1. The test was performed in Conduction 1
2. Tested Date: 2023/4/20

4.8 Unwanted Emissions below 1 GHz

Description Manufacturer	Model No.	Serial No.	Calibrated Date	Calibrated Until
Bilog Antenna Schwarzbeck	VULB 9168	9168-0942	2022/10/20	2023/10/19
Boresight Antenna Tower & Turn Table Max-Full	MF-7802BS	MF780208530	N/A	N/A
Fixed attenuator Mini-Circuits	UNAT-5+	PAD-ATT5-01	2022/12/28	2023/12/27
LOOP ANTENNA Electro-Metrics	EM-6879	264	2023/2/21	2024/2/20
Pre_Amplifier EMCI	EMC001340	980142	2022/6/2	2023/6/1
Pre_Amplifier(20M-3G) EMCI	EMC330N	980852	2023/2/20	2024/2/19
RF Coaxial Cable COMMATE/PEWC	8D	966-6-1	2023/4/6	2024/4/5
		966-6-2	2023/4/6	2024/4/5
		966-6-3	2023/4/6	2024/4/5
RF Coaxial Cable JYEBO	5D-FB	LOOPCAB-001	2022/12/19	2023/12/18
		LOOPCAB-002	2022/12/19	2023/12/18
Software	ADT_Radiated_V8.7.08	N/A	N/A	N/A
Spectrum Analyzer Keysight	N9020B	MY60112410	2023/3/6	2024/3/5
Test Receiver KEYSIGHT	N9038A	MY59050100	2022/6/20	2023/6/19

Notes:

1. The test was performed in 966 Chamber No. 6.
2. Tested Date: 2023/4/19

4.9 Unwanted Emissions above 1 GHz

Description Manufacturer	Model No.	Serial No.	Calibrated Date	Calibrated Until
Boresight Antenna Tower & Turn Table Max-Full	MF-7802BS	MF780208530	N/A	N/A
Horn Antenna Schwarzbeck	BBHA 9120D	9120D-2035	2022/11/13	2023/11/12
	BBHA 9170	BBHA9170519	2022/11/13	2023/11/12
Pre_Amplifier EMCI	EMC12630SE	980385	2022/8/15	2023/8/14
	EMC184045SE	980387	2022/12/28	2023/12/27
RF Cable EMCI	EMC104-SM-SM-1300	210205	2022/5/10	2023/5/9
RF Cable-Frequency range: 1- 40GHz EMCI	EMC102-KM-KM-1200	160924	2022/12/28	2023/12/27
RF Coaxial Cable EMCI	EMC-KM-KM-4000	200214	2023/2/20	2024/2/19
	EMC101G-KM-KM-10000	210708	2022/11/4	2023/11/3
Software	ADT_Radiated_V8.7.08	N/A	N/A	N/A
Spectrum Analyzer Keysight	N9020B	MY60112410	2023/3/6	2024/3/5
Test Receiver KEYSIGHT	N9038A	MY59050100	2022/6/20	2023/6/19

Notes:

1. The test was performed in 966 Chamber No. 6.
2. Tested Date: 2023/3/20 ~ 2023/4/19

5 Limits of Test Items

5.1 RF Output Power

The Maximum Output Power Measurement is 125 mW (21 dBm).

5.2 Number of Hopping Frequency Used

At least 15 channels frequencies, and should be equally spaced.

5.3 Dwell Time on Each Channel

The average time of occupancy on any channel shall not be greater than 0.4 seconds within a period of 0.4 seconds multiplied by the number of hopping channels employed.

5.4 Hopping Channel Separation

At least 25 kHz or two-third of 20 dB hopping channel bandwidth (whichever is greater).

5.5 20 dB Bandwidth

Maximum bandwidth is not specified.

5.6 Conducted Out of Band Emissions

Below 20 dB of the highest emission level of operating band (in 100 kHz Resolution Bandwidth).

5.7 AC Power Conducted Emissions

Frequency (MHz)	Conducted Limit (dBuV)	
	Quasi-peak	Average
0.15 - 0.5	66 - 56	56 - 46
0.50 - 5.0	56	46
5.0 - 30.0	60	50

Notes:

1. The lower limit shall apply at the transition frequencies.
2. The limit decreases in line with the logarithm of the frequency in the range of 0.15 to 0.50 MHz.

5.8 Unwanted Emissions below 1 GHz

Radiated emissions up to 1 GHz which fall in the restricted bands must comply with the radiated emission limits specified as below table. Other emissions shall be at least 20 dB below the highest level of the desired power:

Frequencies (MHz)	Field Strength (microvolts/meter)	Measurement Distance (meters)
0.009 ~ 0.490	2400/F(kHz)	300
0.490 ~ 1.705	24000/F(kHz)	30
1.705 ~ 30.0	30	30
30 ~ 88	100	3
88 ~ 216	150	3
216 ~ 960	200	3
Above 960	500	3

Notes:

1. The lower limit shall apply at the transition frequencies.
2. Emission level (dBuV/m) = 20 log Emission level (uV/m).

5.9 Unwanted Emissions above 1 GHz

Radiated emissions above 1 GHz which fall in the restricted bands must comply with the radiated emission limits specified as below table. Other emissions shall be at least 20 dB below the highest level of the desired power:

Frequencies (MHz)	Field Strength (microvolts/meter)	Measurement Distance (meters)
Above 960	500	3

Notes:

1. The lower limit shall apply at the transition frequencies.
2. Emission level (dBuV/m) = 20 log Emission level (uV/m).
3. For frequencies above 1000 MHz, the field strength limits are based on average detector, however, the peak field strength of any emission shall not exceed the maximum permitted average limits, specified above by more than 20 dB under any condition of modulation.

6 Test Arrangements

6.1 RF Output Power

6.1.1 Test Setup

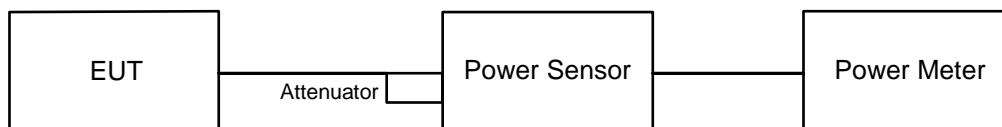

6.1.2 Test Procedure

Peak Power:

A peak power sensor was used on the output port of the EUT. A power meter was used to read the response of the peak power sensor. Record the power level.

Average Power:

Average power sensor was used to perform output power measurement, trigger and gating function of wide band power meter is enabled to measure max output power of TX on burst. Duty factor is not added to measured value.

6.2 Number of Hopping Frequency Used

6.2.1 Test Setup

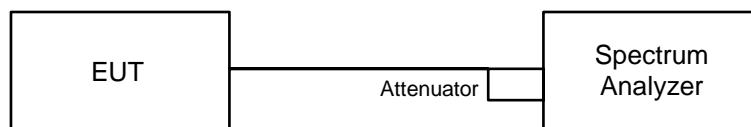

6.2.2 Test Procedure

- a. Check the calibration of the measuring instrument (SA) using either an internal calibrator or a known signal from an external generator.
- b. Turn on the EUT and connect its antenna terminal to measurement via a low loss cable. Then set it to any one measured frequency within its operating range and make sure the instrument is operated in its linear range.
- c. Set the SA on MaxHold Mode, and then keep the EUT in hopping mode. Record all the signals from each channel until each one has been recorded.
- d. Set the SA on View mode and then plot the result on SA screen.
- e. Repeat above procedures until all frequencies measured were complete.

6.3 Dwell Time on Each Channel

6.3.1 Test Setup

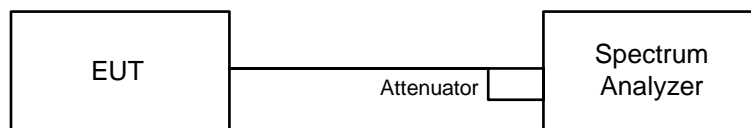

6.3.2 Test Procedure

- Check the calibration of the measuring instrument (SA) using either an internal calibrator or a known signal from an external generator.
- Turn on the EUT and connect its antenna terminal to measurement via a low loss cable. Then set it to any one measured frequency within its operating range and make sure the instrument is operated in its linear range.
- Adjust the center frequency of SA on any frequency to be measured and set SA to zero span mode. And then, set RBW and VBW of spectrum analyzer to proper value.
- Measure the time duration of one transmission on the measured frequency. And then plot the result with time difference of this time duration.
- Repeat above procedures until all different time-slot modes have been completed.

6.4 Hopping Channel Separation

6.4.1 Test Setup

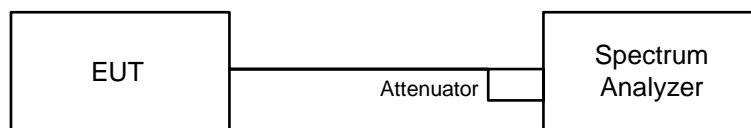

6.4.2 Test Procedure

- Check the calibration of the measuring instrument using either an internal calibrator or a known signal from an external generator.
- Turn on the EUT and connect it to measurement instrument. Then set it to any one convenient frequency within its operating range.
- By using the MaxHold function record the separation of two adjacent channels.
- Measure the frequency difference of these two adjacent channels by SA MARK function. And then plot the result on SA screen.
- Repeat above procedures until all frequencies measured were complete.

6.5 20 dB Bandwidth

6.5.1 Test Setup



6.5.2 Test Procedure

- Check the calibration of the measuring instrument using either an internal calibrator or a known signal from an external generator.
- Turn on the EUT and connect it to measurement instrument. Then set it to any one convenient frequency within its operating range. Set a reference level on the measuring instrument equal to the highest peak value.
- Measure the frequency difference of two frequencies that were attenuated 20 dB from the reference level. Record the frequency difference as the emission bandwidth.
- Repeat above procedures until all frequencies measured were complete.

6.6 Conducted Out of Band Emissions

6.6.1 Test Setup

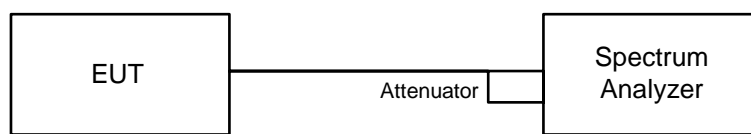

6.6.2 Test Procedure

MEASUREMENT PROCEDURE REF

- Set the RBW = 100 kHz.
- Set the VBW \geq 300 kHz.
- Detector = peak.
- Sweep time = auto couple.
- Trace mode = max hold.
- Allow trace to fully stabilize.
- Use the peak marker function to determine the maximum power level in any 100 kHz band segment within the fundamental EBW.

MEASUREMENT PROCEDURE OOB

- Set RBW = 100 kHz.
- Set VBW \geq 300 kHz.
- Detector = peak.
- Sweep = auto couple.
- Trace Mode = max hold.
- Allow trace to fully stabilize.
- Use the peak marker function to determine the maximum amplitude level.

6.7 AC Power Conducted Emissions

6.7.1 Test Setup

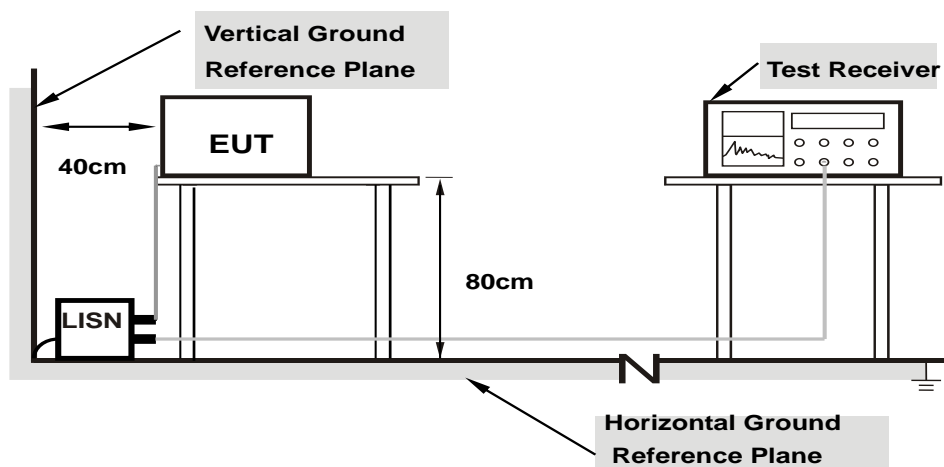

Note: 1.Support units were connected to second LISN.

For the actual test configuration, please refer to the attached file (Test Setup Photo).

6.7.2 Test Procedure

- The EUT was placed on a 0.8 meter to the top of table and placed 0.4 meters from the conducting wall of the shielded room with EUT being connected to the power mains through a line impedance stabilization network (LISN). Other support units were connected to the power mains through another LISN. The two LISNs provide 50 ohm/ 50 uH of coupling impedance for the measuring instrument.
- Both lines of the power mains connected to the EUT were checked for maximum conducted interference.
- The frequency range from 150 kHz to 30 MHz was searched. Emission levels under (Limit – 20 dB) was not recorded.

Note: The resolution bandwidth and video bandwidth of test receiver is 9 kHz for quasi-peak detection (QP) and average detection (AV) at frequency 0.15 MHz-30 MHz.

6.8 Unwanted Emissions below 1 GHz

6.8.1 Test Setup

For Radiated emission below 30 MHz

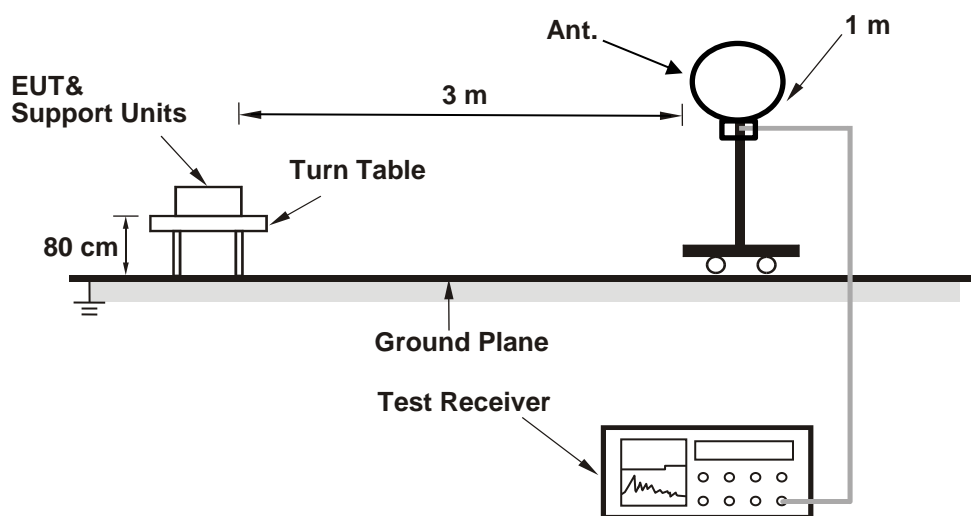

For Radiated emission above 30 MHz

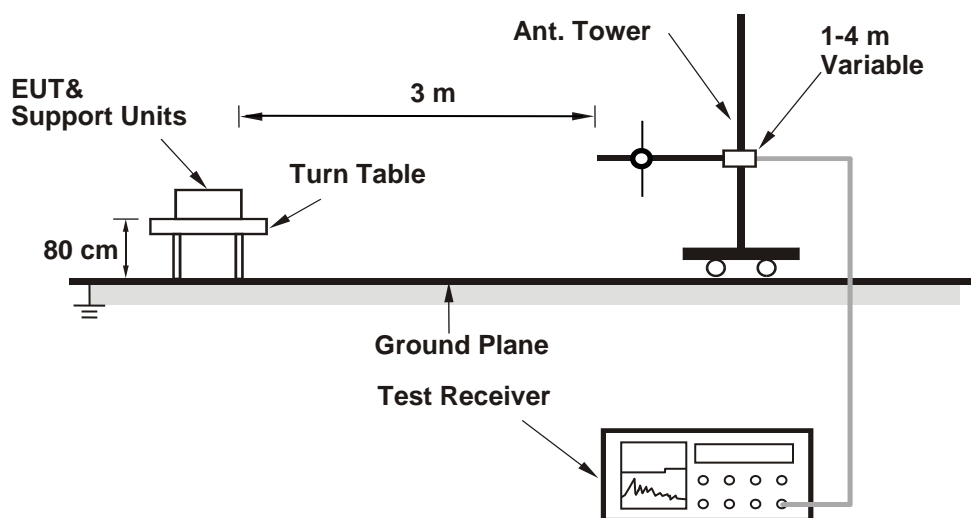

For the actual test configuration, please refer to the attached file (Test Setup Photo).

6.8.2 Test Procedure

For Radiated emission below 30 MHz

- a. The EUT was placed on the top of a rotating table 0.8 meters above the ground at 3 meter chamber room for test. The table was rotated 360 degrees to determine the position of the highest radiation.
- b. The EUT was set 3 meters away from the interference-receiving antenna, which was mounted on the top of a variable-height antenna tower.
- c. Parallel, perpendicular, and ground-parallel orientations of the antenna are set to make the measurement.
- d. For each suspected emission, the EUT was arranged to its worst case and the rotatable table was turned from 0 degrees to 360 degrees to find the maximum reading.
- e. The test-receiver system was set to Quasi-Peak Detect Function and Specified Bandwidth with Maximum Hold Mode, except for the frequency band (9 kHz to 90 kHz and 110 kHz to 490 kHz) set to average detect function and peak detect function.

Notes:

1. The resolution bandwidth and video bandwidth of test receiver/spectrum analyzer is 200 Hz at frequency below 150 kHz.
2. The resolution bandwidth and video bandwidth of test receiver/spectrum analyzer is 9 kHz or 10 kHz at frequency (150 kHz to 30 MHz).
3. All modes of operation were investigated and the worst-case emissions are reported.

For Radiated emission above 30 MHz

- a. The EUT was placed on the top of a rotating table 0.8 meters above the ground at 3 meter chamber room for test. The table was rotated 360 degrees to determine the position of the highest radiation.
- b. The EUT was set 3 meters away from the interference-receiving antenna, which was mounted on the top of a variable-height antenna tower.
- c. The height of antenna is varied from one meter to four meters above the ground to determine the maximum value of the field strength. Both horizontal and vertical polarizations of the antenna are set to make the measurement.
- d. For each suspected emission, the EUT was arranged to its worst case and then the antenna was tuned to heights from 1 meter to 4 meters and the rotatable table was turned from 0 degrees to 360 degrees to find the maximum reading.
- e. The test-receiver system was set to quasi-peak detect function and specified bandwidth with maximum hold mode when the test frequency is below 1 GHz.

Notes:

1. The resolution bandwidth and video bandwidth of test receiver/spectrum analyzer is 120 kHz for Quasi-peak detection (QP) at frequency below 1 GHz.
2. All modes of operation were investigated and the worst-case emissions are reported.

6.9 Unwanted Emissions above 1 GHz

6.9.1 Test Setup

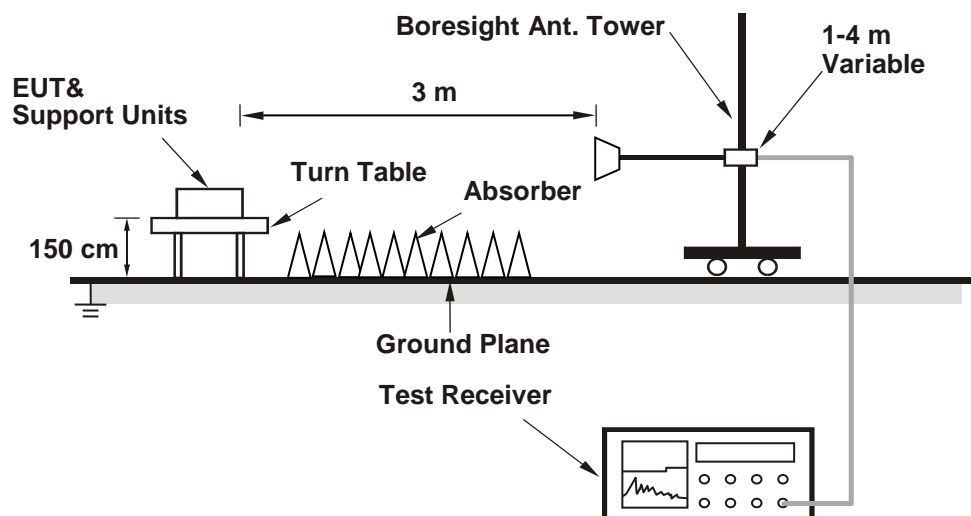

For the actual test configuration, please refer to the attached file (Test Setup Photo).

6.9.2 Test Procedure

- The EUT was placed on the top of a rotating table 1.5 meters above the ground at 3 meter chamber room for test. The table was rotated 360 degrees to determine the position of the highest radiation.
- The EUT was set 3 meters away from the interference-receiving antenna, which was mounted on the top of a variable-height antenna tower.
- The height of antenna is varied from one meter to four meters above the ground to determine the maximum value of the field strength. Both horizontal and vertical polarizations of the antenna are set to make the measurement.
- For each suspected emission, the EUT was arranged to its worst case and then the antenna was tuned to heights from 1 meter to 4 meters and the rotatable table was turned from 0 degrees to 360 degrees to find the maximum reading.
- The test-receiver system was set to peak and average detects function and specified bandwidth with maximum hold mode when the test frequency is above 1 GHz. If the peak reading value also meets average limit, measurement with the average detector is unnecessary.

Notes:

- The resolution bandwidth of test receiver/spectrum analyzer is 1 MHz and the video bandwidth is 3 MHz for Peak detection (PK) and Average detection (AV) at frequency above 1 GHz.
- According to ANSI C63.10 section 6.6.4 and 4.1.4.2.2. For fundamental and harmonic signal measurement, according to ANSI C63.10 section 7.5, the average value = peak value + duty cycle correction factor. For duty cycle correction factor values, see the Test Signal Duty Cycle section in this report.
- All modes of operation were investigated and the worst-case emissions are reported.

7 Test Results of Test Item

7.1 RF Output Power

Input Power:	120 Vac, 60 Hz	Environmental Conditions:	25°C, 65% RH	Tested By:	Katina Lu
--------------	----------------	---------------------------	--------------	------------	-----------

For Peak Power

GFSK

Chan.	Chan. Freq. (MHz)	Peak Power (mW)	Peak Power (dBm)	Power Limit (dBm)	Test Result
0	2402	25.293	14.03	21	Pass
39	2441	26.182	14.18	21	Pass
78	2480	27.861	14.45	21	Pass

Note: The antenna gain is 2.07 dBi < 6 dBi, so the output power limit shall not be reduced.

8DPSK

Chan.	Chan. Freq. (MHz)	Peak Power (mW)	Peak Power (dBm)	Power Limit (dBm)	Test Result
0	2402	14.454	11.60	21	Pass
39	2441	18.281	12.62	21	Pass
78	2480	16.943	12.29	21	Pass

Note: The antenna gain is 2.07 dBi < 6 dBi, so the output power limit shall not be reduced.

For Average Power

GFSK

Chan.	Chan. Freq. (MHz)	Average Power (mW)	Average Power (dBm)
0	2402	24.155	13.83
39	2441	24.378	13.87
78	2480	26.546	14.24

8DPSK

Chan.	Chan. Freq. (MHz)	Average Power (mW)	Average Power (dBm)
0	2402	8.054	9.06
39	2441	9.772	9.90
78	2480	9.162	9.62

7.2 Number of Hopping Frequency Used

Input Power:	120 Vac, 60 Hz	Environmental Conditions:	25°C, 65% RH	Tested By:	Katina Lu
--------------	----------------	---------------------------	--------------	------------	-----------

GFSK

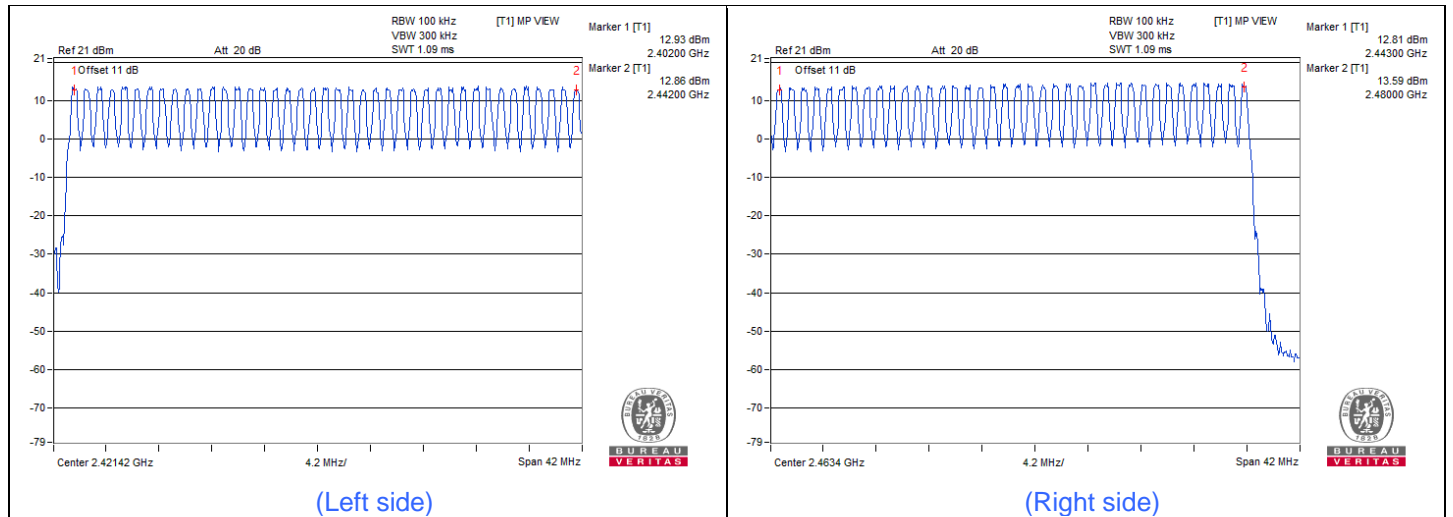

Note: There are 79 hopping frequencies in the hopping mode. On the plots, it shows that the hopping frequencies are equally spaced.

8DPSK

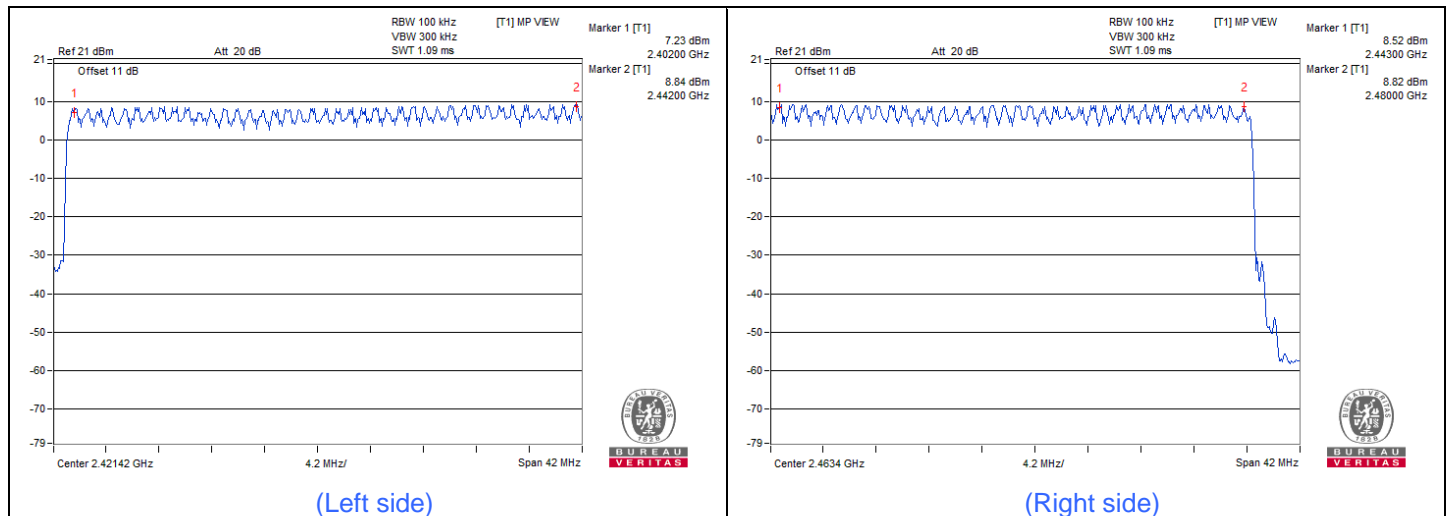

Note: There are 79 hopping frequencies in the hopping mode. On the plots, it shows that the hopping frequencies are equally spaced.



7.3 Dwell Time on Each Channel

Input Power:	120 Vac, 60 Hz	Environmental Conditions:	25°C, 65% RH	Tested By:	Katina Lu
--------------	----------------	---------------------------	--------------	------------	-----------

GFSK

Mode	Number of transmission in 31.6 sec	Length of transmission time (msec)	Result (msec)	Limit (msec)	Test Result
DH1	50 (times / 5 sec) * 6.32 = 316 times	0.435	137.46	400	Pass
DH3	27 (times / 5 sec) * 6.32 = 171 times	1.703	291.21	400	Pass
DH5	17 (times / 5 sec) * 6.32 = 108 times	2.992	323.14	400	Pass

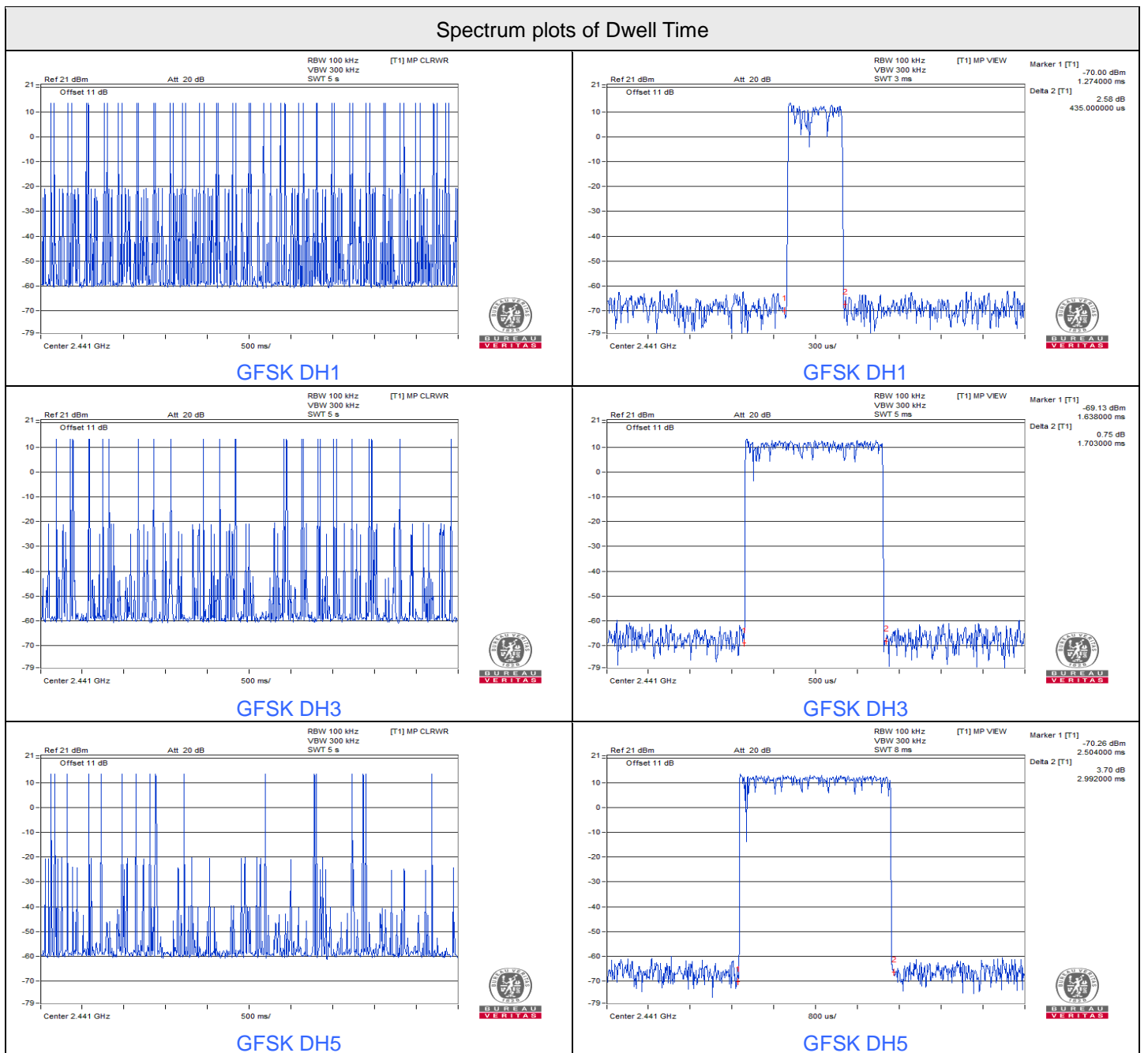

8DPSK

Mode	Number of transmission in 31.6 sec	Length of transmission time (msec)	Result (msec)	Limit (msec)	Test Result
3DH1	51 (times / 5 sec) * 6.32 = 323 times	0.443	143.09	400	Pass
3DH3	26 (times / 5 sec) * 6.32 = 165 times	1.696	279.84	400	Pass
3DH5	17 (times / 5 sec) * 6.32 = 108 times	2.98	321.84	400	Pass

Spectrum plots of Dwell Time

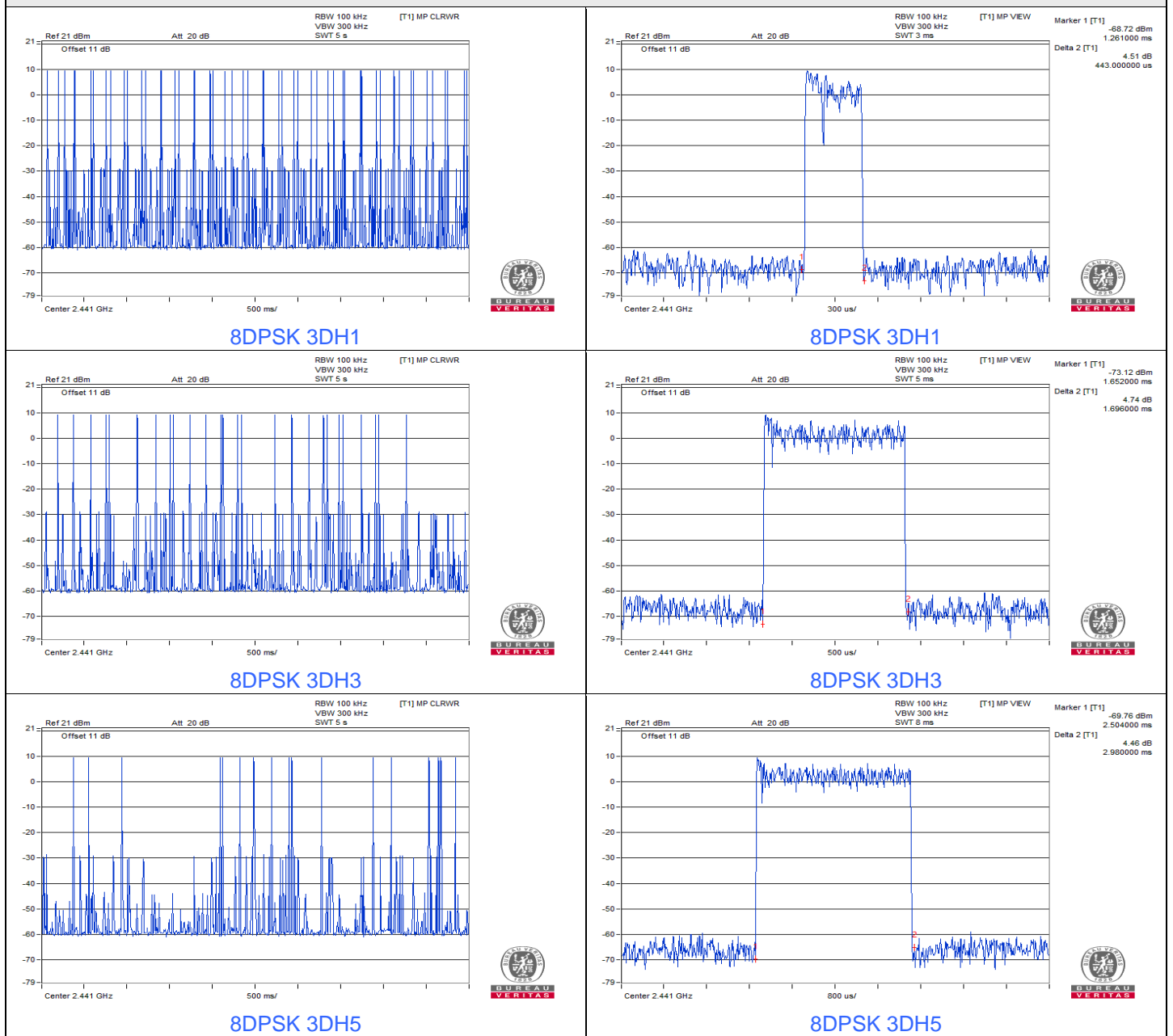

7.4 Hopping Channel Separation

Input Power:	120 Vac, 60 Hz	Environmental Conditions:	25°C, 65% RH	Tested By:	Katina Lu
--------------	----------------	---------------------------	--------------	------------	-----------

GFSK

Channel	Frequency (MHz)	Hopping Channel Separation (MHz)	Minimum Limit (MHz)	Test Result
0	2402	1.00	0.67	Pass
39	2441	1.00	0.67	Pass
78	2480	1.00	0.66	Pass

Note: The minimum limit is two-third 20dB bandwidth.

8DPSK

Channel	Frequency (MHz)	Hopping Channel Separation (MHz)	Minimum Limit (MHz)	Test Result
0	2402	1.00	0.88	Pass
39	2441	1.00	0.88	Pass
78	2480	1.00	0.88	Pass

Note: The minimum limit is two-third 20dB bandwidth.

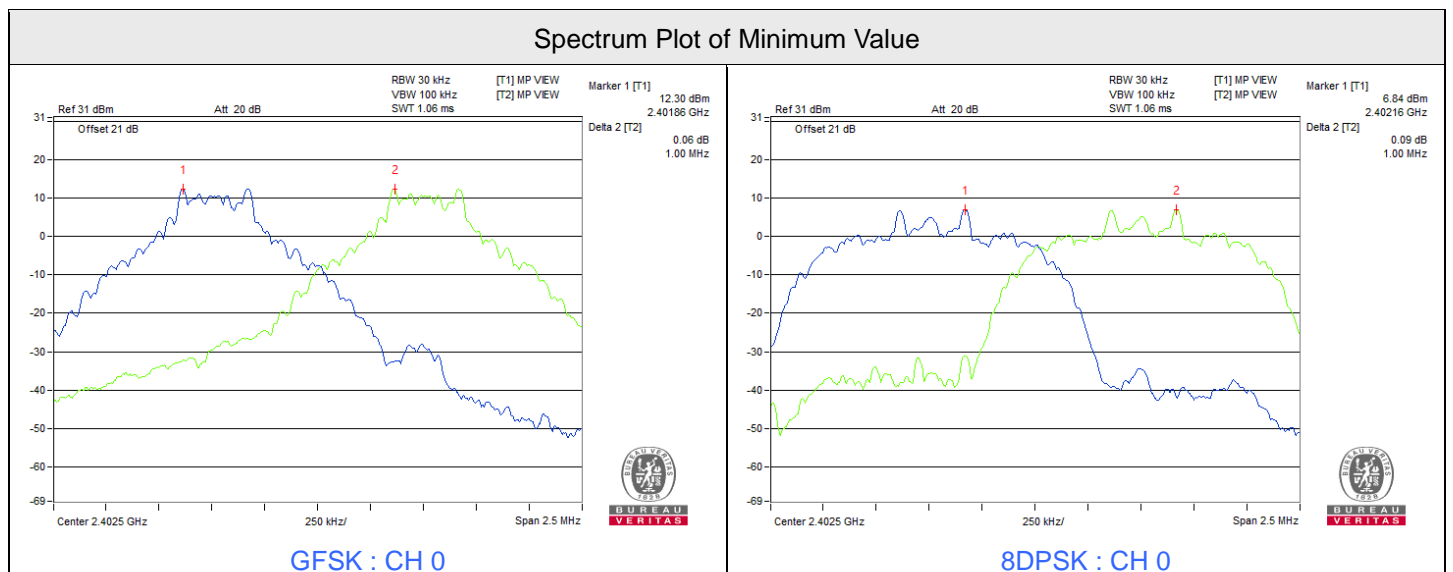

7.5 20 dB Bandwidth

Input Power:	120 Vac, 60 Hz	Environmental Conditions:	25°C, 65% RH	Tested By:	Katina Lu
--------------	----------------	---------------------------	--------------	------------	-----------

GFSK

Channel	Frequency (MHz)	20dB Bandwidth (MHz)
0	2402	1
39	2441	1
78	2480	0.99

8DPSK

Channel	Frequency (MHz)	20dB Bandwidth (MHz)
0	2402	1.31
39	2441	1.31
78	2480	1.31

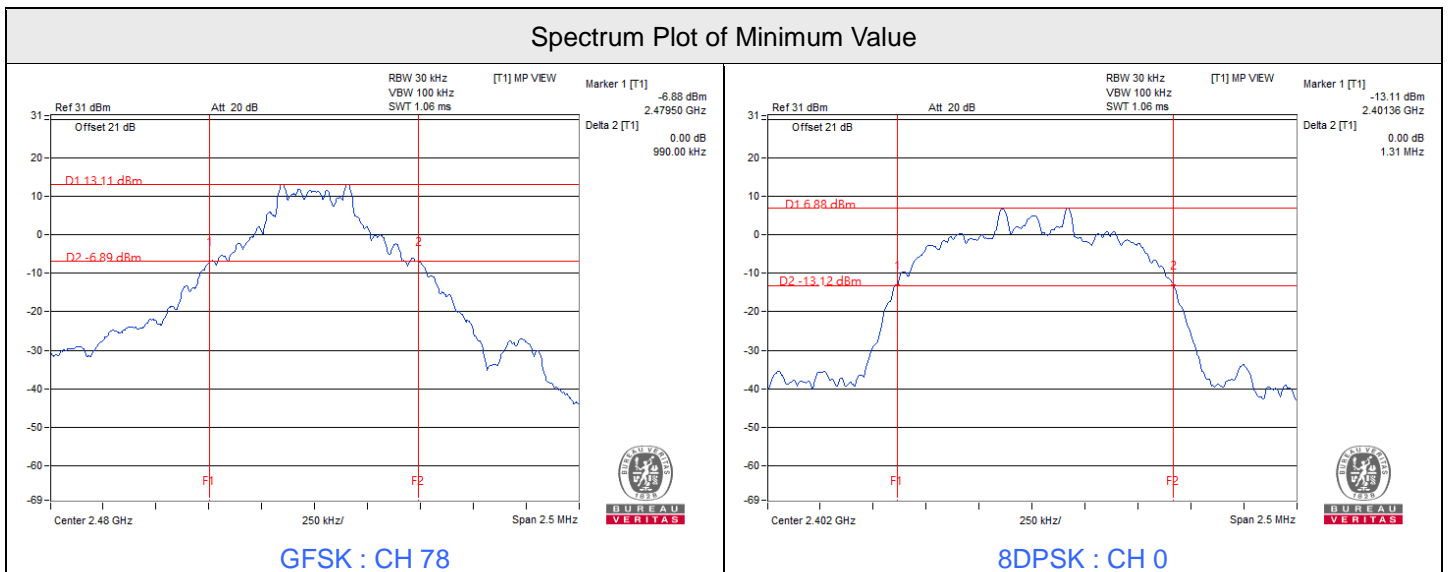

7.6 Conducted Out of Band Emissions

Input Power:	120 Vac, 60 Hz	Environmental Conditions:	25°C, 65% RH	Tested By:	Katina Lu
--------------	----------------	---------------------------	--------------	------------	-----------

GFSK

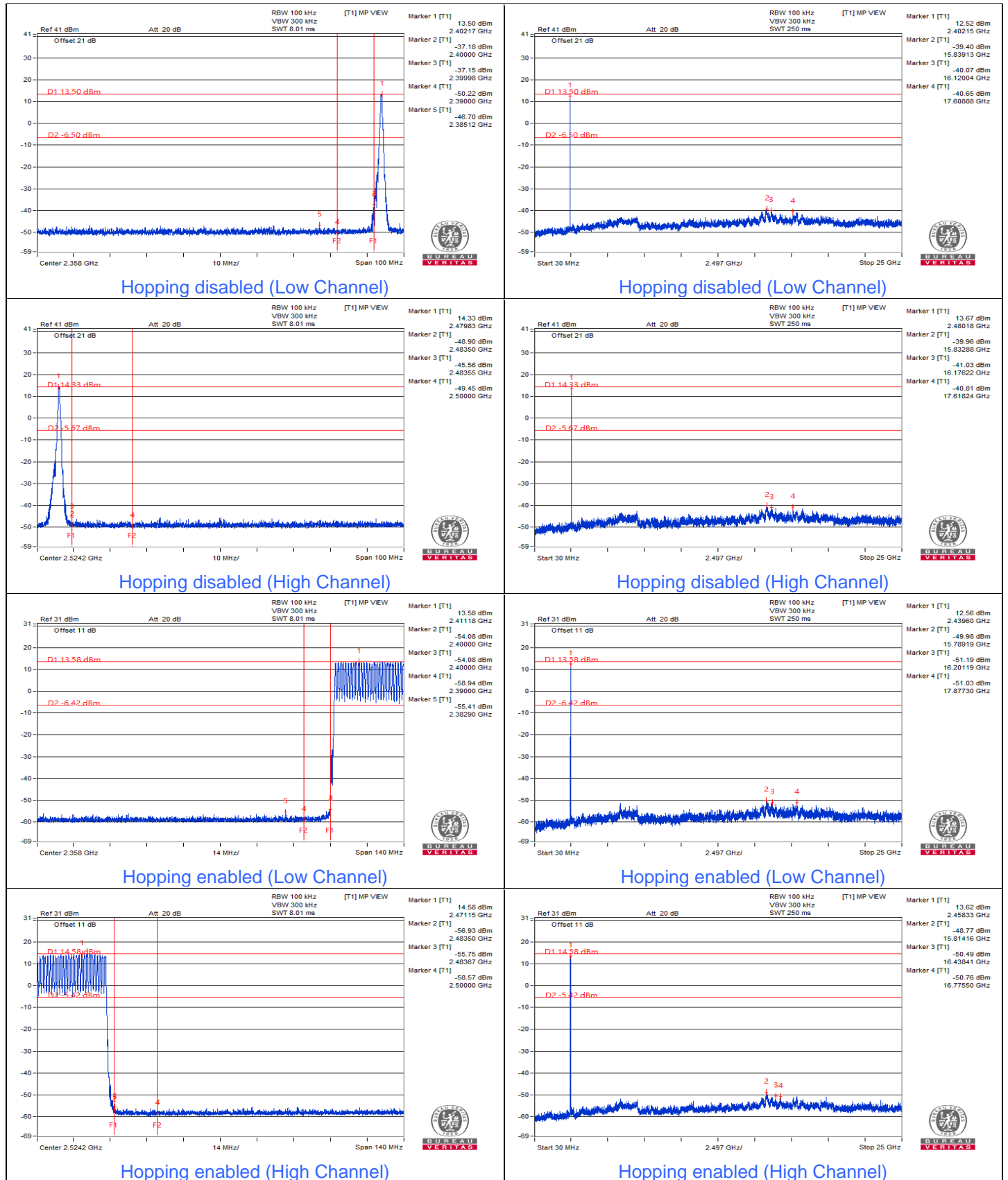



8DPSK

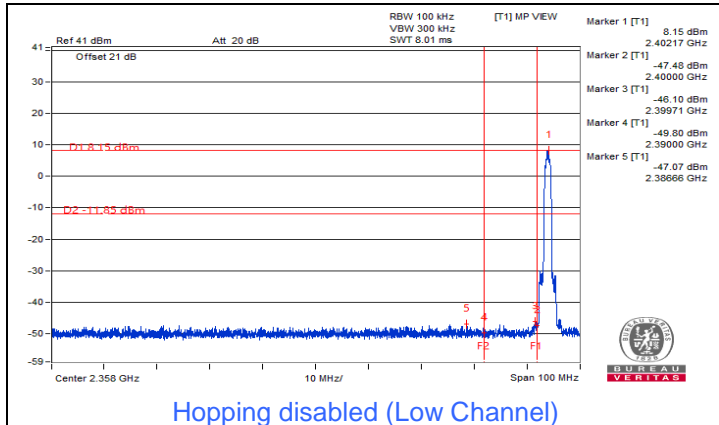

Hopping disabled (Low Channel)

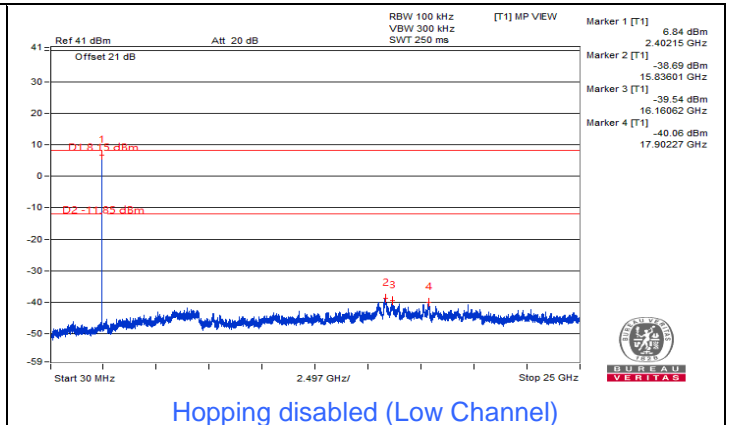

Hopping disabled (Low Channel)

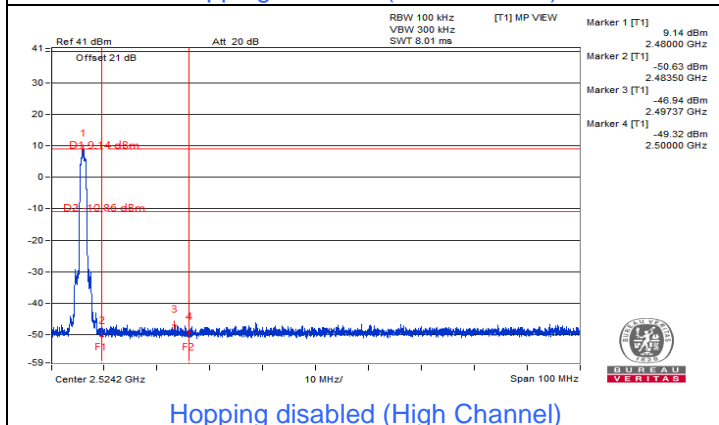

Hopping disabled (High Channel)

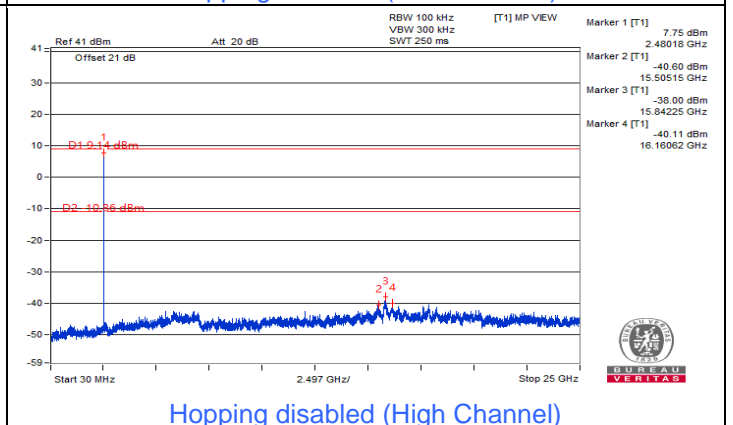

Hopping disabled (High Channel)

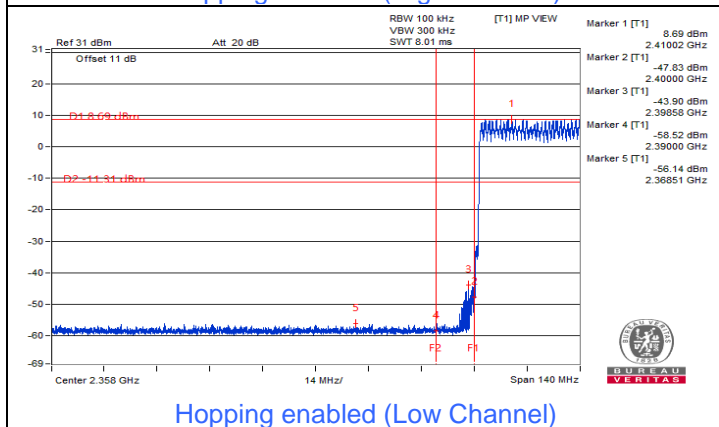

Hopping enabled (Low Channel)

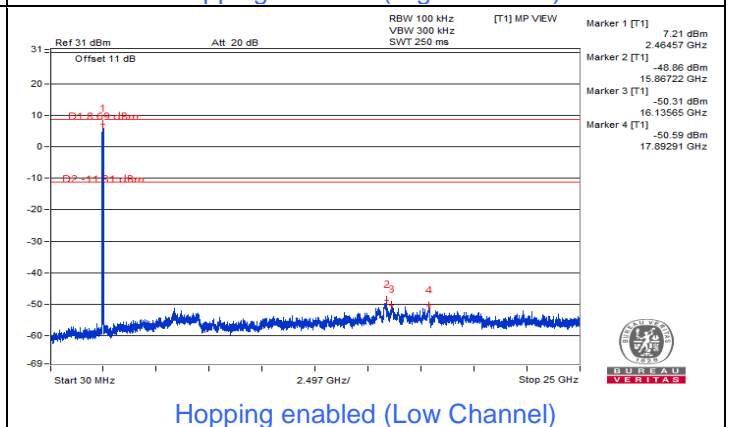

Hopping enabled (Low Channel)

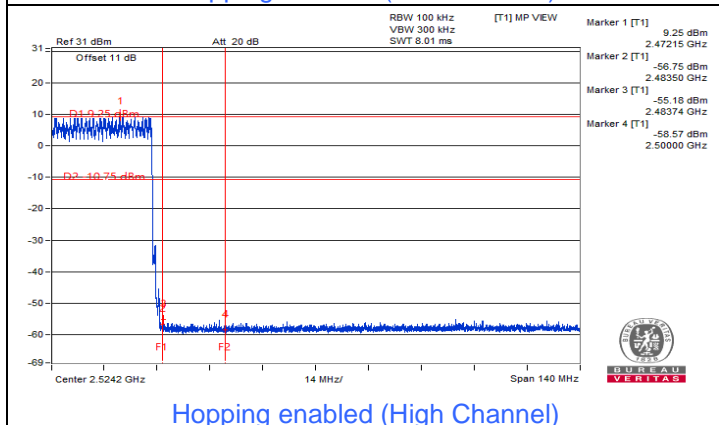

Hopping enabled (High Channel)

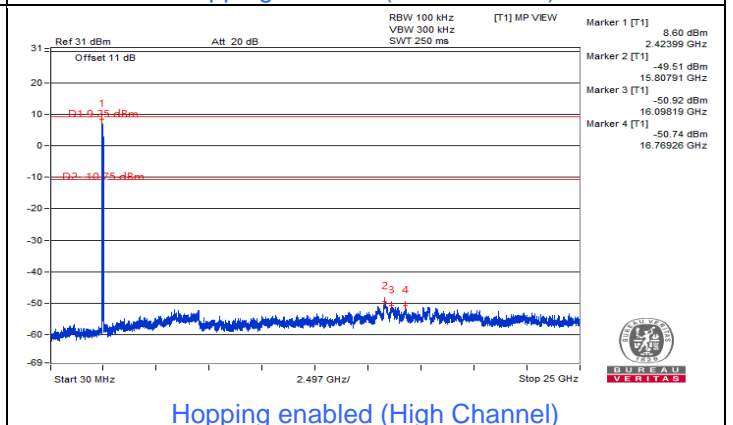

Hopping enabled (High Channel)

7.7 AC Power Conducted Emissions

RF Mode	BT GFSK	Channel	CH 78 : 2480 MHz
Frequency Range	150kHz ~ 30MHz	Detector Function & Resolution Bandwidth	Quasi-Peak (QP) / Average (AV), 9 kHz
Input Power	120 Vac, 60 Hz	Environmental Conditions	25°C, 75% RH
Tested By	Sampson Chen		

Phase Of Power : Line (L)										
No	Frequency (MHz)	Correction Factor (dB)	Reading Value (dBuV)		Emission Level (dBuV)		Limit (dBuV)		Margin (dB)	
			Q.P.	AV.	Q.P.	AV.	Q.P.	AV.	Q.P.	AV.
1	0.26328	9.98	22.65	17.62	32.63	27.60	61.33	51.33	-28.70	-23.73
2	0.40000	9.99	22.87	17.39	32.86	27.38	57.85	47.85	-24.99	-20.47
3	0.52500	10.00	22.86	14.64	32.86	24.64	56.00	46.00	-23.14	-21.36
4	0.84531	10.02	17.88	6.12	27.90	16.14	56.00	46.00	-28.10	-29.86
5	1.03906	10.03	18.47	7.05	28.50	17.08	56.00	46.00	-27.50	-28.92
6	26.75781	11.47	25.85	21.78	37.32	33.25	60.00	50.00	-22.68	-16.75

Remarks:

1. Q.P. and AV. are abbreviations of quasi-peak and average individually.
2. The emission levels of other frequencies were very low against the limit.
3. Margin value = Emission level – Limit value
4. Correction factor = Insertion loss + Cable loss
5. Emission Level = Correction Factor + Reading Value

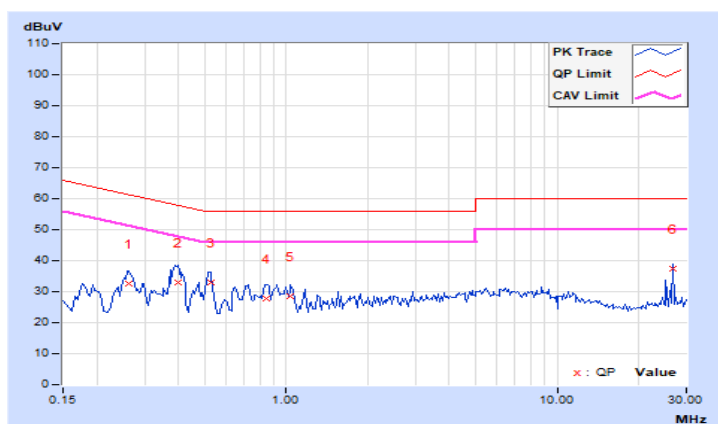

RF Mode	BT GFSK	Channel	CH 78 : 2480 MHz
Frequency Range	150kHz ~ 30MHz	Detector Function & Resolution Bandwidth	Quasi-Peak (QP) / Average (AV), 9 kHz
Input Power	120 Vac, 60 Hz	Environmental Conditions	25°C, 75% RH
Tested By	Sampson Chen		

Phase Of Power : Neutral (N)										
No	Frequency (MHz)	Correction Factor (dB)	Reading Value (dBuV)		Emission Level (dBuV)		Limit (dBuV)		Margin (dB)	
			Q.P.	AV.	Q.P.	AV.	Q.P.	AV.	Q.P.	AV.
1	0.26719	10.03	26.74	18.24	36.77	28.27	61.20	51.20	-24.43	-22.93
2	0.40781	10.04	25.46	17.37	35.50	27.41	57.69	47.69	-22.19	-20.28
3	0.52109	10.05	23.21	13.64	33.26	23.69	56.00	46.00	-22.74	-22.31
4	0.84531	10.07	16.38	4.33	26.45	14.40	56.00	46.00	-29.55	-31.60
5	2.13672	10.16	12.75	3.63	22.91	13.79	56.00	46.00	-33.09	-32.21
6	26.76563	11.16	23.20	19.36	34.36	30.52	60.00	50.00	-25.64	-19.48

Remarks:

1. Q.P. and AV. are abbreviations of quasi-peak and average individually.
2. The emission levels of other frequencies were very low against the limit.
3. Margin value = Emission level – Limit value
4. Correction factor = Insertion loss + Cable loss
5. Emission Level = Correction Factor + Reading Value

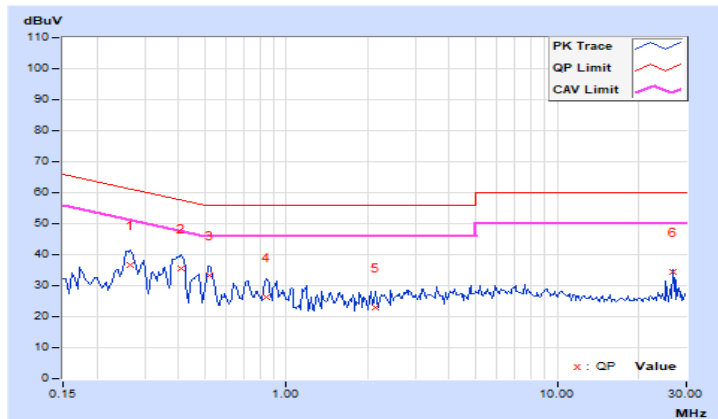

7.8 Unwanted Emissions below 1 GHz

RF Mode	BT GFSK	Channel	CH 78 : 2480 MHz
Frequency Range	30 MHz ~ 1 GHz	Detector Function & Bandwidth	(QP) RB = 120kHz
Input Power	120 Vac, 60 Hz	Environmental Conditions	21°C, 67% RH
Tested By	Nick Tsou		

Antenna Polarity & Test Distance : Horizontal at 3 m								
No	Frequency (MHz)	Emission Level (dBuV/m)	Limit (dBuV/m)	Margin (dB)	Antenna Height (m)	Table Angle (Degree)	Raw Value (dBuV)	Correction Factor (dB/m)
1	47.10	19.7 QP	40.0	-20.3	1.00 H	215	32.1	-12.4
2	114.15	24.1 QP	43.5	-19.4	1.00 H	154	39.4	-15.3
3	217.31	25.0 QP	46.0	-21.0	1.50 H	165	41.1	-16.1
4	582.00	24.3 QP	46.0	-21.7	1.50 H	165	29.8	-5.5
5	810.44	28.1 QP	46.0	-17.9	2.00 H	145	29.8	-1.7
6	1000.00	32.3 QP	54.0	-21.7	3.00 H	78	32.1	0.2

Remarks:

1. Emission Level(dBuV/m) = Raw Value(dBuV) + Correction Factor(dB/m)
2. Correction Factor(dB/m) = Antenna Factor(dB/m) + Cable Factor(dB) – Pre-Amplifier Factor(dB)
3. Margin value = Emission Level – Limit value
4. The other emission levels were very low against the limit of frequency range 30 MHz ~ 1 GHz.
5. The emission levels were very low against the limit of frequency range 9 kHz ~ 30 MHz: the amplitude of spurious emissions attenuated more than 20 dB below the permissible value to be report.

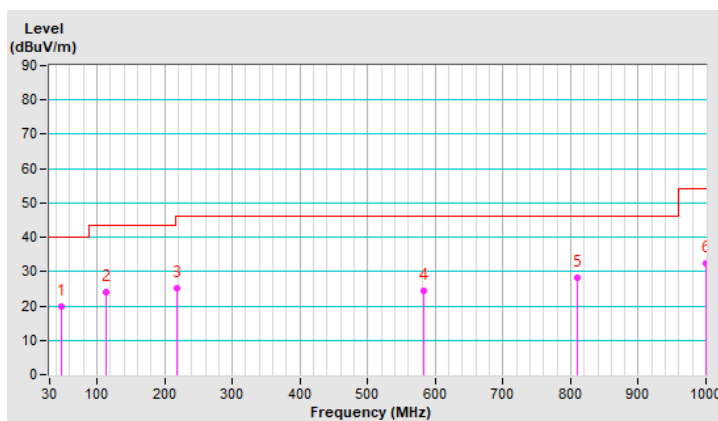

RF Mode	BT GFSK	Channel	CH 78 : 2480 MHz
Frequency Range	30 MHz ~ 1 GHz	Detector Function & Bandwidth	(QP) RB = 120kHz
Input Power	120 Vac, 60 Hz	Environmental Conditions	21°C, 67% RH
Tested By	Nick Tsou		

Antenna Polarity & Test Distance : Vertical at 3 m								
No	Frequency (MHz)	Emission Level (dBuV/m)	Limit (dBuV/m)	Margin (dB)	Antenna Height (m)	Table Angle (Degree)	Raw Value (dBuV)	Correction Factor (dB/m)
1	44.48	30.1 QP	40.0	-9.9	1.00 V	344	42.7	-12.6
2	149.29	28.6 QP	43.5	-14.9	2.00 V	360	41.1	-12.5
3	180.64	24.6 QP	43.5	-18.9	1.50 V	336	38.8	-14.2
4	456.34	25.1 QP	46.0	-20.9	3.00 V	360	33.1	-8.0
5	819.97	28.4 QP	46.0	-17.6	1.00 V	353	29.9	-1.5
6	1000.00	31.7 QP	54.0	-22.3	1.50 V	360	31.5	0.2

Remarks:

1. Emission Level(dBuV/m) = Raw Value(dBuV) + Correction Factor(dB/m)
2. Correction Factor(dB/m) = Antenna Factor(dB/m) + Cable Factor(dB) – Pre-Amplifier Factor(dB)
3. Margin value = Emission Level – Limit value
4. The other emission levels were very low against the limit of frequency range 30 MHz ~ 1 GHz.
5. The emission levels were very low against the limit of frequency range 9 kHz ~ 30 MHz: the amplitude of spurious emissions attenuated more than 20 dB below the permissible value to be report.

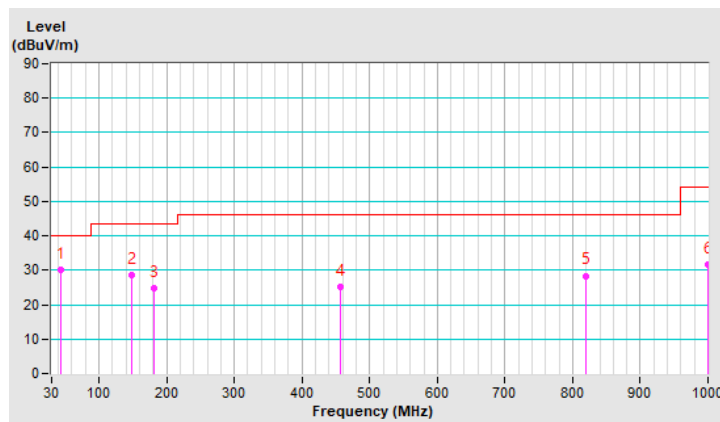

7.9 Unwanted Emissions above 1 GHz

RF Mode	BT GFSK	Channel	CH 0 : 2402 MHz
Frequency Range	1 GHz ~ 25 GHz	Detector Function & Bandwidth	(PK) RB = 1 MHz, VB = 3 MHz (AV) RB = 1 MHz, VB = 3 MHz
Input Power	120 Vac, 60 Hz	Environmental Conditions	25°C, 67% RH
Tested By	Nick Tsou		

Antenna Polarity & Test Distance : Horizontal at 3 m								
No	Frequency (MHz)	Emission Level (dBuV/m)	Limit (dBuV/m)	Margin (dB)	Antenna Height (m)	Table Angle (Degree)	Raw Value (dBuV)	Correction Factor (dB/m)
1	2390.00	54.7 PK	74.0	-19.3	1.15 H	122	57.1	-2.4
2	2390.00	45.1 AV	54.0	-8.9	1.15 H	122	47.5	-2.4
3	*2402.00	112.8 PK			1.15 H	122	115.2	-2.4
4	*2402.00	82.0 AV			1.15 H	122	84.4	-2.4
5	4804.00	41.1 PK	74.0	-32.9	1.41 H	157	38.3	2.8
6	4804.00	10.3 AV	54.0	-43.7	1.41 H	157	7.5	2.8

Remarks:

1. Emission Level(dBuV/m) = Raw Value(dBuV) + Correction Factor(dB/m)
2. Correction Factor(dB/m) = Antenna Factor(dB/m) + Cable Factor(dB) – Pre-Amplifier Factor(dB)
3. Margin value = Emission Level – Limit value
4. The other emission levels were very low against the limit.
5. " * " : Fundamental frequency, the limit was restricted at the RF Output Power.
6. The average value of fundamental and harmonic frequency is: Average = Peak value + 20 log(Duty cycle) Where the duty cycle correction factor is calculated from following formula:
 $20 \log(\text{Duty cycle}) = 20 \log(2.89 \text{ ms} / 100 \text{ ms}) = -30.8 \text{ dB}$

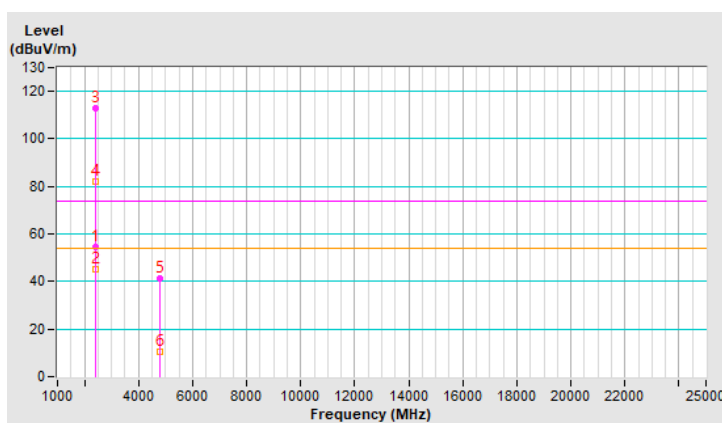

RF Mode	BT GFSK	Channel	CH 0 : 2402 MHz
Frequency Range	1 GHz ~ 25 GHz	Detector Function & Bandwidth	(PK) RB = 1 MHz, VB = 3 MHz (AV) RB = 1 MHz, VB = 3 MHz
Input Power	120 Vac, 60 Hz	Environmental Conditions	25°C, 67% RH
Tested By	Nick Tsou		

Antenna Polarity & Test Distance : Vertical at 3 m								
No	Frequency (MHz)	Emission Level (dBuV/m)	Limit (dBuV/m)	Margin (dB)	Antenna Height (m)	Table Angle (Degree)	Raw Value (dBuV)	Correction Factor (dB/m)
1	2390.00	52.6 PK	74.0	-21.4	2.34 V	187	55.0	-2.4
2	2390.00	42.3 AV	54.0	-11.7	2.34 V	187	44.7	-2.4
3	*2402.00	108.4 PK			2.34 V	187	110.8	-2.4
4	*2402.00	77.6 AV			2.34 V	187	80.0	-2.4
5	4804.00	41.0 PK	74.0	-33.0	1.17 V	356	38.2	2.8
6	4804.00	10.2 AV	54.0	-43.8	1.17 V	356	7.4	2.8

Remarks:

1. Emission Level(dBuV/m) = Raw Value(dBuV) + Correction Factor(dB/m)
2. Correction Factor(dB/m) = Antenna Factor(dB/m) + Cable Factor(dB) – Pre-Amplifier Factor(dB)
3. Margin value = Emission Level – Limit value
4. The other emission levels were very low against the limit.
5. " * " : Fundamental frequency, the limit was restricted at the RF Output Power.
6. The average value of fundamental and harmonic frequency is: Average = Peak value + 20 log(Duty cycle) Where the duty cycle correction factor is calculated from following formula:
 $20 \log(\text{Duty cycle}) = 20 \log(2.89 \text{ ms} / 100 \text{ ms}) = -30.8 \text{ dB}$

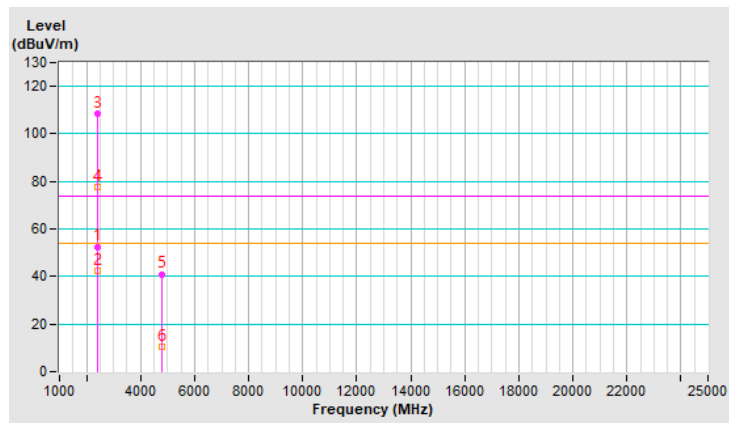

RF Mode	BT GFSK	Channel	CH 39 : 2441 MHz
Frequency Range	1 GHz ~ 25 GHz	Detector Function & Bandwidth	(PK) RB = 1 MHz, VB = 3 MHz (AV) RB = 1 MHz, VB = 3 MHz
Input Power	120 Vac, 60 Hz	Environmental Conditions	25°C, 67% RH
Tested By	Nick Tsou		

Antenna Polarity & Test Distance : Horizontal at 3 m

No	Frequency (MHz)	Emission Level (dBuV/m)	Limit (dBuV/m)	Margin (dB)	Antenna Height (m)	Table Angle (Degree)	Raw Value (dBuV)	Correction Factor (dB/m)
1	*2441.00	113.1 PK			1.20 H	119	115.4	-2.3
2	*2441.00	82.3 AV			1.20 H	119	84.6	-2.3
3	4882.00	41.3 PK	74.0	-32.7	1.42 H	145	38.6	2.7
4	4882.00	10.5 AV	54.0	-43.5	1.42 H	145	7.8	2.7
5	7323.00	45.7 PK	74.0	-28.3	2.50 H	245	37.3	8.4
6	7323.00	14.9 AV	54.0	-39.1	2.50 H	245	6.5	8.4

Remarks:

1. Emission Level(dBuV/m) = Raw Value(dBuV) + Correction Factor(dB/m)
2. Correction Factor(dB/m) = Antenna Factor(dB/m) + Cable Factor(dB) – Pre-Amplifier Factor(dB)
3. Margin value = Emission Level – Limit value
4. The other emission levels were very low against the limit.
5. " * " : Fundamental frequency, the limit was restricted at the RF Output Power.
6. The average value of fundamental and harmonic frequency is: Average = Peak value + 20 log(Duty cycle) Where the duty cycle correction factor is calculated from following formula:
 $20 \log(\text{Duty cycle}) = 20 \log(2.89 \text{ ms} / 100 \text{ ms}) = -30.8 \text{ dB}$

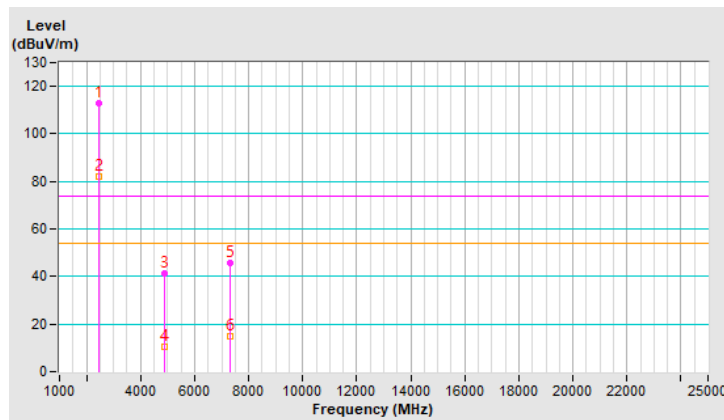

RF Mode	BT GFSK	Channel	CH 39 : 2441 MHz
Frequency Range	1 GHz ~ 25 GHz	Detector Function & Bandwidth	(PK) RB = 1 MHz, VB = 3 MHz (AV) RB = 1 MHz, VB = 3 MHz
Input Power	120 Vac, 60 Hz	Environmental Conditions	25°C, 67% RH
Tested By	Nick Tsou		

Antenna Polarity & Test Distance : Vertical at 3 m

No	Frequency (MHz)	Emission Level (dBuV/m)	Limit (dBuV/m)	Margin (dB)	Antenna Height (m)	Table Angle (Degree)	Raw Value (dBuV)	Correction Factor (dB/m)
1	*2441.00	108.6 PK			2.11 V	177	110.9	-2.3
2	*2441.00	77.8 AV			2.11 V	177	80.1	-2.3
3	4882.00	41.1 PK	74.0	-32.9	1.20 V	356	38.4	2.7
4	4882.00	10.3 AV	54.0	-43.7	1.20 V	356	7.6	2.7
5	7323.00	46.5 PK	74.0	-27.5	1.50 V	211	38.1	8.4
6	7323.00	15.8 AV	54.0	-38.2	1.50 V	211	7.4	8.4

Remarks:

1. Emission Level(dBuV/m) = Raw Value(dBuV) + Correction Factor(dB/m)
2. Correction Factor(dB/m) = Antenna Factor(dB/m) + Cable Factor(dB) – Pre-Amplifier Factor(dB)
3. Margin value = Emission Level – Limit value
4. The other emission levels were very low against the limit.
5. " * " : Fundamental frequency, the limit was restricted at the RF Output Power.
6. The average value of fundamental and harmonic frequency is: Average = Peak value + 20 log(Duty cycle) Where the duty cycle correction factor is calculated from following formula:
 $20 \log(\text{Duty cycle}) = 20 \log(2.89 \text{ ms} / 100 \text{ ms}) = -30.8 \text{ dB}$

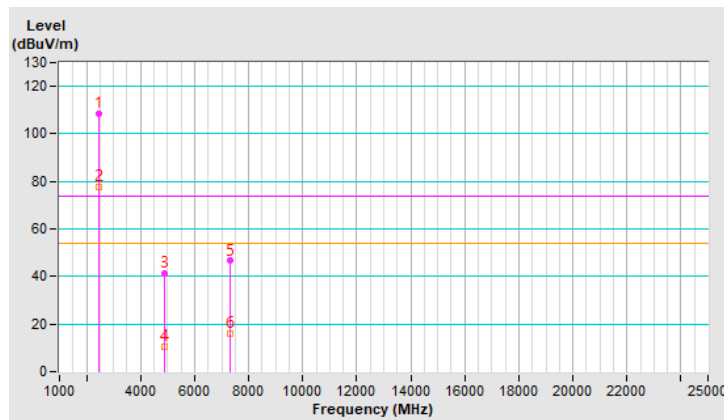

RF Mode	BT GFSK	Channel	CH 78 : 2480 MHz
Frequency Range	1 GHz ~ 25 GHz	Detector Function & Bandwidth	(PK) RB = 1 MHz, VB = 3 MHz (AV) RB = 1 MHz, VB = 3 MHz
Input Power	120 Vac, 60 Hz	Environmental Conditions	25°C, 67% RH
Tested By	Nick Tsou		

Antenna Polarity & Test Distance : Horizontal at 3 m								
No	Frequency (MHz)	Emission Level (dBuV/m)	Limit (dBuV/m)	Margin (dB)	Antenna Height (m)	Table Angle (Degree)	Raw Value (dBuV)	Correction Factor (dB/m)
1	*2480.00	114.2 PK			1.43 H	120	116.5	-2.3
2	*2480.00	83.4 AV			1.43 H	120	85.7	-2.3
3	2483.50	57.5 PK	74.0	-16.5	1.43 H	120	59.8	-2.3
4	2483.50	45.4 AV	54.0	-8.6	1.43 H	120	47.7	-2.3
5	4960.00	41.7 PK	74.0	-32.3	1.42 H	142	38.8	2.9
6	4960.00	10.9 AV	54.0	-43.1	1.42 H	142	8.0	2.9
7	7440.00	46.3 PK	74.0	-27.7	2.45 H	218	37.7	8.6
8	7440.00	15.5 AV	54.0	-38.5	2.45 H	218	6.9	8.6

Remarks:

1. Emission Level(dBuV/m) = Raw Value(dBuV) + Correction Factor(dB/m)
2. Correction Factor(dB/m) = Antenna Factor(dB/m) + Cable Factor(dB) – Pre-Amplifier Factor(dB)
3. Margin value = Emission Level – Limit value
4. The other emission levels were very low against the limit.
5. " * ": Fundamental frequency, the limit was restricted at the RF Output Power.
6. The average value of fundamental and harmonic frequency is: Average = Peak value + 20 log(Duty cycle) Where the duty cycle correction factor is calculated from following formula:
 $20 \log(\text{Duty cycle}) = 20 \log(2.89 \text{ ms} / 100 \text{ ms}) = -30.8 \text{ dB}$

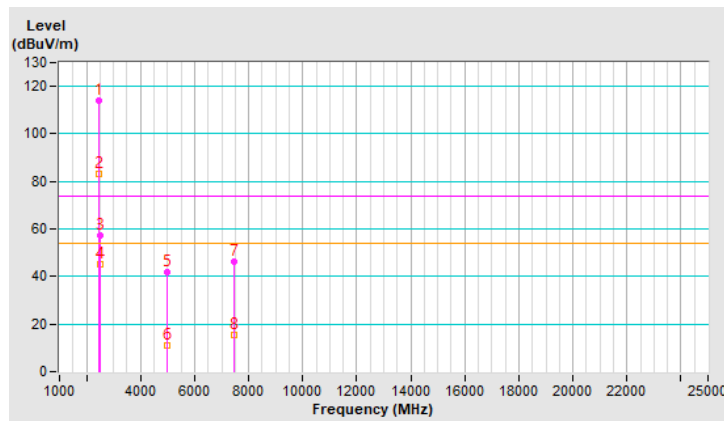

RF Mode	BT GFSK	Channel	CH 78 : 2480 MHz
Frequency Range	1 GHz ~ 25 GHz	Detector Function & Bandwidth	(PK) RB = 1 MHz, VB = 3 MHz (AV) RB = 1 MHz, VB = 3 MHz
Input Power	120 Vac, 60 Hz	Environmental Conditions	25°C, 67% RH
Tested By	Nick Tsou		

Antenna Polarity & Test Distance : Vertical at 3 m								
No	Frequency (MHz)	Emission Level (dBuV/m)	Limit (dBuV/m)	Margin (dB)	Antenna Height (m)	Table Angle (Degree)	Raw Value (dBuV)	Correction Factor (dB/m)
1	*2480.00	108.2 PK			2.14 V	166	110.5	-2.3
2	*2480.00	77.3 AV			2.14 V	166	79.6	-2.3
3	2483.50	51.6 PK	74.0	-22.4	2.14 V	166	53.9	-2.3
4	2483.50	44.1 AV	54.0	-9.9	2.14 V	166	46.4	-2.3
5	4960.00	41.5 PK	74.0	-32.5	1.23 V	360	38.6	2.9
6	4960.00	10.7 AV	54.0	-43.3	1.23 V	360	7.8	2.9
7	7440.00	46.9 PK	74.0	-27.1	1.53 V	258	38.3	8.6
8	7440.00	16.1 AV	54.0	-37.9	1.53 V	258	7.5	8.6

Remarks:

1. Emission Level(dBuV/m) = Raw Value(dBuV) + Correction Factor(dB/m)
2. Correction Factor(dB/m) = Antenna Factor(dB/m) + Cable Factor(dB) – Pre-Amplifier Factor(dB)
3. Margin value = Emission Level – Limit value
4. The other emission levels were very low against the limit.
5. " * ": Fundamental frequency, the limit was restricted at the RF Output Power.
6. The average value of fundamental and harmonic frequency is: Average = Peak value + 20 log(Duty cycle) Where the duty cycle correction factor is calculated from following formula:
 $20 \log(\text{Duty cycle}) = 20 \log(2.89 \text{ ms} / 100 \text{ ms}) = -30.8 \text{ dB}$

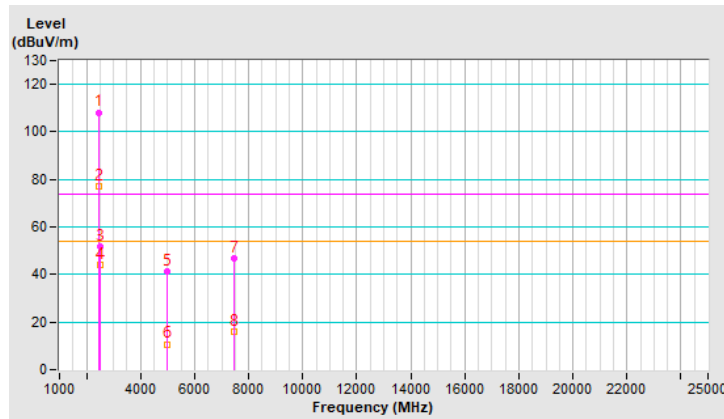

RF Mode	BT 8DPSK	Channel	CH 0 : 2402 MHz
Frequency Range	1 GHz ~ 25 GHz	Detector Function & Bandwidth	(PK) RB = 1 MHz, VB = 3 MHz (AV) RB = 1 MHz, VB = 3 MHz
Input Power	120 Vac, 60 Hz	Environmental Conditions	25°C, 67% RH
Tested By	Nick Tsou		

Antenna Polarity & Test Distance : Horizontal at 3 m

No	Frequency (MHz)	Emission Level (dBuV/m)	Limit (dBuV/m)	Margin (dB)	Antenna Height (m)	Table Angle (Degree)	Raw Value (dBuV)	Correction Factor (dB/m)
1	2390.00	54.9 PK	74.0	-19.1	1.97 H	121	57.3	-2.4
2	2390.00	44.3 AV	54.0	-9.7	1.97 H	121	46.7	-2.4
3	*2402.00	108.7 PK			1.97 H	121	111.1	-2.4
4	*2402.00	77.9 AV			1.97 H	121	80.3	-2.4
5	4804.00	40.8 PK	74.0	-33.2	1.46 H	144	38.0	2.8
6	4804.00	10.0 AV	54.0	-44.0	1.46 H	144	7.2	2.8

Remarks:

1. Emission Level(dBuV/m) = Raw Value(dBuV) + Correction Factor(dB/m)
2. Correction Factor(dB/m) = Antenna Factor(dB/m) + Cable Factor(dB) – Pre-Amplifier Factor(dB)
3. Margin value = Emission Level – Limit value
4. The other emission levels were very low against the limit.
5. " * " : Fundamental frequency, the limit was restricted at the RF Output Power.
6. The average value of fundamental and harmonic frequency is: Average = Peak value + 20 log(Duty cycle) Where the duty cycle correction factor is calculated from following formula:
 $20 \log(\text{Duty cycle}) = 20 \log(2.9 \text{ ms} / 100 \text{ ms}) = -30.8 \text{ dB}$

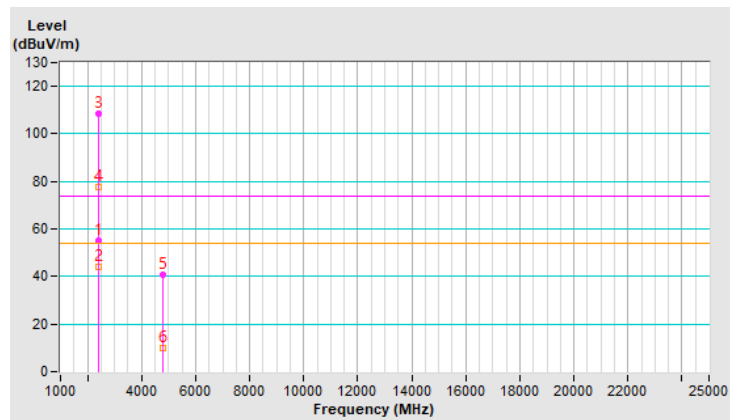

RF Mode	BT 8DPSK	Channel	CH 0 : 2402 MHz
Frequency Range	1 GHz ~ 25 GHz	Detector Function & Bandwidth	(PK) RB = 1 MHz, VB = 3 MHz (AV) RB = 1 MHz, VB = 3 MHz
Input Power	120 Vac, 60 Hz	Environmental Conditions	25°C, 67% RH
Tested By	Nick Tsou		

Antenna Polarity & Test Distance : Vertical at 3 m								
No	Frequency (MHz)	Emission Level (dBuV/m)	Limit (dBuV/m)	Margin (dB)	Antenna Height (m)	Table Angle (Degree)	Raw Value (dBuV)	Correction Factor (dB/m)
1	2390.00	52.5 PK	74.0	-21.5	2.34 V	183	54.9	-2.4
2	2390.00	42.4 AV	54.0	-11.6	2.34 V	183	44.8	-2.4
3	*2402.00	105.7 PK			2.34 V	183	108.1	-2.4
4	*2402.00	74.9 AV			2.34 V	183	77.3	-2.4
5	4804.00	41.1 PK	74.0	-32.9	1.21 V	354	38.3	2.8
6	4804.00	10.3 AV	54.0	-43.7	1.21 V	354	7.5	2.8

Remarks:

1. Emission Level(dBuV/m) = Raw Value(dBuV) + Correction Factor(dB/m)
2. Correction Factor(dB/m) = Antenna Factor(dB/m) + Cable Factor(dB) – Pre-Amplifier Factor(dB)
3. Margin value = Emission Level – Limit value
4. The other emission levels were very low against the limit.
5. " * " : Fundamental frequency, the limit was restricted at the RF Output Power.
6. The average value of fundamental and harmonic frequency is: Average = Peak value + 20 log(Duty cycle) Where the duty cycle correction factor is calculated from following formula:
 $20 \log(\text{Duty cycle}) = 20 \log(2.9 \text{ ms} / 100 \text{ ms}) = -30.8 \text{ dB}$

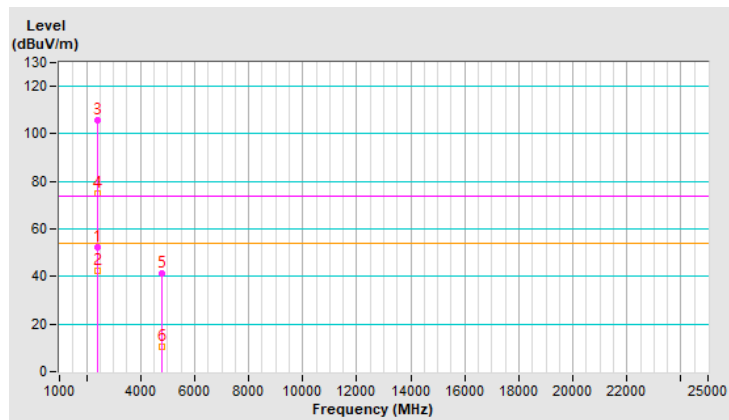

RF Mode	BT 8DPSK	Channel	CH 39 : 2441 MHz
Frequency Range	1 GHz ~ 25 GHz	Detector Function & Bandwidth	(PK) RB = 1 MHz, VB = 3 MHz (AV) RB = 1 MHz, VB = 3 MHz
Input Power	120 Vac, 60 Hz	Environmental Conditions	25°C, 67% RH
Tested By	Nick Tsou		

Antenna Polarity & Test Distance : Horizontal at 3 m								
No	Frequency (MHz)	Emission Level (dBuV/m)	Limit (dBuV/m)	Margin (dB)	Antenna Height (m)	Table Angle (Degree)	Raw Value (dBuV)	Correction Factor (dB/m)
1	*2441.00	110.4 PK			1.21 H	118	112.7	-2.3
2	*2441.00	79.6 AV			1.21 H	118	81.9	-2.3
3	4882.00	41.8 PK	74.0	-32.2	1.43 H	137	39.1	2.7
4	4882.00	11.0 AV	54.0	-43.0	1.43 H	137	8.3	2.7
5	7323.00	45.5 PK	74.0	-28.5	2.52 H	185	37.1	8.4
6	7323.00	14.7 AV	54.0	-39.3	2.52 H	185	6.3	8.4

Remarks:

1. Emission Level(dBuV/m) = Raw Value(dBuV) + Correction Factor(dB/m)
2. Correction Factor(dB/m) = Antenna Factor(dB/m) + Cable Factor(dB) – Pre-Amplifier Factor(dB)
3. Margin value = Emission Level – Limit value
4. The other emission levels were very low against the limit.
5. " * " : Fundamental frequency, the limit was restricted at the RF Output Power.
6. The average value of fundamental and harmonic frequency is: Average = Peak value + 20 log(Duty cycle) Where the duty cycle correction factor is calculated from following formula:
 $20 \log(\text{Duty cycle}) = 20 \log(2.9 \text{ ms} / 100 \text{ ms}) = -30.8 \text{ dB}$

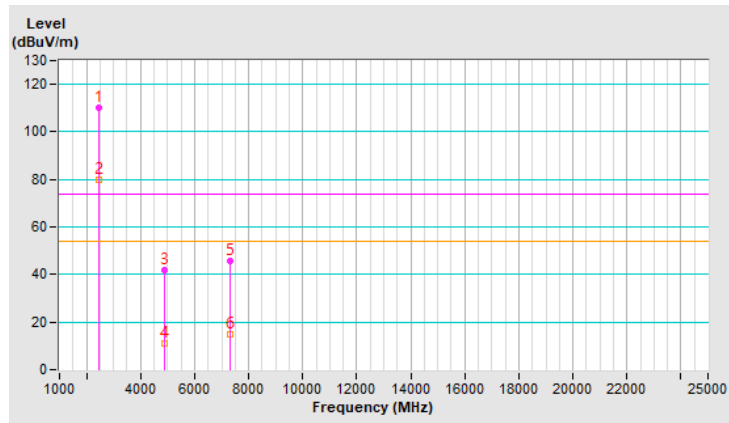

RF Mode	BT 8DPSK	Channel	CH 39 : 2441 MHz
Frequency Range	1 GHz ~ 25 GHz	Detector Function & Bandwidth	(PK) RB = 1 MHz, VB = 3 MHz (AV) RB = 1 MHz, VB = 3 MHz
Input Power	120 Vac, 60 Hz	Environmental Conditions	25°C, 67% RH
Tested By	Nick Tsou		

Antenna Polarity & Test Distance : Vertical at 3 m								
No	Frequency (MHz)	Emission Level (dBuV/m)	Limit (dBuV/m)	Margin (dB)	Antenna Height (m)	Table Angle (Degree)	Raw Value (dBuV)	Correction Factor (dB/m)
1	*2441.00	105.3 PK			2.11 V	187	107.6	-2.3
2	*2441.00	74.5 AV			2.11 V	187	76.8	-2.3
3	4882.00	40.6 PK	74.0	-33.4	1.25 V	354	37.9	2.7
4	4882.00	9.8 AV	54.0	-44.2	1.25 V	354	7.1	2.7
5	7323.00	46.8 PK	74.0	-27.2	1.45 V	245	38.4	8.4
6	7323.00	16.0 AV	54.0	-38.0	1.45 V	245	7.6	8.4

Remarks:

1. Emission Level(dBuV/m) = Raw Value(dBuV) + Correction Factor(dB/m)
2. Correction Factor(dB/m) = Antenna Factor(dB/m) + Cable Factor(dB) – Pre-Amplifier Factor(dB)
3. Margin value = Emission Level – Limit value
4. The other emission levels were very low against the limit.
5. " * " : Fundamental frequency, the limit was restricted at the RF Output Power.
6. The average value of fundamental and harmonic frequency is: Average = Peak value + 20 log(Duty cycle) Where the duty cycle correction factor is calculated from following formula:
 $20 \log(\text{Duty cycle}) = 20 \log(2.9 \text{ ms} / 100 \text{ ms}) = -30.8 \text{ dB}$

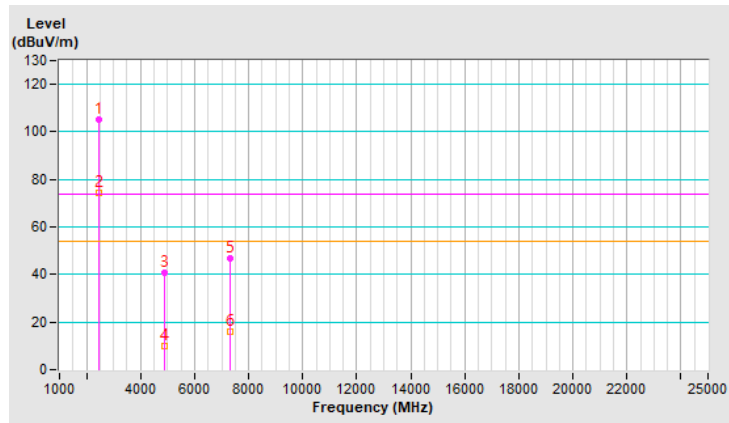

RF Mode	BT 8DPSK	Channel	CH 78 : 2480 MHz
Frequency Range	1 GHz ~ 25 GHz	Detector Function & Bandwidth	(PK) RB = 1 MHz, VB = 3 MHz (AV) RB = 1 MHz, VB = 3 MHz
Input Power	120 Vac, 60 Hz	Environmental Conditions	25°C, 67% RH
Tested By	Nick Tsou		

Antenna Polarity & Test Distance : Horizontal at 3 m								
No	Frequency (MHz)	Emission Level (dBuV/m)	Limit (dBuV/m)	Margin (dB)	Antenna Height (m)	Table Angle (Degree)	Raw Value (dBuV)	Correction Factor (dB/m)
1	*2480.00	111.3 PK			1.42 H	119	113.6	-2.3
2	*2480.00	80.5 AV			1.42 H	119	82.8	-2.3
3	2483.50	55.1 PK	74.0	-18.9	1.42 H	119	57.4	-2.3
4	2483.50	44.8 AV	54.0	-9.2	1.42 H	119	47.1	-2.3
5	4960.00	41.5 PK	74.0	-32.5	1.44 H	149	38.6	2.9
6	4960.00	10.7 AV	54.0	-43.3	1.44 H	149	7.8	2.9
7	7440.00	45.8 PK	74.0	-28.2	2.47 H	214	37.2	8.6
8	7440.00	15.0 AV	54.0	-39.0	2.47 H	214	6.4	8.6

Remarks:

1. Emission Level(dBuV/m) = Raw Value(dBuV) + Correction Factor(dB/m)
2. Correction Factor(dB/m) = Antenna Factor(dB/m) + Cable Factor(dB) – Pre-Amplifier Factor(dB)
3. Margin value = Emission Level – Limit value
4. The other emission levels were very low against the limit.
5. " * ": Fundamental frequency, the limit was restricted at the RF Output Power.
6. The average value of fundamental and harmonic frequency is: Average = Peak value + 20 log(Duty cycle) Where the duty cycle correction factor is calculated from following formula:
 $20 \log(\text{Duty cycle}) = 20 \log(2.9 \text{ ms} / 100 \text{ ms}) = -30.8 \text{ dB}$

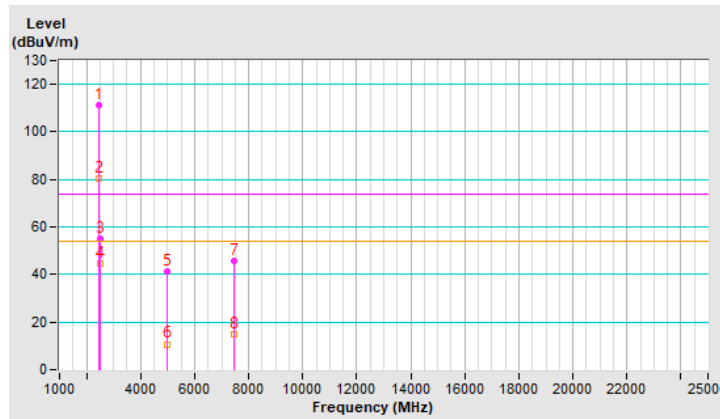

RF Mode	BT 8DPSK	Channel	CH 78 : 2480 MHz
Frequency Range	1 GHz ~ 25 GHz	Detector Function & Bandwidth	(PK) RB = 1 MHz, VB = 3 MHz (AV) RB = 1 MHz, VB = 3 MHz
Input Power	120 Vac, 60 Hz	Environmental Conditions	25°C, 67% RH
Tested By	Nick Tsou		

Antenna Polarity & Test Distance : Vertical at 3 m								
No	Frequency (MHz)	Emission Level (dBuV/m)	Limit (dBuV/m)	Margin (dB)	Antenna Height (m)	Table Angle (Degree)	Raw Value (dBuV)	Correction Factor (dB/m)
1	*2480.00	105.3 PK			2.22 V	182	107.6	-2.3
2	*2480.00	74.5 AV			2.22 V	182	76.8	-2.3
3	2483.50	50.8 PK	74.0	-23.2	2.22 V	182	53.1	-2.3
4	2483.50	43.0 AV	54.0	-11.0	2.22 V	182	45.3	-2.3
5	4960.00	41.4 PK	74.0	-32.6	1.21 V	341	38.5	2.9
6	4960.00	10.6 AV	54.0	-43.4	1.21 V	341	7.7	2.9
7	7440.00	46.1 PK	74.0	-27.9	1.56 V	211	37.5	8.6
8	7440.00	15.3 AV	54.0	-38.7	1.56 V	211	6.7	8.6

Remarks:

1. Emission Level(dBuV/m) = Raw Value(dBuV) + Correction Factor(dB/m)
2. Correction Factor(dB/m) = Antenna Factor(dB/m) + Cable Factor(dB) – Pre-Amplifier Factor(dB)
3. Margin value = Emission Level – Limit value
4. The other emission levels were very low against the limit.
5. " * ": Fundamental frequency, the limit was restricted at the RF Output Power.
6. The average value of fundamental and harmonic frequency is: Average = Peak value + 20 log(Duty cycle) Where the duty cycle correction factor is calculated from following formula:
 $20 \log(\text{Duty cycle}) = 20 \log(2.9 \text{ ms} / 100 \text{ ms}) = -30.8 \text{ dB}$

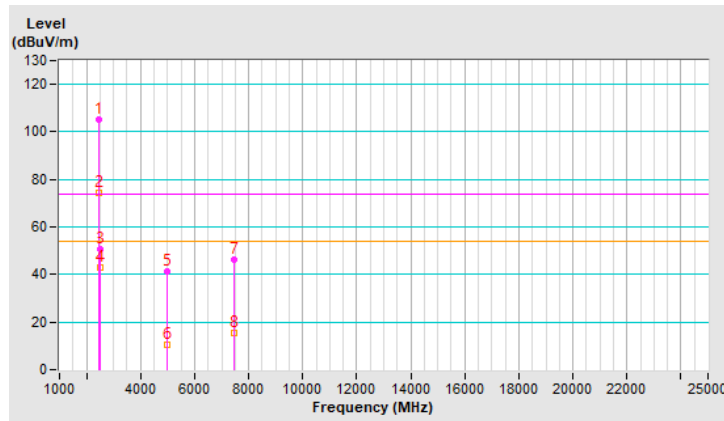

Plot of Band Edge

BT GFSK Channel 0

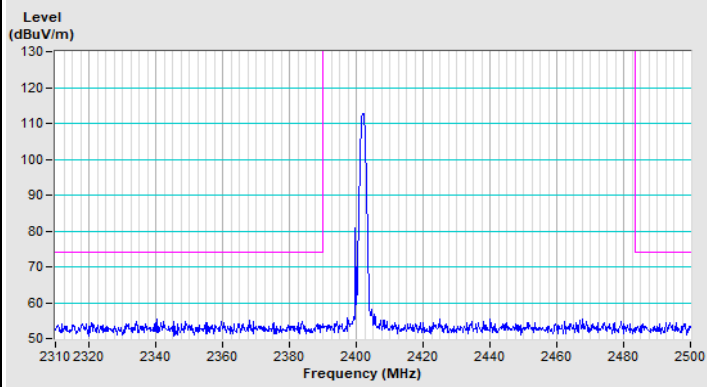

Horizontal (Peak)

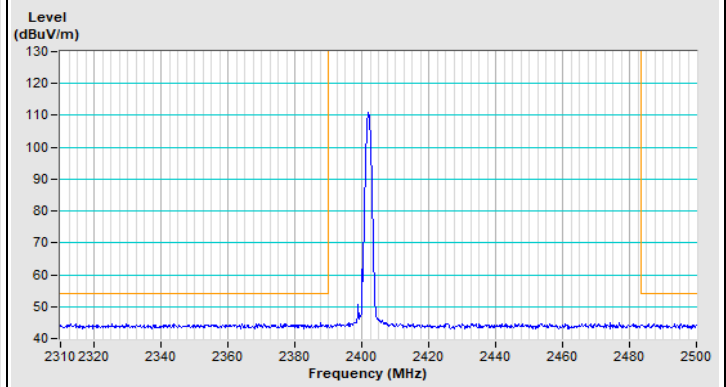

Horizontal (Average)

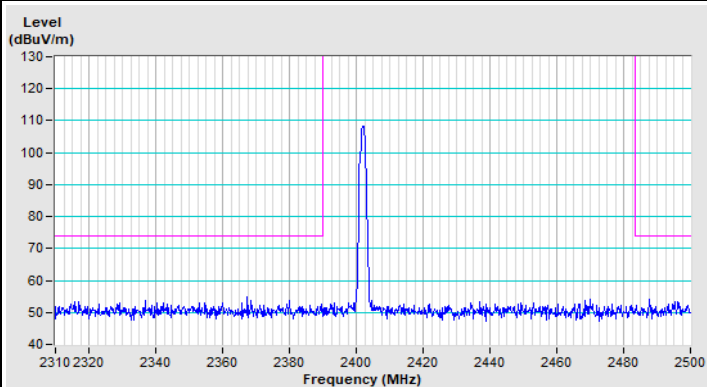

Vertical (Peak)

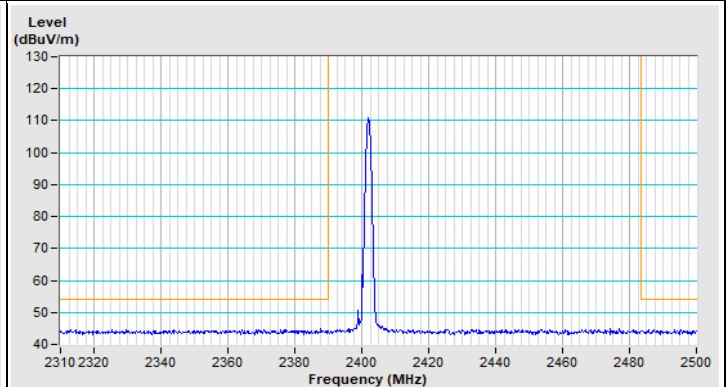

Vertical (Average)

BT GFSK Channel 78

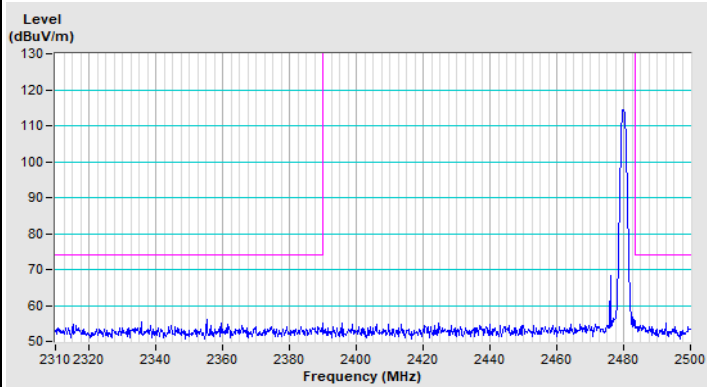

Horizontal (Peak)

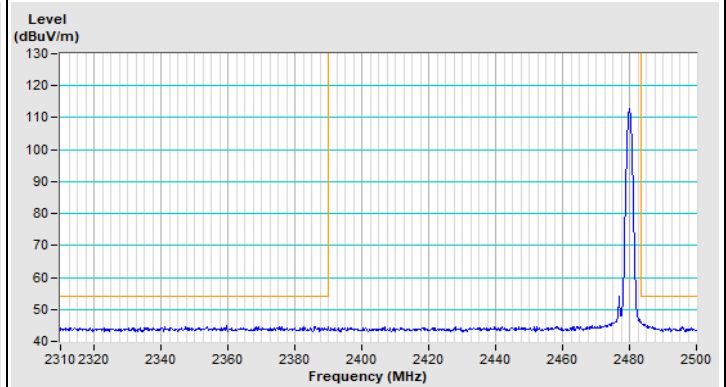

Horizontal (Average)

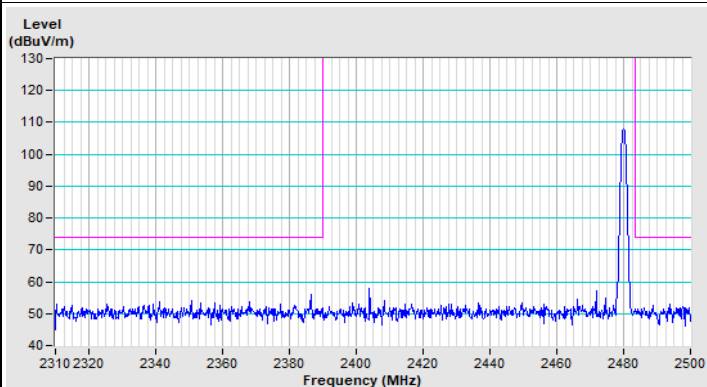

Vertical (Peak)

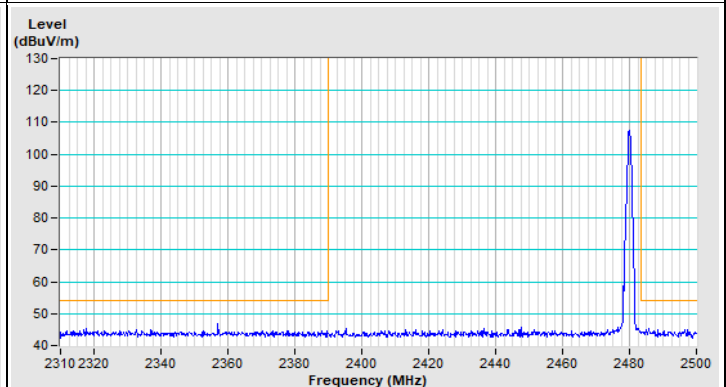

Vertical (Average)

BT 8DPSK Channel 0

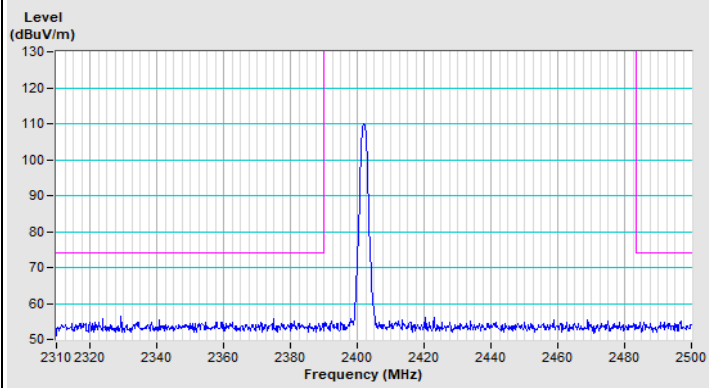

Horizontal (Peak)

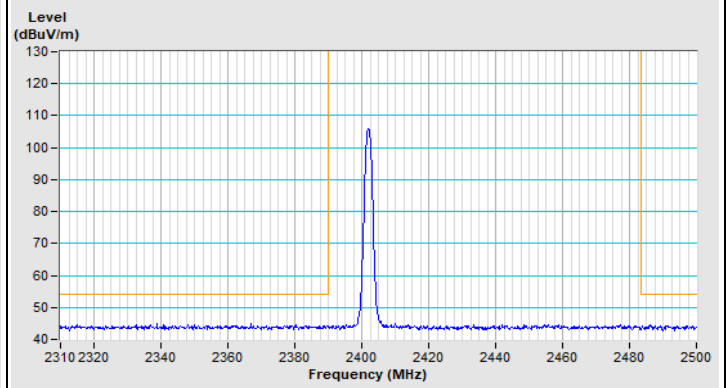

Horizontal (Average)

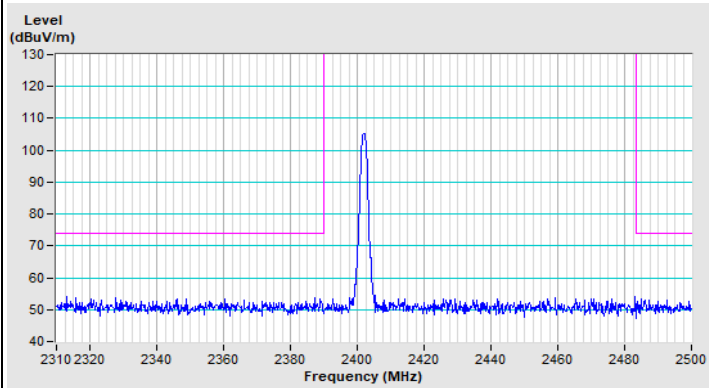

Vertical (Peak)

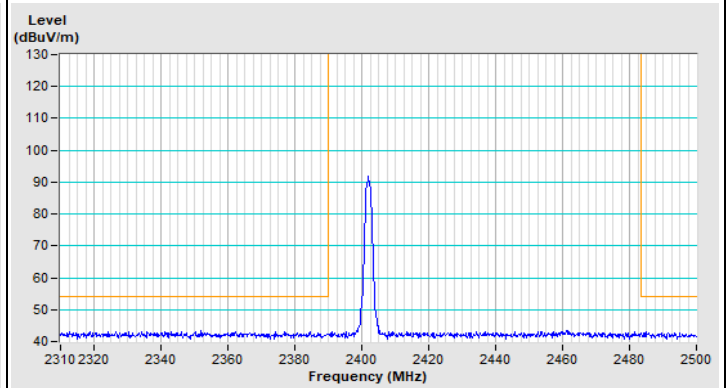

Vertical (Average)

BT 8DPSK Channel 78

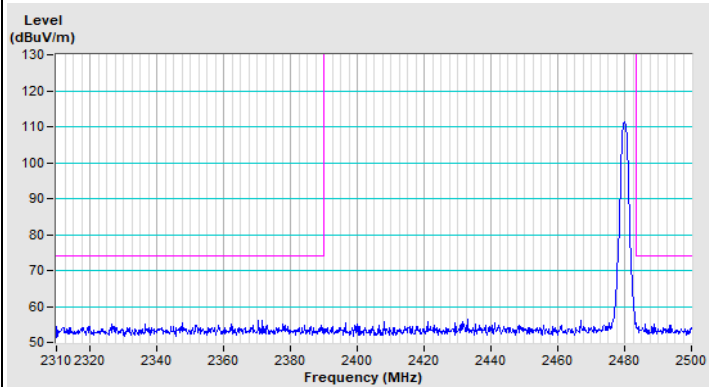

Horizontal (Peak)

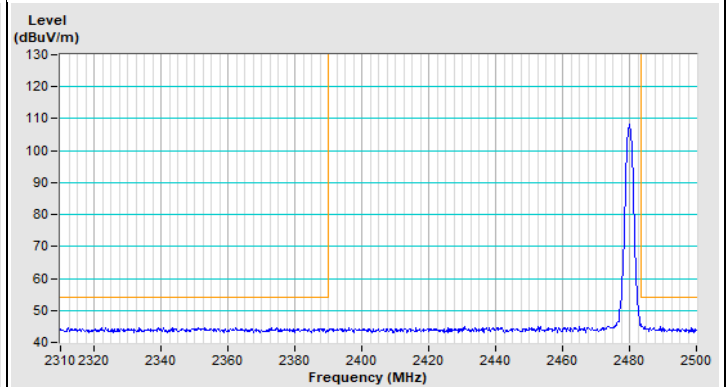

Horizontal (Average)

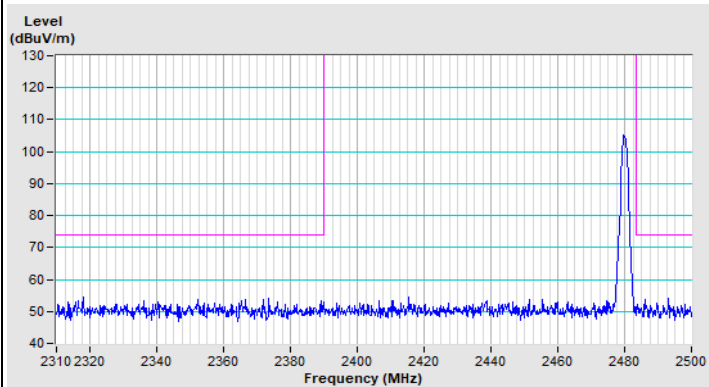

Vertical (Peak)

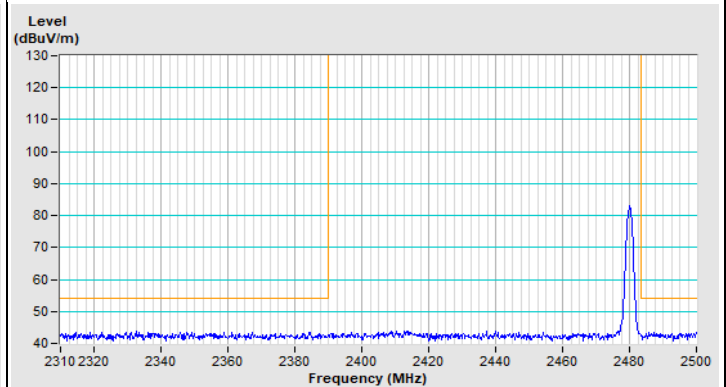

Vertical (Average)

8 Pictures of Test Arrangements

Please refer to the attached file (Test Setup Photo)

9 Information of the Testing Laboratories

We, Bureau Veritas Consumer Products Services (H.K.) Ltd., Taoyuan Branch, were founded in 1988 to provide our best service in EMC, Radio, Telecom and Safety consultation. Our laboratories are FCC recognized accredited test firms and accredited according to ISO/IEC 17025.

If you have any comments, please feel free to contact us at the following:

Lin Kou EMC/RF Lab

Tel: 886-2-26052180

Fax: 886-2-26051924

Hsin Chu EMC/RF/Telecom Lab

Tel: 886-3-6668565

Fax: 886-3-6668323

Hwa Ya EMC/RF/Safety Lab

Tel: 886-3-3183232

Fax: 886-3-3270892

Email: service.adt@bureauveritas.com

Web Site: <http://ee.bureauveritas.com.tw>

The address and road map of all our labs can be found in our web site also.

--- END ---