

FCC Test Report (BT-LE)

Report No.: RF200210E09

FCC ID: NKR-LS02

Test Model: SKP3R0-01

Received Date: Feb. 10, 2020

Test Date: Feb. 26 to Mar. 02, 2020

Issued Date: May 20, 2020

Applicant: Wistron NeWeb Corp.

Address: 20 Park Avenue II, Hsinchu Science Park, Hsinchu 308, Taiwan, R.O.C.

Issued By: Bureau Veritas Consumer Products Services (H.K.) Ltd., Taoyuan Branch
Hsin Chu Laboratory

Lab Address: E-2, No.1, Li Hsin 1st Road, Hsinchu Science Park, Hsinchu City 300,
Taiwan

Test Location : E-2, No.1, Li Hsin 1st Road, Hsinchu Science Park, Hsinchu City 300,
Taiwan

**FCC Registration /
Designation Number:** 723255 / TW2022



This report is for your exclusive use. Any copying or replication of this report to or for any other person or entity, or use of our name or trademark, is permitted only with our prior written permission. This report sets forth our findings solely with respect to the test samples identified herein. The results set forth in this report are not indicative or representative of the quality or characteristics of the lot from which a test sample was taken or any similar or identical product unless specifically and expressly noted. Our report includes all of the tests requested by you and the results thereof based upon the information that you provided to us. You have 60 days from date of issuance of this report to notify us of any material error or omission caused by our negligence, provided, however, that such notice shall be in writing and shall specifically address the issue you wish to raise. A failure to raise such issue within the prescribed time shall constitute your unqualified acceptance of the completeness of this report, the tests conducted and the correctness of the report contents. Unless specific mention, the uncertainty of measurement has been explicitly taken into account to declare the compliance or non-compliance to the specification. The report must not be used by the client to claim product certification, approval, or endorsement by TAF or any government agencies.

Table of Contents

Release Control Record	4
1 Certificate of Conformity	5
2 Summary of Test Results	6
2.1 Measurement Uncertainty.....	6
2.2 Modification Record.....	6
3 General Information	7
3.1 General Description of EUT (BT-LE).....	7
3.2 Description of Test Modes.....	8
3.2.1 Test Mode Applicability and Tested Channel Detail.....	9
3.3 Duty Cycle of Test Signal.....	10
3.4 Description of Support Units.....	11
3.4.1 Configuration of System under Test.....	11
3.5 General Description of Applied Standards and References.....	12
4 Test Types and Results	13
4.1 Radiated Emission and Bandedge Measurement.....	13
4.1.1 Limits of Radiated Emission and Bandedge Measurement.....	13
4.1.2 Test Instruments.....	14
4.1.3 Test Procedures.....	15
4.1.4 Deviation from Test Standard.....	15
4.1.5 Test Setup.....	16
4.1.6 EUT Operating Conditions.....	17
4.1.7 Test Results.....	18
4.2 Conducted Emission Measurement.....	23
4.2.1 Limits of Conducted Emission Measurement.....	23
4.2.2 Test Instruments.....	23
4.2.3 Test Procedures.....	24
4.2.4 Deviation from Test Standard.....	24
4.2.5 Test Setup.....	24
4.2.6 EUT Operating Conditions.....	24
4.2.7 Test Results.....	25
4.3 6dB Bandwidth Measurement.....	27
4.3.1 Limits of 6dB Bandwidth Measurement.....	27
4.3.2 Test Setup.....	27
4.3.3 Test Instruments.....	27
4.3.4 Test Procedure.....	27
4.3.5 Deviation from Test Standard.....	27
4.3.6 EUT Operating Conditions.....	27
4.3.7 Test Result.....	28
4.4 Conducted Output Power Measurement.....	29
4.4.1 Limits of Conducted Output Power Measurement.....	29
4.4.2 Test Setup.....	29
4.4.3 Test Instruments.....	29
4.4.4 Test Procedures.....	29
4.4.5 Deviation from Test Standard.....	29
4.4.6 EUT Operating Conditions.....	29
4.4.7 Test Results.....	30
4.5 Power Spectral Density Measurement.....	31
4.5.1 Limits of Power Spectral Density Measurement.....	31
4.5.2 Test Setup.....	31
4.5.3 Test Instruments.....	31
4.5.4 Test Procedure.....	31
4.5.5 Deviation from Test Standard.....	31

4.5.6 EUT Operating Condition	31
4.5.7 Test Results	32
5 Pictures of Test Arrangements.....	35
Appendix – Information of the Testing Laboratories	38

Release Control Record

Issue No.	Description	Date Issued
RF200210E09	Original release.	May 20, 2020

1 Certificate of Conformity

Product: Keypad

Brand: ADT

Test Model: SKP3R0-01

Sample Status: ENGINEERING SAMPLE

Applicant: Wistron NeWeb Corp.

Test Date: Feb. 26 to Mar. 02, 2020

Standards: 47 CFR FCC Part 15, Subpart C (Section 15.247)
ANSI C63.10: 2013

The above equipment has been tested by **Bureau Veritas Consumer Products Services (H.K.) Ltd., Taoyuan Branch**, and found compliance with the requirement of the above standards. The test record, data evaluation & Equipment Under Test (EUT) configurations represented herein are true and accurate accounts of the measurements of the sample's EMC characteristics under the conditions specified in this report.

Prepared by : Joyce Kuo , **Date:** May 20, 2020
Joyce Kuo / Specialist

Approved by : Clark Lin , **Date:** May 20, 2020
Clark Lin / Technical Manager

2 Summary of Test Results

47 CFR FCC Part 15, Subpart C (SECTION 15.247)			
FCC Clause	Test Item	Result	Remarks
15.207	AC Power Conducted Emission	Pass	Meet the requirement of limit. Minimum passing margin is -20.12dB at 24.19141 MHz.
15.205 & 209 & 15.247(d)	Radiated Emissions & Band Edge Measurement	Pass	Meet the requirement of limit. Minimum passing margin is -3.8dB at 2483.50 MHz.
15.247(d)	Antenna Port Emission	Pass	Meet the requirement of limit.
15.247(a)(2)	6dB bandwidth	Pass	Meet the requirement of limit.
15.247(b)	Conducted power	Pass	Meet the requirement of limit.
15.247(e)	Power Spectral Density	Pass	Meet the requirement of limit.
15.203	Antenna Requirement	Pass	Antenna connector is i-pex(MHF) not a standard connector.

Note: Determining compliance based on the results of the compliance measurement, not taking into account measurement instrumentation uncertainty.

2.1 Measurement Uncertainty

Where relevant, the following measurement uncertainty levels have been estimated for tests performed on the EUT as specified in CISPR 16-4-2:

Measurement	Frequency	Expanded Uncertainty (k=2) (\pm)
Conducted Emissions at mains ports	150kHz ~ 30MHz	1.8 dB
Conducted Emissions	-	3.1 dB
Radiated Emissions up to 1 GHz	9kHz ~ 30MHz	3.0 dB
	30MHz ~ 1GHz	4.8 dB
Radiated Emissions above 1 GHz	1GHz ~ 6GHz	5.0 dB
	6GHz ~ 18GHz	5.0 dB
	18GHz ~ 40GHz	5.3 dB

2.2 Modification Record

There were no modifications required for compliance.

3 General Information

3.1 General Description of EUT (BT-LE)

Product	Keypad
Brand	ADT
Test Model	SKP3R0-01
Status of EUT	ENGINEERING SAMPLE
Power Supply Rating	5Vdc from power adapter or 6Vdc from batteries
Modulation Type	GFSK
Modulation Technology	DTS
Transfer Rate	Up to 1Mbps
Operating Frequency	2.402 ~ 2.480GHz
Number of Channel	40
Output Power	1.648mW
Antenna Type	Refer to Note
Antenna Connector	Refer to Note
Accessory Device	Adapter x1
Cable Supplied	NA

Note:

1. There are Bluetooth and DECT technology used for the EUT. The EUT has two radios as following table:

Radio 1	Radio 2
Bluetooth	DECT

2. Simultaneously transmission condition.

Condition	Technology	
1	Bluetooth	DECT

Note: The emission of the simultaneous operation has been evaluated and no non-compliance was found.

3. The EUT uses following adapter.

Brand	Model No.	Spec.
FRECOM	F12L20-050200SPAU	AC Input: 100-240Vac, 0.3A, 50-60Hz DC Output: 5V, 2A DC cable: Unshielded, 1.8m

4. The antennas provided to the EUT, please refer to the following table:

Antenna NO.	Antenna Net Gain(dBi)	Frequency range	Antenna Type	Connector Type
BLE	2.94	2.4 GHz	Dipole	i-pex(MHF)
	3.36	2.45 GHz		
	2.77	2.5 GHz		
DECT	3.19	1921MHz	PIFA	i-pex(MHF)
	3.1	1925MHz		
	3.04	1928MHz		

5. For radiated emissions test, the EUT was pre-tested under the following modes:

Pre-test Mode	Description
Mode A	Power from adapter
Mode B	Power from battery

Note: From the above modes, the worst case was found in **Mode A**. Therefore only the test data of the mode was recorded in this report.

6. The above EUT information is declared by manufacturer and for more detailed features description, please refer to the manufacturer's specifications or user's manual.

3.2 Description of Test Modes

40 channels are provided to this EUT:

CHANNEL	FREQ. (MHz)	CHANNEL	FREQ. (MHz)	CHANNEL	FREQ. (MHz)	CHANNEL	FREQ. (MHz)
0	2402	10	2422	20	2442	30	2462
1	2404	11	2424	21	2444	31	2464
2	2406	12	2426	22	2446	32	2466
3	2408	13	2428	23	2448	33	2468
4	2410	14	2430	24	2450	34	2470
5	2412	15	2432	25	2452	35	2472
6	2414	16	2434	26	2454	36	2474
7	2416	17	2436	27	2456	37	2476
8	2418	18	2438	28	2458	38	2478
9	2420	19	2440	29	2460	39	2480

3.2.1 Test Mode Applicability and Tested Channel Detail

EUT CONFIGURE MODE	APPLICABLE TO				DESCRIPTION
	RE \geq 1G	RE<1G	PLC	APCM	
-	√	√	√	√	-

Where **RE \geq 1G**: Radiated Emission above 1GHz **RE<1G**: Radiated Emission below 1GHz
PLC: Power Line Conducted Emission **APCM**: Antenna Port Conducted Measurement

NOTE: The EUT had been pre-tested on the positioned of standing and wall-mount. The worst case was found when positioned of standing.

Radiated Emission Test (Above 1GHz):

- Pre-Scan has been conducted to determine the worst-case mode from all possible combinations between available modulations, data rates and antenna ports (if EUT with antenna diversity architecture).
- Following channel(s) was (were) selected for the final test as listed below.

AVAILABLE CHANNEL	TESTED CHANNEL	MODULATION TYPE	DATA RATE (Mbps)
0 to 39	0, 19, 39	GFSK	1

Radiated Emission Test (Below 1GHz):

- Pre-Scan has been conducted to determine the worst-case mode from all possible combinations between available modulations, data rates and antenna ports (if EUT with antenna diversity architecture).
- Following channel(s) was (were) selected for the final test as listed below.

AVAILABLE CHANNEL	TESTED CHANNEL	MODULATION TYPE	DATA RATE (Mbps)
0 to 39	39	GFSK	1

Power Line Conducted Emission Test:

- Pre-Scan has been conducted to determine the worst-case mode from all possible combinations between available modulations, data rates and antenna ports (if EUT with antenna diversity architecture).
- Following channel(s) was (were) selected for the final test as listed below.

AVAILABLE CHANNEL	TESTED CHANNEL	MODULATION TYPE	DATA RATE (Mbps)
0 to 39	39	GFSK	1

Antenna Port Conducted Measurement:

- This item includes all test value of each mode, but only includes spectrum plot of worst value of each mode.
- Pre-Scan has been conducted to determine the worst-case mode from all possible combinations between available modulations, data rates and antenna ports (if EUT with antenna diversity architecture).
- Following channel(s) was (were) selected for the final test as listed below.

AVAILABLE CHANNEL	TESTED CHANNEL	MODULATION TYPE	DATA RATE (Mbps)
0 to 39	0, 19, 39	GFSK	1

Test Condition:

Applicable To	Environmental Conditions	Input Power	Tested By
RE \geq 1G	21deg. C, 67%RH	120Vac, 60Hz	Ryan Du
RE $<$ 1G	23deg. C, 69%RH	120Vac, 60Hz	Ryan Du
PLC	25deg. C, 60%RH	120Vac, 60Hz	Andy Ho
APCM	25deg. C, 75%RH	120Vac, 60Hz	Kevin Ko

3.3 Duty Cycle of Test Signal

Duty cycle of test signal is $< 98\%$, duty factor shall be considered.

Duty cycle = $0.383 \text{ ms} / 0.626 \text{ ms} = 0.612$, Duty factor = $10 * \log(1/\text{Duty cycle}) = 0.612$

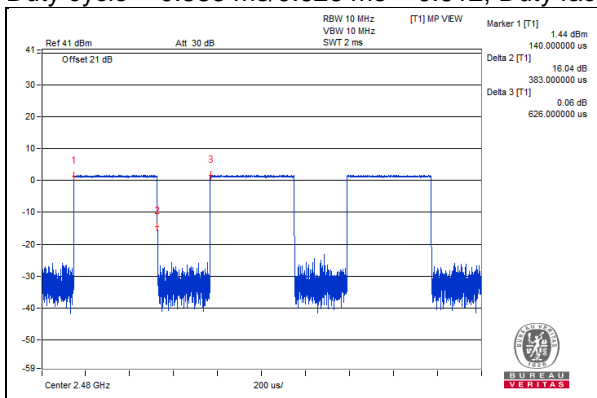

3.4 Description of Support Units

The EUT has been tested as an independent unit together with other necessary accessories or support units. The following support units or accessories were used to form a representative test configuration during the tests.

ID	Product	Brand	Model No.	Serial No.	FCC ID	Remarks
A.	Battery*4	Duracell	AAA	NA	NA	Provided by Lab

ID	Descriptions	Qty.	Length (m)	Shielding (Yes/No)	Cores (Qty.)	Remarks
1.	DC Cable	1	1.8	No	0	Supplied by client

3.4.1 Configuration of System under Test

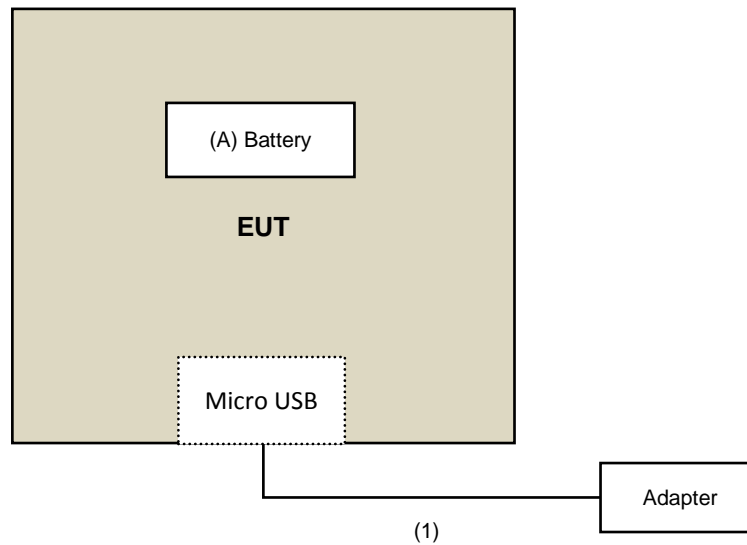

3.5 General Description of Applied Standards and References

The EUT is a RF Product. According to the specifications of the manufacturer, it must comply with the requirements of the following standards and References:

Test standard:
FCC Part 15, Subpart C (15.247)
ANSI C63.10-2013

All test items have been performed and recorded as per the above standards.

References Test Guidance:
KDB 558074 D01 15.247 Meas Guidance v05r02

All test items have been performed as a reference to the above KDB test guidance.

4 Test Types and Results

4.1 Radiated Emission and Bandedge Measurement

4.1.1 Limits of Radiated Emission and Bandedge Measurement

Radiated emissions which fall in the restricted bands must comply with the radiated emission limits specified as below table. Other emissions shall be at least 20dB below the highest level of the desired power:

Frequencies (MHz)	Field Strength (microvolts/meter)	Measurement Distance (meters)
0.009 ~ 0.490	2400/F(kHz)	300
0.490 ~ 1.705	24000/F(kHz)	30
1.705 ~ 30.0	30	30
30 ~ 88	100	3
88 ~ 216	150	3
216 ~ 960	200	3
Above 960	500	3

NOTE:

1. The lower limit shall apply at the transition frequencies.
2. Emission level (dBuV/m) = 20 log Emission level (uV/m).
3. For frequencies above 1000MHz, the field strength limits are based on average detector, however, the peak field strength of any emission shall not exceed the maximum permitted average limits, specified above by more than 20dB under any condition of modulation.

4.1.2 Test Instruments

DESCRIPTION & MANUFACTURER	MODEL NO.	SERIAL NO.	CALIBRATED DATE	CALIBRATED UNTIL
Test Receiver ESR7 R&S	ESR7	102026	Apr. 24, 2019	Apr. 23, 2020
Spectrum Analyzer Keysight	N9030B	MY57141948	May 25, 2019	May 24, 2020
Pre-Amplifier EMCI	EMC001340	980142	May 30, 2019	May 29, 2020
Loop Antenna Electro-Metrics	EM-6879	269	Sep. 16, 2019	Sep. 15, 2020
RF Cable	NA	LOOPCAB-001	Jan. 08, 2020	Jan. 07, 2021
RF Cable	NA	LOOPCAB-002	Jan. 08, 2020	Jan. 07, 2021
Pre-Amplifier EMCI	EMC330N	980538	Apr. 30, 2019	Apr. 29, 2020
Trilog Broadband Antenna SCHWARZBECK	VULB9168	9168-0842	Nov. 08, 2019	Nov. 07, 2020
RF Cable	8D	966-5-1	May 03, 2019	May 02, 2020
RF Cable	8D	966-5-2	May 03, 2019	May 02, 2020
RF Cable	8D	966-5-3	May 03, 2019	May 02, 2020
Fixed attenuator Mini-Circuits	UNAT-5+	PAD-ATT5-02	Jan. 14, 2020	Jan. 13, 2021
Horn_Antenna SCHWARZBECK	BBHA 9120D	9120D-1819	Nov. 24, 2019	Nov. 23, 2020
Pre-Amplifier EMCI	EMC12630SE	980509	May 03, 2019	May 02, 2020
RF Cable EMCI	EMC104-SM-SM-1500	180503	May 03, 2019	May 02, 2020
RF Cable EMCI	EMC104-SM-SM-2000	180501	May 03, 2019	May 02, 2020
RF Cable EMCI	EMC104-SM-SM-6000	180505	May 03, 2019	May 02, 2020
Pre-Amplifier EMCI	EMC184045SE	980387	Jan. 15, 2020	Jan. 14, 2021
Horn_Antenna SCHWARZBECK	BBHA 9170	BBHA9170519	Nov. 24, 2019	Nov. 23, 2020
RF Cable	EMC102-KM-KM-1200	160924	Jan. 15, 2020	Jan. 14, 2021
RF Cable	EMC102-KM-KM-4500	181205	Aug. 26, 2019	Aug. 25, 2020
Software	ADT_Radiated_V8.7.08	NA	NA	NA
Spectrum Analyzer R&S	FSV40	100964	June 04, 2019	June 03, 2020
Power meter Anritsu	ML2495A	1014008	May 13, 2019	May 12, 2020
Power sensor Anritsu	MA2411B	0917122	May 13, 2019	May 12, 2020
Fixed Attenuator Mini-Circuits	MDCS18N-10	MDCS18N-10-01	Apr. 15, 2019	Apr. 14, 2020

Note:

1. The calibration interval of the above test instruments is 12 months and the calibrations are traceable to NML/ROC and NIST/USA.
2. The test was performed in 966 Chamber No. 5.
3. Loop antenna was used for all emissions below 30 MHz.
4. Tested Date: Feb. 26 to Mar. 02, 2020

4.1.3 Test Procedures

For Radiated emission below 30MHz

- a. The EUT was placed on the top of a rotating table 0.8 meters above the ground at a 3 meter chamber room. The table was rotated 360 degrees to determine the position of the highest radiation.
- b. The EUT was set 3 meters away from the interference-receiving antenna, which was mounted on the top of a variable-height antenna tower.
- c. Parallel, perpendicular, and ground-parallel orientations of the antenna are set to make the measurement.
- d. For each suspected emission, the EUT was arranged to its worst case and the rotatable table was turned from 0 degrees to 360 degrees to find the maximum reading.
- e. The test-receiver system was set to Quasi-Peak Detect Function and Specified Bandwidth with Maximum Hold Mode.

NOTE:

1. The resolution bandwidth and video bandwidth of test receiver/spectrum analyzer is 9kHz at frequency below 30MHz.

For Radiated emission above 30MHz

- a. The EUT was placed on the top of a rotating table 0.8 meters (for 30MHz ~ 1GHz) / 1.5 meters (for above 1GHz) above the ground at 3 meter chamber room for test. The table was rotated 360 degrees to determine the position of the highest radiation.
- b. The EUT was set 3 meters away from the interference-receiving antenna, which was mounted on the top of a variable-height antenna tower.
- c. The height of antenna is varied from one meter to four meters above the ground to determine the maximum value of the field strength. Both horizontal and vertical polarizations of the antenna are set to make the measurement.
- d. For each suspected emission, the EUT was arranged to its worst case and then the antenna was tuned to heights from 1 meter to 4 meters and the rotatable table was turned from 0 degrees to 360 degrees to find the maximum reading.
- e. The test-receiver system was set to quasi-peak detect function and specified bandwidth with maximum hold mode when the test frequency is below 1 GHz.
- f. The test-receiver system was set to peak and average detect function and specified bandwidth with maximum hold mode when the test frequency is above 1 GHz. If the peak reading value also meets average limit, measurement with the average detector is unnecessary.

Note:

1. The resolution bandwidth and video bandwidth of test receiver/spectrum analyzer is 120kHz for Quasi-peak detection (QP) at frequency below 1GHz.
2. The resolution bandwidth of test receiver/spectrum analyzer is 1 MHz and the video bandwidth is 3 MHz for Peak detection (PK) at frequency above 1GHz.
3. The resolution bandwidth of test receiver/spectrum analyzer is 1MHz and the video bandwidth is $\geq 1/T$ (Duty cycle $< 98\%$) or 10Hz (Duty cycle $\geq 98\%$) for Average detection (AV) at frequency above 1GHz.
4. All modes of operation were investigated and the worst-case emissions are reported.

4.1.4 Deviation from Test Standard

No deviation.

4.1.5 Test Setup

For Radiated emission below 30MHz

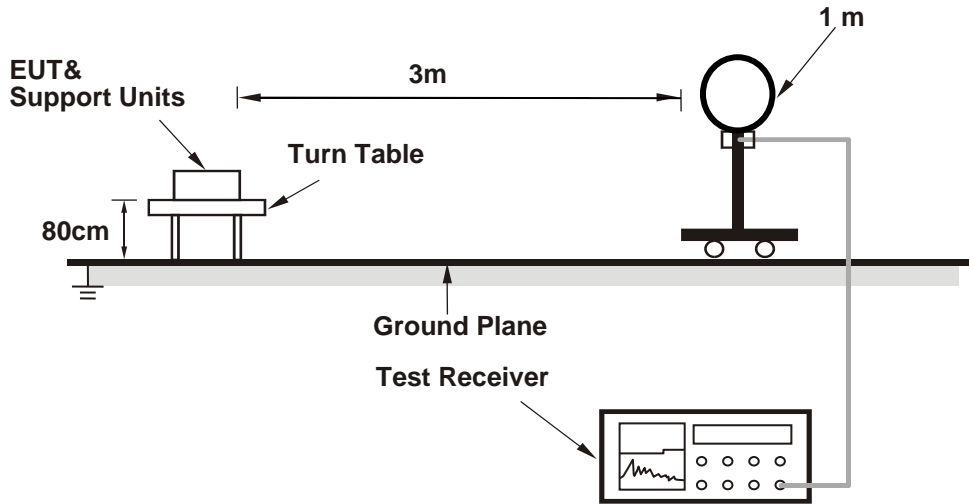

For Radiated emission 30MHz to 1GHz

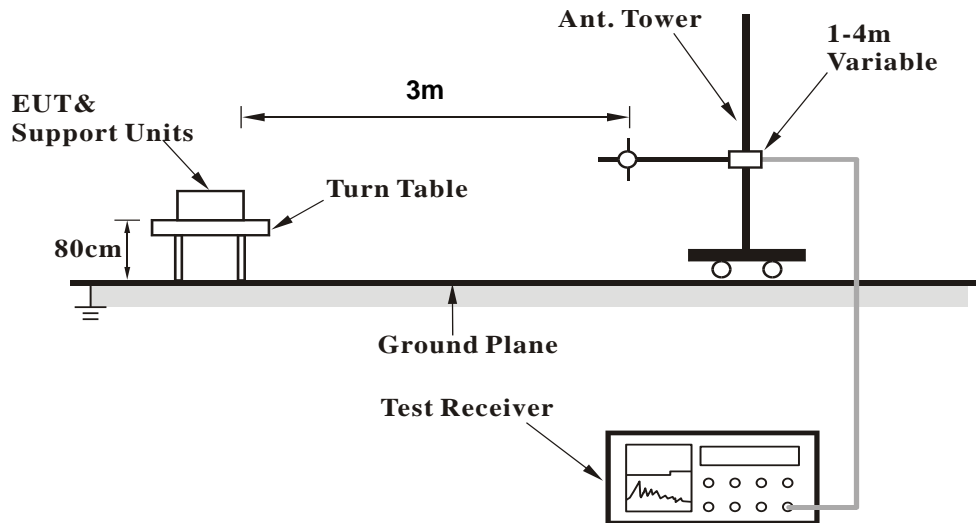

For Radiated emission above 1GHz

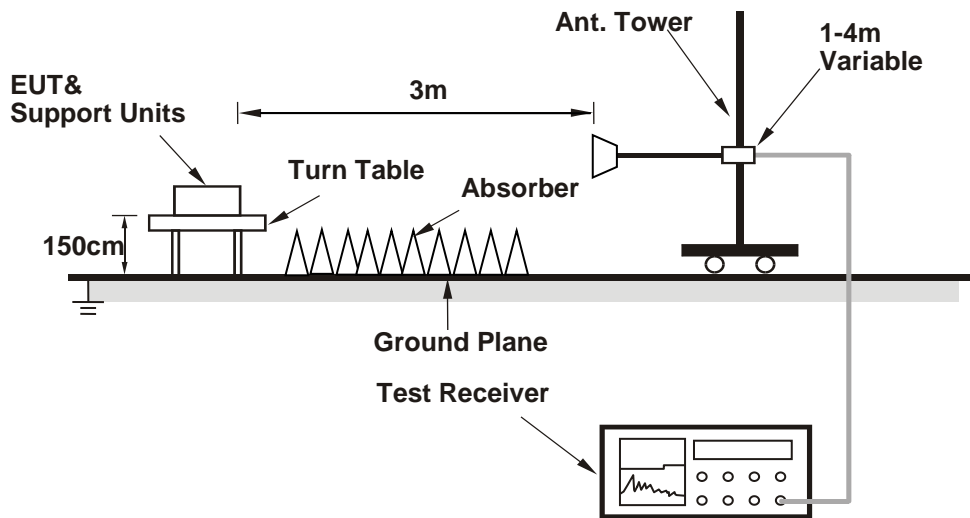

For the actual test configuration, please refer to the attached file (Test Setup Photo).

4.1.6 EUT Operating Conditions

- Placed the EUT on the testing table.
- Controlling software (Paste BLE command.txt) has been activated to set the EUT on specific status.

4.1.7 Test Results

Above 1GHz Data :

CHANNEL	TX Channel 0	DETECTOR FUNCTION	Peak (PK)
FREQUENCY RANGE	1GHz ~ 25GHz		Average (AV)

ANTENNA POLARITY & TEST DISTANCE: HORIZONTAL AT 3 M

NO.	FREQ. (MHz)	EMISSION LEVEL (dBuV/m)	LIMIT (dBuV/m)	MARGIN (dB)	ANTENNA HEIGHT (m)	TABLE ANGLE (Degree)	RAW VALUE (dBuV)	CORRECTION FACTOR (dB/m)
1	2390.00	56.7 PK	74.0	-17.3	3.77 H	242	59.8	-3.1
2	2390.00	43.0 AV	54.0	-11.0	3.77 H	242	46.1	-3.1
3	*2402.00	93.2 PK			3.77 H	242	96.3	-3.1
4	*2402.00	91.9 AV			3.77 H	242	95.0	-3.1
5	4804.00	40.5 PK	74.0	-33.5	1.82 H	135	39.3	1.2
6	4804.00	33.3 AV	54.0	-20.7	1.82 H	135	32.1	1.2

ANTENNA POLARITY & TEST DISTANCE: VERTICAL AT 3 M

NO.	FREQ. (MHz)	EMISSION LEVEL (dBuV/m)	LIMIT (dBuV/m)	MARGIN (dB)	ANTENNA HEIGHT (m)	TABLE ANGLE (Degree)	RAW VALUE (dBuV)	CORRECTION FACTOR (dB/m)
1	2390.00	60.7 PK	74.0	-13.3	1.05 V	27	63.8	-3.1
2	2390.00	43.2 AV	54.0	-10.8	1.05 V	27	46.3	-3.1
3	*2402.00	97.3 PK			1.05 V	27	100.4	-3.1
4	*2402.00	95.7 AV			1.05 V	27	98.8	-3.1
5	4804.00	40.9 PK	74.0	-33.1	1.50 V	258	39.7	1.2
6	4804.00	33.7 AV	54.0	-20.3	1.50 V	258	32.5	1.2

REMARKS:

1. Emission Level(dBuV/m) = Raw Value(dBuV) + Correction Factor(dB/m)
2. Correction Factor(dB/m) = Antenna Factor(dB/m) + Cable Factor(dB) – Pre-Amplifier Factor(dB)
3. Margin value = Emission Level – Limit value
4. The other emission levels were very low against the limit.
5. " * ": Fundamental frequency.

CHANNEL	TX Channel 19	DETECTOR FUNCTION	Peak (PK)
FREQUENCY RANGE	1GHz ~ 25GHz		Average (AV)

ANTENNA POLARITY & TEST DISTANCE: HORIZONTAL AT 3 M

NO.	FREQ. (MHz)	EMISSION LEVEL (dBuV/m)	LIMIT (dBuV/m)	MARGIN (dB)	ANTENNA HEIGHT (m)	TABLE ANGLE (Degree)	RAW VALUE (dBuV)	CORRECTION FACTOR (dB/m)
1	*2440.00	92.6 PK			3.74 H	226	95.7	-3.1
2	*2440.00	91.2 AV			3.74 H	226	94.3	-3.1
3	4880.00	40.9 PK	74.0	-33.1	1.82 H	134	39.8	1.1
4	4880.00	33.4 AV	54.0	-20.6	1.82 H	134	32.3	1.1
5	7320.00	43.3 PK	74.0	-30.7	1.69 H	165	36.0	7.3
6	7320.00	32.9 AV	54.0	-21.1	1.69 H	165	25.6	7.3

ANTENNA POLARITY & TEST DISTANCE: VERTICAL AT 3 M

NO.	FREQ. (MHz)	EMISSION LEVEL (dBuV/m)	LIMIT (dBuV/m)	MARGIN (dB)	ANTENNA HEIGHT (m)	TABLE ANGLE (Degree)	RAW VALUE (dBuV)	CORRECTION FACTOR (dB/m)
1	*2440.00	97.2 PK			1.09 V	29	100.3	-3.1
2	*2440.00	95.8 AV			1.09 V	29	98.9	-3.1
3	4880.00	41.1 PK	74.0	-32.9	1.44 V	244	40.0	1.1
4	4880.00	33.5 AV	54.0	-20.5	1.44 V	244	32.4	1.1
5	7320.00	44.5 PK	74.0	-29.5	2.18 V	231	37.2	7.3
6	7320.00	33.5 AV	54.0	-20.5	2.18 V	231	26.2	7.3

REMARKS:

1. Emission Level(dBuV/m) = Raw Value(dBuV) + Correction Factor(dB/m)
2. Correction Factor(dB/m) = Antenna Factor(dB/m) + Cable Factor(dB) – Pre-Amplifier Factor(dB)
3. Margin value = Emission Level – Limit value
4. The other emission levels were very low against the limit.
5. " * ": Fundamental frequency.

CHANNEL	TX Channel 39	DETECTOR FUNCTION	Peak (PK)
FREQUENCY RANGE	1GHz ~ 25GHz		Average (AV)

ANTENNA POLARITY & TEST DISTANCE: HORIZONTAL AT 3 M

NO.	FREQ. (MHz)	EMISSION LEVEL (dBuV/m)	LIMIT (dBuV/m)	MARGIN (dB)	ANTENNA HEIGHT (m)	TABLE ANGLE (Degree)	RAW VALUE (dBuV)	CORRECTION FACTOR (dB/m)
1	*2480.00	92.8 PK			3.73 H	228	95.9	-3.1
2	*2480.00	91.6 AV			3.73 H	228	94.7	-3.1
3	2483.50	67.0 PK	74.0	-7.0	3.73 H	228	70.1	-3.1
4	2483.50	43.1 AV	54.0	-10.9	3.73 H	228	46.2	-3.1
5	4960.00	40.7 PK	74.0	-33.3	1.86 H	125	39.4	1.3
6	4960.00	33.4 AV	54.0	-20.6	1.86 H	125	32.1	1.3
7	7440.00	44.0 PK	74.0	-30.0	1.70 H	169	36.6	7.4
8	7440.00	33.4 AV	54.0	-20.6	1.70 H	169	26.0	7.4

ANTENNA POLARITY & TEST DISTANCE: VERTICAL AT 3 M

NO.	FREQ. (MHz)	EMISSION LEVEL (dBuV/m)	LIMIT (dBuV/m)	MARGIN (dB)	ANTENNA HEIGHT (m)	TABLE ANGLE (Degree)	RAW VALUE (dBuV)	CORRECTION FACTOR (dB/m)
1	*2480.00	97.6 PK			1.04 V	17	100.7	-3.1
2	*2480.00	96.2 AV			1.04 V	17	99.3	-3.1
3	2483.50	70.2 PK	74.0	-3.8	1.04 V	17	73.3	-3.1
4	2483.50	43.2 AV	54.0	-10.8	1.04 V	17	46.3	-3.1
5	4960.00	41.1 PK	74.0	-32.9	1.47 V	253	39.8	1.3
6	4960.00	33.7 AV	54.0	-20.3	1.47 V	253	32.4	1.3
7	7440.00	44.4 PK	74.0	-29.6	2.17 V	220	37.0	7.4
8	7440.00	33.4 AV	54.0	-20.6	2.17 V	220	26.0	7.4

REMARKS:

- Emission Level(dBuV/m) = Raw Value(dBuV) + Correction Factor(dB/m)
- Correction Factor(dB/m) = Antenna Factor(dB/m) + Cable Factor(dB) – Pre-Amplifier Factor(dB)
- Margin value = Emission Level – Limit value
- The other emission levels were very low against the limit.
- " * ": Fundamental frequency.

Below 1GHz Data:

CHANNEL	TX Channel 39	DETECTOR FUNCTION	Quasi-Peak (QP)
FREQUENCY RANGE	9kHz ~ 1GHz		

ANTENNA POLARITY & TEST DISTANCE: HORIZONTAL AT 3 M								
NO.	FREQ. (MHz)	EMISSION LEVEL (dBuV/m)	LIMIT (dBuV/m)	MARGIN (dB)	ANTENNA HEIGHT (m)	TABLE ANGLE (Degree)	RAW VALUE (dBuV)	CORRECTION FACTOR (dB/m)
1	50.01	22.9 QP	40.0	-17.1	2.00 H	0	35.6	-12.7
2	63.97	27.2 QP	40.0	-12.8	3.00 H	100	41.0	-13.8
3	118.88	30.5 QP	43.5	-13.0	2.50 H	267	45.5	-15.0
4	142.64	35.6 QP	43.5	-7.9	1.50 H	61	48.5	-12.9
5	213.91	35.1 QP	43.5	-8.4	1.00 H	295	51.1	-16.0
6	285.18	36.6 QP	46.0	-9.4	1.00 H	73	49.1	-12.5

REMARKS:

1. Emission Level(dBuV/m) = Raw Value(dBuV) + Correction Factor(dB/m)
2. Correction Factor(dB/m) = Antenna Factor(dB/m) + Cable Factor(dB) – Pre-Amplifier Factor(dB)
3. Margin value = Emission Level – Limit value
4. The other emission levels were very low against the limit of frequency range 30MHz~1000MHz.
5. The emission levels were very low against the limit of frequency range 9kHz~30MHz: the amplitude of spurious emissions attenuated more than 20 dB below the permissible value to be report.

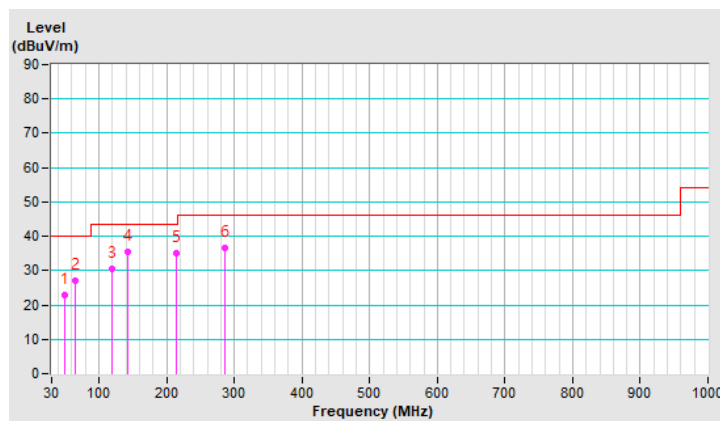

CHANNEL	TX Channel 39	DETECTOR FUNCTION	Quasi-Peak (QP)
FREQUENCY RANGE	9kHz ~ 1GHz		

ANTENNA POLARITY & TEST DISTANCE: VERTICAL AT 3 M

NO.	FREQ. (MHz)	EMISSION LEVEL (dBuV/m)	LIMIT (dBuV/m)	MARGIN (dB)	ANTENNA HEIGHT (m)	TABLE ANGLE (Degree)	RAW VALUE (dBuV)	CORRECTION FACTOR (dB/m)
1	42.61	33.1 QP	40.0	-6.9	1.50 V	0	46.0	-12.9
2	59.42	32.1 QP	40.0	-7.9	1.00 V	239	45.5	-13.4
3	142.57	32.2 QP	43.5	-11.3	2.50 V	0	45.1	-12.9
4	178.24	30.9 QP	43.5	-12.6	1.00 V	360	44.9	-14.0
5	213.89	32.3 QP	43.5	-11.2	1.50 V	333	48.3	-16.0
6	285.23	34.1 QP	46.0	-11.9	1.50 V	17	46.6	-12.5

REMARKS:

1. Emission Level(dBuV/m) = Raw Value(dBuV) + Correction Factor(dB/m)
2. Correction Factor(dB/m) = Antenna Factor(dB/m) + Cable Factor(dB) – Pre-Amplifier Factor(dB)
3. Margin value = Emission Level – Limit value
4. The other emission levels were very low against the limit of frequency range 30MHz~1000MHz.
5. The emission levels were very low against the limit of frequency range 9kHz~30MHz: the amplitude of spurious emissions attenuated more than 20 dB below the permissible value to be report.

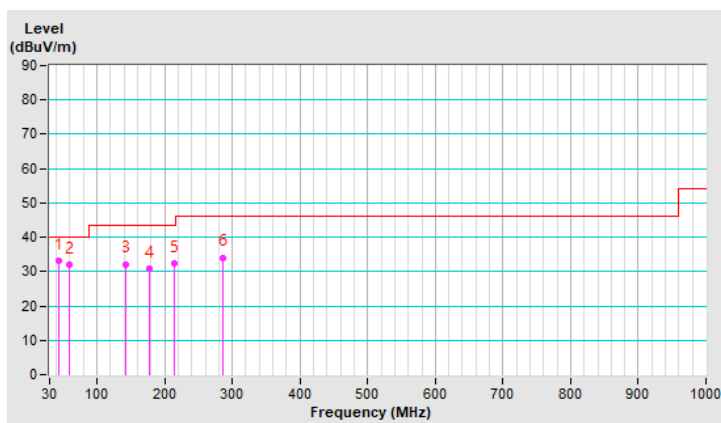

4.2 Conducted Emission Measurement

4.2.1 Limits of Conducted Emission Measurement

Frequency (MHz)	Conducted Limit (dBuV)	
	Quasi-peak	Average
0.15 - 0.5	66 - 56	56 - 46
0.50 - 5.0	56	46
5.0 - 30.0	60	50

Note: 1. The lower limit shall apply at the transition frequencies.

2. The limit decreases in line with the logarithm of the frequency in the range of 0.15 to 0.50MHz.

4.2.2 Test Instruments

DESCRIPTION & MANUFACTURER	MODEL NO.	SERIAL NO.	CALIBRATED DATE	CALIBRATED UNTIL
Test Receiver R&S	ESCS 30	847124/029	Oct. 23, 2019	Oct. 22, 2020
Line-Impedance Stabilization Network (for EUT) R&S	ESH3-Z5	848773/004	Oct. 23, 2019	Oct. 22, 2020
Line-Impedance Stabilization Network (for Peripheral) R&S	ESH3-Z5	835239/001	Mar. 17, 2019	Mar. 16, 2020
50 ohms Terminator	50	3	Oct. 23, 2019	Oct. 22, 2020
RF Cable	5D-FB	COCCAB-001	Sep. 27, 2019	Sep. 26, 2020
Fixed attenuator EMCI	STI02-2200-10	003	Mar. 14, 2019	Mar. 13, 2020
Software BVADT	BVADT_Cond_ V7.3.7.4	NA	NA	NA

Note:

1. The calibration interval of the above test instruments are 12 months and the calibrations are traceable to NML/ROC and NIST/USA.
2. The test was performed in Conduction 1.
3. Tested Date: Feb. 28, 2020

4.2.3 Test Procedures

- The EUT was placed 0.4 meters from the conducting wall of the shielded room with EUT being connected to the power mains through a line impedance stabilization network (LISN). Other support units were connected to the power mains through another LISN. The two LISNs provide 50 ohm/ 50uH of coupling impedance for the measuring instrument.
- Both lines of the power mains connected to the EUT were checked for maximum conducted interference.
- The frequency range from 150kHz to 30MHz was searched. Emission levels under (Limit - 20dB) was not recorded.

NOTE: The resolution bandwidth and video bandwidth of test receiver is 9kHz for quasi-peak detection (QP) and average detection (AV) at frequency 0.15MHz-30MHz.

4.2.4 Deviation from Test Standard

No deviation.

4.2.5 Test Setup

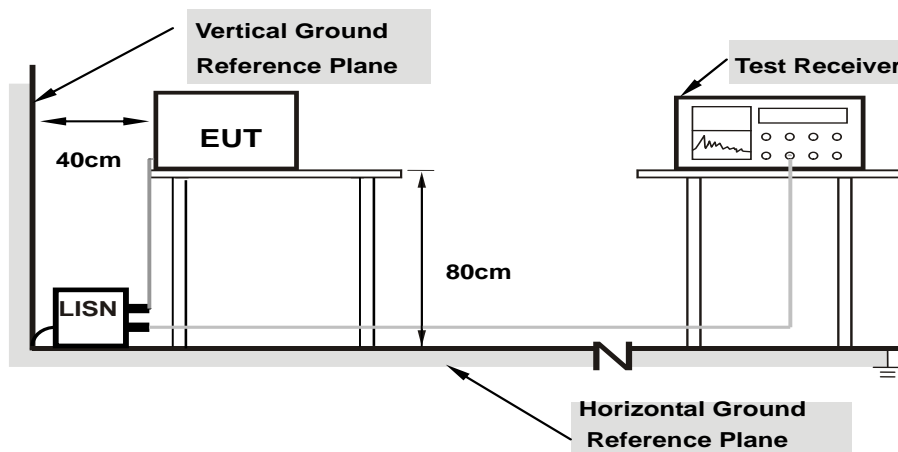

Note: 1.Support units were connected to second LISN.

For the actual test configuration, please refer to the attached file (Test Setup Photo).

4.2.6 EUT Operating Conditions

Same as 4.1.6.

4.2.7 Test Results

Phase	Line (L)	Detector Function	Quasi-Peak (QP) / Average (AV)
-------	----------	-------------------	--------------------------------

No	Freq. [MHz]	Corr. Factor	Reading Value [dB (uV)]		Emission Level [dB (uV)]		Limit [dB (uV)]		Margin (dB)	
		(dB)	Q.P.	AV.	Q.P.	AV.	Q.P.	AV.	Q.P.	AV.
	1	0.15391	9.99	33.90	20.08	43.89	30.07	65.79	55.79	-21.90
2	0.18125	9.99	30.92	16.78	40.91	26.77	64.43	54.43	-23.52	-27.66
3	0.23984	9.99	23.44	9.78	33.43	19.77	62.10	52.10	-28.67	-32.33
4	0.52891	10.01	19.70	11.37	29.71	21.38	56.00	46.00	-26.29	-24.62
5	7.69531	10.50	12.76	5.90	23.26	16.40	60.00	50.00	-36.74	-33.60
6	24.19141	11.52	23.65	18.36	35.17	29.88	60.00	50.00	-24.83	-20.12

Remarks:

1. Q.P. and AV. are abbreviations of quasi-peak and average individually.
2. The emission levels of other frequencies were very low against the limit.
3. Margin value = Emission level – Limit value
4. Correction factor = Insertion loss + Cable loss
5. Emission Level = Correction Factor + Reading Value

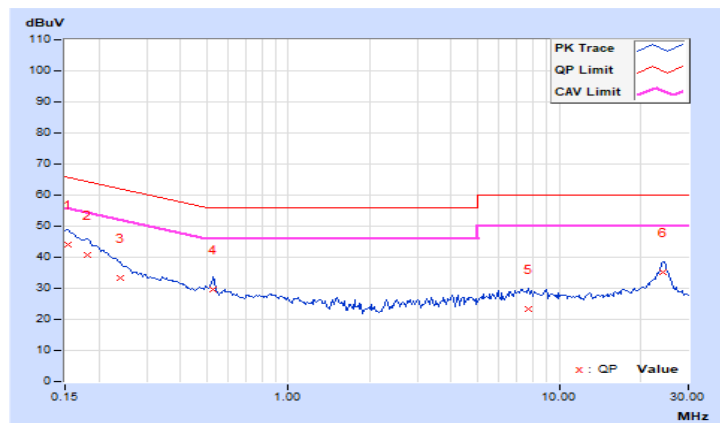

Phase	Neutral (N)	Detector Function	Quasi-Peak (QP) / Average (AV)
-------	-------------	-------------------	--------------------------------

No	Freq. [MHz]	Corr. Factor	Reading Value [dB (uV)]		Emission Level [dB (uV)]		Limit [dB (uV)]		Margin (dB)	
		(dB)	Q.P.	AV.	Q.P.	AV.	Q.P.	AV.	Q.P.	AV.
	1	0.15781	9.99	31.70	16.99	41.69	26.98	65.58	55.58	-23.89
2	0.18516	9.99	28.04	14.05	38.03	24.04	64.25	54.25	-26.22	-30.21
3	0.23594	9.99	22.39	8.36	32.38	18.35	62.24	52.24	-29.86	-33.89
4	0.53672	10.02	15.50	8.94	25.52	18.96	56.00	46.00	-30.48	-27.04
5	8.67969	10.50	9.18	1.22	19.68	11.72	60.00	50.00	-40.32	-38.28
6	24.17578	11.21	19.99	15.36	31.20	26.57	60.00	50.00	-28.80	-23.43

Remarks:

1. Q.P. and AV. are abbreviations of quasi-peak and average individually.
2. The emission levels of other frequencies were very low against the limit.
3. Margin value = Emission level – Limit value
4. Correction factor = Insertion loss + Cable loss
5. Emission Level = Correction Factor + Reading Value

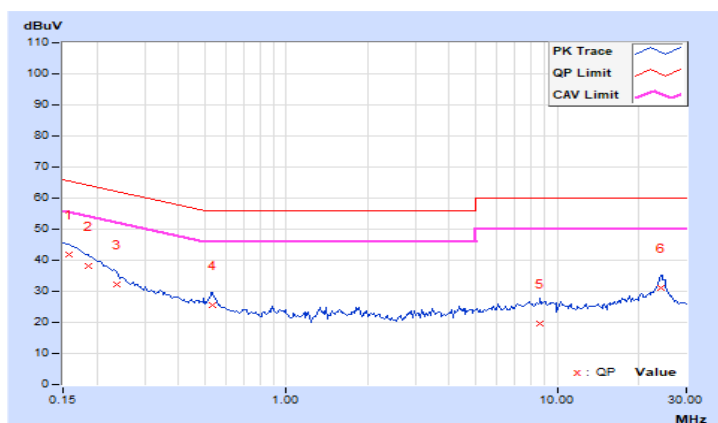

4.3 6dB Bandwidth Measurement

4.3.1 Limits of 6dB Bandwidth Measurement

The minimum of 6dB Bandwidth Measurement is 0.5 MHz.

4.3.2 Test Setup

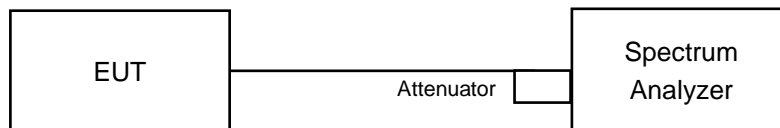

4.3.3 Test Instruments

Refer to section 4.1.2 to get information of above instrument.

4.3.4 Test Procedure

- a. Set resolution bandwidth (RBW) = 100kHz
- b. Set the video bandwidth (VBW) $\geq 3 \times$ RBW, Detector = Peak.
- c. Trace mode = max hold.
- d. Sweep = auto couple.
- e. Measure the maximum width of the emission that is constrained by the frequencies associated with the two amplitude points (upper and lower) that are attenuated by 6 dB relative to the maximum level measured in the fundamental emission

4.3.5 Deviation from Test Standard

No deviation.

4.3.6 EUT Operating Conditions

The software provided by client to enable the EUT under transmission condition continuously at lowest, middle and highest channel frequencies individually.

4.3.7 Test Result

Channel	Frequency (MHz)	6dB Bandwidth (MHz)	Minimum Limit (MHz)	Pass / Fail
0	2402	0.71	0.5	Pass
19	2440	0.72	0.5	Pass
39	2480	0.71	0.5	Pass

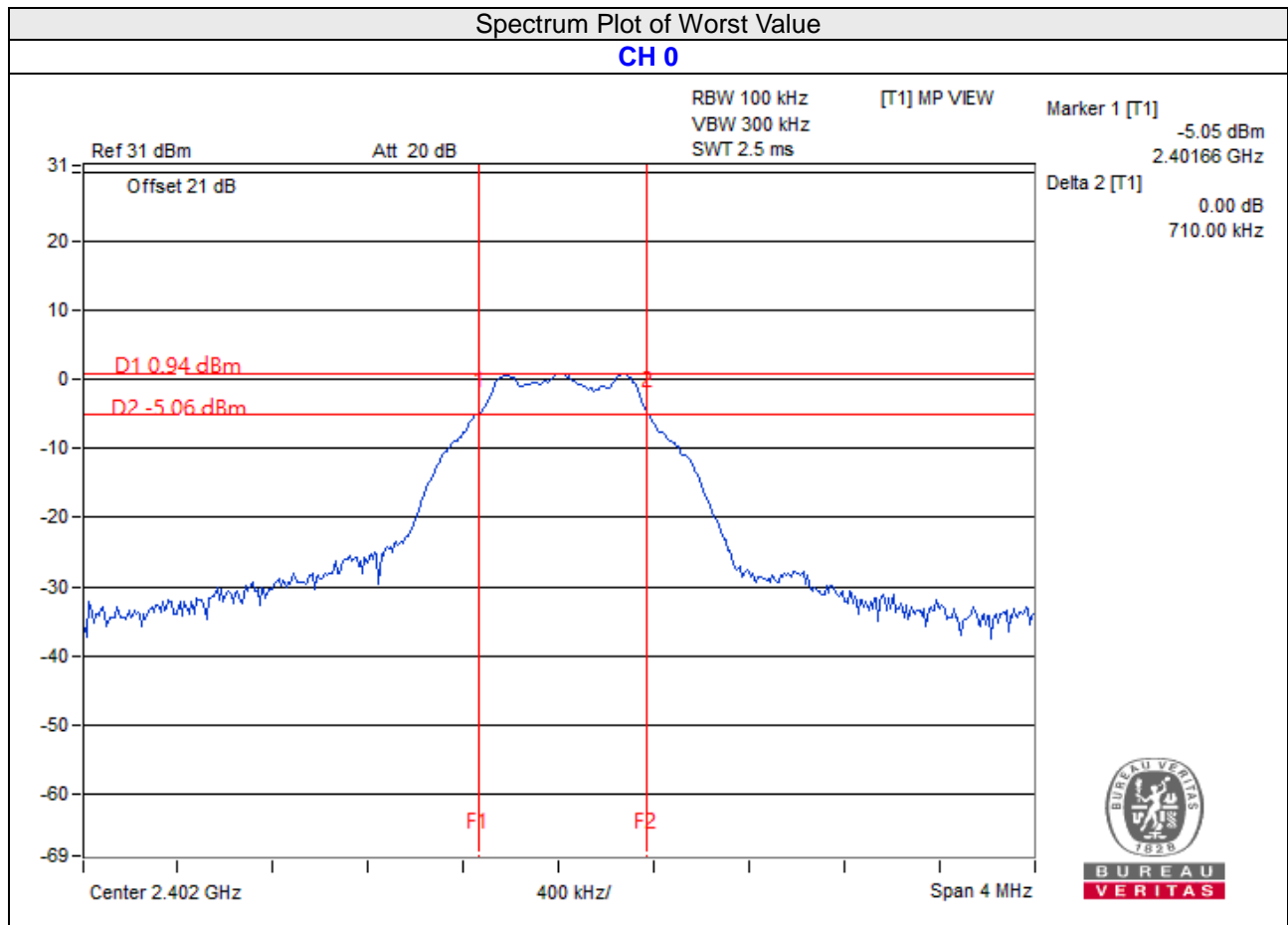

4.4 Conducted Output Power Measurement

4.4.1 Limits of Conducted Output Power Measurement

For systems using digital modulation in the 2400–2483.5 MHz bands: 1 Watt (30dBm)

4.4.2 Test Setup

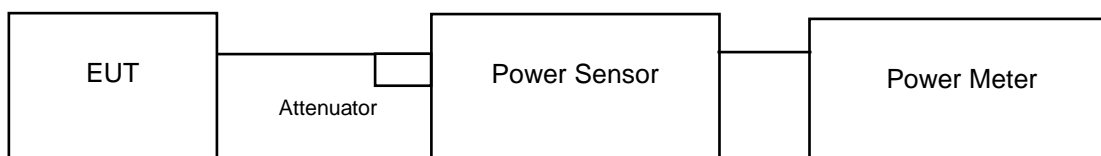

4.4.3 Test Instruments

Refer to section 4.1.2 to get information of above instrument.

4.4.4 Test Procedures

A peak power sensor was used on the output port of the EUT. A power meter was used to read the response of the peak power sensor. Record the power level.

Average power sensor was used to perform output power measurement, trigger and gating function of wide band power meter is enabled to measure max output power of TX on burst. Duty factor is not added to measured value..

4.4.5 Deviation from Test Standard

No deviation.

4.4.6 EUT Operating Conditions

The software provided by client to enable the EUT under transmission condition continuously at lowest, middle and highest channel frequencies individually.

4.4.7 Test Results

FOR PEAK POWER

Channel	Frequency (MHz)	Peak Power (mW)	Peak Power (dBm)	Limit (dBm)	Pass/Fail
0	2402	1.563	1.94	30.00	Pass
19	2440	1.6	2.04	30.00	Pass
39	2480	1.648	2.17	30.00	Pass

FOR AVERAGE POWER

Channel	Frequency (MHz)	Average Power (mW)	Average Power (dBm)
0	2402	1.122	0.50
19	2440	1.127	0.52
39	2480	1.132	0.54

4.5 Power Spectral Density Measurement

4.5.1 Limits of Power Spectral Density Measurement

The Maximum of Power Spectral Density Measurement is 8dBm in any 3kHz.

4.5.2 Test Setup

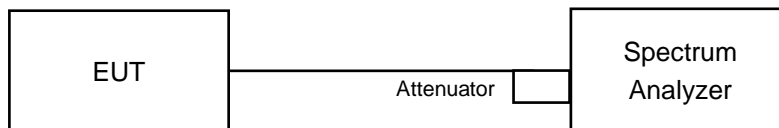

4.5.3 Test Instruments

Refer to section 4.1.2 to get information of above instrument.

4.5.4 Test Procedure

- a. Set analyzer center frequency to DTS channel center frequency.
- b. Set the span to 1.5 times the DTS bandwidth.
- c. Set the RBW to: $3 \text{ kHz} \leq \text{RBW} \leq 100 \text{ kHz}$.
- d. Set the VBW $\geq 3 \times \text{RBW}$.
- e. Detector = peak.
- f. Sweep time = auto couple.
- g. Trace mode = max hold.
- h. Allow trace to fully stabilize.
- i. Use the peak marker function to determine the maximum amplitude level within the RBW.

4.5.5 Deviation from Test Standard

No deviation.

4.5.6 EUT Operating Condition

Same as Item 4.3.6

4.5.7 Test Results

Channel	Freq. (MHz)	PSD (dBm/3kHz)	Limit (dBm/3kHz)	Pass /Fail
0	2402	-12.79	8	Pass
19	2440	-13.00	8	Pass
39	2480	-13.19	8	Pass

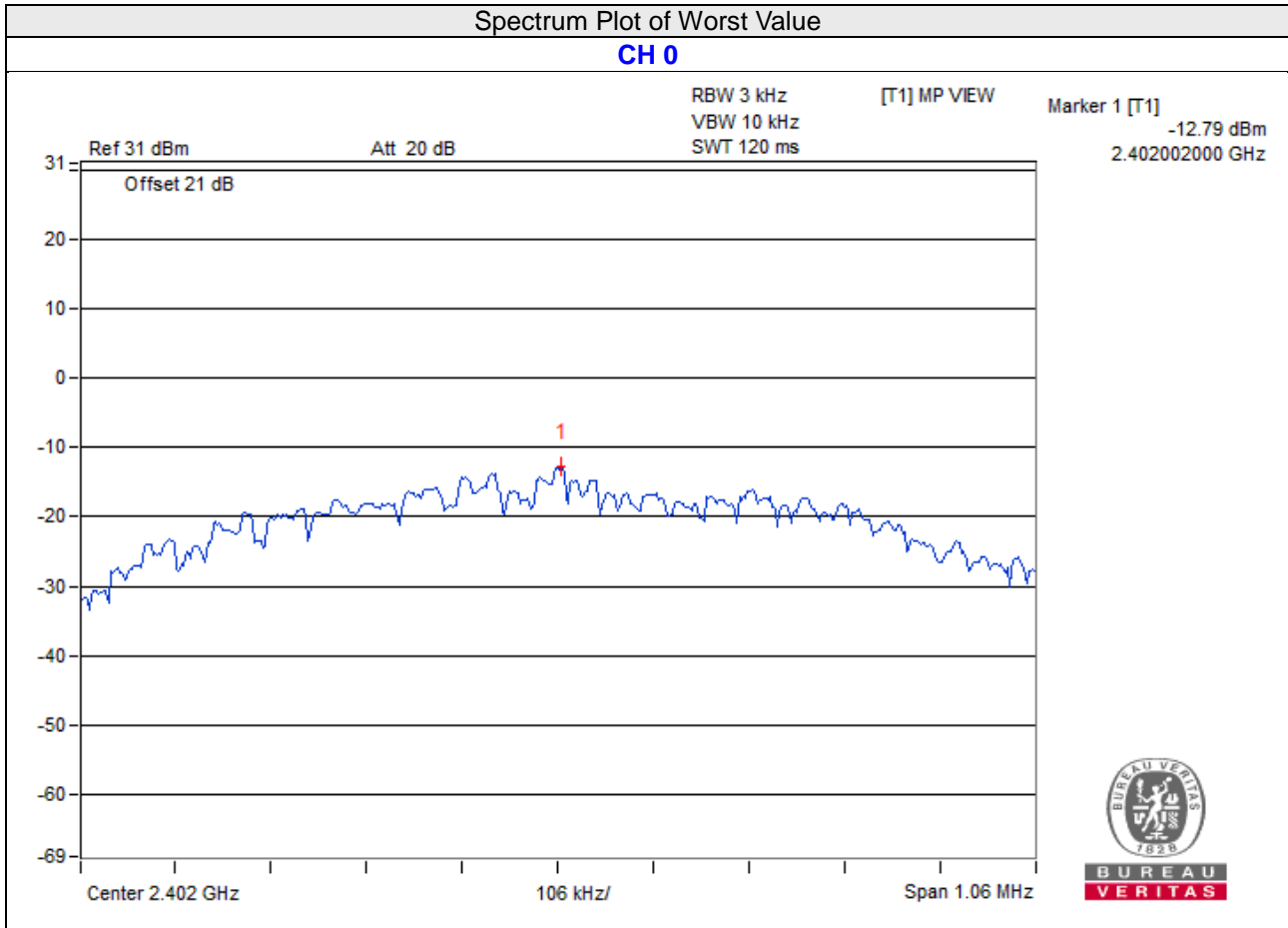

4.6 Conducted Out of Band Emission Measurement

4.6.1 Limits of Conducted Out of Band Emission Measurement

Below -20dB of the highest emission level of operating band (in 100kHz Resolution Bandwidth).

4.6.2 Test Setup

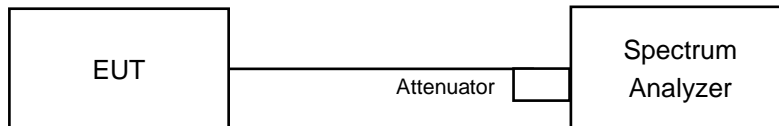

4.6.3 Test Instruments

Refer to section 4.1.2 to get information of above instrument.

4.6.4 Test Procedure

MEASUREMENT PROCEDURE REF

1. Set the RBW = 100 kHz.
2. Set the VBW \geq 300 kHz.
3. Detector = peak.
4. Sweep time = auto couple.
5. Trace mode = max hold.
6. Allow trace to fully stabilize.
7. Use the peak marker function to determine the maximum power level in any 100 kHz band segment within the fundamental EBW.

MEASUREMENT PROCEDURE OOBE

1. Set RBW = 100 kHz.
2. Set VBW \geq 300 kHz.
3. Detector = peak.
4. Sweep = auto couple.
5. Trace Mode = max hold.
6. Allow trace to fully stabilize.
7. Use the peak marker function to determine the maximum amplitude level.

4.6.5 Deviation from Test Standard

No deviation.

4.6.6 EUT Operating Condition

Same as Item 4.3.6

4.6.7 Test Results

BT-LE 1M

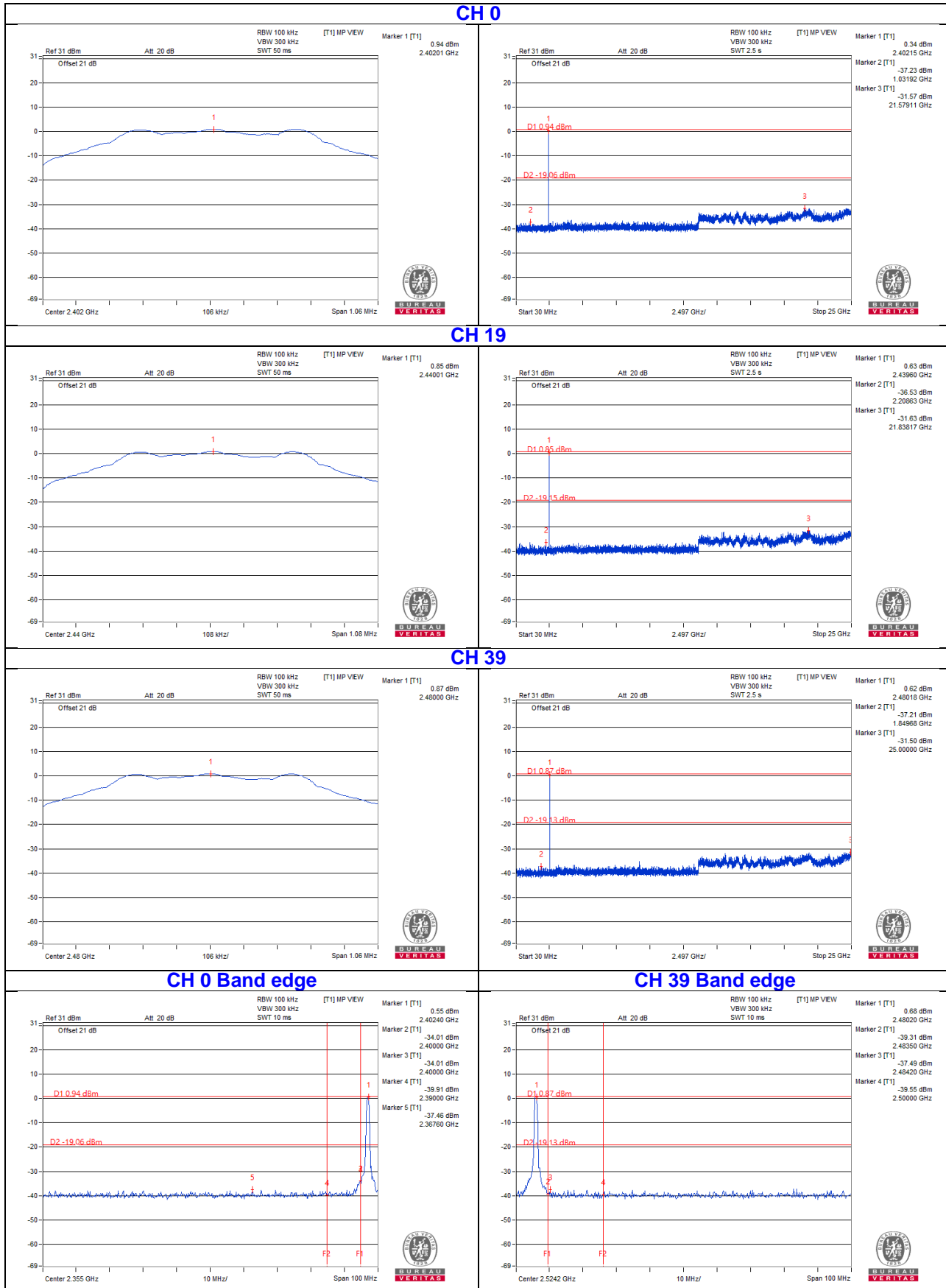

5 Pictures of Test Arrangements

Please refer to the attached file (Test Setup Photo).

Annex A- Band-edge measurement

Test Setup

<Radiated Emission above 1 GHz>

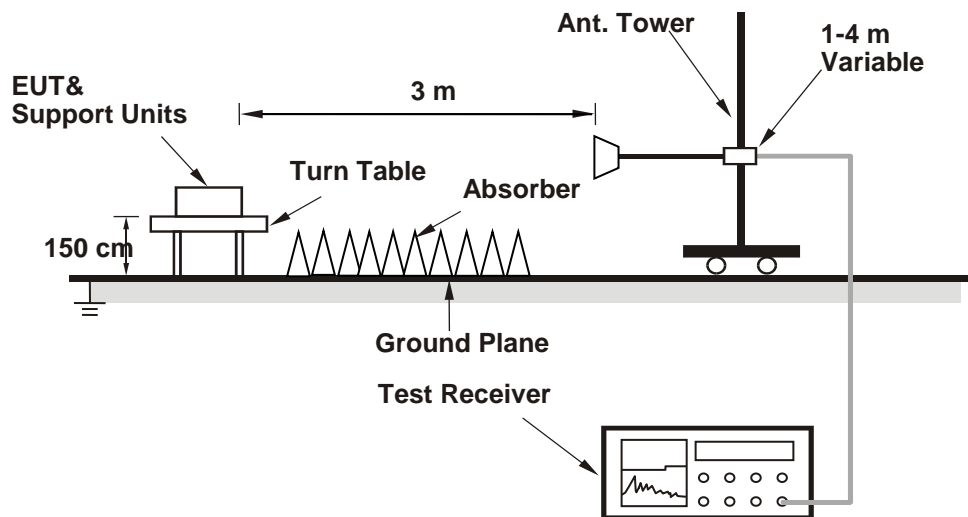

For the actual test configuration, please refer to the attached file (Test Setup Photo).

EUT Operating Conditions

- a. Placed the EUT on the testing table.
- b. Controlling software (Paste BLE command.txt) has been activated to set the EUT on specific status.

Test Results

BT_LE-1M

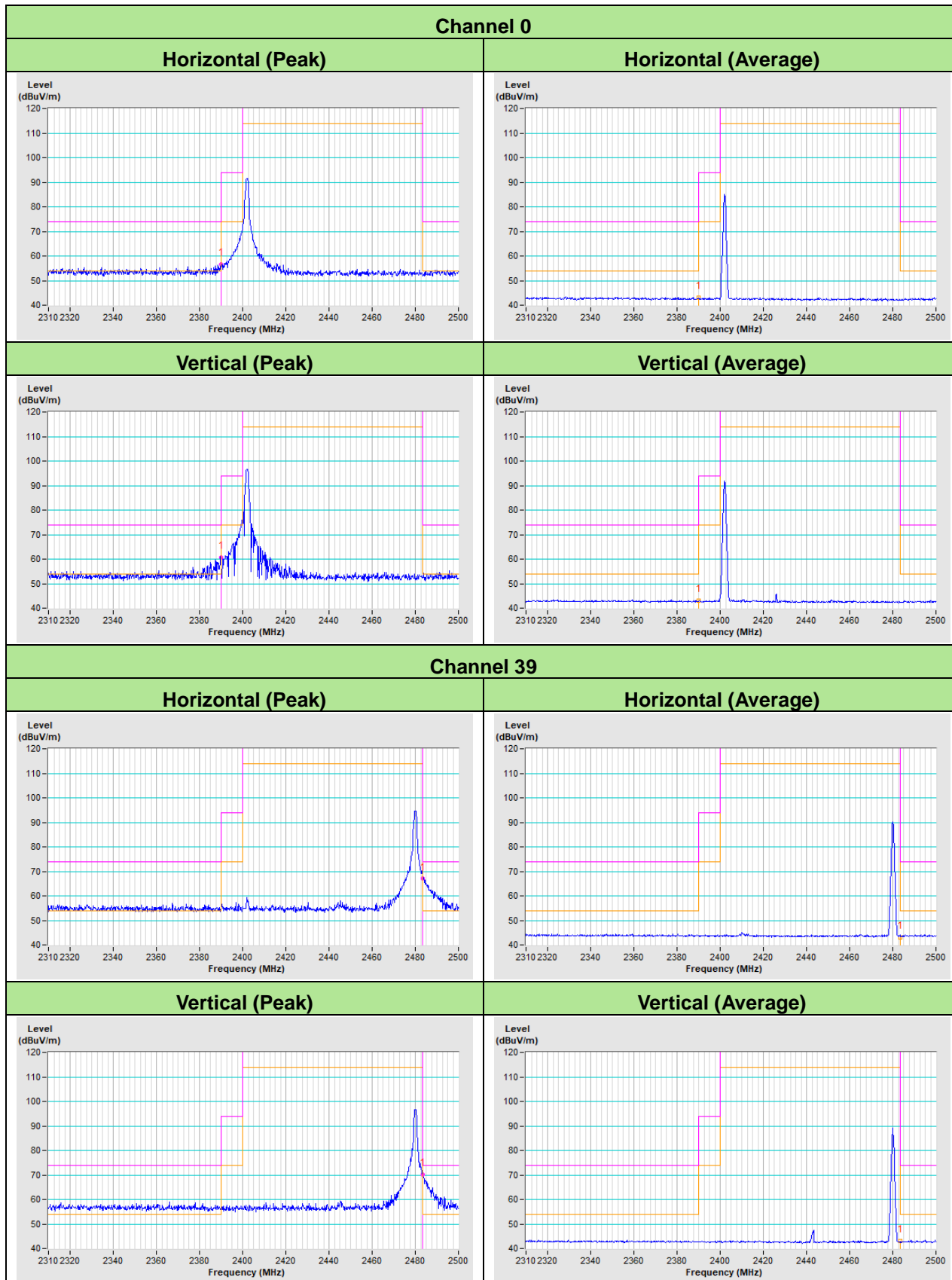

Appendix – Information of the Testing Laboratories

We, Bureau Veritas Consumer Products Services (H.K.) Ltd., Taoyuan Branch, were founded in 1988 to provide our best service in EMC, Radio, Telecom and Safety consultation. Our laboratories are FCC recognized accredited test firms and accredited according to ISO/IEC 17025.

If you have any comments, please feel free to contact us at the following:

Lin Kou EMC/RF Lab

Tel: 886-2-26052180

Fax: 886-2-26051924

Hsin Chu EMC/RF/Telecom Lab

Tel: 886-3-6668565

Fax: 886-3-6668323

Hwa Ya EMC/RF/Safety Lab

Tel: 886-3-3183232

Fax: 886-3-3270892

Email: service.adt@tw.bureauveritas.com

Web Site: www.bureauveritas-adt.com

The address and road map of all our labs can be found in our web site also.

--- END ---