



# FCC RF Test Report

**APPLICANT** : Wistron NeWeb Corporation  
**EQUIPMENT** : LTE Module  
**MODEL NAME** : IMG01,IMG0  
**FCC ID** : NKR-IMG01  
**STANDARD** : 47 CFR Part 2, 27  
**CLASSIFICATION** : PCS Licensed Transmitter (TNB)

The product was received on Oct. 28, 2014 and completely tested on Nov. 10, 2014. We, SPORTON INTERNATIONAL INC., would like to declare that the tested sample has been evaluated in accordance with the test procedures given in ANSI / TIA / EIA-603-C-2004 and the testing has shown the tested sample to be in compliance with the applicable technical standards.

The test results in this report apply exclusively to the tested model / sample. Without written approval of SPORTON INTERNATIONAL INC., the test report shall not be reproduced except in full.

Reviewed by: Joseph Lin / Supervisor

Approved by: Jones Tsai / Manager



## **SPORTON INTERNATIONAL INC.**

**No. 52, Hwa Ya 1<sup>st</sup> Rd., Hwa Ya Technology Park, Kwei-Shan Hsiang, Tao Yuan Hsien, Taiwan, R.O.C.**



## TABLE OF CONTENTS

**REVISION HISTORY** ..... 4

**SUMMARY OF TEST RESULT** ..... 5

**1 GENERAL DESCRIPTION** ..... 6

    1.1 Applicant ..... 6

    1.2 Manufacturer ..... 6

    1.3 Product Feature of Equipment Under Test ..... 6

    1.4 Product Specification subjective to this standard ..... 7

    1.5 Modification of EUT ..... 7

    1.6 Emission Designator ..... 8

    1.7 Testing Location ..... 9

    1.8 Applicable Standards ..... 9

**2 TEST CONFIGURATION OF EQUIPMENT UNDER TEST** ..... 10

    2.1 Test Mode ..... 10

    2.2 Connection Diagram of Test System ..... 11

    2.3 Support Unit used in test configuration and system ..... 12

    2.4 Measurement Results Explanation Example ..... 12

**3 CONDUCTED TEST ITEMS** ..... 13

    3.1 Measuring Instruments ..... 13

    3.2 Test Setup ..... 13

    3.3 Test Result of Conducted Test ..... 13

    3.4 Conducted Output Power and ERP/EIRP ..... 14

    3.5 Peak-to-Average Ratio ..... 15

    3.6 Occupied Bandwidth ..... 16

    3.7 Conducted Band Edge ..... 17

    3.8 Conducted Spurious Emission ..... 18

    3.9 Frequency Stability ..... 19

**4 RADIATED TEST ITEMS** ..... 20

    4.1 Measuring Instruments ..... 20

    4.2 Test Setup ..... 20

    4.3 Test Result of Radiated Test ..... 20

    4.4 Radiated Spurious Emission ..... 21

**5 LIST OF MEASURING EQUIPMENT** ..... 22

**6 UNCERTAINTY OF EVALUATION** ..... 23



**APPENDIX A. TEST RESULTS OF CONDUCTED TEST**

**APPENDIX B. TEST RESULTS OF RADIATED TEST**

**APPENDIX C. SETUP PHOTOGRAPHS**





**SUMMARY OF TEST RESULT**

Report Section	FCC Rule	Description	Limit	Result	Remark
3.4	§2.1046	Conducted Output Power	Reporting Only	PASS	-
3.5	N/A	Peak-to-Average Ratio	<13 dB	PASS	-
3.6	§2.1049 §27.53(h)(3)	Occupied Bandwidth	Reporting Only	PASS	-
3.7	§2.1051 §27.53(c)(2) §27.53(c)(4) §27.53(f) §27.53(g)	Conducted Band Edge Measurement	< 43+10log <sub>10</sub> (P[Watts])	PASS	-
3.8	§2.1053 §27.53(c)(2) §27.53(f) §27.53(g)	Conducted Spurious Emission	< 43+10log <sub>10</sub> (P[Watts])	PASS	-
3.9	§2.1055 §27.54	Frequency Stability Temperature & Voltage	< 2.5 ppm	PASS	
4.4	§27.50(b)(10)	Effective Radiated Power	ERP < 3 Watt	PASS	
	§27.50(d)(4)	Equivalent Isotropic Radiated Power	EIRP < 1Watt		
4.5	§2.1053 §27.53(c)(2) §27.53(f) §27.53(h)	Radiated Spurious Emission	< 43+10log <sub>10</sub> (P[Watts])	PASS	Under limit 8.18 dB at 1560.000 MHz



# 1 General Description

## 1.1 Applicant

**Wistron NeWeb Corporation**

20 Park Ave. II, Hsinchu Science Park, Hsinchu 308, Taiwan

## 1.2 Manufacturer

**Wistron NeWeb Corporation**

20 Park Ave. II, Hsinchu Science Park, Hsinchu 308, Taiwan

## 1.3 Product Feature of Equipment Under Test

Product Feature	
Equipment	LTE Module
Model Name	IMG01,IMG0
FCC ID	NKR-IMG01
EUT supports Radios application	LTE
EUT Stage	Identical Prototype

**Remark:** Two models are identical except the model number, the purpose of different model number is for market segmentation.



### 1.4 Product Specification subjective to this standard

Product Specification subjective to this standard	
<b>Tx Frequency</b>	LTE Band 4 : 1710.7 MHz ~ 1754.3 MHz LTE Band 13 : 779.5 MHz ~ 784.5 MHz
<b>Rx Frequency</b>	LTE Band 4 : 2110.7 MHz ~ 2154.3 MHz LTE Band 13 : 748.5 MHz ~ 753.5 MHz
<b>Bandwidth</b>	LTE Band 4 : 1.4MHz / 3MHz / 5MHz / 10MHz / 15MHz / 20MHz LTE Band 13 : 5MHz / 10MHz
<b>Maximum Output Power to Antenna</b>	LTE Band 4 : 22.93 dBm LTE Band 13 : 23.14 dBm
<b>Antenna Gain</b>	LTE Band 4 : 2.63 dBi LTE Band 13 : 6.33 dBi
<b>Type of Modulation</b>	QPSK / 16QAM

### 1.5 Modification of EUT

No modifications are made to the EUT during all test items.



### 1.6 Emission Designator

LTE Band 4		QPSK			16QAM		
BW(MHz)	Emission Designator (99%OBW)	Frequency Tolerance (ppm)	Maximum EIRP(W)	Emission Designator (99%OBW)	Frequency Tolerance (ppm)	Maximum EIRP(W)	
1.4	1M11G7D	-	0.3524	1M11W7D	-	0.3034	
3	2M74G7D	-	0.3597	2M74W7D	-	0.3055	
5	4M50G7D	-	0.3467	4M51W7D	-	0.2979	
10	9M10G7D	0.0029	0.3483	9M10W7D	-	0.2999	
15	13M5G7D	-	0.3565	13M6W7D	-	0.3013	
20	18M8G7D	-	0.3459	18M8W7D	-	0.2944	
LTE Band 13		QPSK			16QAM		
BW(MHz)	Emission Designator (99%OBW)	Frequency Tolerance (ppm)	Maximum ERP(W)	Emission Designator (99%OBW)	Frequency Tolerance (ppm)	Maximum ERP(W)	
5	4M50G7D	-	0.5395	4M49W7D	-	0.4508	
10	9M04G7D	0.0205	0.5395	9M04W7D	-	0.4753	





### 1.7 Testing Location

Sporton Lab is accredited to ISO 17025 by Taiwan Accreditation Foundation (TAF code : 1190) and the FCC designation No. TW1022 under the FCC 2.948(e) by Mutual Recognition Agreement (MRA) in FCC Test.

<b>Test Site</b>	SPORTON INTERNATIONAL INC.	
<b>Test Site Location</b>	No. 52, Hwa Ya 1 <sup>st</sup> Rd., Hwa Ya Technology Park, Kwei-Shan Hsiang, Tao Yuan Hsien, Taiwan, R.O.C. TEL: +886-3-327-3456 FAX: +886-3-328-4978	
<b>Test Site No.</b>	<b>Sporton Site No.</b>	
	TH02-HY	03CH07-HY

### 1.8 Applicable Standards

According to the specifications of the manufacturer, the EUT must comply with the requirements of the following standards:

- ♦ 47 CFR Part 2, 27
- ♦ ANSI / TIA / EIA-603-C-2004
- ♦ FCC KDB 971168 D01 Power Meas. License Digital Systems v02r02
- ♦ FCC KDB 412172 D01 Determining ERP and EIRP v01

**Remark:**

1. All test items were verified and recorded according to the standards and without any deviation during the test.
2. This EUT has also been tested and complied with the requirements of FCC Part 15, Subpart B, recorded in a separate test report.



## 2 Test Configuration of Equipment Under Test

### 2.1 Test Mode

Antenna port conducted and radiated test items listed below are performed according to KDB 971168 D01 Power Meas. License Digital Systems v02r02 with maximum output power.

Test Items	Band	Bandwidth (MHz)						Modulation		RB #			Test Channel		
		1.4	3	5	10	15	20	QPSK	16QAM	1	Half	Full	L	M	H
Max. Output Power	4	√	√	√	√	√	√	√	√	√	√	√	√	√	√
	13	-	-	√	√	-	-	√	√	√	√	√	√	√	√
Peak-to-Average Ratio	4						√	√	√	√		√	√	√	√
	13	-	-		√	-	-	√	√	√		√	√	√	√
26dB and 99% Bandwidth	4	√	√	√	√	√	√	√	√			√	√	√	√
	13	-	-	√	√	-	-	√	√			√	√	√	√
Conducted Band Edge	4	√	√	√	√	√	√	√	√	√		√	√		√
	13	-	-	√	√	-	-	√	√	√		√	√		√
Conducted Spurious Emission	4	√	√	√	√	√	√	√	√	√			√	√	√
	13	-	-	√	√	-	-	√	√	√			√	√	√
Frequency Stability	4				√			√				√		√	
	13	-	-		√	-	-	√				√		√	
E.R.P./ E.I.R.P.	4	√	√	√	√	√	√	√	√	√			√	√	√
	13	-	-	√	√	-	-	√	√	√			√	√	√
Radiated Spurious Emission	4	√	√	√	√	√	√	√	√	√	√	√	√	√	√
	13	-	-	√	√	-	-	√	√	√	√	√	√	√	√
Note	<ol style="list-style-type: none"> <li>The mark "√" means that this configuration is chosen for testing</li> <li>The mark "-" means that this bandwidth is not supported.</li> <li>For E.R.P./E.I.R.P. measurement, the widest bandwidth of each band is chosen for testing due to highest conducted power. Besides, the lowest bandwidth of each band is also measured for reporting only.</li> <li>The device is investigated from 30MHz to 10 times of fundamental signal for radiated spurious emission test under different RB size/offset and modulations in exploratory test. Subsequently, only the worst case emissions are reported.</li> </ol>														

## 2.2 Connection Diagram of Test System

### Radiated Spurious Emission (For Band 4)

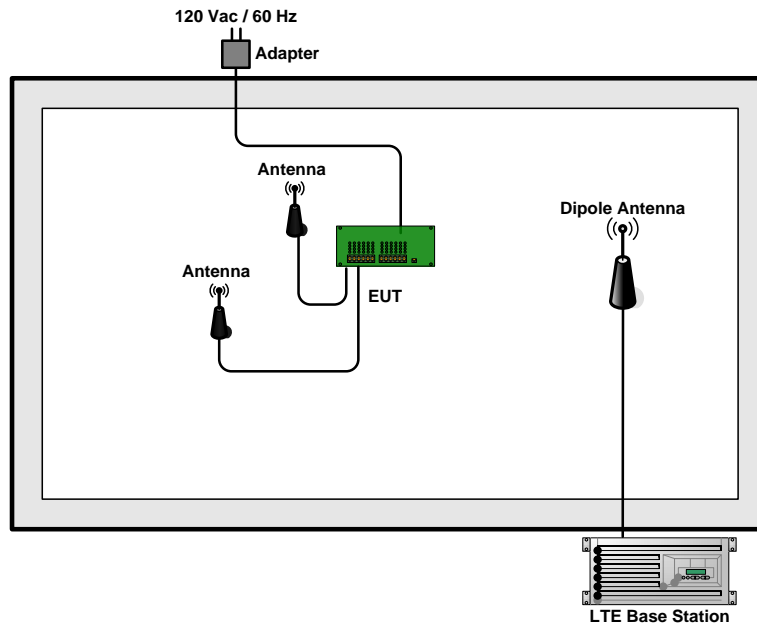

### Radiated Spurious Emission (For Band 13)

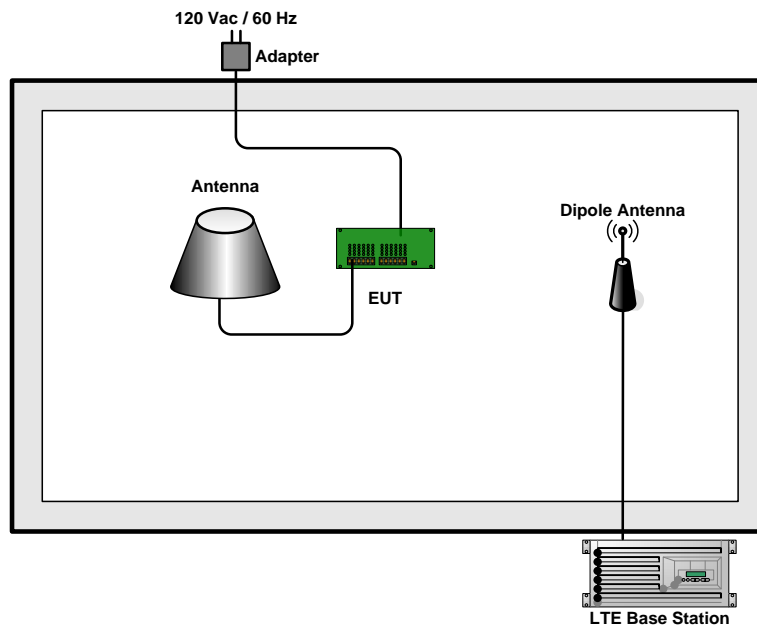



### 2.3 Support Unit used in test configuration and system

Item	Equipment	Trade Name	Model No.	FCC ID	Data Cable	Power Cord
1.	LTE Base Station	Anritsu	MT8820C	N/A	N/A	Unshielded, 1.8 m
2.	Fixture	N/A	N/A	N/A	N/A	N/A

### 2.4 Measurement Results Explanation Example

For all conducted test items:

The offset level is set in the spectrum analyzer to compensate the RF cable loss and attenuator factor between EUT conducted output port and spectrum analyzer. With the offset compensation, the spectrum analyzer reading level is exactly the EUT RF output level.

The spectrum analyzer offset is derived from RF cable loss and attenuator factor.

*Offset = RF cable loss + attenuator factor.*

Following shows an offset computation example with cable loss 4.2 dB and 10dB attenuator.

Example :

$$\begin{aligned} \text{Offset(dB)} &= \text{RF cable loss(dB)} + \text{attenuator factor(dB)}. \\ &= 4.2 + 10 = 14.2 \text{ (dB)} \end{aligned}$$

### 3 Conducted Test Items

#### 3.1 Measuring Instruments

See list of measuring instruments of this test report.

#### 3.2 Test Setup

##### 3.2.1 Conducted Output Power

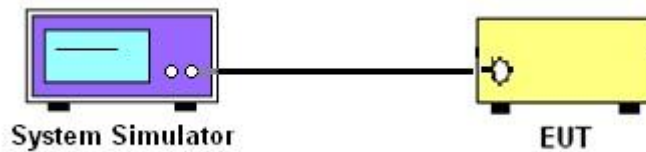

##### 3.2.2 Peak-to-Average Ratio, Occupied Bandwidth ,Conducted Band-Edge and Conducted Spurious Emission

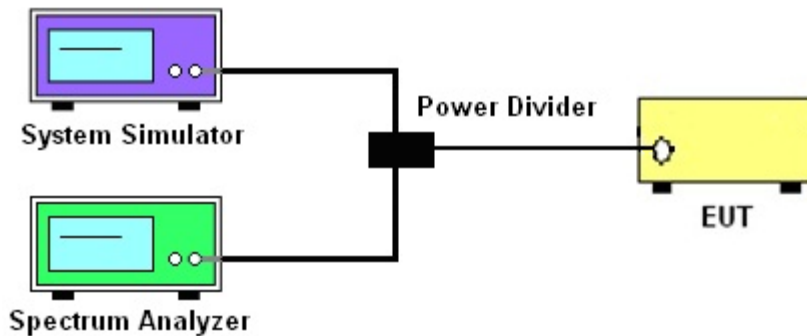

##### 3.2.3 Frequency Stability

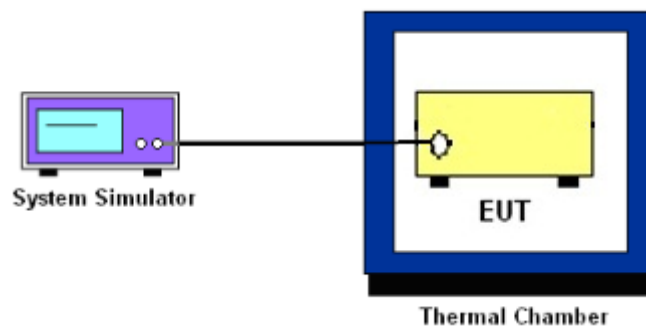

### 3.3 Test Result of Conducted Test

Please refer to Appendix A.



### 3.4 Conducted Output Power and ERP/EIRP

#### 3.4.1 Description of the Conducted Output Power Measurement and ERP/EIRP Measurement

A system simulator was used to establish communication with the EUT. Its parameters were set to force the EUT transmitting at maximum output power. The measured power in the radio frequency on the transmitter output terminals shall be reported.

The ERP of mobile transmitters must not exceed 3 Watts for LTE Band 13.

The EIRP of mobile transmitters must not exceed 1 Watts for LTE Band 4.

According to KDB 412172 D01 Power Approach,

$EIRP = P_T + G_T - L_C$ ,  $ERP = EIRP - 2.15$ , where

$P_T$  = transmitter output power in dBm

$G_T$  = gain of the transmitting antenna in dBi

$L_C$  = signal attenuation in the connecting cable between the transmitter and antenna in dB

#### 3.4.2 Test Procedures

1. The transmitter output port was connected to the system simulator.
2. Set EUT at maximum power through the system simulator.
3. Select lowest, middle, and highest channels for each band and different modulation.
4. Measure and record the power level from the system simulator.



## **3.5 Peak-to-Average Ratio**

### **3.5.1 Description of the PAR Measurement**

Power Complementary Cumulative Distribution Function (CCDF) curves provide a means for characterizing the power peaks of a digitally modulated signal on a statistical basis. A CCDF curve depicts the probability of the peak signal amplitude exceeding the average power level. Most contemporary measurement instrumentation include the capability to produce CCDF curves for an input signal provided that the instrument's resolution bandwidth can be set wide enough to accommodate the entire input signal bandwidth. In measuring transmissions in this band using an average power technique, the peak-to-average ratio (PAR) of the transmission may not exceed 13 dB.

### **3.5.2 Test Procedures**

1. The testing follows FCC KDB 971168 v02r02 Section 5.7.1.
2. The EUT was connected to spectrum and system simulator via a power divider.
3. Set the CCDF (Complementary Cumulative Distribution Function) option in spectrum analyzer.
4. The highest RF powers were measured and recorded the maximum PAPR level associated with a probability of 0.1 %.
5. Record the deviation as Peak to Average Ratio.



## **3.6 Occupied Bandwidth**

### **3.6.1 Description of Occupied Bandwidth Measurement**

The occupied bandwidth is the width of a frequency band such that, below the lower and above the upper frequency limits, the mean powers emitted are each equal to a specified percentage 0.5% of the total mean transmitted power.

The 26 dB emission bandwidth is defined as the frequency range between two points, one above and one below the carrier frequency, at which the spectral density of the emission is attenuated 26 dB below the maximum in-band spectral density of the modulated signal. Spectral density (power per unit bandwidth) is to be measured with a detector of resolution bandwidth equal to approximately 1.0% of the emission bandwidth.

### **3.6.2 Test Procedures**

1. The testing follows FCC KDB 971168 v02r02 Section 4.2.
2. The EUT was connected to spectrum analyzer and system simulator via a power divider.





### 3.7 Conducted Band Edge

#### 3.7.1 Description of Conducted Band Edge Measurement

27.53 (c) and RSS – 130 for Band 13

For operations in the 776-788 MHz band, the FCC limit is  $43 + 10\log_{10}(P[\text{Watts}])$  dB below the transmitter power P(Watts) in a 100 kHz bandwidth. However, in the 100 kHz bands immediately outside and adjacent to the frequency block, a resolution bandwidth of at least 30 kHz may be employed. In addition, the power of any unwanted emissions in any 6.25 kHz bandwidth for all frequencies between 763-775 MHz and 793-806 MHz shall be attenuated below the transmitter power, P (dBW), by at least  $65 + 10 \log_{10} p(\text{watts})$ , dB, for mobile and portable equipment.

27.53 (h) and RSS – 139 for Band 4

For operations in the 1710 – 1755 MHz band, the FCC limit is  $43 + 10\log_{10}(P[\text{Watts}])$  dB below the transmitter power P(Watts) in a 1 MHz bandwidth. However, in the 1MHz bands immediately outside and adjacent to the licensee's frequency block, a resolution bandwidth of at least one percent of the emission bandwidth of the fundamental emission of the transmitter may be employed.

#### 3.7.2 Test Procedures

1. The testing follows FCC KDB 971168 v02r02 Section 6.0.
2. The EUT was connected to spectrum analyzer and system simulator via a power divider.
3. The band edges of low and high channels for the highest RF powers were measured. Set RBW  $\geq 1\%$  EBW in the 1MHz band immediately outside and adjacent to the band edge.
4. Set spectrum analyzer with RMS detector.
5. The RF fundamental frequency should be excluded against the limit line in the operating frequency band.
6. The limit line is derived from  $43 + 10\log(P)$ dB below the transmitter power P(Watts)  
 $= P(\text{W}) - [43 + 10\log(P)]$  (dB)  
 $= [30 + 10\log(P)]$  (dBm) -  $[43 + 10\log(P)]$  (dB)  
 $= -13\text{dBm}$ .



### 3.8 Conducted Spurious Emission

#### 3.8.1 Description of Conducted Spurious Emission Measurement

The power of any emission outside of the authorized operating frequency ranges must be lower than the transmitter power (P) by a factor of at least  $43 + 10 \log (P)$  dB.

It is measured by means of a calibrated spectrum analyzer and scanned from 30 MHz up to a frequency including its 10<sup>th</sup> harmonic.

#### 3.8.2 Test Procedures

1. The testing follows FCC KDB 971168 v02r02 Section 6.0.
2. The EUT was connected to spectrum analyzer and system simulator via a power divider.
3. The RF output of EUT was connected to the spectrum analyzer by RF cable and attenuator. The path loss was compensated to the results for each measurement.
4. The middle channel for the highest RF power within the transmitting frequency was measured.
5. The conducted spurious emission for the whole frequency range was taken.
6. Make the measurement with the spectrum analyzer's RBW = 1MHz, VBW = 3MHz, taking the record of maximum spurious emission.
7. The RF fundamental frequency should be excluded against the limit line in the operating frequency band.
8. The limit line is derived from  $43 + 10\log(P)$ dB below the transmitter power P(Watts)  
=  $P(W) - [43 + 10\log(P)]$  (dB)  
=  $[30 + 10\log(P)]$  (dBm) -  $[43 + 10\log(P)]$  (dB)  
= -13dBm.



### 3.9 Frequency Stability

#### 3.9.1 Description of Frequency Stability Measurement

The frequency stability shall be measured by variation of ambient temperature and variation of primary supply voltage to ensure that the fundamental emission stays within the authorized frequency block. The frequency stability of the transmitter shall be maintained within  $\pm 0.00025\%$  ( $\pm 2.5\text{ppm}$ ) of the center frequency.

#### 3.9.2 Test Procedures for Temperature Variation

1. The EUT was set up in the thermal chamber and connected with the system simulator.
2. With power OFF, the temperature was decreased to  $-30^{\circ}\text{C}$  and the EUT was stabilized before testing. Power was applied and the maximum change in frequency was recorded within one minute.
3. With power OFF, the temperature was raised in  $10^{\circ}\text{C}$  step up to  $50^{\circ}\text{C}$ . The EUT was stabilized at each step for at least half an hour. Power was applied and the maximum frequency change was recorded within one minute.

#### 3.9.3 Test Procedures for Voltage Variation

1. The testing follows FCC KDB 971168 v02r02 Section 9.0.
2. The EUT was placed in a temperature chamber at  $25\pm 5^{\circ}\text{C}$  and connected with the system simulator.
3. The power supply voltage to the EUT was varied from 85% to 115% of the nominal value measured at the input to the EUT.
4. The variation in frequency was measured for the worst case.

## 4 Radiated Test Items

### 4.1 Measuring Instruments

See list of measuring instruments of this test report.

### 4.2 Test Setup

#### 4.2.1 For radiated test from 30MHz to 1GHz

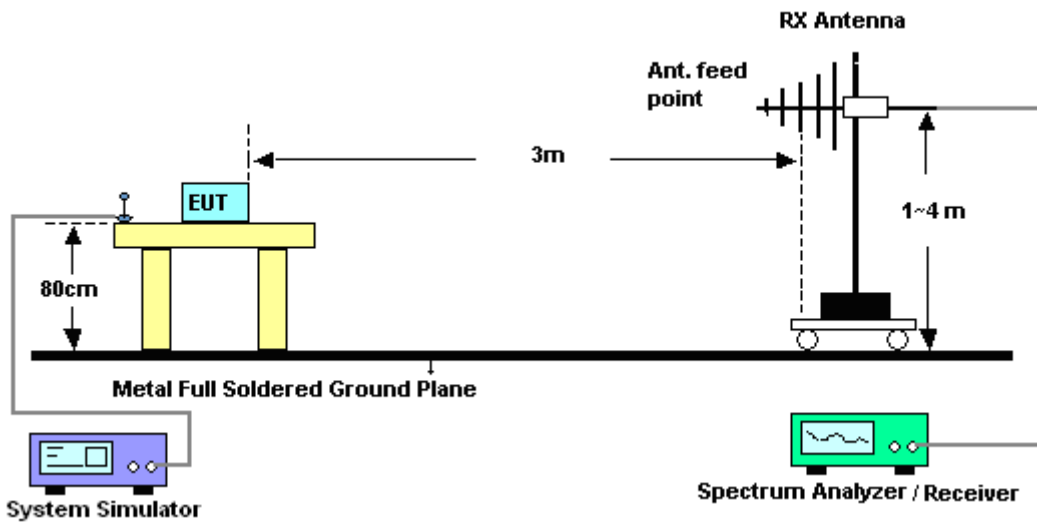

#### 4.2.2 For radiated test above 1GHz

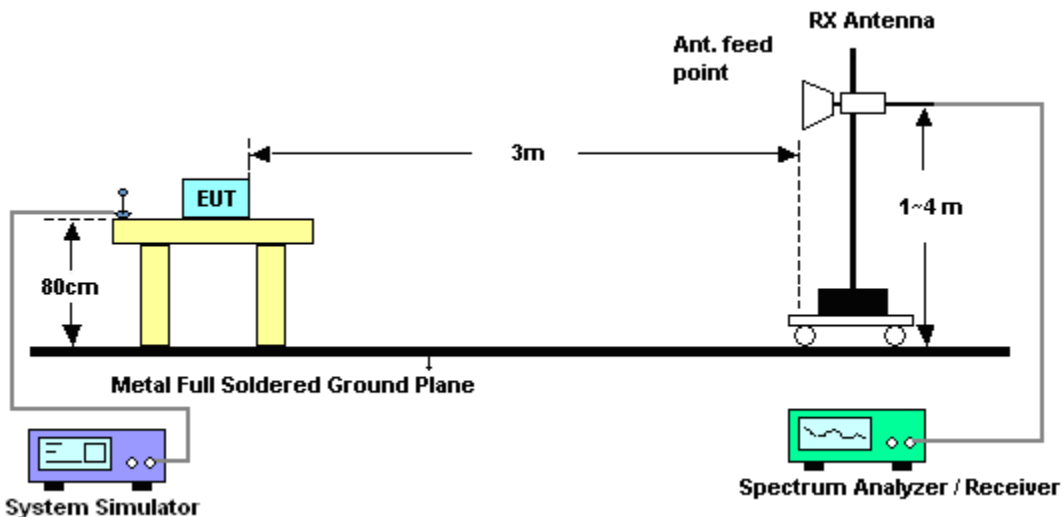

### 4.3 Test Result of Radiated Test

Please refer to Appendix B.



## 4.4 Radiated Spurious Emission

### 4.4.1 Description of Radiated Spurious Emission

The radiated spurious emission was measured by substitution method according to ANSI / TIA / EIA-603-C-2004. The power of any emission outside of the authorized operating frequency ranges must be attenuated below the transmitter power (P) by a factor of at least  $43 + 10 \log (P)$  dB.

For LTE Band 13

For operations in the 746-758 MHz, 775-788 MHz, and 805-806 MHz bands, emissions in the band 1559-1610 MHz shall be limited to  $-70$  dBW/MHz equivalent isotropically radiated power (EIRP) for wideband signals, and  $-80$  dBW EIRP for discrete emissions of less than 700 Hz bandwidth.

The spectrum is scanned from 30 MHz up to a frequency including its 10th harmonic.

### 4.4.2 Test Procedures

1. The testing follows FCC KDB 971168 v02r02 Section 5.8 and ANSI / TIA-603-C-2004 Section 2.2.12.
2. The EUT was placed on a rotatable wooden table with 0.8 meter above ground.
3. The EUT was set 3 meters from the receiving antenna, which was mounted on the antenna tower.
4. The table was rotated 360 degrees to determine the position of the highest spurious emission.
5. The height of the receiving antenna is varied between one meter and four meters to search the maximum spurious emission for both horizontal and vertical polarizations.
6. Make the measurement with the spectrum analyzer's RBW = 1MHz, VBW = 3MHz, taking the record of maximum spurious emission.
7. A horn antenna was substituted in place of the EUT and was driven by a signal generator.
8. Tune the output power of signal generator to the same emission level with EUT maximum spurious emission.
9. Taking the record of output power at antenna port.
10. Repeat step 7 to step 8 for another polarization.
11. The RF fundamental frequency should be excluded against the limit line in the operating frequency band.

The limit line is derived from  $43 + 10\log(P)$ dB below the transmitter power P(Watts)  
 $= P(W) - [43 + 10\log(P)]$  (dB)  
 $= [30 + 10\log(P)]$  (dBm) -  $[43 + 10\log(P)]$  (dB)  
 $= -13$ dBm.

12. EIRP (dBm) = S.G. Power – Tx Cable Loss + Tx Antenna Gain
13. ERP (dBm) = EIRP - 2.15



## 5 List of Measuring Equipment

Instrument	Manufacturer	Model No.	Serial No.	Characteristics	Calibration Date	Test Date	Due Date	Remark
LTE Base Station	Anritsu	MT8820C	6201026480	30MHz~2.7GHz SISO	Jan. 07, 2014	Nov. 05, 2014 ~ Nov. 10, 2014	Jan. 06, 2015	Conducted (TH02-HY)
Spectrum Analyzer	Rohde & Schwarz	FSP40	100055	9kHz~40GHz	Jun. 09, 2014	Nov. 05, 2014 ~ Nov. 10, 2014	Jun. 08, 2015	Conducted (TH02-HY)
Thermal Chamber	Ten Billion	TTH-D3SP	TBN-930701	N/A	Jul. 17, 2014	Nov. 05, 2014 ~ Nov. 10, 2014	Jul. 16, 2015	Conducted (TH02-HY)
Spectrum Analyzer	Rohde & Schwarz	FSV30	101749	10Hz ~ 30GHz	Feb. 10, 2014	Nov. 06, 2014 ~ Nov. 07, 2014	Feb. 09, 2015	Radiation (03CH07-HY)
Bilog Antenna	Schaffner	CBL6111C	2726	30MHz ~ 1GHz	Sep. 27, 2014	Nov. 06, 2014 ~ Nov. 07, 2014	Sep. 26, 2015	Radiation (03CH07-HY)
Double Ridge Horn Antenna	ESCO	3117	75962	1GHz~18GHz	Aug. 19, 2014	Nov. 06, 2014 ~ Nov. 07, 2014	Aug. 18, 2015	Radiation (03CH07-HY)
Preamplifier	COM-POWER	PA-103A	161241	10 MHz ~ 1000MHz	Mar. 17, 2014	Nov. 06, 2014 ~ Nov. 07, 2014	Mar. 16, 2015	Radiation (03CH07-HY)
Preamplifier	Agilent	8449B	3008A02362	1 GHz~26.5 GHz	Nov. 29, 2013	Nov. 06, 2014 ~ Nov. 07, 2014	Nov. 28, 2014	Radiation (03CH07-HY)
Turn Table	ChainTek	ChainTek 3000	N/A	0 ~ 360 degree	N/A	Nov. 06, 2014 ~ Nov. 07, 2014	N/A	Radiation (03CH07-HY)
Antenna Mast	ChainTek	M-400-0	114/8000604/L	N/A	N/A	Nov. 06, 2014 ~ Nov. 07, 2014	N/A	Radiation (03CH07-HY)
SHF-EHF Horn Antenna	SCHWARZBECK	BBHA 9170	BBHA9170251	18GHz~40GHz	Oct. 02, 2014	Nov. 06, 2014 ~ Nov. 07, 2014	Oct. 01, 2015	Radiation (03CH07-HY)



## 6 Uncertainty of Evaluation

### Uncertainty of Radiated Emission Measurement (30 MHz ~ 1000 MHz)

Measuring Uncertainty for a Level of Confidence of 95% ( $U = 2Uc(y)$ )	2.54
---	------

### Uncertainty of Radiated Emission Measurement (1 GHz ~ 40 GHz)

Measuring Uncertainty for a Level of Confidence of 95% ( $U = 2Uc(y)$ )	4.72
---	------



## Appendix A. Test Results of Conducted Test

### Conducted Output Power(Average power)

LTE Band 4 Maximum Average Power [dBm]						
BW [MHz]	RB Size	RB Offset	Mod	Lowest	Middle	Highest
1.4	1	0	QPSK	22.43	22.84	22.41
1.4	1	2		22.49	22.79	22.36
1.4	1	5		22.57	22.81	22.50
1.4	3	0		22.64	22.40	22.46
1.4	3	1		22.48	22.40	22.40
1.4	3	2		22.50	22.80	22.40
1.4	6	0		21.58	21.90	21.56
1.4	1	0	16-QAM	21.74	22.19	21.68
1.4	1	2		21.72	22.10	21.76
1.4	1	5		21.90	21.17	21.34
1.4	3	0		21.57	21.90	21.51
1.4	3	1		21.55	21.80	21.53
1.4	3	2		21.58	21.77	21.55
1.4	6	0		21.72	21.91	21.60
3	1	0	QPSK	22.56	22.85	22.47
3	1	7		22.71	22.93	22.65
3	1	14		22.72	22.76	22.47
3	8	0		21.57	21.84	21.51
3	8	4		21.73	21.94	21.70
3	8	7		21.81	21.82	21.71
3	15	0		21.62	21.86	21.60
3	1	0	16-QAM	21.83	22.17	21.70
3	1	7		21.91	22.22	21.88
3	1	14		21.95	22.13	21.70
3	8	0		21.60	21.87	21.54
3	8	4		21.74	21.98	21.71
3	8	7		21.82	21.86	21.71
3	15	0		21.60	21.87	21.58





LTE Band 4 Maximum Average Power [dBm]						
BW [MHz]	RB Size	RB Offset	Mod	Lowest	Middle	Highest
5	1	0	QPSK	22.32	22.61	22.39
5	1	12		22.60	22.77	22.48
5	1	24		22.46	22.60	22.31
5	12	0		21.56	21.72	21.35
5	12	6		21.84	21.85	21.52
5	12	11		21.73	21.72	21.38
5	25	0		21.77	21.87	21.44
5	1	0	16-QAM	21.67	21.96	21.55
5	1	12		22.00	22.11	21.75
5	1	24		21.78	22.00	21.65
5	12	0		21.54	21.72	21.36
5	12	6		21.85	21.85	21.51
5	12	11		21.74	21.72	21.36
5	25	0		21.73	21.87	21.42
10	1	0	QPSK	22.54	22.79	22.67
10	1	24		22.52	22.73	22.41
10	1	49		22.74	22.72	22.42
10	25	0		21.75	21.96	21.55
10	25	12		21.66	21.73	21.36
10	25	24		21.80	21.79	21.53
10	50	0		21.77	21.84	21.50
10	1	0	16-QAM	21.77	22.14	21.97
10	1	24		21.90	22.11	21.64
10	1	49		22.00	22.02	21.70
10	25	0		21.72	21.95	21.57
10	25	12		21.64	21.82	21.37
10	25	24		21.76	21.80	21.51
10	50	0		21.73	21.85	21.49



LTE Band 4 Maximum Average Power [dBm]						
BW [MHz]	RB Size	RB Offset	Mod	Lowest	Middle	Highest
15	1	0	QPSK	22.45	22.82	22.63
15	1	37		22.78	22.67	22.41
15	1	74		22.89	22.54	22.35
15	36	0		21.64	21.80	21.51
15	36	18		21.75	21.82	21.47
15	36	37		21.79	21.67	21.47
15	75	0		21.74	21.68	21.38
15	1	0	16-QAM	21.74	22.16	21.92
15	1	37		22.04	21.97	21.73
15	1	74		22.06	21.83	21.60
15	36	0		21.62	21.88	21.52
15	36	18		21.71	21.82	21.46
15	36	37		21.75	21.68	21.43
15	75	0		21.69	21.67	21.36
20	1	0	QPSK	22.45	22.76	22.57
20	1	49		22.71	22.71	22.58
20	1	99		22.50	22.43	22.08
20	50	0		21.82	21.85	21.67
20	50	24		21.88	21.64	21.54
20	50	49		21.83	21.69	21.36
20	100	0		21.83	21.66	21.51
20	1	0	16-QAM	21.59	21.92	21.85
20	1	49		22.06	21.94	21.86
20	1	99		21.80	21.70	21.34
20	50	0		21.68	21.82	21.69
20	50	24		21.85	21.64	21.55
20	50	49		21.81	21.70	21.35
20	100	0		21.79	21.69	21.50



LTE Band 13 Maximum Average Power [dBm]						
BW [MHz]	RB Size	RB Offset	Mod	Lowest	Middle	Highest
5	1	0	QPSK	23.14	22.95	22.61
5	1	12		23.12	22.58	22.86
5	1	24		22.68	22.67	22.74
5	12	0		22.05	21.81	21.54
5	12	6		22.06	21.60	21.78
5	12	11		21.81	21.63	21.67
5	25	0		22.19	21.59	21.77
5	1	0	16-QAM	22.36	21.97	21.76
5	1	12		22.18	21.92	22.07
5	1	24		21.66	21.76	21.80
5	12	0		20.85	20.88	20.61
5	12	6		20.88	20.67	20.85
5	12	11		20.88	20.70	20.73
5	25	0		21.01	20.66	20.74
10	1	0	QPSK		23.14	
10	1	24			22.49	
10	1	49			22.81	
10	25	0			21.99	
10	25	12			21.76	
10	25	24			21.75	
10	50	0			21.74	
10	1	0	16-QAM		22.59	
10	1	24			21.81	
10	1	49			21.86	
10	25	0			20.79	
10	25	12			20.72	
10	25	24			20.80	
10	50	0			20.76	



**ERP/EIRP**

PCS Band ( $G_T - L_C = 2.63$ dB)						
Modes	LTE Band 4 (QPSK, BW=1.4M)			LTE Band 4 (16QAM, BW=1.4M)		
Channel	19957 (Low)	20175 (Mid)	20393 (High)	19957 (Low)	20175 (Mid)	20393 (High)
Frequency (MHz)	1710.7	1732.5	1754.3	1710.7	1732.5	1754.3
Conducted Power $P_T$ (dBm)	22.64	22.84	22.50	21.90	22.19	21.76
Conducted Power $P_T$ (Watts)	0.18	0.19	0.18	0.15	0.17	0.15
EIRP (dBm)	25.27	25.47	25.13	24.53	24.82	24.39
EIRP (Watts)	0.3365	0.3524	0.3258	0.2838	0.3034	0.2748

PCS Band ( $G_T - L_C = 2.63$ dB)						
Modes	LTE Band 4 (QPSK, BW=3M)			LTE Band 4 (16QAM, BW=3M)		
Channel	19965(Low)	20175 (Mid)	20385 (High)	19965(Low)	20175 (Mid)	20385 (High)
Frequency (MHz)	1711.5	1732.5	1753.5	1711.5	1732.5	1753.5
Conducted Power $P_T$ (dBm)	22.72	22.93	22.65	21.95	22.22	21.88
Conducted Power $P_T$ (Watts)	0.19	0.20	0.18	0.16	0.17	0.15
EIRP (dBm)	25.35	25.56	25.28	24.58	24.85	24.51
EIRP (Watts)	0.3428	0.3597	0.3373	0.2871	0.3055	0.2825



PCS Band ( $G_T - L_C = 2.63$ dB)						
Modes	LTE Band 4 (QPSK, BW=5M)			LTE Band 4 (16QAM, BW=5M)		
Channel	19975(Low)	20175 (Mid)	20375 (High)	19975(Low)	20175 (Mid)	20375 (High)
Frequency (MHz)	1712.5	1732.5	1752.5	1712.5	1732.5	1752.5
Conducted Power $P_T$ (dBm)	22.60	22.77	22.48	22.00	22.11	21.75
Conducted Power $P_T$ (Watts)	0.18	0.19	0.18	0.16	0.16	0.15
EIRP(dBm)	25.23	25.40	25.11	24.63	24.74	24.38
EIRP(Watts)	0.3334	0.3467	0.3243	0.2904	0.2979	0.2742

PCS Band ( $G_T - L_C = 2.63$ dB)						
Modes	LTE Band 4 (QPSK, BW=10M)			LTE Band 4 (16QAM, BW=10M)		
Channel	20000 (Low)	20175 (Mid)	20350 (High)	20000 (Low)	20175 (Mid)	20350 (High)
Frequency (MHz)	1715	1732.5	1750	1715	1732.5	1750
Conducted Power $P_T$ (dBm)	22.74	22.79	22.67	22.00	22.14	21.97
Conducted Power $P_T$ (Watts)	0.19	0.19	0.18	0.16	0.16	0.16
EIRP(dBm)	25.37	25.42	25.30	24.63	24.77	24.60
EIRP(Watts)	0.3443	0.3483	0.3388	0.2904	0.2999	0.2884



PCS Band ( $G_T - L_C = 2.63$ dB)						
Modes	LTE Band 4 (QPSK, BW=15M)			LTE Band 4 (16QAM, BW=15M)		
Channel	20025 (Low)	20175 (Mid)	20325 (High)	20025 (Low)	20175 (Mid)	20325 (High)
Frequency (MHz)	1717.5	1732.5	1747.5	1717.5	1732.5	1747.5
Conducted Power $P_T$ (dBm)	22.89	22.82	22.63	22.06	22.16	21.92
Conducted Power $P_T$ (Watts)	0.19	0.19	0.18	0.16	0.16	0.16
EIRP(dBm)	25.52	25.45	25.26	24.69	24.79	24.55
EIRP(Watts)	0.3565	0.3508	0.3357	0.2944	0.3013	0.2851

PCS Band ( $G_T - L_C = 2.63$ dB)						
Modes	LTE Band 4 (QPSK, BW=20M)			LTE Band 4 (16QAM, BW=20M)		
Channel	20050 (Low)	20175 (Mid)	20300 (High)	20050 (Low)	20175 (Mid)	20300 (High)
Frequency (MHz)	1720	1732.5	1745	1720	1732.5	1745
Conducted Power $P_T$ (dBm)	22.71	22.76	22.58	22.06	21.94	21.86
Conducted Power $P_T$ (Watts)	0.19	0.19	0.18	0.16	0.16	0.15
EIRP(dBm)	25.34	25.39	25.21	24.69	24.57	24.49
EIRP(Watts)	0.3420	0.3459	0.3319	0.2944	0.2864	0.2812



Cellular Band ( $G_T - L_C = 6.33$ dB)						
Modes	LTE Band 13 (QPSK, BW=5M)			LTE Band 13 (16QAM, BW=5M)		
Channel	23205 (Low)	23230 (Mid)	23255 (High)	23205 (Low)	23230 (Mid)	23255 (High)
Frequency (MHz)	779.5	782	784.5	779.5	782	784.5
Conducted Power $P_T$ (dBm)	23.14	22.95	22.86	22.36	21.97	22.07
Conducted Power $P_T$ (Watts)	0.21	0.20	0.19	0.17	0.16	0.16
ERP(dBm)	27.32	27.13	27.04	26.54	26.15	26.25
ERP(Watts)	0.5395	0.5164	0.5058	0.4508	0.4121	0.4217

Cellular Band ( $G_T - L_C = 6.33$ dB)		
Modes	LTE Band 13 (QPSK, BW=10M)	LTE Band 13 (16QAM, BW=10M)
Channel	23230 (Mid)	23230 (Mid)
Frequency (MHz)	782	782
Conducted Power $P_T$ (dBm)	23.14	22.59
Conducted Power $P_T$ (Watts)	0.21	0.18
ERP(dBm)	27.32	26.77
ERP(Watts)	0.5395	0.4753



### Peak-to-Average Ratio

Mode	LTE Band 4 / 20MHz				
Mod.	QPSK		16QAM		Limit: 13dB
RB Size	1RB	Full RB	1RB	RB Size	Result
Lowest CH	4.62	5.13	5.64	5.51	PASS
Middle CH	4.23	5.83	5.03	6.22	
Highest CH	5.35	5.45	6.25	5.93	

Mode	LTE Band 13 / 10MHz				
Mod.	QPSK		16QAM		Limit: 13dB
RB Size	1RB	Full RB	1RB	RB Size	Result
Lowest CH	-	-	-	-	PASS
Middle CH	4.58	5.74	5.51	6.31	
Highest CH	-	-	-	-	





LTE Band 4 / 20MHz / QPSK

Lowest Channel / 1RB

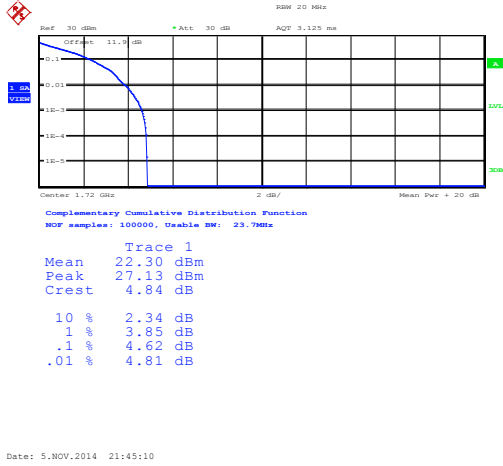

Lowest Channel / Full RB

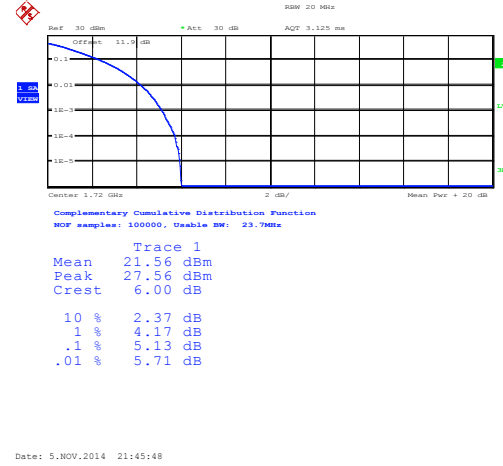

Middle Channel / 1RB

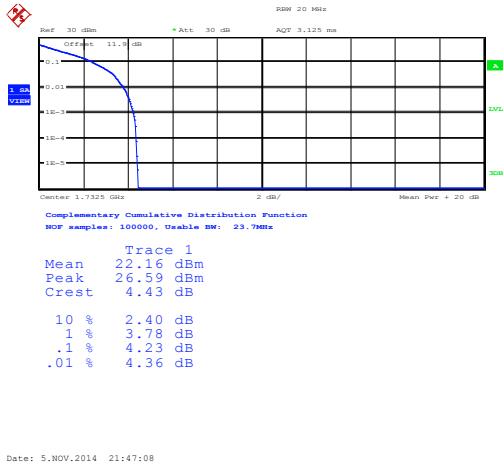

Middle Channel / Full RB

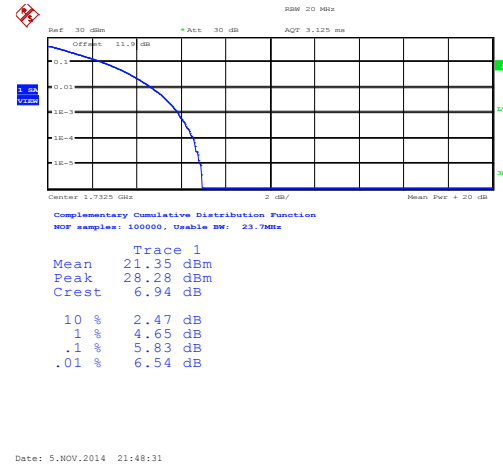

Highest Channel / 1RB

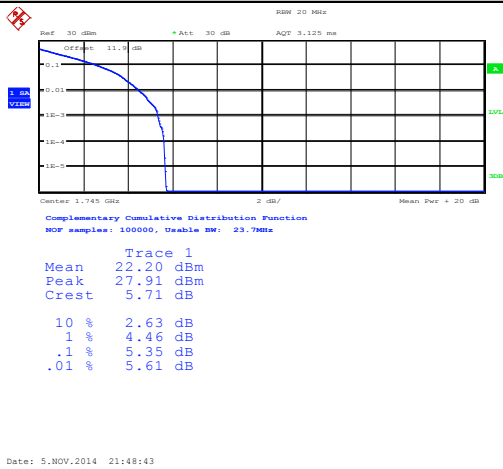

Highest Channel / Full RB

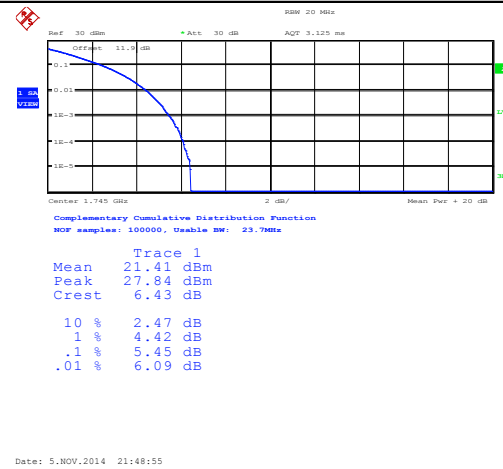



LTE Band 4 / 20MHz / 16QAM

Lowest Channel / 1RB

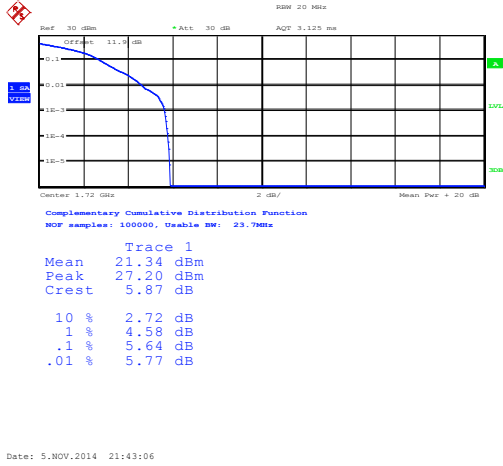

Lowest Channel / Full RB

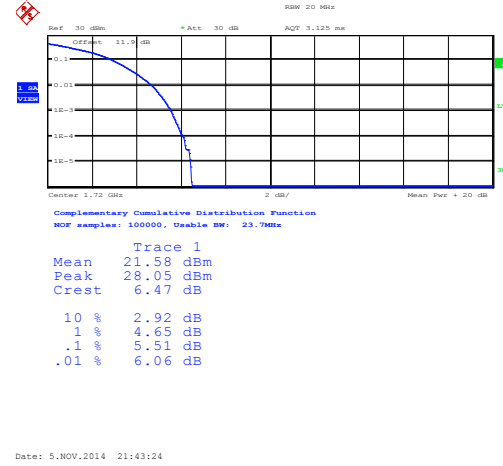

Middle Channel / 1RB

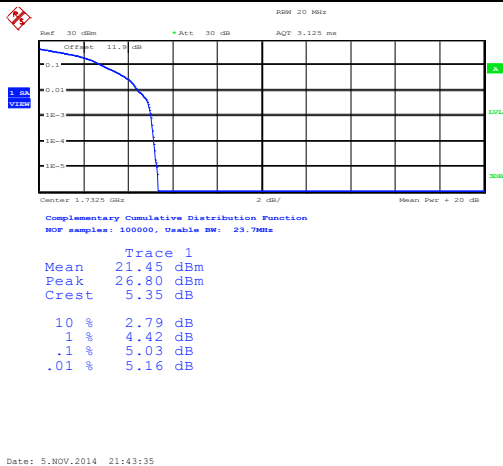

Middle Channel / Full RB

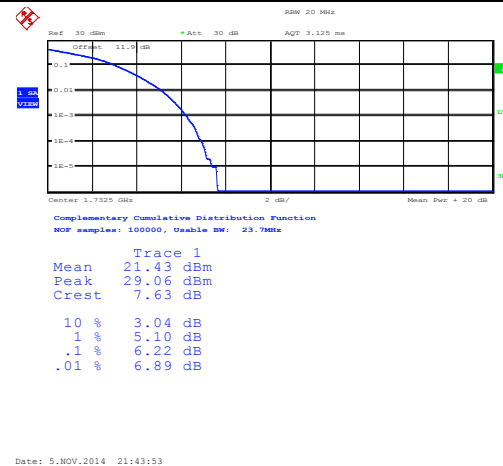

Highest Channel / 1RB

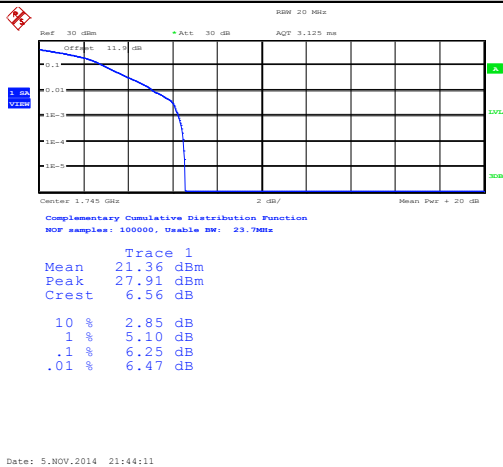

Highest Channel / Full RB

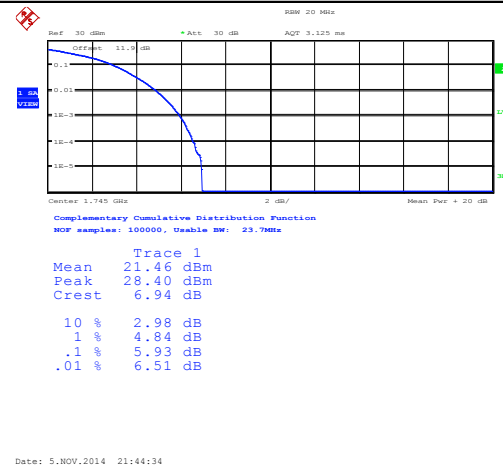



LTE Band 13 / 10MHz / QPSK

Middle Channel/ 1RB

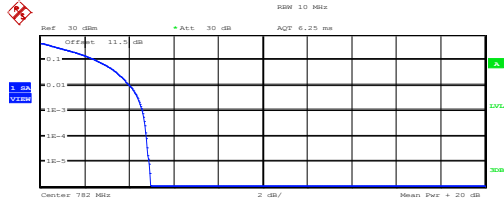

Complementary Cumulative Distribution Function  
NOF samples: 100000, Usable BW: 11.2MHz

Trace 1  
Mean 23.35 dBm  
Peak 28.30 dBm  
Crest 4.95 dB

10 % 2.47 dB  
1 % 4.01 dB  
.1 % 4.58 dB  
.01 % 4.78 dB

Date: 5.NOV.2014 23:03:19

Middle Channel / Full RB

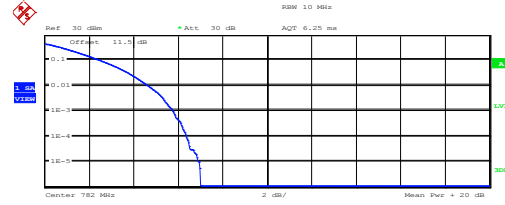

Complementary Cumulative Distribution Function  
NOF samples: 100000, Usable BW: 11.2MHz

Trace 1  
Mean 21.92 dBm  
Peak 28.94 dBm  
Crest 7.01 dB

10 % 2.47 dB  
1 % 4.62 dB  
.1 % 5.74 dB  
.01 % 6.35 dB

Date: 5.NOV.2014 23:03:30

LTE Band 13 / 10MHz / 16QAM

Middle Channel/ 1RB

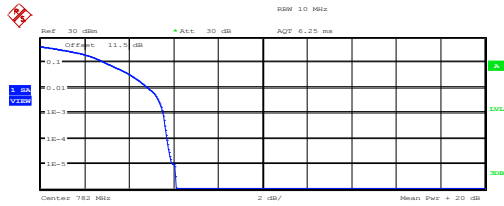

Complementary Cumulative Distribution Function  
NOF samples: 100000, Usable BW: 11.2MHz

Trace 1  
Mean 22.48 dBm  
Peak 28.58 dBm  
Crest 6.10 dB

10 % 2.92 dB  
1 % 4.81 dB  
.1 % 5.51 dB  
.01 % 5.71 dB

Date: 5.NOV.2014 23:02:56

Middle Channel / Full RB

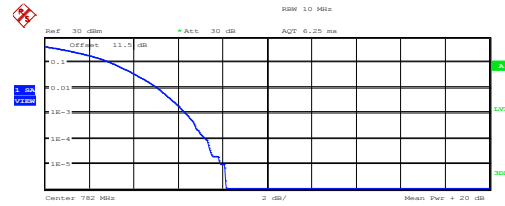

Complementary Cumulative Distribution Function  
NOF samples: 100000, Usable BW: 11.2MHz

Trace 1  
Mean 20.72 dBm  
Peak 28.87 dBm  
Crest 8.14 dB

10 % 2.98 dB  
1 % 5.03 dB  
.1 % 6.31 dB  
.01 % 7.21 dB

Date: 5.NOV.2014 23:03:07



**26dB Bandwidth**

Mode	LTE Band 4 : 26dB BW(MHz)											
	1.4MHz		3MHz		5MHz		10MHz		15MHz		20MHz	
Mod.	QPSK	16QAM	QPSK	16QAM	QPSK	16QAM	QPSK	16QAM	QPSK	16QAM	QPSK	16QAM
Lowest CH	1.26	1.29	3.06	3.02	5.02	4.94	10.18	10.2	14.85	14.85	21.4	21.28
Middle CH	1.26	1.27	3.06	3.07	5	5.03	10.2	10.24	14.97	15	21.64	21.68
Highest CH	1.28	1.29	3.08	3.05	5.03	5.03	10.14	10.24	14.82	14.82	21.4	21.2

Mode	LTE Band 13 : 26dB BW(MHz)											
	1.4MHz		3MHz		5MHz		10MHz		15MHz		20MHz	
Mod.	QPSK	16QAM	QPSK	16QAM	QPSK	16QAM	QPSK	16QAM	QPSK	16QAM	QPSK	16QAM
Lowest CH	-	-	-	-	5.01	4.99	-	-	-	-	-	-
Middle CH	-	-	-	-	5.02	4.99	10.12	10.14	-	-	-	-
Highest CH	-	-	-	-	5.01	4.97	-	-	-	-	-	-



LTE Band 4

Lowest Channel / 1.4MHz / QPSK

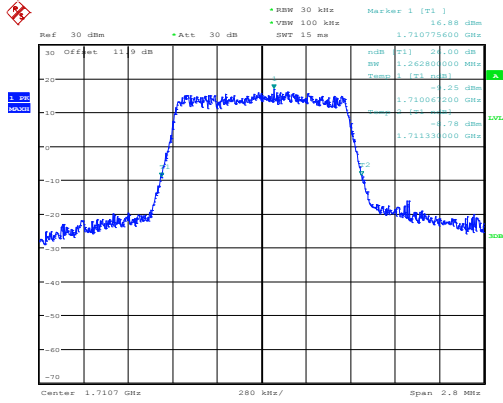

Lowest Channel / 1.4MHz / 16QAM

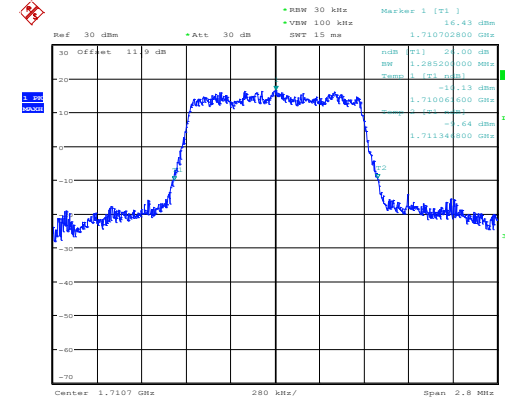

Middle Channel / 1.4MHz / QPSK

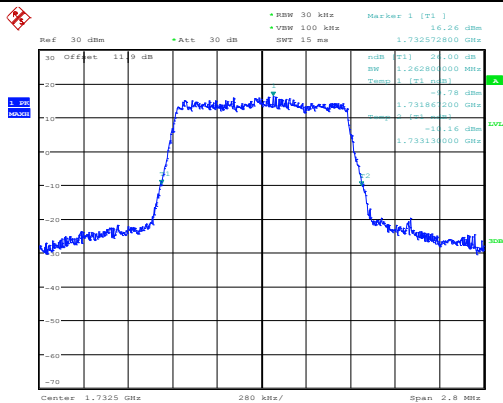

Middle Channel / 1.4MHz / 16QAM

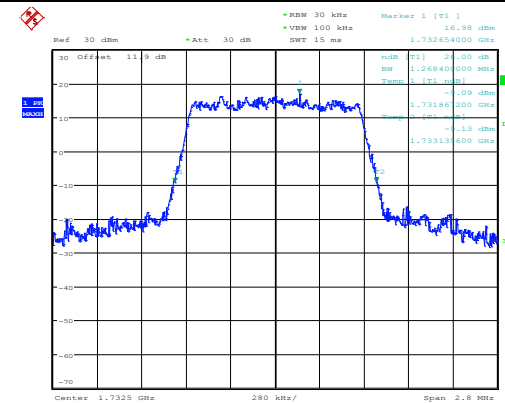

Highest Channel / 1.4MHz / QPSK

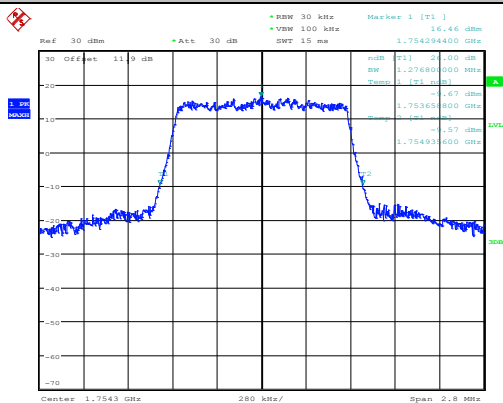

Highest Channel / 1.4MHz / 16QAM

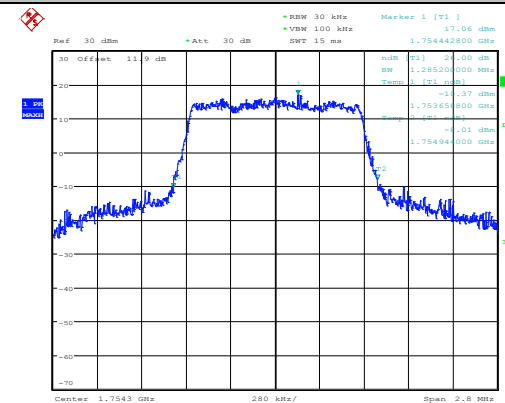



LTE Band 4

Lowest Channel / 3MHz / QPSK

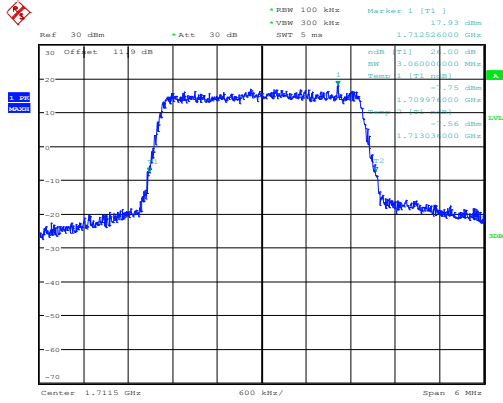

Date: 5.NOV.2014 20:04:39

Lowest Channel / 3MHz / 16QAM

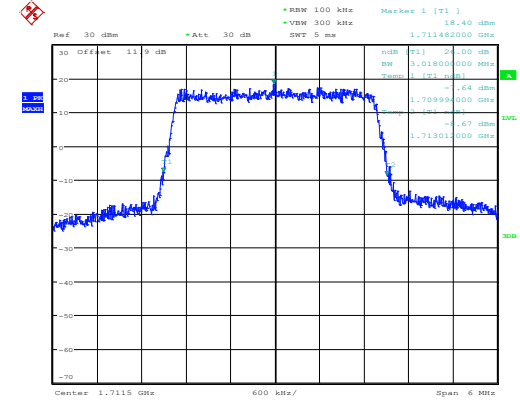

Date: 5.NOV.2014 20:04:52

Middle Channel / 3MHz / QPSK

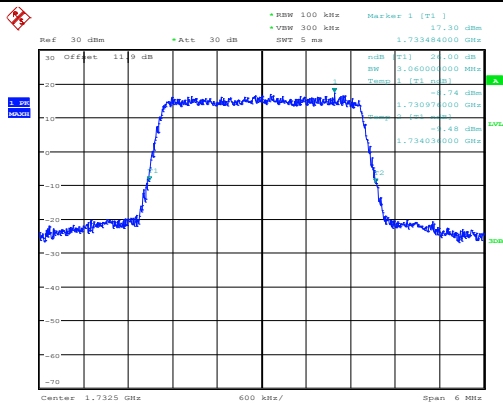

Date: 5.NOV.2014 20:12:29

Middle Channel / 3MHz / 16QAM

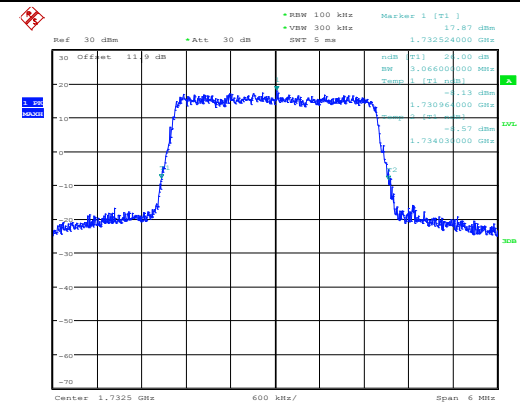

Date: 5.NOV.2014 20:12:42

Highest Channel / 3MHz / QPSK

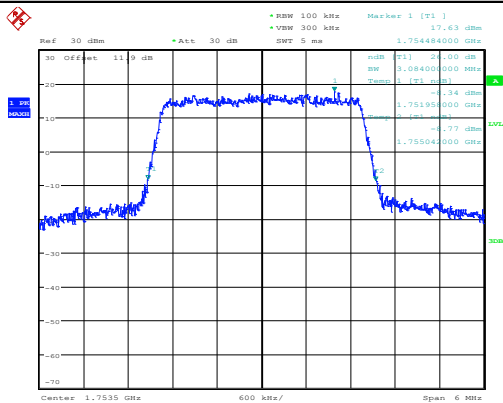

Date: 5.NOV.2014 20:15:38

Highest Channel / 3MHz / 16QAM

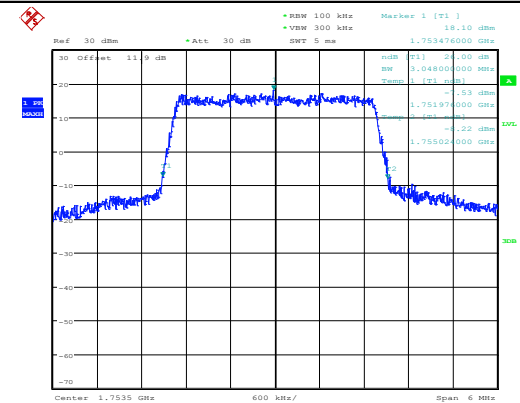

Date: 5.NOV.2014 20:15:50



LTE Band 4

Lowest Channel / 5MHz / QPSK

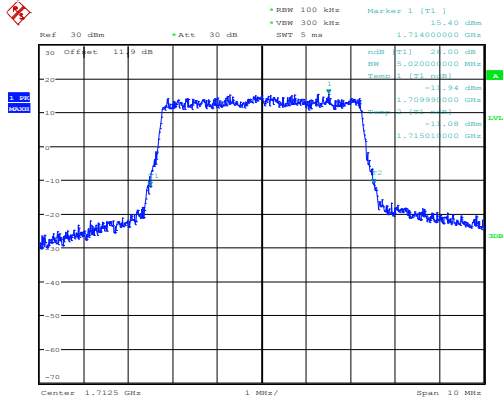

Date: 5.NOV.2014 20:23:28

Lowest Channel / 5MHz / 16QAM

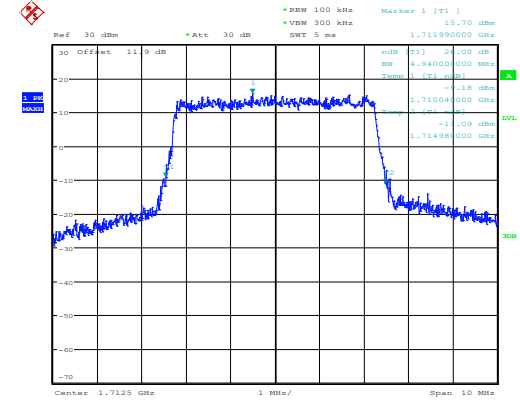

Date: 5.NOV.2014 20:23:40

Middle Channel / 5MHz / QPSK

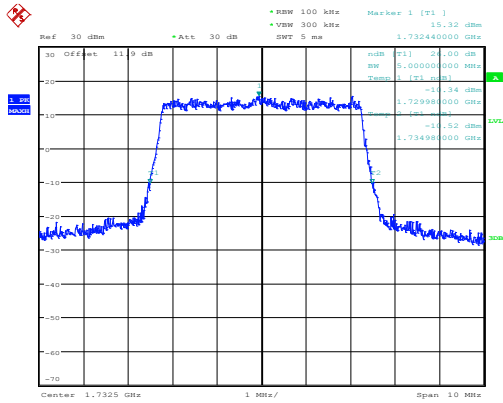

Date: 5.NOV.2014 20:31:17

Middle Channel / 5MHz / 16QAM

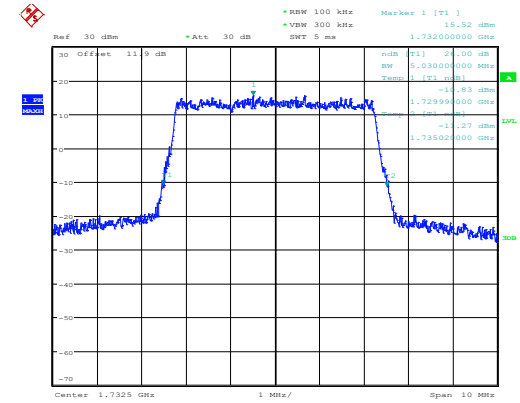

Date: 5.NOV.2014 20:31:30

Highest Channel / 5MHz / QPSK

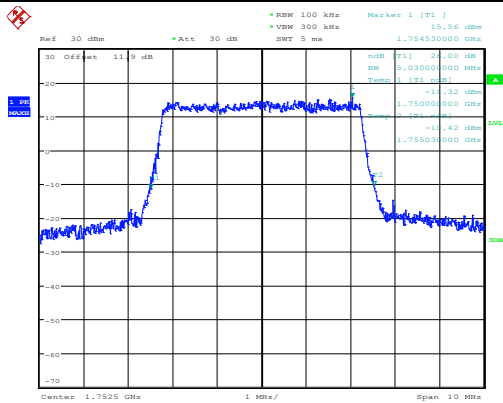

Date: 5.NOV.2014 20:34:25

Highest Channel / 5MHz / 16QAM

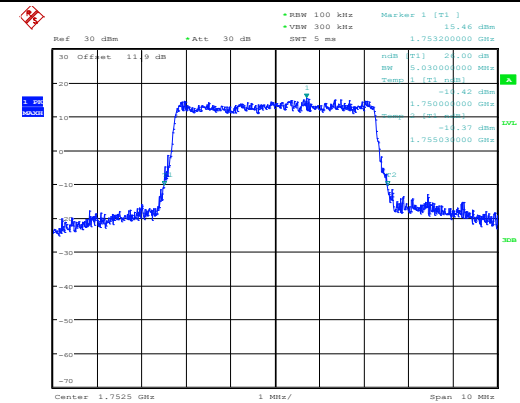

Date: 5.NOV.2014 20:34:38



LTE Band 4

Lowest Channel / 10MHz / QPSK

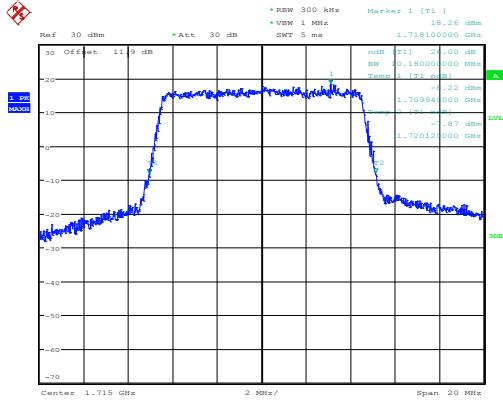

Date: 5.NOV.2014 20:42:15

Lowest Channel / 10MHz / 16QAM

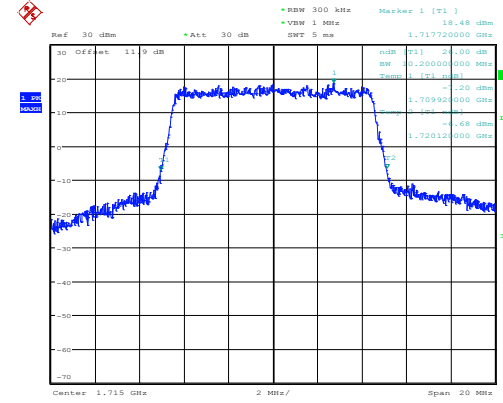

Date: 5.NOV.2014 20:42:28

Middle Channel / 10MHz / QPSK

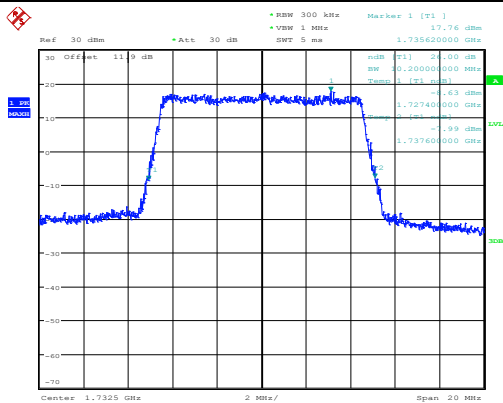

Date: 5.NOV.2014 20:50:10

Middle Channel / 10MHz / 16QAM

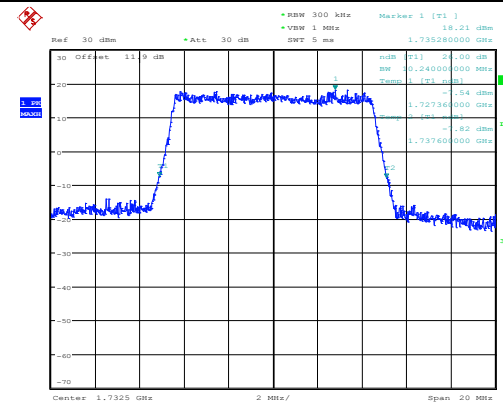

Date: 5.NOV.2014 20:50:23

Highest Channel / 10MHz / QPSK

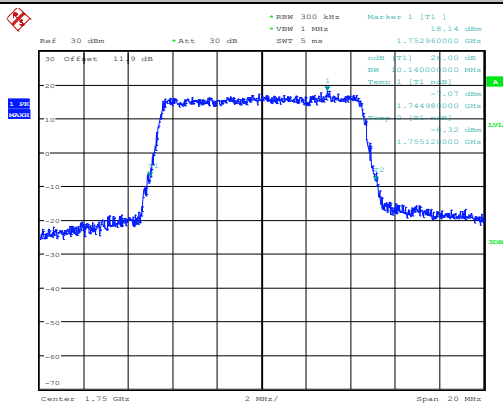

Date: 5.NOV.2014 20:53:20

Highest Channel / 10MHz / 16QAM

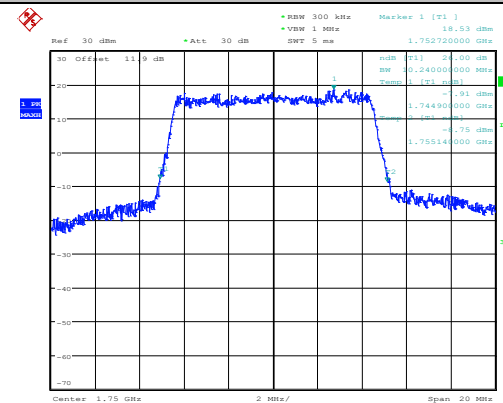

Date: 5.NOV.2014 20:53:33





LTE Band 4

Lowest Channel / 15MHz / QPSK

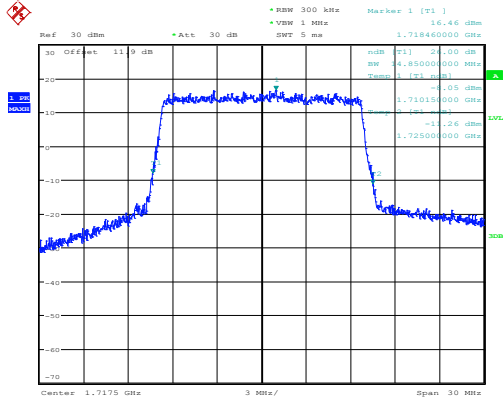

Date: 5.NOV.2014 21:01:11

Lowest Channel / 15MHz / 16QAM

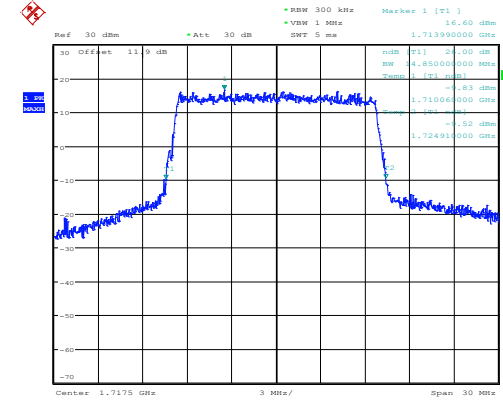

Date: 5.NOV.2014 21:01:24

Middle Channel / 15MHz / QPSK

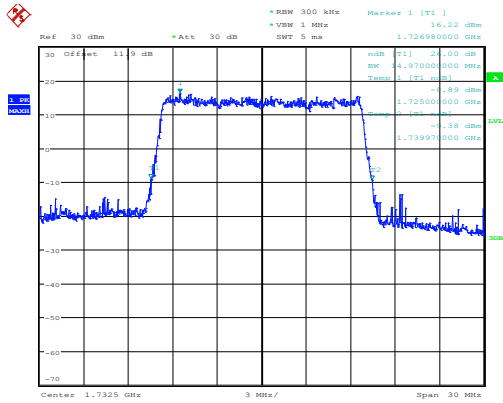

Date: 5.NOV.2014 21:09:01

Middle Channel / 15MHz / 16QAM

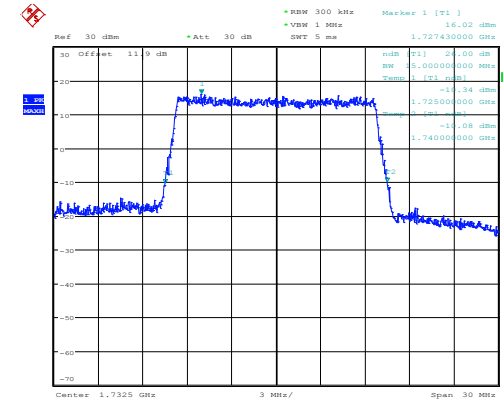

Date: 5.NOV.2014 21:09:14

Highest Channel / 15MHz / QPSK

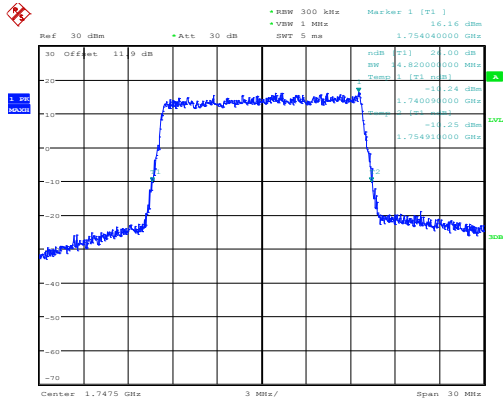

Date: 5.NOV.2014 21:12:09

Highest Channel / 15MHz / 16QAM

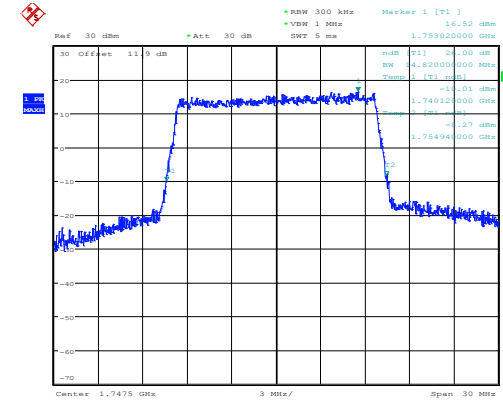

Date: 5.NOV.2014 21:12:22



LTE Band 4

Lowest Channel / 20MHz / QPSK

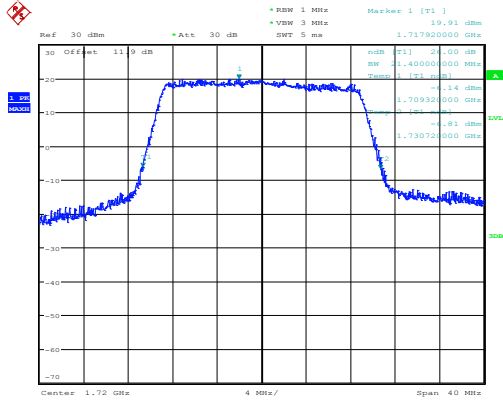

Date: 5.NOV.2014 21:19:59

Lowest Channel / 20MHz / 16QAM

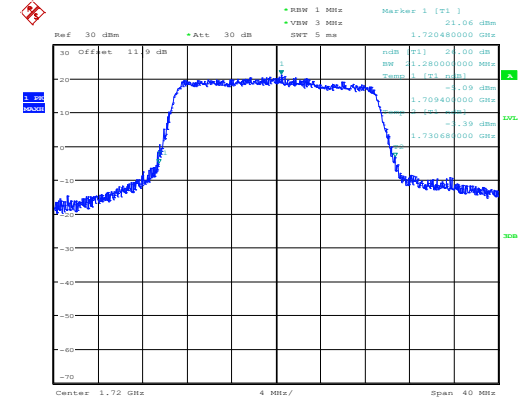

Date: 5.NOV.2014 21:20:12

Middle Channel / 20MHz / QPSK

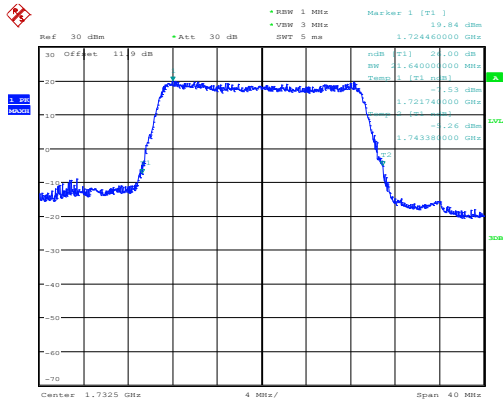

Date: 5.NOV.2014 21:27:50

Middle Channel / 20MHz / 16QAM

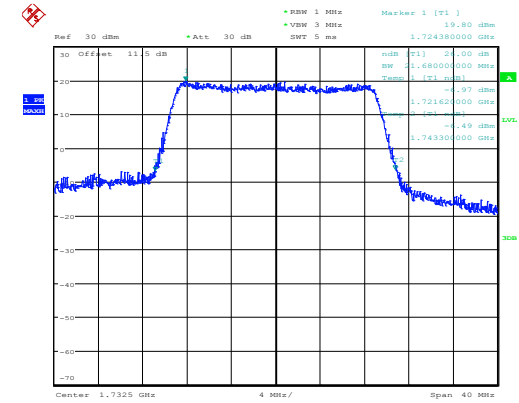

Date: 10.NOV.2014 19:06:21

Highest Channel / 20MHz / QPSK

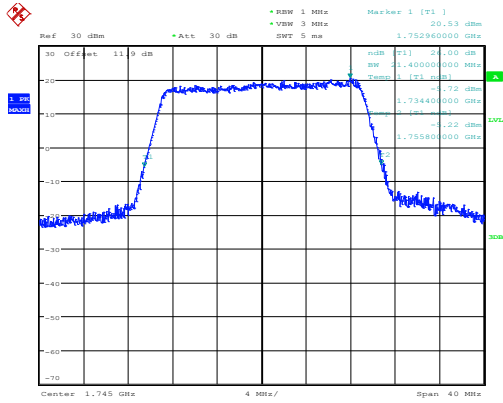

Date: 5.NOV.2014 21:30:57

Highest Channel / 20MHz / 16QAM

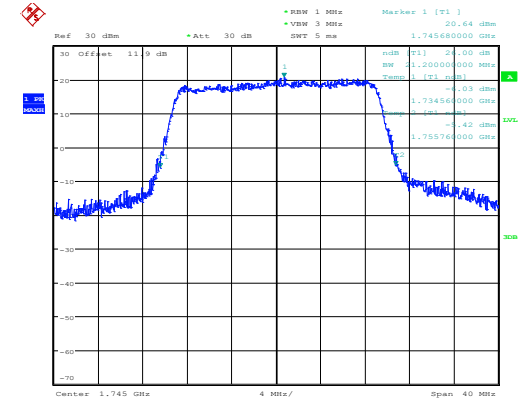

Date: 5.NOV.2014 21:31:10





LTE Band 13

Middle Channel / 10MHz / QPSK

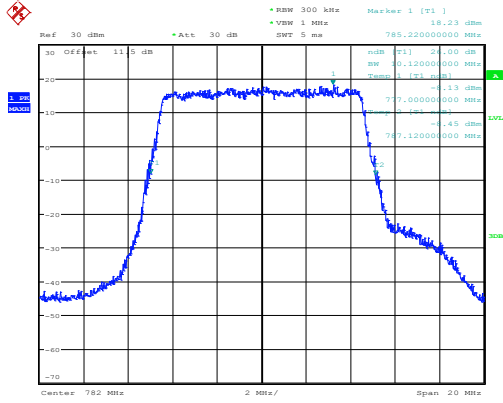

Date: 5.NOV.2014 23:00:22

Middle Channel / 10MHz / 16QAM

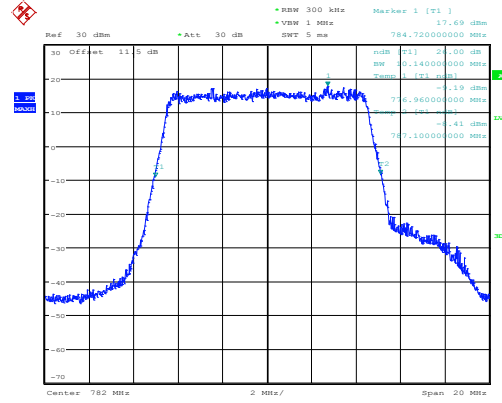

Date: 5.NOV.2014 23:00:09



### Occupied Bandwidth

Mode	LTE Band 4 : 99%OBW(MHz)											
	1.4MHz		3MHz		5MHz		10MHz		15MHz		20MHz	
Mod.	QPSK	16QAM	QPSK	16QAM	QPSK	16QAM	QPSK	16QAM	QPSK	16QAM	QPSK	16QAM
Lowest CH	1.1	1.1	2.74	2.72	4.48	4.5	9.08	9.04	13.47	13.5	18.52	18.6
Middle CH	1.1	1.1	2.74	2.72	4.5	4.5	9.1	9.06	13.5	13.56	18.76	18.76
Highest CH	1.1	1.1	2.74	2.74	4.5	4.51	9.08	9.1	13.5	13.5	18.64	18.6

Mode	LTE Band 13 : 99%OBW(MHz)											
	1.4MHz		3MHz		5MHz		10MHz		15MHz		20MHz	
Mod.	QPSK	16QAM	QPSK	16QAM	QPSK	16QAM	QPSK	16QAM	QPSK	16QAM	QPSK	16QAM
Lowest CH	-	-	-	-	4.48	4.49	-	-	-	-	-	-
Middle CH	-	-	-	-	4.5	4.49	9.04	9.04	-	-	-	-
Highest CH	-	-	-	-	4.5	4.49	-	-	-	-	-	-



LTE Band 4

Lowest Channel / 1.4MHz / QPSK

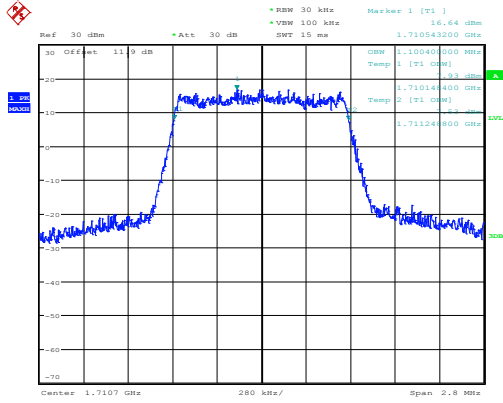

Date: 5.NOV.2014 19:32:52

Lowest Channel / 1.4MHz / 16QAM

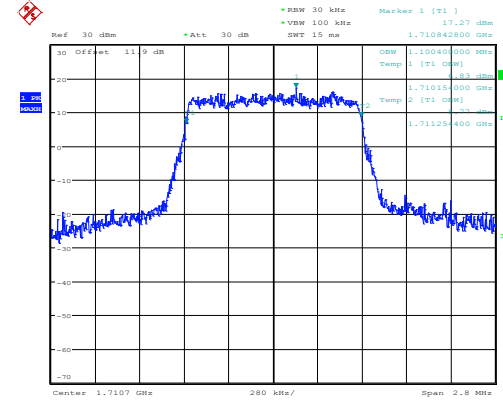

Date: 5.NOV.2014 19:33:03

Middle Channel / 1.4MHz / QPSK

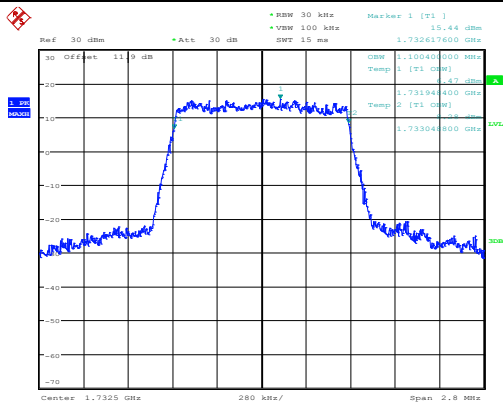

Date: 5.NOV.2014 19:49:43

Middle Channel / 1.4MHz / 16QAM

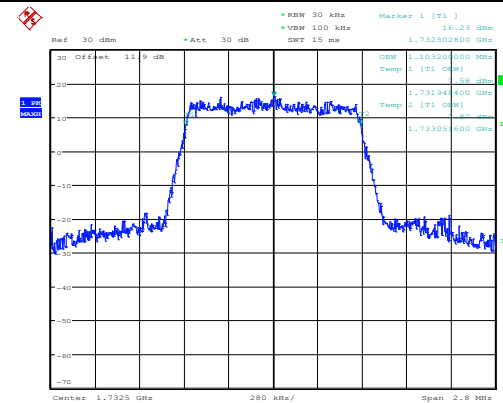

Date: 5.NOV.2014 19:49:54

Highest Channel / 1.4MHz / QPSK

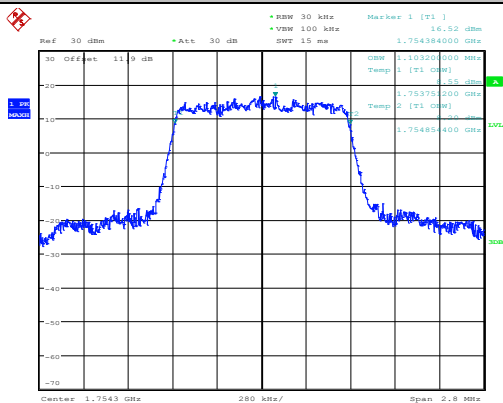

Date: 5.NOV.2014 19:54:09

Highest Channel / 1.4MHz / 16QAM

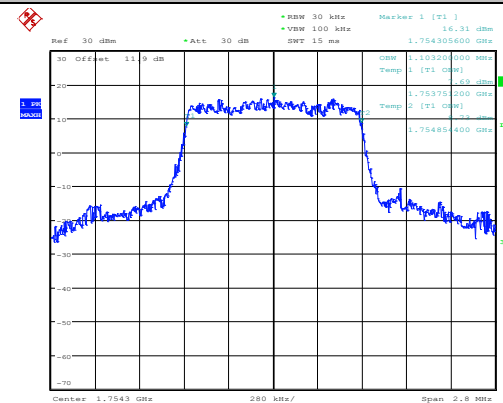

Date: 5.NOV.2014 19:54:19



LTE Band 4

Lowest Channel / 3MHz / QPSK

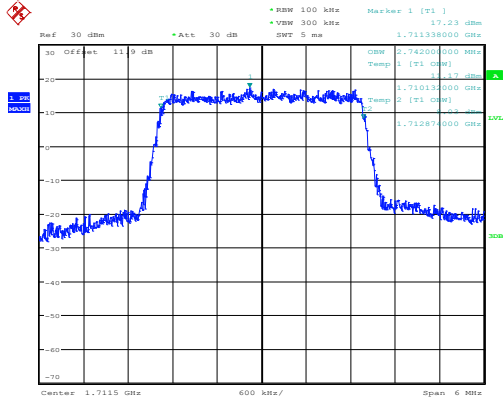

Date: 5.NOV.2014 20:04:15

Lowest Channel / 3MHz / 16QAM

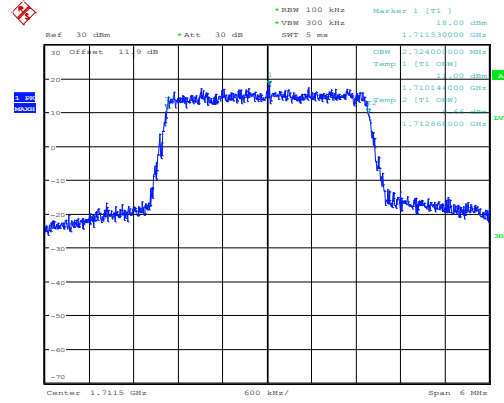

Date: 5.NOV.2014 20:04:26

Middle Channel / 3MHz / QPSK

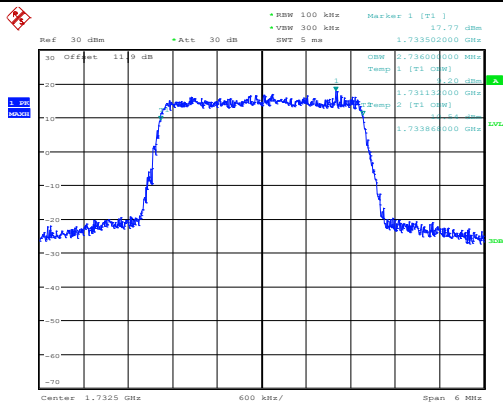

Date: 5.NOV.2014 20:12:05

Middle Channel / 3MHz / 16QAM

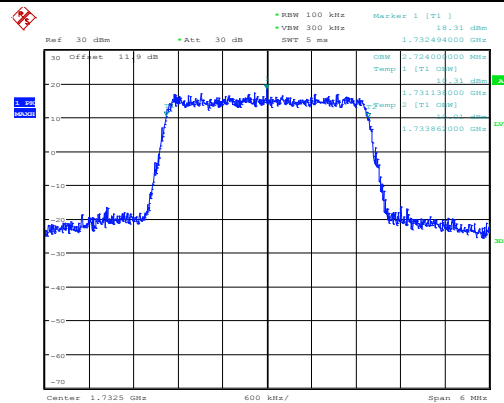

Date: 5.NOV.2014 20:12:16

Highest Channel / 3MHz / QPSK

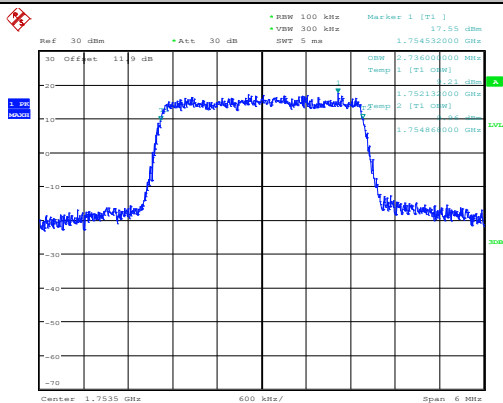

Date: 5.NOV.2014 20:15:14

Highest Channel / 3MHz / 16QAM

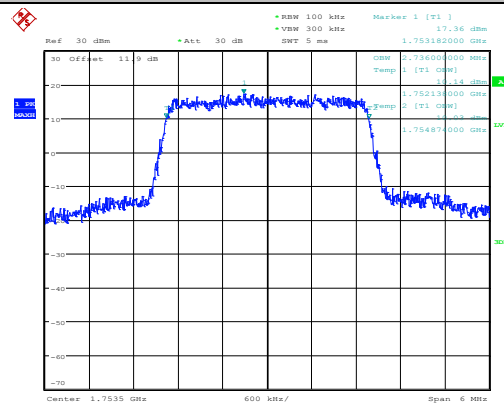

Date: 5.NOV.2014 20:15:25



LTE Band 4

Lowest Channel / 5MHz / QPSK

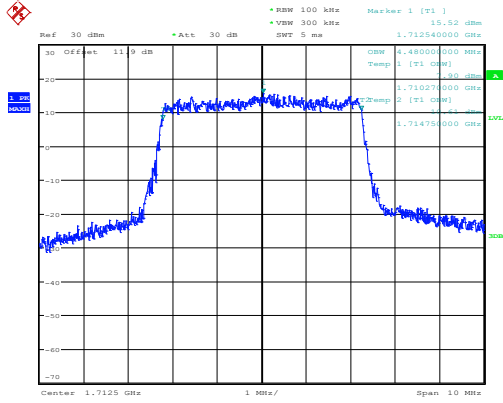

Date: 5.NOV.2014 20:23:04

Lowest Channel / 5MHz / 16QAM

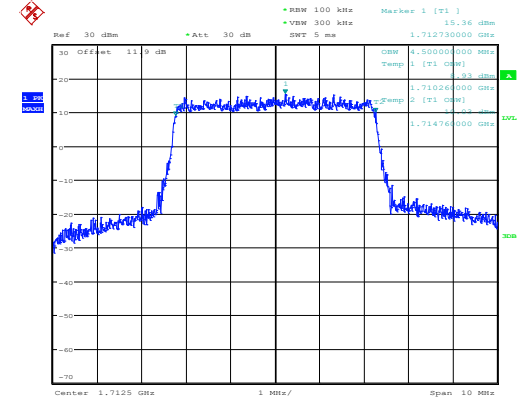

Date: 5.NOV.2014 20:23:15

Middle Channel / 5MHz / QPSK

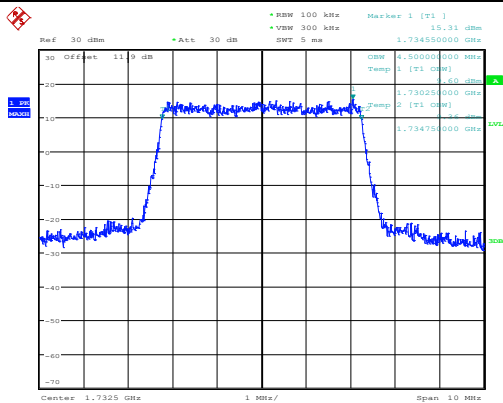

Date: 5.NOV.2014 20:30:53

Middle Channel / 5MHz / 16QAM

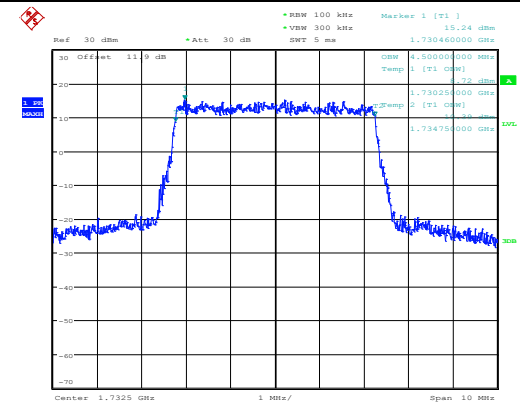

Date: 5.NOV.2014 20:31:04

Highest Channel / 5MHz / QPSK

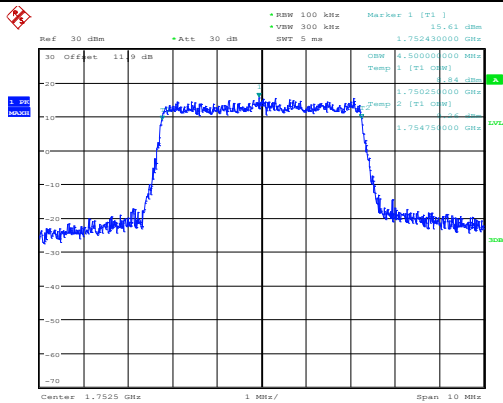

Date: 5.NOV.2014 20:34:02

Highest Channel / 5MHz / 16QAM

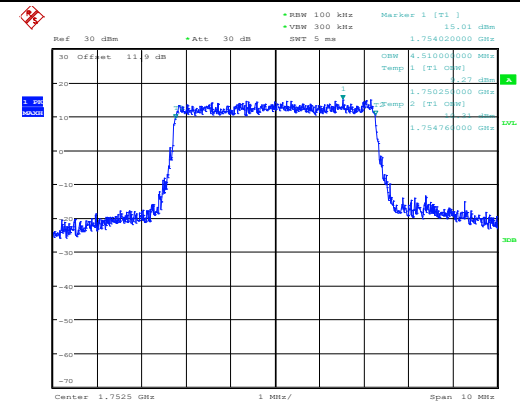

Date: 5.NOV.2014 20:34:13





LTE Band 4

Lowest Channel / 10MHz / QPSK

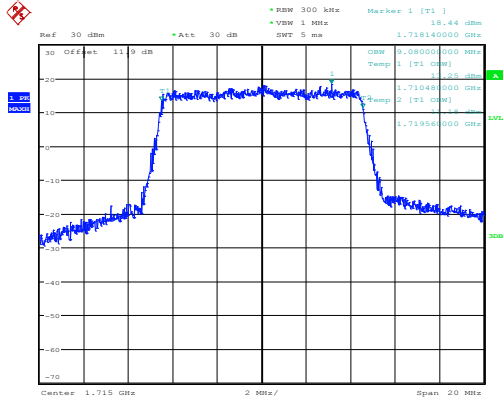

Date: 5.NOV.2014 20:41:51

Lowest Channel / 10MHz / 16QAM

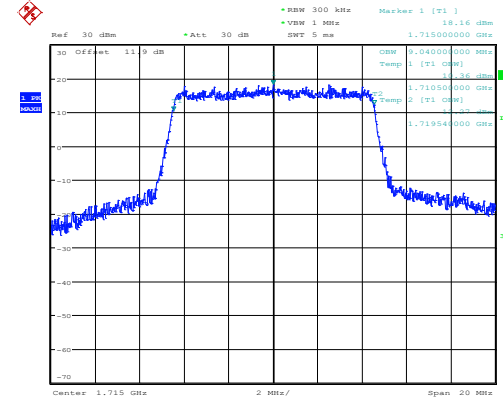

Date: 5.NOV.2014 20:42:02

Middle Channel / 10MHz / QPSK

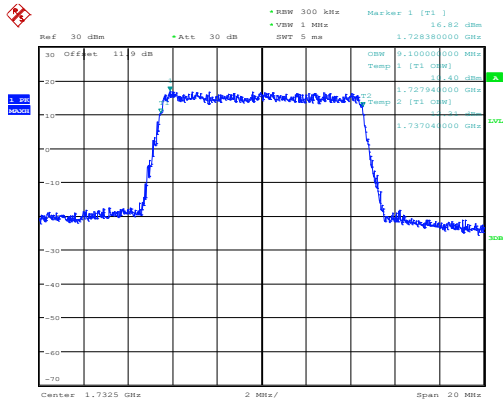

Date: 5.NOV.2014 20:49:46

Middle Channel / 10MHz / 16QAM

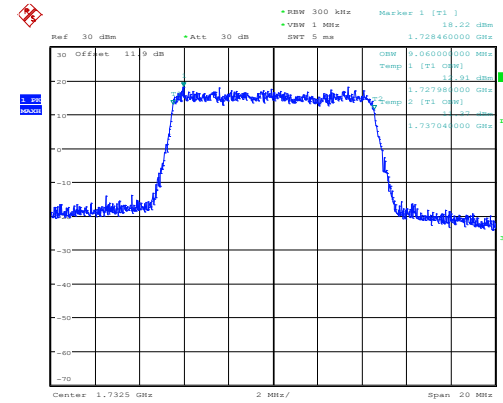

Date: 5.NOV.2014 20:49:57

Highest Channel / 10MHz / QPSK

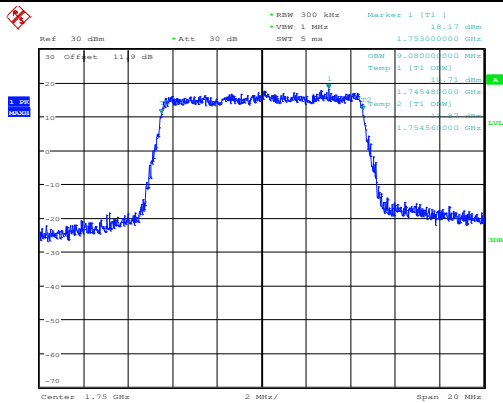

Date: 5.NOV.2014 20:52:56

Highest Channel / 10MHz / 16QAM

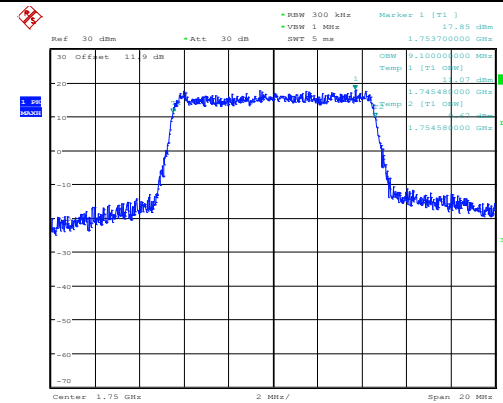

Date: 5.NOV.2014 20:53:07



LTE Band 4

Lowest Channel / 15MHz / QPSK

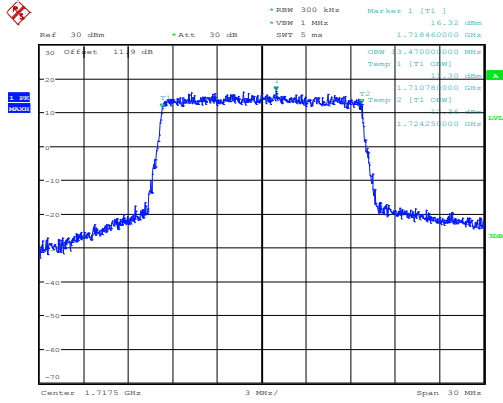

Date: 5.NOV.2014 21:00:47

Lowest Channel / 15MHz / 16QAM

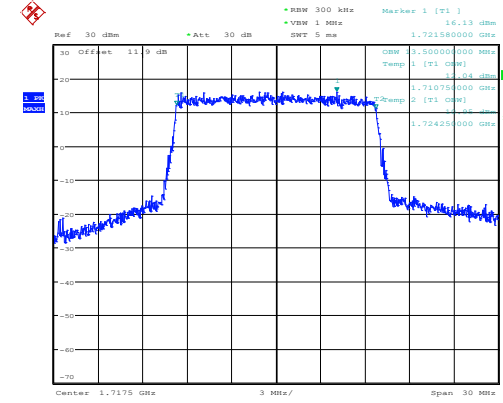

Date: 5.NOV.2014 21:00:58

Middle Channel / 15MHz / QPSK

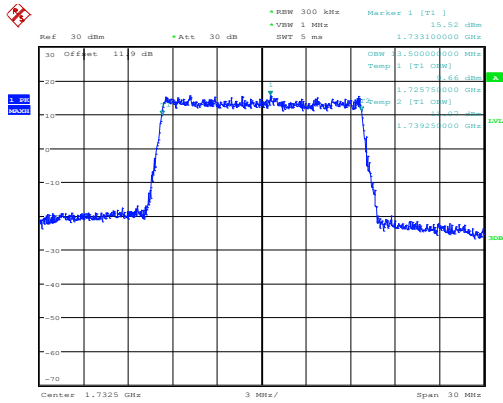

Date: 5.NOV.2014 21:08:37

Middle Channel / 15MHz / 16QAM

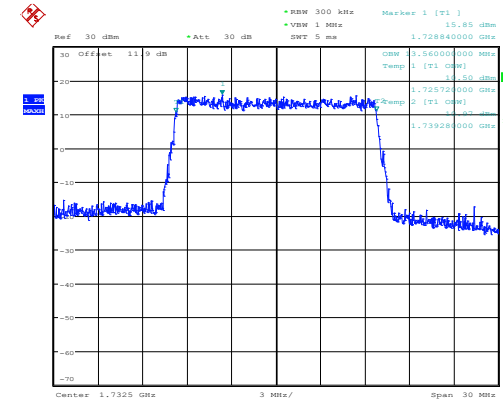

Date: 5.NOV.2014 21:08:48

Highest Channel / 15MHz / QPSK

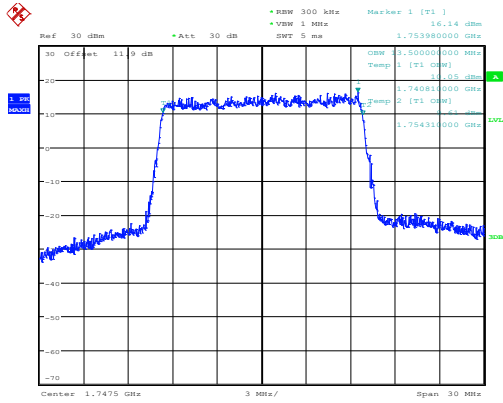

Date: 5.NOV.2014 21:11:46

Highest Channel / 15MHz / 16QAM

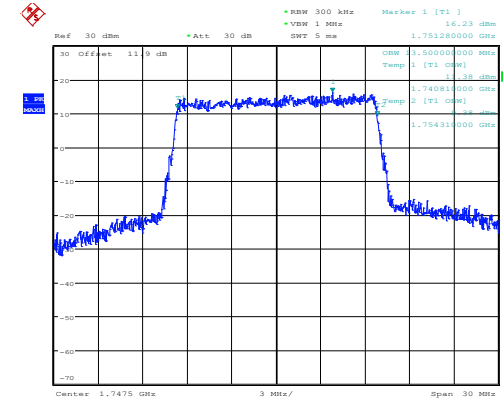

Date: 5.NOV.2014 21:11:56



LTE Band 4

Lowest Channel / 20MHz / QPSK

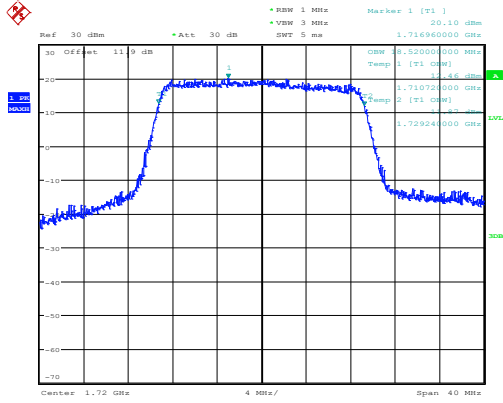

Date: 5.NOV.2014 21:19:35

Lowest Channel / 20MHz / 16QAM

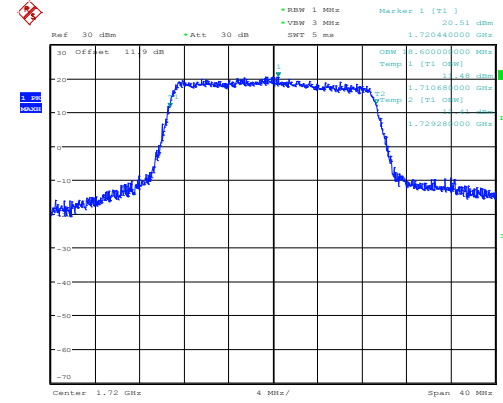

Date: 5.NOV.2014 21:19:46

Middle Channel / 20MHz / QPSK

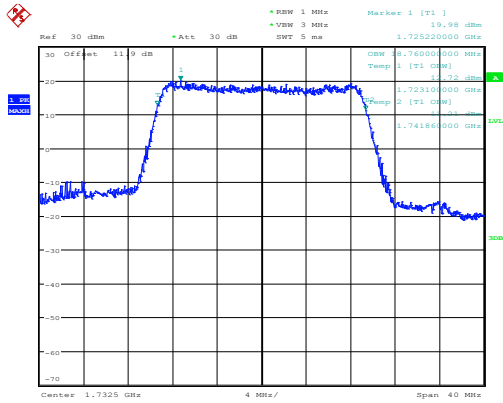

Date: 5.NOV.2014 21:27:26

Middle Channel / 20MHz / 16QAM

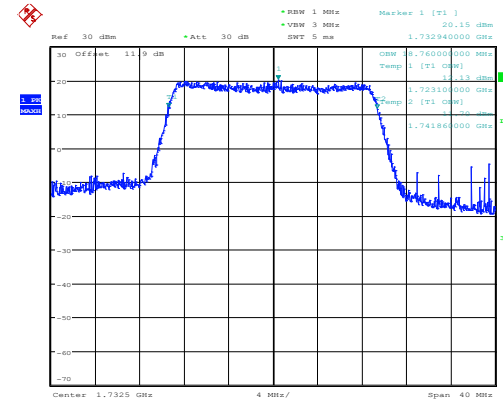

Date: 5.NOV.2014 21:27:37

Highest Channel / 20MHz / QPSK

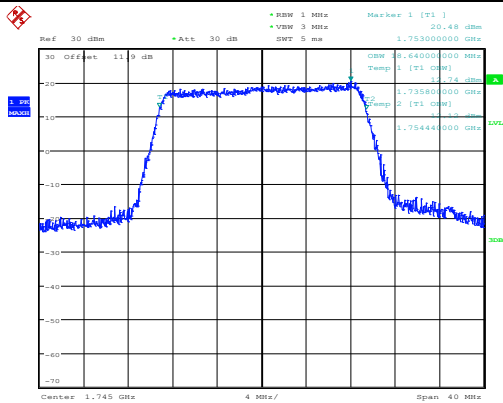

Date: 5.NOV.2014 21:30:34

Highest Channel / 20MHz / 16QAM

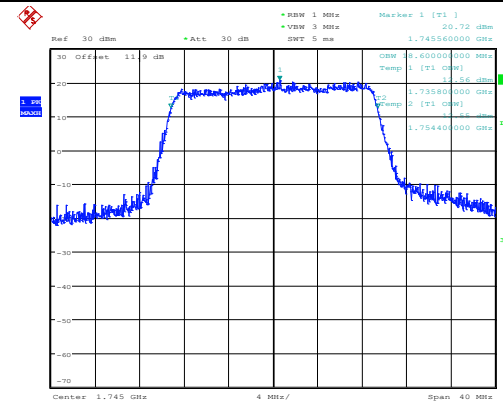

Date: 5.NOV.2014 21:30:45



LTE Band 13

Lowest Channel / 5MHz / QPSK

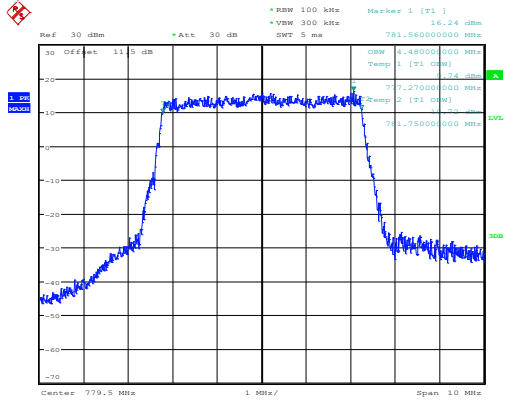

Date: 5.NOV.2014 22:45:56

Lowest Channel / 5MHz / 16QAM

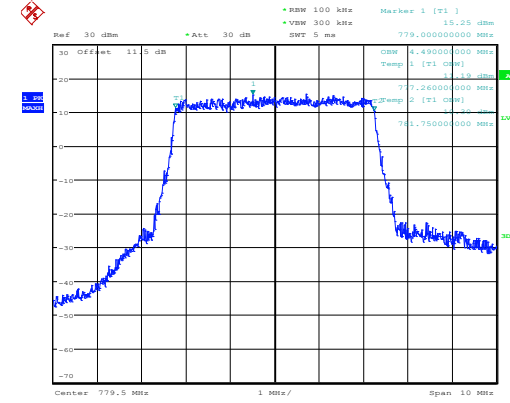

Date: 10.NOV.2014 18:57:12

Middle Channel / 5MHz / QPSK

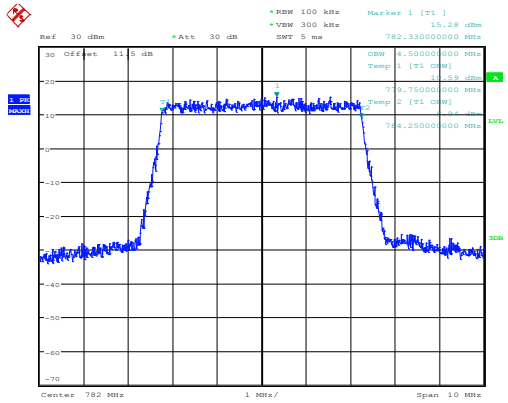

Date: 5.NOV.2014 22:56:27

Middle Channel / 5MHz / 16QAM

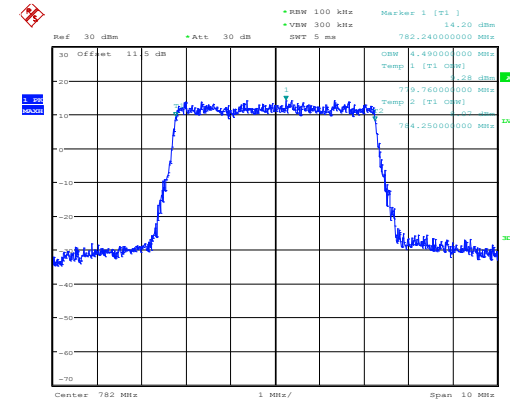

Date: 5.NOV.2014 22:56:16

Highest Channel / 5MHz / QPSK

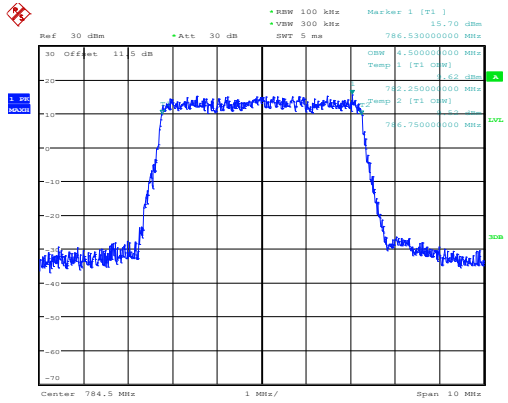

Date: 5.NOV.2014 22:56:39

Highest Channel / 5MHz / 16QAM

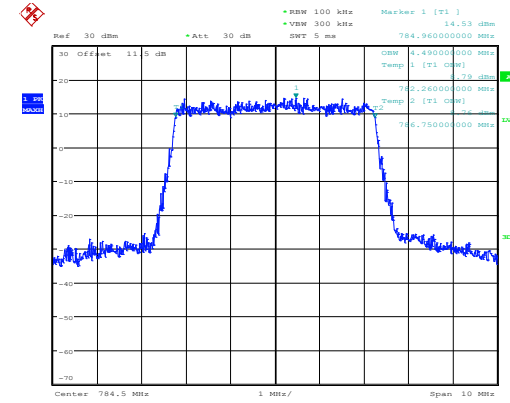

Date: 5.NOV.2014 22:56:48



LTE Band 13

Middle Channel / 10MHz / QPSK

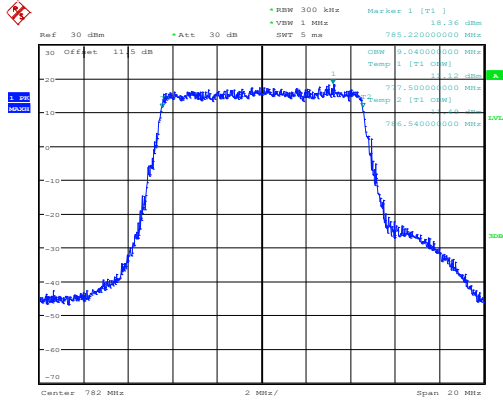

Date: 5.NOV.2014 22:59:46

Middle Channel / 10MHz / 16QAM

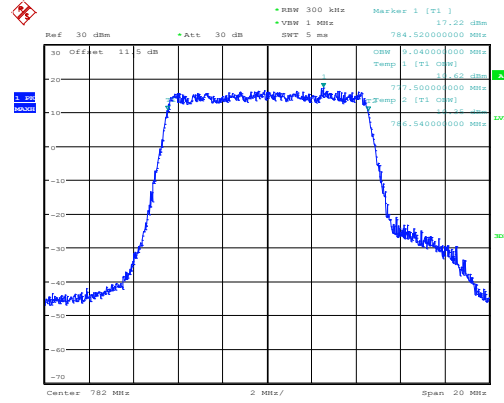

Date: 5.NOV.2014 22:59:57



# Conducted Band Edge

## LTE Band 4 / 1.4MHz / QPSK

### Lowest Band Edge / 1RB

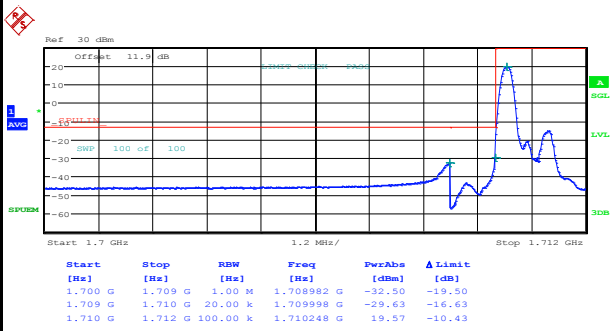

Date: 5.NOV.2014 22:36:05

### Highest Band Edge / 1RB

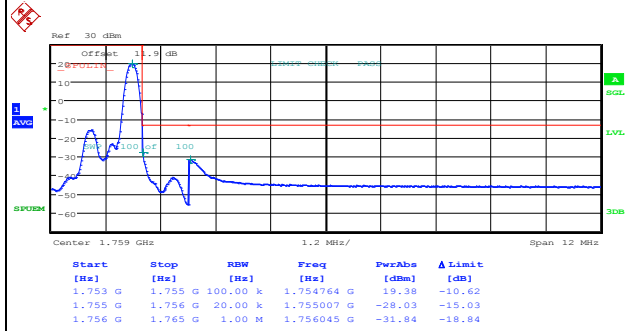

Date: 5.NOV.2014 22:44:31

### Lowest Band Edge / Full RB

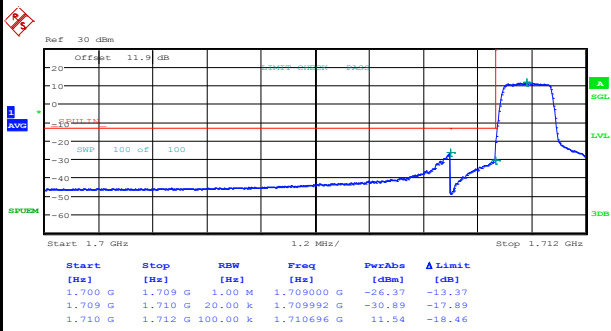

Date: 5.NOV.2014 22:35:40

### Highest Band Edge / Full RB

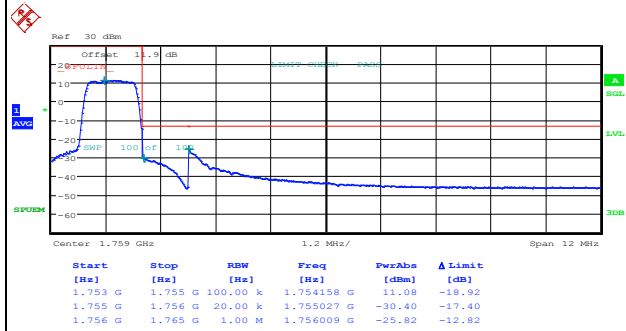

Date: 5.NOV.2014 22:41:37



LTE Band 4 / 1.4MHz / 16QAM

Lowest Band Edge / 1 RB

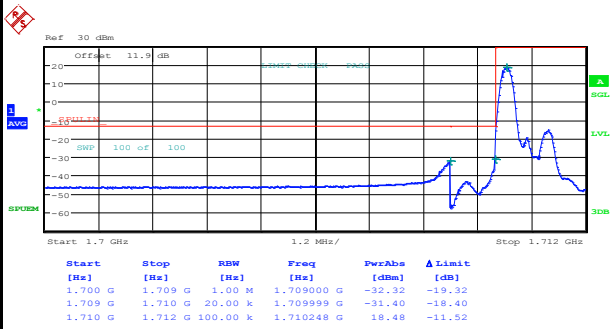

Date: 5.NOV.2014 22:36:56

Highest Band Edge / 1 RB

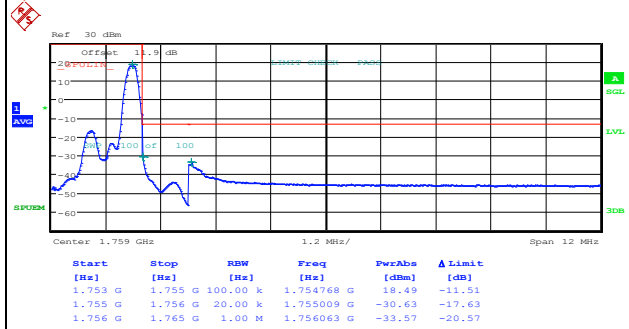

Date: 5.NOV.2014 22:43:33

Lowest Band Edge / Full RB

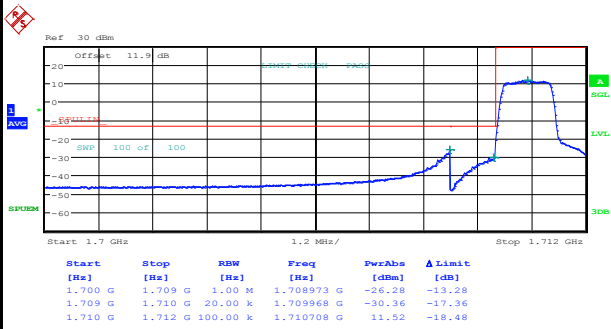

Date: 5.NOV.2014 22:35:05

Highest Band Edge / Full RB

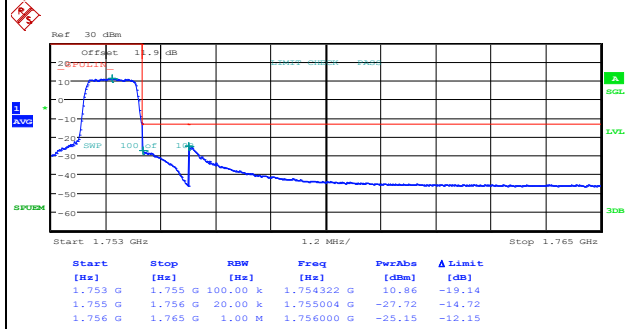

Date: 5.NOV.2014 22:40:15



LTE Band 4 / 3MHz / QPSK

Lowest Band Edge / 1RB

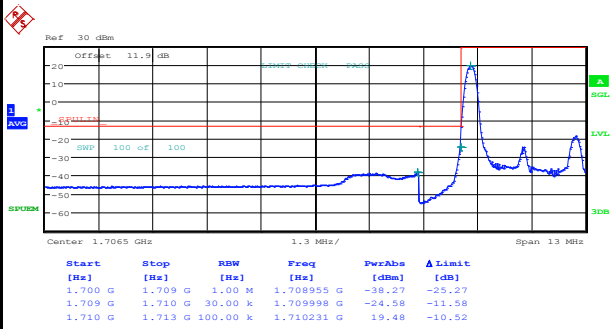

Date: 5.NOV.2014 20:06:02

Highest Band Edge / 1 RB

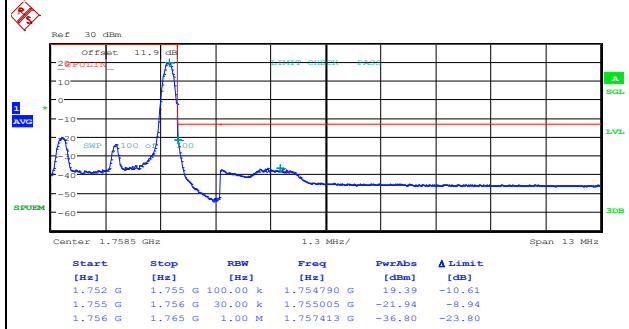

Date: 5.NOV.2014 20:17:01

Lowest Band Edge / Full RB

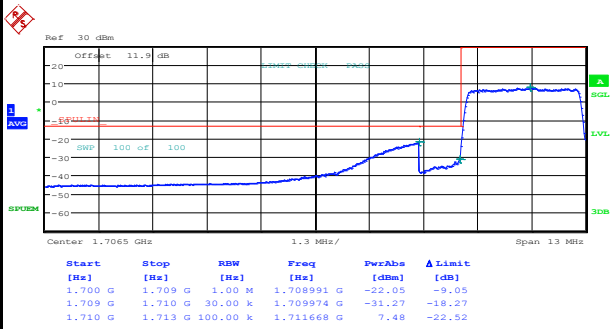

Date: 5.NOV.2014 20:08:23

Highest Band Edge / Full RB

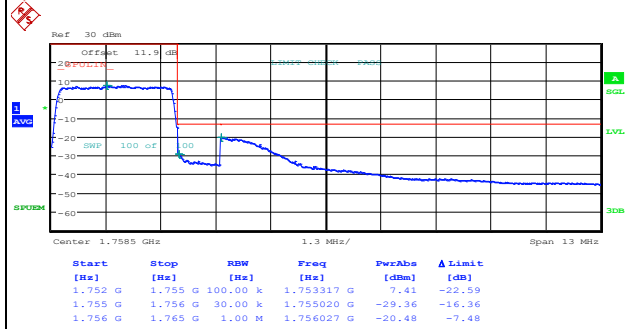

Date: 5.NOV.2014 20:19:21





LTE Band 4 / 3MHz / 16QAM

Lowest Band Edge / 1 RB

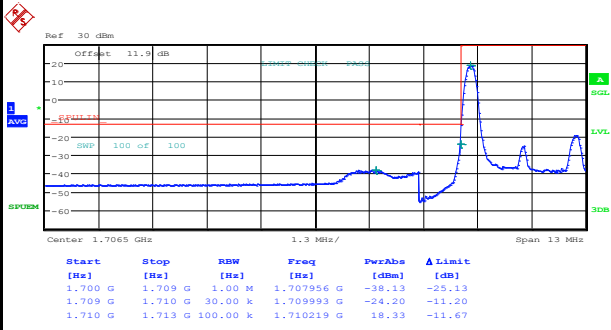

Date: 5.NOV.2014 20:07:13

Highest Band Edge / 1 RB

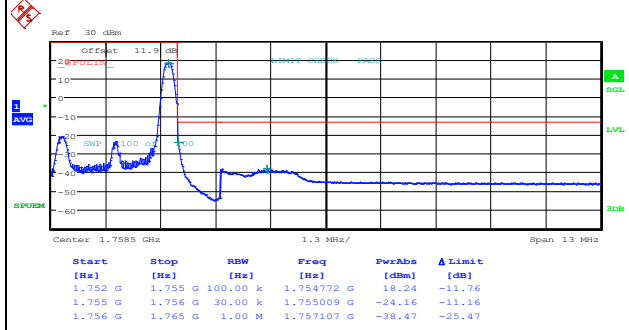

Date: 5.NOV.2014 20:18:11

Lowest Band Edge / Full RB

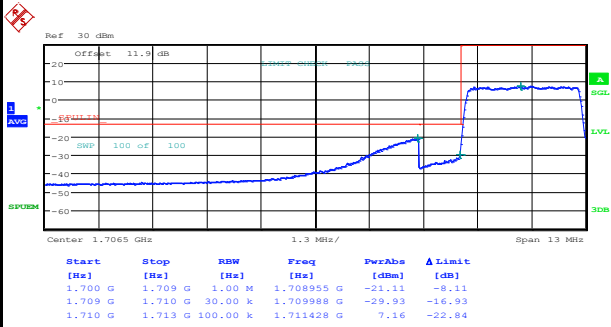

Date: 5.NOV.2014 20:09:33

Highest Band Edge / Full RB

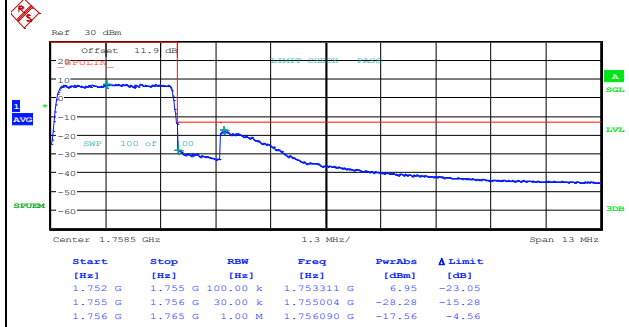

Date: 5.NOV.2014 20:20:32



LTE Band 4 / 5MHz / QPSK

Lowest Band Edge / 1 RB

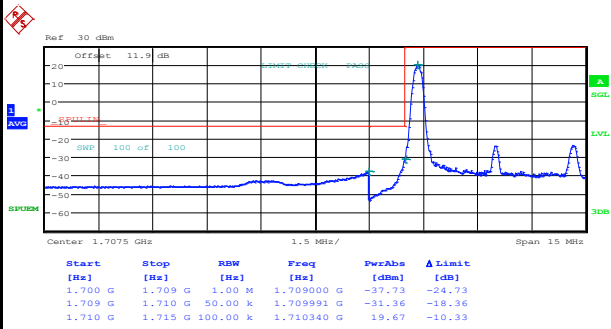

Date: 5.NOV.2014 20:24:50

Highest Band Edge / 1 RB

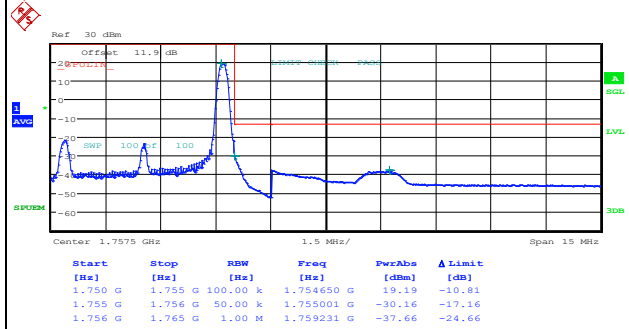

Date: 5.NOV.2014 20:35:49

Lowest Band Edge / Full RB

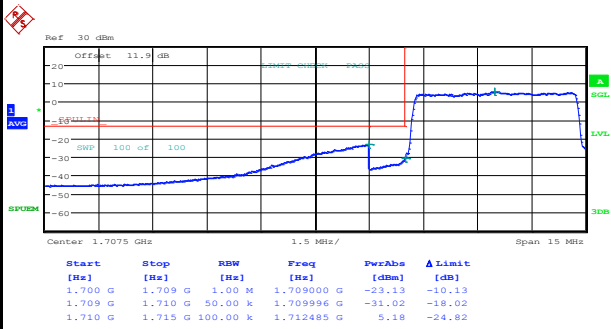

Date: 5.NOV.2014 20:27:11

Highest Band Edge / Full RB

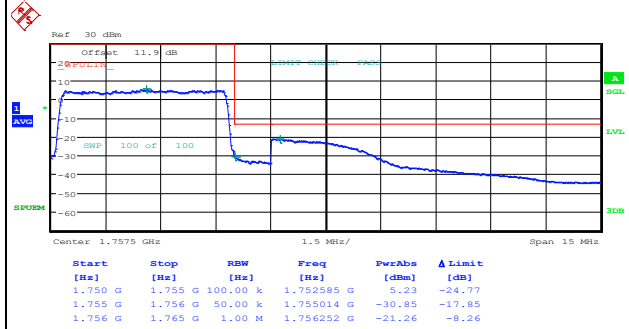

Date: 5.NOV.2014 20:38:09



LTE Band 4 / 5MHz / 16QAM

Lowest Band Edge / 1RB

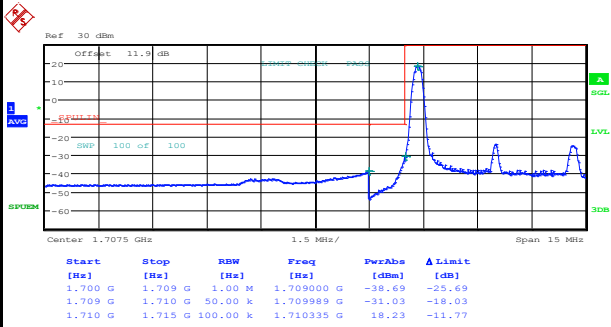

Date: 5.NOV.2014 20:26:01

Highest Band Edge / 1 RB

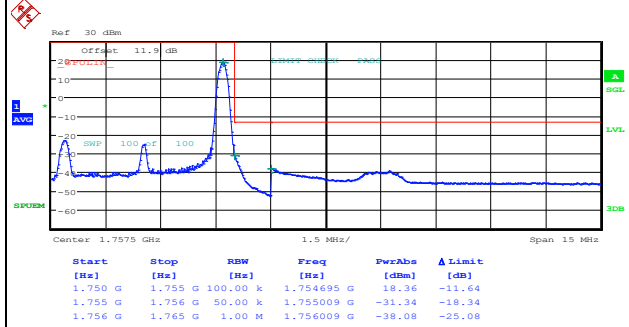

Date: 5.NOV.2014 20:36:59

Lowest Band Edge / Full RB

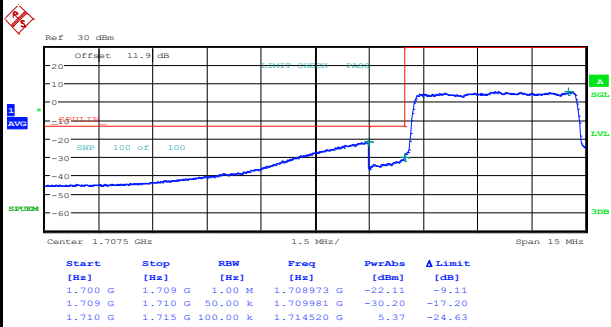

Date: 5.NOV.2014 20:28:21

Highest Band Edge / Full RB

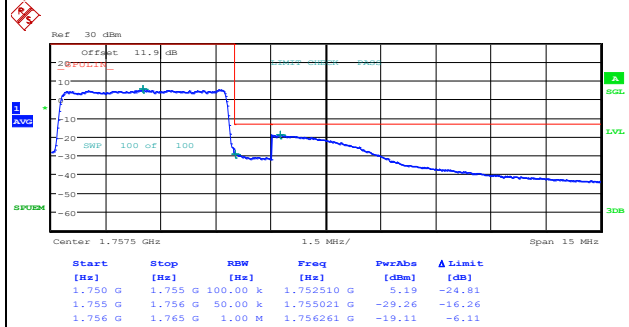

Date: 5.NOV.2014 20:39:20



LTE Band 4 / 10MHz / QPSK

Lowest Band Edge / 1 RB

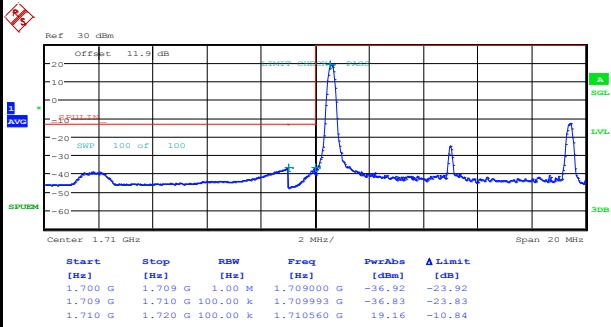

Date: 5.NOV.2014 20:43:38

Highest Band Edge / 1 RB

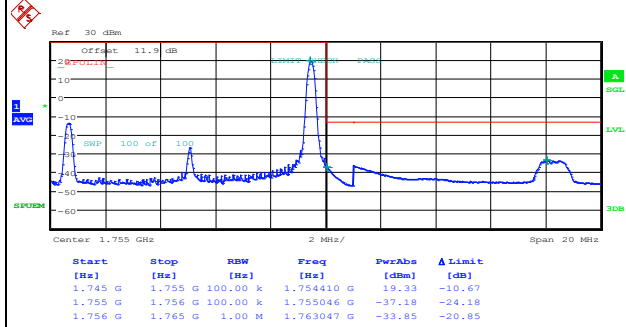

Date: 5.NOV.2014 20:54:43

Lowest Band Edge / Full RB

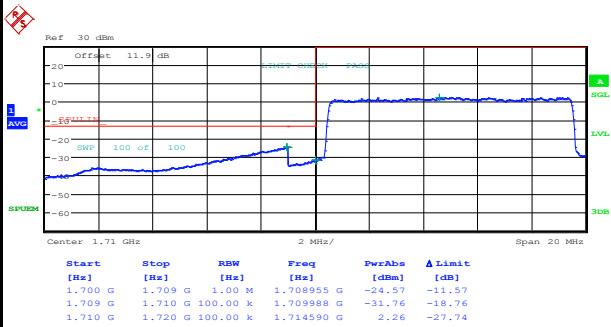

Date: 5.NOV.2014 20:45:59

Highest Band Edge / Full RB

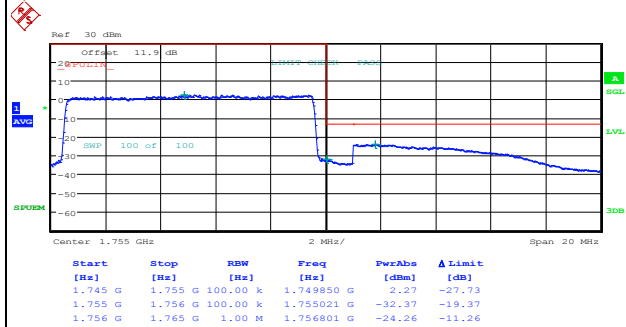

Date: 5.NOV.2014 20:57:04



LTE Band 4 / 10MHz / 16QAM

Lowest Band Edge / 1 RB

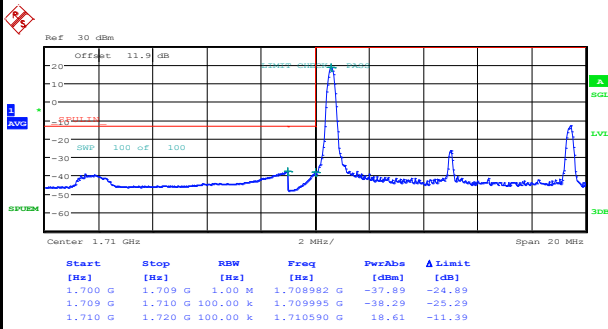

Date: 5.NOV.2014 20:44:48

Highest Band Edge / 1 RB

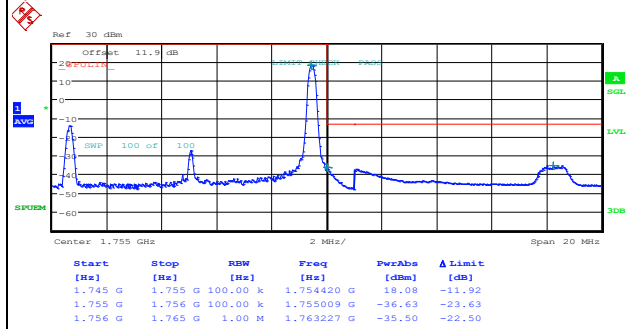

Date: 5.NOV.2014 20:55:54

Lowest Band Edge / Full RB

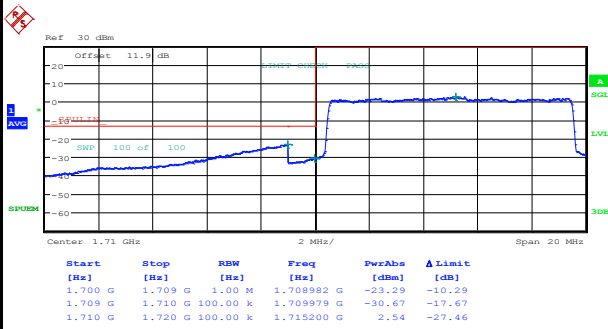

Date: 5.NOV.2014 20:47:09

Highest Band Edge / Full RB

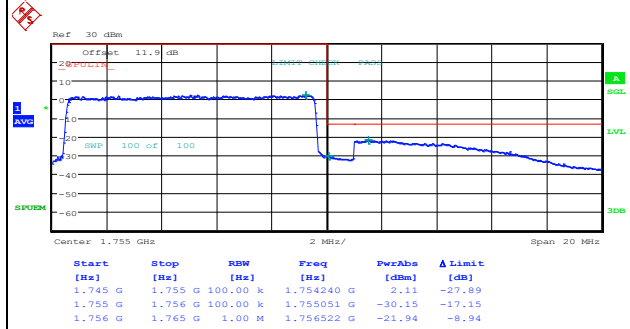

Date: 5.NOV.2014 20:58:14



LTE Band 4 / 15MHz / QPSK

Lowest Band Edge / 1 RB

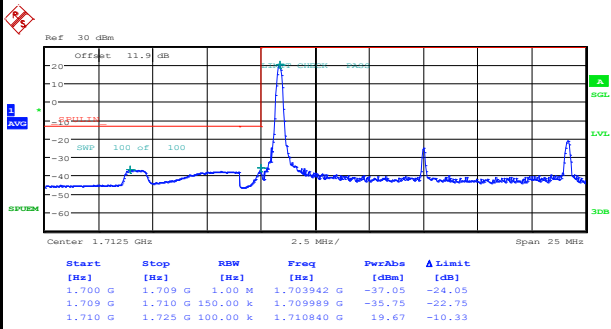

Date: 5.NOV.2014 21:02:34

Highest Band Edge / 1 RB

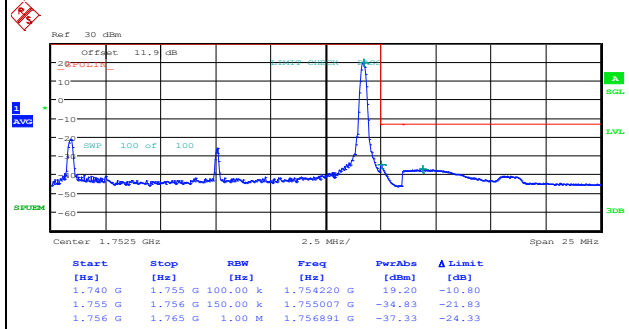

Date: 5.NOV.2014 21:13:32

Lowest Band Edge / Full RB

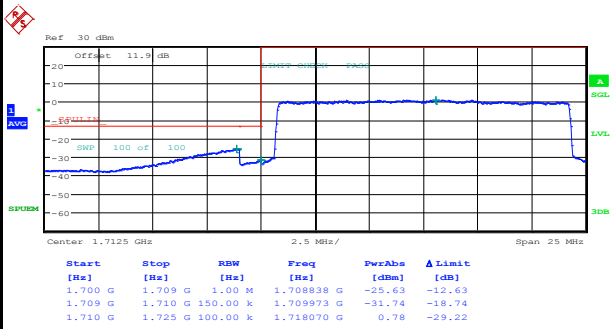

Date: 5.NOV.2014 21:04:55

Highest Band Edge / Full RB

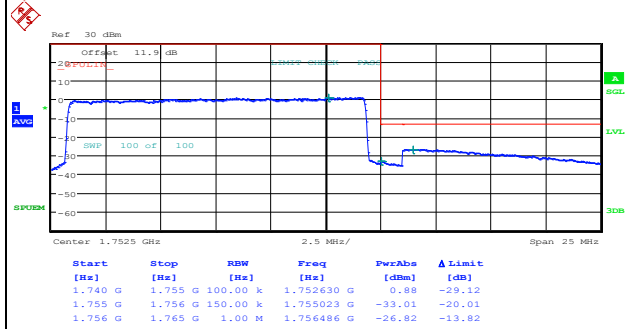

Date: 5.NOV.2014 21:15:53



LTE Band 4 / 15MHz / 16QAM

Lowest Band Edge / 1 RB

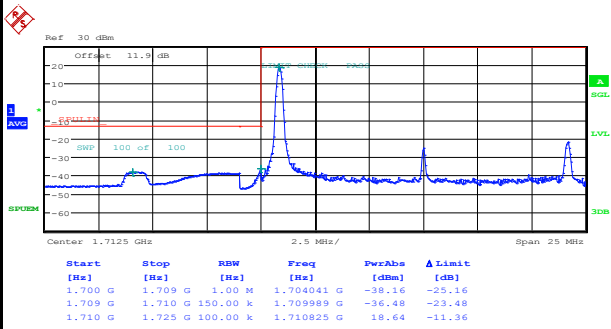

Date: 5.NOV.2014 21:03:44

Highest Band Edge / 1 RB

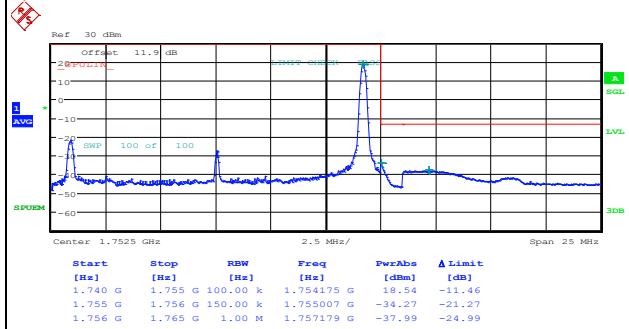

Date: 5.NOV.2014 21:14:43

Lowest Band Edge / Full RB

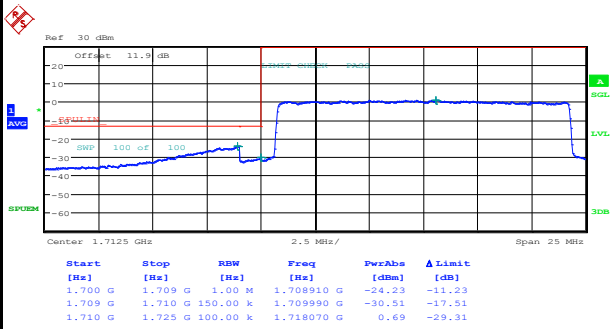

Date: 5.NOV.2014 21:06:05

Highest Band Edge / Full RB

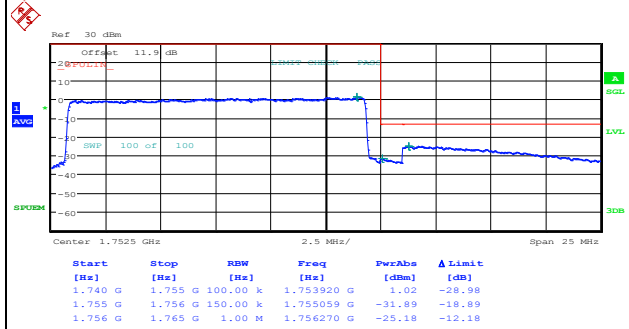

Date: 5.NOV.2014 21:17:03



LTE Band 4 / 20MHz / QPSK

Lowest Band Edge / 1 RB

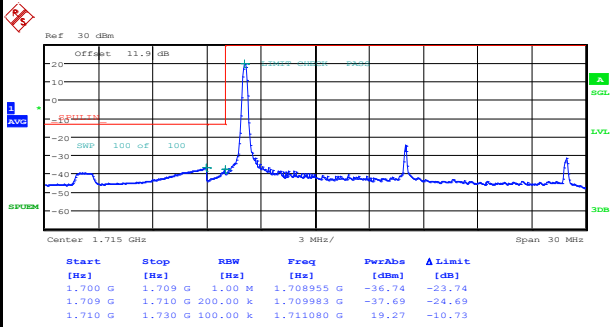

Date: 5.NOV.2014 21:21:22

Highest Band Edge / 1 RB

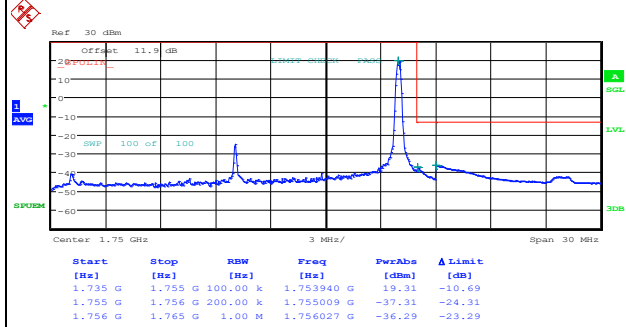

Date: 5.NOV.2014 21:32:20

Lowest Band Edge / Full RB

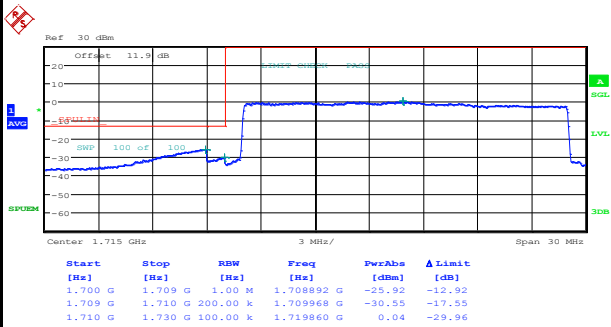

Date: 5.NOV.2014 21:23:43

Highest Band Edge / Full RB

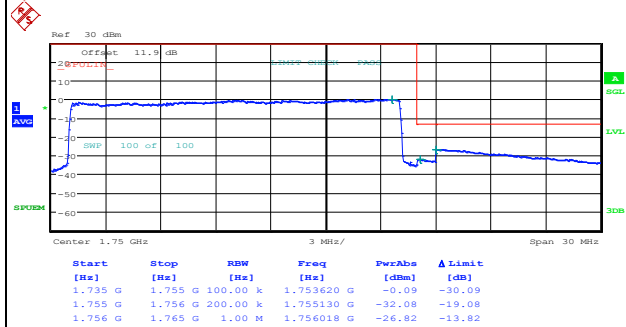

Date: 5.NOV.2014 21:34:41





LTE Band 4 / 20MHz / 16QAM

Lowest Band Edge / 1 RB

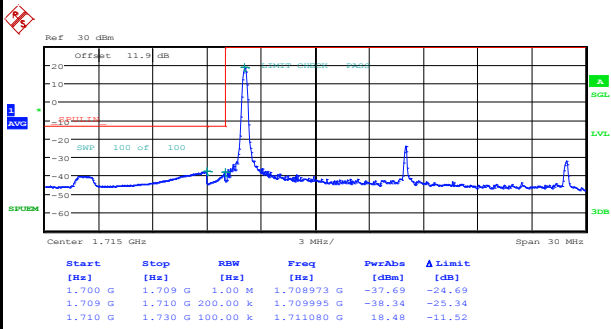

Date: 5.NOV.2014 21:22:33

Highest Band Edge / 1 RB

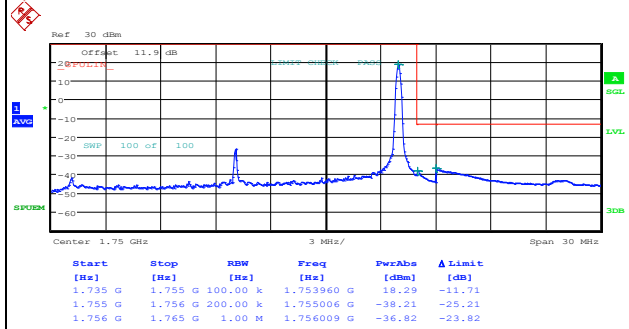

Date: 5.NOV.2014 21:33:31

Lowest Band Edge / Full RB

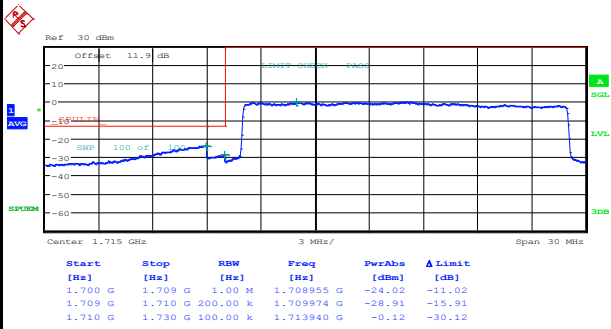

Date: 5.NOV.2014 21:24:54

Highest Band Edge / Full RB

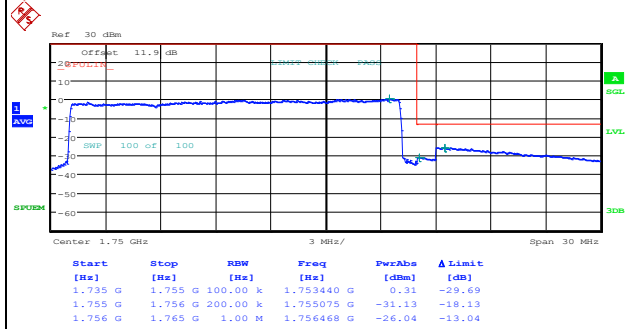

Date: 5.NOV.2014 21:35:52



LTE Band 13 / 5MHz / QPSK

Lowest Band Edge / 1 RB

Highest Band Edge / 1 RB

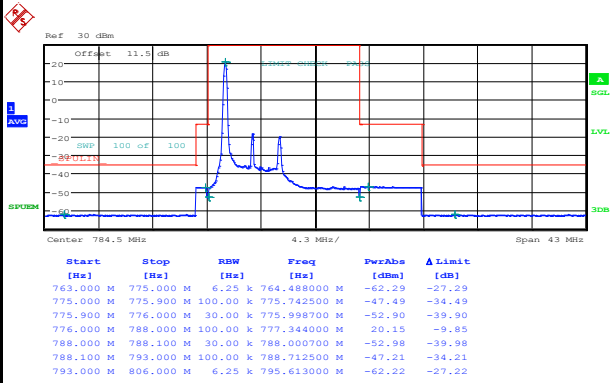

Date: 5.NOV.2014 23:48:26

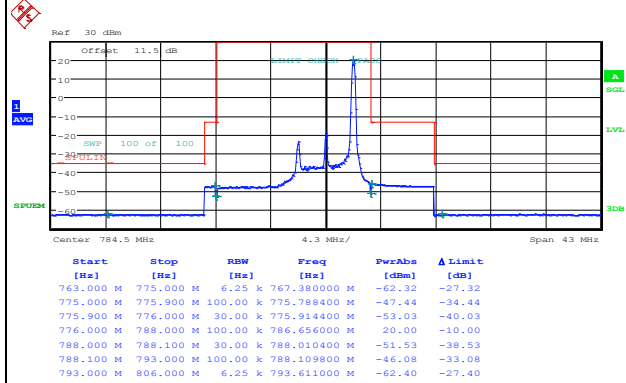

Date: 6.NOV.2014 00:13:27

Lowest Band Edge / Full RB

Highest Band Edge / Full RB

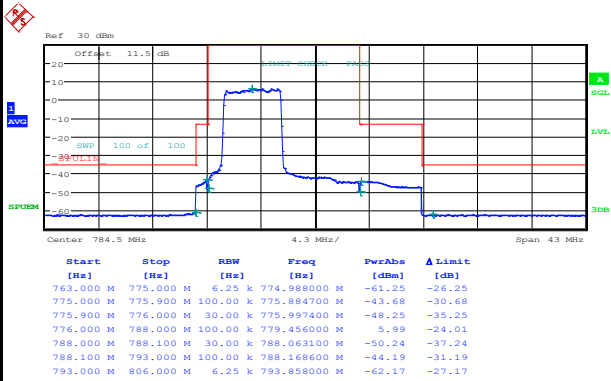

Date: 5.NOV.2014 23:41:30

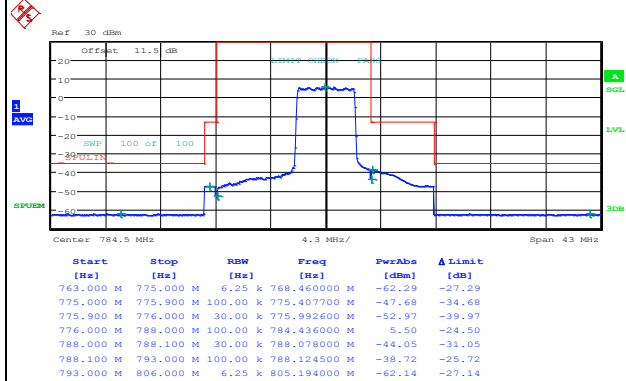

Date: 6.NOV.2014 00:22:34



LTE Band 13 / 5MHz / 16QAM

Lowest Band Edge / 1 RB

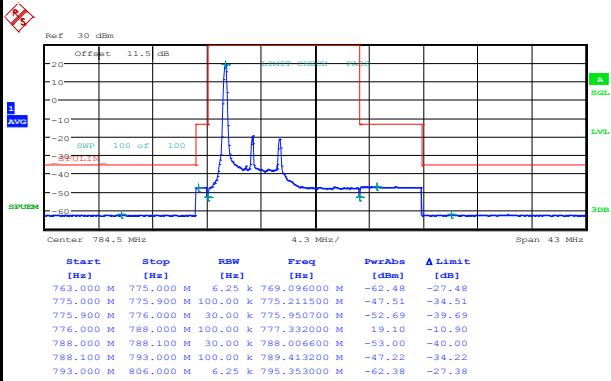

Date: 5.NOV.2014 23:46:17

Highest Band Edge / 1 RB

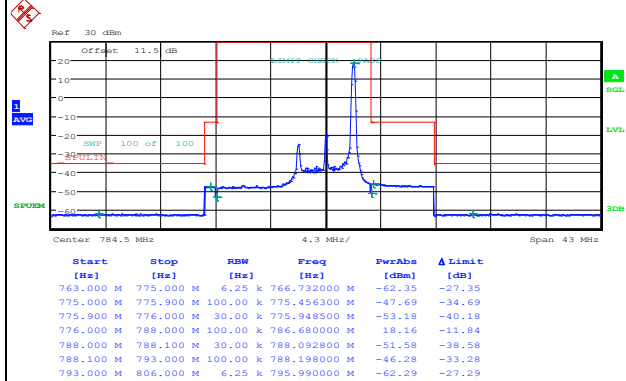

Date: 6.NOV.2014 00:16:29

Lowest Band Edge / Full RB

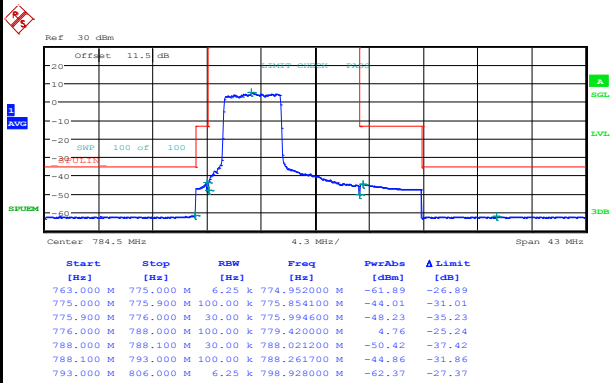

Date: 5.NOV.2014 23:43:46

Highest Band Edge / Full RB

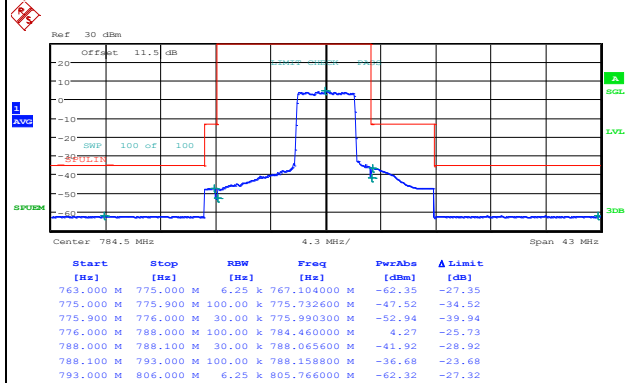

Date: 6.NOV.2014 00:19:12



LTE Band 13 / 10MHz / QPSK

Lowest Band Edge / 1 RB

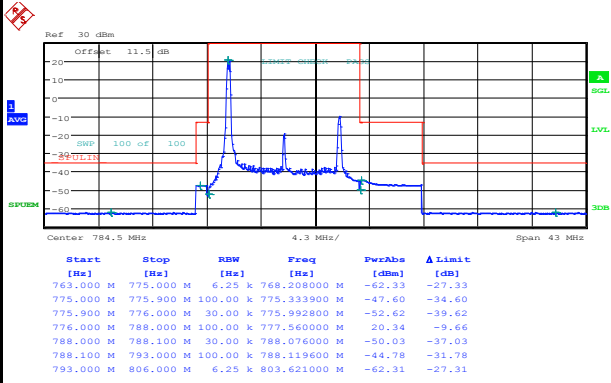

Date: 5.NOV.2014 23:27:20

Highest Band Edge / 1 RB

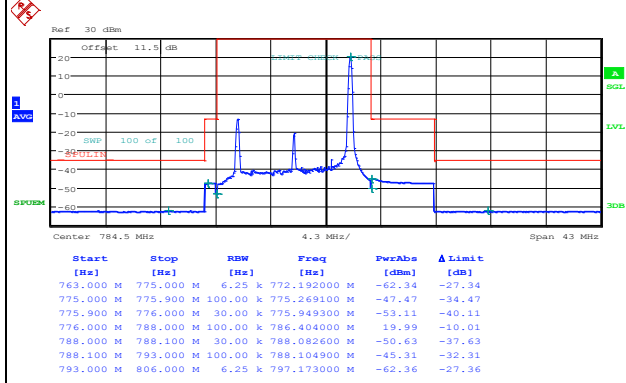

Date: 5.NOV.2014 23:24:14

Band Edge / Full RB

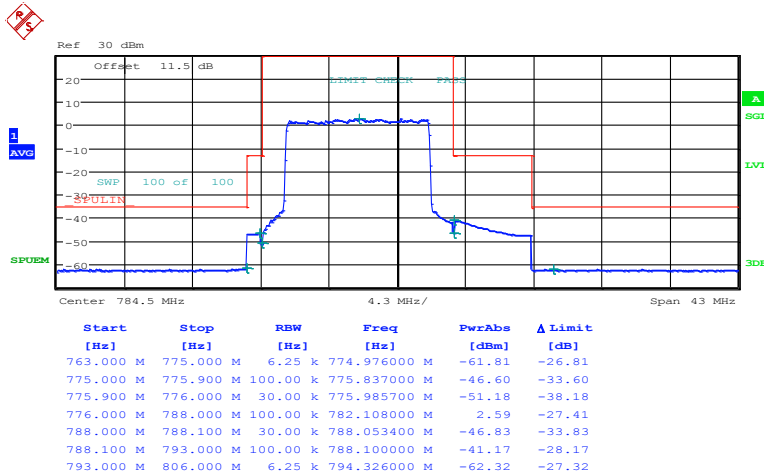

Date: 5.NOV.2014 23:39:01



LTE Band 13 / 10MHz / 16QAM

Lowest Band Edge / 1 RB

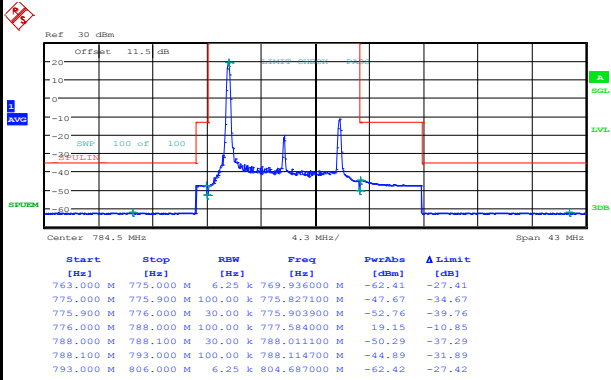

Date: 5.NOV.2014 23:33:07

Highest Band Edge / 1 RB

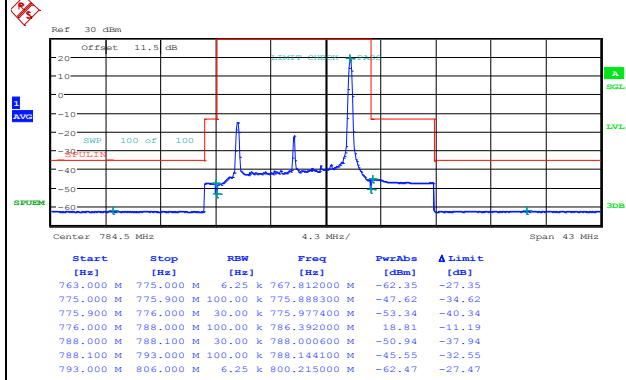

Date: 5.NOV.2014 23:21:56

Band Edge / Full RB

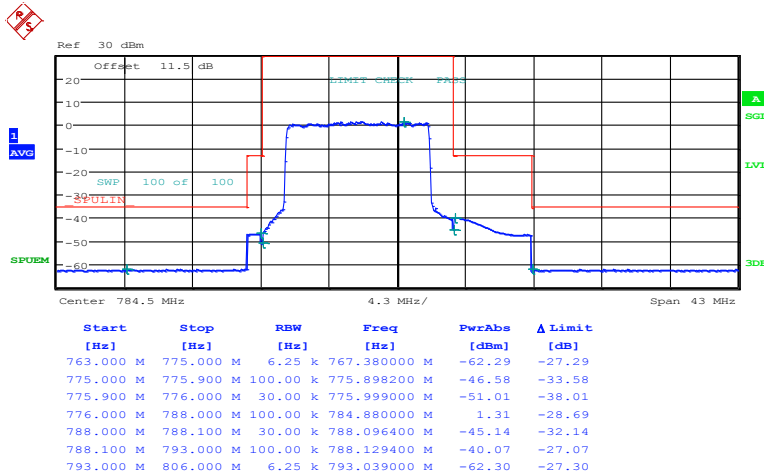

Date: 5.NOV.2014 23:36:30



# Conducted Spurious Emission

## LTE Band 4 / 1.4MHz

### Lowest Channel / QPSK

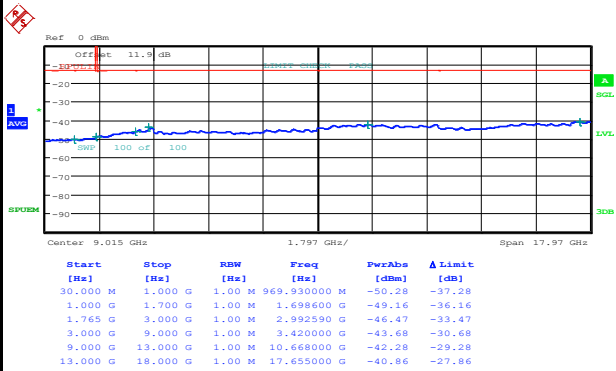

Date: 5.NOV.2014 22:16:37

### Lowest Channel / 16QAM

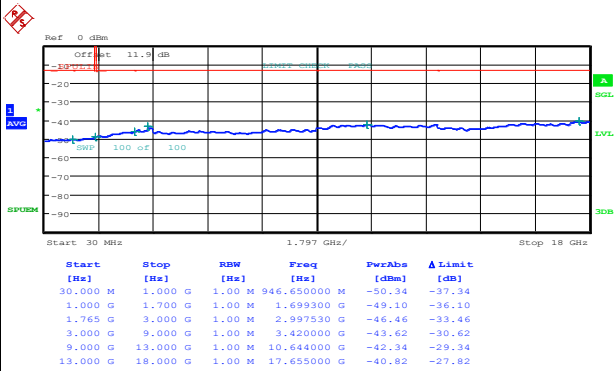

Date: 5.NOV.2014 22:18:07

### Middle Channel / QPSK

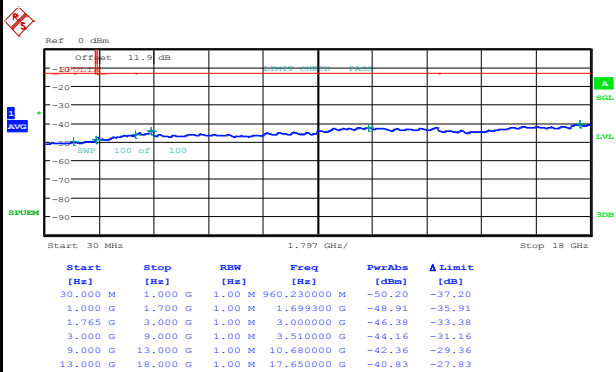

Date: 5.NOV.2014 22:23:20

### Middle Channel / 16QAM

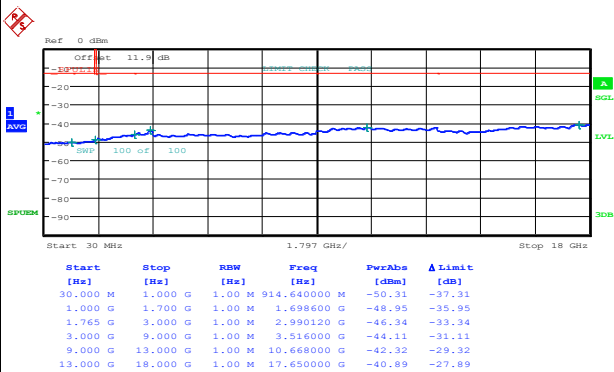

Date: 5.NOV.2014 22:19:05



LTE Band 4 / 1.4MHz

Highest Channel / QPSK

Highest Channel / 16QAM

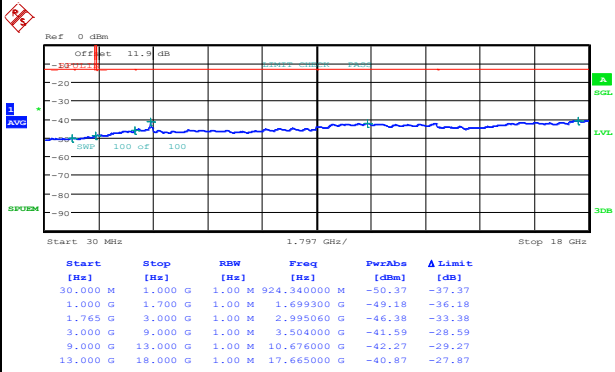

Date: 5.NOV.2014 22:29:07

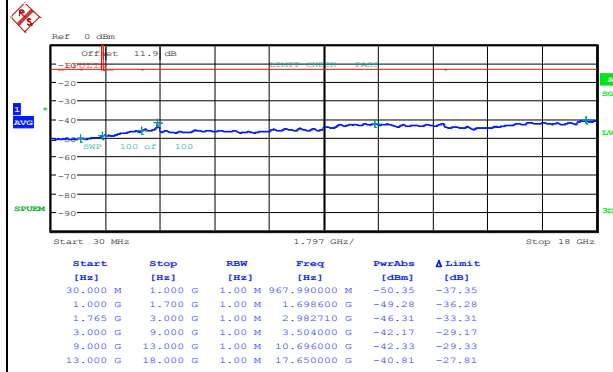

Date: 5.NOV.2014 22:30:59

LTE Band 4 / 3MHz

Lowest Channel / QPSK

Lowest Channel / 16QAM

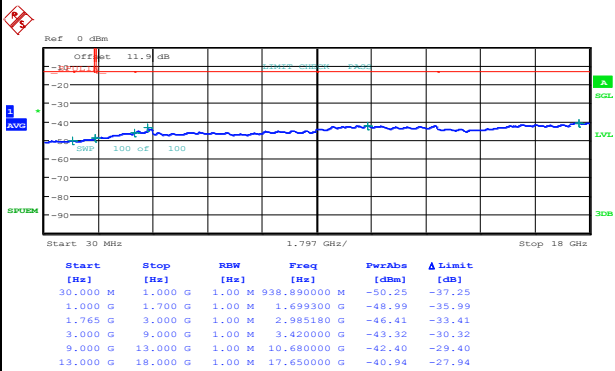

Date: 5.NOV.2014 20:10:44

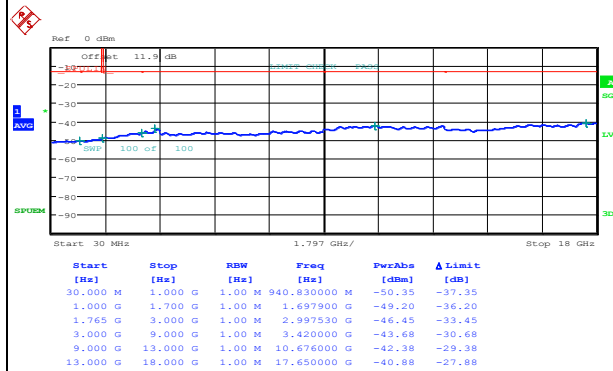

Date: 5.NOV.2014 20:11:54



LTE Band 4 / 3MHz

Middle Channel / QPSK

Middle Channel / 16QAM

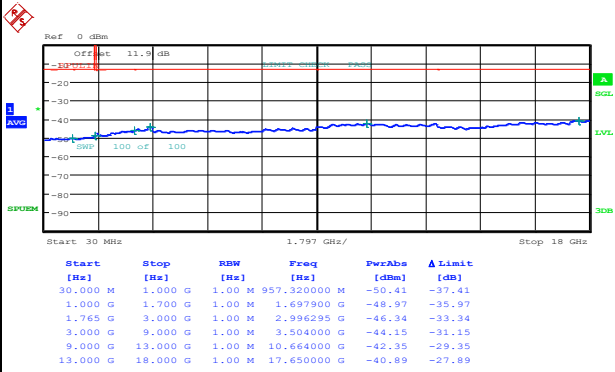

Date: 5.NOV.2014 20:13:52

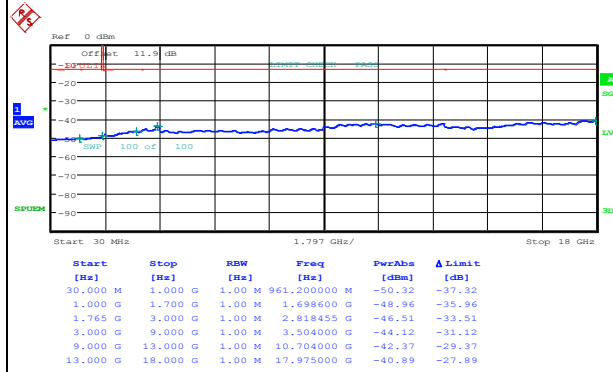

Date: 5.NOV.2014 20:15:03

Highest Channel / QPSK

Highest Channel / 16QAM

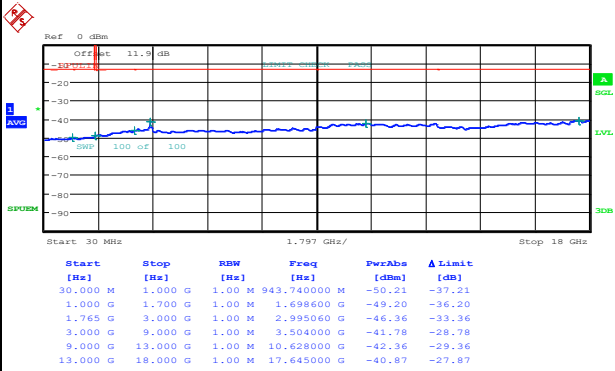

Date: 5.NOV.2014 20:21:42

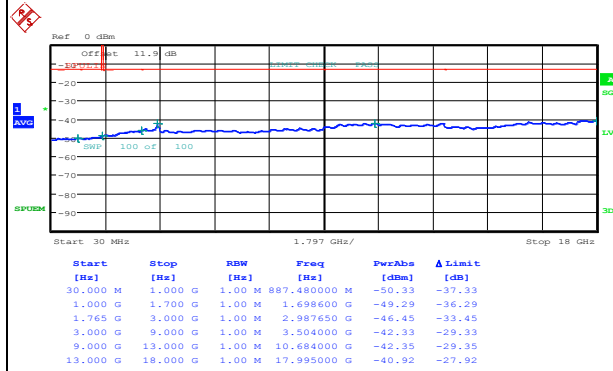

Date: 5.NOV.2014 20:22:53





LTE Band 4 / 5MHz

Lowest Channel / QPSK

Lowest Channel / 16QAM

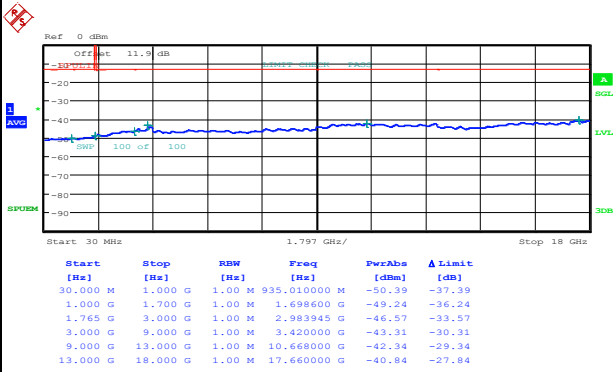

Date: 5.NOV.2014 20:29:32

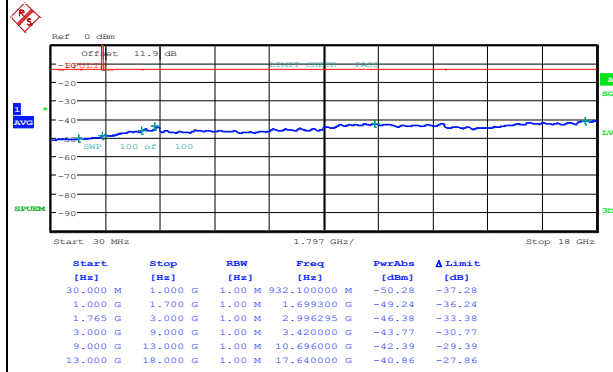

Date: 5.NOV.2014 20:30:42

Middle Channel / QPSK

Middle Channel / 16QAM

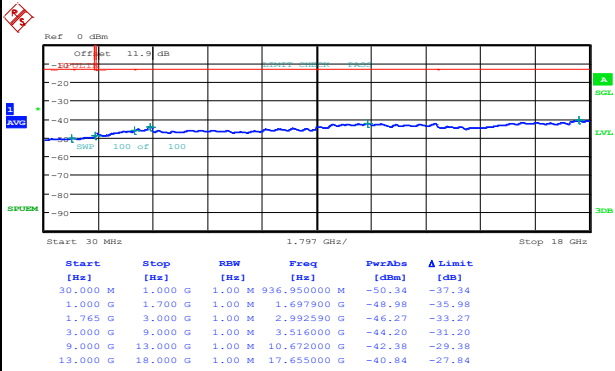

Date: 5.NOV.2014 20:32:40

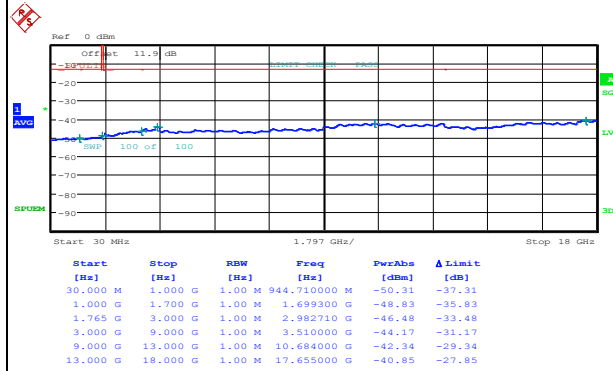

Date: 5.NOV.2014 20:33:51



LTE Band 4 / 5MHz

Highest Channel / QPSK

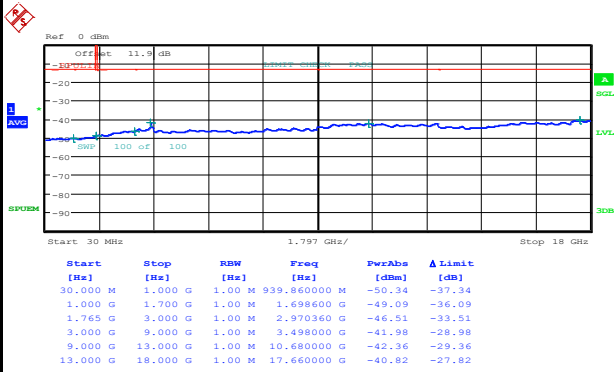

Date: 5.NOV.2014 20:40:30

Highest Channel / 16QAM

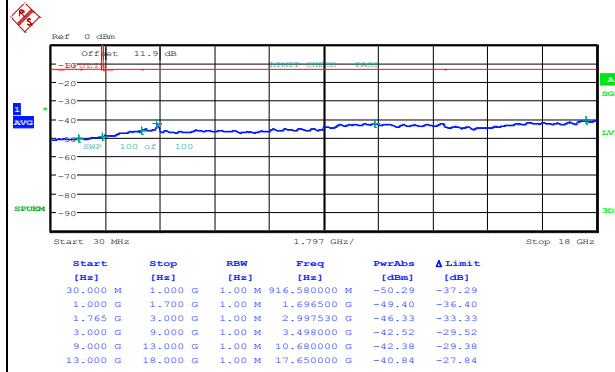

Date: 5.NOV.2014 20:41:40

LTE Band 4 / 10MHz

Lowest Channel / QPSK

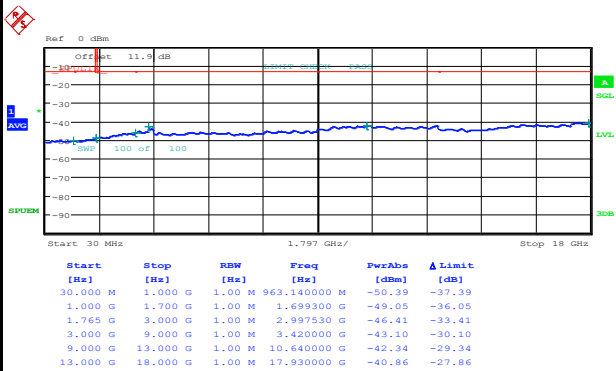

Date: 5.NOV.2014 20:48:19

Lowest Channel / 16QAM

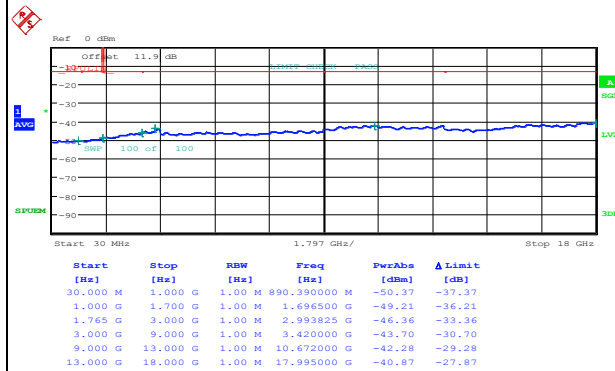

Date: 5.NOV.2014 20:49:30



LTE Band 4 / 10MHz

Middle Channel / QPSK

Middle Channel / 16QAM

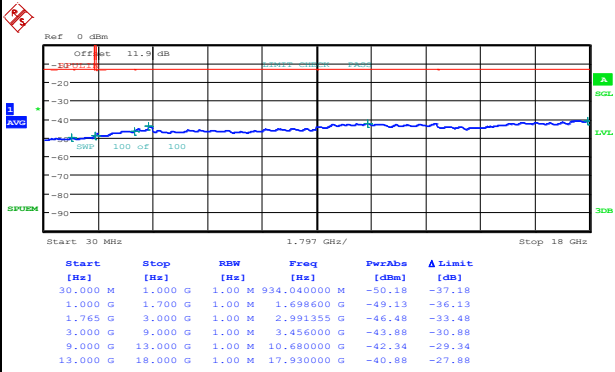

Date: 5.NOV.2014 20:51:34



Date: 5.NOV.2014 20:52:45

Highest Channel / QPSK

Highest Channel / 16QAM

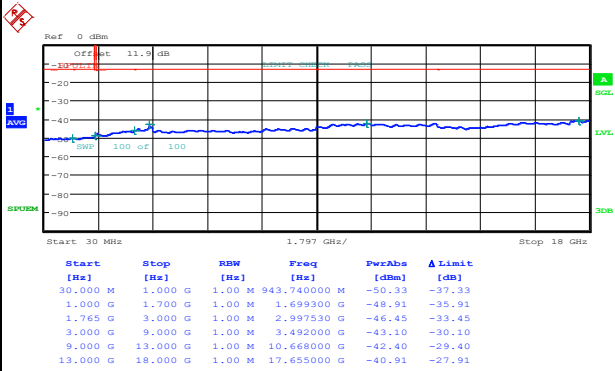

Date: 5.NOV.2014 20:59:25

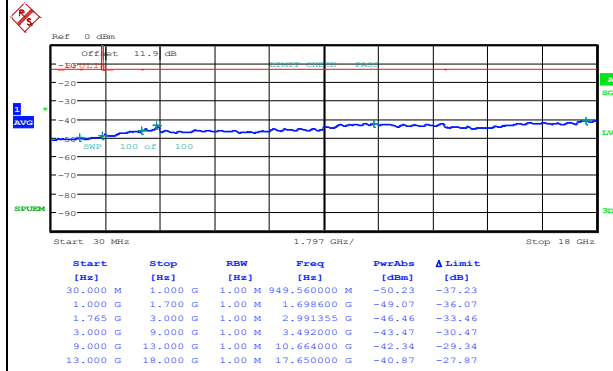

Date: 5.NOV.2014 21:00:36



LTE Band 4 / 15MHz

Lowest Channel / QPSK

Lowest Channel / 16QAM

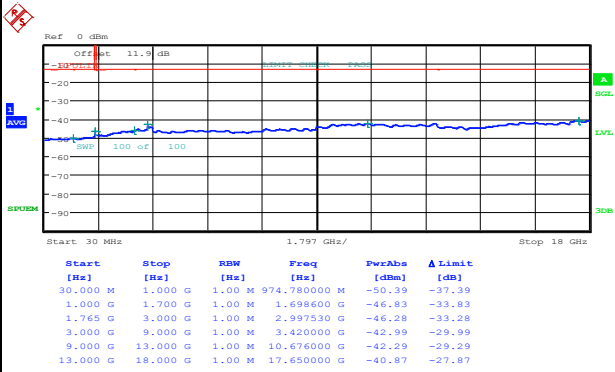

Date: 5.NOV.2014 21:07:16

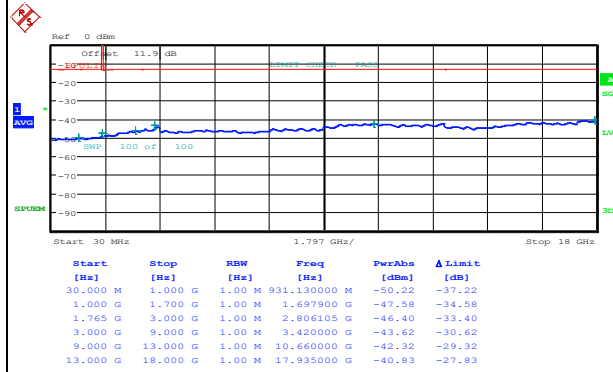

Date: 5.NOV.2014 21:08:26

Middle Channel / QPSK

Middle Channel / 16QAM

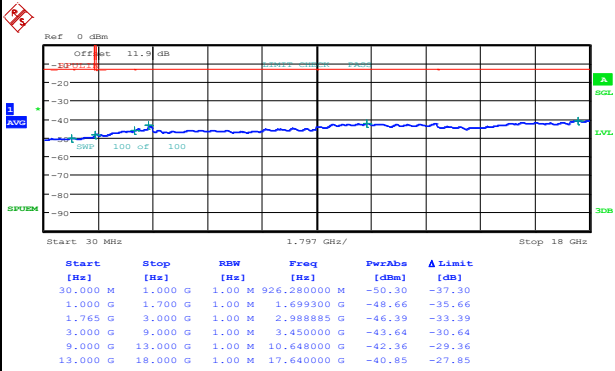

Date: 5.NOV.2014 21:10:24

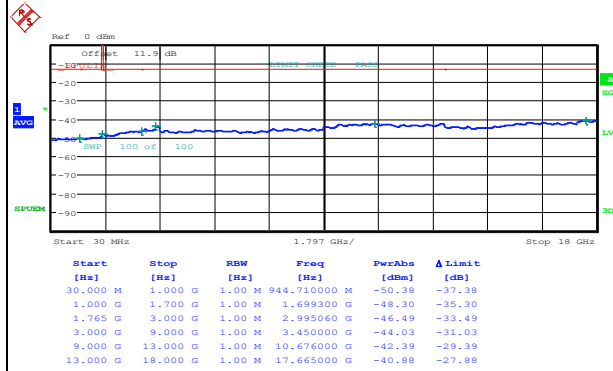

Date: 5.NOV.2014 21:11:35



LTE Band 4 / 15MHz

Highest Channel / QPSK

Highest Channel / 16QAM

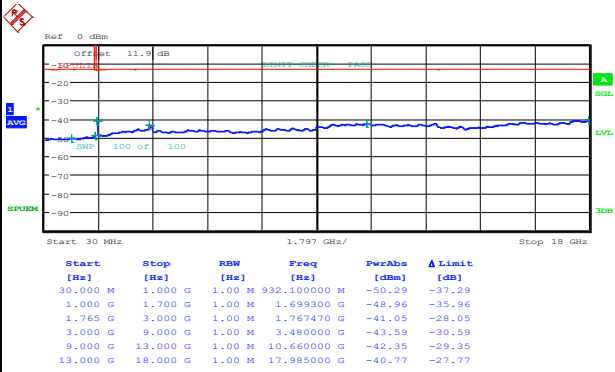

Date: 5.NOV.2014 21:18:14

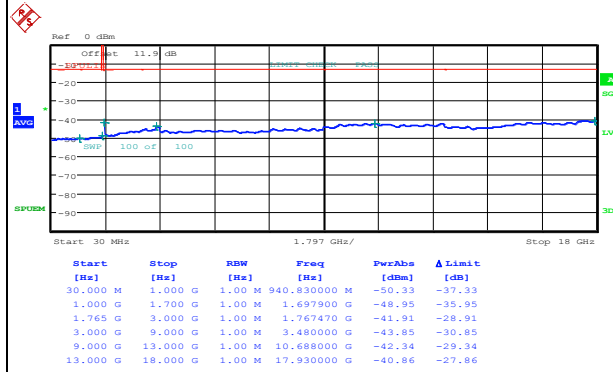

Date: 5.NOV.2014 21:19:24

LTE Band 4 / 20MHz

Lowest Channel / QPSK

Lowest Channel / 16QAM

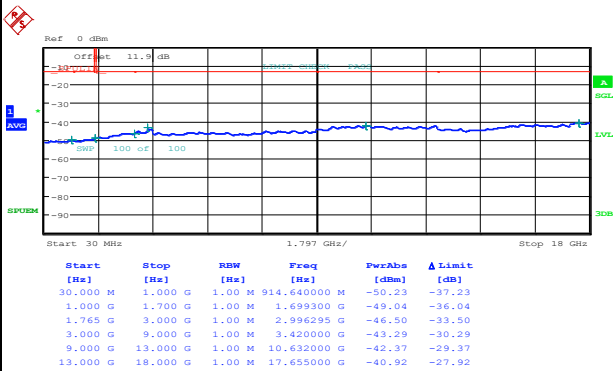

Date: 5.NOV.2014 21:26:04

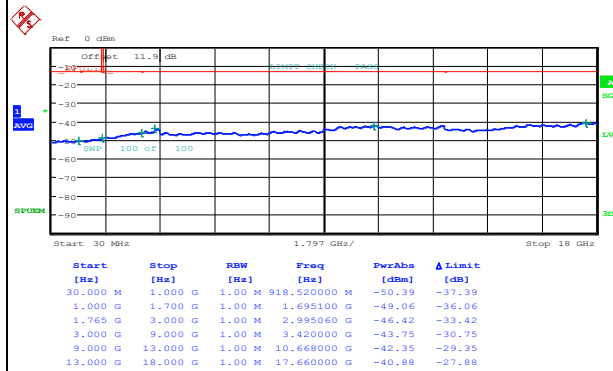

Date: 5.NOV.2014 21:27:15



LTE Band 4 / 20MHz

Middle Channel / QPSK

Middle Channel / 16QAM

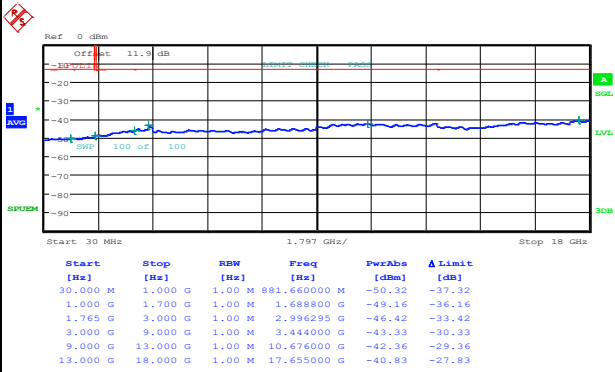

Date: 5.NOV.2014 21:29:12

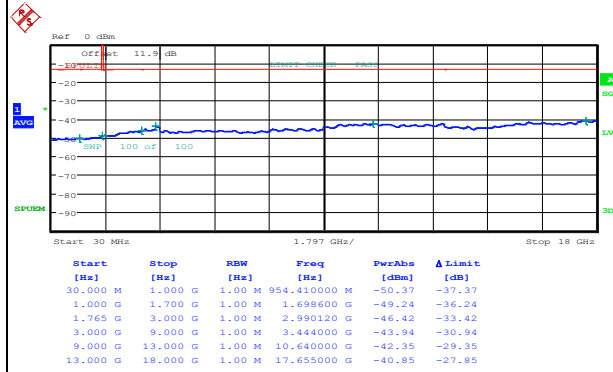

Date: 5.NOV.2014 21:30:23

Highest Channel / QPSK

Highest Channel / 16QAM

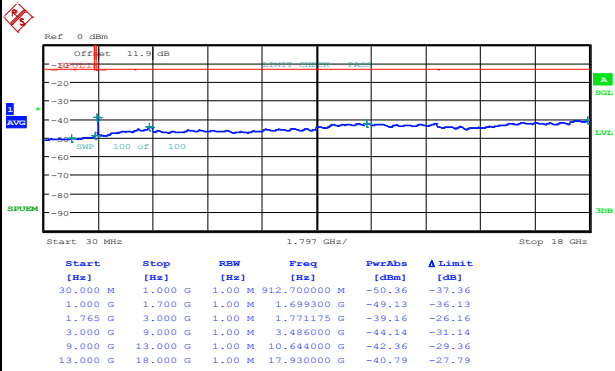

Date: 5.NOV.2014 21:37:02



Date: 5.NOV.2014 21:38:13



LTE Band 13 / 5MHz

Lowest Channel / QPSK

Lowest Channel / 16QAM

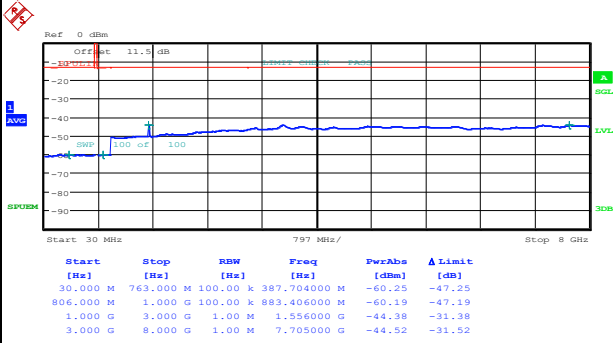

Date: 5.NOV.2014 22:52:08

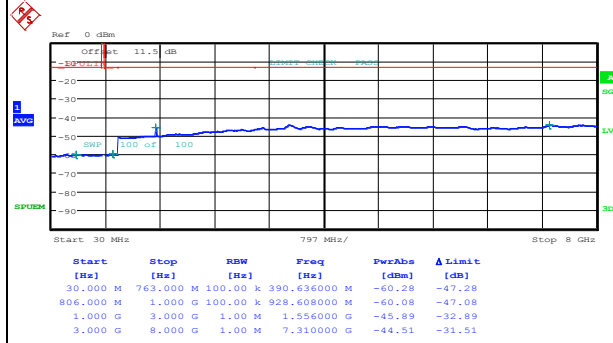

Date: 5.NOV.2014 22:53:18

Middle Channel / QPSK

Middle Channel / 16QAM

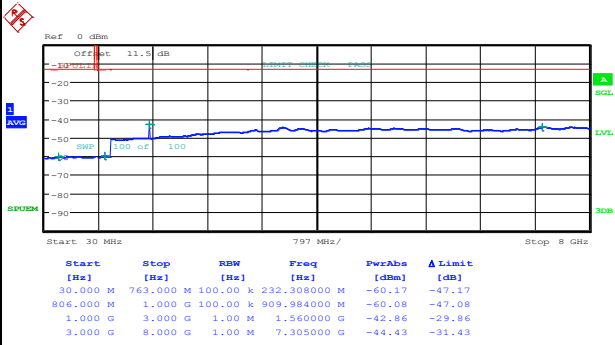

Date: 5.NOV.2014 22:55:40

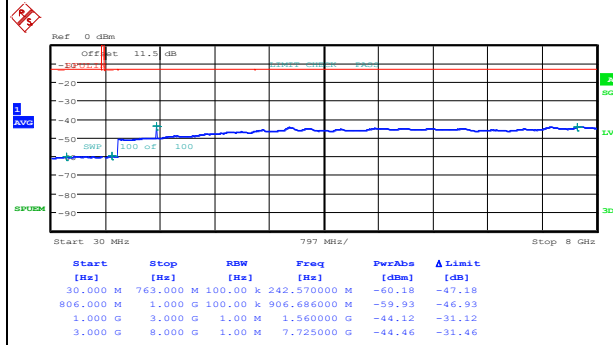

Date: 5.NOV.2014 22:54:29



LTE Band 13 / 5MHz

Highest Channel / QPSK

Highest Channel / 16QAM

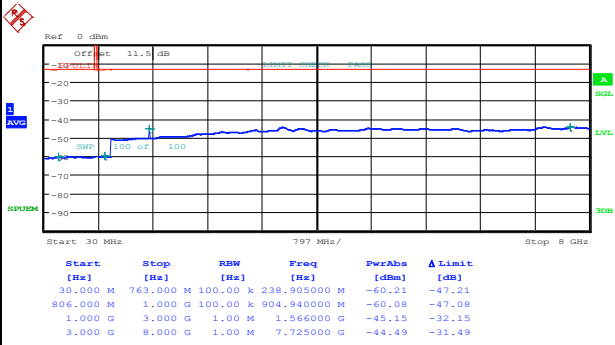

Date: 5.NOV.2014 22:58:24

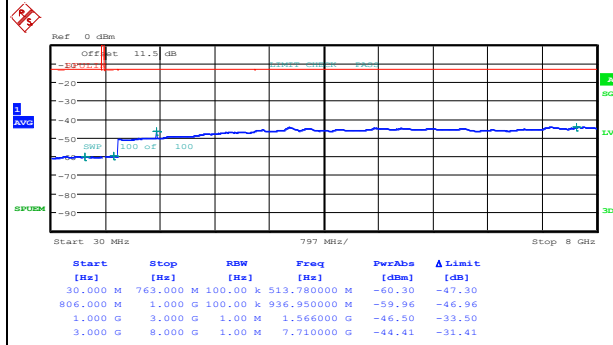

Date: 5.NOV.2014 22:59:35

LTE Band 13 / 10MHz

Middle Channel / QPSK

Middle Channel / 16QAM

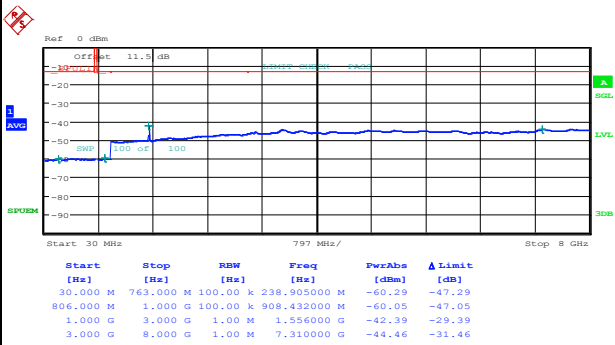

Date: 5.NOV.2014 23:02:43

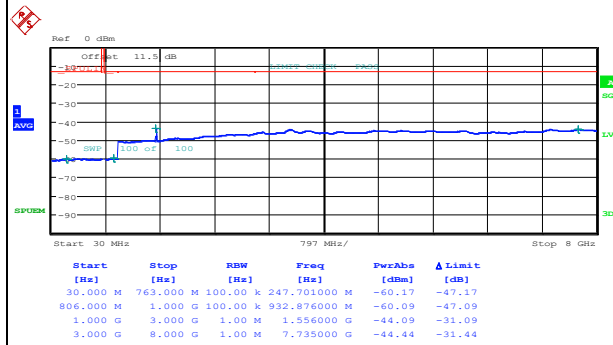

Date: 5.NOV.2014 23:01:33





**Frequency Stability**

Test Conditions		LTE Band 4 (QPSK) / Middle Channel	Limit
Temperature (°C)	Voltage (Volt)	BW 10MHz	Note 2.
		Deviation (ppm)	Result
60	Normal Voltage	0.0017	PASS
50	Normal Voltage	0.0020	
40	Normal Voltage	0.0014	
30	Normal Voltage	0.0011	
20(Ref.)	Normal Voltage	0.0000	
10	Normal Voltage	0.0009	
0	Normal Voltage	0.0003	
-10	Normal Voltage	0.0006	
-20	Normal Voltage	0.0024	
-30	Normal Voltage	0.0025	
20	Maximum Voltage	0.0029	
20	Normal Voltage	0.0000	
20	Battery End Point	0.0018	

**Note:**

1. Normal Voltage = 3.3V. ; Battery End Point (BEP) = 2.97 V. ; Maximum Voltage =3.63 V
2. Note: The frequency fundamental emissions stay within the authorized frequency block based on the frequency deviation measured is small.



Test Conditions		LTE Band 13 (QPSK) / Middle Channel	Limit
Temperature (°C)	Voltage (Volt)	BW 10MHz	Note 2.
		Deviation (ppm)	Result
60	Normal Voltage	0.0040	PASS
50	Normal Voltage	0.0004	
40	Normal Voltage	0.0101	
30	Normal Voltage	0.0143	
20(Ref.)	Normal Voltage	0.0000	
10	Normal Voltage	0.0185	
0	Normal Voltage	0.0077	
-10	Normal Voltage	0.0066	
-20	Normal Voltage	0.0205	
-30	Normal Voltage	0.0092	
20	Maximum Voltage	0.0078	
20	Normal Voltage	0.0133	
20	Battery End Point	0.0127	

**Note:**

1. Normal Voltage = 3.3V. ; Battery End Point (BEP) = 2.97 V. ; Maximum Voltage =3.63 V
2. Note: The frequency fundamental emissions stay within the authorized frequency block based on the frequency deviation measured is small.



# Appendix B. Test Results of Radiated Test

## Radiated Spurious Emission

LTE Band 4 / 1.4MHz / 16QAM / RB Size 1 Offset 0									
Channel	Frequency ( MHz )	EIRP ( dBm )	Limit ( dBm )	Over Limit ( dB )	SPA Reading (dBm)	S.G. Power ( dBm )	TX Cable loss ( dB )	TX Antenna Gain (dBi)	Polarization (H/V)
Lowest	3420	-42.25	-13	-29.25	-58.56	-48.32	1.58	7.65	H
	5128	-39.20	-13	-26.20	-59.68	-46.49	2.41	9.70	H
	6843	-38.98	-13	-25.98	-67.18	-46.95	2.64	10.61	H
	3420	-45.41	-13	-32.41	-62.84	-51.48	1.58	7.65	V
	5128	-42.92	-13	-29.92	-63.9	-50.21	2.41	9.70	V
	6843	-38.99	-13	-25.99	-66.43	-46.96	2.64	10.61	V
Middle	3462	-44.08	-13	-31.08	-60.49	-50.32	1.59	7.83	H
	5198	-36.94	-13	-23.94	-57.66	-44.19	2.45	9.70	H
	6927	-38.72	-13	-25.72	-67.3	-46.82	2.61	10.71	H
	3462	-43.95	-13	-30.95	-62.01	-50.19	1.59	7.83	V
	5198	-39.02	-13	-26.02	-60.11	-46.27	2.45	9.70	V
	6927	-39.78	-13	-26.78	-67.38	-47.88	2.61	10.71	V
Highest	3504	-42.93	-13	-29.93	-59.31	-49.33	1.61	8.00	H
	5261	-36.00	-13	-23.00	-56.77	-43.21	2.49	9.70	H
	7018	-38.97	-13	-25.97	-67.5	-47.22	2.58	10.84	H
	3504	-44.12	-13	-31.12	-61.55	-50.52	1.61	8.00	V
	5261	-40.90	-13	-27.90	-61.63	-48.11	2.49	9.70	V
	7018	-40.14	-13	-27.14	-67.85	-48.39	2.58	10.84	V

Remark: Spurious emissions within 30-1000MHz were found more than 20dB below limit line.



LTE Band 4 / 3MHz / 16QAM / RB Size 1 Offset 0									
Channel	Frequency ( MHz )	EIRP ( dBm )	Limit ( dBm )	Over Limit ( dB )	SPA Reading (dBm)	S.G. Power ( dBm )	TX Cable loss ( dB )	TX Antenna Gain (dBi)	Polarization (H/V)
Lowest	3420	-44.57	-13	-31.57	-60.87	-50.64	1.58	7.65	H
	5128	-38.83	-13	-25.83	-59.09	-46.12	2.41	9.70	H
	6843	-39.57	-13	-26.57	-67.46	-47.54	2.64	10.61	H
	3420	-45.41	-13	-32.41	-63.36	-51.48	1.58	7.65	V
	5128	-41.00	-13	-28.00	-61.23	-48.29	2.41	9.70	V
	6843	-40.36	-13	-27.36	-67.21	-48.33	2.64	10.61	V
Middle	3462	-46.93	-13	-33.93	-62.92	-53.17	1.59	7.83	H
	5191	-35.96	-13	-22.96	-57.28	-43.21	2.45	9.70	H
	6927	-38.79	-13	-25.79	-67.24	-46.89	2.61	10.71	H
	3462	-43.87	-13	-30.87	-61.46	-50.11	1.59	7.83	V
	5191	-40.98	-13	-27.98	-61.47	-48.23	2.45	9.70	V
	6827	-39.72	-13	-26.72	-67.03	-47.67	2.65	10.59	V
Highest	3504	-42.23	-13	-29.23	-58.77	-48.63	1.61	8.00	H
	5254	-34.95	-13	-21.95	-55.58	-42.17	2.48	9.70	H
	7011	-39.25	-13	-26.25	-67.87	-47.49	2.59	10.82	H
	3504	-42.82	-13	-29.82	-60.29	-49.22	1.61	8.00	V
	5254	-38.47	-13	-25.47	-59.75	-45.69	2.48	9.70	V
	7011	-39.67	-13	-26.67	-67.44	-47.91	2.59	10.82	V

LTE Band 4 / 5MHz / 16QAM / RB Size 1 Offset 0									
Channel	Frequency ( MHz )	EIRP ( dBm )	Limit ( dBm )	Over Limit ( dB )	SPA Reading (dBm)	S.G. Power ( dBm )	TX Cable loss ( dB )	TX Antenna Gain (dBi)	Polarization (H/V)
Lowest	3420	-42.62	-13	-29.62	-59.09	-48.69	1.58	7.65	H
	5128	-39.08	-13	-26.08	-59.52	-46.37	2.41	9.70	H
	6843	-38.45	-13	-25.45	-66.63	-46.42	2.64	10.61	H
	3420	-44.42	-13	-31.42	-62.28	-50.49	1.58	7.65	V
	5128	-42.10	-13	-29.10	-62.9	-49.39	2.41	9.70	V
	6843	-39.48	-13	-26.48	-66.71	-47.45	2.64	10.61	V
Middle	3462	-45.21	-13	-32.21	-61.19	-51.45	1.59	7.83	H
	5191	-35.60	-13	-22.60	-57.19	-42.85	2.45	9.70	H
	6920	-39.12	-13	-26.12	-67.28	-47.21	2.62	10.70	H
	3462	-44.03	-13	-31.03	-61.43	-50.27	1.59	7.83	V
	5191	-40.33	-13	-27.33	-61.25	-47.58	2.45	9.70	V
	6921	-39.53	-13	-26.53	-66.8	-47.62	2.62	10.71	V
Highest	3497	-41.83	-13	-28.83	-58.07	-48.21	1.60	7.99	H
	5254	-37.12	-13	-24.12	-58.3	-44.34	2.48	9.70	H
	7004	-39.00	-13	-26.00	-67.47	-47.22	2.59	10.81	H
	3497	-42.09	-13	-29.09	-60	-48.47	1.60	7.99	V
	5254	-40.64	-13	-27.64	-61.11	-47.86	2.48	9.70	V
	7004	-40.40	-13	-27.40	-68	-48.62	2.59	10.81	V

Remark: Spurious emissions within 30-1000MHz were found more than 20dB below limit line.



LTE Band 4 / 10MHz / 16QAM / RB Size 1 Offset 0									
Channel	Frequency ( MHz )	EIRP ( dBm )	Limit ( dBm )	Over Limit ( dB )	SPA Reading (dBm)	S.G. Power ( dBm )	TX Cable loss ( dB )	TX Antenna Gain (dBi)	Polarization (H/V)
Lowest	3420	-42.30	-13	-29.30	58.97	-48.37	1.58	7.65	H
	5128	-38.22	-13	-25.22	-58.72	-45.51	2.41	9.70	H
	6843	-38.26	-13	-25.26	-67.02	-46.23	2.64	10.61	H
	3420	-44.30	-13	-31.30	-61.95	-50.37	1.58	7.65	V
	5128	-42.15	-13	-29.15	-62.87	-49.44	2.41	9.70	V
	6843	-38.70	-13	-25.70	-66.05	-46.67	2.64	10.61	V
Middle	3455	-45.10	-13	-32.10	-61.48	-51.31	1.59	7.80	H
	5184	-36.93	-13	-23.93	-57.41	-44.19	2.44	9.70	H
	6913	-38.89	-13	-25.89	-67.11	-46.97	2.62	10.70	H
	3455	-44.27	-13	-31.27	-62.02	-50.48	1.59	7.80	V
	5184	-40.85	-13	-27.85	-61.8	-48.11	2.44	9.70	V
	6913	-40.55	-13	-27.55	-67.95	-48.63	2.62	10.70	V
Highest	3490	-41.84	-13	-28.84	-58.1	-48.19	1.60	7.96	H
	5233	-34.97	-13	-21.97	-55.77	-42.2	2.47	9.70	H
	6983	-38.13	-13	-25.13	-66.87	-46.31	2.60	10.78	H
	3490	-43.82	-13	-30.82	-61.28	-50.17	1.60	7.96	V
	5233	-38.96	-13	-25.96	-59.69	-46.19	2.47	9.70	V
	6983	-39.15	-13	-26.15	-66.52	-47.33	2.60	10.78	V

LTE Band 4 / 15MHz / 16QAM / RB Size 1 Offset 0									
Channel	Frequency ( MHz )	EIRP ( dBm )	Limit ( dBm )	Over Limit ( dB )	SPA Reading (dBm)	S.G. Power ( dBm )	TX Cable loss ( dB )	TX Antenna Gain (dBi)	Polarization (H/V)
Lowest	3420	-42.78	-13	-29.78	-59.24	-48.85	1.58	7.65	H
	5132	-38.88	-13	-25.88	-59.22	-46.17	2.41	9.70	H
	6843	-38.92	-13	-25.92	-67.09	-46.89	2.64	10.61	H
	3420	-45.16	-13	-32.16	-62.81	-51.23	1.58	7.65	V
	5135	-42.89	-13	-29.89	-63.23	-50.18	2.41	9.70	V
	6843	-39.64	-13	-26.64	-67.02	-47.61	2.64	10.61	V
Middle	3448	-48.06	-13	-35.06	-60.63	-54.24	1.59	7.77	H
	5177	-37.07	-13	-24.07	-57.84	-44.33	2.44	9.70	H
	6906	-39.12	-13	-26.12	-67.05	-47.19	2.62	10.69	H
	3448	-44.43	-13	-31.43	-62.28	-50.61	1.59	7.77	V
	5177	-39.56	-13	-26.56	-60.47	-46.82	2.44	9.70	V
	6906	-40.21	-13	-27.21	-67.31	-48.28	2.62	10.69	V
Highest	3483	-38.90	-13	-25.90	-55.52	-45.23	1.60	7.93	H
	5219	-34.95	-13	-21.95	-55.54	-42.19	2.46	9.70	H
	6962	-39.31	-13	-26.31	-67.83	-47.46	2.60	10.75	H
	3483	-41.03	-13	-28.03	-58.96	-47.36	1.60	7.93	V
	5219	-38.38	-13	-25.38	-59.35	-45.62	2.46	9.70	V
	6962	-39.70	-13	-26.70	-66.99	-47.85	2.60	10.75	V

Remark: Spurious emissions within 30-1000MHz were found more than 20dB below limit line.



LTE Band 4 / 20MHz / 16QAM / RB Size 1 Offset 0									
Channel	Frequency ( MHz )	EIRP ( dBm )	Limit ( dBm )	Over Limit ( dB )	SPA Reading (dBm)	S.G. Power ( dBm )	TX Cable loss ( dB )	TX Antenna Gain (dBi)	Polarization (H/V)
Lowest	3420	-42.10	-13	-29.10	-58.35	-48.17	1.58	7.65	H
	5135	-39.10	-13	-26.10	-59.27	-46.39	2.41	9.70	H
	6843	-38.50	-13	-25.50	-67.1	-46.47	2.64	10.61	H
	3420	-44.14	-13	-31.14	-61.66	-50.21	1.58	7.65	V
	5135	-42.50	-13	-29.50	-63.24	-49.79	2.41	9.70	V
	6843	-39.77	-13	-26.77	-66.78	-47.74	2.64	10.61	V
Middle	3448	-43.57	-13	-30.57	-59.93	-49.75	1.59	7.77	H
	5170	-37.92	-13	-24.92	-58.43	-45.19	2.43	9.70	H
	6892	-37.83	-13	-24.83	-66.04	-45.88	2.63	10.67	H
	3448	-45.24	-13	-32.24	-62.85	-51.42	1.59	7.77	V
	5170	-40.36	-13	-27.36	-61.12	-47.63	2.43	9.70	V
	6892	-40.12	-13	-27.12	-66.97	-48.17	2.63	10.67	V
Highest	3469	-41.90	-13	-28.90	-57.8	-48.17	1.59	7.86	H
	5205	-36.61	-13	-23.61	-57.31	-43.85	2.46	9.70	H
	6941	-39.12	-13	-26.12	-67.23	-47.24	2.61	10.73	H
	3469	-43.34	-13	-30.34	-60.83	-49.61	1.59	7.86	V
	5205	-40.15	-13	-27.15	-60.58	-47.39	2.46	9.70	V
	6941	-39.50	-13	-26.50	-66.46	-47.62	2.61	10.73	V

Remark: Spurious emissions within 30-1000MHz were found more than 20dB below limit line.



LTE Band 13 / 5MHz / 16QAM / RB Size 25 Offset 0									
Channel	Frequency ( MHz )	ERP ( dBm )	Limit ( dBm )	Over Limit ( dB )	SPA Reading (dBm)	S.G. Power ( dBm )	TX Cable loss ( dB )	TX Antenna Gain (dBi)	Polarization (H/V)
Lowest	1560	-52.32	-42.15	-10.17	-62.81	-54.36	0.94	5.13	H
	2346	-50.19	-13	-37.19	-64.86	-51.74	1.24	4.94	H
	3128	-49.73	-13	-36.73	-65.95	-52.46	1.49	6.36	H
	1560	-50.33	-42.15	-8.18	-63.24	-52.37	0.94	5.13	V
	2346	-50.00	-13	-37.00	-65.44	-51.55	1.24	4.94	V
	3128	-48.82	-13	-35.82	-66.26	-51.55	1.49	6.36	V
Middle	1568	-53.25	-42.15	-11.10	-63.73	-55.27	0.94	5.11	H
	2353	-51.56	-13	-38.56	-65.95	-53.12	1.24	4.96	H
	3138	-49.64	-13	-36.64	-65.80	-52.41	1.49	6.41	H
	1568	-51.99	-42.15	-9.84	-64.30	-54.01	0.94	5.11	V
	2353	-49.83	-13	-36.83	-65.20	-51.39	1.24	4.96	V
	3138	-47.44	-13	-34.44	-65.94	-50.21	1.49	6.41	V
Highest	1576	-53.74	-42.15	-11.59	-63.94	-55.73	0.95	5.09	H
	2361	-51.24	-13	-38.24	-65.80	-52.83	1.25	4.98	H
	3148	-50.36	-13	-37.36	-66.58	-53.17	1.49	6.45	H
	1576	-51.00	-42.15	-8.85	-64.10	-52.99	0.95	5.09	V
	2361	-49.80	-13	-36.80	-65.37	-51.39	1.25	4.98	V
	3148	-47.36	-13	-34.36	-65.42	-50.17	1.49	6.45	V

LTE Band 13 / 10MHz / 16QAM / RB Size 50 Offset 0									
Channel	Frequency ( MHz )	ERP ( dBm )	Limit ( dBm )	Over Limit ( dB )	SPA Reading (dBm)	S.G. Power ( dBm )	TX Cable loss ( dB )	TX Antenna Gain (dBi)	Polarization (H/V)
Middle	1574	-53.12	-42.15	-10.97	-63.39	-55.12	0.94	5.09	H
	2361	-50.77	-13	-37.77	-65.3	-52.36	1.25	4.98	H
	3148	-49.86	-13	-36.86	-66.1	-52.67	1.49	6.45	H
	1574	-51.71	-42.15	-9.56	-64.17	-53.71	0.94	5.09	V
	2361	-49.15	-13	-36.15	-64.67	-50.74	1.25	4.98	V
	3148	-47.98	-13	-34.98	-65.85	-50.79	1.49	6.45	V

Remark: Spurious emissions within 30-1000MHz were found more than 20dB below limit line.