



A D T

FCC TEST REPORT

REPORT NO. : RF110401C17

MODEL NO. : DE220-1-A (refer to item 3.1 for more details)

FCC ID : NKR-GDE220

RECEIVED : Apr. 01, 2011

TESTED : Apr. 07 ~ Apr. 08, 2011

ISSUED : May 04, 2011

APPLICANT : Wistron NeWeb Corp.

ADDRESS : 20 Park Avenue II, Hsinchu Science Park,
Hsinchu 308, Taiwan, R.O.C.

ISSUED BY : Bureau Veritas Consumer Products Services
(H.K.) Ltd., Taoyuan Branch

LAB ADDRESS : No. 47, 14th Ling, Chia Pau Tsuen, Lin Kou
Hsiang, Taipei Hsien 244, Taiwan, R.O.C.

TEST LOCATION : No. 19, Hwa Ya 2nd Rd, Wen Hwa Tsuen, Kwei
Shan Hsiang, Taoyuan Hsien 333, Taiwan, R.O.C.

This test report consists of 44 pages in total. It may be duplicated completely for legal use with the approval of the applicant. It should not be reproduced except in full, without the written approval of our laboratory. The client should not use it to claim product, certification, approval or endorsement by TAF or any government agency. The test results in the report only apply to the tested sample. The test results in this report are traceable to the national or international standards.





A D T

Table of Contents

RELEASE CONTROL RECORD.....	3
1. CERTIFICATION	4
2. SUMMARY OF TEST RESULTS	5
2.1 MEASUREMENT UNCERTAINTY	5
3. GENERAL INFORMATION.....	6
3.1 GENERAL DESCRIPTION OF EUT	6
3.2 DESCRIPTION OF TEST MODES.....	7
3.2.1 CONFIGURATION OF SYSTEM UNDER TEST	7
3.2.2 TEST MODE APPLICABILITY AND TESTED CHANNEL DETAIL	8
3.3 GENERAL DESCRIPTION OF APPLIED STANDARDS	9
3.4 DESCRIPTION OF SUPPORT UNITS	9
4. TEST TYPES AND RESULTS	10
4.1 RADIATED EMISSION MEASUREMENT	10
4.1.1 LIMITS OF RADIATED EMISSION MEASUREMENT.....	10
4.1.2 TEST INSTRUMENTS	11
4.1.3 TEST PROCEDURES	12
4.1.4 DEVIATION FROM TEST STANDARD	12
4.1.5 TEST SETUP	13
4.1.6 EUT OPERATING CONDITIONS	13
4.1.7 TEST RESULTS	14
4.2 CONDUCTED EMISSION MEASUREMENT	29
4.2.1 LIMITS OF CONDUCTED EMISSION MEASUREMENT.....	29
4.2.2 TEST INSTRUMENTS	29
4.2.3 TEST PROCEDURES	30
4.2.4 DEVIATION FROM TEST STANDARD	30
4.2.5 TEST SETUP	31
4.2.6 EUT OPERATING CONDITIONS	31
4.2.7 TEST RESULTS	32
4.3 BAND EDGES MEASUREMENT	38
4.3.1 LIMITS OF BAND EDGES MEASUREMENT	38
4.3.2 TEST INSTRUMENTS	38
4.3.3 TEST PROCEDURE	38
4.3.4 DEVIATION FROM TEST STANDARD	38
4.3.5 EUT OPERATING CONDITION	38
4.3.6 TEST RESULTS	39
5. PHOTOGRAPHS OF THE TEST CONFIGURATION.....	42
6. INFORMATION ON THE TESTING LABORATORIES	43
7. APPENDIX A - MODIFICATIONS RECORDERS FOR ENGINEERING CHANGES TO THE EUT BY THE LAB.....	44



A D T

RELEASE CONTROL RECORD

ISSUE NO.	REASON FOR CHANGE	DATE ISSUED
Original release	NA	May 04, 2011



A D T

1. CERTIFICATION

PRODUCT: In-Home-Display

MODEL NO.: DE220-1-A (refer to item 3.1 for more details)

BRAND: greenWAVE REALITY

APPLICANT: Wistron NeWeb Corp.

TESTED: Apr. 07 ~ Apr. 08, 2011

TEST SAMPLE: ENGINEERING SAMPLE

STANDARDS: FCC Part 15, Subpart C (Section 15.249)

ANSI C63.4-2003

ANSI C63.10-2009

The above equipment (model: DE220-1-A) have been tested by **Bureau Veritas Consumer Products Services (H.K.) Ltd., Taoyuan Branch**, and found compliance with the requirement of the above standards. The test record, data evaluation & Equipment Under Test (EUT) configurations represented herein are true and accurate accounts of the measurements of the sample's EMC characteristics under the conditions specified in this report.

PREPARED BY :  , DATE : May 04, 2011
Polly Chien / Specialist

APPROVED BY :  , DATE : May 04, 2011
Gary Chang / Assistant Manager



2. SUMMARY OF TEST RESULTS

The EUT has been tested according to the following specifications:

APPLIED STANDARD: FCC Part 15, Subpart C (Section 15.249)			
STANDARD PARAGRAPH	TEST TYPE	RESULT	REMARK
15.207	Conducted Emission Test	PASS	Meet the requirement of limit. Minimum passing margin is -21.57dB at 0.276MHz.
15.209 15.249 15.249 (d)	Radiated Emission Test Band Edge Measurement Limit: 50dB less than the peak value of fundamental frequency or meet radiated emission limit in section 15.209	PASS	Meet the requirement of limit. Minimum passing margin is -0.6dB at 8175.78MHz.

2.1 MEASUREMENT UNCERTAINTY

Where relevant, the following measurement uncertainty levels have been estimated for tests performed on the EUT as specified in CISPR 16-4-2:

MEASUREMENT	FREQUENCY	UNCERTAINTY
Conducted emissions	9kHz~30MHz	2.44 dB
Radiated emissions	30MHz ~ 200MHz	3.19 dB
	200MHz ~1000MHz	3.21 dB
	1GHz ~ 18GHz	2.26 dB
	18GHz ~ 40GHz	1.94 dB

This uncertainty represents an expanded uncertainty expressed at approximately the 95% confidence level using a coverage factor of k=2.



3. GENERAL INFORMATION

3.1 GENERAL DESCRIPTION OF EUT

EUT	In-Home-Display
MODEL NO.	DE220-1-A (refer to NOTE for more details)
FCC ID	NKR-GDE220
POWER SUPPLY	5.0Vdc, 0.55A (for adapter) 6Vdc, 2200mAh (for non-rechargeable battery, type: Alkaline)
MODULATION TYPE	2 Frequency Shift Keying (2FSK) (9.6kbpps) 2 Gaussian Frequency Shift Keying (2GFSK) (40kbps/100kbps)
OPERATING FREQUENCY	908.42MHz, 908.4MHz, 916MHz
NUMBER OF CHANNEL	3
DATA CABLE	NA
I/O PORT	NA
ACCESSORY DEVICES	Adapter

NOTE:

- The following models are electrically identical, different model names are for marketing purpose.

BRAND	MODEL	DESCRIPTION
greenWAVE REALITY	DE220-1-A	Main test model, EUT with power adapter.
	DE220-1	EUT with battery only.
	DE220-X-A	X can be 1, 10 and 12. For marketing purpose.

- The EUT was powered by the following adapter:

BRAND:	Ktec
MODEL:	KSAS0060500055VUD
INPUT:	100-240Vac~, 50/60Hz, 0.18A
OUTPUT:	5.0Vdc, 0.55A
POWER LINE:	DC: 1.51m non-shielded cable without core

- The above EUT information is declared by the manufacturer and for more detailed features description, please refer to the manufacturer's specifications or User's Manual.

3.2 DESCRIPTION OF TEST MODES

3 channels are provided to this EUT.

CHANNEL	FREQ. (MHz)
1	908.42
2	908.40
3	916.00

3.2.1 CONFIGURATION OF SYSTEM UNDER TEST

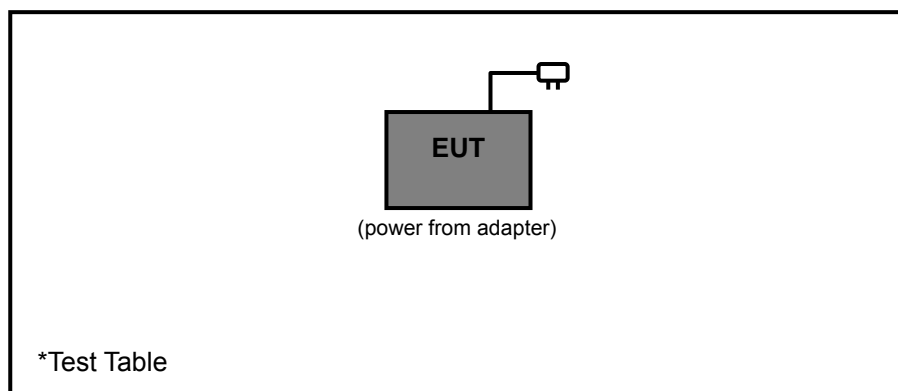



3.2.2 TEST MODE APPLICABILITY AND TESTED CHANNEL DETAIL

EUT CONFIGURE MODE	APPLICABLE TO				DESCRIPTION
	RE≥1G	RE<1G	PLC	BM	
-	√	√	√	√	-

Where **PLC**: Power Line Conducted Emission
RE≥1G: Radiated Emission above 1GHz

RE<1G: Radiated Emission below 1GHz
BM: Bandedge Measurement

RADIATED EMISSION TEST (ABOVE 1 GHz):

- Pre-Scan has been conducted to determine the worst-case mode from all possible combinations between available modulations, XYZ axis and antenna ports (if EUT with antenna diversity architecture).
- Following channel(s) was (were) selected for the final test as listed below.

TESTED CHANNEL	OPERATING FREQUENCY	MODULATION TYPE	AXIS
1	908.42MHz	2FSK	Z
2	908.40MHz	2GFSK	Z
3	916.00MHz	2GFSK	Z

RADIATED EMISSION TEST (BELOW 1 GHz):

- Pre-Scan has been conducted to determine the worst-case mode from all possible combinations between available modulations, XYZ axis and antenna ports (if EUT with antenna diversity architecture).
- Following channel(s) was (were) selected for the final test as listed below.

TESTED CHANNEL	OPERATING FREQUENCY	MODULATION TYPE	AXIS
1	908.42MHz	2FSK	Z
2	908.40MHz	2GFSK	Z
3	916.00MHz	2GFSK	Z

POWER LINE CONDUCTED EMISSION TEST:

- Pre-Scan has been conducted to determine the worst-case mode from all possible combinations between available modulations and antenna ports (if EUT with antenna diversity architecture).
- Following channel(s) was (were) selected for the final test as listed below.

TESTED CHANNEL	OPERATING FREQUENCY	MODULATION TYPE
1	908.42MHz	2FSK
2	908.40MHz	2GFSK
3	916.00MHz	2GFSK

BANDEDGE MEASUREMENT:

- Pre-Scan has been conducted to determine the worst-case mode from all possible combinations between available modulations and antenna ports (if EUT with antenna diversity architecture).
- Following channel(s) was (were) selected for the final test as listed below.

TESTED CHANNEL	OPERATING FREQUENCY	MODULATION TYPE
1	908.42MHz	2FSK
2	908.40MHz	2GFSK
3	916.00MHz	2GFSK

TEST CONDITION:

APPLICABLE TO	ENVIRONMENTAL CONDITIONS	INPUT POWER	TESTED BY
RE \geq 1G	25deg. C, 65%RH, 1012 hPa	120Vac, 60Hz	Frank Wang
RE $<$ 1G	25deg. C, 65%RH, 1012 hPa	120Vac, 60Hz	Frank Wang
PLC	20deg. C, 60%RH, 1009 hPa	120Vac, 60Hz	Match Tsui
BM	25deg. C, 65%RH, 1012 hPa	120Vac, 60Hz	Frank Wang

3.3 GENERAL DESCRIPTION OF APPLIED STANDARDS

The EUT is a RF Product. According to the specifications of the manufacturer, it must comply with the requirements of the following standards:

FCC Part 15, Subpart C (Section 15.249)

ANSI C63.4-2003

ANSI C63.10-2009

All test items have been performed and recorded as per the above standards.

NOTE: The EUT is also considered as a kind of computer peripheral, because the connection to computer is necessary for typical use. It has been verified to comply with the requirements of FCC Part 15, Subpart B, Class B (DoC). The test report has been issued separately.

3.4 DESCRIPTION OF SUPPORT UNITS

The EUT has been tested as an independent unit.

4. TEST TYPES AND RESULTS

4.1 RADIATED EMISSION MEASUREMENT

4.1.1 LIMITS OF RADIATED EMISSION MEASUREMENT

Emissions radiated outside of the specified bands, shall be according to the general radiated limits in 15.209, 15.249 as following:

15.209 Limit		
Frequencies (MHz)	Field strength (microvolts/meter)	Measurement distance (meters)
0.009 ~ 0.490	2400/F(kHz)	300
0.490 ~ 1.705	24000/F(kHz)	30
1.705 ~ 30.0	30	30
30 ~ 88	100	3
88 ~ 216	150	3
216 ~ 960	200	3
Above 960	500	3
15.249 Limit		
Fundamental Frequency	Field Strength of Fundamental (millivolts/meter)	Field Strength of Harmonics (microvolts/meter)
902 ~ 928 MHz	50	500
2400 ~ 2483.5 MHz	50	500
5725 ~ 5875 MHz	50	500
24 ~ 24.25 GHz	250	2500

NOTE:

1. The lower limit shall apply at the transition frequencies.
2. Emission level (dBuV/m) = 20 log Emission level (uV/m).
3. As shown in 15.35(b), for frequencies above 1000MHz, the field strength limits are based on average detector, however, the peak field strength of any emission shall not exceed the maximum permitted average limits, specified above by more than 20dB under any condition of modulation.

4.1.2 TEST INSTRUMENTS

DESCRIPTION & MANUFACTURER	MODEL NO.	SERIAL NO.	DATE OF CALIBRATION	DUE DATE OF CALIBRATION
Test Receiver ROHDE & SCHWARZ	ESI7	838496/016	Dec. 27, 2010	Dec. 26, 2011
Spectrum Analyzer ROHDE & SCHWARZ	FSU43	100115	Aug. 02, 2010	Aug. 01, 2011
BILOG Antenna SCHWARZBECK	VULB9168	9168-156	Apr. 30, 2010	Apr. 29, 2011
HORN Antenna SCHWARZBECK	BBHA 9120D	9120D-408	Jan. 06, 2011	Jan. 05, 2012
HORN Antenna SCHWARZBECK	BBHA 9170	BBHA9170243	Dec. 27, 2010	Dec. 26, 2011
Preamplifier Agilent	8449B	3008A01961	Nov. 02, 2010	Nov. 01, 2011
Preamplifier Agilent	8447D	2944A10738	Nov. 02, 2010	Nov. 01, 2011
RF signal cable HUBER+SUHNNER	SUCOFLEX 104	274041/4	Aug. 21, 2010	Aug. 20, 2011
RF signal cable HUBER+SUHNNER	SUCOFLEX 104	283397/4	Aug. 21, 2010	Aug. 20, 2011
Software ADT.	ADT_Radiated_ V7.6.15.9.2	NA	NA	NA
Antenna Tower inn-co GmbH	MA 4000	010303	NA	NA
Antenna Tower Controller inn-co GmbH	CO2000	019303	NA	NA
Turn Table ADT.	TT100.	TT93021704	NA	NA
Turn Table Controller ADT.	SC100.	SC93021704	NA	NA

- NOTE:**
1. The calibration interval of the above test instruments is 12 months and the calibrations are traceable to NML/ROC and NIST/USA.
 2. The test was performed in HwaYa Chamber 4.
 3. The horn antenna and HP preamplifier (model: 8449B) are used only for the measurement of emission frequency above 1GHz if tested.
 4. The FCC Site Registration No. is 988962.
 5. The IC Site Registration No. is IC7450F-4.

4.1.3 TEST PROCEDURES

- a. The EUT was placed on the top of a rotating table 0.8 meters above the ground at a 3 meter semi-anechoic chamber. The table was rotated 360 degrees to determine the position of the highest radiation.
- b. The EUT was set 3 meters away from the interference-receiving antenna, which was mounted on the top of a variable-height antenna tower.
- c. The antenna is a broadband antenna, and its height is varied from one meter to four meters above the ground to determine the maximum value of the field strength. Both horizontal and vertical polarizations of the antenna are set to make the measurement.
- d. For each suspected emission, the EUT was arranged to its worst case and then the antenna was tuned to heights from 1 meter to 4 meters and the rotatable table was turned from 0 degrees to 360 degrees to find the maximum reading.
- e. The test-receiver system was set to Peak Detect Function and Specified Bandwidth with Maximum Hold Mode.
- f. If the emission level of the EUT in peak mode was lower than the limit specified, then testing could be stopped and the peak values of the EUT would be reported. Otherwise the emissions would be re-tested one by one using peak, quasi-peak or average method as specified and then reported in a data sheet.

NOTE:

1. The resolution bandwidth and video bandwidth of test receiver/spectrum analyzer is 120kHz for Quasi-peak detection at frequency below 1GHz.
2. The resolution bandwidth of test receiver/spectrum analyzer is 1MHz and video bandwidth is 3MHz for Peak detection at frequency above 1GHz.
3. All modes of operation were investigated and the worst-case emissions are reported.

4.1.4 DEVIATION FROM TEST STANDARD

No deviation.

4.1.5 TEST SETUP

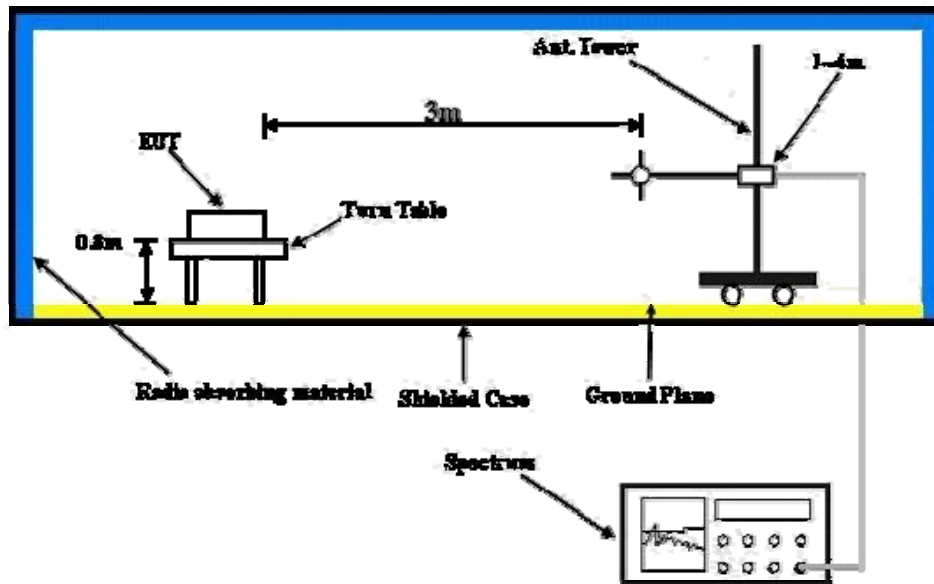

For the actual test configuration, please refer to the attached file (Test Setup Photo).

4.1.6 EUT OPERATING CONDITIONS

- a. Placed the EUT on a testing table.
- b. Set the transmitter part of EUT under transmission condition continuously at specific channel frequency.
- c. The necessary accessories enable the EUT in full functions.



4.1.7 TEST RESULTS

For 908.42 MHz

EUT TEST CONDITION		MEASUREMENT DETAIL	
CHANNEL	Channel 1 (908.42MHz)	FREQUENCY RANGE	Below 1000MHz
INPUT POWER	120Vac, 60 Hz	DETECTOR FUNCTION	Quasi-Peak
ENVIRONMENTAL CONDITIONS	25deg. C, 65%RH 1012 hPa	TESTED BY	Frank Wang

ANTENNA POLARITY & TEST DISTANCE: HORIZONTAL AT 3 M								
NO.	FREQ. (MHz)	EMISSION LEVEL (dBuV/m)	LIMIT (dBuV/m)	MARGIN (dB)	ANTENNA HEIGHT (m)	TABLE ANGLE (Degree)	RAW VALUE (dBuV)	CORRECTION FACTOR (dB/m)
1	*908.42	89.5 QP	94.0	-4.5	1.52 H	156	60.7	28.8
ANTENNA POLARITY & TEST DISTANCE: VERTICAL AT 3 M								
NO.	FREQ. (MHz)	EMISSION LEVEL (dBuV/m)	LIMIT (dBuV/m)	MARGIN (dB)	ANTENNA HEIGHT (m)	TABLE ANGLE (Degree)	RAW VALUE (dBuV)	CORRECTION FACTOR (dB/m)
1	*908.42	84.4 QP	94.0	-9.6	1.10 V	38	55.6	28.8

- REMARKS:**
1. Emission level (dBuV/m) = Raw Value (dBuV) + Correction Factor (dB/m).
 2. Correction Factor (dB/m) = Antenna Factor (dB/m) + Cable Factor (dB).
 3. The other emission levels were very low against the limit.
 4. Margin value = Emission level – Limit value.
 5. “ * “ : Fundamental frequency
 6. The average value of fundamental frequency is: Average = Peak value + 20log(Duty cycle) Where the duty factor is calculated from following formula:
 $20 \log (\text{Duty cycle}) = 20 \log (43 \text{ ms} / 100 \text{ ms}) = -7.3 \text{ dB}$

Please see page 18 for plotted duty.



A D T

ABOVE 1GHz DATA

EUT TEST CONDITION		MEASUREMENT DETAIL	
CHANNEL	Channel 1 (908.42MHz)	FREQUENCY RANGE	1 ~ 25GHz
INPUT POWER	120Vac, 60Hz	DETECTOR FUNCTION	Peak (PK) Average (AV)
ENVIRONMENTAL CONDITIONS	25deg. C, 65%RH 1012 hPa	TESTED BY	Frank Wang

ANTENNA POLARITY & TEST DISTANCE: HORIZONTAL AT 3 M								
NO.	FREQ. (MHz)	EMISSION LEVEL (dBuV/m)	LIMIT (dBuV/m)	MARGIN (dB)	ANTENNA HEIGHT (m)	TABLE ANGLE (Degree)	RAW VALUE (dBuV)	CORRECTION FACTOR (dB/m)
1	1816.84	39.9 PK	74.0	-34.1	1.05 H	168	10.50	29.40
2	1816.84	32.6 AV	54.0	-21.4	1.05 H	168	3.20	29.40
3	2725.26	54.6 PK	74.0	-19.4	1.10 H	102	22.50	32.10
4	2725.26	47.3 AV	54.0	-6.7	1.10 H	102	15.20	32.10
5	3633.68	50.4 PK	74.0	-23.6	1.30 H	54	16.40	34.00
6	3633.68	43.1 AV	54.0	-10.9	1.30 H	54	9.10	34.00
7	4542.10	51.4 PK	74.0	-22.6	1.53 H	108	14.90	36.50
8	4542.10	44.1 AV	54.0	-9.9	1.53 H	108	7.60	36.50
9	6358.94	52.1 PK	74.0	-21.9	1.50 H	154	11.40	40.70
10	6358.94	44.8 AV	54.0	-9.2	1.50 H	154	4.10	40.70
11	8175.78	58.6 PK	74.0	-15.4	1.36 H	305	13.60	45.00
12	8175.78	51.3 AV	54.0	-2.7	1.36 H	305	6.30	45.00

- REMARKS:**
1. Emission level (dBuV/m) = Raw Value (dBuV) + Correction Factor (dB/m).
 2. Correction Factor (dB/m) = Antenna Factor (dB/m) + Cable Factor (dB).
 3. The other emission levels were very low against the limit.
 4. Margin value = Emission level – Limit value.
 5. The average value of fundamental frequency is: Average = Peak value + 20log(Duty cycle) Where the duty factor is calculated from following formula:
 $20 \log (\text{Duty cycle}) = 20 \log (43 \text{ ms} / 100 \text{ ms}) = -7.3 \text{ dB}$

Please see page 18 for plotted duty.



A D T

EUT TEST CONDITION		MEASUREMENT DETAIL	
CHANNEL	Channel 1 (908.42MHz)	FREQUENCY RANGE	1 ~ 25GHz
INPUT POWER	120Vac, 60Hz	DETECTOR FUNCTION	Peak (PK) Average (AV)
ENVIRONMENTAL CONDITIONS	25deg. C, 65%RH 1012 hPa	TESTED BY	Frank Wang

ANTENNA POLARITY & TEST DISTANCE: VERTICAL AT 3 M								
NO.	FREQ. (MHz)	EMISSION LEVEL (dBuV/m)	LIMIT (dBuV/m)	MARGIN (dB)	ANTENNA HEIGHT (m)	TABLE ANGLE (Degree)	RAW VALUE (dBuV)	CORRECTION FACTOR (dB/m)
1	1816.84	47.6 PK	74.0	-26.4	1.24 V	185	18.20	29.40
2	1816.84	40.3 AV	54.0	-13.7	1.24 V	185	10.90	29.40
3	2725.26	53.8 PK	74.0	-20.2	1.28 V	175	21.70	32.10
4	2725.26	46.5 AV	54.0	-7.5	1.28 V	175	14.40	32.10
5	3633.68	52.9 PK	74.0	-21.1	1.18 V	174	18.90	34.00
6	3633.68	45.6 AV	54.0	-8.4	1.18 V	174	11.60	34.00
7	4542.10	54.6 PK	74.0	-19.4	1.17 V	40	18.10	36.50
8	4542.10	47.3 AV	54.0	-6.7	1.17 V	40	10.80	36.50
9	6358.94	54.4 PK	74.0	-19.6	1.12 V	36	13.70	40.70
10	6358.94	47.1 AV	54.0	-6.9	1.12 V	36	6.40	40.70
11	8175.78	60.7 PK	74.0	-13.3	1.03 V	170	15.70	45.00
12	8175.78	53.4 AV	54.0	-0.6	1.03 V	170	8.40	45.00

- REMARKS:** 1. Emission level (dBuV/m) = Raw Value (dBuV) + Correction Factor (dB/m).
2. Correction Factor (dB/m) = Antenna Factor (dB/m) + Cable Factor (dB).
3. The other emission levels were very low against the limit.
4. Margin value = Emission level – Limit value.
5. The average value of fundamental frequency is: Average = Peak value + 20log(Duty cycle) Where the duty factor is calculated from following formula:
20 log (Duty cycle) = 20 log (43 ms / 100 ms) = -7.3 dB

Please see page 18 for plotted duty.



A D T

BELOW 1GHz WORST-CASE DATA

EUT TEST CONDITION		MEASUREMENT DETAIL	
CHANNEL	Channel 1 (908.42MHz)	FREQUENCY RANGE	Below 1000MHz
INPUT POWER	120Vac, 60Hz	DETECTOR FUNCTION	Quasi-Peak
ENVIRONMENTAL CONDITIONS	25deg. C, 65%RH 1012 hPa	TESTED BY	Frank Wang

ANTENNA POLARITY & TEST DISTANCE: HORIZONTAL AT 3 M								
NO.	FREQ. (MHz)	EMISSION LEVEL (dBuV/m)	LIMIT (dBuV/m)	MARGIN (dB)	ANTENNA HEIGHT (m)	TABLE ANGLE (Degree)	RAW VALUE (dBuV)	CORRECTION FACTOR (dB/m)
1	506.25	19.9 QP	46.0	-26.1	1.50 H	298	-1.60	21.50
2	634.57	22.7 QP	46.0	-23.3	1.50 H	226	-1.50	24.20
3	702.62	23.0 QP	46.0	-23.0	1.50 H	157	-2.10	25.10
4	760.95	23.9 QP	46.0	-22.1	2.25 H	310	-2.60	26.50
5	902.00	27.0 QP	46.0	-19.0	1.75 H	10	-1.70	28.70
6	928.00	26.6 QP	46.0	-19.4	1.00 H	298	-2.40	29.00
ANTENNA POLARITY & TEST DISTANCE: VERTICAL AT 3 M								
NO.	FREQ. (MHz)	EMISSION LEVEL (dBuV/m)	LIMIT (dBuV/m)	MARGIN (dB)	ANTENNA HEIGHT (m)	TABLE ANGLE (Degree)	RAW VALUE (dBuV)	CORRECTION FACTOR (dB/m)
1	504.31	20.0 QP	46.0	-26.0	1.25 V	247	-1.50	21.50
2	644.30	22.5 QP	46.0	-23.5	1.00 V	226	-1.80	24.30
3	751.23	23.7 QP	46.0	-22.3	2.00 V	178	-2.50	26.20
4	829.00	25.4 QP	46.0	-20.6	1.25 V	343	-2.40	27.80
5	902.00	26.8 QP	46.0	-19.2	2.00 V	154	-1.90	28.70
6	928.00	26.5 QP	46.0	-19.5	1.50 V	76	-2.50	29.00

- REMARKS:**
1. Emission level (dBuV/m) = Raw Value (dBuV) + Correction Factor (dB/m).
 2. Correction Factor (dB/m) = Antenna Factor (dB/m) + Cable Factor (dB).
 3. The other emission levels were very low against the limit.
 4. Margin value = Emission level – Limit value.



A D T

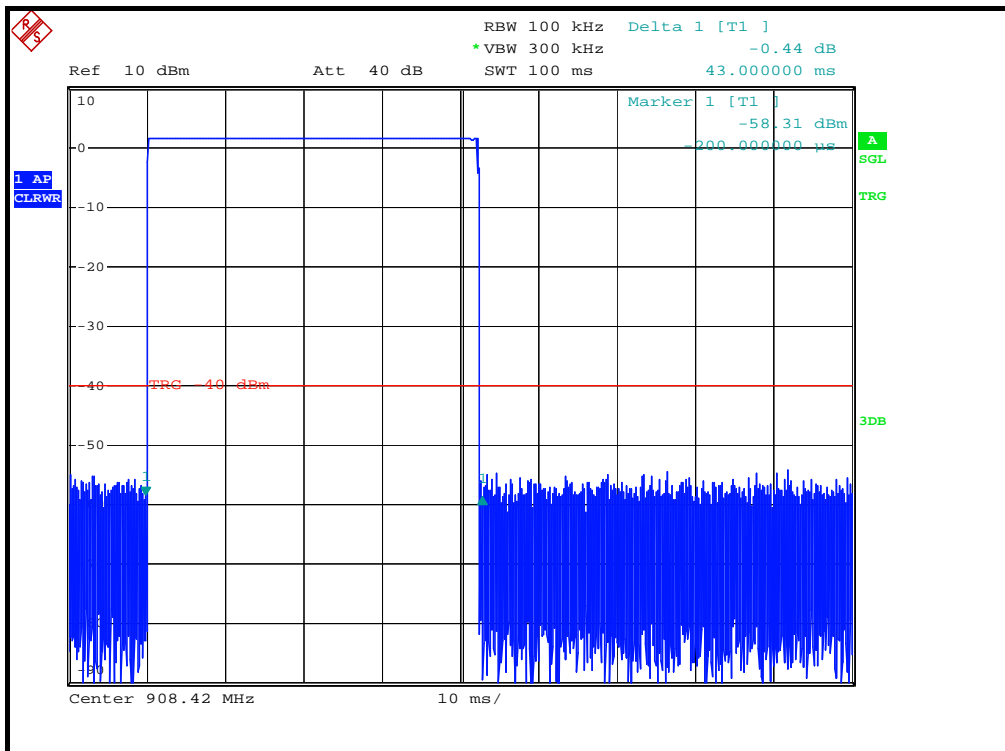

$$20 \log (\text{Duty cycle}) = 20 \log (43\text{ms} / 100 \text{ms}) = -7.3\text{dB}$$



A D T

For 908.40 MHz

EUT TEST CONDITION		MEASUREMENT DETAIL	
CHANNEL	Channel 2 (908.40MHz)	FREQUENCY RANGE	Below 1000MHz
INPUT POWER	120Vac, 60 Hz	DETECTOR FUNCTION	Quasi-Peak
ENVIRONMENTAL CONDITIONS	25deg. C, 65%RH 1012 hPa	TESTED BY	Frank Wang

ANTENNA POLARITY & TEST DISTANCE: HORIZONTAL AT 3 M								
NO.	FREQ. (MHz)	EMISSION LEVEL (dBuV/m)	LIMIT (dBuV/m)	MARGIN (dB)	ANTENNA HEIGHT (m)	TABLE ANGLE (Degree)	RAW VALUE (dBuV)	CORRECTION FACTOR (dB/m)
1	*908.40	80.4 QP	94.0	-13.6	1.60 H	332	51.6	28.8
ANTENNA POLARITY & TEST DISTANCE: VERTICAL AT 3 M								
NO.	FREQ. (MHz)	EMISSION LEVEL (dBuV/m)	LIMIT (dBuV/m)	MARGIN (dB)	ANTENNA HEIGHT (m)	TABLE ANGLE (Degree)	RAW VALUE (dBuV)	CORRECTION FACTOR (dB/m)
1	*908.40	72.0 QP	94.0	-22.0	1.00 V	2	43.2	28.8

- REMARKS:**
1. Emission level (dBuV/m) = Raw Value (dBuV) + Correction Factor (dB/m).
 2. Correction Factor (dB/m) = Antenna Factor (dB/m) + Cable Factor (dB).
 3. The other emission levels were very low against the limit.
 4. Margin value = Emission level – Limit value.
 5. “ * “ : Fundamental frequency
 6. The average value of fundamental frequency is: Average = Peak value + 20log(Duty cycle) Where the duty factor is calculated from following formula:
 $20 \log (\text{Duty cycle}) = 20 \log (14.88 \text{ ms} / 100 \text{ ms}) = -16.5 \text{ dB}$

Please see page 23 for plotted duty.



ABOVE 1GHz DATA

EUT TEST CONDITION		MEASUREMENT DETAIL	
CHANNEL	Channel 2 (908.40MHz)	FREQUENCY RANGE	1 ~ 25GHz
INPUT POWER	120Vac, 60Hz	DETECTOR FUNCTION	Peak (PK) Average (AV)
ENVIRONMENTAL CONDITIONS	25deg. C, 65%RH 1012 hPa	TESTED BY	Frank Wang

ANTENNA POLARITY & TEST DISTANCE: HORIZONTAL AT 3 M								
NO.	FREQ. (MHz)	EMISSION LEVEL (dBuV/m)	LIMIT (dBuV/m)	MARGIN (dB)	ANTENNA HEIGHT (m)	TABLE ANGLE (Degree)	RAW VALUE (dBuV)	CORRECTION FACTOR (dB/m)
1	1816.80	41.2 PK	74.0	-32.8	1.38 H	336	11.80	29.40
2	1816.80	24.7 AV	54.0	-29.3	1.38 H	336	-4.70	29.40
3	2725.20	56.5 PK	74.0	-17.5	1.14 H	310	24.40	32.10
4	2725.20	40.0 AV	54.0	-14.0	1.14 H	310	7.90	32.10
5	3633.60	50.8 PK	74.0	-23.2	1.32 H	236	16.80	34.00
6	3633.60	34.3 AV	54.0	-19.7	1.32 H	236	0.30	34.00
7	4542.00	51.9 PK	74.0	-22.1	1.32 H	48	15.40	36.50
8	4542.00	35.4 AV	54.0	-18.6	1.32 H	48	-1.10	36.50
9	6358.80	53.2 PK	74.0	-20.8	1.42 H	308	12.50	40.70
10	6358.80	36.7 AV	54.0	-17.3	1.42 H	308	-4.00	40.70
11	8175.60	57.5 PK	74.0	-16.5	1.37 H	252	12.50	45.00
12	8175.60	41.0 AV	54.0	-13.0	1.37 H	252	-4.00	45.00

- REMARKS:**
1. Emission level (dBuV/m) = Raw Value (dBuV) + Correction Factor (dB/m).
 2. Correction Factor (dB/m) = Antenna Factor (dB/m) + Cable Factor (dB).
 3. The other emission levels were very low against the limit.
 4. Margin value = Emission level – Limit value.
 5. The average value of fundamental frequency is: Average = Peak value + 20log(Duty cycle) Where the duty factor is calculated from following formula:
 $20 \log (\text{Duty cycle}) = 20 \log (14.88 \text{ ms} / 100 \text{ ms}) = -16.5 \text{ dB}$

Please see page 23 for plotted duty.



A D T

EUT TEST CONDITION		MEASUREMENT DETAIL	
CHANNEL	Channel 2 (908.40MHz)	FREQUENCY RANGE	1 ~ 25GHz
INPUT POWER	120Vac, 60Hz	DETECTOR FUNCTION	Peak (PK) Average (AV)
ENVIRONMENTAL CONDITIONS	25deg. C, 65%RH 1012 hPa	TESTED BY	Frank Wang

ANTENNA POLARITY & TEST DISTANCE: VERTICAL AT 3 M								
NO.	FREQ. (MHz)	EMISSION LEVEL (dBuV/m)	LIMIT (dBuV/m)	MARGIN (dB)	ANTENNA HEIGHT (m)	TABLE ANGLE (Degree)	RAW VALUE (dBuV)	CORRECTION FACTOR (dB/m)
1	1816.80	47.4 PK	74.0	-26.6	1.30 V	340	18.00	29.40
2	1816.80	30.9 AV	54.0	-23.1	1.30 V	340	1.50	29.40
3	2725.20	55.0 PK	74.0	-19.0	1.32 V	26	22.90	32.10
4	2725.20	38.5 AV	54.0	-15.5	1.32 V	26	6.40	32.10
5	3633.60	54.5 PK	74.0	-19.5	1.56 V	350	20.50	34.00
6	3633.60	38.0 AV	54.0	-16.0	1.56 V	350	4.00	34.00
7	4542.00	54.1 PK	74.0	-19.9	1.16 V	219	17.60	36.50
8	4542.00	37.6 AV	54.0	-16.4	1.16 V	219	1.10	36.50
9	6358.80	54.6 PK	74.0	-19.4	1.00 V	350	13.90	40.70
10	6358.80	38.1 AV	54.0	-15.9	1.00 V	350	-2.60	40.70
11	8175.60	61.2 PK	74.0	-12.8	1.45 V	355	16.20	45.00
12	8175.60	44.7 AV	54.0	-9.3	1.45 V	355	-0.30	45.00

- REMARKS:**
1. Emission level (dBuV/m) = Raw Value (dBuV) + Correction Factor (dB/m).
 2. Correction Factor (dB/m) = Antenna Factor (dB/m) + Cable Factor (dB).
 3. The other emission levels were very low against the limit.
 4. Margin value = Emission level – Limit value.
 5. The average value of fundamental frequency is: Average = Peak value + 20log(Duty cycle) Where the duty factor is calculated from following formula:
20 log (Duty cycle) = 20 log (14.88 ms / 100 ms) = -16.5 dB

Please see page 23 for plotted duty.



A D T

BELOW 1GHZ WORST-CASE DATA

EUT TEST CONDITION		MEASUREMENT DETAIL	
CHANNEL	Channel 2 (908.40MHz)	FREQUENCY RANGE	Below 1000MHz
INPUT POWER (SYSTEM)	120Vac, 60Hz	DETECTOR FUNCTION	Quasi-Peak
ENVIRONMENTAL CONDITIONS	25deg. C, 65%RH 1012 hPa	TESTED BY	Frank Wang

ANTENNA POLARITY & TEST DISTANCE: HORIZONTAL AT 3 M								
NO.	FREQ. (MHz)	EMISSION LEVEL (dBuV/m)	LIMIT (dBuV/m)	MARGIN (dB)	ANTENNA HEIGHT (m)	TABLE ANGLE (Degree)	RAW VALUE (dBuV)	CORRECTION FACTOR (dB/m)
1	383.76	20.5 QP	46.0	-25.5	1.00 H	52	2.40	18.10
2	543.19	19.7 QP	46.0	-26.3	2.00 H	76	-2.70	22.40
3	702.62	23.7 QP	46.0	-22.3	1.75 H	325	-1.40	25.10
4	811.50	25.8 QP	46.0	-20.2	2.00 H	226	-1.80	27.60
5	902.00	26.6 QP	46.0	-19.4	1.55 H	20	-2.10	28.70
6	928.00	26.7 QP	46.0	-19.3	1.50 H	25	-2.30	29.00
ANTENNA POLARITY & TEST DISTANCE: VERTICAL AT 3 M								
NO.	FREQ. (MHz)	EMISSION LEVEL (dBuV/m)	LIMIT (dBuV/m)	MARGIN (dB)	ANTENNA HEIGHT (m)	TABLE ANGLE (Degree)	RAW VALUE (dBuV)	CORRECTION FACTOR (dB/m)
1	319.60	20.4 QP	46.0	-25.6	1.75 V	253	4.50	15.90
2	486.81	19.4 QP	46.0	-26.6	1.75 V	19	-1.60	21.00
3	632.63	22.2 QP	46.0	-23.8	1.75 V	130	-2.00	24.20
4	757.06	24.3 QP	46.0	-21.7	1.25 V	100	-2.10	26.40
5	902.00	26.4 QP	46.0	-19.6	1.58 V	19	-2.30	28.70
6	928.00	27.0 QP	46.0	-19.0	1.55 V	200	-2.00	29.00

- REMARKS:**
1. Emission level (dBuV/m) = Raw Value (dBuV) + Correction Factor (dB/m).
 2. Correction Factor (dB/m) = Antenna Factor (dB/m) + Cable Factor (dB).
 3. The other emission levels were very low against the limit.
 4. Margin value = Emission level – Limit value.



A D T

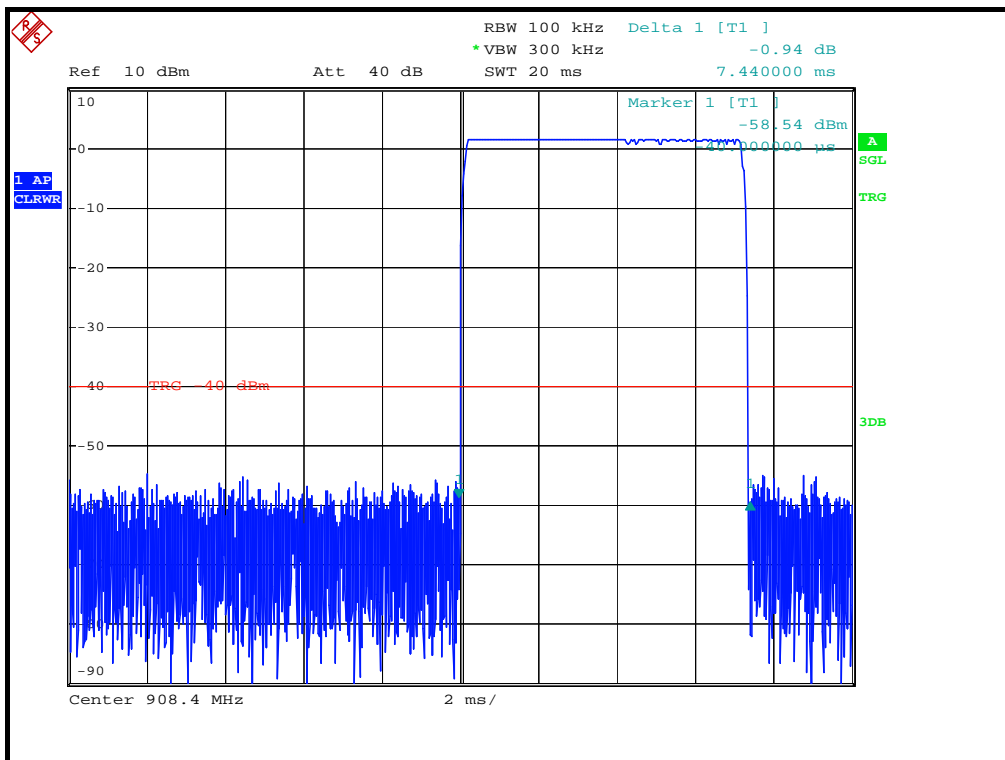
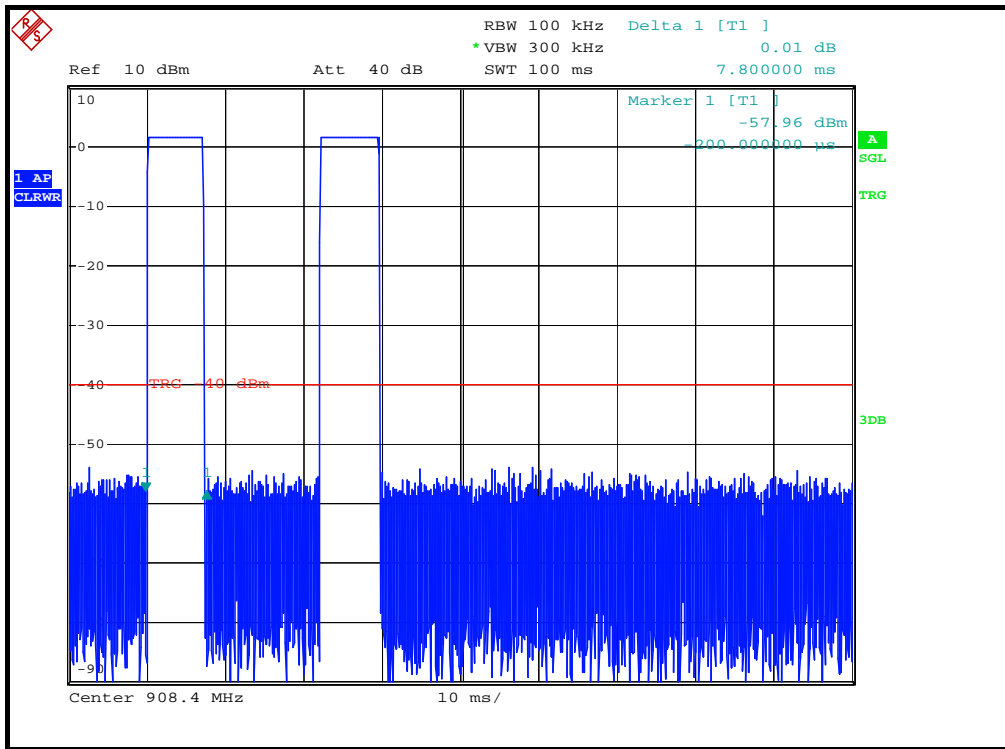

$$20 \log (\text{Duty cycle}) = 20 \log [(7.44 + 7.44) \text{ ms} / 100 \text{ ms}] = -16.5 \text{ dB}$$



For 916.00 MHz

EUT TEST CONDITION		MEASUREMENT DETAIL	
CHANNEL	Channel 3 (916.00MHz)	FREQUENCY RANGE	Below 1000MHz
INPUT POWER	120Vac, 60 Hz	DETECTOR FUNCTION	Quasi-Peak
ENVIRONMENTAL CONDITIONS	25deg. C, 65%RH 1012 hPa	TESTED BY	Frank Wang

ANTENNA POLARITY & TEST DISTANCE: HORIZONTAL AT 3 M								
NO.	FREQ. (MHz)	EMISSION LEVEL (dBuV/m)	LIMIT (dBuV/m)	MARGIN (dB)	ANTENNA HEIGHT (m)	TABLE ANGLE (Degree)	RAW VALUE (dBuV)	CORRECTION FACTOR (dB/m)
1	*916.00	76.7 QP	94.0	-17.3	1.49 H	150	47.9	28.8

ANTENNA POLARITY & TEST DISTANCE: VERTICAL AT 3 M								
NO.	FREQ. (MHz)	EMISSION LEVEL (dBuV/m)	LIMIT (dBuV/m)	MARGIN (dB)	ANTENNA HEIGHT (m)	TABLE ANGLE (Degree)	RAW VALUE (dBuV)	CORRECTION FACTOR (dB/m)
1	*916.00	70.2 QP	94.0	-23.8	1.06 V	81	41.4	28.8

- REMARKS:**
1. Emission level (dBuV/m) = Raw Value (dBuV) + Correction Factor (dB/m).
 2. Correction Factor (dB/m) = Antenna Factor (dB/m) + Cable Factor (dB).
 3. The other emission levels were very low against the limit.
 4. Margin value = Emission level – Limit value.
 5. “ * “ : Fundamental frequency
 6. The average value of fundamental frequency is: Average = Peak value + 20log(Duty cycle) Where the duty factor is calculated from following formula:
 $20 \log (\text{Duty cycle}) = 20 \log (10.24 \text{ ms} / 100 \text{ ms}) = -19.8 \text{ dB}$

Please see page 28 for plotted duty.



ABOVE 1GHz DATA

EUT TEST CONDITION		MEASUREMENT DETAIL	
CHANNEL	Channel 3 (916.00MHz)	FREQUENCY RANGE	1 ~ 25GHz
INPUT POWER	120Vac, 60Hz	DETECTOR FUNCTION	Peak (PK) Average (AV)
ENVIRONMENTAL CONDITIONS	25deg. C, 65%RH 1012 hPa	TESTED BY	Frank Wang

ANTENNA POLARITY & TEST DISTANCE: HORIZONTAL AT 3 M								
NO.	FREQ. (MHz)	EMISSION LEVEL (dBuV/m)	LIMIT (dBuV/m)	MARGIN (dB)	ANTENNA HEIGHT (m)	TABLE ANGLE (Degree)	RAW VALUE (dBuV)	CORRECTION FACTOR (dB/m)
1	1832.00	45.0 PK	74.0	-29.0	1.52 H	316	15.60	29.40
2	1832.00	25.2 AV	54.0	-28.8	1.52 H	316	-4.20	29.40
3	2748.00	57.3 PK	74.0	-16.7	1.12 H	280	25.10	32.20
4	2748.00	37.5 AV	54.0	-16.5	1.12 H	280	5.30	32.20
5	3664.00	47.7 PK	74.0	-26.3	1.37 H	286	13.60	34.10
6	3664.00	27.9 AV	54.0	-26.1	1.37 H	286	-6.20	34.10
7	4580.00	50.6 PK	74.0	-23.4	1.20 H	13	14.00	36.60
8	4580.00	30.8 AV	54.0	-23.2	1.20 H	13	-5.80	36.60
9	6412.00	52.5 PK	74.0	-21.5	1.30 H	260	11.50	41.00
10	6412.00	32.7 AV	54.0	-21.3	1.30 H	260	-8.30	41.00
11	8244.00	58.2 PK	74.0	-15.8	1.14 H	72	13.20	45.00
12	8244.00	38.4 AV	54.0	-15.6	1.14 H	72	-6.60	45.00

- REMARKS:**
1. Emission level (dBuV/m) = Raw Value (dBuV) + Correction Factor (dB/m).
 2. Correction Factor (dB/m) = Antenna Factor (dB/m) + Cable Factor (dB).
 3. The other emission levels were very low against the limit.
 4. Margin value = Emission level – Limit value.
 5. The average value of fundamental frequency is: Average = Peak value + 20log(Duty cycle) Where the duty factor is calculated from following formula:
 $20 \log (\text{Duty cycle}) = 20 \log (10.24 \text{ ms} / 100 \text{ ms}) = -19.8 \text{ dB}$

Please see page 28 for plotted duty.



A D T

EUT TEST CONDITION		MEASUREMENT DETAIL	
CHANNEL	Channel 3 (916.00MHz)	FREQUENCY RANGE	1 ~ 25GHz
INPUT POWER	120Vac, 60Hz	DETECTOR FUNCTION	Peak (PK) Average (AV)
ENVIRONMENTAL CONDITIONS	25deg. C, 65%RH 1012 hPa	TESTED BY	Frank Wang

ANTENNA POLARITY & TEST DISTANCE: VERTICAL AT 3 M								
NO.	FREQ. (MHz)	EMISSION LEVEL (dBuV/m)	LIMIT (dBuV/m)	MARGIN (dB)	ANTENNA HEIGHT (m)	TABLE ANGLE (Degree)	RAW VALUE (dBuV)	CORRECTION FACTOR (dB/m)
1	1832.00	45.9 PK	74.0	-28.1	1.25 V	0	16.50	29.40
2	1832.00	26.1 AV	54.0	-27.9	1.25 V	0	-3.30	29.40
3	2748.00	55.1 PK	74.0	-18.9	1.35 V	352	22.90	32.20
4	2748.00	35.3 AV	54.0	-18.7	1.35 V	352	3.10	32.20
5	3664.00	49.1 PK	74.0	-24.9	1.35 V	345	15.00	34.10
6	3664.00	29.3 AV	54.0	-24.7	1.35 V	345	-4.80	34.10
7	4580.00	52.4 PK	74.0	-21.6	1.00 V	7	15.80	36.60
8	4580.00	32.6 AV	54.0	-21.4	1.00 V	7	-4.00	36.60
9	6412.00	54.9 PK	74.0	-19.1	1.00 V	353	13.90	41.00
10	6412.00	35.1 AV	54.0	-18.9	1.00 V	353	-5.90	41.00
11	8244.00	61.4 PK	74.0	-12.6	1.28 V	352	16.40	45.00
12	8244.00	41.6 AV	54.0	-12.4	1.28 V	352	-3.40	45.00

- REMARKS:**
1. Emission level (dBuV/m) = Raw Value (dBuV) + Correction Factor (dB/m).
 2. Correction Factor (dB/m) = Antenna Factor (dB/m) + Cable Factor (dB).
 3. The other emission levels were very low against the limit.
 4. Margin value = Emission level – Limit value.
 5. The average value of fundamental frequency is: Average = Peak value + 20log(Duty cycle) Where the duty factor is calculated from following formula:
 $20 \log (\text{Duty cycle}) = 20 \log (10.24 \text{ ms} / 100 \text{ ms}) = -19.8 \text{ dB}$

Please see page 28 for plotted duty.



A D T

BELOW 1GHz WORST-CASE DATA

EUT TEST CONDITION		MEASUREMENT DETAIL	
CHANNEL	Channel 3 (916.00MHz)	FREQUENCY RANGE	Below 1000MHz
INPUT POWER	120Vac, 60Hz	DETECTOR FUNCTION	Quasi-Peak
ENVIRONMENTAL CONDITIONS	25deg. C, 65%RH 1012 hPa	TESTED BY	Frank Wang

ANTENNA POLARITY & TEST DISTANCE: HORIZONTAL AT 3 M								
NO.	FREQ. (MHz)	EMISSION LEVEL (dBuV/m)	LIMIT (dBuV/m)	MARGIN (dB)	ANTENNA HEIGHT (m)	TABLE ANGLE (Degree)	RAW VALUE (dBuV)	CORRECTION FACTOR (dB/m)
1	539.30	20.2 QP	46.0	-25.8	1.50 H	256	-2.10	22.30
2	634.57	22.5 QP	46.0	-23.5	2.00 H	205	-1.70	24.20
3	739.57	24.2 QP	46.0	-21.8	1.50 H	85	-1.70	25.90
4	819.28	25.8 QP	46.0	-20.2	1.75 H	247	-1.90	27.70
5	902.00	26.0 QP	46.0	-20.0	1.00 H	292	-2.70	28.70
6	928.00	27.2 QP	46.0	-18.8	1.50 H	193	-1.80	29.00
ANTENNA POLARITY & TEST DISTANCE: VERTICAL AT 3 M								
NO.	FREQ. (MHz)	EMISSION LEVEL (dBuV/m)	LIMIT (dBuV/m)	MARGIN (dB)	ANTENNA HEIGHT (m)	TABLE ANGLE (Degree)	RAW VALUE (dBuV)	CORRECTION FACTOR (dB/m)
1	549.03	20.2 QP	46.0	-25.8	1.00 V	4	-2.30	22.50
2	636.52	22.0 QP	46.0	-24.0	1.00 V	58	-2.20	24.20
3	743.45	24.2 QP	46.0	-21.8	1.00 V	67	-1.80	26.00
4	832.89	25.0 QP	46.0	-21.0	1.00 V	322	-2.90	27.90
5	902.00	26.5 QP	46.0	-19.5	1.00 V	136	-2.20	28.70
6	928.00	26.0 QP	46.0	-20.0	1.50 V	199	-3.00	29.00

- REMARKS:**
1. Emission level (dBuV/m) = Raw Value (dBuV) + Correction Factor (dB/m).
 2. Correction Factor (dB/m) = Antenna Factor (dB/m) + Cable Factor (dB).
 3. The other emission levels were very low against the limit.
 4. Margin value = Emission level – Limit value.

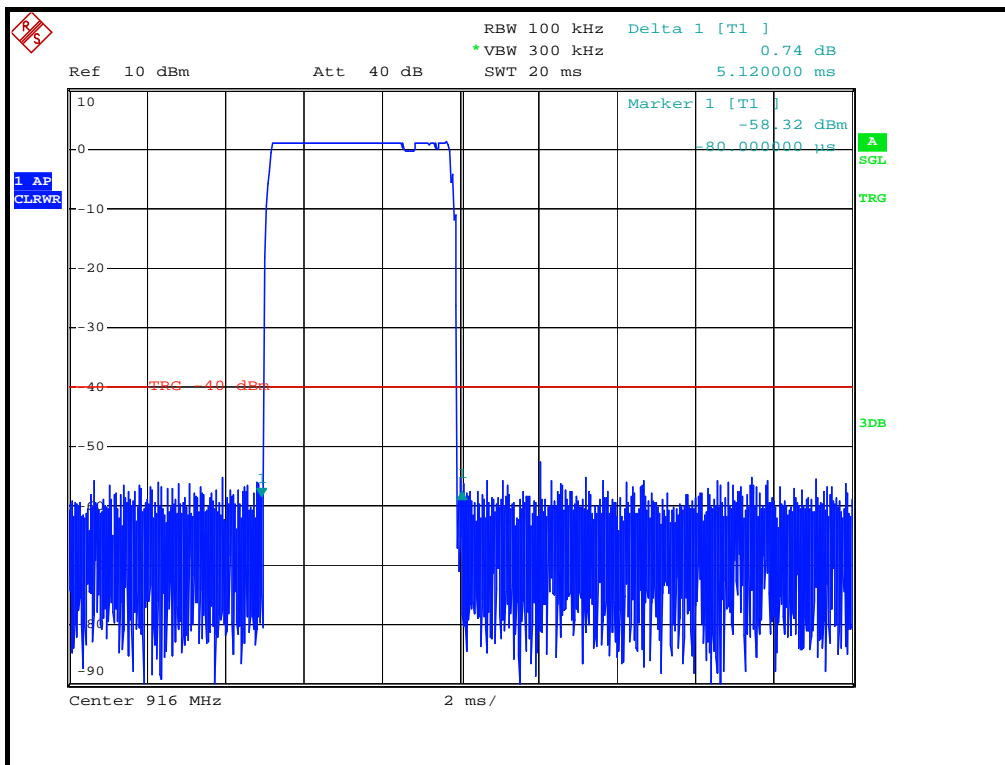
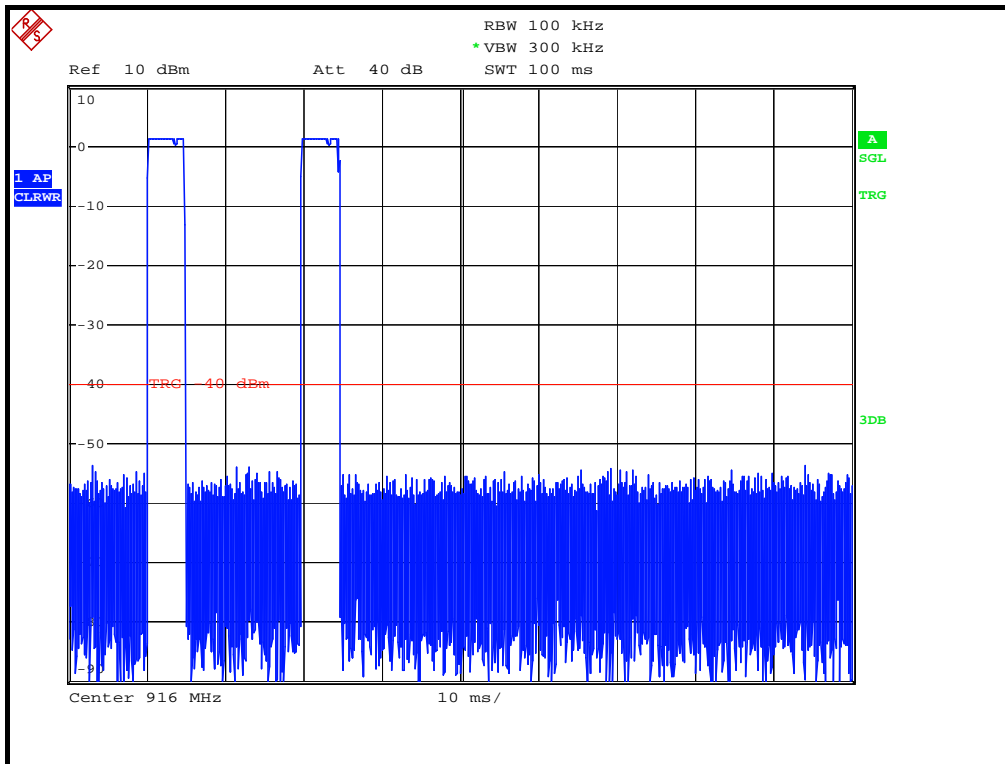

$$20 \log (\text{Duty cycle}) = 20 \log [(5.12 + 5.12) \text{ ms} / 100 \text{ ms}] = -19.8\text{dB}$$

4.2 CONDUCTED EMISSION MEASUREMENT

4.2.1 LIMITS OF CONDUCTED EMISSION MEASUREMENT

FREQUENCY OF EMISSION (MHz)	CONDUCTED LIMIT (dB μ V)	
	Quasi-peak	Average
0.15-0.5	66 to 56	56 to 46
0.5-5	56	46
5-30	60	50

- NOTE:**
1. The lower limit shall apply at the transition frequencies.
 2. The limit decreases in line with the logarithm of the frequency in the range of 0.15 to 0.50 MHz.
 3. All emanations from a class A/B digital device or system, including any network of conductors and apparatus connected thereto, shall not exceed the level of field strengths specified above.

4.2.2 TEST INSTRUMENTS

DESCRIPTION & MANUFACTURER	MODEL NO.	SERIAL NO.	DATE OF CALIBRATION	DUE DATE OF CALIBRATION
Test Receiver ROHDE & SCHWARZ	ESCS30	100289	Nov. 23, 2010	Nov. 22, 2011
RF signal cable Woken	5D-FB	Cable-HYCO2-01	Dec. 30, 2010	Dec. 29, 2011
LISN ROHDE & SCHWARZ	ESH2-Z5	100100	Jan. 06, 2011	Jan. 05, 2012
LISN ROHDE & SCHWARZ	ESH3-Z5	100311	Jul. 08, 2010	Jul. 07, 2011
Software ADT	ADT_Cond_ V7.3.7	NA	NA	NA

- NOTE:**
1. The calibration interval of the above test instruments is 12 months and the calibrations are traceable to NML/ROC and NIST/USA.
 2. The test was performed in HwaYa Shielded Room 2.
 3. The VCCI Site Registration No. is C-2047.

4.2.3 TEST PROCEDURES

- a. The EUT was placed 0.4 meters from the conducting wall of the shielded room with EUT being connected to the power mains through a line impedance stabilization network (LISN). Other support units were connected to the power mains through another LISN. The two LISNs provide 50 ohm/ 50uH of coupling impedance for the measuring instrument.
- b. Both lines of the power mains connected to the EUT were checked for maximum conducted interference.
- c. The frequency range from 150kHz to 30MHz was searched. Emission levels under (Limit - 20dB) was not recorded.

NOTE: All modes of operation were investigated and the worst-case emissions are reported.

4.2.4 DEVIATION FROM TEST STANDARD

No deviation.

4.2.5 TEST SETUP

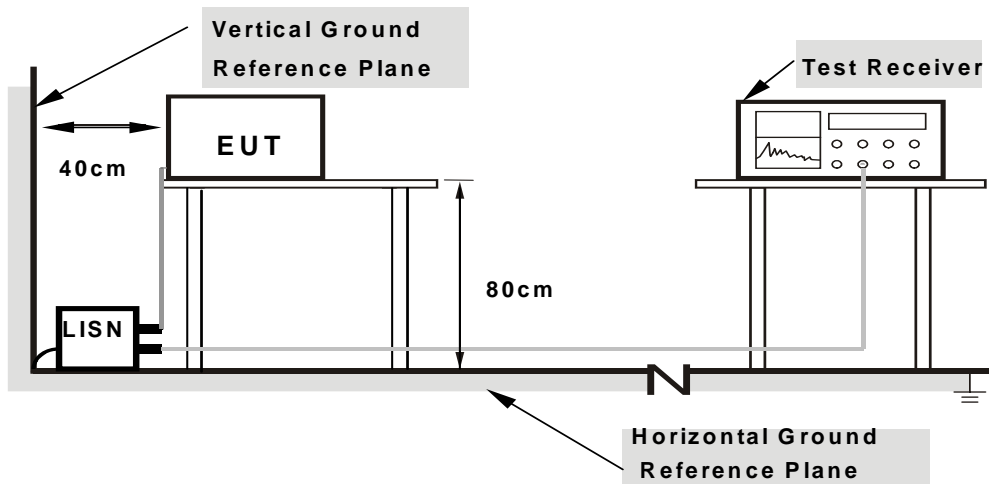

- Note:**
1. Support units were connected to second LISN.
 2. Both of LISNs (AMN) are 80 cm from EUT and at least 80 cm from other units and other metal planes

For the actual test configuration, please refer to the attached file (Test Setup Photo).

4.2.6 EUT OPERATING CONDITIONS

Same as 4.1.6.

4.2.7 TEST RESULTS

CONDUCTED WORST-CASE DATA :

For 908.42 MHz

PHASE	Line 1	6dB BANDWIDTH	9kHz
--------------	--------	----------------------	------

No	Freq. [MHz]	Corr.	Reading Value		Emission Level		Limit		Margin	
		Factor	[dB (uV)]		[dB (uV)]		[dB (uV)]		(dB)	
		(dB)	Q.P.	AV.	Q.P.	AV.	Q.P.	AV.	Q.P.	AV.
1	0.275	0.16	38.67	-	38.83	-	60.97	50.97	-22.14	-
2	0.556	0.18	25.24	-	25.42	-	56.00	46.00	-30.58	-
3	0.732	0.18	23.88	-	24.06	-	56.00	46.00	-31.94	-
4	1.695	0.21	21.24	-	21.45	-	56.00	46.00	-34.55	-
5	2.137	0.23	19.06	-	19.29	-	56.00	46.00	-36.71	-
6	24.250	1.22	5.98	-	7.20	-	60.00	50.00	-52.80	-

- REMARKS:**
1. Q.P. and AV. are abbreviations of quasi-peak and average individually.
 2. "-": The Quasi-peak reading value also meets average limit and measurement with the average detector is unnecessary.
 3. The emission levels of other frequencies were very low against the limit.
 4. Margin value = Emission level - Limit value
 5. Correction factor = Insertion loss + Cable loss
 6. Emission Level = Correction Factor + Reading Value.

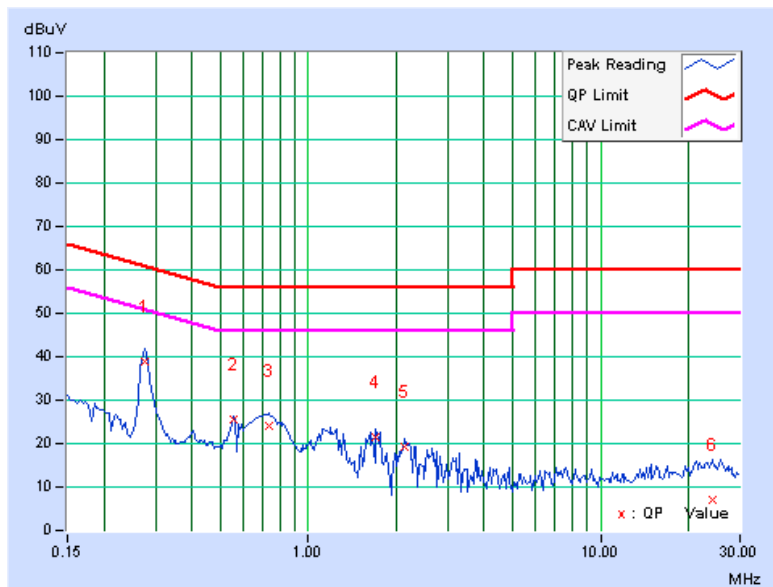

PHASE	Line 2	6dB BANDWIDTH	9kHz
-------	--------	---------------	------

No	Freq. [MHz]	Corr. Factor (dB)	Reading Value		Emission Level		Limit		Margin	
			[dB (uV)]		[dB (uV)]		[dB (uV)]		(dB)	
			Q.P.	AV.	Q.P.	AV.	Q.P.	AV.	Q.P.	AV.
1	0.275	0.18	34.14	-	34.32	-	60.97	50.97	-26.65	-
2	0.548	0.19	19.52	-	19.71	-	56.00	46.00	-36.29	-
3	0.689	0.20	17.68	-	17.88	-	56.00	46.00	-38.12	-
4	1.754	0.23	15.17	-	15.40	-	56.00	46.00	-40.60	-
5	2.660	0.26	12.89	-	13.15	-	56.00	46.00	-42.85	-
6	22.301	0.98	4.90	-	5.88	-	60.00	50.00	-54.12	-

- REMARKS:**
1. Q.P. and AV. are abbreviations of quasi-peak and average individually.
 2. "-": The Quasi-peak reading value also meets average limit and measurement with the average detector is unnecessary.
 3. The emission levels of other frequencies were very low against the limit.
 4. Margin value = Emission level - Limit value
 5. Correction factor = Insertion loss + Cable loss
 6. Emission Level = Correction Factor + Reading Value.

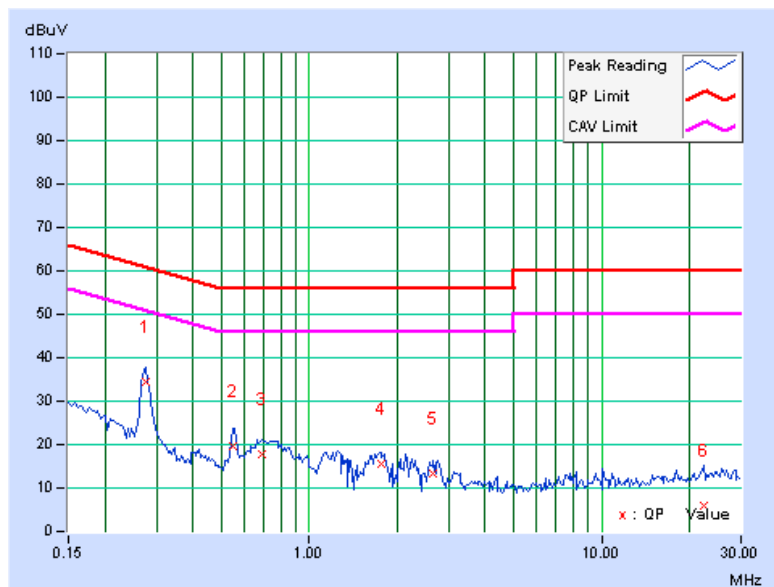

For 908.40 MHz

PHASE	Line 1	6dB BANDWIDTH	9kHz
--------------	--------	----------------------	------

No	Freq. [MHz]	Corr.	Reading Value		Emission Level		Limit		Margin	
		Factor	[dB (uV)]		[dB (uV)]		[dB (uV)]		(dB)	
		(dB)	Q.P.	AV.	Q.P.	AV.	Q.P.	AV.	Q.P.	AV.
1	0.275	0.16	39.10	-	39.26	-	60.97	50.97	-21.71	-
2	0.552	0.18	24.95	-	25.13	-	56.00	46.00	-30.87	-
3	0.693	0.18	24.48	-	24.66	-	56.00	46.00	-31.34	-
4	1.215	0.20	21.97	-	22.17	-	56.00	46.00	-33.83	-
5	1.719	0.21	21.58	-	21.79	-	56.00	46.00	-34.21	-
6	26.176	1.24	4.92	-	6.16	-	60.00	50.00	-53.84	-

- REMARKS:**
1. Q.P. and AV. are abbreviations of quasi-peak and average individually.
 2. "-": The Quasi-peak reading value also meets average limit and measurement with the average detector is unnecessary.
 3. The emission levels of other frequencies were very low against the limit.
 4. Margin value = Emission level - Limit value
 5. Correction factor = Insertion loss + Cable loss
 6. Emission Level = Correction Factor + Reading Value.

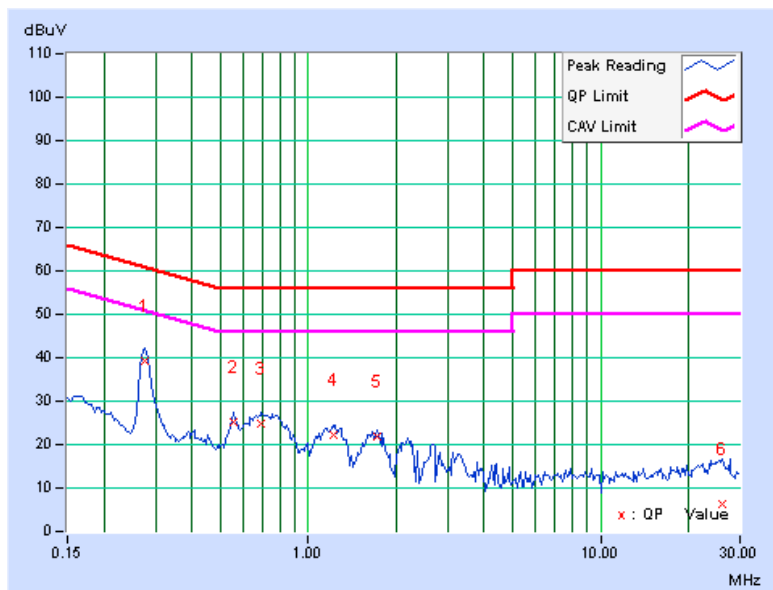

PHASE	Line 2	6dB BANDWIDTH	9kHz
-------	--------	---------------	------

No	Freq. [MHz]	Corr. Factor (dB)	Reading Value		Emission Level		Limit		Margin	
			[dB (uV)]		[dB (uV)]		[dB (uV)]		(dB)	
			Q.P.	AV.	Q.P.	AV.	Q.P.	AV.	Q.P.	AV.
1	0.275	0.18	34.41	-	34.59	-	60.97	50.97	-26.38	-
2	0.548	0.19	20.06	-	20.25	-	56.00	46.00	-35.75	-
3	0.724	0.20	18.07	-	18.27	-	56.00	46.00	-37.73	-
4	1.246	0.21	15.81	-	16.02	-	56.00	46.00	-39.98	-
5	1.754	0.23	15.35	-	15.58	-	56.00	46.00	-40.42	-
6	24.355	1.02	6.05	-	7.07	-	60.00	50.00	-52.93	-

- REMARKS:**
1. Q.P. and AV. are abbreviations of quasi-peak and average individually.
 2. "-": The Quasi-peak reading value also meets average limit and measurement with the average detector is unnecessary.
 3. The emission levels of other frequencies were very low against the limit.
 4. Margin value = Emission level - Limit value
 5. Correction factor = Insertion loss + Cable loss
 6. Emission Level = Correction Factor + Reading Value.

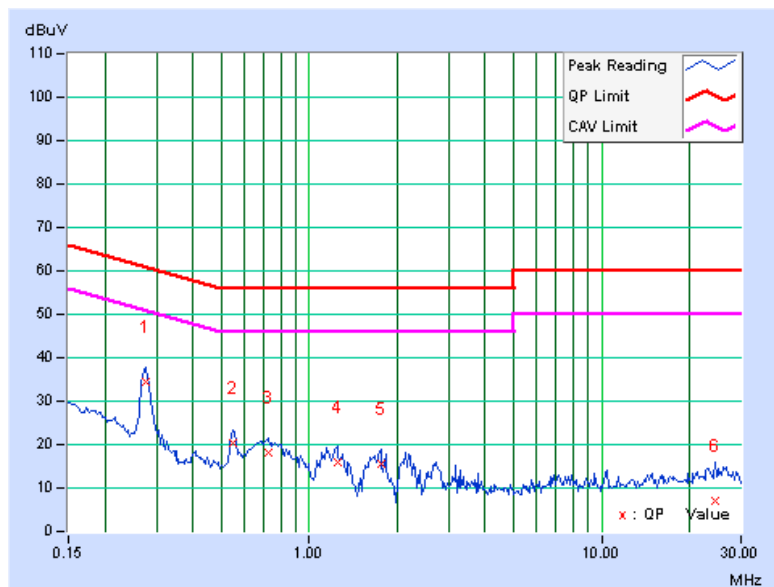

For 916.00 MHz

PHASE	Line 1	6dB BANDWIDTH	9kHz
--------------	--------	----------------------	------

No	Freq. [MHz]	Corr. Factor (dB)	Reading Value		Emission Level		Limit		Margin	
			[dB (uV)]		[dB (uV)]		[dB (uV)]		(dB)	
			Q.P.	AV.	Q.P.	AV.	Q.P.	AV.	Q.P.	AV.
1	0.276	0.16	39.20	-	39.36	-	60.93	50.93	-21.57	-
2	0.556	0.18	25.22	-	25.40	-	56.00	46.00	-30.60	-
3	0.705	0.18	24.68	-	24.86	-	56.00	46.00	-31.14	-
4	1.281	0.20	21.59	-	21.79	-	56.00	46.00	-34.21	-
5	1.738	0.21	21.51	-	21.72	-	56.00	46.00	-34.28	-
6	23.555	1.20	8.39	-	9.59	-	60.00	50.00	-50.41	-

- REMARKS:**
1. Q.P. and AV. are abbreviations of quasi-peak and average individually.
 2. "-": The Quasi-peak reading value also meets average limit and measurement with the average detector is unnecessary.
 3. The emission levels of other frequencies were very low against the limit.
 4. Margin value = Emission level - Limit value
 5. Correction factor = Insertion loss + Cable loss
 6. Emission Level = Correction Factor + Reading Value.

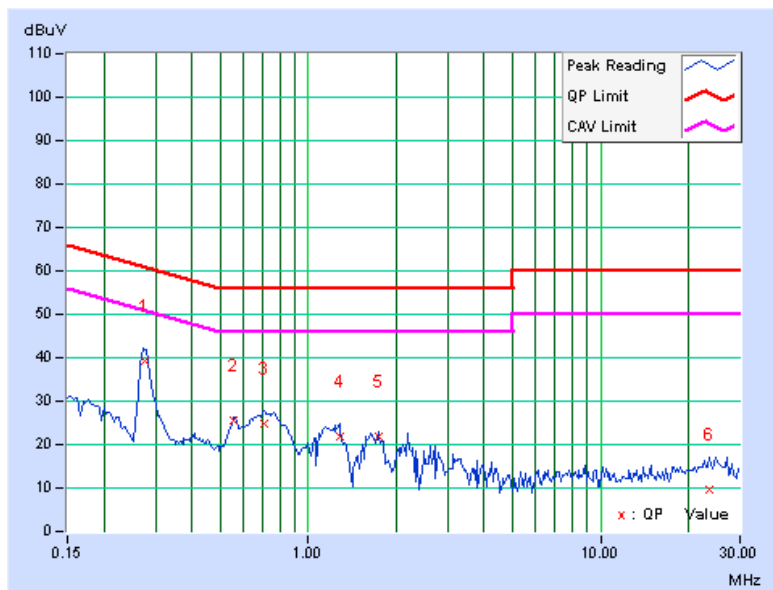

PHASE	Line 2	6dB BANDWIDTH	9kHz
-------	--------	---------------	------

No	Freq. [MHz]	Corr. Factor (dB)	Reading Value		Emission Level		Limit		Margin	
			[dB (uV)]		[dB (uV)]		[dB (uV)]		(dB)	
			Q.P.	AV.	Q.P.	AV.	Q.P.	AV.	Q.P.	AV.
1	0.271	0.18	34.87	-	35.05	-	61.08	51.08	-26.04	-
2	0.545	0.19	17.18	-	17.37	-	56.00	46.00	-38.63	-
3	0.705	0.20	18.35	-	18.55	-	56.00	46.00	-37.45	-
4	1.207	0.21	15.94	-	16.15	-	56.00	46.00	-39.85	-
5	1.711	0.22	16.02	-	16.24	-	56.00	46.00	-39.76	-
6	22.387	0.98	9.15	-	10.13	-	60.00	50.00	-49.87	-

- REMARKS:**
1. Q.P. and AV. are abbreviations of quasi-peak and average individually.
 2. "-": The Quasi-peak reading value also meets average limit and measurement with the average detector is unnecessary.
 3. The emission levels of other frequencies were very low against the limit.
 4. Margin value = Emission level - Limit value
 5. Correction factor = Insertion loss + Cable loss
 6. Emission Level = Correction Factor + Reading Value.

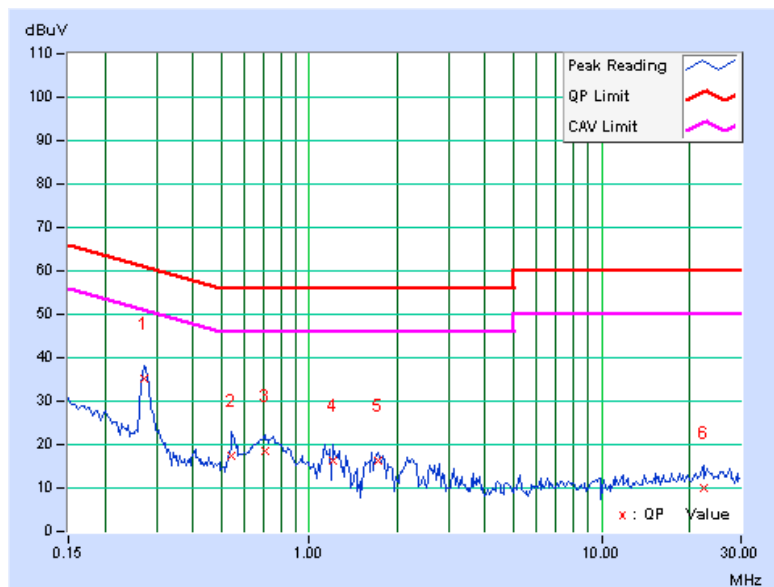

4.3 BAND EDGES MEASUREMENT

4.3.1 LIMITS OF BAND EDGES MEASUREMENT

Below -50dB of the highest emission level of operating band (in 100kHz Resolution Bandwidth).

4.3.2 TEST INSTRUMENTS

DESCRIPTION & MANUFACTURER	MODEL NO.	SERIAL NO.	DATE OF CALIBRATION	DUE DATE OF CALIBRATION
SPECTRUM ANALYZER R&S	FSP40	100040	Jul. 17, 2010	Jul. 16, 2011

NOTE: The calibration interval of the above test instruments is 12 months and the calibrations are traceable to NML/ROC and NIST/USA.

4.3.3 TEST PROCEDURE

The transmitter output was connected to the spectrum analyzer via a low loss cable. Set both RBW and VBW of spectrum analyzer to 100 kHz and 300 kHz with suitable frequency span including 100 MHz bandwidth from band edge. The band edges was measured and recorded.

The spectrum plots are attached on the following pages.

4.3.4 DEVIATION FROM TEST STANDARD

No deviation.

4.3.5 EUT OPERATING CONDITION

The software provided by client to enable the EUT under transmission condition continuously at lowest and highest channel frequencies individually.

4.3.6 TEST RESULTS

The spectrum plots are attached on the following images. D1 line indicates the highest level, and D2 line indicates the 50dB offset below D1. It shows compliance with the requirement in part 15.249 (d).

For 908.40 MHz

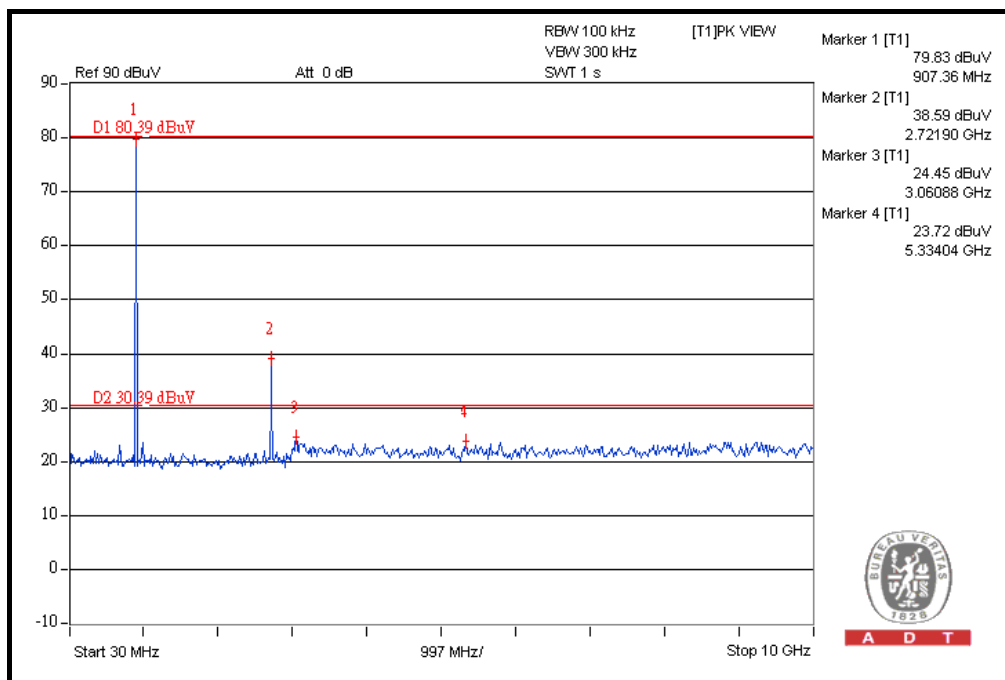
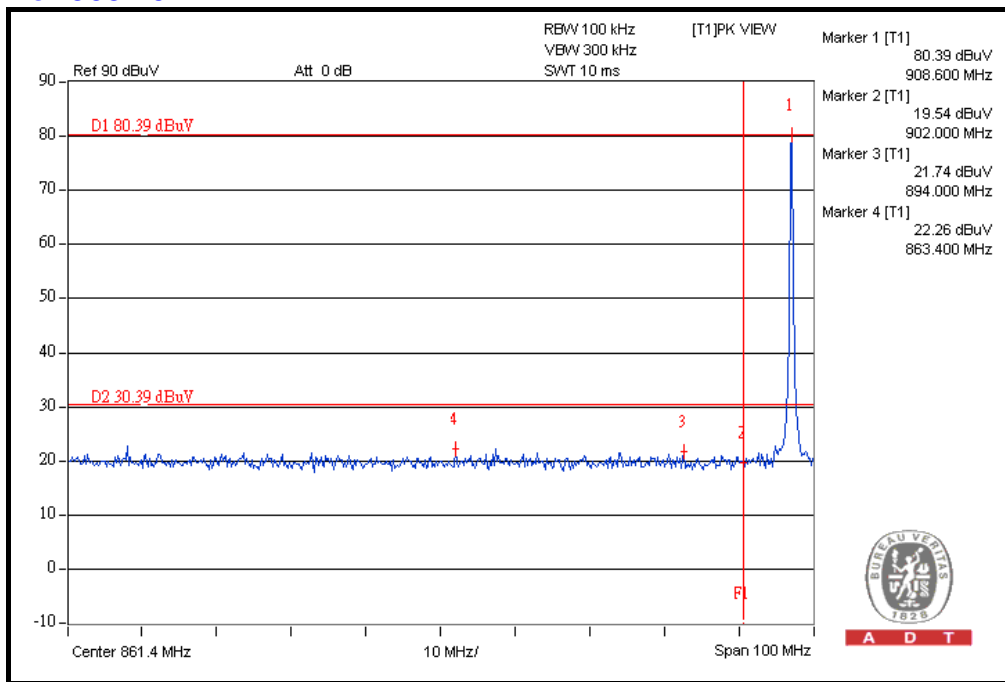



A D T

For 908.42 MHz

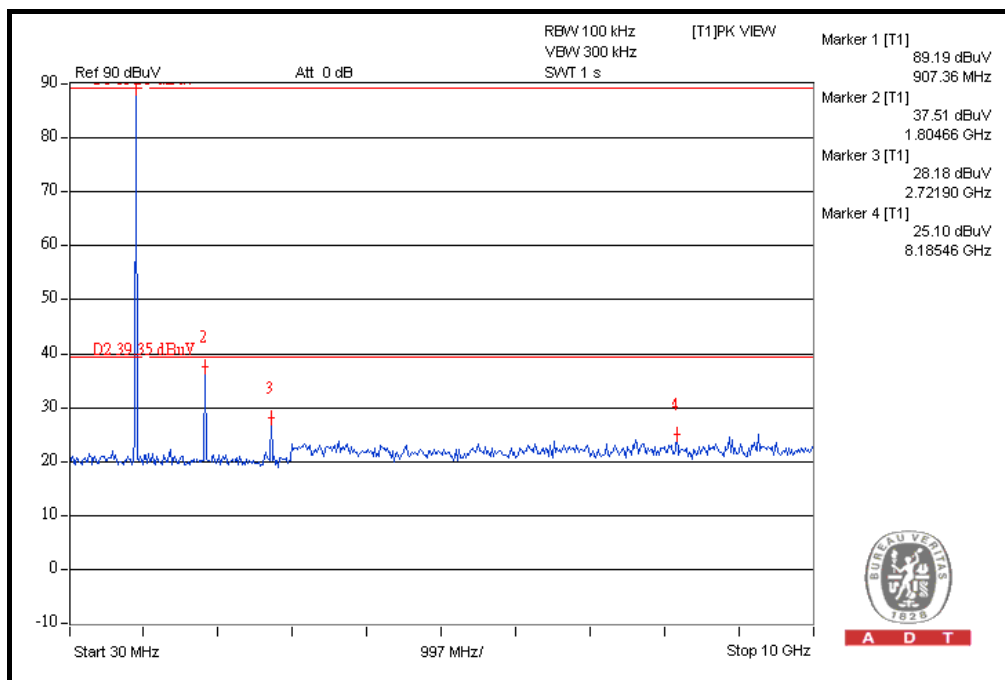
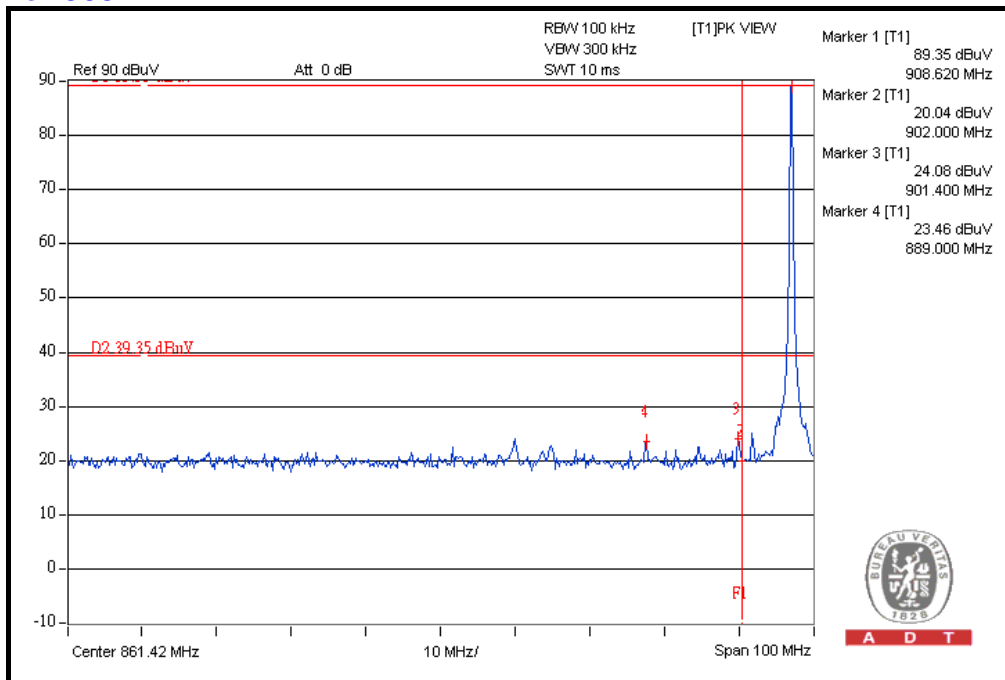



A D T

For 916.00 MHz

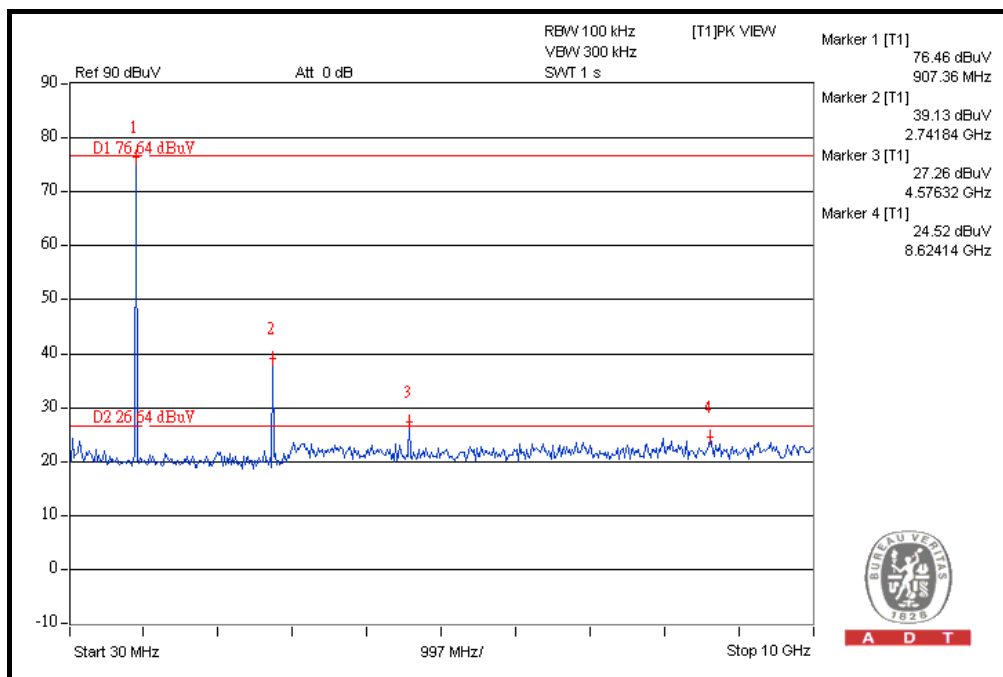
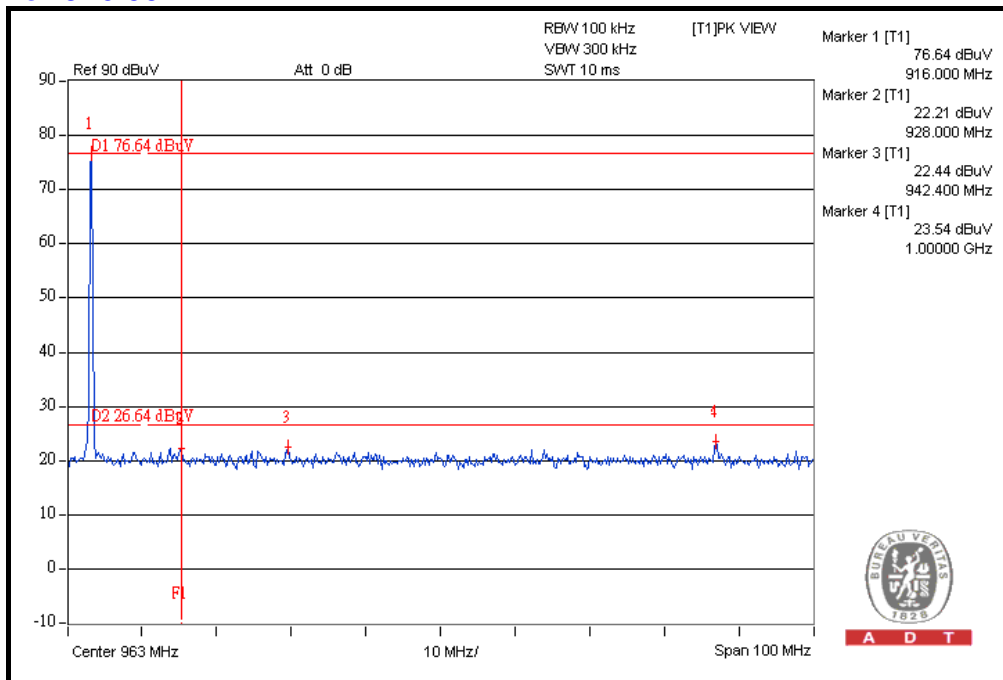

5. PHOTOGRAPHS OF THE TEST CONFIGURATION

Please refer to the attached file (Test Setup Photo).



6. INFORMATION ON THE TESTING LABORATORIES

We, Bureau Veritas Consumer Products Services (H.K.) Ltd., Taoyuan Branch, were founded in 1988 to provide our best service in EMC, Radio, Telecom and Safety consultation. Our laboratories are accredited and approved according to ISO/IEC 17025.

Copies of accreditation certificates of our laboratories obtained from approval agencies can be downloaded from our web site: www.adt.com.tw/index.5.phtml. If you have any comments, please feel free to contact us at the following:

Linko EMC/RF Lab

Tel: 886-2-26052180

Fax: 886-2-26051924

Hsin Chu EMC/RF Lab

Tel: 886-3-5935343

Fax: 886-3-5935342

Hwa Ya EMC/RF/Safety/Telecom Lab

Tel: 886-3-3183232

Fax: 886-3-3185050

Web Site: www.adt.com.tw

The address and road map of all our labs can be found in our web site also.



A D T

7. APPENDIX A - MODIFICATIONS RECORDERS FOR ENGINEERING CHANGES TO THE EUT BY THE LAB

No any modifications are made to the EUT by the lab during the test.

--- END ---