



# SPORTON International Inc.

No. 52, Hwa Ya 1st Rd., Kwei-Shan Hsiang, TaoYuan Hsien, Taiwan, R.O.C.  
Ph: 886-3-327-3456 / FAX: 886-3-327-0973 / www.sporton.com.tw

## FCC Dynamic Frequency Selection Test Report

|                        |  |
|------------------------|--|
| Applicant's company    | <b>Wistron NeWeb Corporation</b>                                   |
| Applicant Address      | 20 Park Avenue II, Hsinchu Science Park, Hsinchu 308,Taiwan,R.O.C. |
| FCC ID                 | <b>NKR-DNUB-B1</b>   |
| Manufacturer's company | <b>Wistron NeWeb Corporation</b>                                   |
| Manufacturer Address   | 20 Park Avenue II, Hsinchu Science Park, Hsinchu 308,Taiwan,R.O.C. |

|                  |   |
|------------------|---|
| Product Name     | 802.11AGN 2X2 USB EMBEDDED WI-FI MODULE   |
| Brand Name       | WNC                                       |
| Model Name       | DNUB-B1                                   |
| Test Standard(s) | 47 CFR FCC Part 15 Subpart E § 15.407     |
| Test Freq. Range | 5250~5350 / 5470~5725 MHz                 |
| Received Date    | Apr. 20, 2010                             |
| Final Test Date  | Apr. 21, 2010                             |
| Submission Type  | Original Equipment                        |
| Operating Mode   | Client (without radar detection function) |

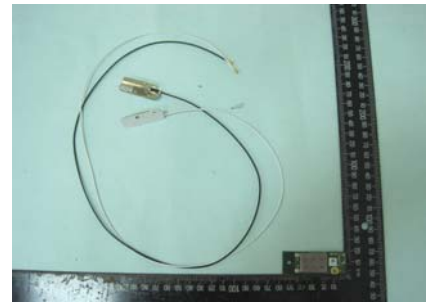

### Statement

The test result in this report refers exclusively to the presented test model / sample.

Without written approval of SPORTON International Inc., the test report shall not be reproduced except in full. The measurements and test results shown in this test report were made in accordance with the procedures and found in compliance with the limit given in FCC OET Order 06-96A (2006) and 47 CFR FCC Part 15 Subpart E § 15.407. The test equipment used to perform the test is calibrated and traceable to NML/ROC.



## Table of Contents

|  |                |
|--|----------------|
| <b>1. CERTIFICATE OF COMPLIANCE .....</b>  | <b>1</b>       |
| <b>2. SUMMARY OF THE TEST RESULT .....</b>   | <b>2</b>       |
| <b>3. GENERAL INFORMATION .....</b>  | <b>3</b>       |
| 3.1. Standard Requirement .....  | 3              |
| 3.2. Product Specification Table.....  | 3              |
| 3.3. Accessories.....  | 6              |
| 3.4. Table for DFS Band Carrier Frequencies .....  | 6              |
| 3.5. Table for Filed Antenna.....  | 7              |
| <b>4. DFS DETECTION THRESHOLDS AND RADAR TEST WAVEFORMS .....</b>  | <b>8</b>       |
| 4.1. Interference Threshold values, Master or Client incorporating In-Service Monitoring .....                           | 8              |
| 4.2. DFS Response requirement values.....  | 8              |
| 4.3. Radar Test Waveforms Minimum Step.....  | 9              |
| 4.4. Short Pulse Radar Test Waveforms .....  | 9              |
| 4.5. Long Pulse Radar Test Waveform.....   | 10             |
| 4.6. Frequency Hopping Radar Test Waveform.....  | 12             |
| 4.7. Conducted Calibration Setup .....   | 14             |
| 4.8. Radar Waveform Calibration Procedure .....  | 14             |
| 4.9. Calibration Deviation.....  | 14             |
| 4.10. Radar Waveform Calibration Result .....  | 15             |
| <b>5. TEST SETUP AND TEST RESULT.....</b>  | <b>17</b>      |
| 5.1. Test setup .....  | 17             |
| 5.2. In-Service Monitoring for Channel Move Time, Channel Closing Transmission Time and Non-Occupancy Period Measurement | 25             |
| <b>6. LIST OF MEASURING EQUIPMENTS .....</b>   | <b>34</b>      |
| <b>7. TEST LOCATION.....</b>   | <b>35</b>      |
| <b>8. TAF CERTIFICATE OF ACCREDITATION .....</b>   | <b>36</b>      |
| <b>APPENDIX A. PHOTOGRAPHS OF EUT.....</b>   | <b>A1 ~ A8</b> |
| <b>APPENDIX B. ANTENNA SPECIFICATION</b>   |                |

## History of This Test Report

Original Issue Date: May 17, 2010

Report No.: FZ042026

- No additional attachment.
- Additional attachment were issued as following record:

| Attachment No. | Issue Date | Description |
|----------------|------------|-------------|
|                |            |             |
|                |            |             |
|                |            |             |
|                |            |             |
|                |            |             |
|                |            |             |
|                |            |             |
|                |            |             |
|                |            |             |
|                |            |             |
|                |            |             |
|                |            |             |
|                |            |             |
|                |            |             |
|                |            |             |
|                |            |             |



## 1. CERTIFICATE OF COMPLIANCE

**Product Name** : 802.11AGN 2X2 USB EMBEDDED WI-FI MODULE  
**Brand Name** : WNC  
**Model Name** : DNUB-B1  
**Applicant** : Wistron NeWeb Corporation  
**Test Rule Part(s)** : 47 CFR FCC Part 15 Subpart E § 15.407

Sporton International as requested by the applicant to evaluate the EMC performance of the product sample received on Apr. 20, 2010 would like to declare that the tested sample has been evaluated and found to be in compliance with the tested rule parts. The data recorded as well as the test configuration specified is true and accurate for showing the sample's EMC nature.

*Jordan Hsiao 2010.5.25*

Jordan Hsiao

SPORTON INTERNATIONAL INC.

## 2. SUMMARY OF THE TEST RESULT

| Applied Standard: OET Order 06-96A (2006) |          |                               |          |
|---|----------|-------------------------------|----------|
| Part                                      | Appendix | Description of Test           | Result   |
| 5.7                                       | 7.4      | Statistical Performance Check | Complies |

Note: Since the product is client without radar detection function, only Channel Move Time, Channel Closing Transmission Time and Non-Occupancy Period are required to be performed.

### 3. GENERAL INFORMATION

#### 3.1. Standard Requirement

FCC 15.407: U-NII devices operating in the 5.25-5.35 GHz band and the 5.47-5.725 GHz band shall employ a TPC mechanism. The U-NII device is required to have the capability to operate at least 6 dB below the mean EIRP value of 30 dBm. A TPC mechanism is not required for systems with an e.i.r.p. of less than 500 mW.

U-NII devices operating in the 5.25-5.35 GHz and 5.47-5.725 GHz bands shall employ a DFS radar detection mechanism to detect the presence of radar systems and to avoid co-channel operation with radar systems.

#### 3.2. Product Specification Table

| Specification Items        | Description  |
|----------------------------|--|
| Product Type               | For 802.11a IEEE 802.11n: WLAN (2TX, 2RX)<br>For 802.11a : WLAN (1TX, 1RX)   |
| Radio Type                 | Intentional Transceiver  |
| Power Type                 | From Host System   |
| Modulation                 | see the below table for IEEE 802.11n<br>OFDM (BPSK / QPSK / 16QAM / 64QAM) for IEEE 802.11a  |
| Data Rate (Mbps)           | see the below table for IEEE 802.11n<br>OFDM (6/9/12/18/24/36/48/54) for IEEE 802.11a  |
| Operating Frequency Range  | 5250~5350 / 5470~5725  |
| Channel Bandwidth          | 20/40 MHz operating channel bandwidth  |
| DFS Function               | Client (without radar detection function)  |
| Max. Con. Power (DFS band) | IEEE 802.11n:<br>Band 2: MCS8 (20MHz): 18.11 dBm ; MCS8 (40MHz): 19.24 dBm<br>Band 3: MCS8 (20MHz): 19.50 dBm ; MCS8 (40MHz): 20.20 dBm<br>802.11a:<br>Band 2: 20.00 dBm ; Band 3: 19.34 dBm |
| Min. Con. Power (DFS band) | IEEE 802.11n:<br>Band 2: MCS8 (20MHz): 12.11 dBm ; MCS8 (40MHz): 13.24 dBm<br>Band 3: MCS8 (20MHz): 13.50 dBm ; MCS8 (40MHz): 14.20 dBm<br>802.11a:<br>Band 2: 14.00 dBm ; Band 3: 13.34 dBm |
| Max. EIRP Power (DFS band) | IEEE 802.11n:<br>Band 2: MCS8 (20MHz): 23.11 dBm ; MCS8 (40MHz): 24.24 dBm<br>Band 3: MCS8 (20MHz): 24.50 dBm ; MCS8 (40MHz): 25.20 dBm<br>802.11a:  |

|                            |  |
|----------------------------|--|
|                            | Band 2: 25.00 dBm ; Band 3: 24.34 dBm  |
| Min. EIRP Power (DFS band) | IEEE 802.11n:<br>Band 2: MCS8 (20MHz): 17.11 dBm ; MCS8 (40MHz): 18.24 dBm<br>Band 3: MCS8 (20MHz): 18.50 dBm ; MCS8 (40MHz): 19.20 dBm<br>802.11a:<br>Band 2: 19.00 dBm ; Band 3: 18.34 dBm |
| TPC Function               | This device does not exceed 27dBm eirp, so no transmit power control is implemented.   |
| Operating Mode             | Client (without radar detection function)  |
| Communication Mode         | IP based system  |
| Power-on cycle             | NA (No Channel Availability Check Function)  |
| Software Version           | 5.10.79.39   |
| Carrier Frequencies        | Please refer to section 3.4  |
| Antenna                    | Please refer to section 3.5  |

#### Antenna & Band width

| Antenna         | Single (TX) |        | Two (TX) |        |
|-----------------|-------------|--------|----------|--------|
|                 | 20 MHz      | 40 MHz | 20 MHz   | 40 MHz |
| Band width Mode |             |        |          |        |
| IEEE 802.11a    | V           | X      | X        | X      |
| IEEE 802.11n    | X           | X      | V        | V      |

## IEEE 802.11n spec

| MCS Index | Nss | Modulation | R   | NBPS | NCBPS |       | NDBPS |       | Datarate(Mbps) |       |         |       |
|-----------|-----|------------|-----|------|-------|-------|-------|-------|----------------|-------|---------|-------|
|           |     |            |     |      |       |       |       |       | 800nsGI        |       | 400nsGI |       |
|           |     |            |     |      | 20MHz | 40MHz | 20MHz | 40MHz | 20MHz          | 40MHz | 20MHz   | 40MHz |
| 0         | 1   | BPSK       | 1/2 | 1    | 52    | 108   | 26    | 54    | 6.5            | 13.5  | 7.200   | 15    |
| 1         | 1   | QPSK       | 1/2 | 2    | 104   | 216   | 52    | 108   | 13.0           | 27.0  | 14.400  | 30    |
| 2         | 1   | QPSK       | 3/4 | 2    | 104   | 216   | 78    | 162   | 19.5           | 40.5  | 21.700  | 45    |
| 3         | 1   | 16-QAM     | 1/2 | 4    | 208   | 432   | 104   | 216   | 26.0           | 54.0  | 28.900  | 60    |
| 4         | 1   | 16-QAM     | 3/4 | 4    | 208   | 432   | 156   | 324   | 39.0           | 81.0  | 43.300  | 90    |
| 5         | 1   | 64-QAM     | 2/3 | 6    | 312   | 648   | 208   | 432   | 52.0           | 108.0 | 57.800  | 120   |
| 6         | 1   | 64-QAM     | 3/4 | 6    | 312   | 648   | 234   | 486   | 58.5           | 121.5 | 65.000  | 135   |
| 7         | 1   | 64-QAM     | 5/6 | 6    | 312   | 648   | 260   | 540   | 65.0           | 135.0 | 72.200  | 150   |
| 8         | 2   | BPSK       | 1/2 | 1    | 104   | 216   | 52    | 108   | 13.0           | 27.0  | 14.444  | 30    |
| 9         | 2   | QPSK       | 1/2 | 2    | 208   | 432   | 104   | 216   | 26.0           | 54.0  | 28.889  | 60    |
| 10        | 2   | QPSK       | 3/4 | 2    | 208   | 432   | 156   | 324   | 39.0           | 81.0  | 43.333  | 90    |
| 11        | 2   | 16-QAM     | 1/2 | 4    | 416   | 864   | 208   | 432   | 52.0           | 108.0 | 57.778  | 120   |
| 12        | 2   | 16-QAM     | 3/4 | 4    | 416   | 864   | 312   | 648   | 78.0           | 162.0 | 86.667  | 180   |
| 13        | 2   | 64-QAM     | 2/3 | 6    | 624   | 1296  | 416   | 864   | 104.0          | 216.0 | 115.556 | 240   |
| 14        | 2   | 64-QAM     | 3/4 | 6    | 624   | 1296  | 468   | 972   | 117.0          | 243.0 | 130.000 | 270   |
| 15        | 2   | 64-QAM     | 5/6 | 6    | 624   | 1296  | 520   | 1080  | 130.0          | 270.0 | 144.444 | 300   |

| Symbol | Explanation                             |
|--------|---|
| NSS    | Number of spatial streams               |
| R      | Code rate                               |
| NBPS   | Number of coded bits per single carrier |
| NCBPS  | Number of coded bits per symbol         |
| NDBPS  | Number of data bits per symbol          |
| GI     | guard interval                          |



### 3.3. Accessories

N/A

### 3.4. Table for DFS Band Carrier Frequencies

There are two bandwidth systems for IEEE 802.11n.

For both 20MHz bandwidth systems, use Channel 52, 56, 60, 64, 100, 104, 108, 112, 116, 120, 124, 128, 132, 136, 140.

For both 40MHz bandwidth systems, use Channel 54, 62, 102, 110, 118, 126, 134.

There is one bandwidth system for IEEE 802.11a.

| Frequency Band                     | Channel No. | Frequency | Channel No. | Frequency |
|------------------------------------|-------------|-----------|-------------|-----------|
| 5250~5350 MHz<br>Band 2 (DFS Band) | 52          | 5260 MHz  | 60          | 5300 MHz  |
|                                    | 54          | 5270 MHz  | 62          | 5310 MHz  |
|                                    | 56          | 5280 MHz  | 64          | 5320 MHz  |
| 5470~5725 MHz<br>Band 3 (DFS Band) | 100         | 5500 MHz  | 120         | 5600 MHz  |
|                                    | 102         | 5510 MHz  | 124         | 5620 MHz  |
|                                    | 104         | 5520 MHz  | 126         | 5630 MHz  |
|                                    | 108         | 5540 MHz  | 128         | 5640 MHz  |
|                                    | 110         | 5550 MHz  | 132         | 5660 MHz  |
|                                    | 112         | 5560 MHz  | 134         | 5670 MHz  |
|                                    | 116         | 5580 MHz  | 136         | 5680 MHz  |
|                                    | 118         | 5590 MHz  | 140         | 5700 MHz  |

### 3.5. Table for Filed Antenna

| Ant. | Brand | Model Name | Antenna Type | Connector | Frequency Band | Antenna Gain (dBi) | Antenna Cable |
|------|-------|------------|--------------|-----------|----------------|--------------------|---------------|
| A    | WNC   | DNUB-B1    | PIFA Antenna | I-PEX     | 2.4GHz         | 3.00               | Black         |
|      |       |            |              |           | 5GHz           | 5.00               | Black         |
| B    | WNC   | DNUB-B1    | PIFA Antenna | I-PEX     | 2.4GHz         | 3.00               | White         |
|      |       |            |              |           | 5GHz           | 5.00               | White         |

Note: The EUT has two antenna connectors which can be used for transmitting and receiving simultaneously as 2TX and 2RX.

<For IEEE 802.11a mode (1TX/1RX)>:

Ant. A can be used as transmitting antenna, and Ant. B can be used as receiving antenna.

<For IEEE 802.11n mode (2TX/2RX)>:

Ant. A and Ant. B can transmit and receive simultaneously.

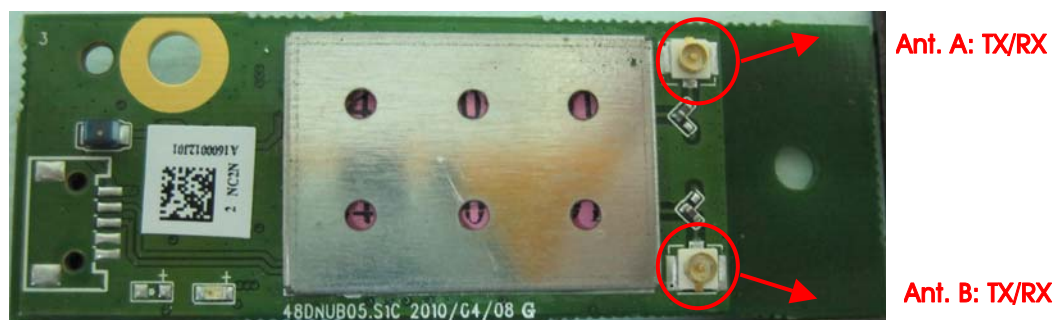

## 4. DFS DETECTION THRESHOLDS AND RADAR TEST WAVEFORMS

### 4.1. Interference Threshold values, Master or Client incorporating In-Service Monitoring

| Maximum Transmit Power | Value (see note) |
|------------------------|------------------|
| ≥ 200 milliwatt        | -64 dBm          |
| < 200 milliwatt        | -62 dBm          |

Note 1: This is the level at the input of the receiver assuming a 0 dBi receive antenna.

Note 2: Throughout these test procedures an additional 1 dB has been added to the amplitude of the test transmission waveforms to account for variations in measurement equipment. This will ensure that the test signal is at or above the detection threshold level to trigger a DFS response.

The radar *Detection Threshold*, lowest antenna gain is the parameter of Interference *radar DFS detection threshold*, The Interference *Detection Threshold* is the **(-64 dBm) + 1 dB = -63dBm**.

### 4.2. DFS Response requirement values

| Parameter                                | Value  |
|--|--|
| <i>Non-occupancy period</i>              | Minimum 30 minutes   |
| <i>Channel Availability Check Time</i>   | 60 seconds   |
| <i>Channel Move Time</i>                 | 10 seconds See Note 1.   |
| <i>Channel Closing Transmission Time</i> | 200 milliseconds + an aggregate of 60 milliseconds over remaining 10 second period. See Notes 1 and 2. |
| <i>U-NII Detection Bandwidth</i>         | Minimum 80% of the 99% power bandwidth See Note 3.   |

Note 1: The instant that the *Channel Move Time* and the *Channel Closing Transmission Time* begins is as follows:

- For the Short pulse radar Test Signals this instant is the end of the *Burst*.
- For the Frequency Hopping radar Test Signal, this instant is the end of the last radar *Burst* generated.
- For the Long Pulse radar Test Signal this instant is the end of the 12 second period defining the radar transmission.

Note 2: The *Channel Closing Transmission Time* is comprised of 200 milliseconds starting at the beginning of the *Channel Move Time* plus any additional intermittent control signals required to facilitate *Channel* changes (an aggregate of 60 milliseconds) during the remainder of the 10 second period. The aggregate duration of control signals will not count quiet periods in between transmissions.

Note 3: During the *U-NII Detection Bandwidth* detection test, radar type 1 is used and for each frequency step the minimum percentage of detection is 90%. Measurements are performed with no data traffic.

### 4.3. Radar Test Waveforms Minimum Step

Step intervals of 0.1 microsecond for Pulse Width, 1 microsecond for PRI, 1 MHz for chirp width and 1 for the number of pulses will be utilized for the random determination of specific test waveforms.

### 4.4. Short Pulse Radar Test Waveforms

| Radar Type                  | Pulse Width ( $\mu\text{sec}$ ) | PRI ( $\mu\text{sec}$ ) | Number of Pulses | Minimum Percentage of Successful Detection | Minimum Trials |
|-----------------------------|---------------------------------|-------------------------|------------------|--|----------------|
| 1                           | 1                               | 1428                    | 18               | 60%  | 30             |
| 2                           | 1-5                             | 150-230                 | 23-29            | 60%  | 30             |
| 3                           | 6-10                            | 200-500                 | 16-18            | 60%  | 30             |
| 4                           | 11-20                           | 200-500                 | 12-16            | 60%  | 30             |
| Aggregate (Radar Types 1-4) |                                 |                         |                  | 80%  | 120            |

A minimum of 30 unique waveforms are required for each of the short pulse radar types 2 through 4. For short pulse radar type 1, the same waveform is used a minimum of 30 times. If more than 30 waveforms are used for short pulse radar types 2 through 4, then each additional waveform must also be unique and not repeated from the previous waveforms. The aggregate is the average of the percentage of successful detections of short pulse radar types 1-4.

#### FCC Radar Types (1~4) System Diagram

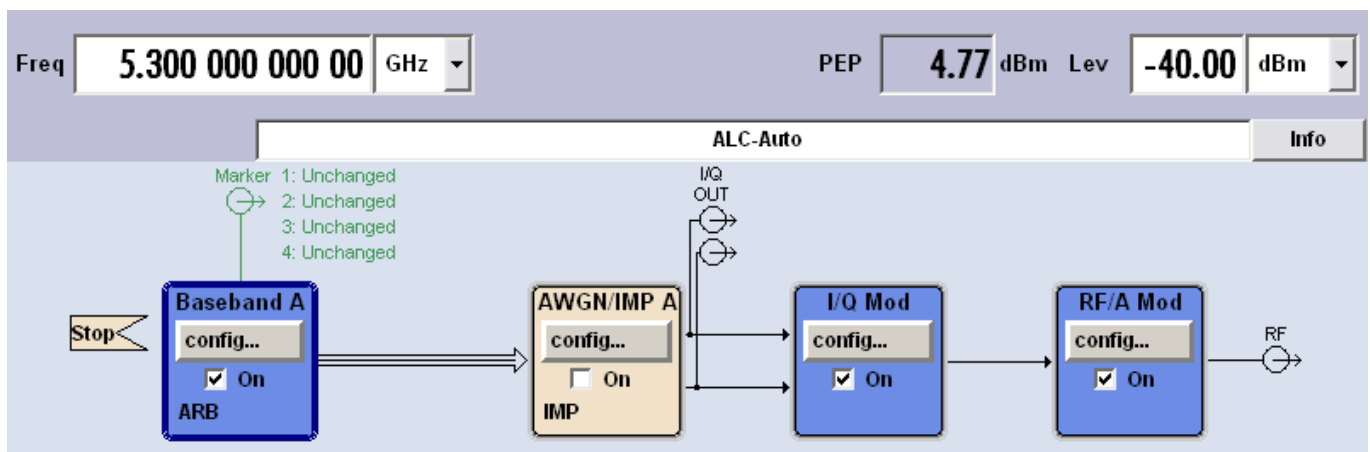

Used R&S SMU200A (Vector SG with one ARB) or SG + ARB

B11: Base-band Generator with ARB (16 M samples) and Digital Modulation

B13: Base-band Main Module

B106: frequency range (100 kHz to 6 GHz)

For selecting the waveform parameters from within the bounds of the signal type, system were random selection using uniform distribution.

#### 4.5. Long Pulse Radar Test Waveform

| Radar Type | Pulse Width ( $\mu\text{sec}$ ) | Chirp Width (MHz) | PRI ( $\mu\text{sec}$ ) | Number of Pulses per Burst | Number of Bursts | Minimum Percentage of Successful Detection | Minimum Trials |
|------------|---------------------------------|-------------------|-------------------------|----------------------------|------------------|--|----------------|
| 5          | 50-100                          | 5-20              | 1000-2000               | 1-3                        | 8-20             | 80%  | 30             |

The parameters for this waveform are randomly chosen. Thirty unique waveforms are required for the Long Pulse radar test signal. If more than 30 waveforms are used for the Long Pulse radar test signal, then each additional waveform must also be unique and not repeated from the previous waveforms. Each waveform is defined as follows:

- (1) The transmission period for the Long Pulse Radar test signal is 12 seconds.
- (2) There are a total of 8 to 20 Bursts in the 12 second period, with the number of Bursts being randomly chosen. This number is Burst\_Count.
- (3) Each Burst consists of 1 to 3 pulses, with the number of pulses being randomly chosen. Each Burst within the 12 second sequence may have a different number of pulses.
- (4) The pulse width is between 50 and 100 microseconds, with the pulse width being randomly chosen. Each pulse within a Burst will have the same pulse width. Pulses in different Bursts may have different pulse widths.
- (5) Each pulse has a linear FM chirp between 5 and 20 MHz, with the chirp width being randomly chosen. Each pulse within a Burst will have the same chirp width. Pulses in different Bursts may have different chirp widths. The chirp is centered on the pulse. For example, with a radar frequency of 5300 MHz and a 20 MHz chirped signal, the chirp starts at 5290 MHz and ends at 5310 MHz.
- (6) If more than one pulse is present in a Burst, the time between the pulses will be between 1000 and 2000 microseconds, with the time being randomly chosen. If three pulses are present in a Burst, the time between the first and second pulses is chosen independently of the time between the second and third pulses.
- (7) The 12 second transmission period is divided into even intervals. The number of intervals is equal to Burst\_Count. Each interval is of length  $(12,000,000 / \text{Burst\_Count})$  microseconds. Each interval contains one Burst. The start time for the Burst, relative to the beginning of the interval, is between 1 and  $[(12,000,000 / \text{Burst\_Count}) - (\text{Total Burst Length}) + (\text{One Random PRI Interval})]$  microseconds, with the start time being randomly chosen. The step interval for the start time is 1 microsecond. The start time for each Burst is chosen independently.

A representative example of a Long Pulse radar test waveform:

- (1) The total test signal length is 12 seconds.
- (2) 8 Bursts are randomly generated for the Burst\_Count.
- (3) Burst 1 has 2 randomly generated pulses.
- (4) The pulse width (for both pulses) is randomly selected to be 75 microseconds.
- (5) The PRI is randomly selected to be at 1213 microseconds.

- (6) Bursts 2 through 8 are generated using steps 3 – 5.
- (7) Each Burst is contained in even intervals of 1,500,000 microseconds. The starting location for Pulse 1, Burst 1 is randomly generated (1 to 1,500,000 minus the total Burst 1 length + 1 random PRI interval) at the 325,001 microsecond step. Bursts 2 through 8 randomly fall in successive 1,500,000 microsecond intervals (i.e. Burst 2 falls in the 1,500,001 – 3,000,000 microsecond range).

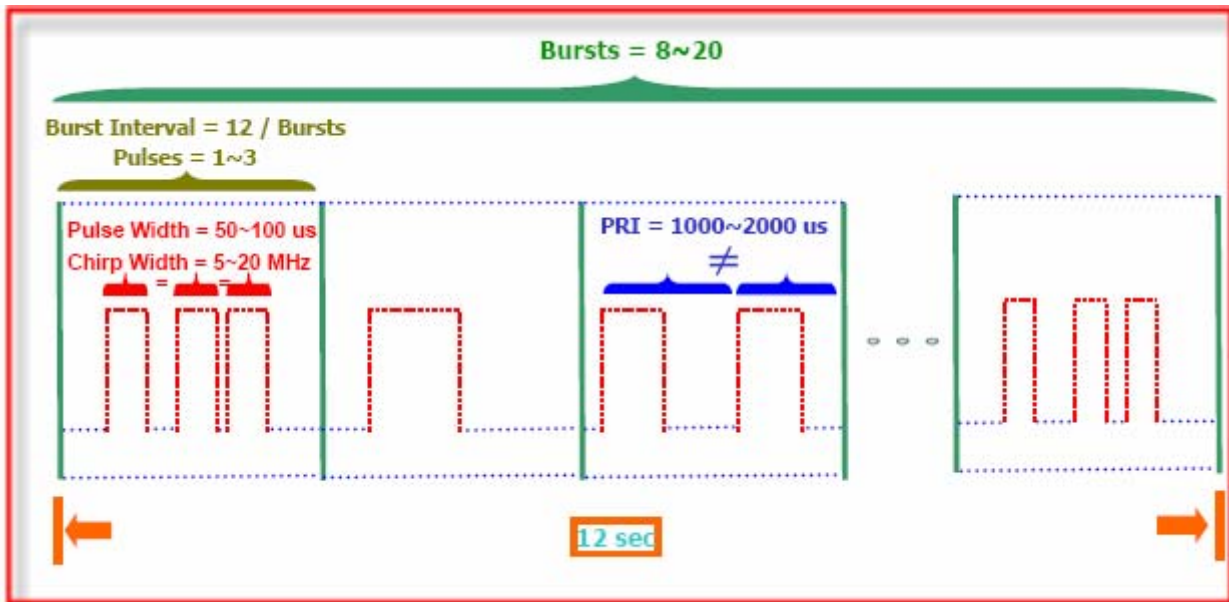

FCC Radar Types (5) System Diagram

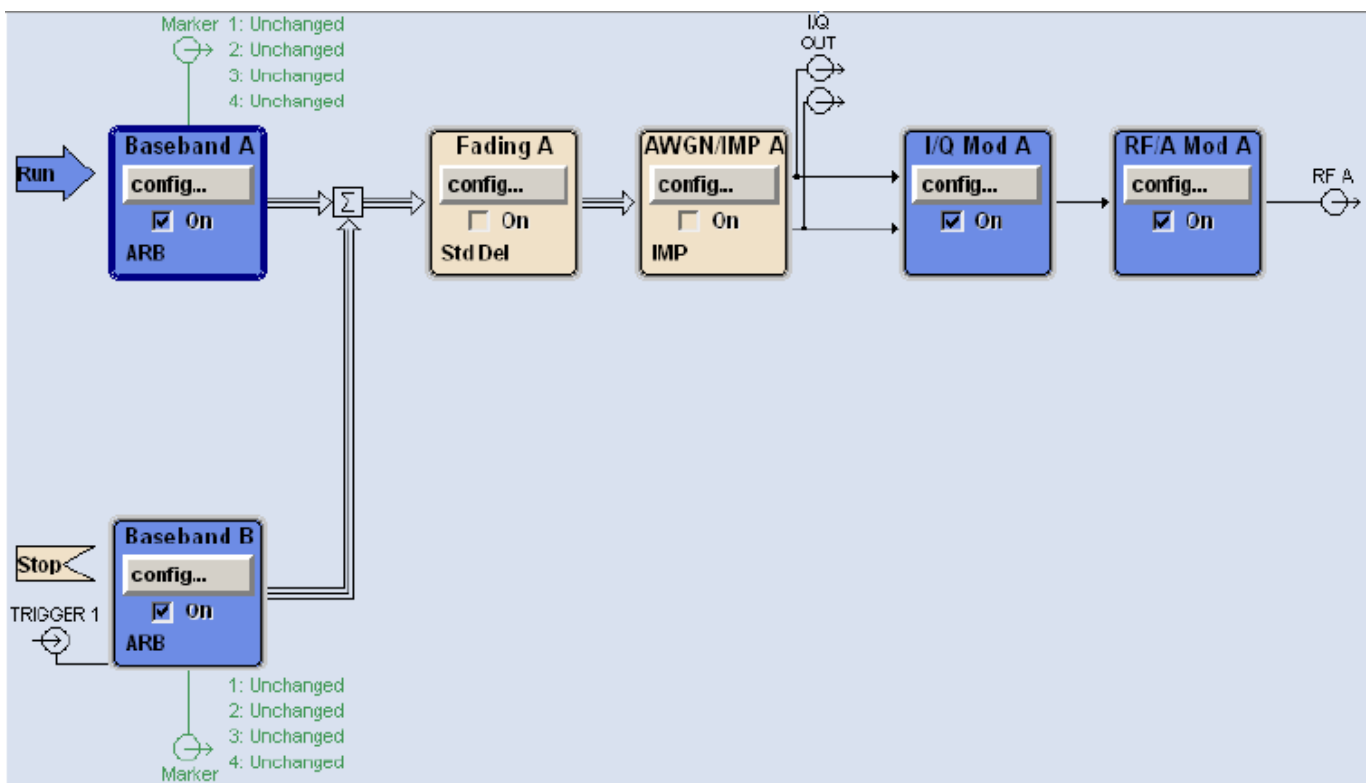

Used R&S SMU200A (Vector SG with two ARB)

Path A / Path B Two B11: Base-band Generator with ARB (16 M samples) and Digital Modulation

B13: Base-band Main Module

B106: frequency range (100 kHz to 6 GHz)

For selecting the waveform parameters from within the bounds of the signal type, system was random selection using uniform distribution.

#### 4.6. Frequency Hopping Radar Test Waveform

| Radar Type | Pulse Width ( $\mu\text{sec}$ ) | PRI ( $\mu\text{sec}$ ) | Pulses per Hop | Hopping Rate (kHz) | Hopping Sequence Length (msec) | Minimum Percentage of Successful Detection | Minimum Trials |
|------------|---------------------------------|-------------------------|----------------|--------------------|--------------------------------|--|----------------|
| 6          | 1                               | 333                     | 9              | 0.333              | 300                            | 70%  | 30             |

For the Frequency Hopping Radar Type, the same Burst parameters are used for each waveform. The hopping sequence is different for each waveform and a 100-length segment is selected from the hopping sequence defined by the following algorithm:

The first frequency in a hopping sequence is selected randomly from the group of 475 integer frequencies from 5250 – 5724 MHz. Next, the frequency that was just chosen is removed from the group and a frequency is randomly selected from the remaining 474 frequencies in the group. This process continues until all 475 frequencies are chosen for the set. For selection of a random frequency, the frequencies remaining within the group are always treated as equally likely.

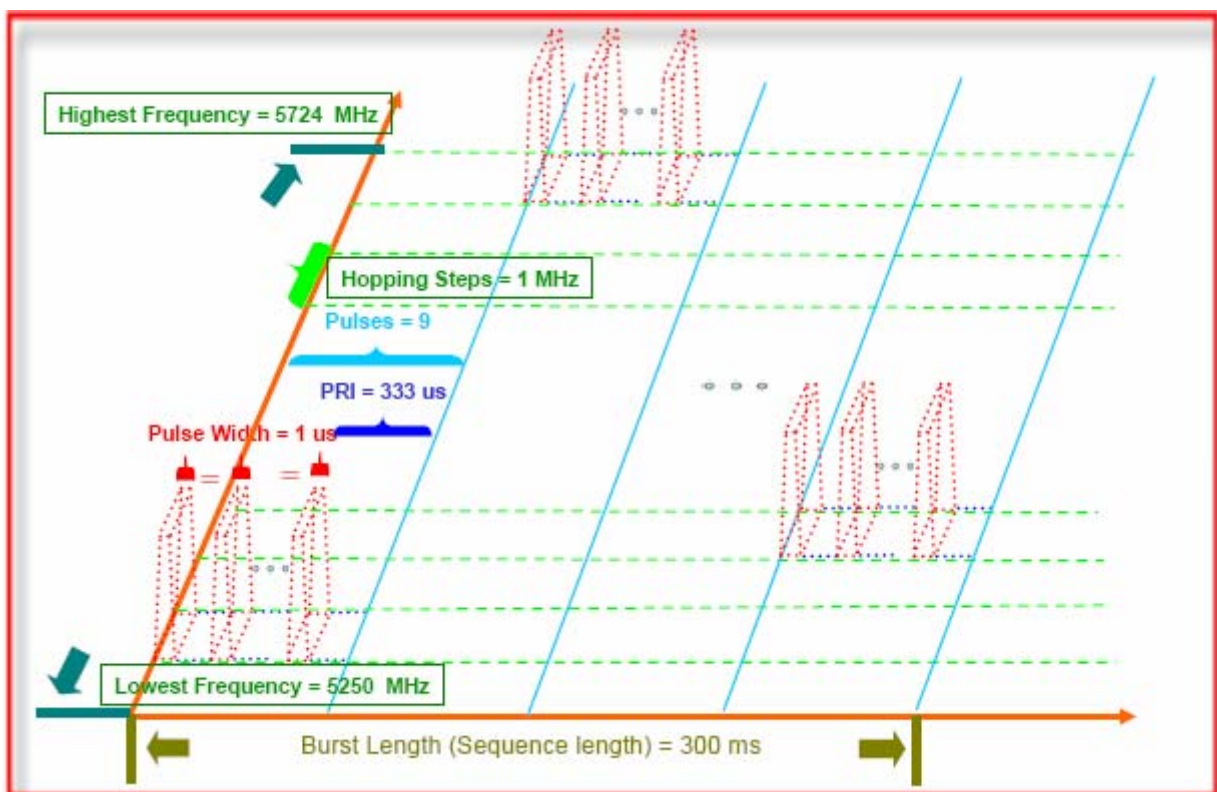

FCC Radar Types (6) System Diagram

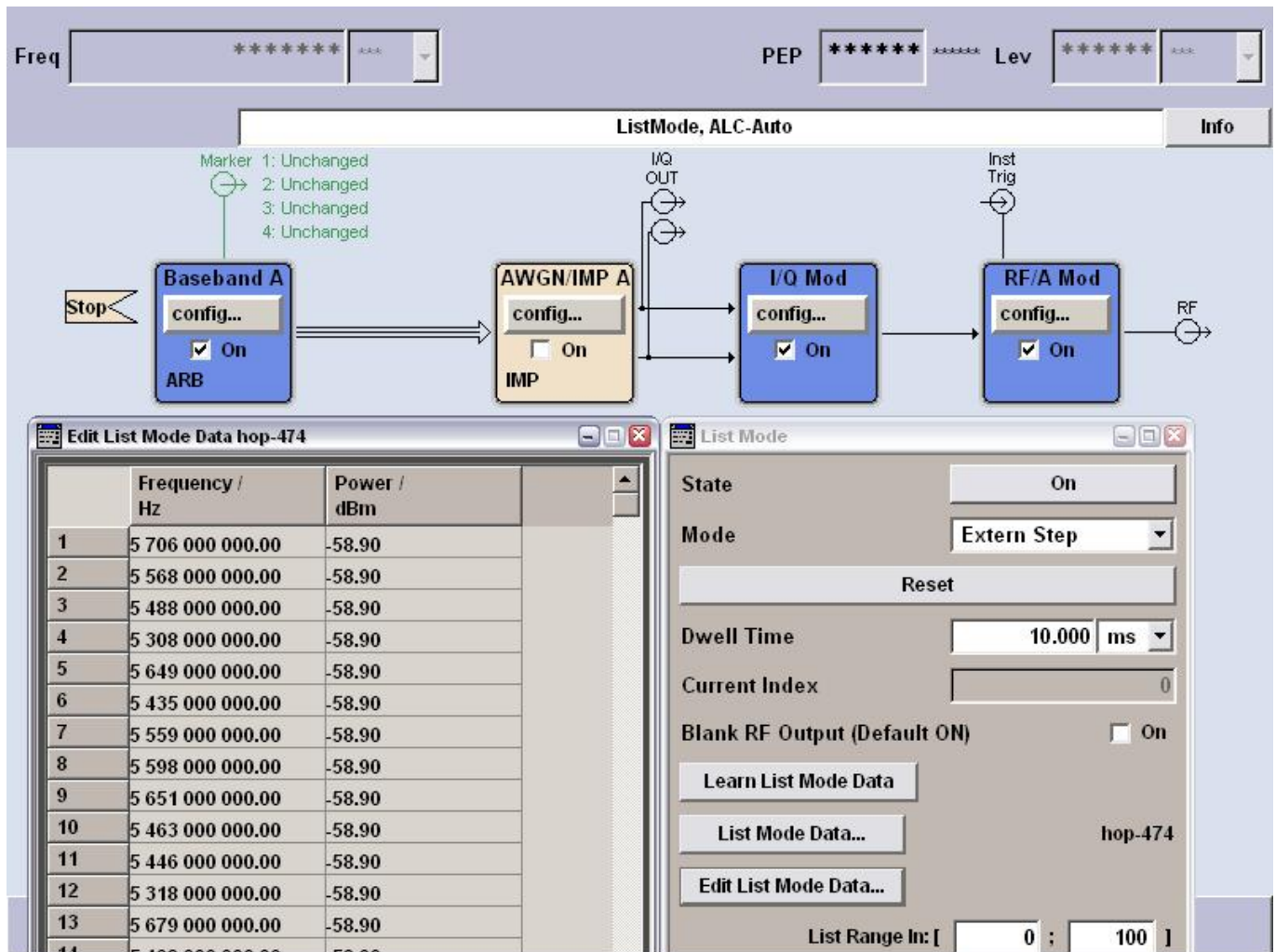

Used R&S SMU200A (Vector SG with one ARB)

B11: Base-band Generator with ARB (16 M samples) and Digital Modulation

B13: Base-band Main Module

B106: frequency range (100 kHz to 6 GHz)

For selecting the waveform parameters from within the bounds of the signal type, system were random selection using uniform distribution.



#### 4.7. Conducted Calibration Setup

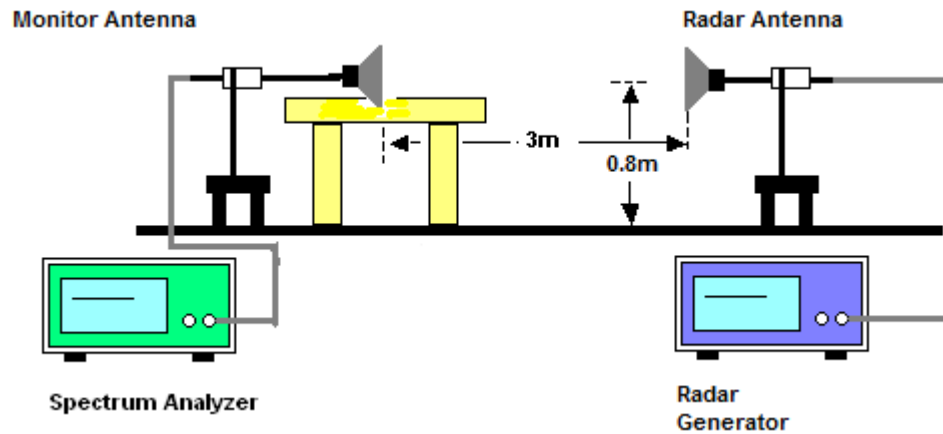

#### 4.8. Radar Waveform Calibration Procedure

The Interference **Radar Detection Threshold Level** is  $(-64\text{dBm}) + 1\text{dB} = -63\text{dBm}$  that had been taken into account the output power range and antenna gain. The above equipment setup was used to calibrate the conducted Radar Waveform. A vector signal generator was utilized to establish the test signal level for each radar type. During this process there were replace 50ohm terminal form Master and Client device and no transmissions by either the Master or Client Device. The spectrum analyzer was switched to the zero span (Time Domain) at the frequency of the Radar Waveform generator. Peak detection was used. The spectrum analyzer resolution bandwidth (RBW) and video bandwidth (VBW) were set to at least 3 MHz. The vector signal generator amplitude was set so that the power level measured at the spectrum analyzer was  $(-64\text{dBm}) + 1\text{dB} = -63\text{dBm}$ . Capture the spectrum analyzer plots on short pulse radar types, long pulse radar type and hopping radar waveform.

#### 4.9. Calibration Deviation

There is no deviation with the original standard.

### 4.10. Radar Waveform Calibration Result

<For 20MHz>:

Radar #1 DFS detection threshold level and the burst of pulses on the Channel frequency

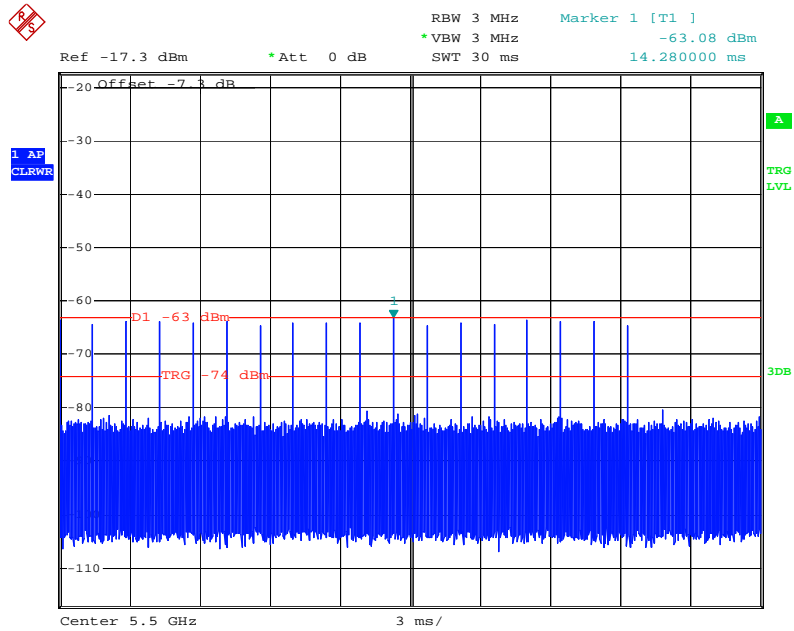

Date: 21.APR.2010 18:26:57

<For 40MHz>:

**Radar #1 DFS detection threshold level and the burst of pulses on the Channel frequency**

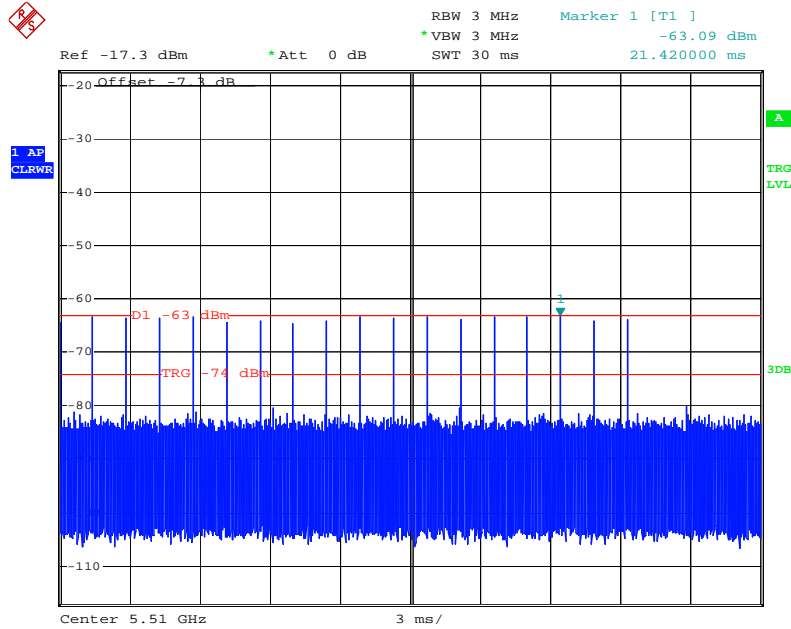

Date: 21.APR.2010 18:29:28

## 5. TEST SETUP AND TEST RESULT

### 5.1. Test setup

#### 5.1.1. Test Setup Diagram

Following is the test setup for generate the radar waveforms and used to monitor UNII device.

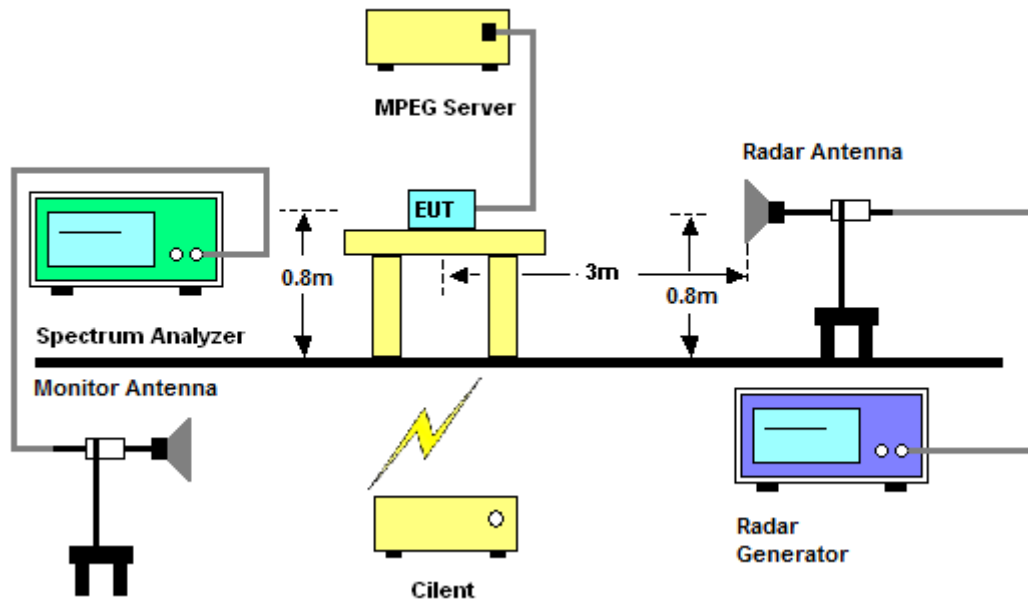

<For 20MHz>:

Master Data Traffic Plot (20 MHz)

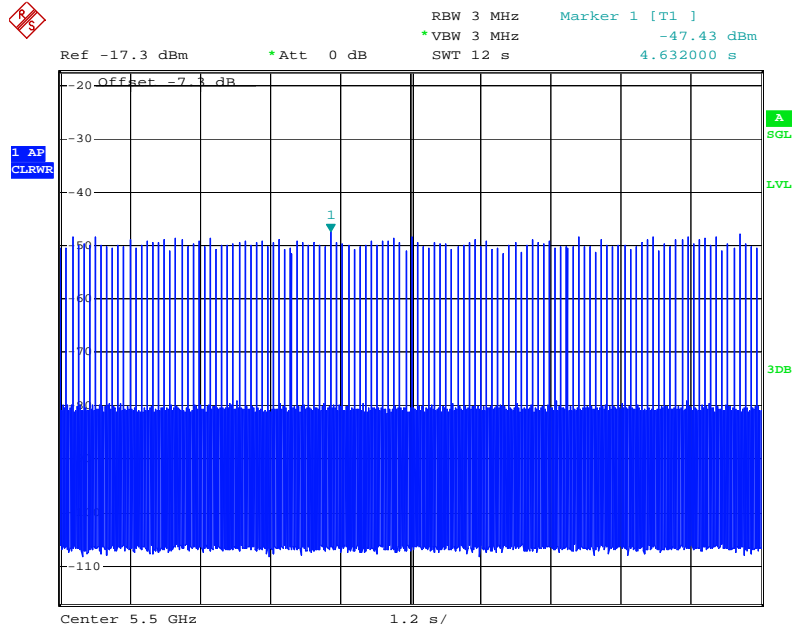

Date: 21.APR.2010 22:35:52

Slave (EUT) Data Traffic Plot (20MHz)

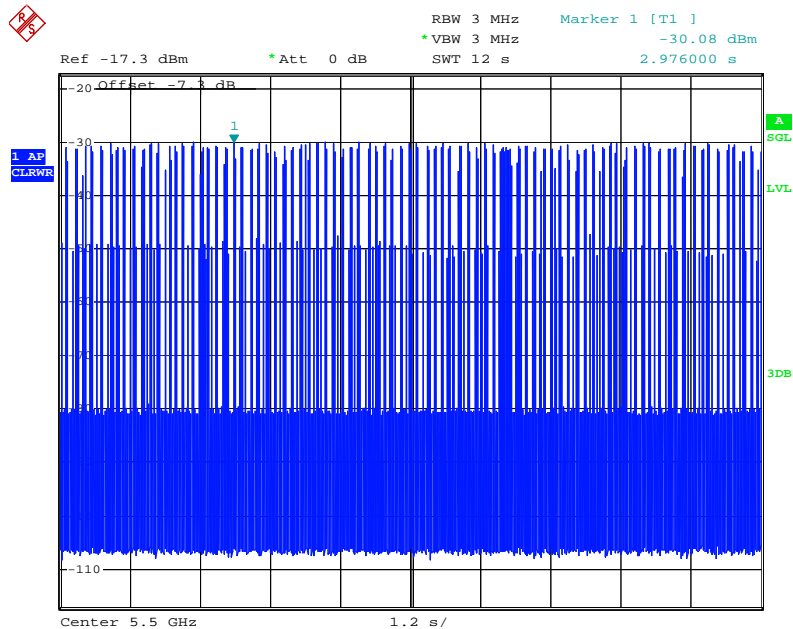

Date: 21.APR.2010 22:37:01

### Without Data Traffic Plot (Noise Plot) (20MHz)

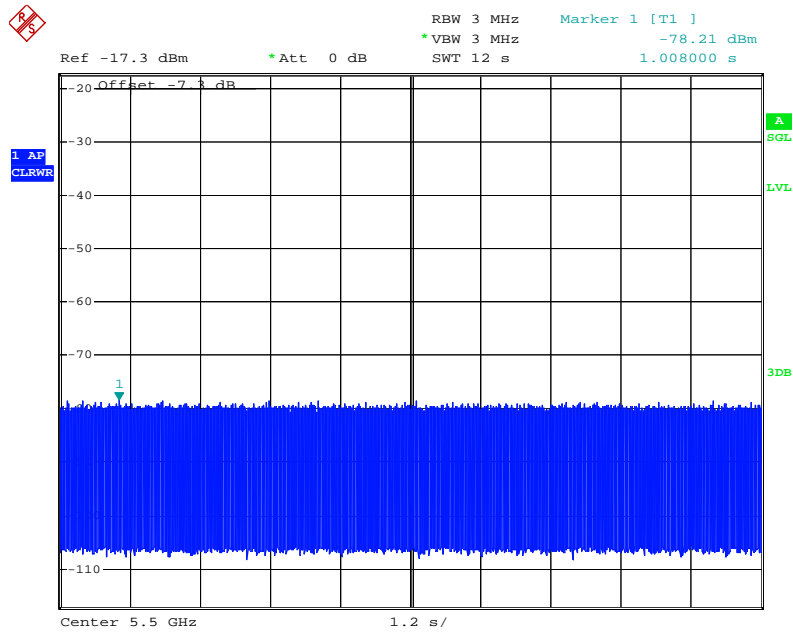

Date: 21.APR.2010 22:45:47

<For 40MHz>:

Master Data Traffic Plot (40 MHz)

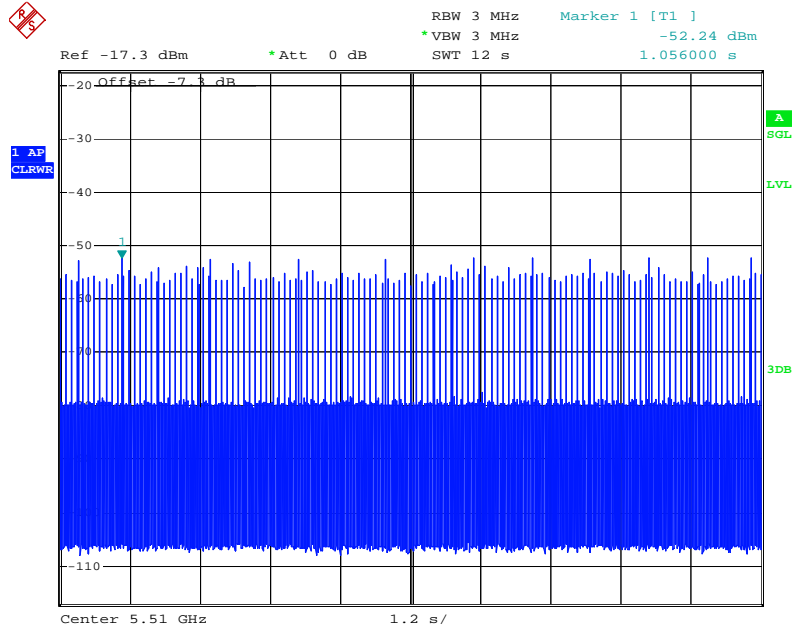

Date: 21.APR.2010 20:29:28

Slave (EUT) Data Traffic Plot (40MHz)

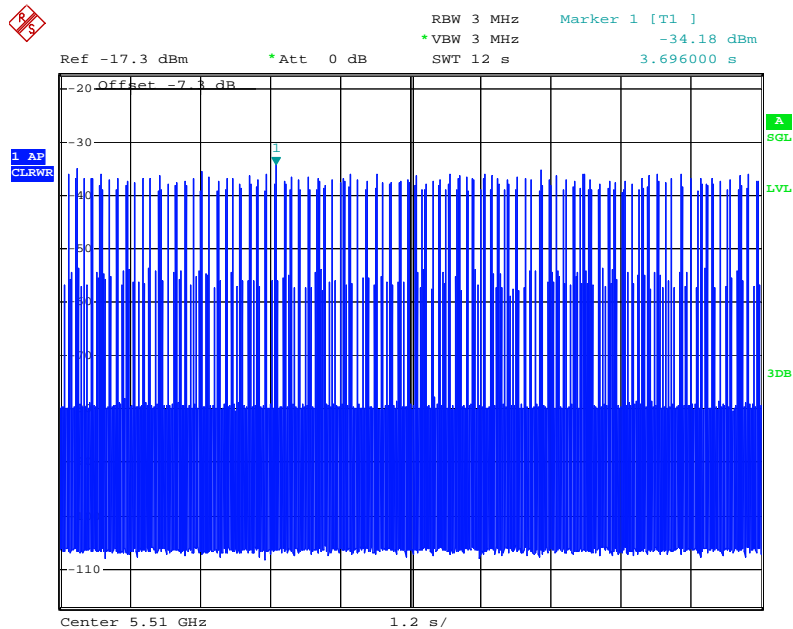

Date: 21.APR.2010 20:32:30

### Without Data Traffic Plot (Noise Plot) (40MHz)

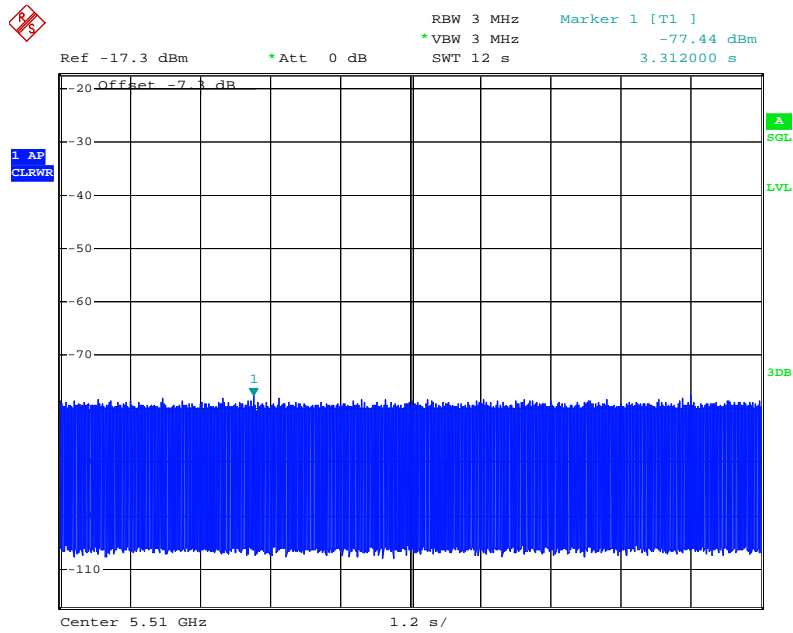

Date: 21.APR.2010 19:23:18



### 5.1.2. Test Setup Photo

FRONT VIEW

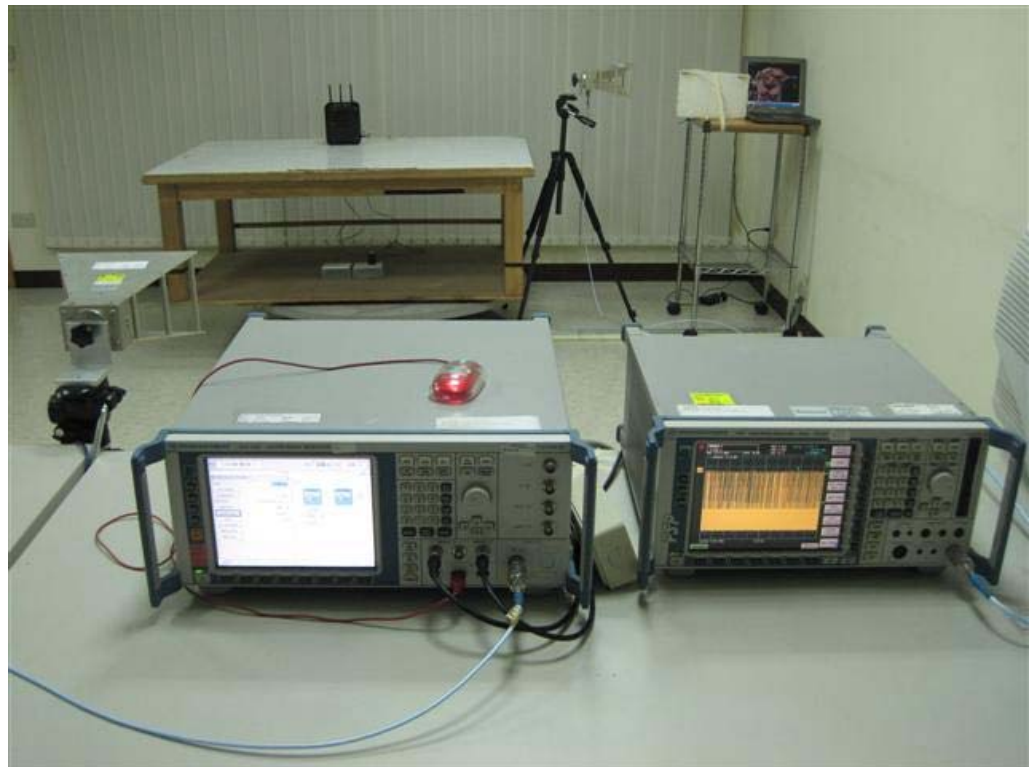

REAR VIEW

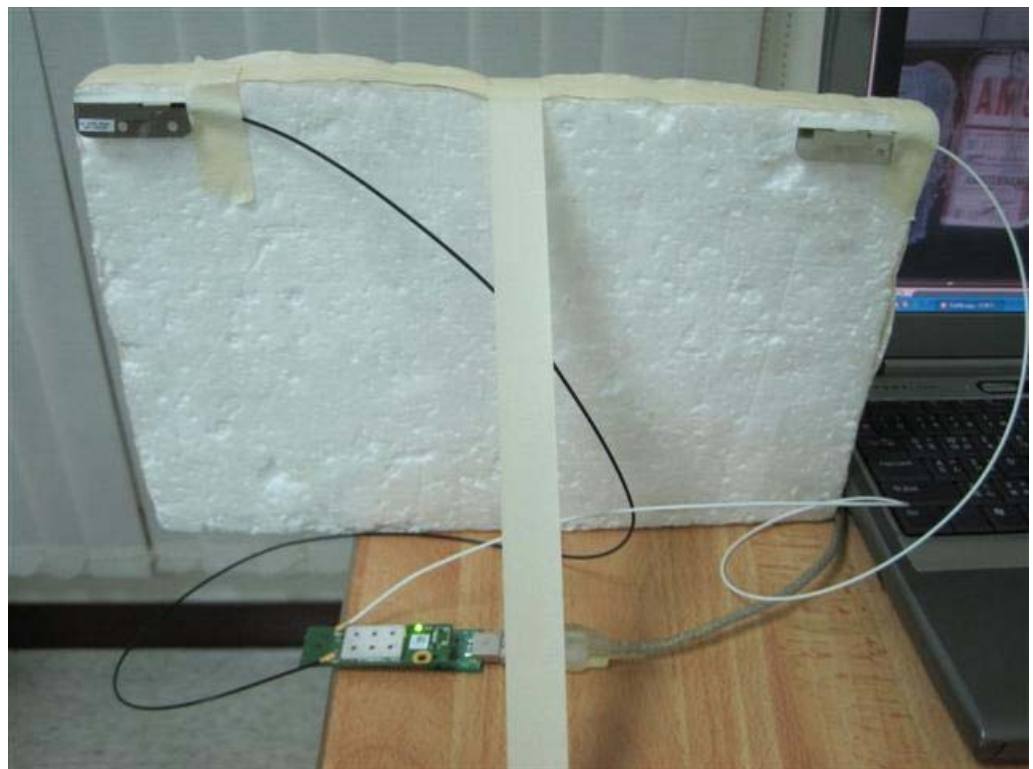

REAR VIEW

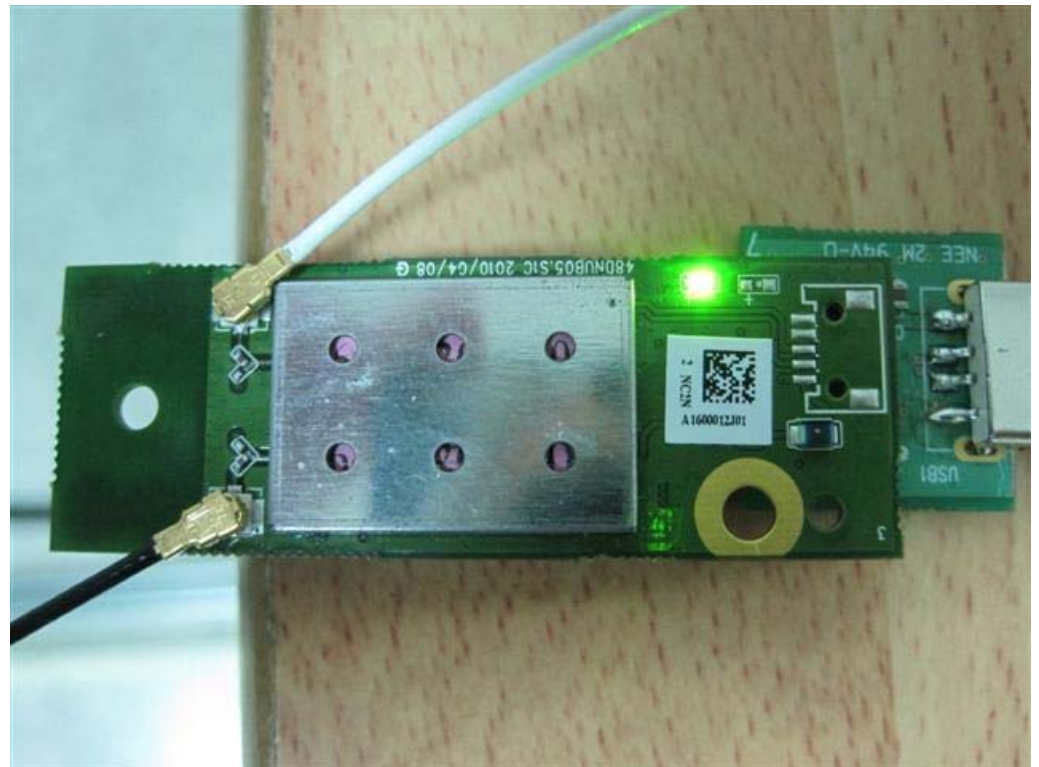

### 5.1.3. Supporting Units

| Support Units | Brand    | Model No.             | Serial No. | FCC ID       | Software Version |
|---------------|----------|-----------------------|------------|--------------|------------------|
| Notebook      | DELL     | D520                  | NB-A       | E2KWM3945ABG | Win XP SP2       |
| Notebook      | DELL     | D400                  | NB-C       | E2K24GBRL    | Win XP SP2       |
| Wireless AP   | Metalink | Mtw_RGPlus_5.0_VB_001 | NA         | VT6-237VB-4B | 02.03.05.35      |

### 5.1.4. Test Setup Operation

System testing was performed with the designated MPEG test file that streams full motion video from the Access Point to the Client in full motion video mode using the media player with the V2.61 Codec package. This file is used by IP and Frame based systems for loading the test channel during the In-service compliance testing of the U-NII device.

The waveform parameters from within the bounds of the signal type are selected randomly using uniform distribution.

A spectrum analyzer is used as a monitor to verify that the EUT has vacated the Channel within the (Channel Closing Transmission Time and Channel Move Time, and does not transmit on a Channel during the Non-Occupancy Period after the detection and Channel move. It is also used to monitor EUT transmissions during the Channel Availability Check Time.

## 5.2. In-Service Monitoring for Channel Move Time, Channel Closing Transmission Time and Non-Occupancy Period Measurement

### 5.2.1. Limit

The EUT has In-Service Monitoring function to continuously monitor the radar signals, If radar is detected, must leave the channel (Shutdown). The Channel Move Time to cease all transmissions on the current Channel upon detection of a Radar Waveform above the DFS Detection Threshold within 10 sec. The total duration of Channel Closing Transmission Time is 260ms, consisting of data signals and the aggregate of control signals, by a U-NII device during the Channel Move Time. The Non-Occupancy Period time is 30 minute during which a Channel will not be utilized after a Radar Waveform is detected on that Channel.

### 5.2.2. Test Procedures

1. When a radar Burst with a level equal to the DFS Detection Threshold + 1dB is generated on the Operating Channel of the U-NII device. A U-NII device operating as a Client Device will associate with the Master at Channel. Stream the MPEG test file from the Master Device to the Client Device on the selected Channel for the entire period of the test. At time T<sub>0</sub> the Radar Waveform generator sends a Burst of pulses for each of the radar types at Detection Threshold + 1dB.
2. Observe the transmissions of the EUT at the end of the radar Burst on the Operating Channel. Measure and record the transmissions from the EUT during the observation time (Channel Move Time). One 10 second plot been reported for the Short Pulse Radar Types 1-4 and one for the Long Pulse Radar Type test in a 22 second plot. The plot for the Short Pulse Radar Types start at the end of the radar burst. The *Channel Move Time* will be calculated based on the plot of the Short Pulse Radar Type. The Long Pulse Radar Type plot show the device ceased transmissions within the 10 second window after detection has occurred. The plot for the Long Pulse Radar Type should start at the beginning of the 12 second waveform.

Measurement of the aggregate duration of the Channel Closing Transmission Time method. With the spectrum analyzer set to zero span tuned to the center frequency of the EUT operating channel at the radar simulated frequency, peak detection, and max hold, the dwell time per bin is given by: **Dwell (2 ms) = S (1 sec) / B (500)** ; where **Dwell** is the dwell time per spectrum analyzer sampling bin, **S** is the sweep time and **B** is the number of spectrum analyzer sampling bins. An upper bound of the aggregate duration of the intermittent control signals of *Channel Closing Transmission Time* is calculated by: **20MHz: C (0 ms) = N (0) X Dwell (2 ms)**, **40MHz: C (0 ms) = N (0) X Dwell (2 ms)**; where **C** is the Closing Time, **N** is the number of spectrum analyzer sampling bins (intermittent control signals) showing a U-NII transmission and **Dwell** is the dwell time per bin.

3. Measure the EUT for more than 30 minutes following the channel close/move time to verify that the EUT does not resume any transmissions on this Channel.

### 5.2.3. Test Deviation

There is no deviation with the original standard.

#### 5.2.4. Result of Channel Move Time & Channel Closing Transmission Time & Non-Occupancy Period

For 20MHz

| Parameter                               | Test Result | Limit         |
|---|-------------|---------------|
|   | Type 1      |               |
| Test Channel (MHz)                      | 5500        | -             |
| Channel Move Time (sec)                 | 0           | < 10s         |
| Intermittent Control Signals(ms) (Note) | 0           | < 60ms        |
| Non-Occupancy Period (min.)             | $\geq 30$   | $\geq 30$ min |

Note: The Channel Closing Transmission Time is comprised of 200 milliseconds starting at the beginning of the Channel Move Time plus any additional intermittent control signals required to facilitate a Channel move (an aggregate of 60 milliseconds) during the remainder of the 10 second period. The aggregate duration of control signals will not count quiet periods in between transmissions.

For 40MHz

| Parameter                               | Test Result | Limit         |
|---|-------------|---------------|
|   | Type 1      |               |
| Test Channel (MHz)                      | 5510        | -             |
| Channel Move Time (sec)                 | 0           | < 10s         |
| Intermittent Control Signals(ms) (Note) | 0           | < 60ms        |
| Non-Occupancy Period (min.)             | $\geq 30$   | $\geq 30$ min |

Note: The Channel Closing Transmission Time is comprised of 200 milliseconds starting at the beginning of the Channel Move Time plus any additional intermittent control signals required to facilitate a Channel move (an aggregate of 60 milliseconds) during the remainder of the 10 second period. The aggregate duration of control signals will not count quiet periods in between transmissions.

### 5.2.5. Channel Move Time Plot

#### Radar #1 Channel Move Time / 20MHz

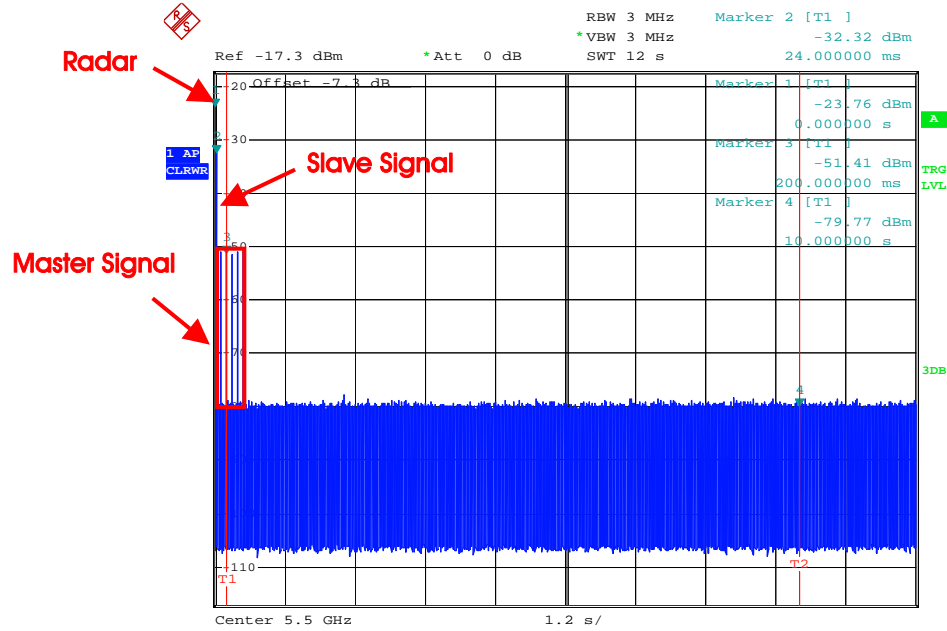

Date: 21.APR.2010 22:39:24

#### Radar #1 Channel Move Time / 40MHz

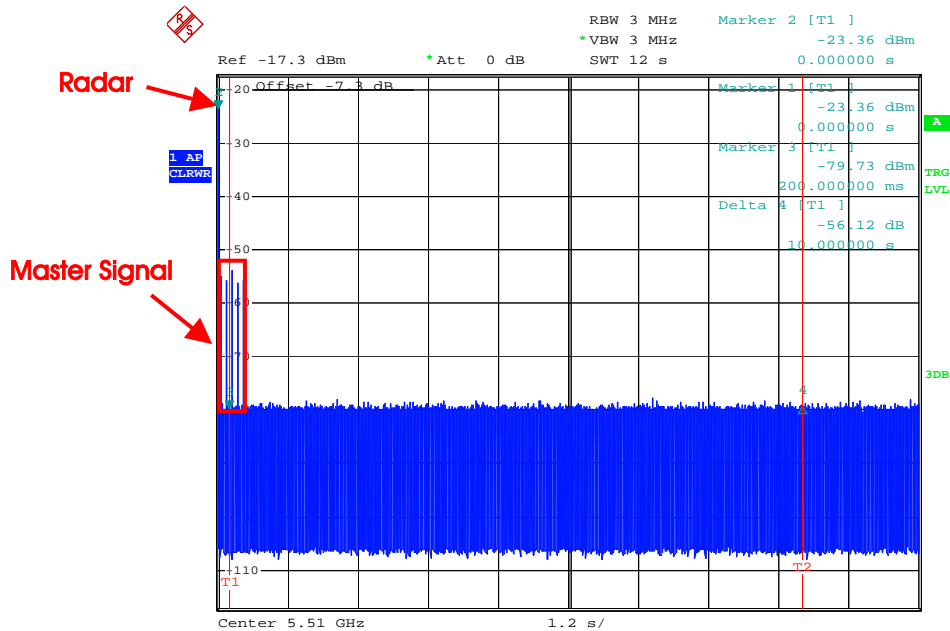

Date: 21.APR.2010 19:21:27

### 5.2.6. Channel Closing Transmission Time Plot

For 20MHz

Radar #1 Channel Closing Transmission Time is comprised of 100 ms starting at the beginning of the Channel Move Time plus 30ms additional intermittent control signals

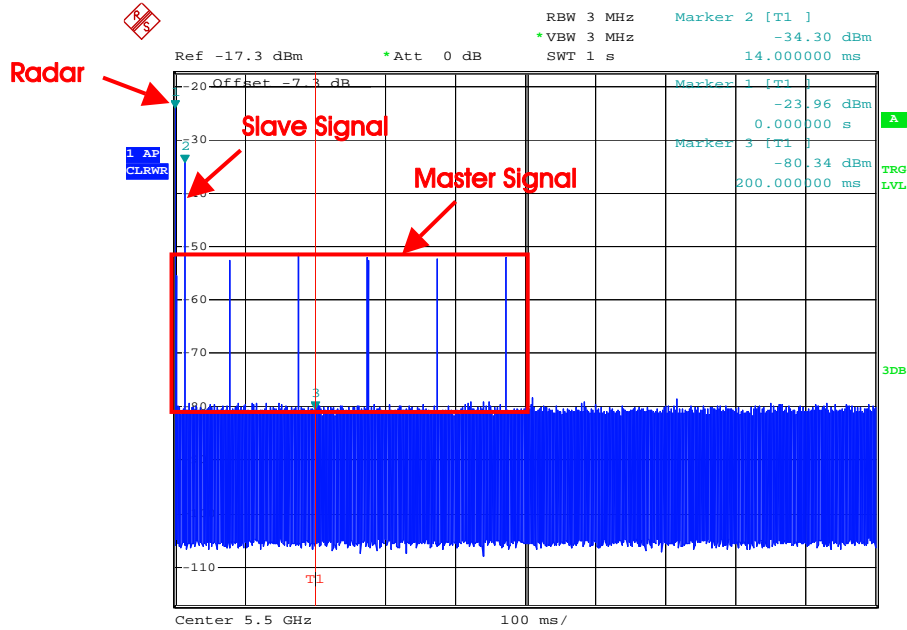

Date: 21.APR.2010 22:44:01

For 40MHz

Radar #1 Channel Closing Transmission Time is comprised of 100 ms starting at the beginning of the Channel Move Time plus 30ms additional intermittent control signals

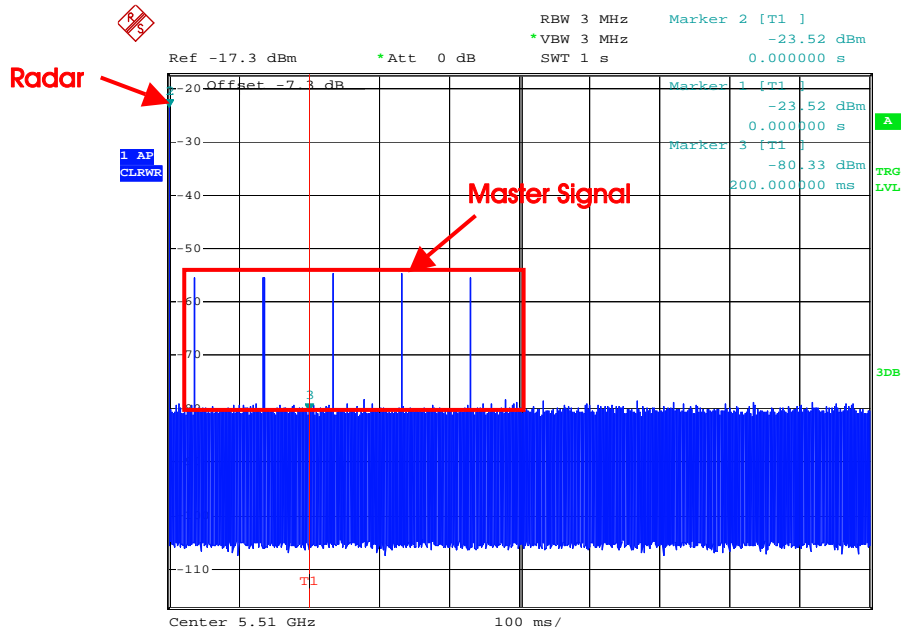

Date: 21.APR.2010 19:26:25

Dwell is the dwell time per spectrum analyzer sampling bin.

S is the sweep time

B is the number of spectrum analyzer sampling bins

C is the intermittent control signals of Channel Closing Transmission Time

N is the number of spectrum analyzer sampling bins (intermittent control signals) showing a U-NII transmission

$$\text{Dwell (2 ms)} = S (1 \text{ sec}) / B (500)$$

$$\text{For 20MHz: } C (0 \text{ ms}) = N (0) \times \text{Dwell (2 ms)}$$

$$\text{For 40MHz: } C (0 \text{ ms}) = N (0) \times \text{Dwell (2 ms)}$$



### 5.2.7. Non-Occupancy Period Plot

For 20MHz

#### Non-Occupancy Period

During the 30 minutes observation time, UUT did not make any transmissions on a channel after a radar signal was detected on that channel by either the Channel Availability Check or the In-Service Monitoring.

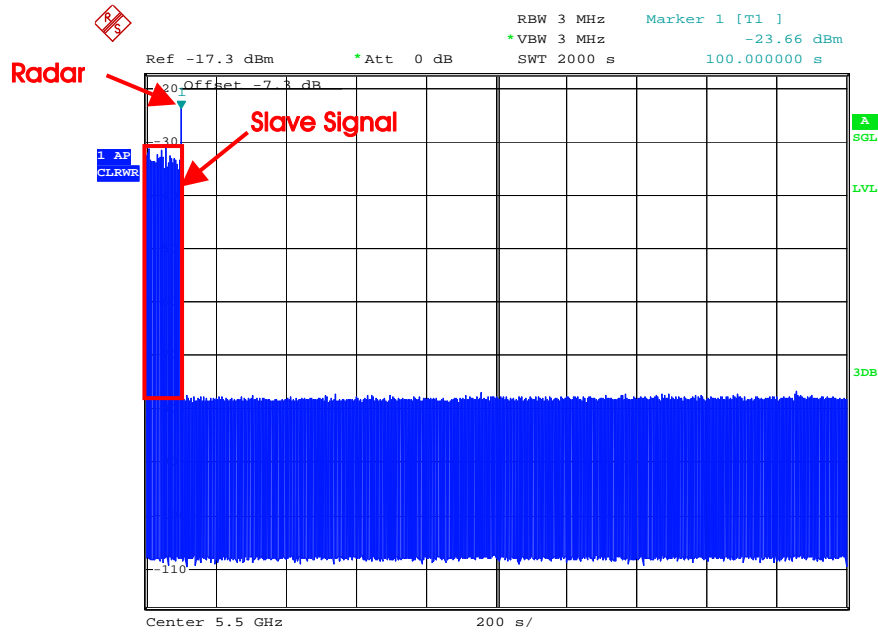

Date: 21.APR.2010 23:30:13

**Non-associated test**

Master was off.

During the 30 minutes observation time, The UUT did not make any transmissions in the DFS band after UUT power up.

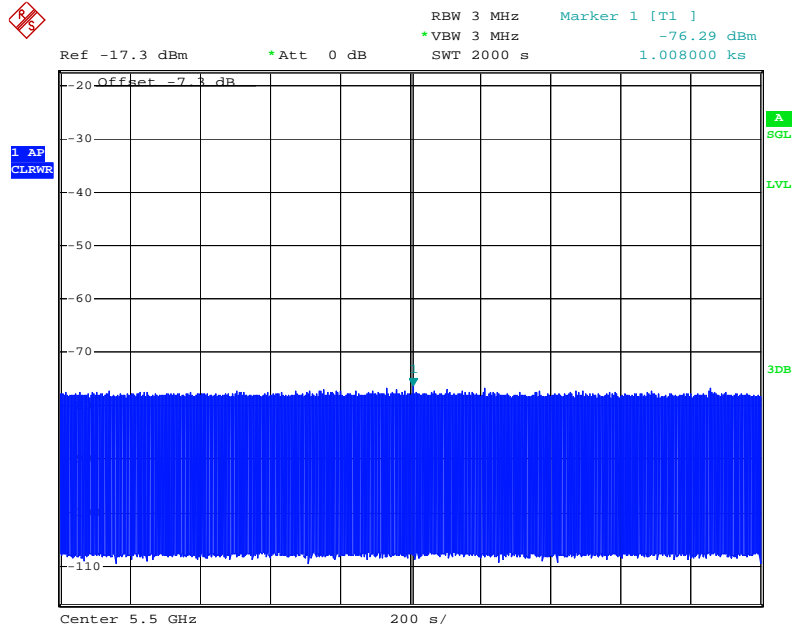

Date: 21.APR.2010 23:51:42

### For 40MHz

#### Non-Occupancy Period

During the 30 minutes observation time, UUT did not make any transmissions on a channel after a radar signal was detected on that channel by either the Channel Availability Check or the In-Service Monitoring.

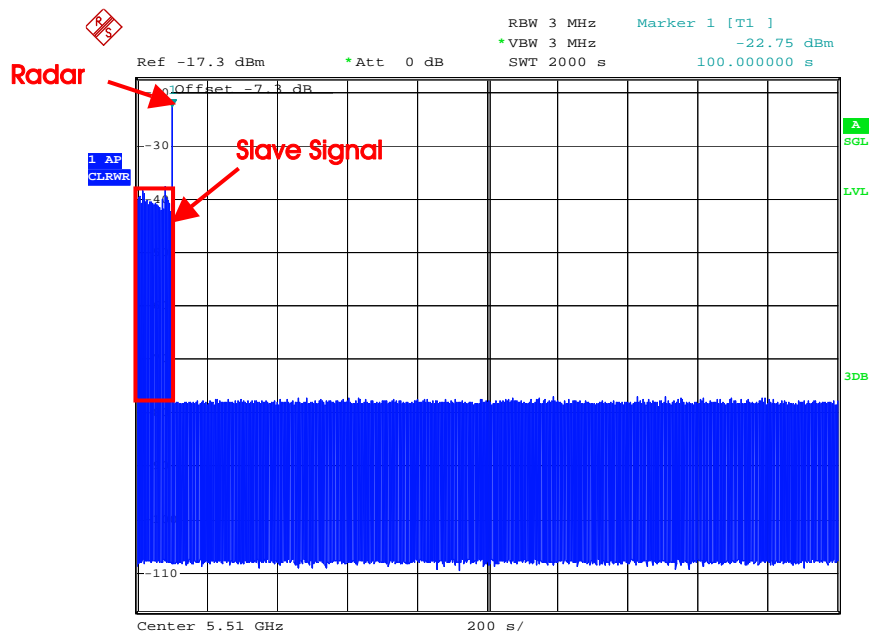

Date: 21.APR.2010 21:54:11

### Non-associated test

Master was off.

During the 30 minutes observation time, The UUT did not make any transmissions in the DFS band after UUT power up.

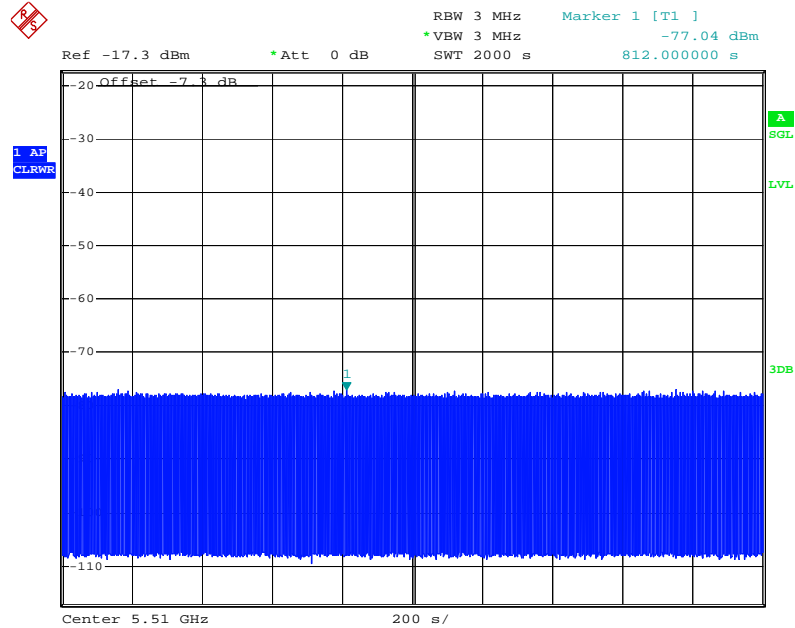

Date: 21.APR.2010 22:30:35

## 6. LIST OF MEASURING EQUIPMENTS

| Instrument                 | Manufacturer | Model No.    | Serial No.        | Characteristics | Calibration Date | Remark              |
|----------------------------|--------------|--------------|-------------------|-----------------|------------------|---------------------|
| Spectrum Analyzer          | R&S          | FSU26.5      | 100015            | 20Hz ~ 26.5GHz  | Oct. 29, 2009    | Conducted (TH01-HY) |
| Power Meter                | R&S          | NRVS         | 100444            | DC ~ 40GHz      | Jul. 31, 2009    | Conducted (TH01-HY) |
| Power Sensor               | R&S          | NRV-Z51      | 100666            | DC ~ 30GHz      | Aug. 05, 2009    | Conducted (TH01-HY) |
| Power Sensor               | R&S          | NRV-Z32      | 100057            | 30MHz ~ 6GHz    | Jul. 31, 2009    | Conducted (TH01-HY) |
| AC Power Source            | HPC          | HPA-500W     | HPA-9100024       | AC 0 ~ 300V     | Jul. 12, 2009*   | Conducted (TH01-HY) |
| DC Power Source            | G.W.         | GPC-6030D    | C671845           | DC 1V ~ 60V     | Mar. 13, 2010    | Conducted (TH01-HY) |
| Temp. and Humidity Chamber | Giant Force  | GTH-225-20-S | MAB0103-001       | N/A             | Aug. 06, 2009    | Conducted (TH01-HY) |
| RF CABLE-1m                | Jye Bao      | RG142        | CB034-1m          | 20MHz ~ 7GHz    | Dec. 02, 2009    | Conducted (TH01-HY) |
| RF CABLE-2m                | Jye Bao      | RG142        | CB035-2m          | 20MHz ~ 1GHz    | Dec. 02, 2009    | Conducted (TH01-HY) |
| Vector Signal Generator    | R&S          | SMU200A      | 102098            | 100kHz ~ 6GHz   | Feb. 13, 2010    | Conducted (TH01-HY) |
| Signal Generator           | R&S          | SMR40        | 100116            | 10MHz ~ 40GHz   | Mar. 25, 2010    | Conducted (TH01-HY) |
| Power Sensor               | Anritsu      | MA2411B      | 0917017           | 300MHz~40GHz    | Dec. 03, 2009    | Conducted (TH01-HY) |
| Power Meter                | Anritsu      | ML2495A      | 0949003           | 300MHz~40GHz    | Dec. 03, 2009    | Conducted (TH01-HY) |
| Spectrum Analyzer          | R&S          | FSP30        | 100023            | 9kHz ~ 30GHz    | Jan. 09, 2010    | Conducted (TH01-HY) |
| RF CABLE-1m                | Jye Bao      | RG142        | CB034-1m          | 20MHz ~ 7GHz    | Dec. 01, 2009    | Conducted (TH01-HY) |
| Vector Signal Generator    | R&S          | SMU200A      | 102098            | 100kHz ~ 6GHz   | Dec. 14, 2009    | Conducted (TH01-HY) |
| RF Power Divider           | HP           | 11636A       | 102934            | N/A             | N/A              | Conducted (TH01-HY) |
| RF Power Splitter          | Anaren       | 44100        | 881840 / 881850   | N/A             | N/A              | Conducted (TH01-HY) |
| RF Power Splitter          | Anaren       | 42100        | 8817950 / 8817960 | N/A             | N/A              | Conducted (TH01-HY) |
| RF Cable-0.5m              | SUHNER       | SUCOFLEX 106 | TH01-HY -01~06    | 1GHz~26.5GHz    | Feb. 04, 2010    | Conducted (TH01-HY) |

Note: Calibration Interval of instruments listed above is one year.

Note: For "\*" Calibration Interval of instruments listed above is two years.

## 7. TEST LOCATION

|        |  |
|--------|--|
| SHIJR  | ADD : 6Fl., No. 106, Sec. 1, Shintai 5th Rd., Shijr City, Taipei, Taiwan 221, R.O.C.<br>TEL : 886-2-2696-2468<br>FAX : 886-2-2696-2255 |
| HWA YA | ADD : No. 52, Hwa Ya 1st Rd., Kwei-Shan Hsiang, Tao Yuan Hsien, Taiwan, R.O.C.<br>TEL : 886-3-327-3456<br>FAX : 886-3-318-0055         |
| LINKOU | ADD : No. 30-2, Dingfu Tsuen, Linkou Shiang, Taipei, Taiwan 244, R.O.C<br>TEL : 886-2-2601-1640<br>FAX : 886-2-2601-1695               |
| DUNGHU | ADD : No. 3, Lane 238, Kangle St., Neihu Chiu, Taipei, Taiwan 114, R.O.C.<br>TEL : 886-2-2631-4739<br>FAX : 886-2-2631-9740            |
| JUNGHE | ADD : 7Fl., No. 758, Jungjeng Rd., Junghe City, Taipei, Taiwan 235, R.O.C.<br>TEL : 886-2-8227-2020<br>FAX : 886-2-8227-2626           |
| NEIHU  | ADD : 4Fl., No. 339, Hsin Hu 2 <sup>nd</sup> Rd., Taipei 114, Taiwan, R.O.C.<br>TEL : 886-2-2794-8886<br>FAX : 886-2-2794-9777         |
| JHUBEI | ADD : No.8, Lane 724, Bo-ai St., Jhubei City, HsinChu County 302, Taiwan, R.O.C.<br>TEL : 886-3-656-9065<br>FAX : 886-3-656-9085       |

## 8. TAF CERTIFICATE OF ACCREDITATION



Certificate No. : L1190-091230

財團法人全國認證基金會  
Taiwan Accreditation Foundation

### Certificate of Accreditation

This is to certify that

**Sporton International Inc.**  
**EMC & Wireless Communications Laboratory**  
No.52, Hwa Ya 1st Rd., Hwa Ya Technology Park, Kwei-Shan Hsiang, Tao Yuan Hsien,  
Taiwan, R.O.C.

**is accredited in respect of laboratory**

|                                       |  |
|---------------------------------------|--|
| <b>Accreditation Criteria</b>         | : ISO/IEC 17025:2005   |
| <b>Accreditation Number</b>           | : 1190   |
| <b>Originally Accredited</b>          | : December 15, 2003  |
| <b>Effective Period</b>               | : January 10, 2010 to January 09, 2013   |
| <b>Accredited Scope</b>               | : Testing Field, see described in the Appendix   |
| <b>Specific Accreditation Program</b> | : Accreditation Program for Designated Testing Laboratory for Commodities Inspection<br>Accreditation Program for Telecommunication Equipment Testing Laboratory<br>Accreditation Program for BSMI Mutual Recognition Arrangement with Foreign Authorities |

*Jay-san Chen*

Jay-San Chen  
President, Taiwan Accreditation Foundation  
Date : December 30, 2009

Pl, total 22 pages

The Appendix forms an integral part of this Certificate, which shall be invalid when use without the Appendix