



SPORTON International Inc.

No. 52, Hwa Ya 1st Rd., Kwei-Shan Hsiang, TaoYuan Hsien, Taiwan, R.O.C.
Ph: 886-3-327-3456 / FAX: 886-3-327-0973 / www.sporton.com.tw

FCC RADIO TEST REPORT

| | |
|------------------------|---|
| Applicant's company | Wistron NeWeb Corporation |
| Applicant Address | 20 Park Avenue II, Hsinchu Science Park, Hsinchu 308, Taiwan, R.O.C. |
| FCC ID | NKR-DNUAE134A |
| Manufacturer's company | Wistron NeWeb Corporation |
| Manufacturer Address | 20 Park Avenue II, Hsinchu Science Park, Hsinchu 308, Taiwan, R.O.C. |

| | |
|-------------------|---|
| Product Name | 802.11a/b/g/n USB Module |
| Brand Name | WNC |
| Model No. | DNUA-E134A |
| Test Rule Part(s) | 47 CFR FCC Part 15 Subpart E § 15.407 |
| Test Freq. Range | 5150 ~ 5350MHz / 5470 ~ 5725MHz |
| Received Date | Apr. 19, 2013 |
| Final Test Date | May 21, 2013 |
| Submission Type | Original Equipment |
| Operating Mode | Client (without radar detection function) |

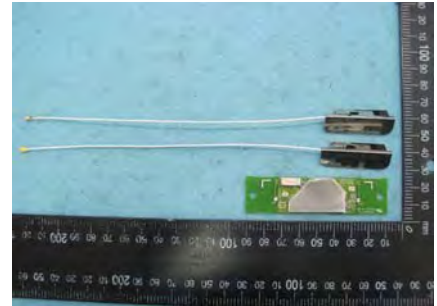

Statement

Test result included is for the IEEE 802.11n and IEEE 802.11a (5150 ~ 5350MHz / 5470 ~ 5725MHz) of the product.

The test result in this report refers exclusively to the presented test model / sample.

Without written approval of SPORTON International Inc., the test report shall not be reproduced except in full.

The measurements and test results shown in this test report were made in accordance with the procedures and found in compliance with the limit given in **ANSI C63.10-2009**,

47 CFR FCC Part 15 Subpart E, KDB 789033 D01 v01r03 and KDB 662911 D01 v01r02.

The test equipment used to perform the test is calibrated and traceable to NML/ROC.





Table of Contents

| | |
|---|----------------|
| 1. CERTIFICATE OF COMPLIANCE | 1 |
| 2. SUMMARY OF THE TEST RESULT | 2 |
| 3. GENERAL INFORMATION | 3 |
| 3.1. Product Details | 3 |
| 3.2. Accessories | 4 |
| 3.3. Table for Filed Antenna | 4 |
| 3.4. Table for Carrier Frequencies | 5 |
| 3.5. Table for Test Modes | 5 |
| 3.6. Table for Testing Locations..... | 6 |
| 3.7. Table for Supporting Units | 7 |
| 3.8. Table for Parameters of Test Software Setting | 7 |
| 3.9. EUT Operation during Test..... | 7 |
| 3.10. Duty Cycle..... | 8 |
| 3.11. Test Configurations..... | 10 |
| 4. TEST RESULT | 12 |
| 4.1. AC Power Line Conducted Emissions Measurement | 12 |
| 4.2. 26dB Bandwidth & 99% Occupied Bandwidth Measurement..... | 16 |
| 4.3. Maximum Conducted Output Power Measurement..... | 33 |
| 4.4. Power Spectral Density Measurement..... | 36 |
| 4.5. Peak Excursion Measurement | 45 |
| 4.6. Radiated Emissions Measurement..... | 54 |
| 4.7. Band Edge Emissions Measurement..... | 85 |
| 4.8. Frequency Stability Measurement..... | 96 |
| 4.9. Antenna Requirements | 98 |
| 5. LIST OF MEASURING EQUIPMENTS | 99 |
| 6. TEST LOCATION | 101 |
| APPENDIX A. TEST PHOTOS | A1 ~ A8 |
| APPENDIX B. MAXIMUM PERMISSIBLE EXPOSURE | B1 ~ B3 |



History of This Test Report

| REPORT NO. | VERSION | DESCRIPTION | ISSUED DATE |
|------------|---------|-------------------------|---------------|
| FR341911AB | Rev. 01 | Initial issue of report | Jun. 03, 2013 |
| | | | |
| | | | |
| | | | |
| | | | |
| | | | |
| | | | |
| | | | |
| | | | |
| | | | |
| | | | |
| | | | |
| | | | |
| | | | |
| | | | |



1. CERTIFICATE OF COMPLIANCE

Product Name : 802.11a/b/g/n USB Module
Brand Name : WNC
Model No. : DNUA-E134A
Applicant : Wistron NeWeb Corporation
Test Rule Part(s) : 47 CFR FCC Part 15 Subpart E § 15.407

Sporton International as requested by the applicant to evaluate the EMC performance of the product sample received on Apr. 19, 2013 would like to declare that the tested sample has been evaluated and found to be in compliance with the tested rule parts. The data recorded as well as the test configuration specified is true and accurate for showing the sample's EMC nature.

A handwritten signature in blue ink that reads 'Sam Chen'.

Sam Chen

SPORTON INTERNATIONAL INC.

2. SUMMARY OF THE TEST RESULT

| Applied Standard: 47 CFR FCC Part 15 Subpart E | | | | |
|--|--------------|--|----------|-------------|
| Part | Rule Section | Description of Test | Result | Under Limit |
| 4.1 | 15.207 | AC Power Line Conducted Emissions | Complies | 10.25 dB |
| 4.2 | 15.407(a) | 26dB Spectrum Bandwidth & 99% Occupied Bandwidth | Complies | - |
| 4.3 | 15.407(a) | Maximum Conducted Output Power | Complies | 0.15 dB |
| 4.4 | 15.407(a) | Power Spectral Density | Complies | 0.11 dB |
| 4.5 | 15.407(a) | Peak Excursion | Complies | 2.67 dB |
| 4.6 | 15.407(b) | Radiated Emissions | Complies | 0.02 dB |
| 4.7 | 15.407(b) | Band Edge Emissions | Complies | 0.04 dB |
| 4.8 | 15.407(g) | Frequency Stability | Complies | - |
| 4.9 | 15.203 | Antenna Requirements | Complies | - |

| Test Items | Uncertainty | Remark |
|---|-----------------------|--------------------------|
| AC Power Line Conducted Emissions | ±2.3dB | Confidence levels of 95% |
| Maximum Conducted Output Power | ±0.5dB | Confidence levels of 95% |
| Power Spectral Density | ±0.5dB | Confidence levels of 95% |
| Peak Excursion | ±0.5dB | Confidence levels of 95% |
| 26dB Spectrum Bandwidth / Frequency Stability | ±8.5×10 ⁻⁸ | Confidence levels of 95% |
| Radiated Emissions (9kHz~30MHz) | ±0.8dB | Confidence levels of 95% |
| Radiated Emissions (30MHz~1000MHz) | ±1.9dB | Confidence levels of 95% |
| Radiated / Band Edge Emissions (1GHz~18GHz) | ±1.9dB | Confidence levels of 95% |
| Radiated Emissions (18GHz~40GHz) | ±1.9dB | Confidence levels of 95% |
| Temperature | ±0.7°C | Confidence levels of 95% |
| Humidity | ±3.2% | Confidence levels of 95% |
| DC / AC Power Source | ±1.4% | Confidence levels of 95% |

3. GENERAL INFORMATION

3.1. Product Details

IEEE 802.11n

| Items | Description |
|--------------------------------|---|
| Product Type | WLAN (2TX, 2RX) |
| Radio Type | Intentional Transceiver |
| Power Type | From Host System |
| Modulation | see the below table for IEEE 802.11n |
| Data Modulation | OFDM (BPSK / QPSK / 16QAM / 64QAM) |
| Data Rate (Mbps) | see the below table for IEEE 802.11n |
| Frequency Range | 5150 ~ 5350MHz / 5470 ~ 5725MHz |
| Channel Number | 16 for 20MHz bandwidth ; 7 for 40MHz bandwidth |
| Channel Band Width (99%) | MCS0 (20MHz): 26.08 MHz ; MCS0 (40MHz): 59.52 MHz |
| Maximum Conducted Output Power | Band 1: MCS0 (20MHz): 14.92 dBm ; MCS0 (40MHz): 16.85 dBm Band 2: MCS0 (20MHz): 21.11 dBm ; MCS0 (40MHz): 21.10 dBm Band 3: MCS0 (20MHz): 20.04 dBm ; MCS0 (40MHz): 20.52 dBm |
| Carrier Frequencies | Please refer to section 3.4 |
| Antenna | Please refer to section 3.3 |

IEEE 802.11a

| Items | Description |
|--------------------------------|---|
| Product Type | WLAN (2TX, 2RX) |
| Radio Type | Intentional Transceiver |
| Power Type | From Host System |
| Modulation | OFDM for IEEE 802.11a |
| Data Modulation | OFDM (BPSK / QPSK / 16QAM / 64QAM) |
| Data Rate (Mbps) | OFDM (6/9/12/18/24/36/48/54) |
| Frequency Range | 5150 ~ 5350MHz / 5470 ~ 5725MHz |
| Channel Number | 16 |
| Channel Band Width (99%) | 24.16 MHz |
| Maximum Conducted Output Power | Band 1: 14.99 dBm ; Band 2: 21.61 dBm ; Band 3: 20.02 dBm |
| Carrier Frequencies | Please refer to section 3.4 |
| Antenna | Please refer to section 3.3 |

Antenna & Band width

| Antenna | Two (TX) | |
|-----------------|----------|--------|
| Band width Mode | 20 MHz | 40 MHz |
| IEEE 802.11a | V | X |
| IEEE 802.11n | V | V |

IEEE 11n Spec.

| Protocol | Number of Transmit Chains (NTX) | Data Rate / MCS |
|----------------|---------------------------------|-----------------|
| 802.11n (HT20) | 2 | MCS 0-15 |
| 802.11n (HT40) | 2 | MCS 0-15 |

Note 1: IEEE Std. 802.11n modulation consists of HT20 and HT40 (HT: High Throughput). Then EUT support HT20 and HT40.

Note 2: Modulation modes consist of below configuration:
HT20/HT40: IEEE 802.11n

3.2. Accessories

N/A

3.3. Table for Filed Antenna

| Ant. | Brand | Model Name | Antenna Type | Connector | Gain (dBi) | |
|------|-------|------------|--------------|-----------|------------|------|
| | | | | | 2.4GHz | 5GHz |
| 1 | WNC | EAAH-N22 | PIFA Antenna | I-PEX | 4.05 | 5.22 |
| 2 | WNC | EAAH-N22 | PIFA Antenna | I-PEX | 3.67 | 5.65 |

Note: The EUT has two antennas.

Chain 1 and Chain 2 could transmit/receive simultaneously.

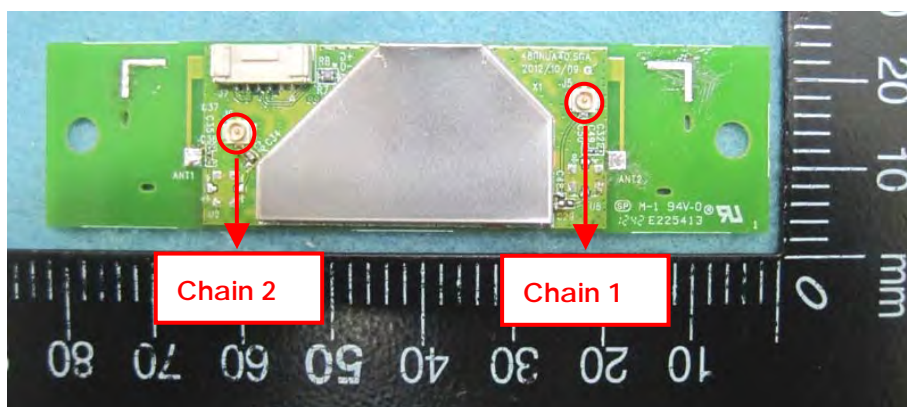

3.4. Table for Carrier Frequencies

The EUT has two bandwidth system.

For 20MHz bandwidth systems, use Channel 36, 40, 44, 48, 52, 56, 60, 64, 100, 104, 108, 112, 116, 132, 136, 140.

For 40MHz bandwidth systems, use Channel 38, 46, 54, 62, 102, 110, 134.

| Frequency Band | Channel No. | Frequency | Channel No. | Frequency |
|-------------------------|-------------|-----------|-------------|-----------|
| 5150~5250 MHz Band 1 | 36 | 5180 MHz | 44 | 5220 MHz |
| | 38 | 5190 MHz | 46 | 5230 MHz |
| | 40 | 5200 MHz | 48 | 5240 MHz |
| 5250~5350 MHz Band 2 | 52 | 5260 MHz | 60 | 5300 MHz |
| | 54 | 5270 MHz | 62 | 5310 MHz |
| | 56 | 5280 MHz | 64 | 5320 MHz |
| 5470~5725 MHz Band 3 | 100 | 5500 MHz | 116 | 5580 MHz |
| | 102 | 5510MHz | 132 | 5660 MHz |
| | 104 | 5520 MHz | 134 | 5670 MHz |
| | 108 | 5540 MHz | 136 | 5680 MHz |
| | 110 | 5550 MHz | 140 | 5700 MHz |
| | 112 | 5560 MHz | - | - |

3.5. Table for Test Modes

Preliminary tests were performed in different data rate to find the worst radiated emission. The data rate shown in the table below is the worst-case rate with respect to the specific test item. Investigation has been done on all the possible configurations for searching the worst cases. The following table is a list of the test modes shown in this test report.

| Test Items | Mode | | Data Rate | Channel | Chain |
|-----------------------------|-------------|----------|-----------|-------------------|-------|
| AC Power Conducted Emission | Normal Link | | - | - | - |
| Max. Conducted Output Power | 11n 20MHz | Band 1~2 | MCS0 | 36/40/48/52/60/64 | 1+2 |
| | | Band 3 | MCS0 | 100/116/140 | 1+2 |
| | 11n 40MHz | Band 1~2 | MCS0 | 38/46/54/62 | 1+2 |
| | | Band 3 | MCS0 | 102/134 | 1+2 |
| | 11a/BPSK | Band 1~2 | 6Mbps | 36/40/48/52/60/64 | 1+2 |
| | | Band 3 | 6Mbps | 100/116/140 | 1+2 |
| Power Spectral Density | 11n 20MHz | Band 1~2 | MCS0 | 36/40/48/52/60/64 | 1+2 |
| | | Band 3 | MCS0 | 100/116/140 | 1+2 |
| | 11n 40MHz | Band 1~2 | MCS0 | 38/46/54/62 | 1+2 |
| | | Band 3 | MCS0 | 102/134 | 1+2 |

| | | | | | |
|--|---------------|----------|-------|-------------------|-----|
| | 11a/BPSK | Band 1~2 | 6Mbps | 36/40/48/52/60/64 | 1+2 |
| | | Band 3 | 6Mbps | 100/116/140 | 1+2 |
| 26dB Spectrum Bandwidth 99% Occupied Bandwidth Measurement | 11n 20MHz | Band 1~2 | MCS0 | 36/40/48/52/60/64 | 1+2 |
| | | Band 3 | MCS0 | 100/116/140 | 1+2 |
| | 11n 40MHz | Band 1~2 | MCS0 | 38/46/54/62 | 1+2 |
| | | Band 3 | MCS0 | 102/134 | 1+2 |
| | 11a/BPSK | Band 1~2 | 6Mbps | 36/40/48/52/60/64 | 1+2 |
| | | Band 3 | 6Mbps | 100/116/140 | 1+2 |
| Peak Excursion | 11n 20MHz | Band 1~2 | MCS0 | 36/52 | 1+2 |
| | | Band 3 | MCS0 | 116 | 1+2 |
| | 11n 40MHz | Band 1~2 | MCS0 | 46/54 | 1+2 |
| | | Band 3 | MCS0 | 102 | 1+2 |
| | 11a/BPSK | Band 1~2 | 6Mbps | 40/52 | 1+2 |
| | | Band 3 | 6Mbps | 116 | 1+2 |
| Radiated Emission Below 1GHz | Normal Link | | - | - | - |
| Radiated Emission Above 1GHz | 11n 20MHz | Band 1~2 | MCS0 | 36/40/48/52/60/64 | 1+2 |
| | | Band 3 | MCS0 | 100/116/140 | 1+2 |
| | 11n 40MHz | Band 1~2 | MCS0 | 38/46/54/62 | 1+2 |
| | | Band 3 | MCS0 | 102/134 | 1+2 |
| | 11a/BPSK | Band 1~2 | 6Mbps | 36/40/48/52/60/64 | 1+2 |
| | | Band 3 | 6Mbps | 100/116/140 | 1+2 |
| Band Edge Emission | 11n 20MHz | Band 1~2 | MCS0 | 36/40/48/52/60/64 | 1+2 |
| | | Band 3 | MCS0 | 100/116/140 | 1+2 |
| | 11n 40MHz | Band 1~2 | MCS0 | 38/46/54/62 | 1+2 |
| | | Band 3 | MCS0 | 102/134 | 1+2 |
| | 11a/BPSK | Band 1~2 | 6Mbps | 36/40/48/52/60/64 | 1+2 |
| | | Band 3 | 6Mbps | 100/116/140 | 1+2 |
| Frequency Stability | Un-modulation | | - | 40/60 | N/A |

3.6. Table for Testing Locations

| Test Site No. | Site Category | Location | FCC Reg. No. | IC File No. | VCCI Reg. No |
|---------------|---------------|----------|--------------|-------------|--------------|
| 03CH01-CB | SAC | Hsin Chu | 262045 | IC 4086D | - |
| CO01-CB | Conduction | Hsin Chu | 262045 | IC 4086D | - |
| TH01-CB | OVEN Room | Hsin Chu | - | - | - |

Open Area Test Site (OATS); Semi Anechoic Chamber (SAC).

Please refer section 6 for Test Site Address.

3.7. Table for Supporting Units

For Test Site No : 03CH01-CB and CO01-CB

| Support Unit | Brand | Model | FCC ID |
|--------------|------------|-----------------|--------------|
| Notebook | DELL | 1200 | E2KWM3945ABG |
| Mouse | Logitech | M-U0026 | DoC |
| Earphone | SHYARO CHI | MIC-04 | N/A |
| Wireless AP | BELKIN | WG7016G22-LF-AK | DoC |

For Test Site No : TH01-CB

| Support Unit | Brand | Model | FCC ID |
|--------------|-------|-------|--------------|
| Notebook | DELL | M1330 | E2KWM3945ABG |

3.8. Table for Parameters of Test Software Setting

During testing, Channel & Power Controlling Software provided by the customer was used to control the operating channel as well as the output power level. The RF output power selection is for the setting of RF output power expected by the customer and is going to be fixed on the firmware of the final end product.

Power Parameters of IEEE 802.11n MCS0 20MHz / Chain 1 + Chain 2

| Test Software Version | ART2-GUI Version 2.3 | | | | | | | | |
|-----------------------|----------------------|----------|----------|----------|----------|----------|----------|----------|----------|
| Frequency | 5180 MHz | 5200 MHz | 5240 MHz | 5260 MHz | 5300 MHz | 5320 MHz | 5500 MHz | 5580 MHz | 5700 MHz |
| MCS0 20MHz | 11 | 11 | 11.5 | 19.5 | 19 | 16 | 15 | 16.5 | 12.5 |

Power Parameters of IEEE 802.11n MCS0 40MHz / Chain 1 + Chain 2

| Test Software Version | ART2-GUI Version 2.3 | | | | | | |
|-----------------------|----------------------|----------|----------|----------|----------|----------|----------|
| Frequency | 5190 MHz | 5230 MHz | 5270 MHz | 5310 MHz | 5510 MHz | 5550 MHz | 5670 MHz |
| MCS0 40MHz | 10 | 13 | 20.5 | 9.5 | 8 | 17.5 | 14.5 |

Power Parameters of IEEE 802.11a / Chain 1 + Chain 2

| Test Software Version | ART2-GUI Version 2.3 | | | | | | | | |
|-----------------------|----------------------|----------|----------|----------|----------|----------|----------|----------|----------|
| Frequency | 5180 MHz | 5200 MHz | 5240 MHz | 5260 MHz | 5300 MHz | 5320 MHz | 5500 MHz | 5580 MHz | 5700 MHz |
| IEEE 802.11a | 11 | 11 | 11 | 19 | 18.5 | 15.5 | 15 | 16 | 13 |

3.9. EUT Operation during Test

The EUT was programmed to be in continuously transmitting mode.

3.10. Duty Cycle

IEEE 802.11n MCS0 20MHz

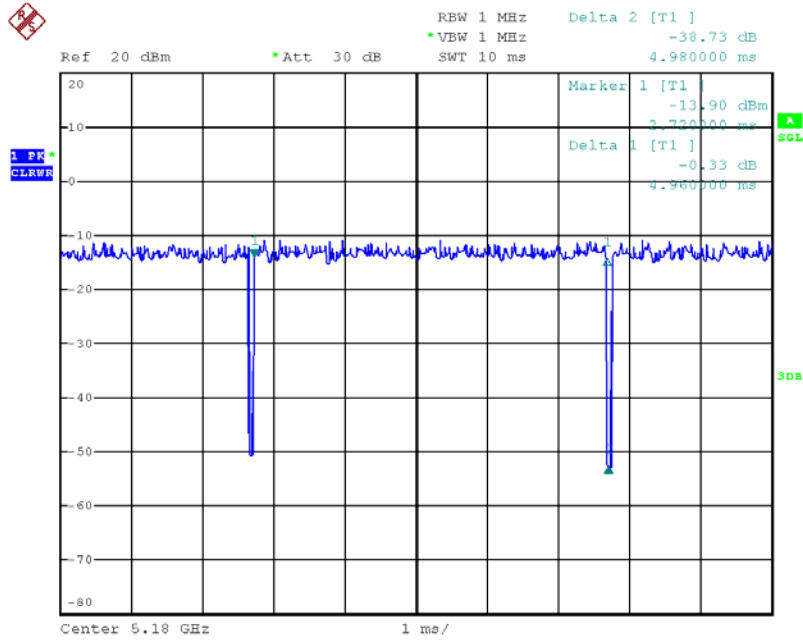

Date: 21.MAY.2013 21:51:19

IEEE 802.11n MCS0 40MHz

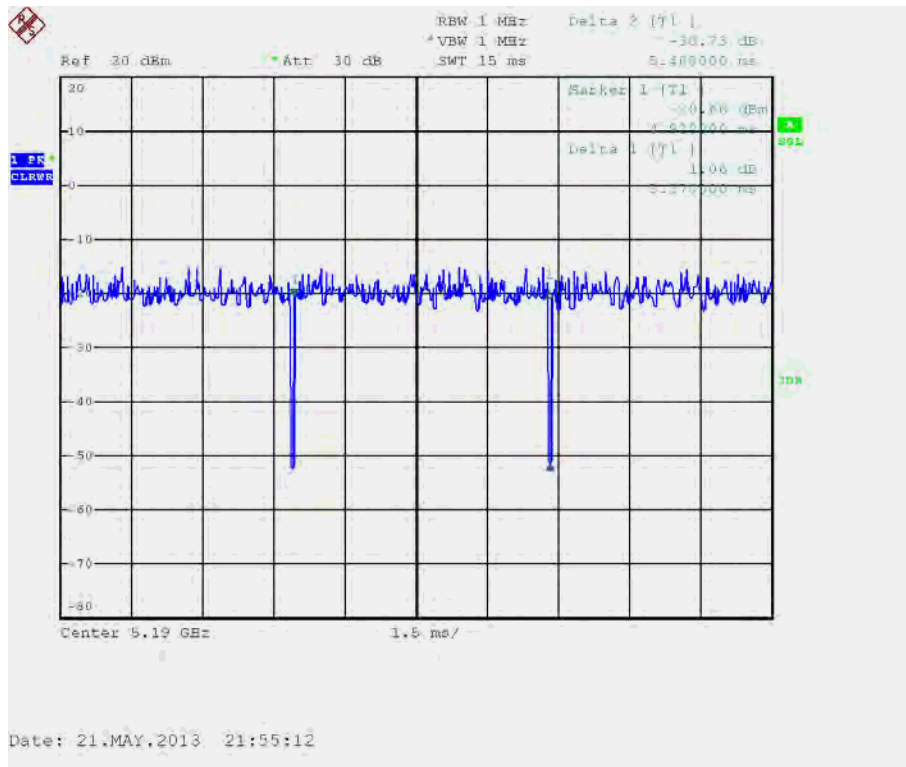

Date: 21.MAY.2013 21:55:12

IEEE 802.11a

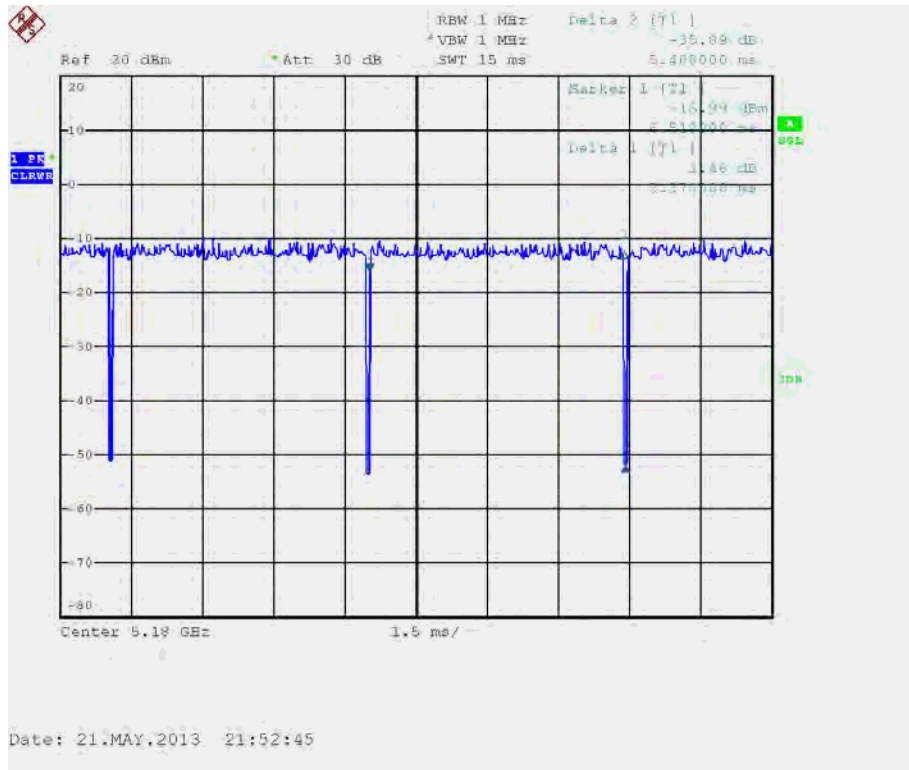

3.11. Test Configurations

3.11.1. AC Power Line Conduction Emissions and Radiation Emissions below 1GHz Test Configuration

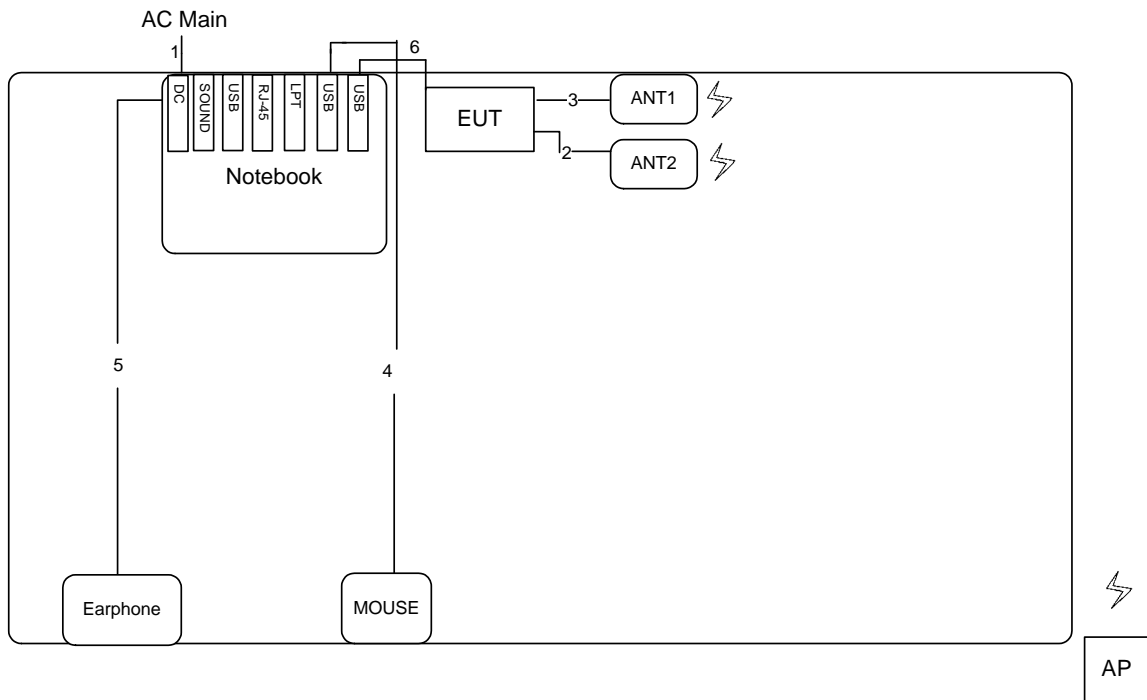

| Item | Connection | Shield | Length |
|------|-------------|--------|--------|
| 1 | Power Cable | No | 2.6m |
| 2 | Ant. Cable | Yes | 0.18m |
| 3 | Ant. Cable | Yes | 0.18m |
| 4 | USB Cable | No | 1.8m |
| 5 | Audio Cable | No | 1.1m |
| 6 | USB Cable | Yes | 0.1m |

3.11.2. Radiation Emissions above 1GHz Test Configuration

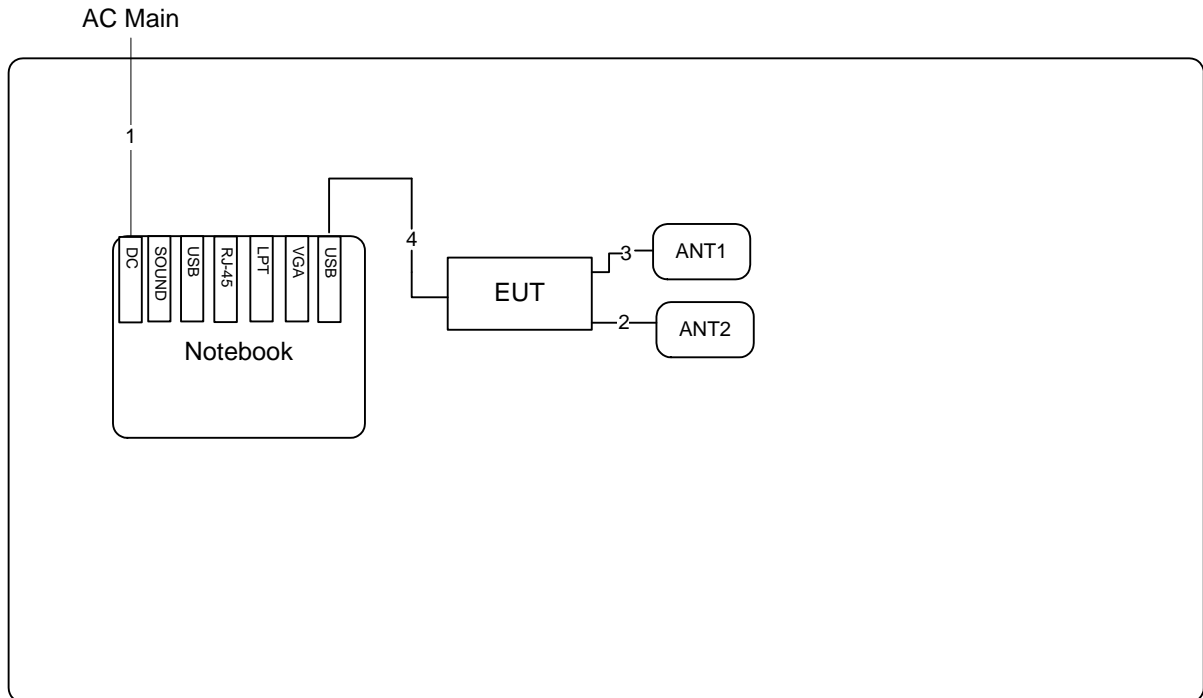

| Item | Connection | Shield | Length |
|------|-------------|--------|--------|
| 1 | Power Cable | No | 2.6m |
| 2 | Ant. Cable | Yes | 0.18m |
| 3 | Ant. Cable | Yes | 0.18m |
| 4 | USB Cable | Yes | 0.1m |

4. TEST RESULT

4.1. AC Power Line Conducted Emissions Measurement

4.1.1. Limit

For this product that is designed to connect to the AC power line, the radio frequency voltage that is conducted back onto the AC power line on any frequency or frequencies within the band 150 kHz to 30 MHz shall not exceed below limits table.

| Frequency (MHz) | QP Limit (dBuV) | AV Limit (dBuV) |
|-----------------|-----------------|-----------------|
| 0.15~0.5 | 66~56 | 56~46 |
| 0.5~5 | 56 | 46 |
| 5~30 | 60 | 50 |

4.1.2. Measuring Instruments and Setting

Please refer to section 5 of equipments list in this report. The following table is the setting of the receiver.

| Receiver Parameters | Setting |
|---------------------|----------|
| Attenuation | 10 dB |
| Start Frequency | 0.15 MHz |
| Stop Frequency | 30 MHz |
| IF Bandwidth | 9 KHz |

4.1.3. Test Procedures

1. Configure the EUT according to ANSI C63.10. The EUT or host of EUT has to be placed 0.4 meter far from the conducting wall of the shielding room and at least 80 centimeters from any other grounded conducting surface.
2. Connect EUT or host of EUT to the power mains through a line impedance stabilization network (LISN).
3. All the support units are connected to the other LISNs. The LISN should provide 50uH/50ohms coupling impedance.
4. The frequency range from 150 KHz to 30 MHz was searched.
5. Set the test-receiver system to Peak Detect Function and Specified Bandwidth with Maximum Hold Mode.
6. The measurement has to be done between each power line and ground at the power terminal.

4.1.4. Test Setup Layout

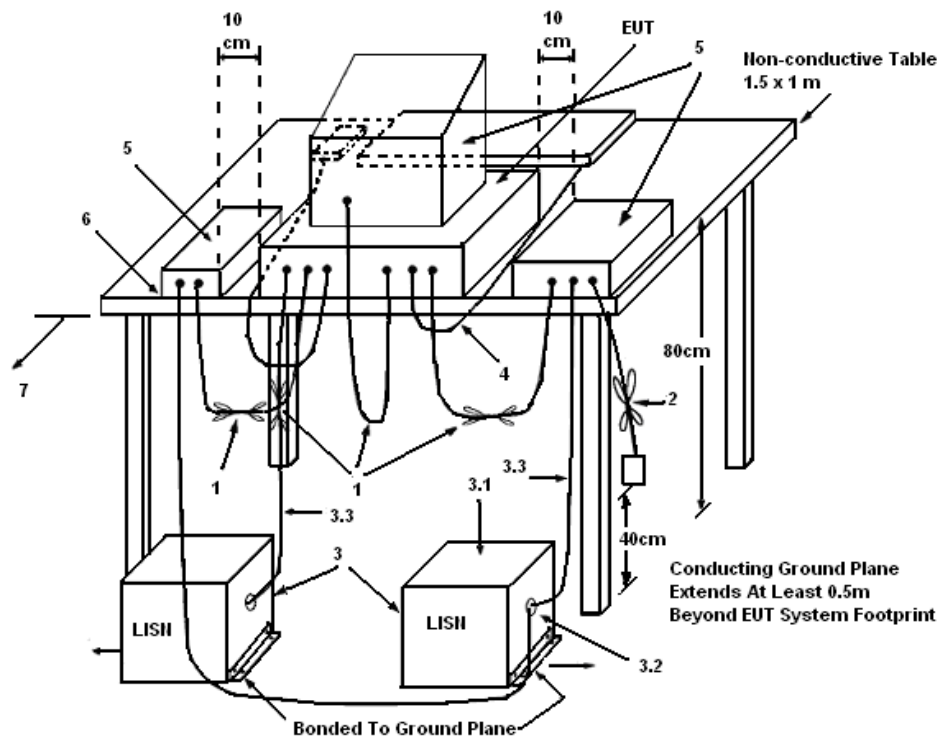

LEGEND:

- (1) Interconnecting cables that hang closer than 40 cm to the ground plane shall be folded back and forth in the center forming a bundle 30 to 40 cm long.
- (2) I/O cables that are not connected to a peripheral shall be bundled in the center. The end of the cable may be terminated, if required, using the correct terminating impedance. The overall length shall not exceed 1 m.
- (3) EUT connected to one LISN. Unused LISN measuring port connectors shall be terminated in 50 Ω . LISN can be placed on top of, or immediately beneath, reference ground plane.
 - (3.1) All other equipment powered from additional LISN(s).
 - (3.2) Multiple outlet strip can be used for multiple power cords of non-EUT equipment.
 - (3.3) LISN at least 80 cm from nearest part of EUT chassis.
- (4) Cables of hand-operated devices, such as keyboards, mice, etc., shall be placed as for normal use.
- (5) Non-EUT components of EUT system being tested.
- (6) Rear of EUT, including peripherals, shall all be aligned and flush with rear of tabletop.
- (7) Rear of tabletop shall be 40 cm removed from a vertical conducting plane that is bonded to the ground plane.

4.1.5. Test Deviation

There is no deviation with the original standard.

4.1.6. EUT Operation during Test

The EUT was placed on the test table and programmed in normal function.

4.1.7. Results of AC Power Line Conducted Emissions Measurement

| | | | |
|---------------|-------------|----------|------|
| Temperature | 24°C | Humidity | 58% |
| Test Engineer | Hank Yang | Phase | Line |
| Configuration | Normal Link | | |

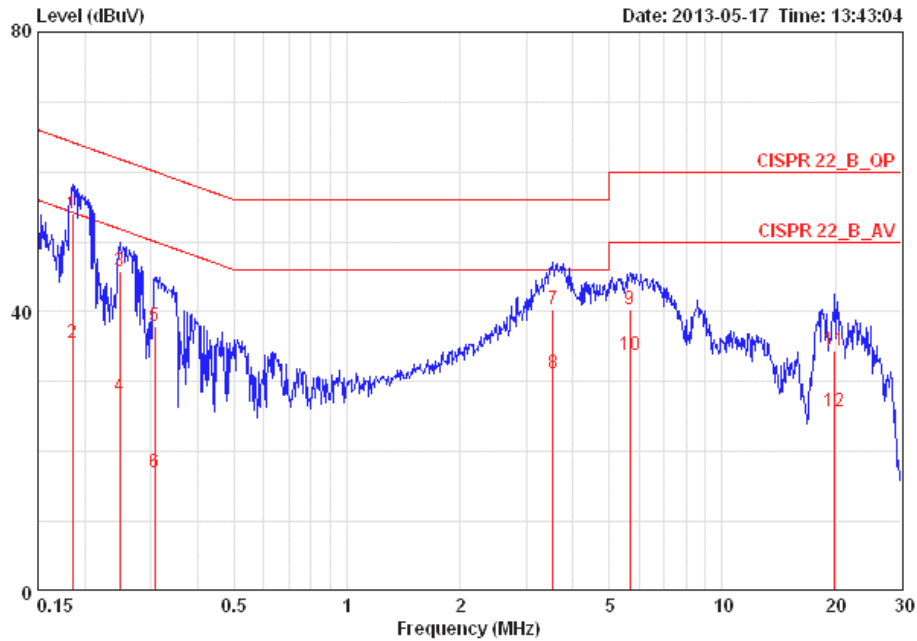

| | Freq | Level | Over Limit | Limit Line | Read Level | LISN Factor | Cable Loss | Pol/Phase | Remark |
|----|---------|-------|------------|------------|------------|-------------|------------|-----------|---------|
| | MHz | dBuV | dB | dBuV | dBuV | dB | dB | | |
| 1 | 0.18541 | 53.99 | -10.25 | 64.24 | 53.65 | 0.15 | 0.19 | LINE | QP |
| 2 | 0.18541 | 35.52 | -18.72 | 54.24 | 35.18 | 0.15 | 0.19 | LINE | AVERAGE |
| 3 | 0.24814 | 45.70 | -16.12 | 61.82 | 45.35 | 0.15 | 0.20 | LINE | QP |
| 4 | 0.24814 | 27.86 | -23.96 | 51.82 | 27.51 | 0.15 | 0.20 | LINE | AVERAGE |
| 5 | 0.30671 | 38.02 | -22.04 | 60.06 | 37.67 | 0.15 | 0.20 | LINE | QP |
| 6 | 0.30671 | 17.06 | -33.00 | 50.06 | 16.71 | 0.15 | 0.20 | LINE | AVERAGE |
| 7 | 3.547 | 40.40 | -15.60 | 56.00 | 39.91 | 0.21 | 0.28 | LINE | QP |
| 8 | 3.547 | 31.08 | -14.92 | 46.00 | 30.59 | 0.21 | 0.28 | LINE | AVERAGE |
| 9 | 5.683 | 40.35 | -19.65 | 60.00 | 39.77 | 0.25 | 0.33 | LINE | QP |
| 10 | 5.683 | 33.88 | -16.12 | 50.00 | 33.30 | 0.25 | 0.33 | LINE | AVERAGE |
| 11 | 19.950 | 34.43 | -25.57 | 60.00 | 33.45 | 0.48 | 0.50 | LINE | QP |
| 12 | 19.950 | 25.63 | -24.37 | 50.00 | 24.65 | 0.48 | 0.50 | LINE | AVERAGE |

| | | | |
|---------------|-------------|----------|---------|
| Temperature | 24°C | Humidity | 58% |
| Test Engineer | Hank Yang | Phase | Neutral |
| Configuration | Normal Link | | |

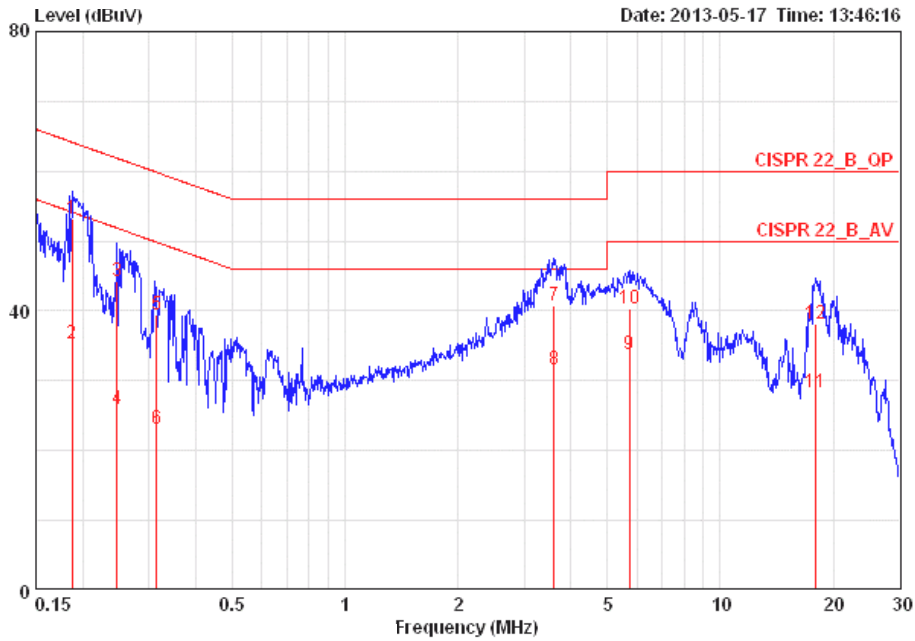

| | Freq | Level | Over | Limit | Read | LISN | Cable | Pol/Phase | Remark |
|----|---------|-------|--------|-------|-------|------|-------|-----------|---------|
| | MHz | dBuV | dB | dBuV | dBuV | dB | dB | | |
| 1 | 0.18739 | 53.11 | -11.05 | 64.15 | 52.83 | 0.08 | 0.20 | NEUTRAL | QP |
| 2 | 0.18739 | 35.41 | -18.75 | 54.15 | 35.13 | 0.08 | 0.20 | NEUTRAL | AVERAGE |
| 3 | 0.24682 | 44.30 | -17.56 | 61.86 | 44.02 | 0.08 | 0.20 | NEUTRAL | QP |
| 4 | 0.24682 | 25.91 | -25.95 | 51.86 | 25.63 | 0.08 | 0.20 | NEUTRAL | AVERAGE |
| 5 | 0.31495 | 39.38 | -20.46 | 59.84 | 39.10 | 0.08 | 0.20 | NEUTRAL | QP |
| 6 | 0.31495 | 23.21 | -26.63 | 49.84 | 22.93 | 0.08 | 0.20 | NEUTRAL | AVERAGE |
| 7 | 3.603 | 40.81 | -15.19 | 56.00 | 40.40 | 0.13 | 0.28 | NEUTRAL | QP |
| 8 | 3.603 | 31.60 | -14.40 | 46.00 | 31.19 | 0.13 | 0.28 | NEUTRAL | AVERAGE |
| 9 | 5.713 | 33.83 | -16.17 | 50.00 | 33.34 | 0.16 | 0.33 | NEUTRAL | AVERAGE |
| 10 | 5.713 | 40.22 | -19.78 | 60.00 | 39.73 | 0.16 | 0.33 | NEUTRAL | QP |
| 11 | 17.944 | 28.42 | -21.58 | 50.00 | 27.58 | 0.36 | 0.48 | NEUTRAL | AVERAGE |
| 12 | 17.944 | 38.11 | -21.89 | 60.00 | 37.27 | 0.36 | 0.48 | NEUTRAL | QP |

Note:

Level = Read Level + LISN Factor + Cable Loss.

4.2. 26dB Bandwidth & 99% Occupied Bandwidth Measurement

4.2.1. Limit

No restriction limits.

4.2.2. Measuring Instruments and Setting

Please refer to section 5 of equipments list in this report. The following table is the setting of the spectrum analyzer.

| 26dB Bandwidth | |
|------------------------|--|
| Spectrum Parameters | Setting |
| Attenuation | Auto |
| Span Frequency | > 26dB Bandwidth |
| RBW | Approximately 1% of the emission bandwidth |
| VBW | VBW > RBW |
| Detector | Peak |
| Trace | Max Hold |
| Sweep Time | Auto |
| 99% Occupied Bandwidth | |
| Spectrum Parameters | Setting |
| Span | 1.5 times to 5.0 times the OBW |
| RBW | 1 % to 5 % of the OBW |
| VBW | $\geq 3 \times \text{RBW}$ |
| Detector | Peak |
| Trace | Max Hold |

4.2.3. Test Procedures

1. The transmitter output (antenna port) was connected to the spectrum analyzer in peak hold mode.
2. Measure the maximum width of the emission that is 26 dB down from the peak of the emission. Compare this with the RBW setting of the analyzer. Readjust RBW and repeat measurement as needed until the RBW/EBW ratio is approximately 1%.

4.2.4. Test Setup Layout

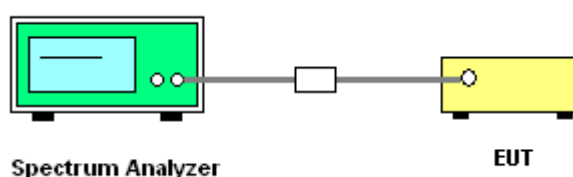

4.2.5. Test Deviation

There is no deviation with the original standard.

4.2.6. EUT Operation during Test

The EUT was programmed to be in continuously transmitting mode.

4.2.7. Test Result of 26dB Bandwidth & 99% Occupied Bandwidth

| | | | |
|---------------|---------|----------------|--------------|
| Temperature | 25°C | Humidity | 56% |
| Test Engineer | Sean Ku | Configurations | IEEE 802.11n |

Configuration IEEE 802.11n MCS0 20MHz / Chain 1 + Chain 2

| Channel | Frequency | 26dB Bandwidth (MHz) | 99% Occupied Bandwidth (MHz) |
|---------|-----------|----------------------|------------------------------|
| 36 | 5180 MHz | 22.72 | 17.92 |
| 40 | 5200 MHz | 23.04 | 17.92 |
| 48 | 5240 MHz | 22.88 | 18.08 |
| 52 | 5260 MHz | 41.76 | 26.08 |
| 60 | 5300 MHz | 40.96 | 26.08 |
| 64 | 5320 MHz | 37.76 | 19.84 |
| 100 | 5500 MHz | 41.44 | 25.60 |
| 116 | 5580 MHz | 38.08 | 24.64 |
| 140 | 5700 MHz | 32.16 | 18.56 |

Configuration IEEE 802.11n MCS0 40MHz / Chain 1 + Chain 2

| Channel | Frequency | 26dB Bandwidth (MHz) | 99% Occupied Bandwidth (MHz) |
|---------|-----------|----------------------|------------------------------|
| 38 | 5190 MHz | 47.68 | 37.12 |
| 46 | 5230 MHz | 62.40 | 37.76 |
| 54 | 5270 MHz | 96.96 | 59.52 |
| 62 | 5310 MHz | 48.00 | 37.44 |
| 102 | 5510MHz | 47.68 | 37.12 |
| 110 | 5550 MHz | 93.76 | 58.24 |
| 134 | 5670 MHz | 85.12 | 42.24 |

| | | | |
|----------------------|---------|-----------------------|--------------|
| Temperature | 25°C | Humidity | 56% |
| Test Engineer | Sean Ku | Configurations | IEEE 802.11a |

Configuration IEEE 802.11a / Chain 1 + Chain 2

| Channel | Frequency | 26dB Bandwidth (MHz) | 99% Occupied Bandwidth (MHz) |
|---------|-----------|----------------------|------------------------------|
| 36 | 5180 MHz | 23.20 | 23.20 |
| 40 | 5200 MHz | 25.28 | 17.12 |
| 48 | 5240 MHz | 22.88 | 16.80 |
| 52 | 5260 MHz | 41.60 | 24.16 |
| 60 | 5300 MHz | 40.48 | 24.16 |
| 64 | 5320 MHz | 33.60 | 18.08 |
| 100 | 5500 MHz | 37.44 | 20.00 |
| 116 | 5580 MHz | 39.36 | 22.72 |
| 140 | 5700 MHz | 33.44 | 18.08 |

26dB Bandwidth & 99% Occupied Bandwidth Plot on Configuration IEEE 802.11n MCS0 20MHz / Chain 1 + Chain 2 / 5180 MHz

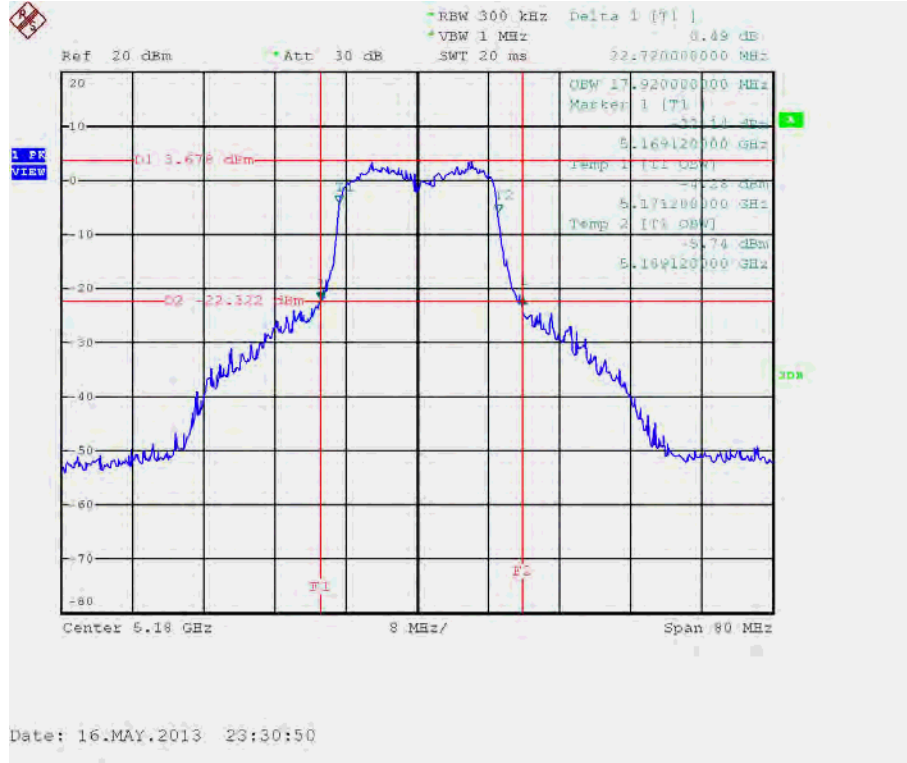

26dB Bandwidth & 99% Occupied Bandwidth Plot on Configuration IEEE 802.11n MCS0 20MHz / Chain 1 + Chain 2 / 5200 MHz

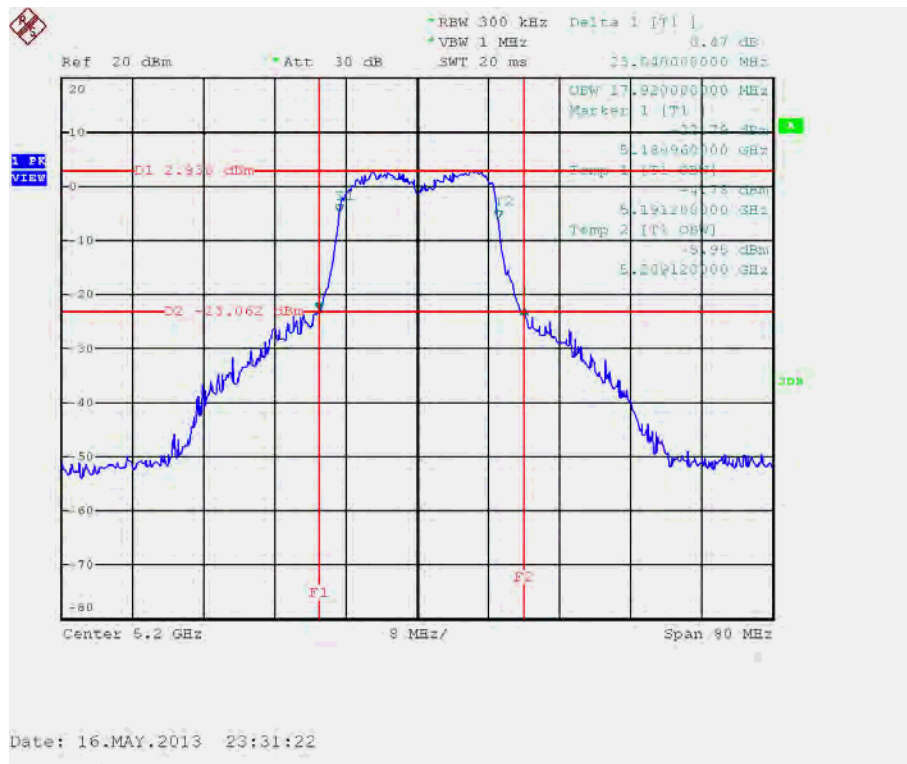

26dB Bandwidth & 99% Occupied Bandwidth Plot on Configuration IEEE 802.11n MCS0 20MHz / Chain 1 + Chain 2 / 5240 MHz

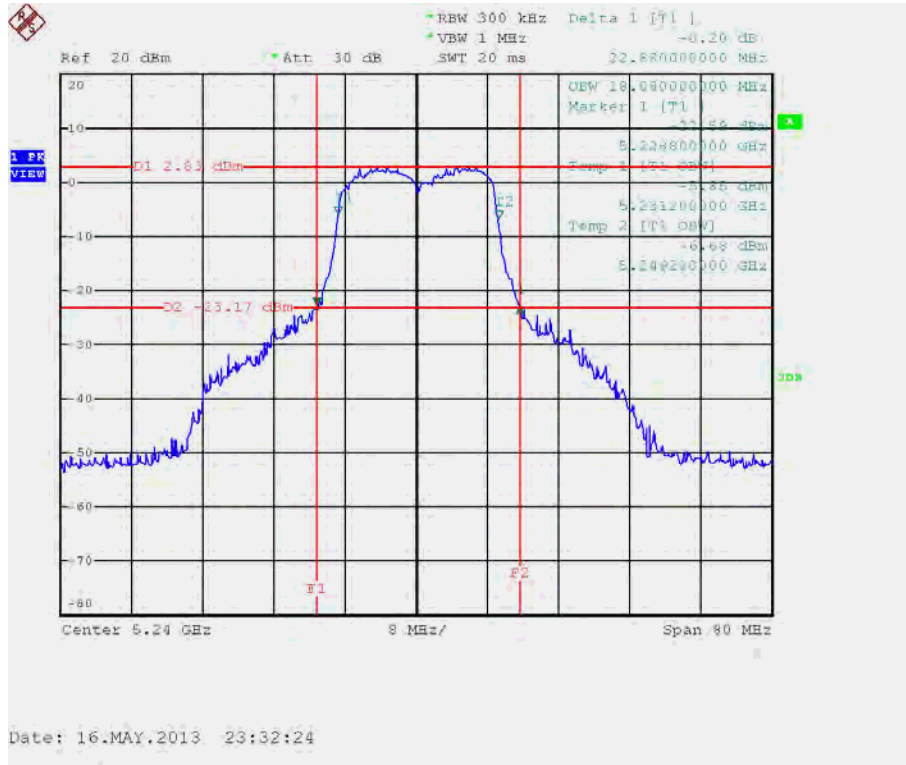

26dB Bandwidth & 99% Occupied Bandwidth Plot on Configuration IEEE 802.11n MCS0 20MHz / Chain 1 + Chain 2 / 5260 MHz

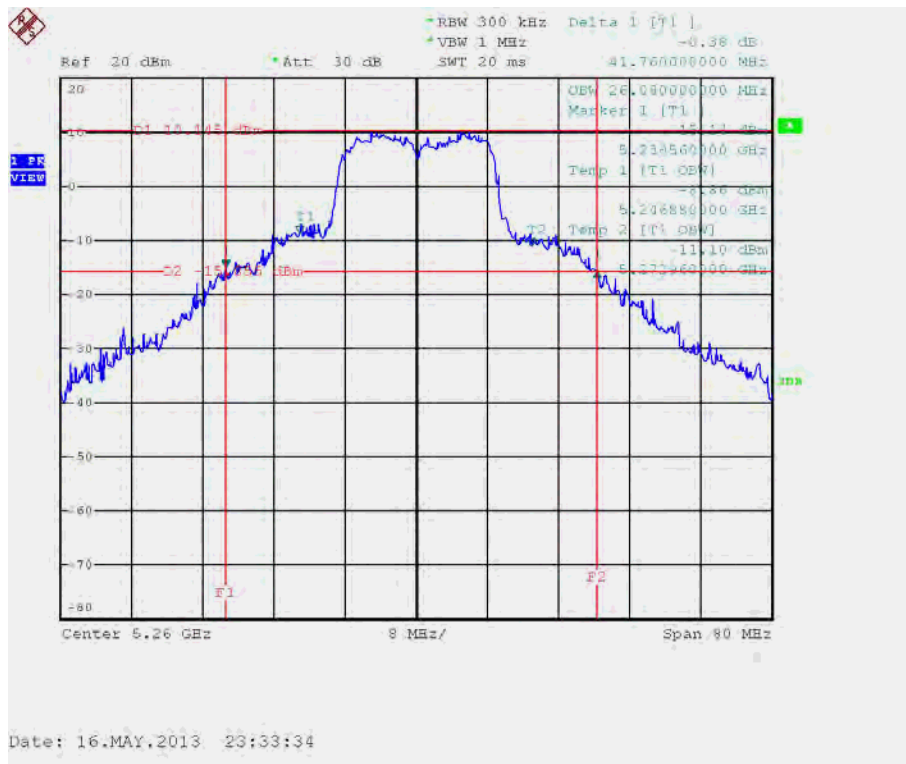

26dB Bandwidth & 99% Occupied Bandwidth Plot on Configuration IEEE 802.11n MCS0 20MHz / Chain 1 + Chain 2 / 5300 MHz

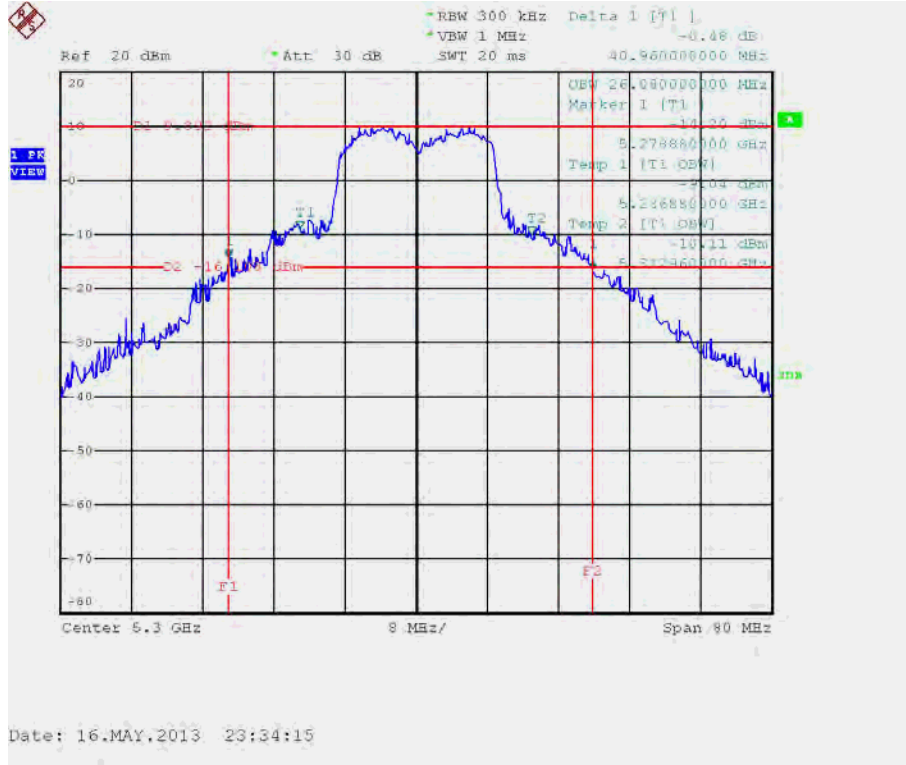

26dB Bandwidth & 99% Occupied Bandwidth Plot on Configuration IEEE 802.11n MCS0 20MHz / Chain 1 + Chain 2 / 5320 MHz

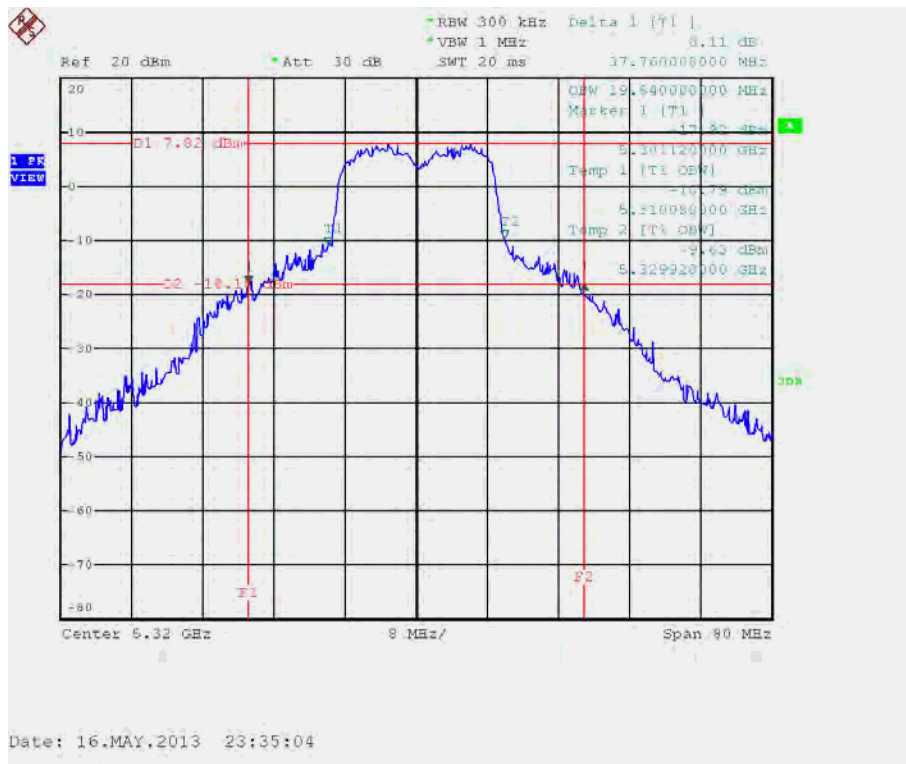

26dB Bandwidth & 99% Occupied Bandwidth Plot on Configuration IEEE 802.11n MCS0 20MHz / Chain 1 + Chain 2 / 5500 MHz

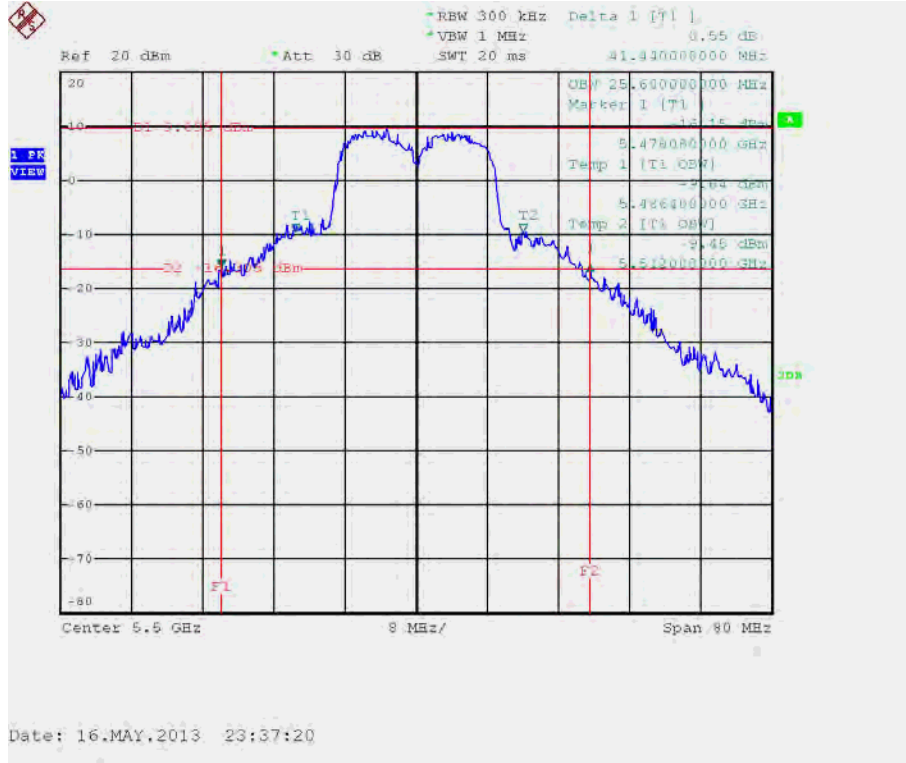

26dB Bandwidth & 99% Occupied Bandwidth Plot on Configuration IEEE 802.11n MCS0 20MHz / Chain 1 + Chain 2 / 5580 MHz

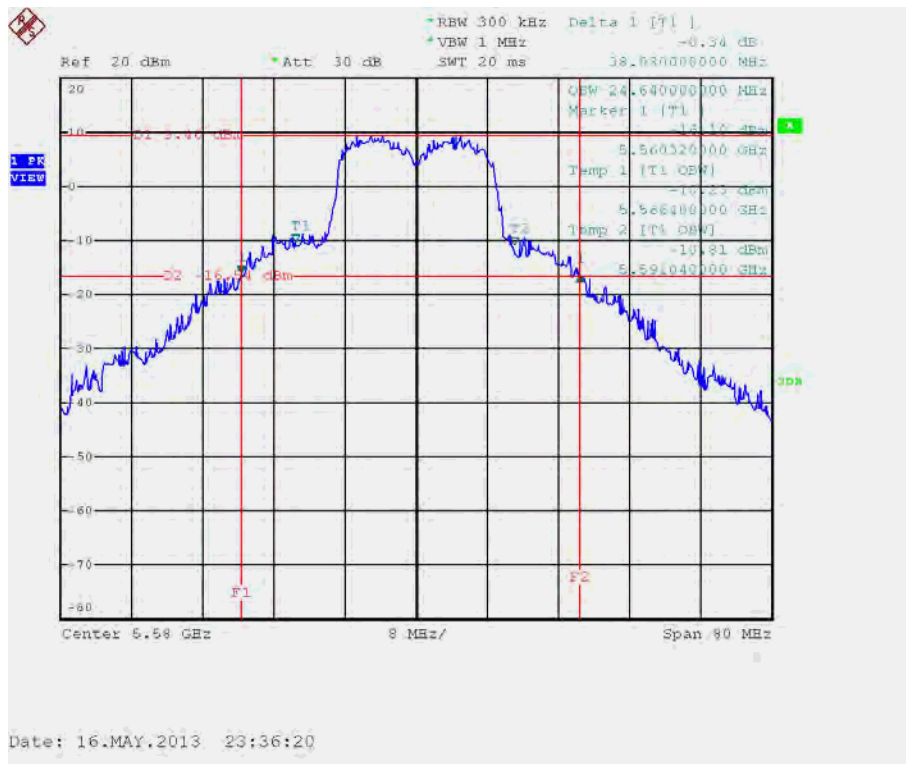

26dB Bandwidth & 99% Occupied Bandwidth Plot on Configuration IEEE 802.11n MCS0 20MHz / Chain 1 + Chain 2 / 5700 MHz

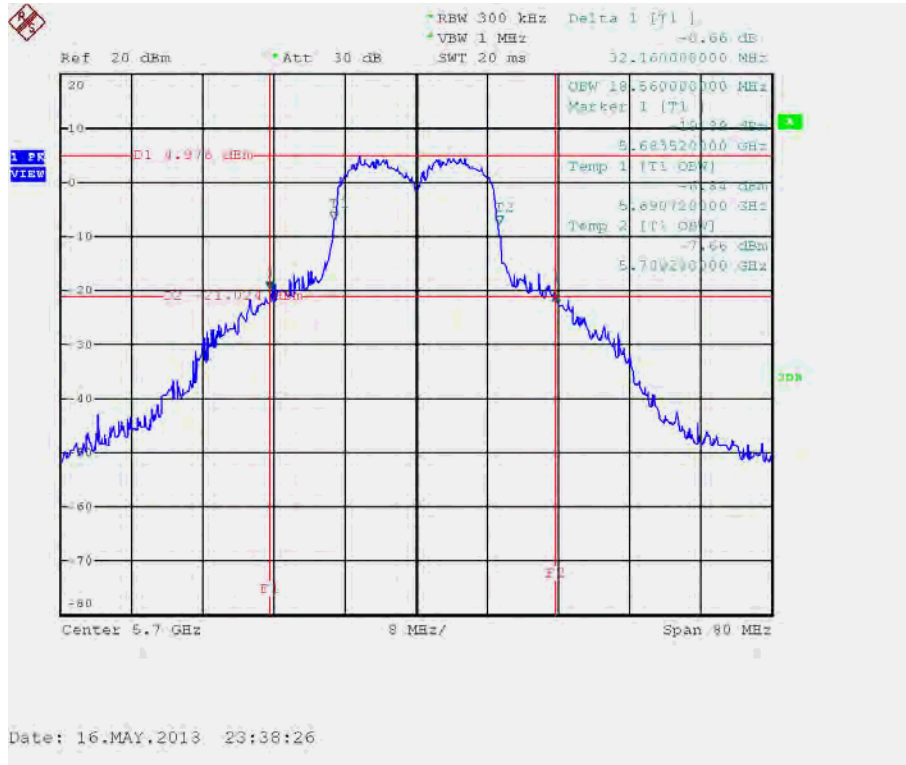

26dB Bandwidth & 99% Occupied Bandwidth Plot on Configuration IEEE 802.11n MCS0 40MHz / Chain 1 + Chain 2 / 5190 MHz

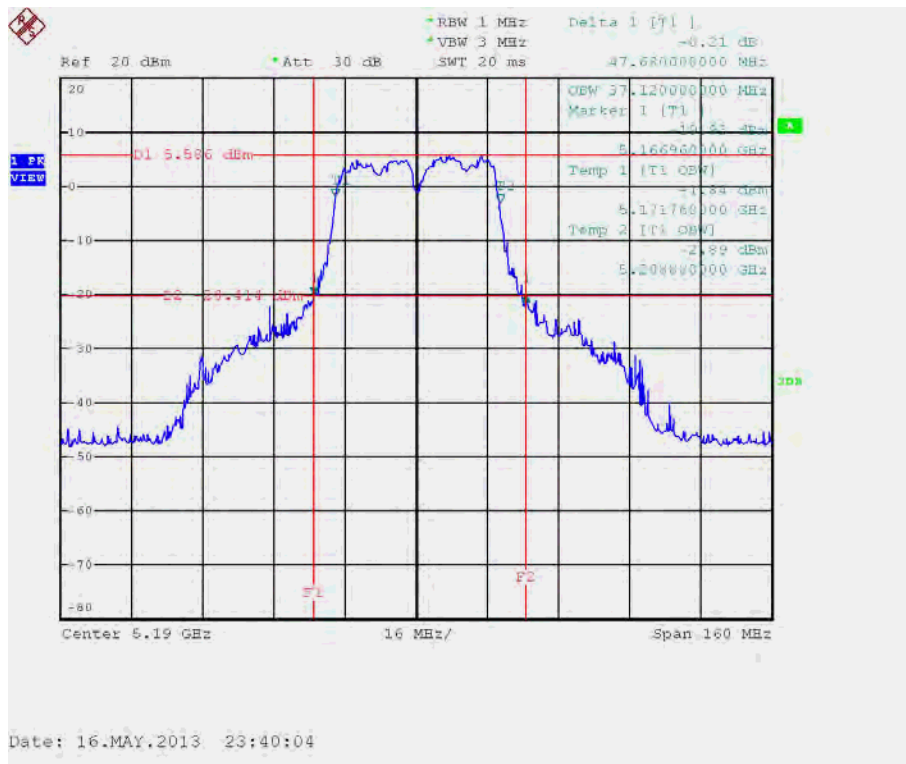

26dB Bandwidth & 99% Occupied Bandwidth Plot on Configuration IEEE 802.11n MCS0 40MHz / Chain 1 + Chain 2 / 5230 MHz

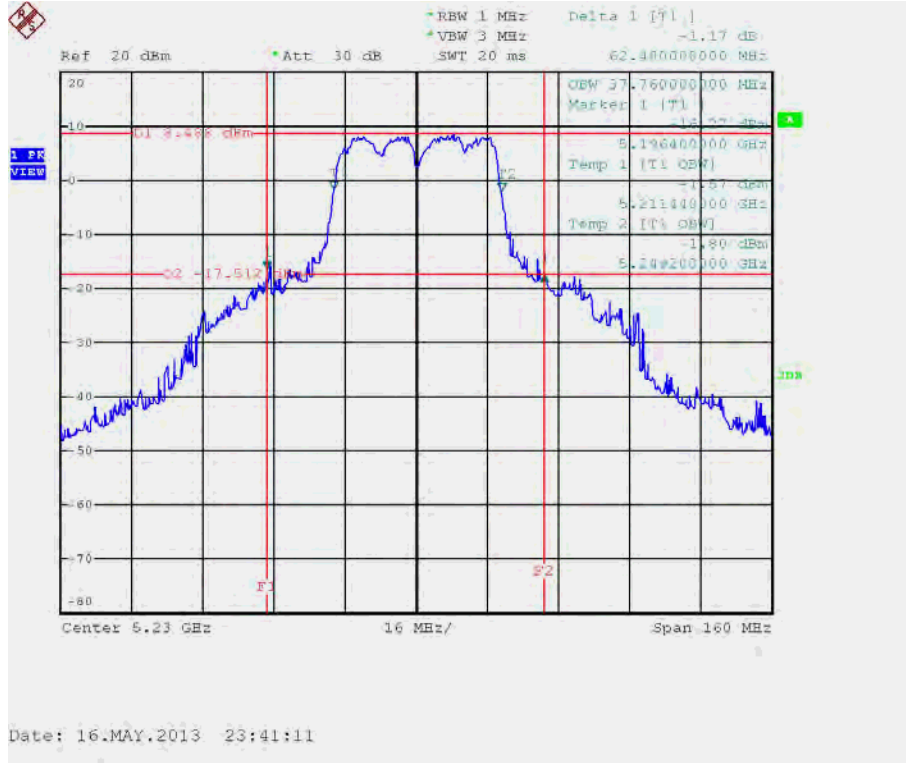

26dB Bandwidth & 99% Occupied Bandwidth Plot on Configuration IEEE 802.11n MCS0 40MHz / Chain 1 + Chain 2 / 5270 MHz

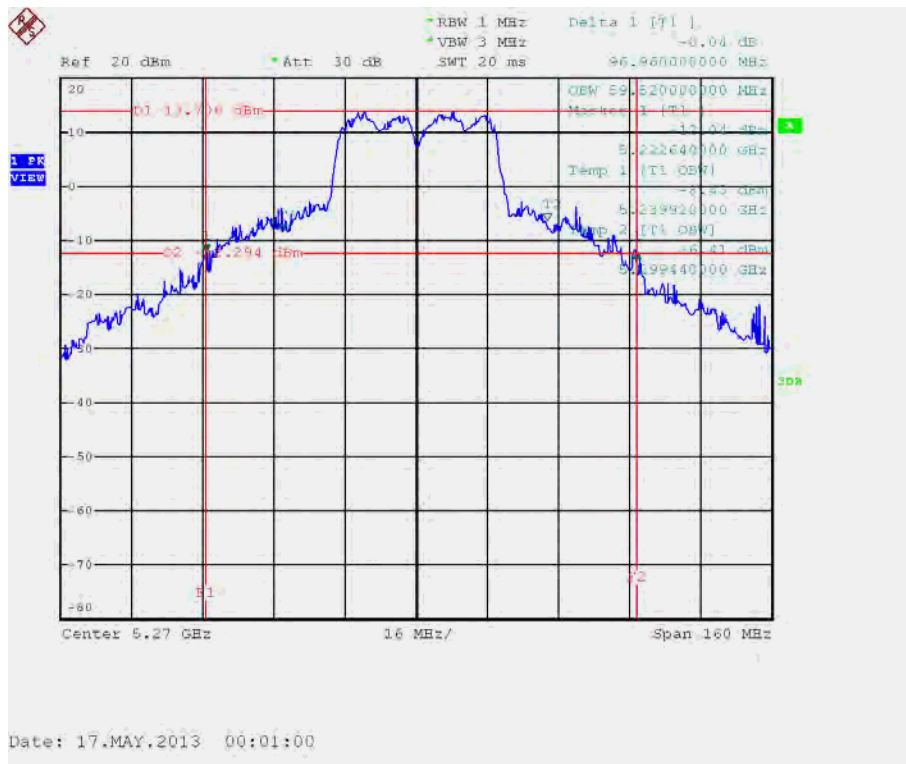

26dB Bandwidth & 99% Occupied Bandwidth Plot on Configuration IEEE 802.11n MCS0 40MHz / Chain 1 + Chain 2 / 5310 MHz

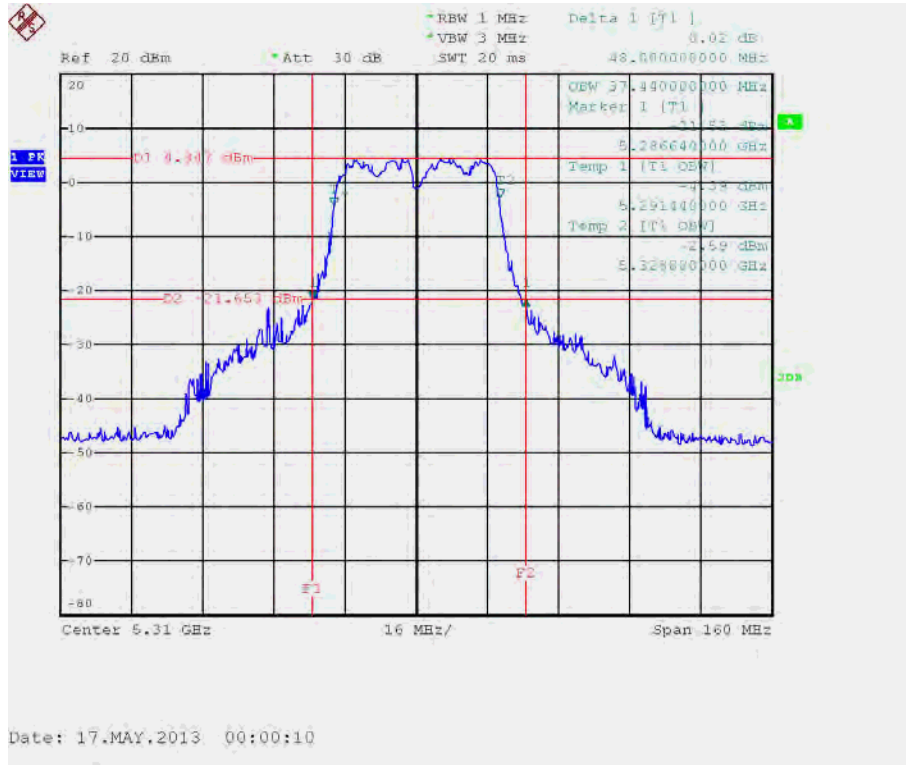

26dB Bandwidth & 99% Occupied Bandwidth Plot on Configuration IEEE 802.11n MCS0 40MHz / Chain 1 + Chain 2 / 5510MHz

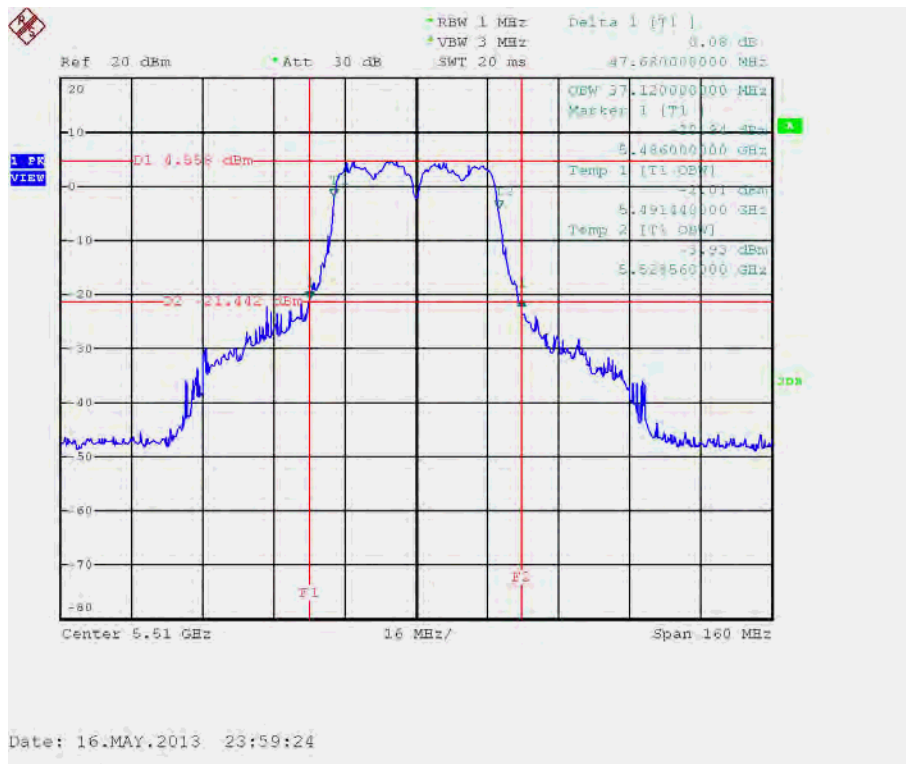

26dB Bandwidth & 99% Occupied Bandwidth Plot on Configuration IEEE 802.11n MCS0 40MHz / Chain 1 + Chain 2 / 5550 MHz

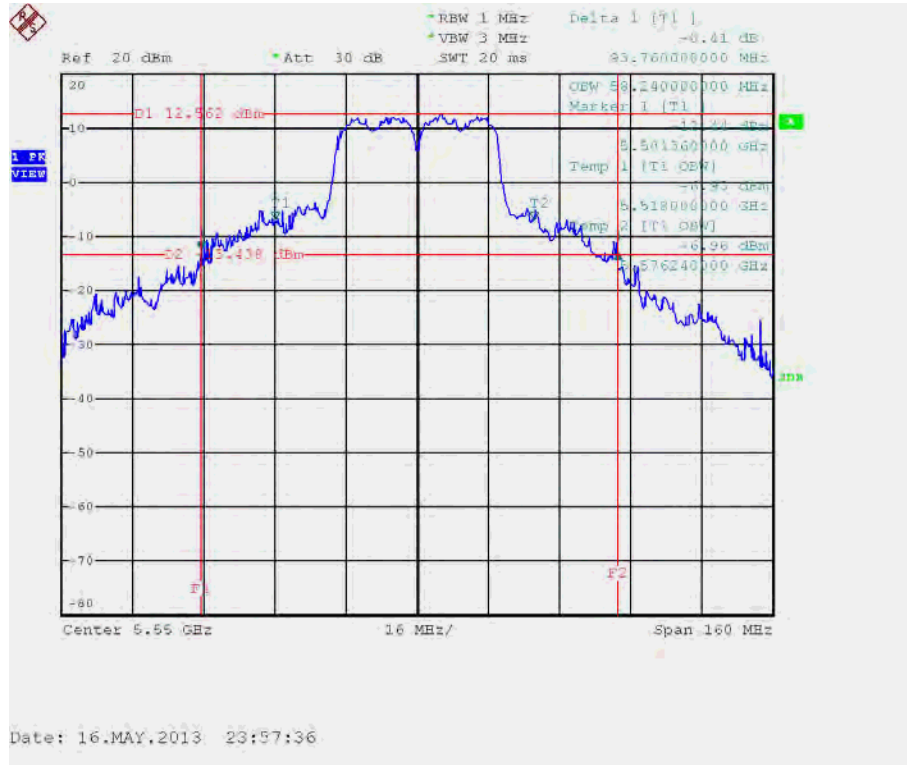

26dB Bandwidth & 99% Occupied Bandwidth Plot on Configuration IEEE 802.11n MCS0 40MHz / Chain 1 + Chain 2 / 5670 MHz

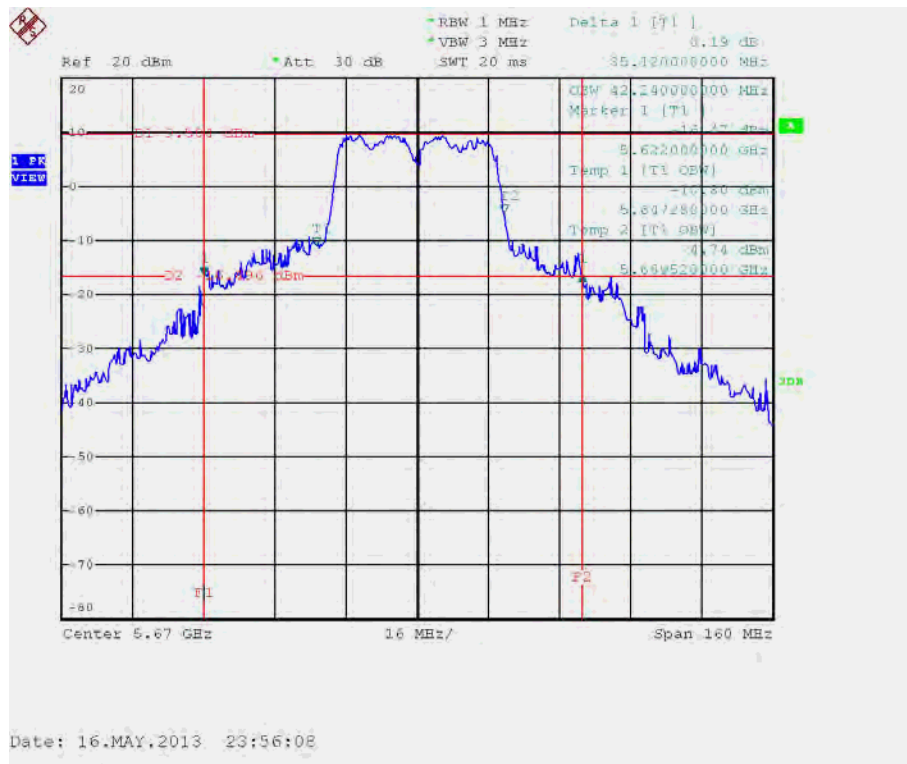

26dB Bandwidth & 99% Occupied Bandwidth Plot on Configuration IEEE 802.11a / Chain 1 + Chain 2 / 5180 MHz

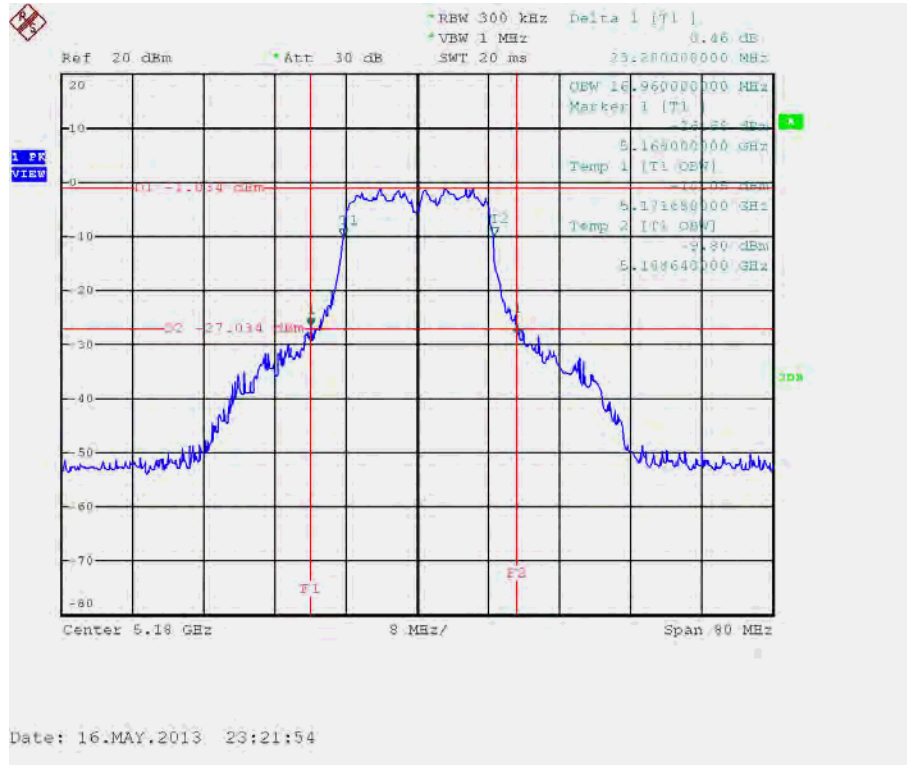

26dB Bandwidth & 99% Occupied Bandwidth Plot on Configuration IEEE 802.11a / Chain 1 + Chain 2 / 5200 MHz

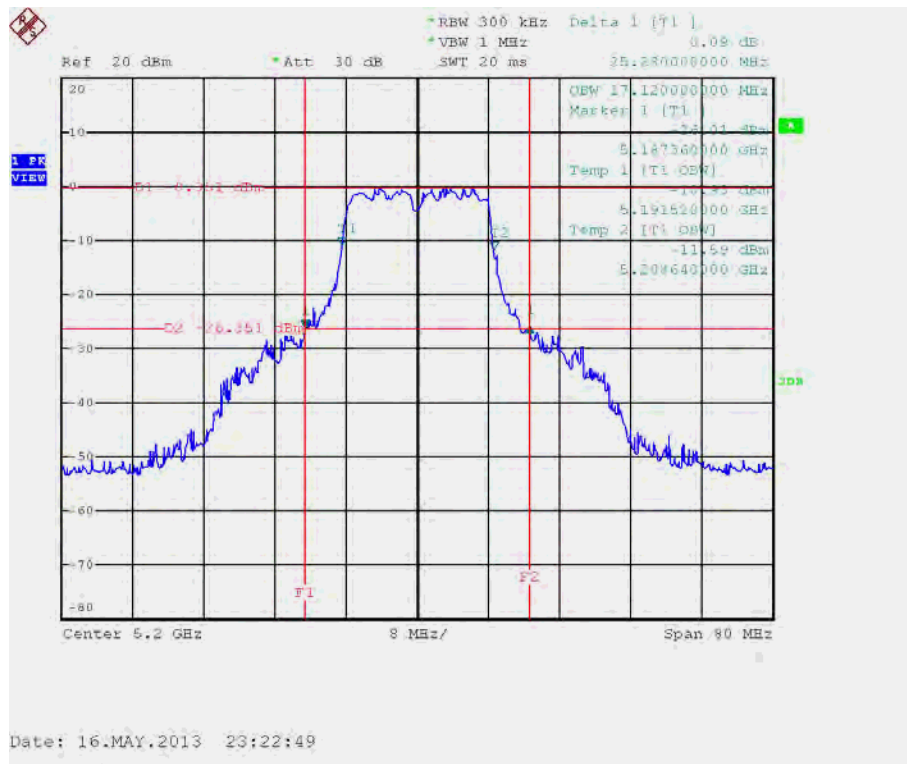

26dB Bandwidth & 99% Occupied Bandwidth Plot on Configuration IEEE 802.11a / Chain 1 + Chain 2 / 5240 MHz

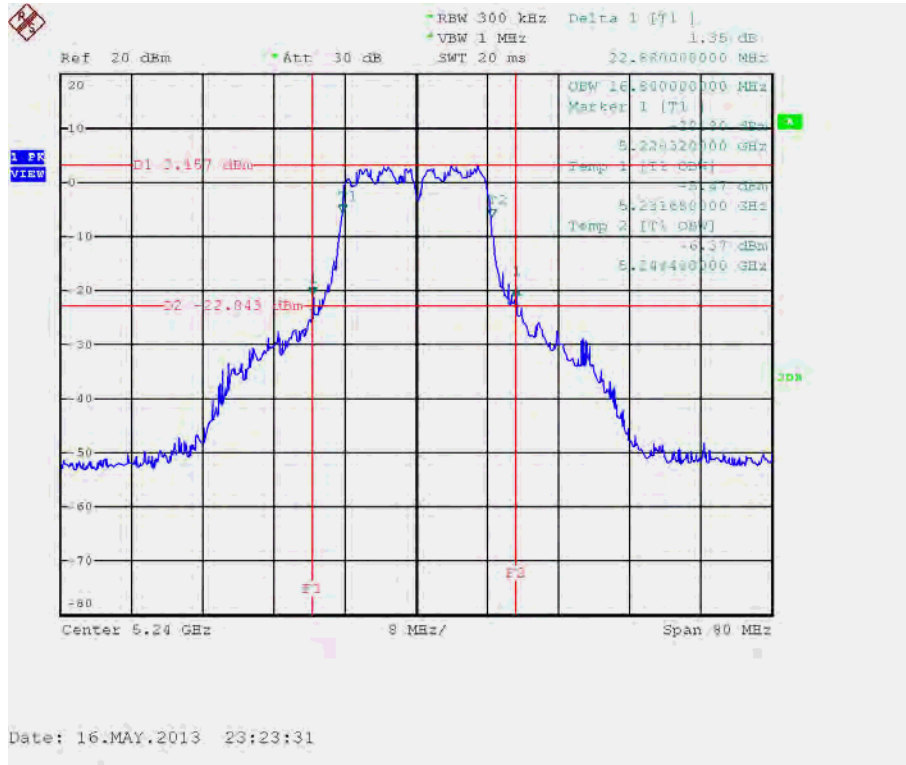

26dB Bandwidth & 99% Occupied Bandwidth Plot on Configuration IEEE 802.11a / Chain 1 + Chain 2 / 5260 MHz

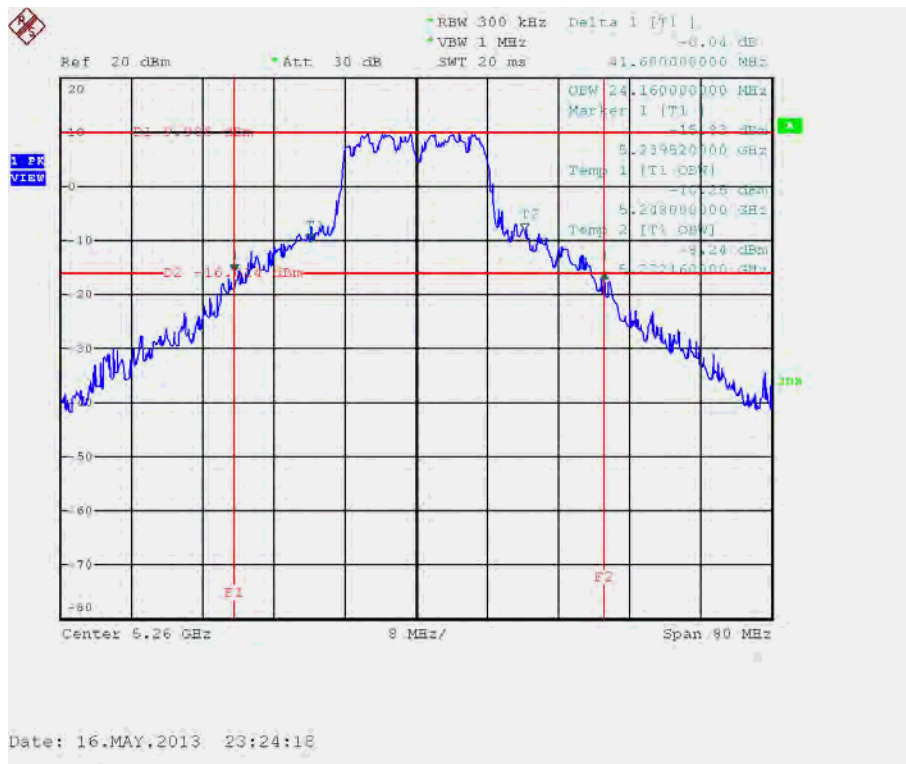

26dB Bandwidth & 99% Occupied Bandwidth Plot on Configuration IEEE 802.11a / Chain 1 + Chain 2 / 5300 MHz

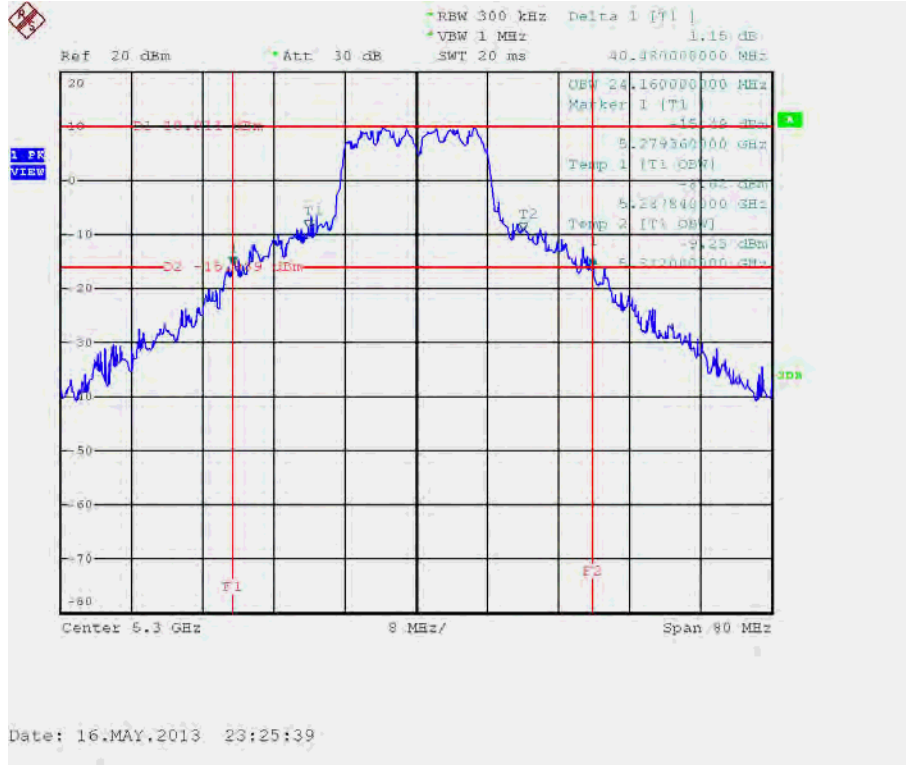

26dB Bandwidth & 99% Occupied Bandwidth Plot on Configuration IEEE 802.11a / Chain 1 + Chain 2 / 5320 MHz

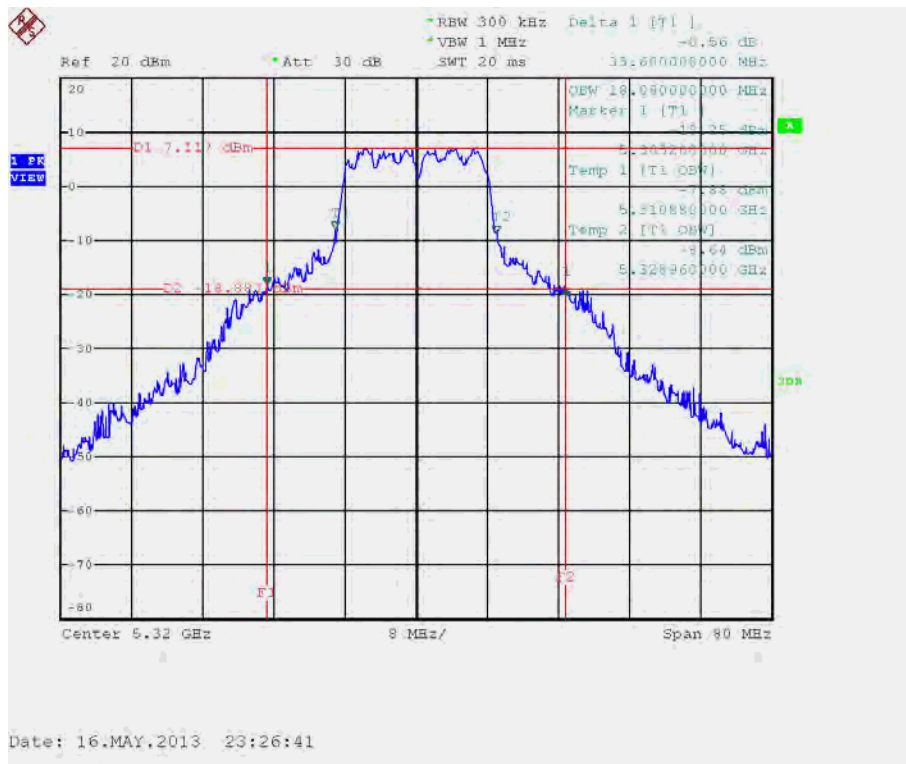

26dB Bandwidth & 99% Occupied Bandwidth Plot on Configuration IEEE 802.11a / Chain 1 + Chain 2 / 5500 MHz

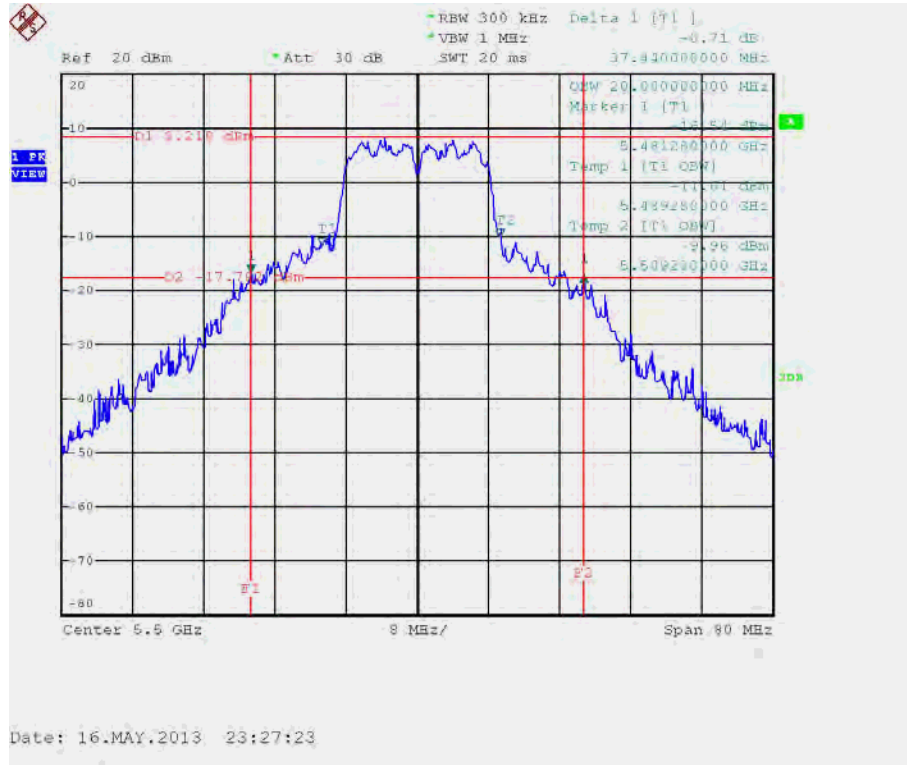

26dB Bandwidth & 99% Occupied Bandwidth Plot on Configuration IEEE 802.11a / Chain 1 + Chain 2 / 5580 MHz

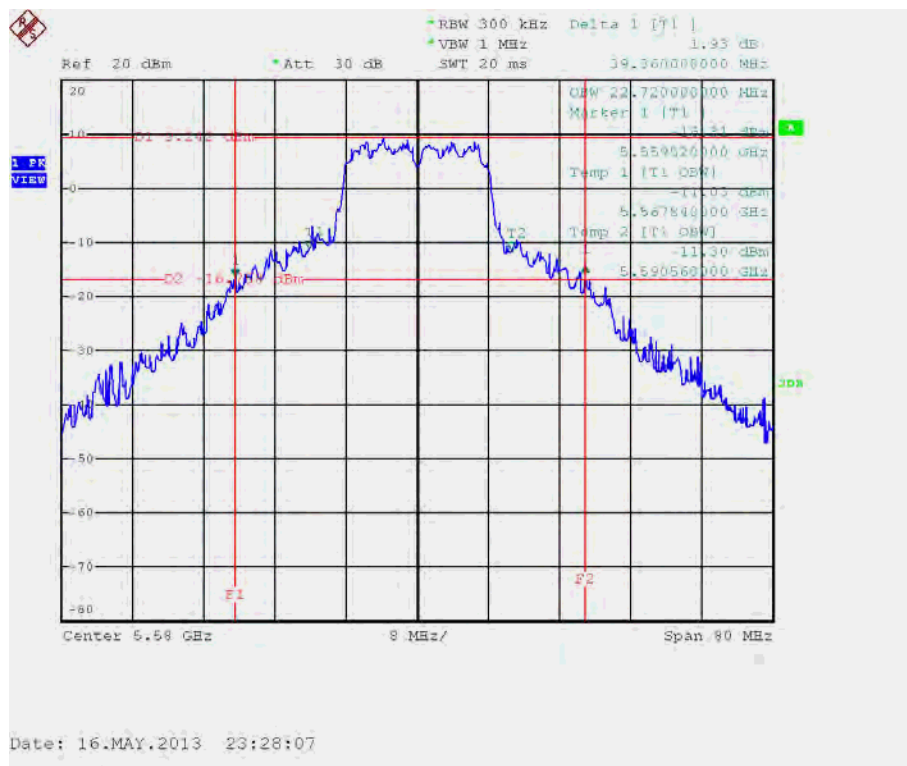

26dB Bandwidth & 99% Occupied Bandwidth Plot on Configuration IEEE 802.11a / Chain 1 + Chain 2 / 5700 MHz

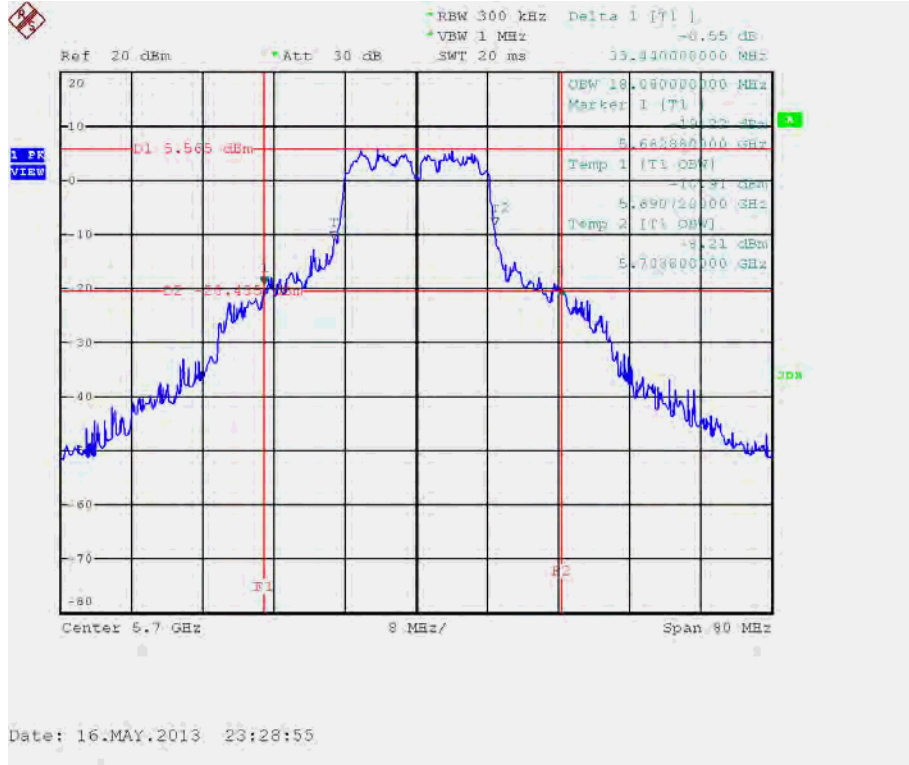

4.3. Maximum Conducted Output Power Measurement

4.3.1. Limit

For the band 5.15–5.25 GHz, the maximum conducted output power over the frequency band of operation shall not exceed the lesser of 50 mW (17dBm) or $4 \text{ dBm} + 10\log B$, where B is the 26 dB emissions bandwidth in MHz. If transmitting antennas of directional gain greater than 6 dBi are used, both the maximum conducted output power and the peak power spectral density shall be reduced by the amount in dB that the directional gain of the antenna exceeds 6 dBi.

For the 5.25-5.35 GHz and 5.470-5.725 GHz bands, the maximum conducted output power over the frequency bands of operation shall not exceed the lesser of 250 mW (24dBm) or $11 \text{ dBm} + 10\log B$, where B is the 26-dB emission bandwidth in MHz. If transmitting antennas of directional gain greater than 6 dBi are used, both the maximum conducted output power and the peak power spectral density shall be reduced by the amount in dB that the directional gain of the antenna exceeds 6 dBi.

4.3.2. Measuring Instruments and Setting

The following table is the setting of the peak power meter.

| Power Meter Parameter | Setting |
|-----------------------|--|
| Bandwidth | 50MHz bandwidth is greater than the EUT emission bandwidth |
| Detector | AVERAGE |

4.3.3. Test Procedures

1. The transmitter output (antenna port) was connected to the power meter.
2. Test was performed in accordance with KDB 789033 D01 v01r03 for Compliance Testing of Unlicensed National Information Infrastructure (U-NII) Devices - Part 15, Subpart E, section (E) Maximum conducted output power =>(3) Method PM (Measurement using an RF average power meter) Multiple antenna systems was performed in accordance with KDB 662911 D01 v01r02 Emissions Testing of Transmitters with Multiple Outputs in the Same Band.
3. When measuring maximum conducted output power with multiple antenna systems, add every result of the values by mathematic formula.

4.3.4. Test Setup Layout

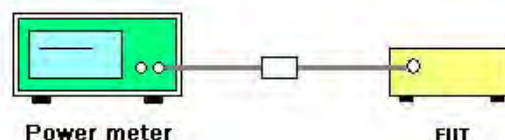

4.3.5. Test Deviation

There is no deviation with the original standard.

4.3.6. EUT Operation during Test

The EUT was programmed to be in continuously transmitting mode.

4.3.7. Test Result of Maximum Conducted Output Power

| | | | |
|---------------|--------------|----------------|--------------|
| Temperature | 25°C | Humidity | 56% |
| Test Engineer | Sean Ku | Configurations | IEEE 802.11n |
| Test Date | May 16, 2013 | | |

Configuration IEEE 802.11n MCS0 20MHz / Chain 1 + Chain 2

| Channel | Frequency | Conducted Power (dBm) | | Total Conducted Output Power (dBm) | Max. Limit (dBm) | Result |
|---------|-----------|-----------------------|---------|------------------------------------|------------------|----------|
| | | Chain 1 | Chain 2 | | | |
| 36 | 5180 MHz | 11.18 | 12.53 | 14.92 | 17.00 | Complies |
| 40 | 5200 MHz | 11.60 | 11.93 | 14.78 | 17.00 | Complies |
| 48 | 5240 MHz | 12.61 | 10.54 | 14.71 | 17.00 | Complies |
| 52 | 5260 MHz | 18.68 | 17.42 | 21.11 | 24.00 | Complies |
| 60 | 5300 MHz | 18.71 | 17.02 | 20.96 | 24.00 | Complies |
| 64 | 5320 MHz | 16.75 | 15.21 | 19.06 | 24.00 | Complies |
| 100 | 5500 MHz | 16.13 | 15.53 | 18.85 | 24.00 | Complies |
| 116 | 5580 MHz | 17.42 | 16.61 | 20.04 | 24.00 | Complies |
| 140 | 5700 MHz | 13.07 | 13.76 | 16.44 | 24.00 | Complies |

Configuration IEEE 802.11n MCS0 40MHz / Chain 1 + Chain 2

| Channel | Frequency | Conducted Power (dBm) | | Total Conducted Output Power (dBm) | Max. Limit (dBm) | Result |
|---------|-----------|-----------------------|---------|------------------------------------|------------------|----------|
| | | Chain 1 | Chain 2 | | | |
| 38 | 5190 MHz | 10.98 | 11.39 | 14.20 | 17.00 | Complies |
| 46 | 5230 MHz | 14.39 | 13.22 | 16.85 | 17.00 | Complies |
| 54 | 5270 MHz | 18.68 | 17.41 | 21.10 | 24.00 | Complies |
| 62 | 5310 MHz | 10.85 | 8.36 | 12.79 | 24.00 | Complies |
| 102 | 5510MHz | 9.96 | 8.95 | 12.49 | 24.00 | Complies |
| 110 | 5550 MHz | 17.19 | 17.81 | 20.52 | 24.00 | Complies |
| 134 | 5670 MHz | 14.34 | 15.41 | 17.92 | 24.00 | Complies |

| | | | |
|---------------|--------------|----------------|--------------|
| Temperature | 25°C | Humidity | 56% |
| Test Engineer | Sean Ku | Configurations | IEEE 802.11a |
| Test Date | May 16, 2013 | | |

Configuration IEEE 802.11a / Chain 1 + Chain 2

| Channel | Frequency | Conducted Power (dBm) | | Total Conducted Output Power (dBm) | Max. Limit (dBm) | Result |
|---------|-----------|-----------------------|---------|------------------------------------|------------------|----------|
| | | Chain 1 | Chain 2 | | | |
| 36 | 5180 MHz | 11.42 | 12.42 | 14.96 | 17.00 | Complies |
| 40 | 5200 MHz | 11.88 | 12.07 | 14.99 | 17.00 | Complies |
| 48 | 5240 MHz | 12.25 | 10.96 | 14.66 | 17.00 | Complies |
| 52 | 5260 MHz | 19.62 | 17.25 | 21.61 | 24.00 | Complies |
| 60 | 5300 MHz | 18.31 | 17.02 | 20.72 | 24.00 | Complies |
| 64 | 5320 MHz | 16.13 | 14.25 | 18.30 | 24.00 | Complies |
| 100 | 5500 MHz | 14.66 | 14.47 | 17.58 | 24.00 | Complies |
| 116 | 5580 MHz | 16.31 | 17.61 | 20.02 | 24.00 | Complies |
| 140 | 5700 MHz | 13.89 | 14.96 | 17.47 | 24.00 | Complies |

4.4. Power Spectral Density Measurement

4.4.1. Limit

The power spectral density is defined as the highest level of power in dBm per MHz generated by the transmitter within the power envelope. The following table is power spectral density limits and decrease power density limit rule refer to section 4.3.1.

| Frequency Range | Power Spectral Density limit (dBm/MHz) |
|-----------------|--|
| 5.15-5.25 GHz | 4 |
| 5.25-5.35 GHz | 11 |
| 5.470-5.725 GHz | 11 |

4.4.2. Measuring Instruments and Setting

Please refer to section 5 of equipments list in this report. The following table is the setting of the spectrum analyzer.

| Spectrum Parameter | Setting |
|--------------------|--|
| Attenuation | Auto |
| Span Frequency | Encompass the entire emissions bandwidth (EBW) of the signal |
| RBW | 1000 kHz |
| VBW | 3000 kHz |
| Detector | RMS |
| Trace | AVERAGE |
| Sweep Time | Auto |
| Trace Average | 100 times |

4.4.3. Test Procedures

1. The transmitter output (antenna port) was connected RF switch to the spectrum analyzer.
2. Test was performed in accordance with KDB 789033 D01 v01r03 for Compliance Testing of Unlicensed National Information Infrastructure (U-NII) Devices - Part 15, Subpart E, section (C) Maximum conducted output power => (d) Method SA-2 (trace averaging across on and off times of the EUT transmissions, followed by duty cycle correction).
3. Multiple antenna systems was performed in accordance with KDB 662911 D01 v01r02 in-Band Power Spectral Density (PSD) Measurements (1) Measure and sum the spectra across the outputs.
4. When measuring first spectral bin of output 1 is summed with that in the first spectral bin of output 2 and that from the first spectral bin of output 3 and so on up to the Nth output to obtain the value for the first frequency bin of the summed spectrum. The summed spectrum value for each of the other frequency bins is computed in the same way.

4.4.4. Test Setup Layout

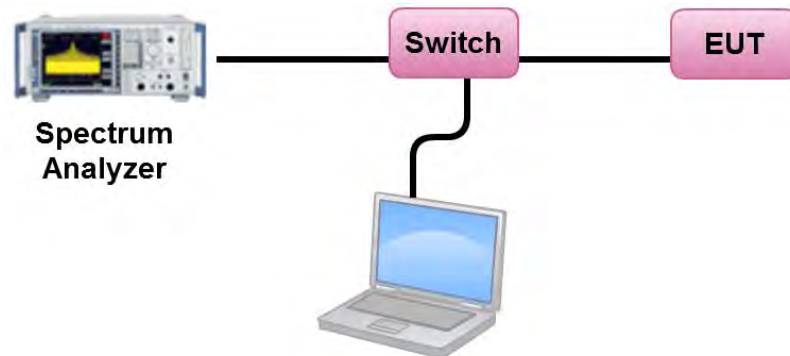

4.4.5. Test Deviation

There is no deviation with the original standard.

4.4.6. EUT Operation during Test

The EUT was programmed to be in continuously transmitting mode.

4.4.7. Test Result of Power Spectral Density

| | | | |
|---------------|--------------|----------------|--------------|
| Temperature | 25°C | Humidity | 56% |
| Test Engineer | Sean Ku | Configurations | IEEE 802.11n |
| Test Date | May 16, 2013 | | |

Configuration IEEE 802.11n MCS0 20MHz / Chain 1 + Chain 2

| Channel | Frequency | Total Power Density (dBm/MHz) | Max. Limit (dBm/MHz) | Result |
|---------|-----------|-------------------------------|----------------------|----------|
| 36 | 5180 MHz | 1.28 | 1.55 | Complies |
| 40 | 5200 MHz | 1.14 | 1.55 | Complies |
| 48 | 5240 MHz | 1.30 | 1.55 | Complies |
| 52 | 5260 MHz | 8.28 | 8.55 | Complies |
| 60 | 5300 MHz | 8.04 | 8.55 | Complies |
| 64 | 5320 MHz | 6.13 | 8.55 | Complies |
| 100 | 5500 MHz | 6.05 | 8.55 | Complies |
| 116 | 5580 MHz | 7.13 | 8.55 | Complies |
| 140 | 5700 MHz | 3.22 | 8.55 | Complies |

Note: Directional gain=GANT+10log(NANT/Nss) =8.45dBi >6dBi, so limit = 4 – (8.45 – 6) = 1.55dBm/MHz
 Directional gain=GANT+10log(NANT/Nss) =8.45dBi >6dBi, so limit = 11 – (8.45 – 6) = 8.55dBm/MHz

Configuration IEEE 802.11n MCS0 40MHz / Chain 1 + Chain 2

| Channel | Frequency | Total Power Density (dBm/MHz) | Max. Limit (dBm/MHz) | Result |
|---------|-----------|-------------------------------|----------------------|----------|
| 38 | 5190 MHz | -1.73 | 1.55 | Complies |
| 46 | 5230 MHz | -1.13 | 1.55 | Complies |
| 54 | 5270 MHz | 3.34 | 8.55 | Complies |
| 62 | 5310 MHz | -5.91 | 8.55 | Complies |
| 102 | 5510MHz | -4.50 | 8.55 | Complies |
| 110 | 5550 MHz | 3.42 | 8.55 | Complies |
| 134 | 5670 MHz | 0.72 | 8.55 | Complies |

Note: Directional gain=GANT+10log(NANT/Nss) =8.45dBi >6dBi, so limit = 4 – (8.45 – 6) = 1.55dBm/MHz
 Directional gain=GANT+10log(NANT/Nss) =8.45dBi >6dBi, so limit = 11 – (8.45 – 6) = 8.55dBm/MHz

| | | | |
|---------------|--------------|----------------|--------------|
| Temperature | 25°C | Humidity | 56% |
| Test Engineer | Sean Ku | Configurations | IEEE 802.11a |
| Test Date | May 16, 2013 | | |

Configuration IEEE 802.11a / Chain 1 + Chain 2

| Channel | Frequency | Total Power Density (dBm/MHz) | Max. Limit (dBm/MHz) | Result |
|---------|-----------|----------------------------------|-------------------------|----------|
| 36 | 5180 MHz | 1.32 | 1.55 | Complies |
| 40 | 5200 MHz | 1.25 | 1.55 | Complies |
| 48 | 5240 MHz | 1.36 | 1.55 | Complies |
| 52 | 5260 MHz | 8.44 | 8.55 | Complies |
| 60 | 5300 MHz | 7.90 | 8.55 | Complies |
| 64 | 5320 MHz | 5.30 | 8.55 | Complies |
| 100 | 5500 MHz | 5.79 | 8.55 | Complies |
| 116 | 5580 MHz | 6.79 | 8.55 | Complies |
| 140 | 5700 MHz | 4.01 | 8.55 | Complies |

Note: Directional gain=GANT+10log(NANT/Nss) =8.45dBi >6dBi, so limit = 4 - (8.45 - 6) = 1.55dBm/MHz
 Directional gain=GANT+10log(NANT/Nss) =8.45dBi >6dBi, so limit = 11 - (8.45 - 6) = 8.55dBm/MHz

Note: All the test values were listed in the report.

For plots, only the channel with maximum results was shown.

Power Density Plot on Configuration IEEE 802.11n MCS0 20MHz / Chain 1 + Chain 2 / 5240 MHz

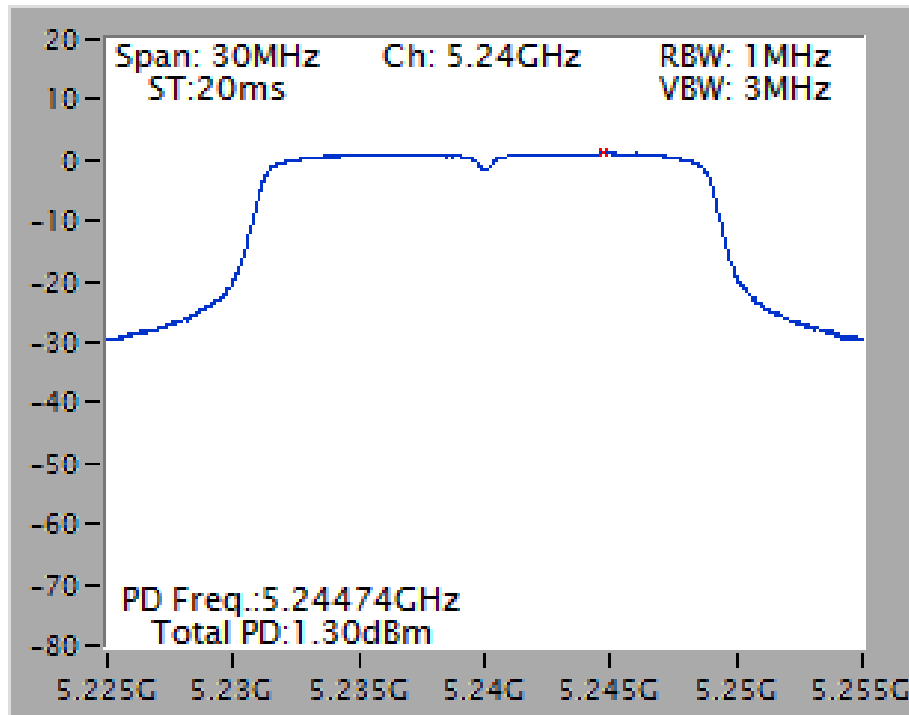

Power Density Plot on Configuration IEEE 802.11n MCS0 20MHz / Chain 1 + Chain 2 / 5260 MHz

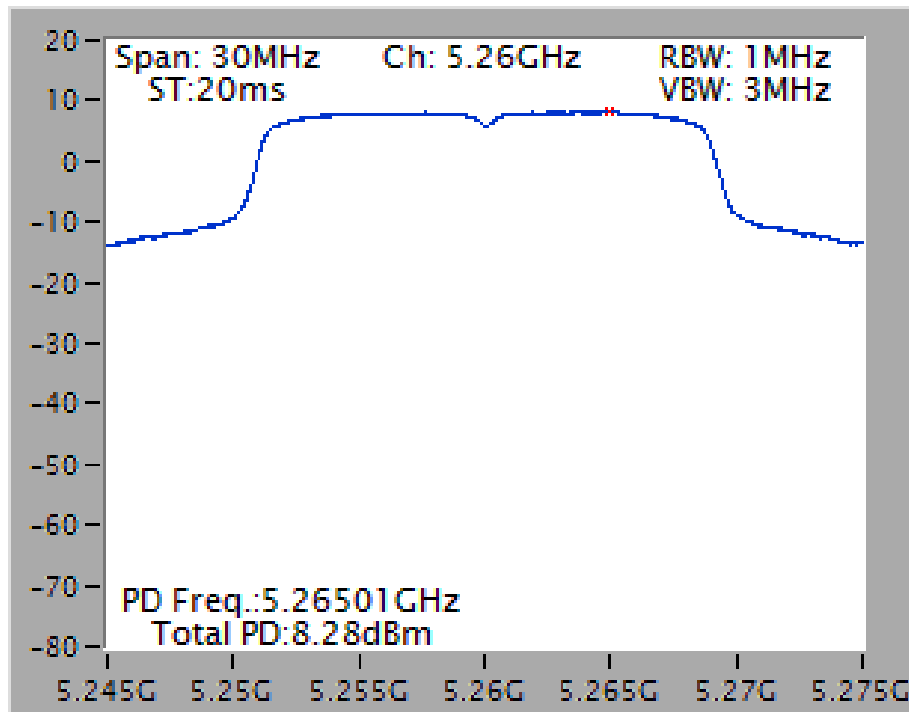

Power Density Plot on Configuration IEEE 802.11n MCS0 20MHz / Chain 1 + Chain 2 / 5580 MHz

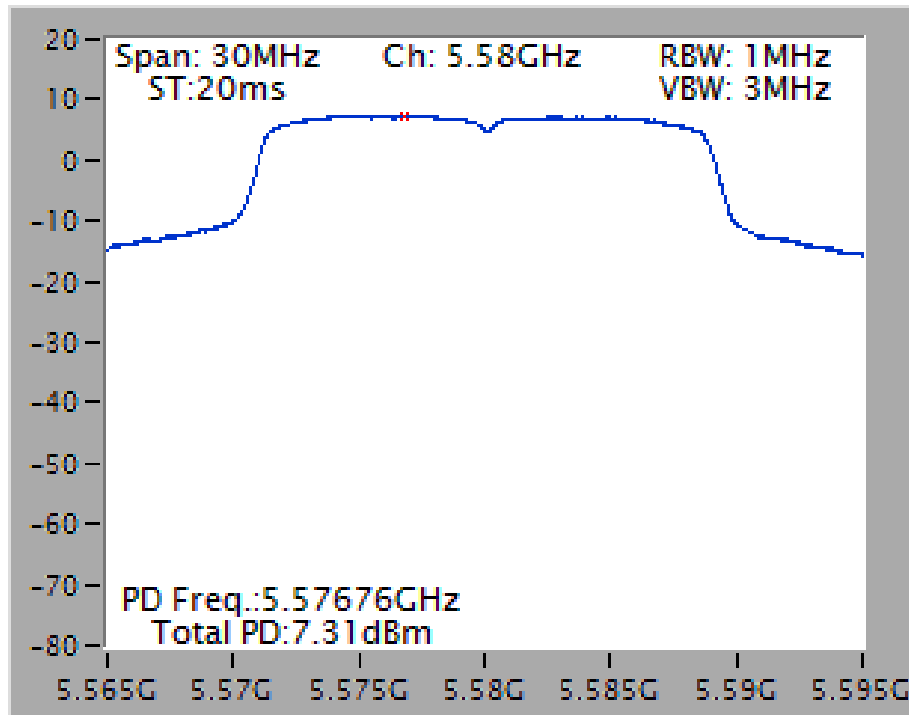

Power Density Plot on Configuration IEEE 802.11n MCS0 40MHz / Chain 1 + Chain 2 / 5230 MHz

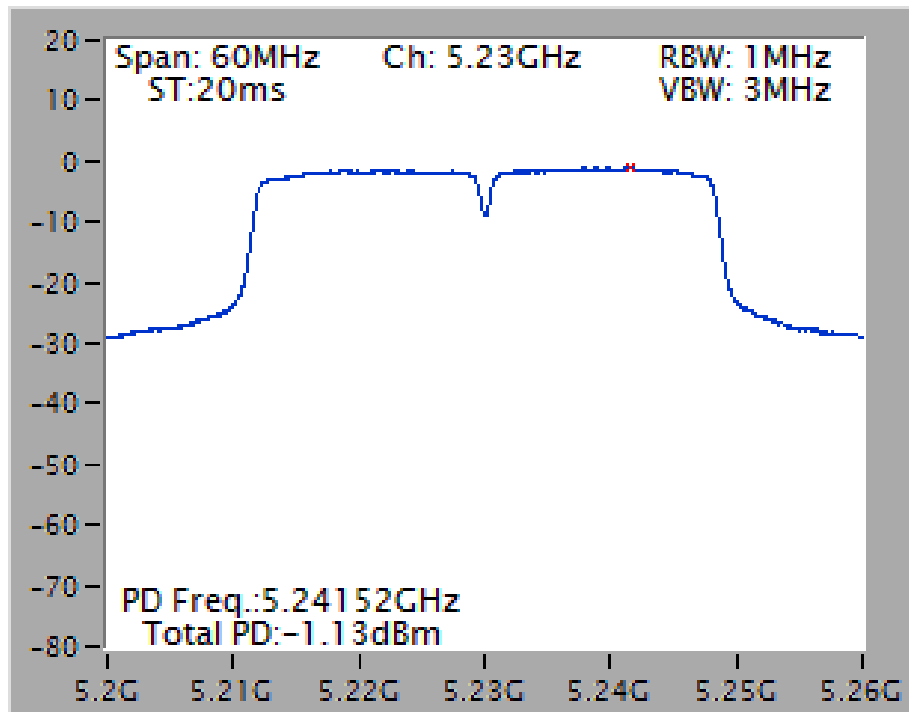

Power Density Plot on Configuration IEEE 802.11n MCS0 40MHz / Chain 1 + Chain 2 / 5270 MHz

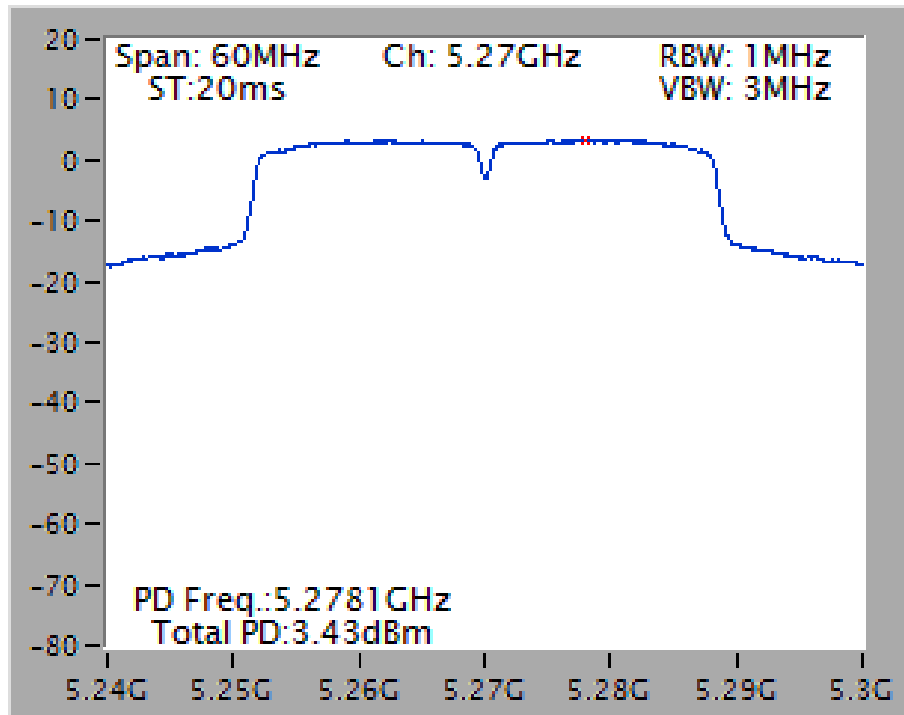

Power Density Plot on Configuration IEEE 802.11n MCS0 40MHz / Chain 1 + Chain 2 / 5550 MHz

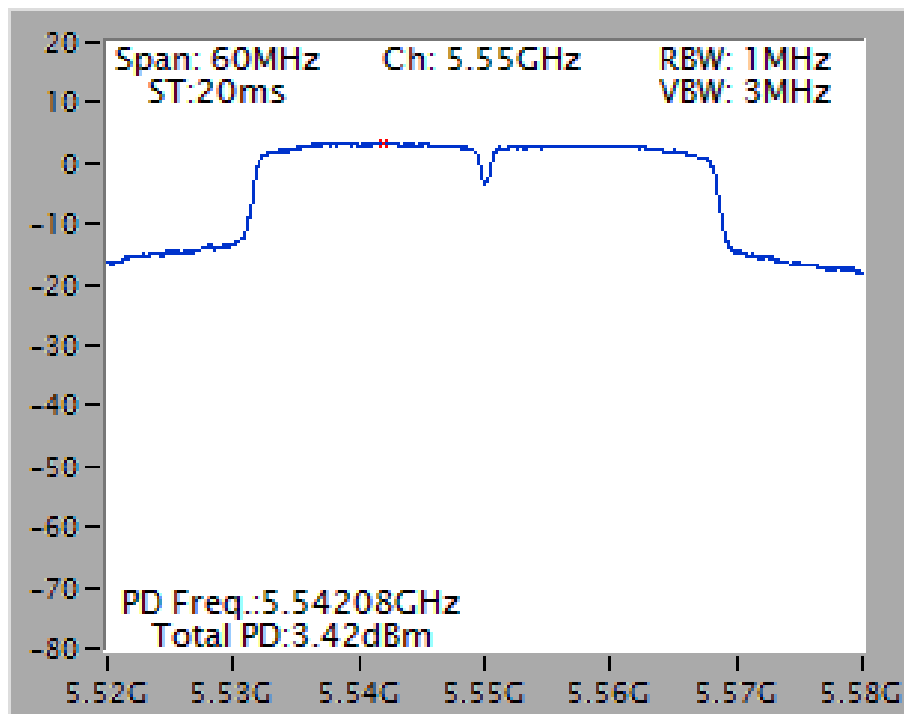

Power Density Plot on Configuration IEEE 802.11a / Chain 1 + Chain 2 / 5240 MHz

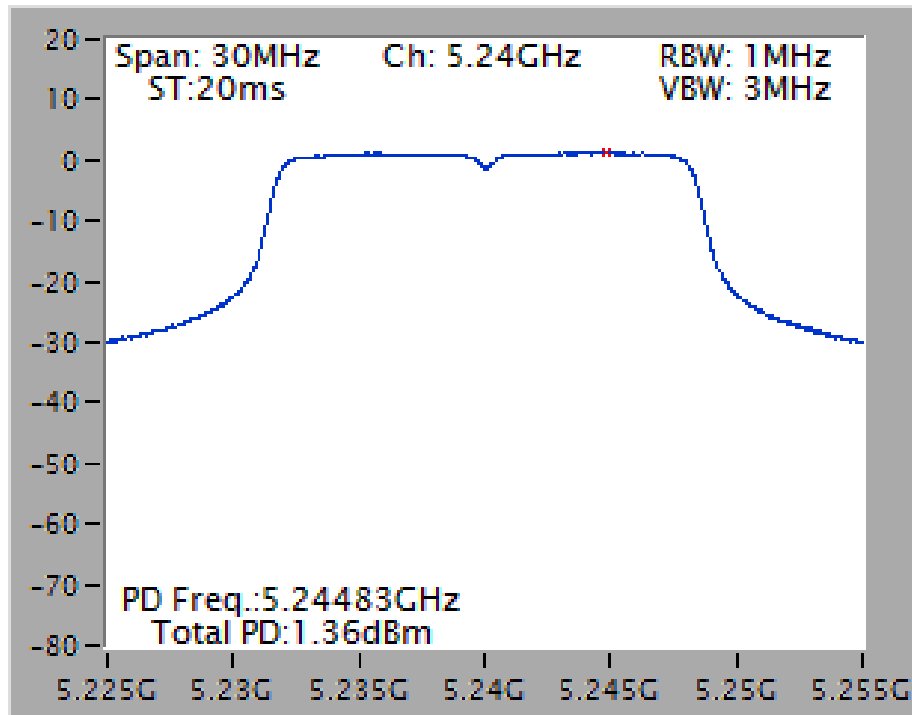

Power Density Plot on Configuration IEEE 802.11a / Chain 1 + Chain 2 / 5260 MHz

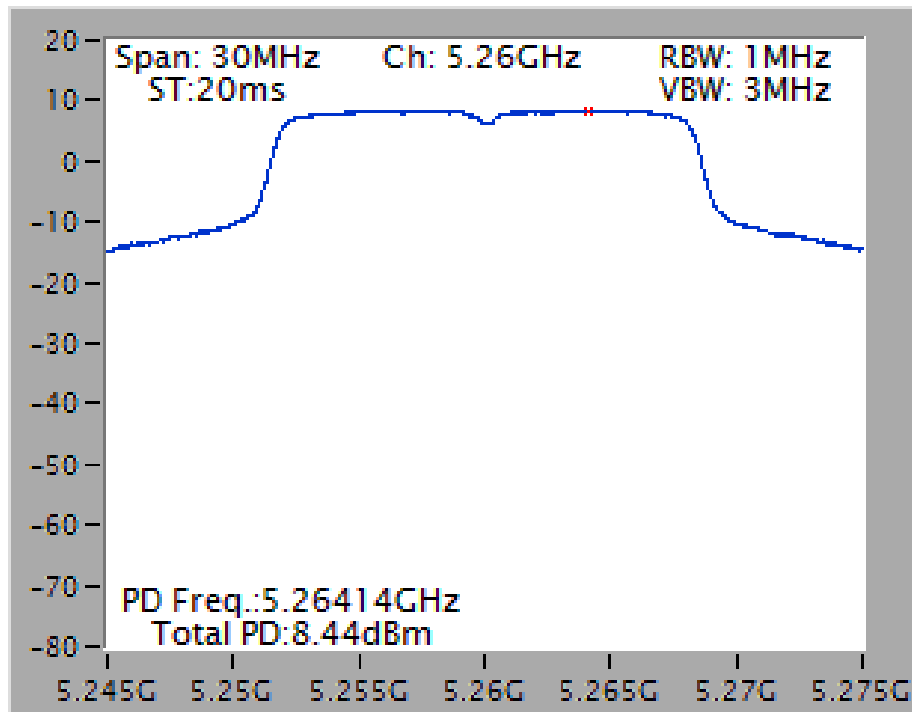

Power Density Plot on Configuration IEEE 802.11a / Chain 1 + Chain 2 / 5580 MHz

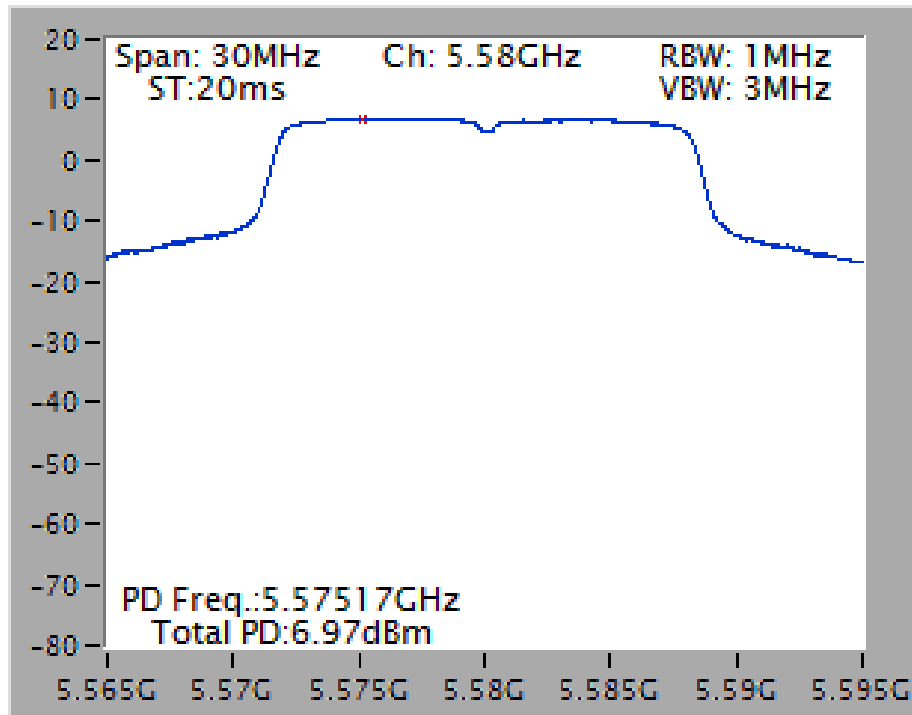

4.5. Peak Excursion Measurement

4.5.1. Limit

The ratio of the peak excursion of the modulation envelope (measured using a peak hold function) to the maximum conducted output power (measured as specified above) shall not exceed 13 dB across any 1 MHz bandwidth or the emissions bandwidth whichever is less.

4.5.2. Measuring Instruments and Setting

Please refer to section 5 of equipments list in this report. The following table is the setting of the spectrum analyzer.

| Spectrum Parameter | Setting |
|--------------------|---|
| Attenuation | Auto |
| Span Frequency | Encompass the entire emissions bandwidth (EBW) of the signal |
| RBW | 1MHz (Peak Trace) / 1MHz (Average Trace) |
| VBW | ≥ 3MHz (Peak Trace) / ≥ 3MHz (Average Trace) |
| Detector | Peak (Peak Trace) / RMS (Average Trace) |
| Trace | Trace: Max hold (Peak Trace) / Trace Average Sweep Count 100 (Average Trace) |
| Sweep Time | AUTO |

4.5.3. Test Procedures

- Trace A, Set RBW =1MHz, VBW = 3MHz, Span >26dB bandwidth, Max. hold.
- Delta Mark trace A Maximum frequency and trace B same frequency.
- Repeat the above procedure until measurements for all frequencies were complete.
- Testing each modulation mode on a single channel in single operating band at single output port. All signal types need test (DSSS, OFDM). All modulation types need test (BPSK, QPSK, 16-QAM, 64-QAM, 256-QAM). All bandwidth modes need test.

4.5.4. Test Setup Layout

This test setup layout is the same as that shown in section 4.4.4.

4.5.5. Test Deviation

There is no deviation with the original standard.

4.5.6. EUT Operation during Test

The EUT was programmed to be in continuously transmitting mode.

4.5.7. Test Result of Peak Excursion

| | | | |
|---------------|---------|----------------|--------------|
| Temperature | 25°C | Humidity | 56% |
| Test Engineer | Sean Ku | Configurations | IEEE 802.11n |

Configuration IEEE 802.11n MCS0 20MHz / Chain 1 + Chain 2

| Modulation | Frequency | Peak Excursion (dB) | Max. Limit (dB) | Result |
|-------------|-----------|---------------------|-----------------|----------|
| BSPK(MCS0) | 5180MHz | 8.57 | 13 | Complies |
| QPSK(MCS1) | 5180MHz | 8.43 | 13 | Complies |
| 16QAM(MCS3) | 5180MHz | 8.67 | 13 | Complies |
| 64QAM(MCS5) | 5180MHz | 10.33 | 13 | Complies |
| BSPK(MCS0) | 5260MHz | 9.16 | 13 | Complies |
| QPSK(MCS1) | 5260MHz | 8.38 | 13 | Complies |
| 16QAM(MCS3) | 5260MHz | 9.28 | 13 | Complies |
| 64QAM(MCS5) | 5260MHz | 10.07 | 13 | Complies |
| BSPK(MCS0) | 5580MHz | 9.01 | 13 | Complies |
| QPSK(MCS1) | 5580MHz | 8.57 | 13 | Complies |
| 16QAM(MCS3) | 5580MHz | 8.83 | 13 | Complies |
| 64QAM(MCS5) | 5580MHz | 9.50 | 13 | Complies |

Configuration IEEE 802.11n MCS0 40MHz / Chain 1 + Chain 2

| Modulation | Frequency | Peak Excursion (dB) | Max. Limit (dB) | Result |
|-------------|-----------|---------------------|-----------------|----------|
| BSPK(MCS0) | 5230MHz | 9.31 | 13 | Complies |
| QPSK(MCS1) | 5230MHz | 9.37 | 13 | Complies |
| 16QAM(MCS3) | 5230MHz | 9.75 | 13 | Complies |
| 64QAM(MCS5) | 5230MHz | 9.29 | 13 | Complies |
| BSPK(MCS0) | 5270MHz | 9.48 | 13 | Complies |
| QPSK(MCS1) | 5270MHz | 9.40 | 13 | Complies |
| 16QAM(MCS3) | 5270MHz | 9.27 | 13 | Complies |
| 64QAM(MCS5) | 5270MHz | 9.07 | 13 | Complies |
| BSPK(MCS0) | 5550MHz | 9.23 | 13 | Complies |
| QPSK(MCS1) | 5550MHz | 9.13 | 13 | Complies |
| 16QAM(MCS3) | 5550MHz | 9.50 | 13 | Complies |
| 64QAM(MCS5) | 5550MHz | 9.35 | 13 | Complies |

| | | | |
|----------------------|---------|-----------------------|--------------|
| Temperature | 25°C | Humidity | 56% |
| Test Engineer | Sean Ku | Configurations | IEEE 802.11a |

Configuration IEEE 802.11a / Chain 1 + Chain 2

| Modulation | Frequency | Peak Excursion (dB) | Max. Limit (dB) | Result |
|-------------------|------------------|----------------------------|------------------------|-----------------|
| BSPK(6Mbps) | 5200MHz | 8.99 | 13 | Complies |
| QPSK(12Mbps) | 5200MHz | 9.16 | 13 | Complies |
| 16QAM(24Mbps) | 5200MHz | 10.48 | 13 | Complies |
| 64QAM(48Mbps) | 5200MHz | 10.17 | 13 | Complies |
| BSPK(6Mbps) | 5260MHz | 9.06 | 13 | Complies |
| QPSK(12Mbps) | 5260MHz | 8.77 | 13 | Complies |
| 16QAM(24Mbps) | 5260MHz | 8.74 | 13 | Complies |
| 64QAM(48Mbps) | 5260MHz | 10.15 | 13 | Complies |
| BSPK(6Mbps) | 5580MHz | 8.75 | 13 | Complies |
| QPSK(12Mbps) | 5580MHz | 8.64 | 13 | Complies |
| 16QAM(24Mbps) | 5580MHz | 8.65 | 13 | Complies |
| 64QAM(48Mbps) | 5580MHz | 10.00 | 13 | Complies |

Note: Only the channel with maximum results was listed in the report.

Peak Excursion Plot on Configuration IEEE 802.11n MCS0 20MHz / Chain 1 + Chain 2 / 64QAM(MCS5) / 5180 MHz

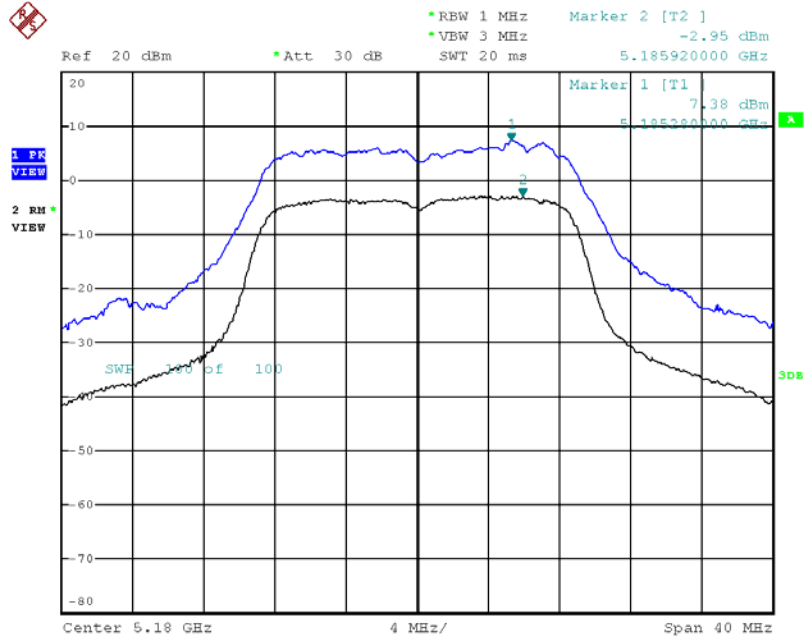

Date: 17.MAY.2013 00:44:41

Peak Excursion Plot on Configuration IEEE 802.11n MCS0 20MHz / Chain 1 + Chain 2 / 64QAM(MCS5) / 5260 MHz

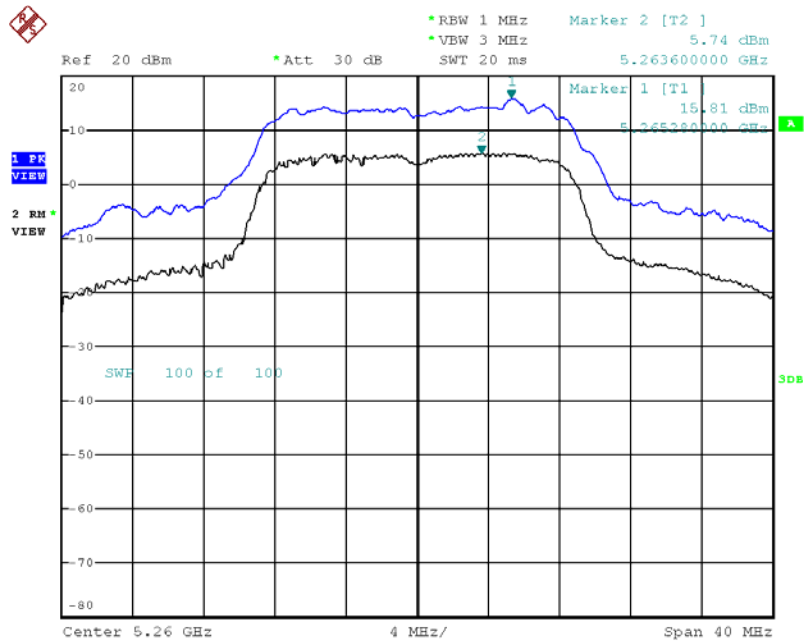

Date: 17.MAY.2013 00:47:59

Peak Excursion Plot on Configuration IEEE 802.11n MCS0 20MHz / Chain 1 + Chain 2 / 64QAM(MCS5) / 5580 MHz

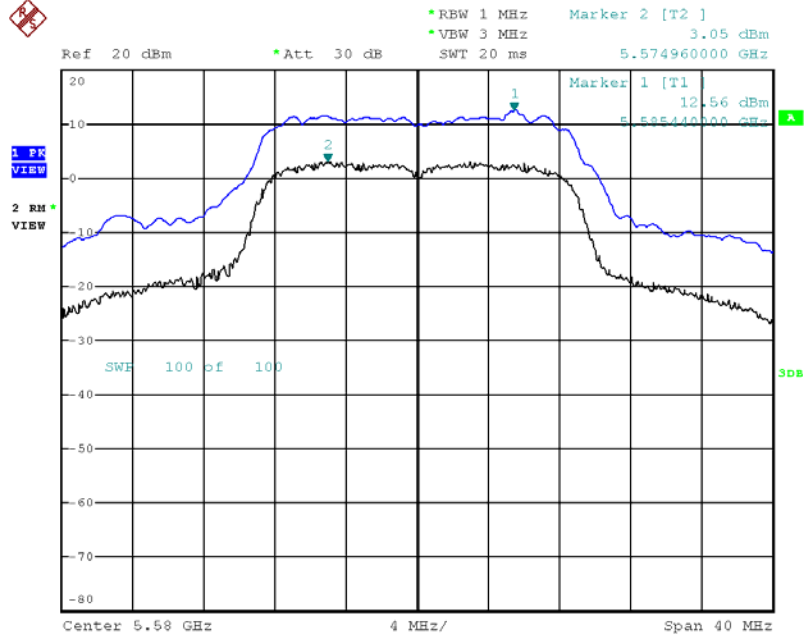

Date: 17.MAY.2013 00:53:57

Peak Excursion Plot on Configuration IEEE 802.11n MCS0 40MHz / Chain 1 + Chain 2 / 16QAM(MCS3) / 5230 MHz

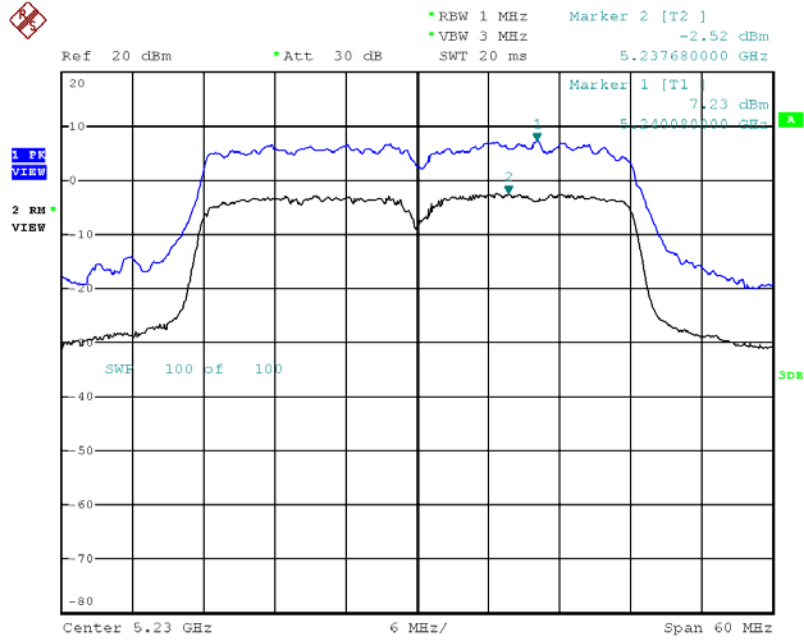

Date: 17.MAY.2013 01:00:29

Peak Excursion Plot on Configuration IEEE 802.11n MCS0 40MHz / Chain 1 + Chain 2 / BSPK(MCS0) / 5270 MHz

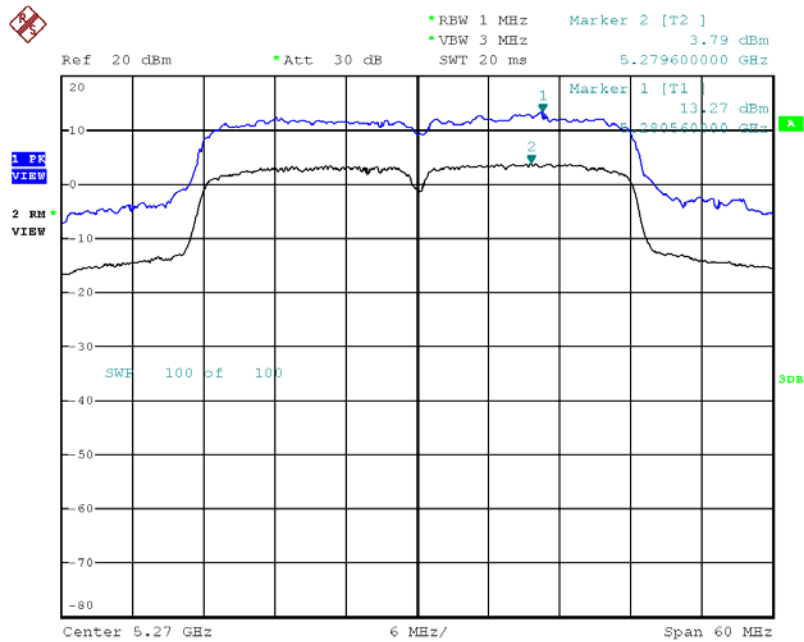

Date: 17.MAY.2013 01:07:40

Peak Excursion Plot on Configuration IEEE 802.11n MCS0 40MHz / Chain 1 + Chain 2 / 16QAM(MCS3) / 5550 MHz

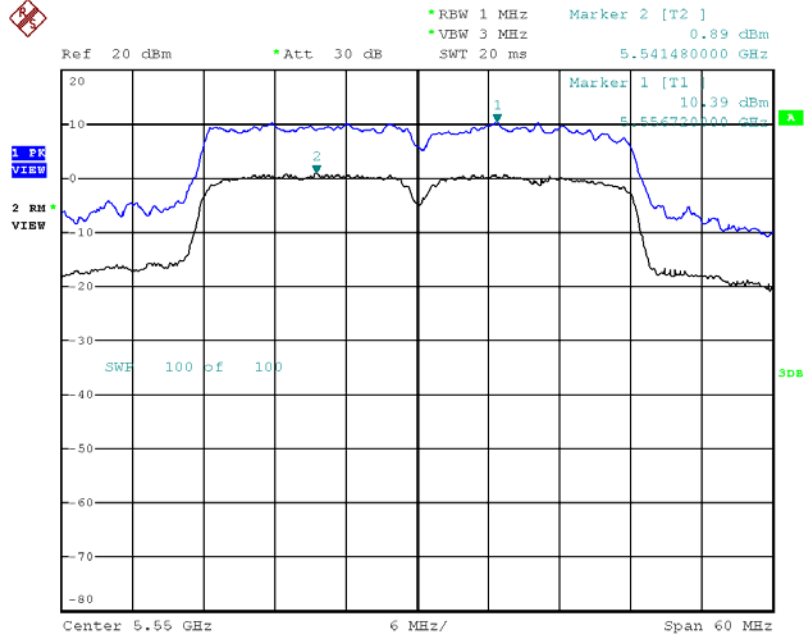

Date: 17.MAY.2013 01:10:52

Peak Excursion Plot on Configuration IEEE 802.11a / Chain 1 + Chain 2 / 16QAM(24Mbps) / 5200 MHz

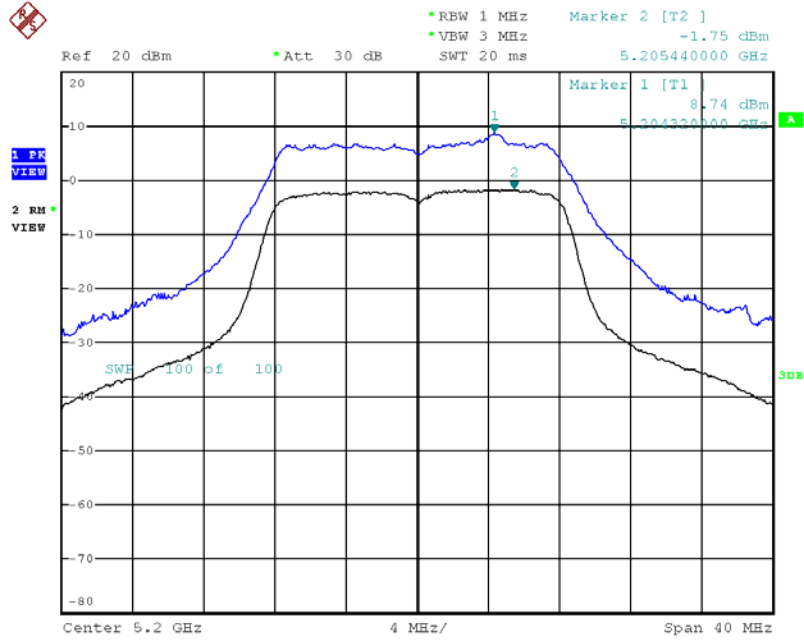

Date: 17.MAY.2013 00:12:04

Peak Excursion Plot on Configuration IEEE 802.11a / Chain 1 + Chain 2 / 64QAM(48Mbps) / 5260 MHz

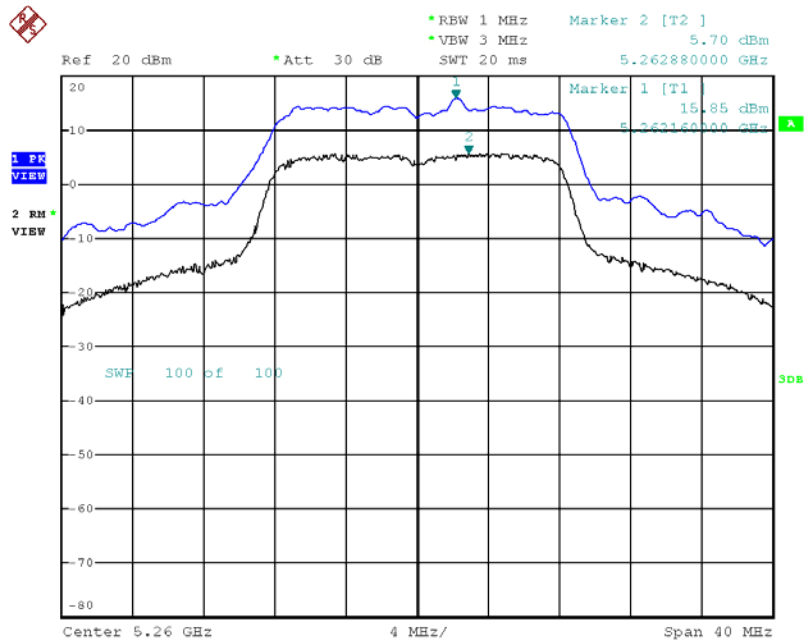

Date: 17.MAY.2013 00:15:00

Peak Excursion Plot on Configuration IEEE 802.11a / Chain 1 + Chain 2 / 64QAM(48Mbps) / 5580 MHz

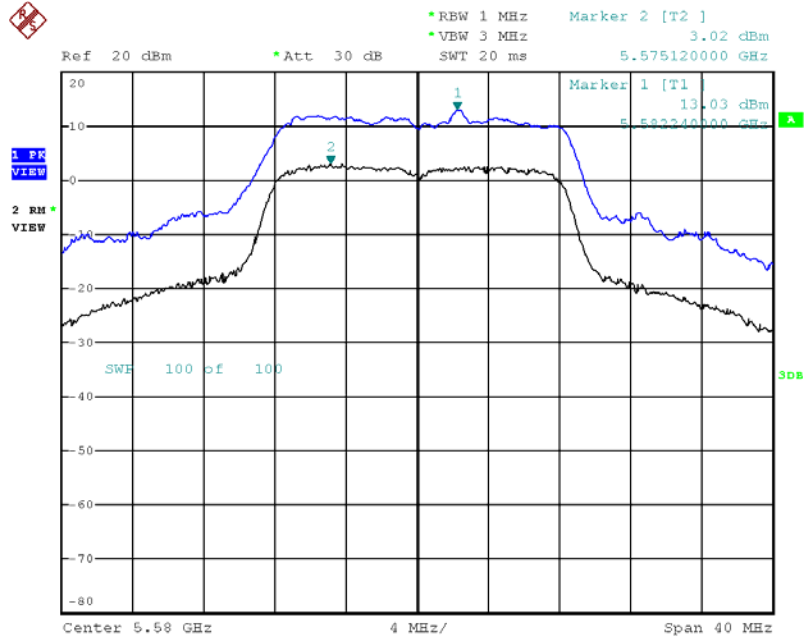

Date: 17.MAY.2013 00:40:12

4.6. Radiated Emissions Measurement

4.6.1. Limit

For transmitters operating in the 5.15-5.35 GHz band: all emissions outside of the 5.15-5.35 GHz band shall not exceed a -27dBm peak limit or average 54dBuV/m and peak 74dBuV/m limits. For transmitters operating in the 5.470-5.725 GHz band: all emissions outside of the 5.470-5.725 GHz band shall not exceed a -27dBm peak limit or average 54dBuV/m and peak 74dBuV/m limits. For transmitters operating in the 5.725-5.825 GHz band: all emissions within the frequency range from the band edge to 10 MHz above or below the band edge shall not exceed an EIRP of -17 dBm/MHz (78.3dBuV/m at 3m). In addition, In case the emission fall within the restricted band specified on 15.205(a), then the 15.209(a) limit in the table below has to be followed.

| Frequencies (MHz) | Field Strength (micorvolts/meter) | Measurement Distance (meters) |
|-------------------|-----------------------------------|-------------------------------|
| 0.009~0.490 | 2400/F(KHz) | 300 |
| 0.490~1.705 | 24000/F(KHz) | 30 |
| 1.705~30.0 | 30 | 30 |
| 30~88 | 100 | 3 |
| 88~216 | 150 | 3 |
| 216~960 | 200 | 3 |
| Above 960 | 500 | 3 |

4.6.2. Measuring Instruments and Setting

Please refer to section 5 of equipments list in this report. The following table is the setting of spectrum analyzer and receiver.

| Spectrum Parameter | Setting |
|---|--|
| Attenuation | Auto |
| Start Frequency | 1000 MHz |
| Stop Frequency | 40 GHz |
| RBW / VBW (Emission in restricted band) | 1MHz / 3MHz for Peak, 1 MHz / 10Hz for Average |
| RBW / VBW (Emission in non-restricted band) | 1MHz / 3MHz for peak |

| Receiver Parameter | Setting |
|------------------------|-----------------------------------|
| Attenuation | Auto |
| Start ~ Stop Frequency | 9kHz~150kHz / RBW 200Hz for QP |
| Start ~ Stop Frequency | 150kHz~30MHz / RBW 9kHz for QP |
| Start ~ Stop Frequency | 30MHz~1000MHz / RBW 120kHz for QP |

4.6.3. Test Procedures

1. Configure the EUT according to ANSI C63.10. The EUT was placed on the top of the turntable 0.8 meter above ground. The phase center of the receiving antenna mounted on the top of a height-variable antenna tower was placed 3 meters far away from the turntable.
2. Power on the EUT and all the supporting units. The turntable was rotated by 360 degrees to determine the position of the highest radiation.
3. The height of the broadband receiving antenna was varied between one meter and four meters above ground to find the maximum emissions field strength of both horizontal and vertical polarization.
4. For each suspected emissions, the antenna tower was scan (from 1 M to 4 M) and then the turntable was rotated (from 0 degree to 360 degrees) to find the maximum reading.
5. Set the test-receiver system to Peak or CISPR quasi-peak Detect Function with specified bandwidth under Maximum Hold Mode.
6. For emissions above 1GHz, use 1MHz VBW and RBW for peak reading. Then 1MHz RBW and 10Hz VBW for average reading in spectrum analyzer.
7. When the radiated emissions limits are expressed in terms of the average value of the emissions, and pulsed operation is employed, the measurement field strength shall be determined by averaging over one complete pulse train, including blanking intervals, as long as the pulse train does not exceed 0.1 seconds. As an alternative (provided the transmitter operates for longer than 0.1 seconds) or in cases where the pulse train exceeds 0.1 seconds, the measured field strength shall be determined from the average absolute voltage during a 0.1 second interval during which the field strength is at its maximum value.
8. If the emissions level of the EUT in peak mode was 3 dB lower than the average limit specified, then testing will be stopped and peak values of EUT will be reported, otherwise, the emissions which do not have 3 dB margin will be repeated one by one using the quasi-peak method for below 1GHz.
9. For testing above 1GHz, the emissions level of the EUT in peak mode was lower than average limit (that means the emissions level in peak mode also complies with the limit in average mode), then testing will be stopped and peak values of EUT will be reported, otherwise, the emissions will be measured in average mode again and reported.
10. In case the emission is lower than 30MHz, loop antenna has to be used for measurement and the recorded data should be QP measured by receiver. High – Low scan is not required in this case.

4.6.4. Test Setup Layout

For radiated emissions below 1GHz

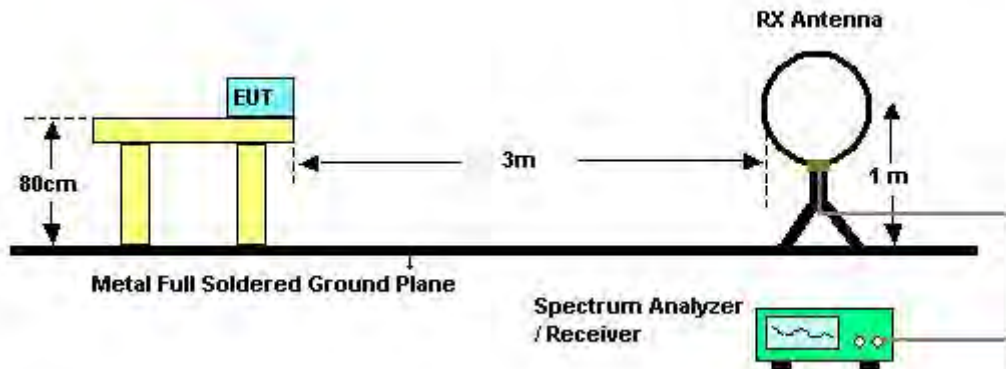

For radiated emissions above 1GHz

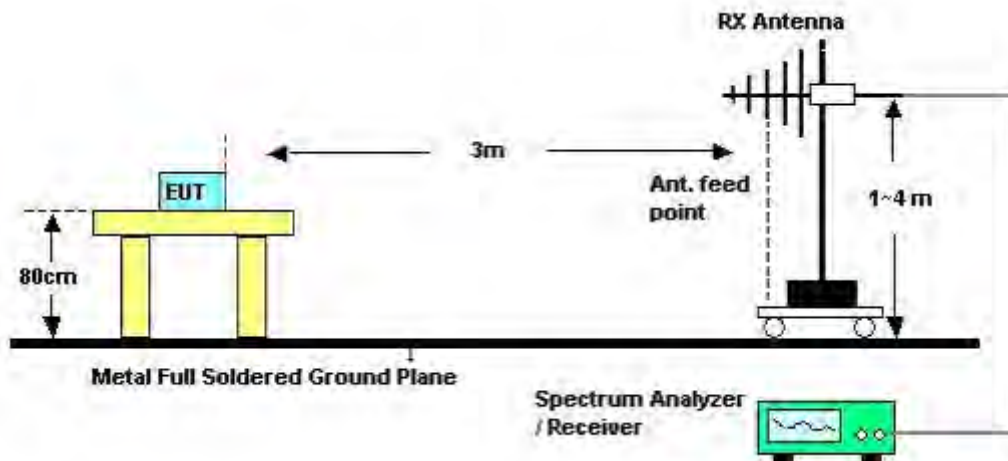

4.6.5. Test Deviation

There is no deviation with the original standard.

4.6.6. EUT Operation during Test

The EUT was programmed to be in continuously transmitting mode.

4.6.7. Results of Radiated Emissions (9kHz~30MHz)

| | | | |
|---------------|--------------|----------------|-------------|
| Temperature | 24°C | Humidity | 48% |
| Test Engineer | Serway Li | Configurations | Normal Link |
| Test Date | May 17, 2013 | | |

| Freq. (MHz) | Level (dBuV) | Over Limit (dB) | Limit Line (dBuV) | Remark |
|-------------|--------------|-----------------|-------------------|----------|
| - | - | - | - | See Note |

Note:

The amplitude of spurious emissions that are attenuated by more than 20dB below the permissible value has no need to be reported.

Distance extrapolation factor = $40 \log(\text{specific distance} / \text{test distance})$ (dB);

Limit line = specific limits (dBuV) + distance extrapolation factor.

4.6.8. Results of Radiated Emissions (30MHz~1GHz)

| | | | |
|---------------|-----------|----------------|-------------|
| Temperature | 24°C | Humidity | 48% |
| Test Engineer | Serway Li | Configurations | Normal Link |

Horizontal

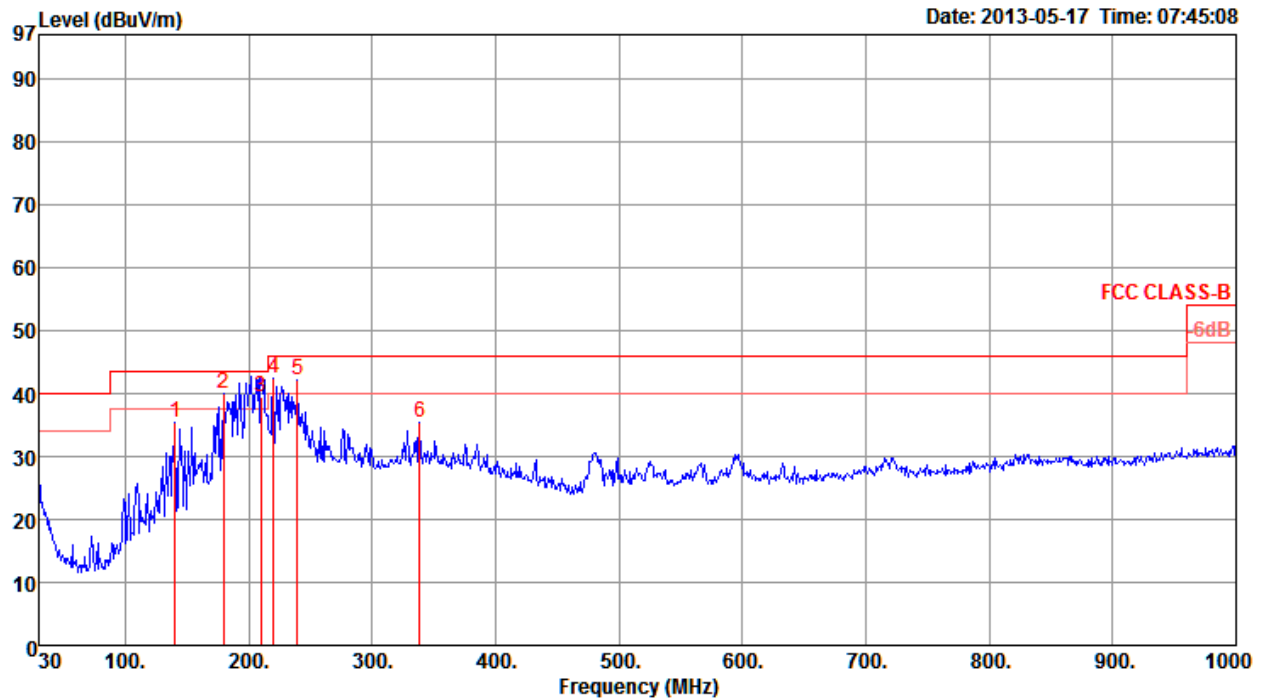

| | Freq | Level | Limit | Over | Read | Cable | Preamp | Antenna | Remark | T/Pos | A/Pos | Pol/Phase |
|---|--------|--------|--------|--------|-------|-------|--------|---------|--------|-------|-------|------------|
| | MHz | dBuV/m | dBuV/m | dB | dBuV | dB | dB | dB/m | | deg | cm | |
| 1 | 140.58 | 35.33 | 43.50 | -8.17 | 49.14 | 1.72 | 27.55 | 12.02 | Peak | 0 | 100 | HORIZONTAL |
| 2 | 179.38 | 40.08 | 43.50 | -3.42 | 55.53 | 2.00 | 27.39 | 9.94 | Peak | 0 | 100 | HORIZONTAL |
| 3 | 210.00 | 39.56 | 43.50 | -3.94 | 53.95 | 2.18 | 27.17 | 10.60 | QP | 135 | 100 | HORIZONTAL |
| 4 | 220.12 | 42.52 | 46.00 | -3.48 | 56.77 | 2.26 | 27.11 | 10.60 | Peak | 0 | 100 | HORIZONTAL |
| 5 | 239.52 | 42.15 | 46.00 | -3.85 | 54.72 | 2.31 | 26.98 | 12.10 | Peak | 0 | 100 | HORIZONTAL |
| 6 | 338.46 | 35.27 | 46.00 | -10.73 | 44.59 | 2.73 | 27.00 | 14.95 | Peak | 0 | 100 | HORIZONTAL |

Vertical

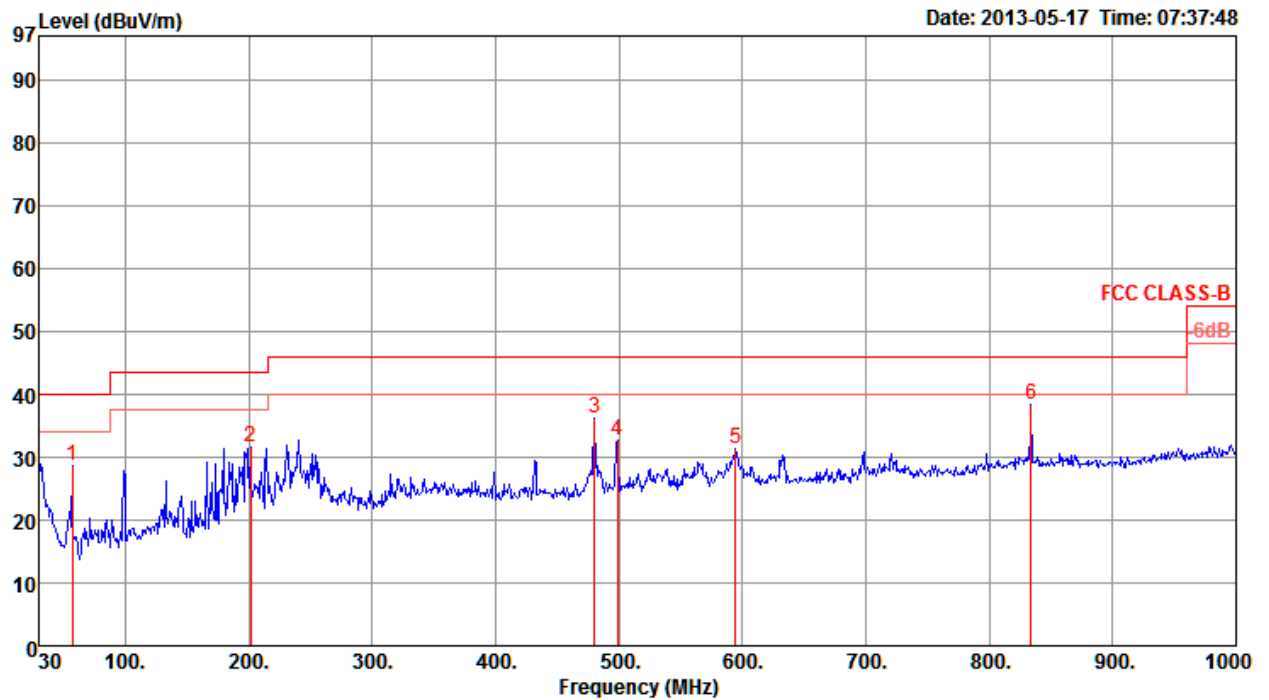

| | Freq | Level | Limit | Over | Read | Cable | Preamp | Antenna | Remark | T/Pos | A/Pos | Pol/Phase |
|-----|--------|--------|--------|--------|-------|-------|--------|---------|--------|-------|-------|-----------|
| | MHz | dBuV/m | dBuV/m | dB | dBuV | dB | dB | dB/m | | deg | cm | |
| 1 | 57.16 | 28.52 | 40.00 | -11.48 | 47.86 | 1.15 | 27.93 | 7.44 | Peak | 0 | 400 | VERTICAL |
| 2 | 201.69 | 31.71 | 43.50 | -11.79 | 46.40 | 2.11 | 27.24 | 10.44 | Peak | 0 | 400 | VERTICAL |
| 3 | 480.08 | 36.19 | 46.00 | -9.81 | 43.28 | 3.33 | 27.90 | 17.48 | Peak | 0 | 400 | VERTICAL |
| 4 | 498.51 | 32.60 | 46.00 | -13.40 | 39.38 | 3.38 | 27.93 | 17.77 | Peak | 0 | 400 | VERTICAL |
| 5 | 594.54 | 31.44 | 46.00 | -14.56 | 36.12 | 3.71 | 27.63 | 19.24 | Peak | 0 | 400 | VERTICAL |
| 6 p | 834.13 | 38.27 | 46.00 | -7.73 | 39.69 | 4.41 | 26.90 | 21.07 | Peak | 0 | 400 | VERTICAL |

Note:

The amplitude of spurious emissions that are attenuated by more than 20dB below the permissible value has no need to be reported.

Emission level (dBuV/m) = 20 log Emission level (uV/m).

Corrected Reading: Antenna Factor + Cable Loss + Read Level - Preamp Factor = Level.

4.6.9. Results for Radiated Emissions (1GHz~40GHz)

| | | | |
|---------------|--------------|----------------|---|
| Temperature | 23°C | Humidity | 63% |
| Test Engineer | Benson Peng | Configurations | IEEE 802.11n MCS0 20MHz Ch 36 / Chain 1 + Chain 2 |
| Test Date | May 13, 2013 | | |

Horizontal

| | Freq | Level | Limit Line | Over Limit | Read Level | Cable Loss | Preamp Factor | Antenna Factor | Remark | T/Pos | A/Pos | Pol/Phase |
|-----|----------|--------|------------|------------|------------|------------|---------------|----------------|---------|-------|-------|------------|
| | MHz | dBuV/m | dBuV/m | dB | dBuV | dB | dB | dB/m | | deg | cm | |
| 1 p | 10360.36 | 61.90 | 68.30 | -6.40 | 52.26 | 6.53 | 35.31 | 38.42 | Peak | 40 | 100 | HORIZONTAL |
| 2 | 15549.84 | 55.15 | 74.00 | -18.85 | 43.61 | 7.86 | 34.81 | 38.49 | Peak | 151 | 100 | HORIZONTAL |
| 3 a | 15549.96 | 42.80 | 54.00 | -11.20 | 31.26 | 7.86 | 34.81 | 38.49 | Average | 151 | 100 | HORIZONTAL |

Vertical

| | Freq | Level | Limit Line | Over Limit | Read Level | Cable Loss | Preamp Factor | Antenna Factor | Remark | T/Pos | A/Pos | Pol/Phase |
|-----|----------|--------|------------|------------|------------|------------|---------------|----------------|---------|-------|-------|-----------|
| | MHz | dBuV/m | dBuV/m | dB | dBuV | dB | dB | dB/m | | deg | cm | |
| 1 p | 10360.48 | 67.88 | 68.30 | -0.42 | 58.24 | 6.53 | 35.31 | 38.42 | Peak | 24 | 102 | VERTICAL |
| 2 | 15540.42 | 55.40 | 74.00 | -18.60 | 43.85 | 7.85 | 34.79 | 38.49 | Peak | 218 | 100 | VERTICAL |
| 3 a | 15544.26 | 43.41 | 54.00 | -10.59 | 31.85 | 7.86 | 34.79 | 38.49 | Average | 218 | 100 | VERTICAL |



| | | | |
|---------------|--------------|----------------|--|
| Temperature | 25.6°C | Humidity | 56% |
| Test Engineer | Jim Huang | Configurations | IEEE 802.11n MCS0 20MHz Ch 40 / Chain 1 + Chain 2 |
| Test Date | May 10, 2013 | | |

Horizontal

| | Freq | Level | Limit | Over | Read | Cable | Antenna | Preamp | Remark | A/Pos | T/Pos | Pol/Phase |
|---|----------|--------|--------|--------|-------|-------|---------|--------|---------|-------|-------|------------|
| | MHz | dBuV/m | dBuV/m | dB | dBuV | dB | dB/m | dB | | cm | deg | |
| 1 | 10396.70 | 58.27 | 68.30 | -10.03 | 50.49 | 4.98 | 38.38 | 35.58 | Peak | 100 | 308 | HORIZONTAL |
| 2 | 15603.20 | 57.89 | 74.00 | -16.11 | 49.50 | 6.13 | 37.60 | 35.34 | Peak | 100 | 334 | HORIZONTAL |
| 3 | 15603.50 | 46.56 | 54.00 | -7.44 | 38.17 | 6.13 | 37.60 | 35.34 | Average | 100 | 334 | HORIZONTAL |

Vertical

| | Freq | Level | Limit | Over | Read | Cable | Antenna | Preamp | Remark | A/Pos | T/Pos | Pol/Phase |
|---|----------|--------|--------|--------|-------|-------|---------|--------|---------|-------|-------|-----------|
| | MHz | dBuV/m | dBuV/m | dB | dBuV | dB | dB/m | dB | | cm | deg | |
| 1 | 10397.00 | 68.27 | 68.30 | -0.03 | 60.49 | 4.98 | 38.38 | 35.58 | Peak | 132 | 338 | VERTICAL |
| 2 | 15603.70 | 45.29 | 54.00 | -8.71 | 36.90 | 6.13 | 37.60 | 35.34 | Average | 101 | 339 | VERTICAL |
| 3 | 15611.80 | 56.14 | 74.00 | -17.86 | 47.77 | 6.13 | 37.58 | 35.34 | Peak | 101 | 339 | VERTICAL |



| | | | |
|---------------|--------------|----------------|--|
| Temperature | 25.6°C | Humidity | 56% |
| Test Engineer | Jim Huang | Configurations | IEEE 802.11n MCS0 20MHz Ch 48 / Chain 1 + Chain 2 |
| Test Date | May 10, 2013 | | |

Horizontal

| | Freq | Level | Limit Line | Over Limit | Read Level | CableAntenna Loss | Antenna Factor | Preamp Factor | Remark | A/Pos | T/Pos | Pol/Phase |
|---|----------|--------|------------|------------|------------|-------------------|----------------|---------------|---------|-------|-------|------------|
| | MHz | dBuV/m | dBuV/m | dB | dBuV | dB | dB/m | dB | | cm | deg | |
| 1 | 10480.60 | 60.21 | 68.30 | -8.09 | 52.34 | 5.00 | 38.39 | 35.52 | Peak | 100 | 358 | HORIZONTAL |
| 2 | 15716.50 | 48.19 | 54.00 | -5.81 | 39.96 | 6.14 | 37.48 | 35.39 | Average | 100 | 336 | HORIZONTAL |
| 3 | 15718.70 | 59.31 | 74.00 | -14.69 | 51.08 | 6.14 | 37.48 | 35.39 | Peak | 100 | 336 | HORIZONTAL |

Vertical

| | Freq | Level | Limit Line | Over Limit | Read Level | CableAntenna Loss | Antenna Factor | Preamp Factor | Remark | A/Pos | T/Pos | Pol/Phase |
|---|----------|--------|------------|------------|------------|-------------------|----------------|---------------|---------|-------|-------|-----------|
| | MHz | dBuV/m | dBuV/m | dB | dBuV | dB | dB/m | dB | | cm | deg | |
| 1 | 10472.80 | 68.06 | 68.30 | -0.24 | 60.19 | 5.00 | 38.39 | 35.52 | Peak | 130 | 345 | VERTICAL |
| 2 | 15717.60 | 60.28 | 74.00 | -13.72 | 52.05 | 6.14 | 37.48 | 35.39 | Peak | 149 | 352 | VERTICAL |
| 3 | 15719.20 | 48.16 | 54.00 | -5.84 | 39.93 | 6.14 | 37.48 | 35.39 | Average | 149 | 352 | VERTICAL |

| | | | |
|---------------|--------------|----------------|--|
| Temperature | 23°C | Humidity | 63% |
| Test Engineer | Benson Peng | Configurations | IEEE 802.11n MCS0 20MHz Ch 52 / Chain 1 + Chain 2 |
| Test Date | May 13, 2013 | | |

Horizontal

| | Freq | Level | Limit Line | Over Limit | Read Level | Cable Loss | Preamp Factor | Antenna Factor | Remark | T/Pos | A/Pos | Pol/Phase |
|-----|----------|--------|------------|------------|------------|------------|---------------|----------------|---------|-------|-------|------------|
| | MHz | dBuV/m | dBuV/m | dB | dBuV | dB | dB | dB/m | | deg | cm | |
| 1 p | 10527.60 | 61.68 | 68.30 | -6.62 | 51.71 | 6.63 | 35.16 | 38.50 | Peak | 40 | 100 | HORIZONTAL |
| 2 a | 15779.30 | 55.72 | 74.00 | -18.28 | 44.36 | 7.93 | 35.01 | 38.44 | Peak | 217 | 100 | HORIZONTAL |
| 3 a | 15780.40 | 44.05 | 54.00 | -9.95 | 32.69 | 7.93 | 35.01 | 38.44 | Average | 217 | 100 | HORIZONTAL |

Vertical

| | Freq | Level | Limit Line | Over Limit | Read Level | Cable Loss | Preamp Factor | Antenna Factor | Remark | T/Pos | A/Pos | Pol/Phase |
|-----|----------|--------|------------|------------|------------|------------|---------------|----------------|---------|-------|-------|-----------|
| | MHz | dBuV/m | dBuV/m | dB | dBuV | dB | dB | dB/m | | deg | cm | |
| 1 p | 10526.88 | 68.07 | 68.30 | -0.23 | 58.10 | 6.63 | 35.16 | 38.50 | Peak | 22 | 100 | VERTICAL |
| 2 a | 15782.50 | 46.85 | 54.00 | -7.15 | 35.48 | 7.94 | 35.01 | 38.44 | Average | 24 | 100 | VERTICAL |
| 3 | 15787.20 | 58.44 | 74.00 | -15.56 | 47.07 | 7.94 | 35.01 | 38.44 | Peak | 24 | 100 | VERTICAL |

| | | | |
|---------------|--------------|----------------|--|
| Temperature | 23°C | Humidity | 63% |
| Test Engineer | Benson Peng | Configurations | IEEE 802.11n MCS0 20MHz Ch 60 / Chain 1 + Chain 2 |
| Test Date | May 13, 2013 | | |

Horizontal

| | Freq | Level | Limit | Over | Read | Cable | Preamp | Antenna | Remark | T/Pos | A/Pos | Pol/Phase |
|-----|----------|--------|--------|-------|-------|-------|--------|---------|---------|-------|-------|------------|
| | MHz | dBuV/m | dBuV/m | dB | dBuV | dB | dB | dB/m | | deg | cm | |
| 1 a | 10606.60 | 48.98 | 54.00 | -5.02 | 39.00 | 6.60 | 35.10 | 38.48 | Average | 40 | 100 | HORIZONTAL |
| 2 p | 10606.90 | 64.01 | 74.00 | -9.99 | 54.03 | 6.60 | 35.10 | 38.48 | Peak | 40 | 100 | HORIZONTAL |

Vertical

| | Freq | Level | Limit | Over | Read | Cable | Preamp | Antenna | Remark | T/Pos | A/Pos | Pol/Phase |
|-----|----------|--------|--------|-------|-------|-------|--------|---------|---------|-------|-------|-----------|
| | MHz | dBuV/m | dBuV/m | dB | dBuV | dB | dB | dB/m | | deg | cm | |
| 1 p | 10605.34 | 68.76 | 74.00 | -5.24 | 58.78 | 6.60 | 35.10 | 38.48 | Peak | 2 | 100 | VERTICAL |
| 2 a | 10606.48 | 53.85 | 54.00 | -0.15 | 43.87 | 6.60 | 35.10 | 38.48 | Average | 2 | 100 | VERTICAL |

| | | | |
|---------------|--------------|----------------|--|
| Temperature | 23°C | Humidity | 63% |
| Test Engineer | Benson Peng | Configurations | IEEE 802.11n MCS0 20MHz Ch 64 / Chain 1 + Chain 2 |
| Test Date | May 13, 2013 | | |

Horizontal

| | Freq | Level | Limit | Over | Read | Cable | Preamp | Antenna | Remark | T/Pos | A/Pos | Pol/Phase |
|-----|----------|--------|--------|--------|-------|-------|--------|---------|---------|-------|-------|------------|
| | MHz | dBuV/m | dBuV/m | dB | dBuV | dB | dB | dB/m | | deg | cm | |
| 1 a | 10644.56 | 45.02 | 54.00 | -8.98 | 35.04 | 6.59 | 35.08 | 38.47 | Average | 39 | 100 | HORIZONTAL |
| 2 p | 10644.98 | 59.12 | 74.00 | -14.88 | 49.14 | 6.59 | 35.08 | 38.47 | Peak | 39 | 100 | HORIZONTAL |

Vertical

| | Freq | Level | Limit | Over | Read | Cable | Preamp | Antenna | Remark | T/Pos | A/Pos | Pol/Phase |
|-----|----------|--------|--------|--------|-------|-------|--------|---------|---------|-------|-------|-----------|
| | MHz | dBuV/m | dBuV/m | dB | dBuV | dB | dB | dB/m | | deg | cm | |
| 1 p | 10645.46 | 63.67 | 74.00 | -10.33 | 53.69 | 6.59 | 35.08 | 38.47 | Peak | 358 | 100 | VERTICAL |
| 2 a | 10646.84 | 48.45 | 54.00 | -5.55 | 38.47 | 6.59 | 35.08 | 38.47 | Average | 358 | 100 | VERTICAL |

| | | | |
|---------------|--------------|----------------|---|
| Temperature | 23°C | Humidity | 63% |
| Test Engineer | Benson Peng | Configurations | IEEE 802.11n MCS0 20MHz Ch 100 / Chain 1 + Chain 2 |
| Test Date | May 13, 2013 | | |

Horizontal

| | Freq | Level | Limit | Over | Read | Cable | Preamp | Antenna | Remark | T/Pos | A/Pos | Pol/Phase |
|-----|----------|--------|--------|--------|-------|-------|--------|---------|---------|-------|-------|------------|
| | MHz | dBuV/m | dBuV/m | dB | dBuV | dB | dB | dB/m | | deg | cm | |
| 1 a | 11000.80 | 40.74 | 54.00 | -13.26 | 30.69 | 6.46 | 34.81 | 38.40 | Average | 66 | 100 | HORIZONTAL |
| 2 p | 11001.36 | 53.64 | 74.00 | -20.36 | 43.59 | 6.46 | 34.81 | 38.40 | Peak | 66 | 100 | HORIZONTAL |

Vertical

| | Freq | Level | Limit | Over | Read | Cable | Preamp | Antenna | Remark | T/Pos | A/Pos | Pol/Phase |
|-----|----------|--------|--------|--------|-------|-------|--------|---------|---------|-------|-------|-----------|
| | MHz | dBuV/m | dBuV/m | dB | dBuV | dB | dB | dB/m | | deg | cm | |
| 1 a | 10999.20 | 43.65 | 54.00 | -10.35 | 33.60 | 6.46 | 34.81 | 38.40 | Average | 23 | 101 | VERTICAL |
| 2 p | 11000.52 | 59.46 | 74.00 | -14.54 | 49.41 | 6.46 | 34.81 | 38.40 | Peak | 23 | 101 | VERTICAL |

| | | | |
|---------------|--------------|----------------|---|
| Temperature | 23°C | Humidity | 63% |
| Test Engineer | Benson Peng | Configurations | IEEE 802.11n MCS0 20MHz Ch 116 / Chain 1 + Chain 2 |
| Test Date | May 13, 2013 | | |

Horizontal

| | Freq | Level | Limit | Over | Read | Cable | Preamp | Antenna | Remark | T/Pos | A/Pos | Pol/Phase |
|-----|----------|--------|--------|--------|-------|-------|--------|---------|---------|-------|-------|------------|
| | MHz | dBuV/m | dBuV/m | dB | dBuV | dB | dB | dB/m | | deg | cm | |
| 1 a | 11159.40 | 46.98 | 54.00 | -7.02 | 36.80 | 6.56 | 34.81 | 38.43 | Average | 181 | 100 | HORIZONTAL |
| 2 p | 11160.52 | 62.94 | 74.00 | -11.06 | 52.76 | 6.56 | 34.81 | 38.43 | Peak | 181 | 100 | HORIZONTAL |

Vertical

| | Freq | Level | Limit | Over | Read | Cable | Preamp | Antenna | Remark | T/Pos | A/Pos | Pol/Phase |
|-----|----------|--------|--------|-------|-------|-------|--------|---------|---------|-------|-------|-----------|
| | MHz | dBuV/m | dBuV/m | dB | dBuV | dB | dB | dB/m | | deg | cm | |
| 1 p | 11165.44 | 68.94 | 74.00 | -5.06 | 58.76 | 6.56 | 34.81 | 38.43 | Peak | 25 | 100 | VERTICAL |
| 2 a | 11165.88 | 53.49 | 54.00 | -0.51 | 43.31 | 6.56 | 34.81 | 38.43 | Average | 25 | 100 | VERTICAL |

| | | | |
|---------------|--------------|----------------|---|
| Temperature | 23°C | Humidity | 63% |
| Test Engineer | Benson Peng | Configurations | IEEE 802.11n MCS0 20MHz Ch 140 / Chain 1 + Chain 2 |
| Test Date | May 13, 2013 | | |

Horizontal

| | Freq | Level | Limit | Over | Read | Cable | Preamp | Antenna | Remark | T/Pos | A/Pos | Pol/Phase |
|-----|----------|--------|--------|--------|-------|-------|--------|---------|---------|-------|-------|------------|
| | MHz | dBuV/m | dBuV/m | dB | dBuV | dB | dB | dB/m | | deg | cm | |
| 1 a | 11398.44 | 42.80 | 54.00 | -11.20 | 32.45 | 6.69 | 34.82 | 38.48 | Average | 236 | 106 | HORIZONTAL |
| 2 p | 11400.56 | 57.11 | 74.00 | -16.89 | 46.76 | 6.69 | 34.82 | 38.48 | Peak | 236 | 106 | HORIZONTAL |

Vertical

| | Freq | Level | Limit | Over | Read | Cable | Preamp | Antenna | Remark | T/Pos | A/Pos | Pol/Phase |
|-----|----------|--------|--------|--------|-------|-------|--------|---------|---------|-------|-------|-----------|
| | MHz | dBuV/m | dBuV/m | dB | dBuV | dB | dB | dB/m | | deg | cm | |
| 1 a | 11398.92 | 44.83 | 54.00 | -9.17 | 34.48 | 6.69 | 34.82 | 38.48 | Average | 223 | 100 | VERTICAL |
| 2 p | 11400.56 | 59.17 | 74.00 | -14.83 | 48.82 | 6.69 | 34.82 | 38.48 | Peak | 223 | 100 | VERTICAL |

| | | | |
|---------------|--------------|----------------|--|
| Temperature | 23°C | Humidity | 63% |
| Test Engineer | Benson Peng | Configurations | IEEE 802.11n MCS0 40MHz Ch 38 / Chain 1 + Chain 2 |
| Test Date | May 13, 2013 | | |

Horizontal

| | Freq | Level | Limit | Over | Read | Cable | Preamp | Antenna | Remark | T/Pos | A/Pos | Pol/Phase |
|-----|----------|--------|--------|--------|-------|-------|--------|---------|---------|-------|-------|------------|
| | MHz | dBuV/m | dBuV/m | dB | dBuV | dB | dB | dB/m | | deg | cm | |
| 1 p | 10382.56 | 53.81 | 68.30 | -14.49 | 44.12 | 6.54 | 35.28 | 38.43 | Peak | 39 | 100 | HORIZONTAL |
| 2 | 15565.28 | 55.60 | 74.00 | -18.40 | 44.06 | 7.86 | 34.81 | 38.49 | Peak | 302 | 100 | HORIZONTAL |
| 3 a | 15565.56 | 42.31 | 54.00 | -11.69 | 30.77 | 7.86 | 34.81 | 38.49 | Average | 302 | 100 | HORIZONTAL |

Vertical

| | Freq | Level | Limit | Over | Read | Cable | Preamp | Antenna | Remark | T/Pos | A/Pos | Pol/Phase |
|-----|----------|--------|--------|--------|-------|-------|--------|---------|---------|-------|-------|-----------|
| | MHz | dBuV/m | dBuV/m | dB | dBuV | dB | dB | dB/m | | deg | cm | |
| 1 p | 10378.72 | 55.43 | 68.30 | -12.87 | 45.74 | 6.54 | 35.28 | 38.43 | Peak | 6 | 100 | VERTICAL |
| 2 | 15566.60 | 55.12 | 74.00 | -18.88 | 43.58 | 7.86 | 34.81 | 38.49 | Peak | 133 | 100 | VERTICAL |
| 3 a | 15568.32 | 42.37 | 54.00 | -11.63 | 30.83 | 7.86 | 34.81 | 38.49 | Average | 133 | 100 | VERTICAL |

| | | | |
|---------------|--------------|----------------|--|
| Temperature | 23°C | Humidity | 63% |
| Test Engineer | Benson Peng | Configurations | IEEE 802.11n MCS0 40MHz Ch 46 / Chain 1 + Chain 2 |
| Test Date | May 13, 2013 | | |

Horizontal

| | Freq | Level | Limit Line | Over Limit | Read Level | Cable Loss | Preamp Factor | Antenna Factor | Remark | T/Pos | A/Pos | Pol/Phase |
|-----|----------|--------|------------|------------|------------|------------|---------------|----------------|---------|-------|-------|------------|
| | MHz | dBuV/m | dBuV/m | dB | dBuV | dB | dB | dB/m | | deg | cm | |
| 1 p | 10467.60 | 59.60 | 68.30 | -8.70 | 49.73 | 6.61 | 35.22 | 38.48 | Peak | 39 | 100 | HORIZONTAL |
| 2 | 15686.32 | 54.62 | 74.00 | -19.38 | 43.18 | 7.90 | 34.92 | 38.46 | Peak | 130 | 100 | HORIZONTAL |
| 3 a | 15692.04 | 43.52 | 54.00 | -10.48 | 32.08 | 7.90 | 34.92 | 38.46 | Average | 130 | 100 | HORIZONTAL |

Vertical

| | Freq | Level | Limit Line | Over Limit | Read Level | Cable Loss | Preamp Factor | Antenna Factor | Remark | T/Pos | A/Pos | Pol/Phase |
|-----|----------|--------|------------|------------|------------|------------|---------------|----------------|---------|-------|-------|-----------|
| | MHz | dBuV/m | dBuV/m | dB | dBuV | dB | dB | dB/m | | deg | cm | |
| 1 p | 10452.14 | 65.79 | 68.30 | -2.51 | 55.94 | 6.60 | 35.22 | 38.47 | Peak | 6 | 100 | VERTICAL |
| 2 | 15694.56 | 56.01 | 74.00 | -17.99 | 44.57 | 7.90 | 34.92 | 38.46 | Peak | 217 | 100 | VERTICAL |
| 3 a | 15697.32 | 45.00 | 54.00 | -9.00 | 33.55 | 7.91 | 34.92 | 38.46 | Average | 217 | 100 | VERTICAL |

| | | | |
|---------------|--------------|----------------|--|
| Temperature | 23°C | Humidity | 63% |
| Test Engineer | Benson Peng | Configurations | IEEE 802.11n MCS0 40MHz Ch 54 / Chain 1 + Chain 2 |
| Test Date | May 13, 2013 | | |

Horizontal

| | Freq | Level | Limit | Over | Read | Cable | Preamp | Antenna | Remark | T/Pos | A/Pos | Pol/Phase |
|-----|----------|--------|--------|--------|-------|-------|--------|---------|---------|-------|-------|------------|
| | MHz | dBuV/m | dBuV/m | dB | dBuV | dB | dB | dB/m | | deg | cm | |
| 1 p | 10547.60 | 59.86 | 68.30 | -8.44 | 49.91 | 6.62 | 35.16 | 38.49 | Peak | 38 | 100 | HORIZONTAL |
| 2 | 15787.90 | 54.98 | 74.00 | -19.02 | 43.61 | 7.94 | 35.01 | 38.44 | Peak | 200 | 100 | HORIZONTAL |
| 3 a | 15812.20 | 43.84 | 54.00 | -10.16 | 32.48 | 7.95 | 35.03 | 38.44 | Average | 200 | 100 | HORIZONTAL |

Vertical

| | Freq | Level | Limit | Over | Read | Cable | Preamp | Antenna | Remark | T/Pos | A/Pos | Pol/Phase |
|-----|----------|--------|--------|--------|-------|-------|--------|---------|---------|-------|-------|-----------|
| | MHz | dBuV/m | dBuV/m | dB | dBuV | dB | dB | dB/m | | deg | cm | |
| 1 p | 10549.80 | 65.24 | 68.30 | -3.06 | 55.27 | 6.62 | 35.14 | 38.49 | Peak | 21 | 100 | VERTICAL |
| 2 | 15807.20 | 57.94 | 74.00 | -16.06 | 46.58 | 7.95 | 35.03 | 38.44 | Peak | 225 | 100 | VERTICAL |
| 3 a | 15808.10 | 46.19 | 54.00 | -7.81 | 34.83 | 7.95 | 35.03 | 38.44 | Average | 225 | 100 | VERTICAL |

| | | | |
|---------------|--------------|----------------|--|
| Temperature | 23°C | Humidity | 63% |
| Test Engineer | Benson Peng | Configurations | IEEE 802.11n MCS0 40MHz Ch 62 / Chain 1 + Chain 2 |
| Test Date | May 13, 2013 | | |

Horizontal

| | Freq | Level | Limit | Over | Read | Cable | Preamp | Antenna | Remark | T/Pos | A/Pos | Pol/Phase |
|-----|----------|--------|--------|--------|-------|-------|--------|---------|---------|-------|-------|------------|
| | MHz | dBuV/m | dBuV/m | dB | dBuV | dB | dB | dB/m | | deg | cm | |
| 1 p | 10615.56 | 51.11 | 74.00 | -22.89 | 41.13 | 6.60 | 35.10 | 38.48 | Peak | 211 | 100 | HORIZONTAL |
| 2 a | 10616.88 | 38.82 | 54.00 | -15.18 | 28.84 | 6.60 | 35.10 | 38.48 | Average | 211 | 100 | HORIZONTAL |

Vertical

| | Freq | Level | Limit | Over | Read | Cable | Preamp | Antenna | Remark | T/Pos | A/Pos | Pol/Phase |
|-----|----------|--------|--------|--------|-------|-------|--------|---------|---------|-------|-------|-----------|
| | MHz | dBuV/m | dBuV/m | dB | dBuV | dB | dB | dB/m | | deg | cm | |
| 1 a | 10617.20 | 39.28 | 54.00 | -14.72 | 29.30 | 6.60 | 35.10 | 38.48 | Average | 241 | 100 | VERTICAL |
| 2 p | 10620.78 | 51.54 | 74.00 | -22.46 | 41.56 | 6.60 | 35.10 | 38.48 | Peak | 241 | 100 | VERTICAL |

| | | | |
|---------------|--------------|----------------|---|
| Temperature | 23°C | Humidity | 63% |
| Test Engineer | Benson Peng | Configurations | IEEE 802.11n MCS0 40MHz Ch 102 / Chain 1 + Chain 2 |
| Test Date | May 13, 2013 | | |

Horizontal

| | Freq | Level | Limit | Over | Read | Cable | Preamp | Antenna | Remark | T/Pos | A/Pos | Pol/Phase |
|-----|----------|--------|--------|--------|-------|-------|--------|---------|---------|-------|-------|------------|
| | MHz | dBuV/m | dBuV/m | dB | dBuV | dB | dB | dB/m | | deg | cm | |
| 1 a | 11018.96 | 36.69 | 54.00 | -17.31 | 26.63 | 6.47 | 34.81 | 38.40 | Average | 226 | 110 | HORIZONTAL |
| 2 p | 11019.32 | 48.81 | 74.00 | -25.19 | 38.75 | 6.47 | 34.81 | 38.40 | Peak | 226 | 110 | HORIZONTAL |

Vertical

| | Freq | Level | Limit | Over | Read | Cable | Preamp | Antenna | Remark | T/Pos | A/Pos | Pol/Phase |
|-----|----------|--------|--------|--------|-------|-------|--------|---------|---------|-------|-------|-----------|
| | MHz | dBuV/m | dBuV/m | dB | dBuV | dB | dB | dB/m | | deg | cm | |
| 1 p | 11015.04 | 49.87 | 74.00 | -24.13 | 39.81 | 6.47 | 34.81 | 38.40 | Peak | 214 | 100 | VERTICAL |
| 2 a | 11015.74 | 37.04 | 54.00 | -16.96 | 26.98 | 6.47 | 34.81 | 38.40 | Average | 214 | 100 | VERTICAL |

| | | | |
|---------------|--------------|----------------|---|
| Temperature | 23°C | Humidity | 63% |
| Test Engineer | Benson Peng | Configurations | IEEE 802.11n MCS0 40MHz Ch 110 / Chain 1 + Chain 2 |
| Test Date | May 13, 2013 | | |

Horizontal

| | Freq | Level | Limit | Over | Read | Cable | Preamp | Antenna | Remark | T/Pos | A/Pos | Pol/Phase |
|-----|----------|--------|--------|--------|-------|-------|--------|---------|---------|-------|-------|------------|
| | MHz | dBuV/m | dBuV/m | dB | dBuV | dB | dB | dB/m | | deg | cm | |
| 1 a | 11094.10 | 45.99 | 54.00 | -8.01 | 35.86 | 6.52 | 34.81 | 38.42 | Average | 220 | 108 | HORIZONTAL |
| 2 p | 11094.20 | 57.89 | 74.00 | -16.11 | 47.76 | 6.52 | 34.81 | 38.42 | Peak | 220 | 108 | HORIZONTAL |

Vertical

| | Freq | Level | Limit | Over | Read | Cable | Preamp | Antenna | Remark | T/Pos | A/Pos | Pol/Phase |
|-----|----------|--------|--------|--------|-------|-------|--------|---------|---------|-------|-------|-----------|
| | MHz | dBuV/m | dBuV/m | dB | dBuV | dB | dB | dB/m | | deg | cm | |
| 1 p | 11106.60 | 61.69 | 74.00 | -12.31 | 51.55 | 6.53 | 34.81 | 38.42 | Peak | 249 | 100 | VERTICAL |
| 2 a | 11108.40 | 49.21 | 54.00 | -4.79 | 39.07 | 6.53 | 34.81 | 38.42 | Average | 249 | 100 | VERTICAL |

| | | | |
|----------------------|--------------|-----------------------|---|
| Temperature | 23°C | Humidity | 63% |
| Test Engineer | Benson Peng | Configurations | IEEE 802.11n MCS0 40MHz Ch 134 / Chain 1 + Chain 2 |
| Test Date | May 13, 2013 | | |

Horizontal

| | Freq | Level | Limit | Over | Read | Cable | Preamp | Antenna | Remark | T/Pos | A/Pos | Pol/Phase |
|-----|----------|--------|--------|--------|-------|-------|--------|---------|---------|-------|-------|------------|
| | MHz | dBuV/m | dBuV/m | dB | dBuV | dB | dB | dB/m | | deg | cm | |
| 1 p | 11331.00 | 56.86 | 74.00 | -17.14 | 46.56 | 6.65 | 34.82 | 38.47 | Peak | 221 | 140 | HORIZONTAL |
| 2 a | 11334.10 | 44.67 | 54.00 | -9.33 | 34.37 | 6.65 | 34.82 | 38.47 | Average | 221 | 140 | HORIZONTAL |

Vertical

| | Freq | Level | Limit | Over | Read | Cable | Preamp | Antenna | Remark | T/Pos | A/Pos | Pol/Phase |
|-----|----------|--------|--------|--------|-------|-------|--------|---------|---------|-------|-------|-----------|
| | MHz | dBuV/m | dBuV/m | dB | dBuV | dB | dB | dB/m | | deg | cm | |
| 1 a | 11334.10 | 46.98 | 54.00 | -7.02 | 36.68 | 6.65 | 34.82 | 38.47 | Average | 352 | 100 | VERTICAL |
| 2 p | 11338.50 | 59.03 | 74.00 | -14.97 | 48.73 | 6.65 | 34.82 | 38.47 | Peak | 352 | 100 | VERTICAL |

Note:

The amplitude of spurious emissions that are attenuated by more than 20dB below the permissible value has no need to be reported.

Emission level (dBuV/m) = 20 log Emission level (uV/m).

Corrected Reading: Antenna Factor + Cable Loss + Read Level - Preamp Factor = Level.

| | | | |
|---------------|--------------|----------------|---|
| Temperature | 23°C | Humidity | 63% |
| Test Engineer | Benson Peng | Configurations | IEEE 802.11a Ch 36 / Chain 1 + Chain 2 |
| Test Date | May 13, 2013 | | |

Horizontal

| | Freq | Level | Limit Line | Over Limit | Read Level | Cable Loss | Preamp Factor | Antenna Factor | Remark | T/Pos | A/Pos | Pol/Phase |
|-----|----------|--------|------------|------------|------------|------------|---------------|----------------|---------|-------|-------|------------|
| | MHz | dBuV/m | dBuV/m | dB | dBuV | dB | dB | dB/m | | deg | cm | |
| 1 p | 10359.96 | 58.93 | 68.30 | -9.37 | 49.29 | 6.53 | 35.31 | 38.42 | Peak | 39 | 100 | HORIZONTAL |
| 2 | 15536.96 | 55.05 | 74.00 | -18.95 | 43.50 | 7.85 | 34.79 | 38.49 | Peak | 118 | 100 | HORIZONTAL |
| 3 a | 15539.84 | 42.69 | 54.00 | -11.31 | 31.14 | 7.85 | 34.79 | 38.49 | Average | 118 | 100 | HORIZONTAL |

Vertical

| | Freq | Level | Limit Line | Over Limit | Read Level | Cable Loss | Preamp Factor | Antenna Factor | Remark | T/Pos | A/Pos | Pol/Phase |
|-----|----------|--------|------------|------------|------------|------------|---------------|----------------|---------|-------|-------|-----------|
| | MHz | dBuV/m | dBuV/m | dB | dBuV | dB | dB | dB/m | | deg | cm | |
| 1 p | 10359.16 | 66.11 | 68.30 | -2.19 | 56.47 | 6.53 | 35.31 | 38.42 | Peak | 25 | 101 | VERTICAL |
| 2 a | 15536.48 | 42.72 | 54.00 | -11.28 | 31.17 | 7.85 | 34.79 | 38.49 | Average | 208 | 100 | VERTICAL |
| 3 | 15541.88 | 55.38 | 74.00 | -18.62 | 43.83 | 7.85 | 34.79 | 38.49 | Peak | 208 | 100 | VERTICAL |



| | | | |
|---------------|--------------|----------------|---|
| Temperature | 25.6°C | Humidity | 56% |
| Test Engineer | Jim Huang | Configurations | IEEE 802.11a CH 40 / Chain 1 + Chain 2 |
| Test Date | May 10, 2013 | | |

Horizontal

| | Freq | Level | Limit | Over | Read | CableAntenna | Preamp | Remark | A/Pos | T/Pos | Pol/Phase |
|---|----------|--------|--------|--------|-------|--------------|--------|--------|-------|-------|------------|
| | MHz | dBuV/m | dBuV/m | dB | dBuV | dB | dB/m | dB | cm | deg | |
| 1 | 10400.00 | 58.35 | 68.30 | -9.95 | 50.57 | 4.98 | 38.38 | 35.58 | 101 | 308 | HORIZONTAL |
| 2 | 15597.60 | 56.84 | 74.00 | -17.16 | 48.45 | 6.13 | 37.60 | 35.34 | 101 | 4 | HORIZONTAL |
| 3 | 15600.70 | 46.04 | 54.00 | -7.96 | 37.65 | 6.13 | 37.60 | 35.34 | 101 | 4 | HORIZONTAL |

Vertical

| | Freq | Level | Limit | Over | Read | CableAntenna | Preamp | Remark | A/Pos | T/Pos | Pol/Phase |
|---|----------|--------|--------|--------|-------|--------------|--------|--------|-------|-------|-----------|
| | MHz | dBuV/m | dBuV/m | dB | dBuV | dB | dB/m | dB | cm | deg | |
| 1 | 10397.90 | 67.87 | 68.30 | -0.43 | 60.09 | 4.98 | 38.38 | 35.58 | 133 | 347 | VERTICAL |
| 2 | 15596.50 | 45.48 | 54.00 | -8.52 | 37.09 | 6.13 | 37.60 | 35.34 | 101 | 352 | VERTICAL |
| 3 | 15598.30 | 56.98 | 74.00 | -17.02 | 48.59 | 6.13 | 37.60 | 35.34 | 101 | 352 | VERTICAL |

| | | | |
|---------------|--------------|----------------|---|
| Temperature | 25.6°C | Humidity | 56% |
| Test Engineer | Jim Huang | Configurations | IEEE 802.11a CH 48 / Chain 1 + Chain 2 |
| Test Date | May 10, 2013 | | |

Horizontal

| | Freq | Level | Limit | Over | Read | CableAntenna | Preamp | Remark | A/Pos | T/Pos | Pol/Phase |
|---|----------|--------|--------|--------|-------|--------------|--------|---------------|-------|-------|------------|
| | MHz | dBuV/m | dBuV/m | dB | dBuV | dB | dB/m | dB | cm | deg | |
| 1 | 10481.10 | 58.45 | 68.30 | -9.85 | 50.58 | 5.00 | 38.39 | 35.52 Peak | 100 | 308 | HORIZONTAL |
| 2 | 15712.10 | 51.81 | 74.00 | -22.19 | 43.57 | 6.14 | 37.48 | 35.38 Peak | 100 | 176 | HORIZONTAL |
| 3 | 15716.70 | 41.60 | 54.00 | -12.40 | 33.37 | 6.14 | 37.48 | 35.39 Average | 100 | 176 | HORIZONTAL |

Vertical

| | Freq | Level | Limit | Over | Read | CableAntenna | Preamp | Remark | A/Pos | T/Pos | Pol/Phase |
|---|----------|--------|--------|--------|-------|--------------|--------|---------------|-------|-------|-----------|
| | MHz | dBuV/m | dBuV/m | dB | dBuV | dB | dB/m | dB | cm | deg | |
| 1 | 10482.70 | 67.79 | 68.30 | -0.51 | 59.91 | 5.00 | 38.40 | 35.52 Peak | 131 | 336 | VERTICAL |
| 2 | 15718.90 | 43.30 | 54.00 | -10.70 | 35.07 | 6.14 | 37.48 | 35.39 Average | 100 | 42 | VERTICAL |
| 3 | 15719.70 | 55.27 | 74.00 | -18.73 | 47.04 | 6.14 | 37.48 | 35.39 Peak | 100 | 42 | VERTICAL |

| | | | |
|---------------|--------------|----------------|---|
| Temperature | 23°C | Humidity | 63% |
| Test Engineer | Benson Peng | Configurations | IEEE 802.11a Ch 52 / Chain 1 + Chain 2 |
| Test Date | May 13, 2013 | | |

Horizontal

| | Freq | Level | Limit | Over | Read | Cable | Preamp | Antenna | Remark | T/Pos | A/Pos | Pol/Phase |
|-----|----------|--------|--------|--------|-------|-------|--------|---------|---------|-------|-------|------------|
| | MHz | dBuV/m | dBuV/m | dB | dBuV | dB | dB | dB/m | | deg | cm | |
| 1 p | 10523.00 | 61.80 | 68.30 | -6.50 | 51.85 | 6.63 | 35.18 | 38.50 | Peak | 39 | 100 | HORIZONTAL |
| 2 a | 15775.92 | 44.80 | 54.00 | -9.20 | 33.42 | 7.93 | 34.99 | 38.44 | Average | 270 | 100 | HORIZONTAL |
| 3 | 15780.48 | 56.96 | 74.00 | -17.04 | 45.60 | 7.93 | 35.01 | 38.44 | Peak | 270 | 100 | HORIZONTAL |

Vertical

| | Freq | Level | Limit | Over | Read | Cable | Preamp | Antenna | Remark | T/Pos | A/Pos | Pol/Phase |
|-----|----------|--------|--------|--------|-------|-------|--------|---------|---------|-------|-------|-----------|
| | MHz | dBuV/m | dBuV/m | dB | dBuV | dB | dB | dB/m | | deg | cm | |
| 1 p | 10517.06 | 68.02 | 68.30 | -0.28 | 58.07 | 6.63 | 35.18 | 38.50 | Peak | 21 | 100 | VERTICAL |
| 2 | 15778.32 | 59.94 | 74.00 | -14.06 | 48.58 | 7.93 | 35.01 | 38.44 | Peak | 323 | 100 | VERTICAL |
| 3 a | 15778.86 | 45.52 | 54.00 | -8.48 | 34.16 | 7.93 | 35.01 | 38.44 | Average | 323 | 100 | VERTICAL |

| | | | |
|---------------|--------------|----------------|---|
| Temperature | 23°C | Humidity | 63% |
| Test Engineer | Benson Peng | Configurations | IEEE 802.11a Ch 60 / Chain 1 + Chain 2 |
| Test Date | May 13, 2013 | | |

Horizontal

| | Freq | Level | Limit | Over | Read | Cable | Preamp | Antenna | Remark | T/Pos | A/Pos | Pol/Phase |
|-----|----------|--------|--------|-------|-------|-------|--------|---------|---------|-------|-------|------------|
| | MHz | dBuV/m | dBuV/m | dB | dBuV | dB | dB | dB/m | | deg | cm | |
| 1 p | 10596.60 | 64.58 | 74.00 | -9.42 | 54.62 | 6.60 | 35.12 | 38.48 | Peak | 40 | 100 | HORIZONTAL |
| 2 a | 10597.12 | 48.97 | 54.00 | -5.03 | 39.01 | 6.60 | 35.12 | 38.48 | Average | 40 | 100 | HORIZONTAL |

Vertical

| | Freq | Level | Limit | Over | Read | Cable | Preamp | Antenna | Remark | T/Pos | A/Pos | Pol/Phase |
|-----|----------|--------|--------|-------|-------|-------|--------|---------|---------|-------|-------|-----------|
| | MHz | dBuV/m | dBuV/m | dB | dBuV | dB | dB | dB/m | | deg | cm | |
| 1 a | 10601.32 | 53.73 | 54.00 | -0.27 | 43.75 | 6.60 | 35.10 | 38.48 | Average | 2 | 100 | VERTICAL |
| 2 p | 10606.04 | 69.06 | 74.00 | -4.94 | 59.08 | 6.60 | 35.10 | 38.48 | Peak | 2 | 100 | VERTICAL |

| | | | |
|---------------|--------------|----------------|---|
| Temperature | 23°C | Humidity | 63% |
| Test Engineer | Benson Peng | Configurations | IEEE 802.11a Ch 64 / Chain 1 + Chain 2 |
| Test Date | May 13, 2013 | | |

Horizontal

| | Freq | Level | Limit | Over | Read | Cable | Preamp | Antenna | Remark | T/Pos | A/Pos | Pol/Phase |
|-----|----------|--------|--------|--------|-------|-------|--------|---------|---------|-------|-------|------------|
| | MHz | dBuV/m | dBuV/m | dB | dBuV | Loss | Factor | Factor | | deg | cm | |
| 1 p | 10636.68 | 59.32 | 74.00 | -14.68 | 49.34 | 6.59 | 35.08 | 38.47 | Peak | 40 | 119 | HORIZONTAL |
| 2 a | 10641.88 | 45.02 | 54.00 | -8.98 | 35.04 | 6.59 | 35.08 | 38.47 | Average | 40 | 119 | HORIZONTAL |

Vertical

| | Freq | Level | Limit | Over | Read | Cable | Preamp | Antenna | Remark | T/Pos | A/Pos | Pol/Phase |
|-----|----------|--------|--------|-------|-------|-------|--------|---------|---------|-------|-------|-----------|
| | MHz | dBuV/m | dBuV/m | dB | dBuV | Loss | Factor | Factor | | deg | cm | |
| 1 p | 10636.44 | 65.99 | 74.00 | -8.01 | 56.01 | 6.59 | 35.08 | 38.47 | Peak | 15 | 106 | VERTICAL |
| 2 a | 10641.92 | 50.00 | 54.00 | -4.00 | 40.02 | 6.59 | 35.08 | 38.47 | Average | 15 | 106 | VERTICAL |

| | | | |
|---------------|--------------|----------------|--|
| Temperature | 23°C | Humidity | 63% |
| Test Engineer | Benson Peng | Configurations | IEEE 802.11a Ch 100 / Chain 1 + Chain 2 |
| Test Date | May 13, 2013 | | |

Horizontal

| | Freq | Level | Limit | Over | Read | Cable | Preamp | Antenna | Remark | T/Pos | A/Pos | Pol/Phase |
|-----|----------|--------|--------|--------|-------|-------|--------|---------|---------|-------|-------|------------|
| | MHz | dBuV/m | dBuV/m | dB | dBuV | dB | dB | dB/m | | deg | cm | |
| 1 p | 10997.32 | 54.75 | 74.00 | -19.25 | 44.70 | 6.46 | 34.81 | 38.40 | Peak | 178 | 148 | HORIZONTAL |
| 2 a | 10999.68 | 41.93 | 54.00 | -12.07 | 31.88 | 6.46 | 34.81 | 38.40 | Average | 178 | 148 | HORIZONTAL |

Vertical

| | Freq | Level | Limit | Over | Read | Cable | Preamp | Antenna | Remark | T/Pos | A/Pos | Pol/Phase |
|-----|----------|--------|--------|--------|-------|-------|--------|---------|---------|-------|-------|-----------|
| | MHz | dBuV/m | dBuV/m | dB | dBuV | dB | dB | dB/m | | deg | cm | |
| 1 a | 10999.32 | 44.77 | 54.00 | -9.23 | 34.72 | 6.46 | 34.81 | 38.40 | Average | 22 | 100 | VERTICAL |
| 2 p | 10999.48 | 58.54 | 74.00 | -15.46 | 48.49 | 6.46 | 34.81 | 38.40 | Peak | 22 | 100 | VERTICAL |

| | | | |
|---------------|--------------|----------------|--|
| Temperature | 23°C | Humidity | 63% |
| Test Engineer | Benson Peng | Configurations | IEEE 802.11a Ch 116 / Chain 1 + Chain 2 |
| Test Date | May 13, 2013 | | |

Horizontal

| | Freq | Level | Limit | Over | Read | Cable | Preamp | Antenna | Remark | T/Pos | A/Pos | Pol/Phase |
|-----|----------|--------|--------|--------|-------|-------|--------|---------|---------|-------|-------|------------|
| | MHz | dBuV/m | dBuV/m | dB | dBuV | dB | dB | dB/m | | deg | cm | |
| 1 p | 11156.36 | 62.21 | 74.00 | -11.79 | 52.04 | 6.55 | 34.81 | 38.43 | Peak | 321 | 100 | HORIZONTAL |
| 2 a | 11161.92 | 46.71 | 54.00 | -7.29 | 36.53 | 6.56 | 34.81 | 38.43 | Average | 321 | 100 | HORIZONTAL |

Vertical

| | Freq | Level | Limit | Over | Read | Cable | Preamp | Antenna | Remark | T/Pos | A/Pos | Pol/Phase |
|-----|----------|--------|--------|-------|-------|-------|--------|---------|---------|-------|-------|-----------|
| | MHz | dBuV/m | dBuV/m | dB | dBuV | dB | dB | dB/m | | deg | cm | |
| 1 p | 11156.44 | 69.25 | 74.00 | -4.75 | 59.08 | 6.55 | 34.81 | 38.43 | Peak | 22 | 100 | VERTICAL |
| 2 a | 11162.36 | 53.98 | 54.00 | -0.02 | 43.80 | 6.56 | 34.81 | 38.43 | Average | 22 | 100 | VERTICAL |

| | | | |
|----------------------|--------------|-----------------------|--|
| Temperature | 23°C | Humidity | 63% |
| Test Engineer | Benson Peng | Configurations | IEEE 802.11a Ch 140 / Chain 1 + Chain 2 |
| Test Date | May 13, 2013 | | |

Horizontal

| | Freq | Level | Limit | Over | Read | Cable | Preamp | Antenna | Remark | T/Pos | A/Pos | Pol/Phase |
|-----|----------|--------|--------|--------|-------|-------|--------|---------|---------|-------|-------|------------|
| | MHz | dBuV/m | dBuV/m | dB | dBuV | dB | dB | dB/m | | deg | cm | |
| 1 p | 11399.12 | 59.87 | 74.00 | -14.13 | 49.52 | 6.69 | 34.82 | 38.48 | Peak | 64 | 113 | HORIZONTAL |
| 2 a | 11399.40 | 46.30 | 54.00 | -7.70 | 35.95 | 6.69 | 34.82 | 38.48 | Average | 64 | 113 | HORIZONTAL |

Vertical

| | Freq | Level | Limit | Over | Read | Cable | Preamp | Antenna | Remark | T/Pos | A/Pos | Pol/Phase |
|-----|----------|--------|--------|--------|-------|-------|--------|---------|---------|-------|-------|-----------|
| | MHz | dBuV/m | dBuV/m | dB | dBuV | dB | dB | dB/m | | deg | cm | |
| 1 a | 11399.04 | 47.09 | 54.00 | -6.91 | 36.74 | 6.69 | 34.82 | 38.48 | Average | 350 | 100 | VERTICAL |
| 2 p | 11399.20 | 58.45 | 74.00 | -15.55 | 48.10 | 6.69 | 34.82 | 38.48 | Peak | 350 | 100 | VERTICAL |

Note:

The amplitude of spurious emissions that are attenuated by more than 20dB below the permissible value has no need to be reported.

Emission level (dBuV/m) = 20 log Emission level (uV/m).

Corrected Reading: Antenna Factor + Cable Loss + Read Level - Preamp Factor = Level.

4.7. Band Edge Emissions Measurement

4.7.1. Limit

For transmitters operating in the 5.15-5.35 GHz band: all emissions outside of the 5.15-5.35 GHz band shall not exceed a -27dBm peak limit or average 54dBuV/m and peak 74dBuV/m limits. For transmitters operating in the 5.470-5.725 GHz band: all emissions outside of the 5.470-5.725 GHz band shall not exceed a -27dBm peak limit or average 54dBuV/m and peak 74dBuV/m limits. For transmitters operating in the 5.725-5.825 GHz band: all emissions within the frequency range from the band edge to 10 MHz above or below the band edge shall not exceed an EIRP of -17 dBm/MHz (78.3dBuV/m at 3m). In addition, In case the emission fall within the restricted band specified on 15.205(a), then the 15.209(a) limit in the table below has to be followed.

| Frequencies (MHz) | Field Strength (micorvolts/meter) | Measurement Distance (meters) |
|-------------------|-----------------------------------|-------------------------------|
| 0.009~0.490 | 2400/F(KHz) | 300 |
| 0.490~1.705 | 24000/F(KHz) | 30 |
| 1.705~30.0 | 30 | 30 |
| 30~88 | 100 | 3 |
| 88~216 | 150 | 3 |
| 216~960 | 200 | 3 |
| Above 960 | 500 | 3 |

4.7.2. Measuring Instruments and Setting

Please refer to section 5 of equipments list in this report. The following table is the setting of the spectrum analyzer.

| Spectrum Parameter | Setting |
|---|--|
| Attenuation | Auto |
| Span Frequency | 100 MHz |
| RBW / VBW (Emission in restricted band) | 1MHz / 3MHz for Peak, 1 MHz / 10Hz for Average |
| RBW / VBW (Emission in non-restricted band) | 1MHz / 3MHz for Peak |

4.7.3. Test Procedures

1. The test procedure is the same as section 4.6.3, only the frequency range investigated is limited to 100MHz around bandedges.

4.7.4. Test Setup Layout

This test setup layout is the same as that shown in section 4.6.4.

4.7.5. Test Deviation

There is no deviation with the original standard.

4.7.6. EUT Operation during Test

The EUT was programmed to be in continuously transmitting mode.

4.7.7. Test Result of Band Edge and Fundamental Emissions

| | | | |
|---------------|--------------|----------------|--|
| Temperature | 25.6°C | Humidity | 56% |
| Test Engineer | Jim Huang | Configurations | IEEE 802.11n MCS0 20MHz Ch 36, 40, 48 / Chain 1 + Chain 2 |
| Test Date | May 10, 2013 | | |

Channel 36

| | Freq | Level | Limit Line | Over Limit | Read Level | CableAntenna Loss | Antenna Factor | Preamp Factor | Remark | A/Pos | T/Pos | Pol/Phase |
|---|---------|--------|------------|------------|------------|-------------------|----------------|---------------|---------|-------|-------|------------|
| | MHz | dBuV/m | dBuV/m | dB | dBuV | dB | dB/m | dB | | cm | deg | |
| 1 | 5150.00 | 53.39 | 54.00 | -0.61 | 16.29 | 3.43 | 33.67 | 0.00 | Average | 125 | 289 | HORIZONTAL |
| 2 | 5150.00 | 71.44 | 74.00 | -2.56 | 34.34 | 3.43 | 33.67 | 0.00 | Peak | 125 | 289 | HORIZONTAL |
| 3 | 5183.40 | 113.60 | | | 76.43 | 3.44 | 33.73 | 0.00 | Peak | 125 | 289 | HORIZONTAL |
| 4 | 5184.40 | 102.48 | | | 65.31 | 3.44 | 33.73 | 0.00 | Average | 125 | 289 | HORIZONTAL |

Item 3, 4 are the fundamental frequency at 5180 MHz.

Channel 40

| | Freq | Level | Limit Line | Over Limit | Read Level | CableAntenna Loss | Antenna Factor | Preamp Factor | Remark | A/Pos | T/Pos | Pol/Phase |
|---|---------|--------|------------|------------|------------|-------------------|----------------|---------------|---------|-------|-------|------------|
| | MHz | dBuV/m | dBuV/m | dB | dBuV | dB | dB/m | dB | | cm | deg | |
| 1 | 5150.00 | 51.97 | 54.00 | -2.03 | 14.87 | 3.43 | 33.67 | 0.00 | Average | 115 | 295 | HORIZONTAL |
| 2 | 5150.00 | 73.41 | 74.00 | -0.59 | 36.31 | 3.43 | 33.67 | 0.00 | Peak | 115 | 295 | HORIZONTAL |
| 3 | 5195.60 | 105.15 | | | 67.94 | 3.45 | 33.76 | 0.00 | Average | 115 | 295 | HORIZONTAL |
| 4 | 5198.00 | 118.15 | | | 80.94 | 3.45 | 33.76 | 0.00 | Peak | 115 | 295 | HORIZONTAL |

Item 3, 4 are the fundamental frequency at 5200 MHz.

Channel 48

| | Freq | Level | Limit Line | Over Limit | Read Level | CableAntenna Loss | Antenna Factor | Preamp Factor | Remark | A/Pos | T/Pos | Pol/Phase |
|---|---------|--------|------------|------------|------------|-------------------|----------------|---------------|---------|-------|-------|-----------|
| | MHz | dBuV/m | dBuV/m | dB | dBuV | dB | dB/m | dB | | cm | deg | |
| 1 | 5149.60 | 60.06 | 74.00 | -13.94 | 22.96 | 3.43 | 33.67 | 0.00 | Peak | 100 | 20 | VERTICAL |
| 2 | 5150.00 | 41.09 | 54.00 | -12.91 | 3.99 | 3.43 | 33.67 | 0.00 | Average | 100 | 20 | VERTICAL |
| 3 | 5235.20 | 105.99 | | | 68.71 | 3.46 | 33.82 | 0.00 | Average | 100 | 20 | VERTICAL |
| 4 | 5235.60 | 118.71 | | | 81.43 | 3.46 | 33.82 | 0.00 | Peak | 100 | 20 | VERTICAL |

Item 3, 4 are the fundamental frequency at 5240 MHz.

| | | | |
|---------------|--------------|----------------|--|
| Temperature | 23°C | Humidity | 63% |
| Test Engineer | Benson Peng | Configurations | IEEE 802.11n MCS0 20MHz Ch 52, 60, 64 / Chain 1 + Chain 2 |
| Test Date | May 14, 2013 | | |

Channel 52

| | Freq | Level | Limit | Over | Read | Cable | Preamp | Antenna | Remark | T/Pos | A/Pos | Pol/Phase |
|-----|---------|--------|--------|-------|-------|-------|--------|---------|---------|-------|-------|-----------|
| | MHz | dBuV/m | dBuV/m | dB | dBuV | dB | dB | dB/m | | deg | cm | |
| 1 p | 5314.00 | 113.71 | | | 75.85 | 4.45 | 0.00 | 33.41 | Peak | 351 | 121 | VERTICAL |
| 2 a | 5325.80 | 100.57 | | | 62.71 | 4.45 | 0.00 | 33.41 | Average | 351 | 121 | VERTICAL |
| 3 ! | 5350.00 | 53.94 | 54.00 | -0.06 | 16.01 | 4.47 | 0.00 | 33.46 | Average | 351 | 121 | VERTICAL |
| 4 ! | 5350.40 | 73.89 | 74.00 | -0.11 | 35.96 | 4.47 | 0.00 | 33.46 | Peak | 351 | 121 | VERTICAL |

Item 1, 2 are the fundamental frequency at 5260 MHz.

Channel 60

| | Freq | Level | Limit | Over | Read | Cable | Preamp | Antenna | Remark | T/Pos | A/Pos | Pol/Phase |
|-----|---------|--------|--------|-------|-------|-------|--------|---------|---------|-------|-------|------------|
| | MHz | dBuV/m | dBuV/m | dB | dBuV | dB | dB | dB/m | | deg | cm | |
| 1 a | 5294.80 | 101.74 | | | 63.92 | 4.44 | 0.00 | 33.38 | Average | 162 | 126 | HORIZONTAL |
| 2 p | 5302.00 | 114.83 | | | 77.01 | 4.44 | 0.00 | 33.38 | Peak | 162 | 126 | HORIZONTAL |
| 3 | 5350.00 | 44.84 | 54.00 | -9.16 | 6.91 | 4.47 | 0.00 | 33.46 | Average | 162 | 126 | HORIZONTAL |
| 4 | 5350.40 | 64.30 | 74.00 | -9.70 | 26.37 | 4.47 | 0.00 | 33.46 | Peak | 162 | 126 | HORIZONTAL |

Item 1, 2 are the fundamental frequency at 5300 MHz.

Channel 64

| | Freq | Level | Limit | Over | Read | Cable | Preamp | Antenna | Remark | T/Pos | A/Pos | Pol/Phase |
|-----|---------|--------|--------|-------|-------|-------|--------|---------|---------|-------|-------|-----------|
| | MHz | dBuV/m | dBuV/m | dB | dBuV | dB | dB | dB/m | | deg | cm | |
| 1 p | 5314.00 | 113.71 | | | 75.85 | 4.45 | 0.00 | 33.41 | Peak | 351 | 121 | VERTICAL |
| 2 a | 5325.80 | 100.57 | | | 62.71 | 4.45 | 0.00 | 33.41 | Average | 351 | 121 | VERTICAL |
| 3 ! | 5350.00 | 53.94 | 54.00 | -0.06 | 16.01 | 4.47 | 0.00 | 33.46 | Average | 351 | 121 | VERTICAL |
| 4 ! | 5350.40 | 73.89 | 74.00 | -0.11 | 35.96 | 4.47 | 0.00 | 33.46 | Peak | 351 | 121 | VERTICAL |

Item 1, 2 are the fundamental frequency at 5320 MHz.

| | | | |
|---------------|--------------|----------------|--|
| Temperature | 23°C | Humidity | 63% |
| Test Engineer | Benson Peng | Configurations | IEEE 802.11n MCS0 20MHz Ch 100, 140 / Chain 1 + Chain 2 |
| Test Date | May 14, 2013 | | |

Channel 100

| | Freq | Level | Limit | Over | Read | Cable | Preamp | Antenna | Remark | T/Pos | A/Pos | Pol/Phase |
|---|---------|--------|--------|--------|-------|-------|--------|---------|---------|-------|-------|------------|
| | MHz | dBuV/m | dBuV/m | dB | dBuV | dB | dB | dB/m | | deg | cm | |
| 1 | 5459.80 | 60.73 | 74.00 | -13.27 | 22.57 | 4.54 | 0.00 | 33.62 | Peak | 157 | 124 | HORIZONTAL |
| 2 | 5460.00 | 44.89 | 54.00 | -9.11 | 6.73 | 4.54 | 0.00 | 33.62 | Average | 157 | 124 | HORIZONTAL |
| 3 | 5469.40 | 73.96 | 74.00 | -0.04 | 35.76 | 4.55 | 0.00 | 33.65 | Peak | 157 | 124 | HORIZONTAL |
| 4 | 5470.00 | 53.74 | 54.00 | -0.26 | 15.54 | 4.55 | 0.00 | 33.65 | Average | 157 | 124 | HORIZONTAL |
| 5 | 5502.00 | 113.86 | | | 75.59 | 4.57 | 0.00 | 33.70 | Peak | 157 | 124 | HORIZONTAL |
| 6 | 5505.60 | 100.53 | | | 62.26 | 4.57 | 0.00 | 33.70 | Average | 157 | 124 | HORIZONTAL |

Item 5, 6 are the fundamental frequency at 5500 MHz.

Channel 140

| | Freq | Level | Limit | Over | Read | Cable | Preamp | Antenna | Remark | T/Pos | A/Pos | Pol/Phase |
|---|---------|--------|--------|-------|-------|-------|--------|---------|---------|-------|-------|-----------|
| | MHz | dBuV/m | dBuV/m | dB | dBuV | dB | dB | dB/m | | deg | cm | |
| 1 | 5694.20 | 112.39 | | | 73.42 | 4.70 | 0.00 | 34.27 | Peak | 359 | 100 | VERTICAL |
| 2 | 5697.60 | 98.45 | | | 59.48 | 4.70 | 0.00 | 34.27 | Average | 359 | 100 | VERTICAL |
| 3 | 5725.00 | 52.46 | 54.00 | -1.54 | 13.37 | 4.72 | 0.00 | 34.37 | Average | 359 | 100 | VERTICAL |
| 4 | 5725.20 | 73.85 | 74.00 | -0.15 | 34.76 | 4.72 | 0.00 | 34.37 | Peak | 359 | 100 | VERTICAL |

Item 1, 2 are the fundamental frequency at 5700 MHz.

| | | | |
|----------------------|--------------|-----------------------|---|
| Temperature | 25.6°C | Humidity | 56% |
| Test Engineer | Jim Huang | Configurations | IEEE 802.11n MCS0 40MHz Ch 38, 46 / Chain 1 + Chain 2 |
| Test Date | May 10, 2013 | | |

Channel 38

| | Freq | Level | Limit | Over | Read | CableAntenna | Preamp | Remark | A/Pos | T/Pos | PoI/Phase |
|---|---------|--------|--------|-------|-------|--------------|--------|--------------|-------|-------|-----------|
| | MHz | dBuV/m | dBuV/m | dB | dBuV | dB | dB/m | dB | cm | deg | |
| 1 | 5149.20 | 69.51 | 74.00 | -4.49 | 32.41 | 3.43 | 33.67 | 0.00 Peak | 100 | 21 | VERTICAL |
| 2 | 5150.00 | 53.70 | 54.00 | -0.30 | 16.60 | 3.43 | 33.67 | 0.00 Average | 100 | 21 | VERTICAL |
| 3 | 5203.20 | 106.95 | | | 69.74 | 3.45 | 33.76 | 0.00 Peak | 100 | 21 | VERTICAL |
| 4 | 5203.60 | 92.57 | | | 55.36 | 3.45 | 33.76 | 0.00 Average | 100 | 21 | VERTICAL |

Item 3, 4 are the fundamental frequency at 5190 MHz.

Channel 46

| | Freq | Level | Limit | Over | Read | CableAntenna | Preamp | Remark | A/Pos | T/Pos | PoI/Phase |
|---|---------|--------|--------|-------|-------|--------------|--------|--------------|-------|-------|-----------|
| | MHz | dBuV/m | dBuV/m | dB | dBuV | dB | dB/m | dB | cm | deg | |
| 1 | 5150.00 | 53.92 | 54.00 | -0.08 | 16.82 | 3.43 | 33.67 | 0.00 Average | 100 | 23 | VERTICAL |
| 2 | 5150.00 | 72.08 | 74.00 | -1.92 | 34.98 | 3.43 | 33.67 | 0.00 Peak | 100 | 23 | VERTICAL |
| 3 | 5217.20 | 99.47 | | | 62.23 | 3.45 | 33.79 | 0.00 Average | 100 | 23 | VERTICAL |
| 4 | 5222.40 | 113.80 | | | 76.55 | 3.46 | 33.79 | 0.00 Peak | 100 | 23 | VERTICAL |

Item 3, 4 are the fundamental frequency at 5230 MHz.



| | | | |
|---------------|--------------|----------------|---|
| Temperature | 23°C | Humidity | 63% |
| Test Engineer | Benson Peng | Configurations | IEEE 802.11n MCS0 40MHz Ch 54, 62 / Chain 1 + Chain 2 |
| Test Date | May 14, 2013 | | |

Channel 54

| | Freq | Level | Limit | Over | Read | Cable | Preamp | Antenna | Remark | T/Pos | A/Pos | Pol/Phase |
|-----|---------|--------|--------|-------|-------|-------|--------|---------|---------|-------|-------|-----------|
| | MHz | dBuV/m | dBuV/m | dB | dBuV | dB | dB | dB/m | | deg | cm | |
| 1 p | 5280.00 | 113.65 | | | 75.87 | 4.43 | 0.00 | 33.35 | Peak | 356 | 109 | VERTICAL |
| 2 a | 5285.20 | 98.88 | | | 61.10 | 4.43 | 0.00 | 33.35 | Average | 356 | 109 | VERTICAL |
| 3 ! | 5350.40 | 72.35 | 74.00 | -1.65 | 34.42 | 4.47 | 0.00 | 33.46 | Peak | 356 | 109 | VERTICAL |
| 4 ! | 5352.00 | 53.94 | 54.00 | -0.06 | 16.01 | 4.47 | 0.00 | 33.46 | Average | 356 | 109 | VERTICAL |

Item 1, 2 are the fundamental frequency at 5270 MHz.

Channel 62

| | Freq | Level | Limit | Over | Read | Cable | Preamp | Antenna | Remark | T/Pos | A/Pos | Pol/Phase |
|-----|---------|--------|--------|-------|-------|-------|--------|---------|---------|-------|-------|-----------|
| | MHz | dBuV/m | dBuV/m | dB | dBuV | dB | dB | dB/m | | deg | cm | |
| 1 p | 5322.40 | 105.14 | | | 67.28 | 4.45 | 0.00 | 33.41 | Peak | 352 | 108 | VERTICAL |
| 2 a | 5325.20 | 90.89 | | | 53.03 | 4.45 | 0.00 | 33.41 | Average | 352 | 108 | VERTICAL |
| 3 ! | 5350.00 | 53.64 | 54.00 | -0.36 | 15.71 | 4.47 | 0.00 | 33.46 | Average | 352 | 108 | VERTICAL |
| 4 ! | 5351.20 | 70.09 | 74.00 | -3.91 | 32.16 | 4.47 | 0.00 | 33.46 | Peak | 352 | 108 | VERTICAL |

Item 1, 2 are the fundamental frequency at 5310 MHz.



| | | | |
|---------------|--------------|----------------|---|
| Temperature | 23°C | Humidity | 63% |
| Test Engineer | Benson Peng | Configurations | IEEE 802.11n MCS0 40MHz Ch 102, 110, 134 / Chain 1 + Chain 2 |
| Test Date | May 14, 2013 | | |

Channel 102

| | Freq | Level | Limit Line | Over Limit | Read Level | Cable Loss | Preamp Factor | Antenna Factor | Remark | T/Pos | A/Pos | Pol/Phase |
|-----|---------|--------|------------|------------|------------|------------|---------------|----------------|---------|-------|-------|------------|
| | MHz | dBuV/m | dBuV/m | dB | dBuV | dB | dB | dB/m | | deg | cm | |
| 1 | 5460.00 | 64.34 | 74.00 | -9.66 | 26.18 | 4.54 | 0.00 | 33.62 | Peak | 158 | 122 | HORIZONTAL |
| 2 | 5460.00 | 45.60 | 74.00 | -28.40 | 7.44 | 4.54 | 0.00 | 33.62 | Peak | 158 | 122 | HORIZONTAL |
| 3 ! | 5470.00 | 69.18 | 74.00 | -4.82 | 30.98 | 4.55 | 0.00 | 33.65 | Peak | 158 | 122 | HORIZONTAL |
| 4 ! | 5470.00 | 53.91 | 54.00 | -0.09 | 15.71 | 4.55 | 0.00 | 33.65 | Average | 158 | 122 | HORIZONTAL |
| 5 a | 5514.80 | 91.80 | | | 53.47 | 4.58 | 0.00 | 33.75 | Average | 158 | 122 | HORIZONTAL |
| 6 p | 5523.60 | 104.72 | | | 66.39 | 4.58 | 0.00 | 33.75 | Peak | 158 | 122 | HORIZONTAL |

Item 5, 6 are the fundamental frequency at 5510MHz.

Channel 110

| | Freq | Level | Limit Line | Over Limit | Read Level | Cable Loss | Preamp Factor | Antenna Factor | Remark | T/Pos | A/Pos | Pol/Phase |
|-----|---------|--------|------------|------------|------------|------------|---------------|----------------|---------|-------|-------|-----------|
| | MHz | dBuV/m | dBuV/m | dB | dBuV | dB | dB | dB/m | | deg | cm | |
| 1 ! | 5457.20 | 68.20 | 74.00 | -5.80 | 30.04 | 4.54 | 0.00 | 33.62 | Peak | 330 | 115 | VERTICAL |
| 2 ! | 5460.00 | 49.67 | 54.00 | -4.33 | 11.51 | 4.54 | 0.00 | 33.62 | Average | 330 | 115 | VERTICAL |
| 3 ! | 5469.60 | 53.54 | 54.00 | -0.46 | 15.34 | 4.55 | 0.00 | 33.65 | Average | 330 | 115 | VERTICAL |
| 4 ! | 5470.00 | 72.38 | 74.00 | -1.62 | 34.18 | 4.55 | 0.00 | 33.65 | Peak | 330 | 115 | VERTICAL |
| 5 p | 5542.80 | 113.50 | | | 75.11 | 4.59 | 0.00 | 33.80 | Peak | 330 | 115 | VERTICAL |
| 6 a | 5554.80 | 99.63 | | | 61.17 | 4.60 | 0.00 | 33.86 | Average | 330 | 115 | VERTICAL |

Item 5, 6 are the fundamental frequency at 5550 MHz.

Channel 134

| | Freq | Level | Limit Line | Over Limit | Read Level | Cable Loss | Preamp Factor | Antenna Factor | Remark | T/Pos | A/Pos | Pol/Phase |
|-----|---------|--------|------------|------------|------------|------------|---------------|----------------|---------|-------|-------|-----------|
| | MHz | dBuV/m | dBuV/m | dB | dBuV | dB | dB | dB/m | | deg | cm | |
| 1 a | 5662.40 | 96.55 | | | 57.71 | 4.67 | 0.00 | 34.17 | Average | 345 | 100 | VERTICAL |
| 2 p | 5667.60 | 110.68 | | | 71.78 | 4.68 | 0.00 | 34.22 | Peak | 345 | 100 | VERTICAL |
| 3 ! | 5725.00 | 53.54 | 54.00 | -0.46 | 14.45 | 4.72 | 0.00 | 34.37 | Average | 345 | 100 | VERTICAL |
| 4 ! | 5726.60 | 71.90 | 74.00 | -2.10 | 32.81 | 4.72 | 0.00 | 34.37 | Peak | 345 | 100 | VERTICAL |

Item 1, 2 are the fundamental frequency at 5670 MHz.

Note:

Emission level (dBuV/m) = 20 log Emission level (uV/m)

Corrected Reading: Antenna Factor + Cable Loss + Read Level - Preamp Factor = Level



| | | | |
|----------------------|--------------|-----------------------|---|
| Temperature | 25.6°C | Humidity | 56% |
| Test Engineer | Jim Huang | Configurations | IEEE 802.11a Ch 36, 40, 48 / Chain 1 + Chain 2 |
| Test Date | May 10, 2013 | | |

Channel 36

| | Freq | Level | Limit Line | Over Limit | Read Level | Cable Loss | Antenna Factor | Preamp Factor | Remark | A/Pos | T/Pos | Pol/Phase |
|---|---------|--------|------------|------------|------------|------------|----------------|---------------|---------|-------|-------|-----------|
| | MHz | dBuV/m | dBuV/m | dB | dBuV | dB | dB/m | dB | | cm | deg | |
| 1 | 5150.00 | 51.39 | 54.00 | -2.61 | 14.29 | 3.43 | 33.67 | 0.00 | Average | 100 | 3 | VERTICAL |
| 2 | 5150.00 | 73.09 | 74.00 | -0.91 | 35.99 | 3.43 | 33.67 | 0.00 | Peak | 100 | 3 | VERTICAL |
| 3 | 5183.20 | 101.82 | | | 64.65 | 3.44 | 33.73 | 0.00 | Average | 100 | 3 | VERTICAL |
| 4 | 5186.40 | 113.71 | | | 76.54 | 3.44 | 33.73 | 0.00 | Peak | 100 | 3 | VERTICAL |

Item 3, 4 are the fundamental frequency at 5180 MHz.

Channel 40

| | Freq | Level | Limit Line | Over Limit | Read Level | Cable Loss | Antenna Factor | Preamp Factor | Remark | A/Pos | T/Pos | Pol/Phase |
|---|---------|--------|------------|------------|------------|------------|----------------|---------------|---------|-------|-------|------------|
| | MHz | dBuV/m | dBuV/m | dB | dBuV | dB | dB/m | dB | | cm | deg | |
| 1 | 5150.00 | 53.86 | 54.00 | -0.14 | 16.76 | 3.43 | 33.67 | 0.00 | Average | 139 | 293 | HORIZONTAL |
| 2 | 5150.00 | 73.42 | 74.00 | -0.58 | 36.32 | 3.43 | 33.67 | 0.00 | Peak | 139 | 293 | HORIZONTAL |
| 3 | 5196.40 | 119.51 | | | 82.30 | 3.45 | 33.76 | 0.00 | Peak | 139 | 293 | HORIZONTAL |
| 4 | 5196.80 | 107.24 | | | 70.03 | 3.45 | 33.76 | 0.00 | Average | 139 | 293 | HORIZONTAL |

Item 3, 4 are the fundamental frequency at 5200 MHz.

Channel 48

| | Freq | Level | Limit Line | Over Limit | Read Level | Cable Loss | Antenna Factor | Preamp Factor | Remark | A/Pos | T/Pos | Pol/Phase |
|---|---------|--------|------------|------------|------------|------------|----------------|---------------|---------|-------|-------|------------|
| | MHz | dBuV/m | dBuV/m | dB | dBuV | dB | dB/m | dB | | cm | deg | |
| 1 | 5150.00 | 39.63 | 54.00 | -14.37 | 2.53 | 3.43 | 33.67 | 0.00 | Average | 139 | 294 | HORIZONTAL |
| 2 | 5150.00 | 50.72 | 74.00 | -23.28 | 13.62 | 3.43 | 33.67 | 0.00 | Peak | 139 | 294 | HORIZONTAL |
| 3 | 5245.20 | 103.77 | | | 66.49 | 3.46 | 33.82 | 0.00 | Average | 139 | 294 | HORIZONTAL |
| 4 | 5246.00 | 116.12 | | | 78.81 | 3.46 | 33.85 | 0.00 | Peak | 139 | 294 | HORIZONTAL |

Item 3, 4 are the fundamental frequency at 5240 MHz.

| | | | |
|---------------|--------------|----------------|---|
| Temperature | 23°C | Humidity | 63% |
| Test Engineer | Benson Peng | Configurations | IEEE 802.11a Ch 52, 60, 64 / Chain 1 + Chain 2 |
| Test Date | May 14, 2013 | | |

Channel 52

| | Freq | Level | Limit | Over | Read | Cable | Preamp | Antenna | Remark | T/Pos | A/Pos | Pol/Phase |
|-----|---------|--------|--------|--------|-------|-------|--------|---------|---------|-------|-------|------------|
| | MHz | dBuV/m | dBuV/m | dB | dBuV | dB | dB | dB/m | | deg | cm | |
| 1 | 5150.00 | 51.74 | 74.00 | -22.26 | 14.26 | 4.34 | 0.00 | 33.14 | Peak | 164 | 131 | HORIZONTAL |
| 2 | 5150.00 | 40.02 | 54.00 | -13.98 | 2.54 | 4.34 | 0.00 | 33.14 | Average | 164 | 131 | HORIZONTAL |
| 3 p | 5258.80 | 114.94 | | | 77.19 | 4.42 | 0.00 | 33.33 | Peak | 164 | 131 | HORIZONTAL |
| 4 a | 5263.00 | 103.15 | | | 65.40 | 4.42 | 0.00 | 33.33 | Average | 164 | 131 | HORIZONTAL |
| 5 | 5350.00 | 41.31 | 54.00 | -12.69 | 3.38 | 4.47 | 0.00 | 33.46 | Average | 164 | 131 | HORIZONTAL |
| 6 | 5351.20 | 52.58 | 74.00 | -21.42 | 14.65 | 4.47 | 0.00 | 33.46 | Peak | 164 | 131 | HORIZONTAL |

Item 3, 4 are the fundamental frequency at 5260 MHz.

Channel 60

| | Freq | Level | Limit | Over | Read | Cable | Preamp | Antenna | Remark | T/Pos | A/Pos | Pol/Phase |
|-----|---------|--------|--------|--------|-------|-------|--------|---------|---------|-------|-------|------------|
| | MHz | dBuV/m | dBuV/m | dB | dBuV | dB | dB | dB/m | | deg | cm | |
| 1 p | 5296.40 | 114.92 | | | 77.10 | 4.44 | 0.00 | 33.38 | Peak | 166 | 126 | HORIZONTAL |
| 2 a | 5306.80 | 103.06 | | | 65.24 | 4.44 | 0.00 | 33.38 | Average | 166 | 126 | HORIZONTAL |
| 3 | 5350.00 | 43.42 | 54.00 | -10.58 | 5.49 | 4.47 | 0.00 | 33.46 | Average | 166 | 126 | HORIZONTAL |
| 4 | 5350.40 | 63.77 | 74.00 | -10.23 | 25.84 | 4.47 | 0.00 | 33.46 | Peak | 166 | 126 | HORIZONTAL |

Item 1, 2 are the fundamental frequency at 5300 MHz.

Channel 64

| | Freq | Level | Limit | Over | Read | Cable | Preamp | Antenna | Remark | T/Pos | A/Pos | Pol/Phase |
|-----|---------|--------|--------|-------|-------|-------|--------|---------|---------|-------|-------|-----------|
| | MHz | dBuV/m | dBuV/m | dB | dBuV | dB | dB | dB/m | | deg | cm | |
| 1 a | 5324.60 | 101.93 | | | 64.07 | 4.45 | 0.00 | 33.41 | Average | 350 | 123 | VERTICAL |
| 2 p | 5325.20 | 114.15 | | | 76.29 | 4.45 | 0.00 | 33.41 | Peak | 350 | 123 | VERTICAL |
| 3 ! | 5350.00 | 73.61 | 74.00 | -0.39 | 35.68 | 4.47 | 0.00 | 33.46 | Peak | 350 | 123 | VERTICAL |
| 4 ! | 5350.20 | 53.44 | 54.00 | -0.56 | 15.51 | 4.47 | 0.00 | 33.46 | Average | 350 | 123 | VERTICAL |

Item 1, 2 are the fundamental frequency at 5320 MHz.

| | | | |
|---------------|--------------|----------------|---|
| Temperature | 23°C | Humidity | 63% |
| Test Engineer | Benson Peng | Configurations | IEEE 802.11a Ch 100, 140 / Chain 1 + Chain 2 |
| Test Date | May 14, 2013 | | |

Channel 100

| | Freq | Level | Limit | Over | Read | Cable | Preamp | Antenna | Remark | T/Pos | A/Pos | Pol/Phase |
|-----|---------|--------|--------|--------|-------|-------|--------|---------|---------|-------|-------|-----------|
| | MHz | dBuV/m | dBuV/m | dB | dBuV | dB | dB | dB/m | | deg | cm | |
| 1 | 5460.00 | 60.71 | 74.00 | -13.29 | 22.55 | 4.54 | 0.00 | 33.62 | Peak | 315 | 136 | VERTICAL |
| 2 | 5460.00 | 43.85 | 54.00 | -10.15 | 5.69 | 4.54 | 0.00 | 33.62 | Average | 315 | 136 | VERTICAL |
| 3 ! | 5469.80 | 73.94 | 74.00 | -0.06 | 35.74 | 4.55 | 0.00 | 33.65 | Peak | 315 | 136 | VERTICAL |
| 4 ! | 5470.00 | 52.10 | 54.00 | -1.90 | 13.90 | 4.55 | 0.00 | 33.65 | Average | 315 | 136 | VERTICAL |
| 5 p | 5494.60 | 113.89 | | | 75.66 | 4.56 | 0.00 | 33.67 | Peak | 315 | 136 | VERTICAL |
| 6 a | 5504.00 | 100.53 | | | 62.26 | 4.57 | 0.00 | 33.70 | Average | 315 | 136 | VERTICAL |

Item 5, 6 are the fundamental frequency at 5500 MHz.

Channel 140

| | Freq | Level | Limit | Over | Read | Cable | Preamp | Antenna | Remark | T/Pos | A/Pos | Pol/Phase |
|-----|---------|--------|--------|-------|-------|-------|--------|---------|---------|-------|-------|-----------|
| | MHz | dBuV/m | dBuV/m | dB | dBuV | dB | dB | dB/m | | deg | cm | |
| 1 a | 5694.00 | 100.86 | | | 61.89 | 4.70 | 0.00 | 34.27 | Average | 341 | 100 | VERTICAL |
| 2 p | 5694.60 | 113.18 | | | 74.21 | 4.70 | 0.00 | 34.27 | Peak | 341 | 100 | VERTICAL |
| 3 ! | 5725.00 | 53.69 | 54.00 | -0.31 | 14.60 | 4.72 | 0.00 | 34.37 | Average | 341 | 100 | VERTICAL |
| 4 ! | 5726.80 | 73.83 | 74.00 | -0.17 | 34.74 | 4.72 | 0.00 | 34.37 | Peak | 341 | 100 | VERTICAL |

Item 1, 2 are the fundamental frequency at 5700 MHz.

Note:

Emission level (dBuV/m) = 20 log Emission level (uV/m)

Corrected Reading: Antenna Factor + Cable Loss + Read Level - Preamp Factor = Level

4.8. Frequency Stability Measurement

4.8.1. Limit

In-band emission is maintained within the band of operation under all conditions of normal operation as specified in the user's manual.

The transmitter center frequency tolerance shall be ± 20 ppm maximum for the 5 GHz band (IEEE 802.11n specification).

4.8.2. Measuring Instruments and Setting

Please refer to section 5 of equipments list in this report. The following table is the setting of the spectrum analyzer.

| Spectrum Parameter | Setting |
|--------------------|--|
| Attenuation | Auto |
| Span Frequency | Entire absence of modulation emissions bandwidth |
| RBW | 10 kHz |
| VBW | 10 kHz |
| Sweep Time | Auto |

4.8.3. Test Procedures

1. The transmitter output (antenna port) was connected to the spectrum analyzer.
2. EUT have transmitted absence of modulation signal and fixed channelize.
3. Set the spectrum analyzer span to view the entire absence of modulation emissions bandwidth.
4. Set RBW = 10 kHz, VBW = 10 kHz with peak detector and maxhold settings.
5. f_c is declaring of channel frequency. Then the frequency error formula is $(f_c - f) / f_c \times 10^6$ ppm and the limit is less than ± 20 ppm (IEEE 802.11n specification).
6. The test extreme voltage is to change the primary supply voltage from 85 to 115 percent of the nominal value
7. Extreme temperature rule is $-10^\circ\text{C} \sim 60^\circ\text{C}$.

4.8.4. Test Setup Layout

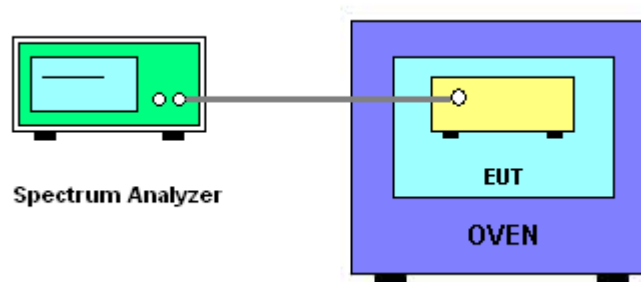

4.8.5. Test Deviation

There is no deviation with the original standard.

4.8.6. EUT Operation during Test

The EUT was programmed to be in continuously un-modulation transmitting mode.

4.8.7. Test Result of Frequency Stability

Voltage vs. Frequency Stability

| Voltage | Measurement Frequency (MHz) | |
|----------------------|-----------------------------|-----------|
| | 5200 | 5300 |
| (V) | | |
| 126.50 | 5200.0458 | 5300.0125 |
| 110.00 | 5200.0522 | 5300.0040 |
| 93.50 | 5200.0585 | 5300.0025 |
| Max. Deviation (MHz) | 0.058500 | 0.012500 |
| Max. Deviation (ppm) | 11.25 | 2.36 |

Temperature vs. Frequency Stability

| Temperature | Measurement Frequency (MHz) | |
|----------------------|-----------------------------|-----------|
| | 5200 | 5300 |
| (°C) | | |
| -10 | 5200.0358 | 5299.9988 |
| 0 | 5200.0395 | 5299.9990 |
| 10 | 5200.0455 | 5299.9995 |
| 20 | 5200.0512 | 5300.0040 |
| 30 | 5200.0522 | 5300.0040 |
| 40 | 5200.0555 | 5300.0158 |
| 50 | 5200.0685 | 5300.0258 |
| 60 | 5200.0758 | 5300.0358 |
| Max. Deviation (MHz) | 0.075800 | 0.035800 |
| Max. Deviation (ppm) | 14.58 | 6.7547 |

4.9. Antenna Requirements

4.9.1. Limit

Except for special regulations, the Low-power Radio-frequency Devices must not be equipped with any jacket for installing an antenna with extension cable. An intentional radiator shall be designed to ensure that no antenna other than that furnished by the responsible party shall be used with the device. The use of a permanently attached antenna or of an antenna that uses a unique coupling to the intentional radiator shall be considered sufficient to comply with the provisions of this Section. The manufacturer may design the unit so that the user can replace a broken antenna, but the use of a standard antenna jack or electrical connector is prohibited. Further, this requirement does not apply to intentional radiators that must be professionally installed.

4.9.2. Antenna Connector Construction

Please refer to section 3.3 in this test report; antenna connector complied with the requirements.

5. LIST OF MEASURING EQUIPMENTS

| Instrument | Manufacturer | Model No. | Serial No. | Characteristics | Calibration Date | Remark |
|----------------------------------|---------------|------------------|----------------|------------------|------------------|-----------------------|
| EMI Test Receiver | R&S | ESCS 30 | 100377 | 9kHz ~ 2.75GHz | Oct. 23, 2012 | Conduction (CO01-CB) |
| LISN | F.C.C. | FCC-LISN-50-16-2 | 04083 | 150kHz ~ 100MHz | Nov. 26, 2012 | Conduction (CO01-CB) |
| V- LISN | Schwarzbeck | NSLK 8127 | 8127-478 | 9kHz ~ 30MHz | Jun. 22, 2012 | Conduction (CO01-CB) |
| Impulsbegrenzer Pulse Limiter | Rohde&Schwarz | ESH3-Z2 | 100430 | 9kHz-30MHz | Feb. 21, 2013 | Conduction (CO01-CB) |
| COND Cable | Woken | Cable | 01 | 0.15MHz-30MHz | Dec. 04, 2012 | Conduction (CO01-CB) |
| Software | Audix | E3 | 5.410e | - | - | Conduction (CO01-CB) |
| BILOG ANTENNA | Schaffner | CBL6112D | 22021 | 20MHz ~ 2GHz | Apr. 16, 2013 | Radiation (03CH01-CB) |
| Loop Antenna | Teseq | HLA 6120 | 24155 | 9 kHz - 30 MHz | Nov. 05, 2012* | Radiation (03CH01-CB) |
| Horn Antenna | EMCO | 3115 | 00075790 | 750MHz-18GHz | Nov. 27, 2012 | Radiation (03CH01-CB) |
| Horn Antenna | SCHWARZBEAK | BBHA 9170 | BBHA9170252 | 15GHz ~ 40GHz | Nov. 23, 2012 | Radiation (03CH01-CB) |
| Pre-Amplifier | Agilent | 8447D | 2944A10991 | 0.1MHz ~ 1.3GHz | Nov. 27, 2012 | Radiation (03CH01-CB) |
| Pre-Amplifier | Agilent | 8449B | 3008A02310 | 1GHz ~ 26.5GHz | Nov. 23, 2012 | Radiation (03CH01-CB) |
| Pre-Amplifier | WM | TF-130N-R1 | 923365 | 26.5GHz ~ 40GHz | Jul. 31, 2012 | Radiation (03CH01-CB) |
| Spectrum analyzer | R&S | FSP40 | 100056 | 9KHz-40GHz | Nov. 16, 2012 | Radiation (03CH01-CB) |
| EMI Test Receiver | R&S | ESCS 30 | 100355 | 9KHz ~ 2.75GHz | Apr. 15, 2013 | Radiation (03CH01-CB) |
| Turn Table | INN CO | CO 2000 | N/A | 0 ~ 360 degree | N.C.R | Radiation (03CH01-CB) |
| Antenna Mast | INN CO | CO2000 | N/A | 1 m - 4 m | N.C.R | Radiation (03CH01-CB) |
| RF Cable-low | Woken | Low Cable-1 | N/A | 30 MHz - 1 GHz | Nov. 18, 2012 | Radiation (03CH01-CB) |
| RF Cable-high | Woken | High Cable-1 | N/A | 1 GHz ~ 26.5 GHz | Nov. 18, 2012 | Radiation (03CH01-CB) |
| RF Cable-high | Woken | High Cable-2 | N/A | 1 GHz ~ 26.5 GHz | Nov. 18, 2012 | Radiation (03CH01-CB) |
| RF Cable-high | Woken | High Cable-3 | N/A | 1 GHz - 40 GHz | Nov. 18, 2012 | Radiation (03CH01-CB) |
| RF Cable-high | Woken | High Cable-4 | N/A | 1 GHz - 40 GHz | Nov. 18, 2012 | Radiation (03CH01-CB) |
| Signal analyzer | R&S | FSV40 | 100979 | 9KHz-40GHz | Oct. 08, 2012 | Conducted (TH01-CB) |
| Temp. and Humidity Chamber | Ten Billion | TTH-D3SP | TBN-931011 | -30~100 degree | Jun. 05, 2012 | Conducted (TH01-CB) |
| RF Power Divider | Woken | 2 Way | 0120A02056002D | 2GHz ~ 18GHz | Nov. 18, 2012 | Conducted (TH01-CB) |
| RF Power Divider | Woken | 3 Way | MDC2366 | 2GHz ~ 18GHz | Nov. 18, 2012 | Conducted (TH01-CB) |
| RF Power Divider | Woken | 4 Way | 0120A04056002D | 2GHz ~ 18GHz | Nov. 18, 2012 | Conducted (TH01-CB) |
| Signal generator | R&S | SMU200A | 102782 | 10MHz-40GHz | Sep. 26, 2012 | Conducted (TH01-CB) |
| Horn Antenna | COM-POWER | AH-118 | 071187 | 1GHz ~ 18GHz | May 09, 2013 | Conducted (TH01-CB) |
| Horn Antenna | COM-POWER | AH-118 | 071042 | 1GHz ~ 18GHz | Dec. 06, 2012 | Conducted (TH01-CB) |
| RF Cable-high | Woken | High Cable-7 | - | 1 GHz ~ 26.5 GHz | Nov. 19, 2012 | Conducted (TH01-CB) |

| Instrument | Manufacturer | Model No. | Serial No. | Characteristics | Calibration Date | Remark |
|---------------|--------------|---------------|------------|------------------|------------------|---------------------|
| RF Cable-high | Woken | High Cable-8 | - | 1 GHz – 26.5 GHz | Nov. 19, 2012 | Conducted (TH01-CB) |
| RF Cable-high | Woken | High Cable-9 | - | 1 GHz – 26.5 GHz | Nov. 19, 2012 | Conducted (TH01-CB) |
| RF Cable-high | Woken | High Cable-10 | - | 1 GHz – 26.5 GHz | Nov. 19, 2012 | Conducted (TH01-CB) |
| RF Cable-high | Woken | High Cable-11 | - | 1 GHz – 26.5 GHz | Nov. 19, 2012 | Conducted (TH01-CB) |
| Power Sensor | Anritsu | MA2411B | 0917223 | 300MHz-40GHz | Nov. 28, 2012 | Conducted (TH01-CB) |
| Power Meter | Anritsu | ML2495A | 1035008 | 300MHz-40GHz | Nov. 27, 2012 | Conducted (TH01-CB) |

Note: Calibration Interval of instruments listed above is one year.

“*” Calibration Interval of instruments listed above is two years.

N.C.R. means Non-Calibration required.

6. TEST LOCATION

| | |
|--------|--|
| SHIJR | ADD : 6Fl., No. 106, Sec. 1, Shintai 5th Rd., Shijr City, Taipei, Taiwan 221, R.O.C. TEL : 886-2-2696-2468 FAX : 886-2-2696-2255 |
| HWA YA | ADD : No. 52, Hwa Ya 1st Rd., Kwei-Shan Hsiang, Tao Yuan Hsien, Taiwan, R.O.C. TEL : 886-3-327-3456 FAX : 886-3-318-0055 |
| LINKOU | ADD : No. 30-2, Dingfu Tsuen, Linkou Shiang, Taipei, Taiwan 244, R.O.C TEL : 886-2-2601-1640 FAX : 886-2-2601-1695 |
| DUNGHU | ADD : No. 3, Lane 238, Kangle St., Neihu Chiu, Taipei, Taiwan 114, R.O.C. TEL : 886-2-2631-4739 FAX : 886-2-2631-9740 |
| JUNGHE | ADD : 7Fl., No. 758, Jungjeng Rd., Junghe City, Taipei, Taiwan 235, R.O.C. TEL : 886-2-8227-2020 FAX : 886-2-8227-2626 |
| NEIHU | ADD : 4Fl., No. 339, Hsin Hu 2 nd Rd., Taipei 114, Taiwan, R.O.C. TEL : 886-2-2794-8886 FAX : 886-2-2794-9777 |
| JHUBEI | ADD : No.8, Lane 724, Bo-ai St., Jhubei City, HsinChu County 302, Taiwan, R.O.C. TEL : 886-3-656-9065 FAX : 886-3-656-9085 |