



SPORTON International Inc.

No. 52, Hwa Ya 1st Rd., Hwa Ya Technology Park, Kwei-Shan Hsiang, Tao Yuan Hsien, Taiwan, R.O.C.
Ph: 886-3-327-3456 / FAX: 886-3-327-0973 / www.sporton.com.tw

FCC RADIO TEST REPORT

| | |
|------------------------|--|
| Applicant's company | Wistron NeWeb Corporation |
| Applicant Address | 20 Park Avenue II, Hsinchu Science Park, Hsinchu 308, Taiwan, R.O.C. |
| FCC ID | NKR-DHURW32 |
| Manufacturer's company | Wistron NeWeb Corporation |
| Manufacturer Address | 20 Park Avenue II, Hsinchu Science Park, Hsinchu 308, Taiwan, R.O.C. |

| | |
|-------------------|---|
| Product Name | 802.11 abgn + BT module |
| Brand Name | WNC |
| Model No. | DHUR-W32 |
| Test Rule Part(s) | 47 CFR FCC Part 15 Subpart E § 15.407 |
| Test Freq. Range | 5150 ~ 5350 MHz / 5470 ~ 5725 MHz / 5725 ~ 5850 MHz |
| Received Date | Jul. 13, 2016 |
| Final Test Date | Aug. 17, 2016 |
| Submission Type | Original Equipment |

Statement

Test result included is for the IEEE 802.11n and IEEE 802.11a of the product.

The test result in this report refers exclusively to the presented test model / sample.

Without written approval of SPORTON International Inc., the test report shall not be reproduced except in full.

The measurements and test results shown in this test report were made in accordance with the procedures and found in compliance with the limit given in ANSI C63.10-2013, 47 CFR FCC Part 15 Subpart E, KDB789033 D02 v01r03, KDB662911 D01 v02r01, ET Docket No. 13-49; FCC 16-24.

The test equipment used to perform the test is calibrated and traceable to NML/ROC.



Table of Contents

| | |
|---|----------------|
| 1. VERIFICATION OF COMPLIANCE | 1 |
| 2. SUMMARY OF THE TEST RESULT | 2 |
| 3. GENERAL INFORMATION | 3 |
| 3.1. Product Details..... | 3 |
| 3.2. Accessories..... | 5 |
| 3.3. Table for Filed Antenna..... | 5 |
| 3.4. Table for Carrier Frequencies | 6 |
| 3.5. Table for Test Modes | 7 |
| 3.6. Table for Testing Locations..... | 8 |
| 3.7. Table for Supporting Units | 9 |
| 3.8. Table for Parameters of Test Software Setting | 10 |
| 3.9. EUT Operation during Test | 10 |
| 3.10. Duty Cycle..... | 10 |
| 3.11. Test Configurations | 11 |
| 4. TEST RESULT | 14 |
| 4.1. AC Power Line Conducted Emissions Measurement..... | 14 |
| 4.2. 26dB Bandwidth and 99% Occupied Bandwidth Measurement..... | 18 |
| 4.3. 6dB Spectrum Bandwidth Measurement | 40 |
| 4.4. Maximum Conducted Output Power Measurement..... | 46 |
| 4.5. Power Spectral Density Measurement | 57 |
| 4.6. Radiated Emissions Measurement | 73 |
| 4.7. Band Edge Emissions Measurement | 116 |
| 4.8. Frequency Stability Measurement | 157 |
| 4.9. Antenna Requirements | 166 |
| 5. LIST OF MEASURING EQUIPMENTS | 167 |
| 6. MEASUREMENT UNCERTAINTY..... | 168 |
| APPENDIX A. TEST PHOTOS | A1 ~ A7 |
| APPENDIX B. RADIATED EMISSION CO-LOCATION REPORT..... | B1 ~ B5 |



History of This Test Report

| REPORT NO. | VERSION | DESCRIPTION | ISSUED DATE |
|------------|---------|-------------------------|---------------|
| FR671331AB | Rev. 01 | Initial issue of report | Sep. 12, 2017 |
| | | | |
| | | | |
| | | | |
| | | | |
| | | | |
| | | | |
| | | | |
| | | | |
| | | | |
| | | | |
| | | | |
| | | | |
| | | | |
| | | | |



1. VERIFICATION OF COMPLIANCE

Product Name : 802.11 abgn + BT module
Brand Name : WNC
Model No. : DHUR-W32
Applicant : Wistron NeWeb Corporation
Test Rule Part(s) : 47 CFR FCC Part 15 Subpart E § 15.407

Sporton International as requested by the applicant to evaluate the EMC performance of the product sample received on Jul. 13, 2016 would like to declare that the tested sample has been evaluated and found to be in compliance with the tested rule parts. The data recorded as well as the test configuration specified is true and accurate for showing the sample's EMC nature.

A handwritten signature in black ink, appearing to read 'Cliff Chang', is written over a horizontal line.

Cliff Chang

SPORTON INTERNATIONAL INC.

2. SUMMARY OF THE TEST RESULT

| Applied Standard: 47 CFR FCC Part 15 Subpart E | | | |
|--|--------------|--|----------|
| Part | Rule Section | Description of Test | Result |
| 4.1 | 15.207 | AC Power Line Conducted Emissions | Complies |
| 4.2 | 15.407(a) | 26dB Spectrum Bandwidth and 99% Occupied Bandwidth | Complies |
| 4.3 | 15.407(e) | 6dB Spectrum Bandwidth | Complies |
| 4.4 | 15.407(a) | Maximum Conducted Output Power | Complies |
| 4.5 | 15.407(a) | Power Spectral Density | Complies |
| 4.6 | 15.407(b) | Radiated Emissions | Complies |
| 4.7 | 15.407(b) | Band Edge Emissions | Complies |
| 4.8 | 15.407(g) | Frequency Stability | Complies |
| 4.9 | 15.203 | Antenna Requirements | Complies |

3. GENERAL INFORMATION

3.1. Product Details

| Items | Description |
|-------------------------|--|
| Product Type | WLAN (2TX, 2RX) |
| Radio Type | Intentional Transceiver |
| Power Type | From host system |
| Modulation | IEEE 802.11a: OFDM IEEE 802.11n: see the below table |
| Data Modulation | IEEE 802.11a/n: OFDM (BPSK / QPSK / 16QAM / 64QAM) |
| Data Rate (Mbps) | IEEE 802.11a: OFDM (6/9/12/18/24/36/48/54) IEEE 802.11n: see the below table |
| Frequency Range | 5150 ~ 5350 MHz / 5470 ~ 5725 MHz / 5725 ~ 5850 MHz |
| Channel Number | 25 for 20MHz bandwidth ; 12 for 40MHz bandwidth |
| Channel Bandwidth (99%) | Band 1: IEEE 802.11a: 18.41 MHz IEEE 802.11n MCS0 (HT20): 17.89 MHz IEEE 802.11n MCS0 (HT40): 37.34 MHz Band 2: IEEE 802.11a: 17.19 MHz IEEE 802.11n MCS0 (HT20): 18.06 MHz IEEE 802.11n MCS0 (HT40): 39.22 MHz Band 3: IEEE 802.11a: 24.49 MHz IEEE 802.11n MCS0 (HT20): 19.28 MHz IEEE 802.11n MCS0 (HT40): 36.76 MHz Band 4: IEEE 802.11a: 28.65 MHz IEEE 802.11n MCS0 (HT20): 26.05 MHz IEEE 802.11n MCS0 (HT40): 36.90 MHz |

| | |
|--------------------------------|--|
| Maximum Conducted Output Power | Band 1: IEEE 802.11a: 21.47 dBm IEEE 802.11n MCS0 (HT20): 21.56 dBm IEEE 802.11n MCS0 (HT40): 21.77 dBm Band 2: IEEE 802.11a: 21.48 dBm IEEE 802.11n MCS0 (HT20): 21.52 dBm IEEE 802.11n MCS0 (HT40): 21.96 dBm Band 3: IEEE 802.11a: 21.41 dBm IEEE 802.11n MCS0 (HT20): 21.45 dBm IEEE 802.11n MCS0 (HT40): 23.45 dBm Band 4: IEEE 802.11a: 22.44 dBm IEEE 802.11n MCS0 (HT20): 22.89 dBm IEEE 802.11n MCS0 (HT40): 22.04 dBm |
| Carrier Frequencies | Please refer to section 3.4 |
| Antenna | Please refer to section 3.3 |

| Items | Description | |
|-----------------------------|---|---|
| Communication Mode | <input checked="" type="checkbox"/> IP Based (Load Based) | <input type="checkbox"/> Frame Based |
| TPC Function | <input checked="" type="checkbox"/> With TPC | <input type="checkbox"/> Without TPC |
| Weather Band (5600~5650MHz) | <input checked="" type="checkbox"/> With 5600~5650MHz | <input type="checkbox"/> Without 5600~5650MHz |
| Beamforming Function | <input type="checkbox"/> With beamforming | <input checked="" type="checkbox"/> Without beamforming |
| Operate Condition | <input checked="" type="checkbox"/> Indoor | <input type="checkbox"/> Outdoor |

Antenna and Bandwidth

| Antenna | Two (TX) | |
|----------------|----------|--------|
| Bandwidth Mode | 20 MHz | 40 MHz |
| IEEE 802.11a | V | X |
| IEEE 802.11n | V | V |

IEEE 11n Spec.

| Protocol | Number of Transmit Chains (NTX) | Data Rate / MCS |
|----------------|---------------------------------|-----------------|
| 802.11n (HT20) | 2 | MCS0-15 |
| 802.11n (HT40) | 2 | MCS0-15 |

Note 1: IEEE Std. 802.11n modulation consists of HT20 and HT40 (HT: High Throughput).
Then EUT supports HT20 and HT40.

Note 2: Modulation modes consist of below configuration: HT20/HT40: IEEE 802.11n

3.2. Accessories

N/A

3.3. Table for Filed Antenna

| Ant. | Brand | Part Number | Antenna Type | Connector | Gain (dBi) | |
|------|-------|-----------------|--------------|-----------|-------------|-----------|
| | | | | | WLAN 2.4GHz | WLAN 5GHz |
| 1 | WNC | 3ADHUBW69S2-111 | PIFA Antenna | N/A | 2.04 | 4.95 |
| 2 | WNC | 3ADHUAW08S1-111 | PIFA Antenna | N/A | 2.37 | 6.52 |
| Ant. | Brand | Part Number | Antenna Type | Connector | Gain (dBi) | |
| | | | | | Bluetooth | |
| 3 | WNC | 81.EEW15.GM3 | PIFA Antenna | I-PEX | -1.39 | |
| 4 | WNC | 81.EEW15.GM4 | PIFA Antenna | I-PEX | -1.99 | |

Note: The EUT has four antennas.

For WLAN function (2TX/2RX):

Ant. 1 and Ant. 2 can be used as transmitting/receiving antenna.

Ant. 1 and Ant. 2 could transmit/receive simultaneously.

For Bluetooth function (1TX/1RX):

Because Ant. 3 and Ant. 4 are the same type antennas, only the higher gain antenna "Ant. 3" was tested and recorded in the report.



3.4. Table for Carrier Frequencies

The EUT has two bandwidth system.

For 20MHz bandwidth systems, use Channel 36, 40, 44, 48, 52, 56, 60, 64, 100, 104, 108, 112, 116, 120, 124, 128, 132, 136, 140, 144, 149, 153, 157, 161, 165.

For 40MHz bandwidth systems, use Channel 38, 46, 54, 62, 102, 110, 118, 126, 134, 142, 151, 159.

| Frequency Band | Channel No. | Frequency | Channel No. | Frequency |
|-------------------------|-------------|-----------|-------------|-----------|
| 5150~5250 MHz Band 1 | 36 | 5180 MHz | 44 | 5220 MHz |
| | 38 | 5190 MHz | 46 | 5230 MHz |
| | 40 | 5200 MHz | 48 | 5240 MHz |
| 5250~5350 MHz Band 2 | 52 | 5260 MHz | 60 | 5300 MHz |
| | 54 | 5270 MHz | 62 | 5310 MHz |
| | 56 | 5280 MHz | 64 | 5320 MHz |
| 5470~5725 MHz Band 3 | 100 | 5500 MHz | 124 | 5620 MHz |
| | 102 | 5510 MHz | 126 | 5630 MHz |
| | 104 | 5520 MHz | 128 | 5640 MHz |
| | 108 | 5540 MHz | 132 | 5660 MHz |
| | 110 | 5550 MHz | 134 | 5670 MHz |
| | 112 | 5560 MHz | 136 | 5680 MHz |
| | 116 | 5580 MHz | 140 | 5700 MHz |
| | 118 | 5590 MHz | 142 | 5710 MHz |
| | 120 | 5600 MHz | 144 | 5720 MHz |
| 5725~5850 MHz Band 4 | 149 | 5745 MHz | 159 | 5795 MHz |
| | 151 | 5755 MHz | 161 | 5805 MHz |
| | 153 | 5765 MHz | 165 | 5825 MHz |
| | 157 | 5785 MHz | - | - |

3.5. Table for Test Modes

Preliminary tests were performed in different data rate to find the worst radiated emission. The data rate shown in the table below is the worst-case rate with respect to the specific test item. Investigation has been done on all the possible configurations for searching the worst cases. The following table is a list of the test modes shown in this test report.

| Test Items | Mode | | Data Rate | Channel | Ant. |
|--|-------------|----------|-----------|---|------|
| AC Power Conducted Emission | Normal Link | | - | - | - |
| Max. Conducted Output Power | 11a/BPSK | Band 1-4 | 6Mbps | 36/40/48/52/60/64/100/116 /140/144/149/157/165 | 1+2 |
| | 11n HT20 | Band 1-4 | MCS0 | 36/40/48/52/60/64/100/116 /140/144/149/157/165 | 1+2 |
| | 11n HT40 | Band 1-4 | MCS0 | 38/46/54/62/102/110/134/ 142/151/159 | 1+2 |
| Power Spectral Density | 11a/BPSK | Band 1-4 | 6Mbps | 36/40/48/52/60/64/100/116 /140/144/149/157/165 | 1+2 |
| | 11n HT20 | Band 1-4 | MCS0 | 36/40/48/52/60/64/100/116 /140/144/149/157/165 | 1+2 |
| | 11n HT40 | Band 1-4 | MCS0 | 38/46/54/62/102/110/134/ 142/151/159 | 1+2 |
| 26dB Spectrum Bandwidth & 99% Occupied Bandwidth Measurement | 11a/BPSK | Band 1-4 | 6Mbps | 36/40/48/52/60/64/100/116 /140/144/149/157/165 | 1+2 |
| | 11n HT20 | Band 1-4 | MCS0 | 36/40/48/52/60/64/100/116 /140/144/149/157/165 | 1+2 |
| | 11n HT40 | Band 1-4 | MCS0 | 38/46/54/62/102/110/134/ 142/151/159 | 1+2 |
| 6dB Spectrum Bandwidth Measurement | 11a/BPSK | Band 4 | 6Mbps | 144/149/157/165 | 1+2 |
| | 11n HT20 | Band 4 | MCS0 | 144/149/157/165 | 1+2 |
| | 11n HT40 | Band 4 | MCS0 | 142/151/159 | 1+2 |
| Radiated Emission Below 1GHz | Normal Link | | - | - | - |
| Radiated Emission Above 1GHz | 11a/BPSK | Band 1-4 | 6Mbps | 36/40/48/52/60/64/100/116 /140/144/149/157/165 | 1+2 |
| | 11n HT20 | Band 1-4 | MCS0 | 36/40/48/52/60/64/100/116 /140/144/149/157/165 | 1+2 |
| | 11n HT40 | Band 1-4 | MCS0 | 38/46/54/62/102/110/134/ 142/151/159 | 1+2 |
| Band Edge Emission | 11a/BPSK | Band 1-4 | 6Mbps | 36/40/48/52/60/64/100/116 /140/144/149/157/165 | 1+2 |
| | 11n HT20 | Band 1-4 | MCS0 | 36/40/48/52/60/64/100/116 /140/144/149/157/165 | 1+2 |
| | 11n HT40 | Band 1-4 | MCS0 | 38/46/54/62/102/110/134/ 142/151/159 | 1+2 |

| | | | | | |
|---------------------|--------|----------|---|---------------|---|
| Frequency Stability | 20 MHz | Band 1-4 | - | 40/60/116/157 | 1 |
| | 40 MHz | Band 1-4 | - | 38/62/110/151 | 1 |

The following test modes were performed for all tests:

For AC Power Line Conducted Emissions test:

Mode 1. 2.4GHz WLAN function + Bluetooth function

Mode 2. 5GHz WLAN function + Bluetooth function

Mode 1 is the worst case, so it was selected to record in this test report.

For Radiated Emissions below 1GHz test:

Mode 1. EUT Y axis - 2.4GHz WLAN function + Bluetooth function

Mode 2. EUT Z axis - 2.4GHz WLAN function + Bluetooth function

Mode 1 has been evaluated to be the worst case among Mode 1~2, thus measurement for Mode 3 will follow this same test mode.

Mode 3. EUT Y axis - 5GHz WLAN function + Bluetooth function

Mode 1 is the worst case, so it was selected to record in this test report.

For Radiated Emissions above 1GHz test:

The EUT was performed at X axis, Y axis and Z axis position for Radiated Emissions above 1GHz test, and the worst case was found at X axis. So the measurement will follow this same test configuration.

For Radiated Emission Co-location test:

Mode 1. EUT Y axis - 2.4GHz WLAN function + Bluetooth function

Mode 2. EUT Z axis - 2.4GHz WLAN function + Bluetooth function

Mode 3. EUT Y axis - 5GHz WLAN function + Bluetooth function

Mode 4. EUT Z axis - 5GHz WLAN function + Bluetooth function

Mode 2 and Mode 4 are worst test result among Mode 1~4, and the test result of those two modes are selected to record in the test report.

For Co-location MPE and Radiated Emission Co-location test:

The EUT could be applied with 2.4GHz WLAN function, 5GHz WLAN function and Bluetooth function; therefore Co-location Maximum Permissible Exposure (Please refer to FA671331) and Radiated Emission Co-location (please refer to Appendix B) tests are added for simultaneously transmit between 2.4GHz WLAN function, 5GHz WLAN function and Bluetooth function.

3.6. Table for Testing Locations

| Test Site Location | | | | | |
|--------------------|--|----------|---------------------|-------------|--------------|
| Address: | No.8, Lane 724, Bo-ai St., Jhubei City, Hsinchu County 302, Taiwan, R.O.C. | | | | |
| TEL: | 886-3-656-9065 | | | | |
| FAX: | 886-3-656-9085 | | | | |
| Test Site No. | Site Category | Location | FCC Designation No. | IC File No. | VCCI Reg. No |
| 03CH01-CB | SAC | Hsin Chu | TW0006 | IC 4086D | - |
| CO02-CB | Conduction | Hsin Chu | TW0006 | IC 4086D | - |
| TH01-CB | OVEN Room | Hsin Chu | - | - | - |

Open Area Test Site (OATS); Semi Anechoic Chamber (SAC).

3.7. Table for Supporting Units

For Test Site No: 03CH01-CB (below 1GHz)

| Support Unit | Brand | Model | FCC ID |
|---------------|---------------|-----------|-------------|
| WLAN AP | Netgear | R7500 | PY314300288 |
| Earphone | e-Power | S90W | N/A |
| NB | DELL | E4300 | DoC |
| Mouse | Logitech | M-U0026 | DoC |
| BT Speaker | MARUS | MSK06C-RD | DoC |
| Flash disk3.0 | Silicon Power | B06 | DoC |

For Test Site No: 03CH01-CB (above1GHz) and TH01-CB

| Support Unit | Brand | Model | FCC ID |
|--------------|-------|-------|--------|
| NB | DELL | E4300 | DoC |

For Test Site No: CO02-CB

| Support Unit | Brand | Model | FCC ID |
|---------------|------------|------------|------------------|
| AP Router | Planex | GW-AP54SGX | KA220030603014-1 |
| NB | DELL | E4300 | DoC |
| Earphone | SHYARO CHI | MIC-04 | DoC |
| Flash disk3.0 | ADATA | C103 | DoC |
| BT Speaker | MARUS | MSK06C-RD | DoC |

3.8. Table for Parameters of Test Software Setting

During testing, Channel and Power Controlling Software provided by the customer was used to control the operating channel as well as the output power level. The RF output power selection is for the setting of RF output power expected by the customer and is going to be fixed on the firmware of the final end product.

| Test Software Version | MT7662UQA V1.0.3.14 | | | | | | | | | | | | |
|-----------------------|----------------------|-------------|-------------|-------------|-------------|-------------|-------------|-------------|-------------|-------------|-------------|-------------|-------------|
| Mode | Test Frequency (MHz) | | | | | | | | | | | | |
| | NCB: 20MHz | | | | | | | | | | | | |
| | 5180 MHz | 5200 MHz | 5240 MHz | 5260 MHz | 5300 MHz | 5320 MHz | 5500 MHz | 5580 MHz | 5700 MHz | 5720 MHz | 5745 MHz | 5785 MHz | 5825 MHz |
| 802.11a | 33/2E | 3D/38 | 2D/2F | 3C/3B | 3C/3B | 2E/2F | 2A/2F | 27/3C | 28/25 | 23/2D | 35/3F | 35/3F | 3F/3F |
| 802.11n MCS0 HT20 | 32/2E | 3C/38 | 2F/2E | 3C/3B | 3C/3E | 30/34 | 2D/31 | 36/3C | 23/2D | 23/2D | 37/3F | 39/3F | 38/3F |
| Mode | NCB: 40MHz | | | | | | | | | | | | |
| 802.11n MCS0 HT40 | 5190 MHz | 5230 MHz | 5270 MHz | 5310 MHz | 5510 MHz | 5550 MHz | 5670 MHz | 5710 MHz | 5755 MHz | 5795 MHz | | | |
| | 26/23 | 30/2E | 34/34 | 22/23 | 1B/1E | 2D/2F | 25/2B | 33/3A | 30/37 | 3B/3F | | | |

3.9. EUT Operation during Test

The EUT was programmed to be in continuously transmitting mode.

3.10. Duty Cycle

| Mode | On Time (ms) | On+Off Time (ms) | Duty Cycle (%) | Duty Factor (dB) | 1/T Minimum VBW (kHz) |
|-------------------|-----------------|---------------------|-------------------|---------------------|--------------------------|
| 802.11a | 1.440 | 1.458 | 98.77 | 0.05 | 0.01 |
| 802.11n MCS0 HT20 | 1.350 | 1.362 | 99.12 | 0.04 | 0.01 |
| 802.11n MCS0 HT40 | 0.640 | 0.680 | 94.12 | 0.26 | 1.56 |

3.11. Test Configurations

3.11.1. AC Power Line Conduction Emissions Test Configuration

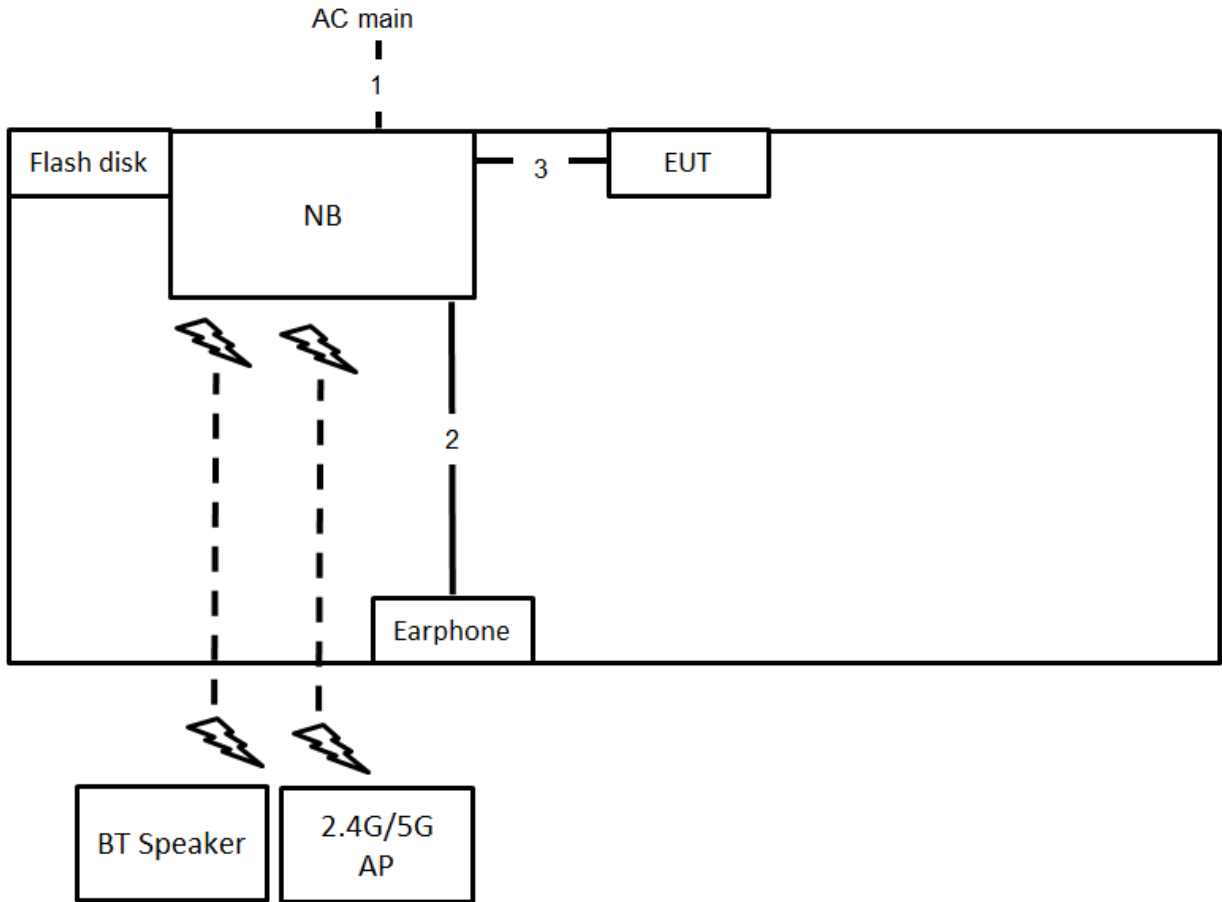

| Item | Connection | Shielded | Length |
|------|-------------|----------|--------|
| 1 | Power cable | No | 2.6m |
| 2 | Audio cable | No | 1.1m |
| 3 | USB cable | No | 0.7m |

3.11.2. Radiation Emissions Test Configuration

Test Configuration: 30MHz~1GHz

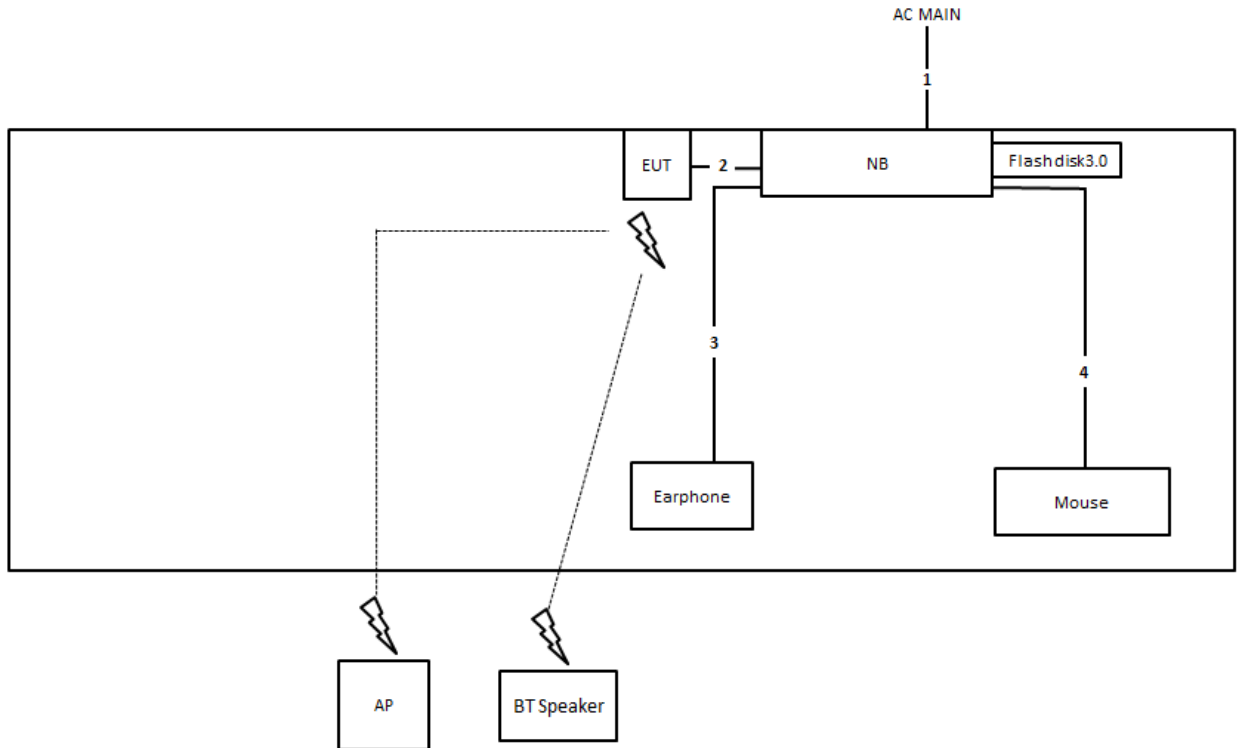

| Item | Connection | Shielded | Length |
|------|-------------|----------|--------|
| 1 | Power cable | No | 1.5m |
| 2 | USB cable | Yes | 0.1m |
| 3 | Audio cable | No | 1.4m |
| 4 | USB cable | Yes | 1.8m |

Test Configuration: above 1GHz

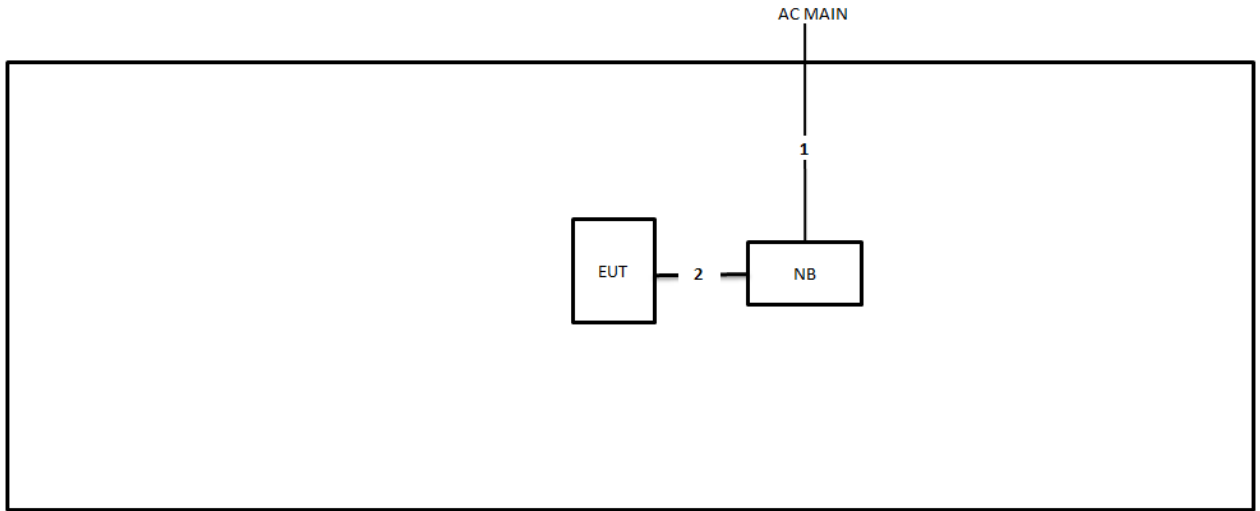

| Item | Connection | Shielded | Length |
|------|-------------|----------|--------|
| 1 | Power cable | No | 1.5m |
| 2 | USB cable | Yes | 0.1m |

4. TEST RESULT

4.1. AC Power Line Conducted Emissions Measurement

4.1.1. Limit

For this product that is designed to connect to the AC power line, the radio frequency voltage that is conducted back onto the AC power line on any frequency or frequencies within the band 150 kHz to 30 MHz shall not exceed below limits table.

| Frequency (MHz) | QP Limit (dBuV) | AV Limit (dBuV) |
|-----------------|-----------------|-----------------|
| 0.15~0.5 | 66~56 | 56~46 |
| 0.5~5 | 56 | 46 |
| 5~30 | 60 | 50 |

4.1.2. Measuring Instruments and Setting

Please refer to section 5 of equipments list in this report. The following table is the setting of the receiver.

| Receiver Parameters | Setting |
|---------------------|----------|
| Attenuation | 10 dB |
| Start Frequency | 0.15 MHz |
| Stop Frequency | 30 MHz |
| IF Bandwidth | 9 kHz |

4.1.3. Test Procedures

1. Configure the EUT according to ANSI C63.10. The EUT or host of EUT has to be placed 0.4 meter far from the conducting wall of the shielding room and at least 80 centimeters from any other grounded conducting surface.
2. Connect EUT or host of EUT to the power mains through a line impedance stabilization network (LISN).
3. All the support units are connected to the other LISNs. The LISN should provide 50uH/50ohms coupling impedance.
4. The frequency range from 150 kHz to 30 MHz was searched.
5. Set the test-receiver system to Peak Detect Function and Specified Bandwidth with Maximum Hold Mode.
6. The measurement has to be done between each power line and ground at the power terminal.

4.1.4. Test Setup Layout

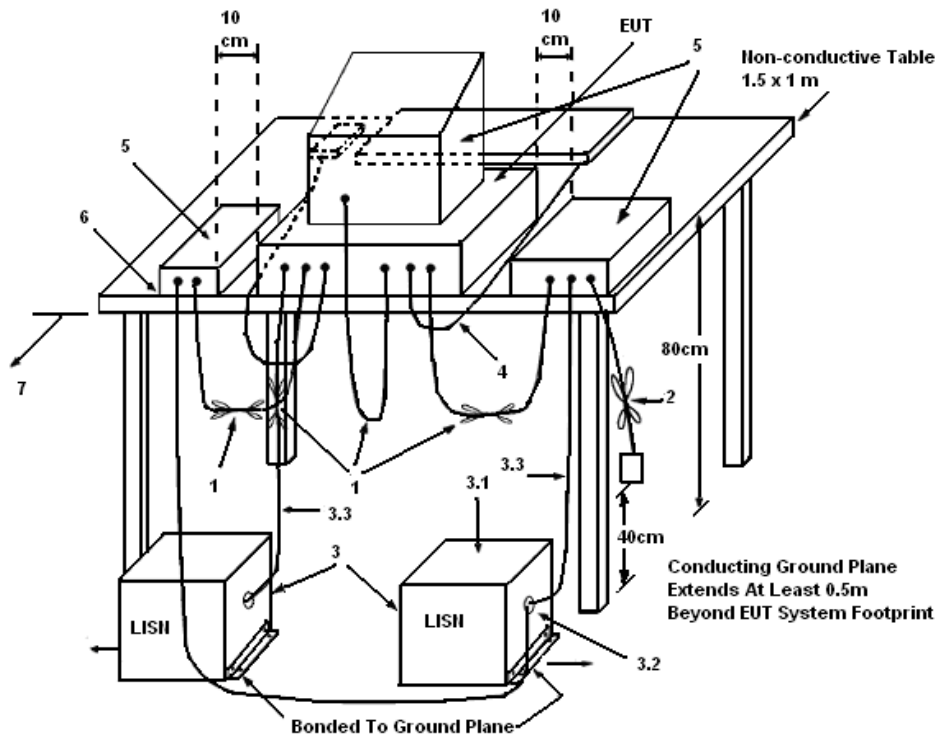

LEGEND:

- (1) Interconnecting cables that hang closer than 40 cm to the ground plane shall be folded back and forth in the center forming a bundle 30 to 40 cm long.
- (2) I/O cables that are not connected to a peripheral shall be bundled in the center. The end of the cable may be terminated, if required, using the correct terminating impedance. The overall length shall not exceed 1 m.
- (3) EUT connected to one LISN. Unused LISN measuring port connectors shall be terminated in 50 Ω . LISN can be placed on top of, or immediately beneath, reference ground plane.
 - (3.1) All other equipment powered from additional LISN(s).
 - (3.2) Multiple outlet strip can be used for multiple power cords of non-EUT equipment.
 - (3.3) LISN at least 80 cm from nearest part of EUT chassis.
- (4) Cables of hand-operated devices, such as keyboards, mice, etc., shall be placed as for normal use.
- (5) Non-EUT components of EUT system being tested.
- (6) Rear of EUT, including peripherals, shall all be aligned and flush with rear of tabletop.
- (7) Rear of tabletop shall be 40 cm removed from a vertical conducting plane that is bonded to the ground plane.

4.1.5. Test Deviation

There is no deviation with the original standard.

4.1.6. EUT Operation during Test

The EUT was placed on the test table and programmed in normal function.

4.1.7. Results of AC Power Line Conducted Emissions Measurement

| | | | |
|---------------|-------------|-----------|--------|
| Temperature | 23°C | Humidity | 62% |
| Test Engineer | Ryo Fan | Phase | Line |
| Configuration | Normal Link | Test Mode | Mode 1 |

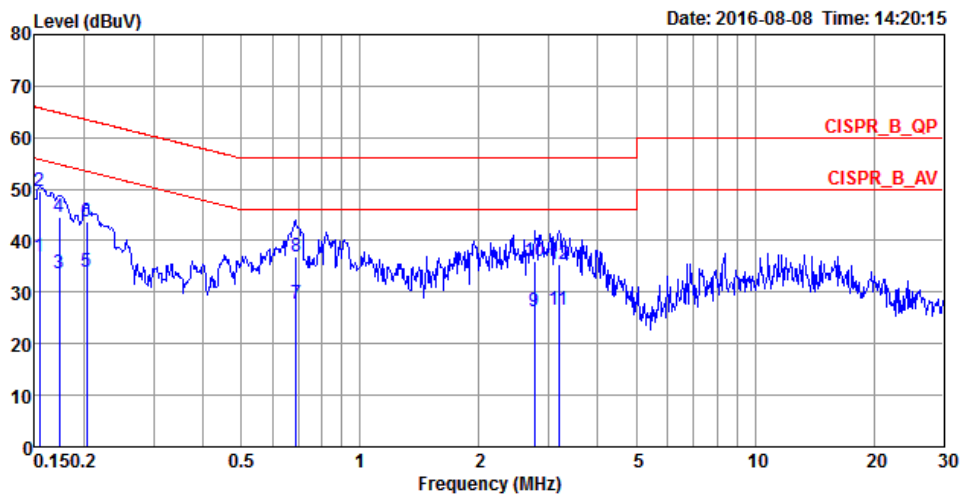

| | Freq | Level | Over Limit | Limit Line | Read Level | LISN Factor | Cable Loss | Remark | Pol/Phase |
|----|--------|-------|------------|------------|------------|-------------|------------|---------|-----------|
| | MHz | dBuV | dB | dBuV | dBuV | dB | dB | | |
| 1 | 0.1540 | 36.95 | -18.83 | 55.78 | 26.83 | 9.96 | 0.16 | Average | LINE |
| 2 | 0.1540 | 49.58 | -16.20 | 65.78 | 39.46 | 9.96 | 0.16 | QP | LINE |
| 3 | 0.1731 | 33.74 | -21.07 | 54.81 | 23.62 | 9.96 | 0.16 | Average | LINE |
| 4 | 0.1731 | 44.63 | -20.18 | 64.81 | 34.51 | 9.96 | 0.16 | QP | LINE |
| 5 | 0.2029 | 34.04 | -19.45 | 53.49 | 23.91 | 9.95 | 0.18 | Average | LINE |
| 6 | 0.2029 | 43.67 | -19.82 | 63.49 | 33.54 | 9.95 | 0.18 | QP | LINE |
| 7 | 0.6893 | 27.64 | -18.36 | 46.00 | 17.42 | 10.03 | 0.19 | Average | LINE |
| 8 | 0.6893 | 36.95 | -19.05 | 56.00 | 26.73 | 10.03 | 0.19 | QP | LINE |
| 9 | 2.7648 | 26.32 | -19.68 | 46.00 | 15.94 | 10.09 | 0.29 | Average | LINE |
| 10 | 2.7648 | 35.90 | -20.10 | 56.00 | 25.52 | 10.09 | 0.29 | QP | LINE |
| 11 | 3.1900 | 26.64 | -19.36 | 46.00 | 16.24 | 10.10 | 0.30 | Average | LINE |
| 12 | 3.1900 | 35.45 | -20.55 | 56.00 | 25.05 | 10.10 | 0.30 | QP | LINE |

| | | | |
|---------------|-------------|-----------|---------|
| Temperature | 23°C | Humidity | 62% |
| Test Engineer | Ryo Fan | Phase | Neutral |
| Configuration | Normal Link | Test Mode | Mode 1 |

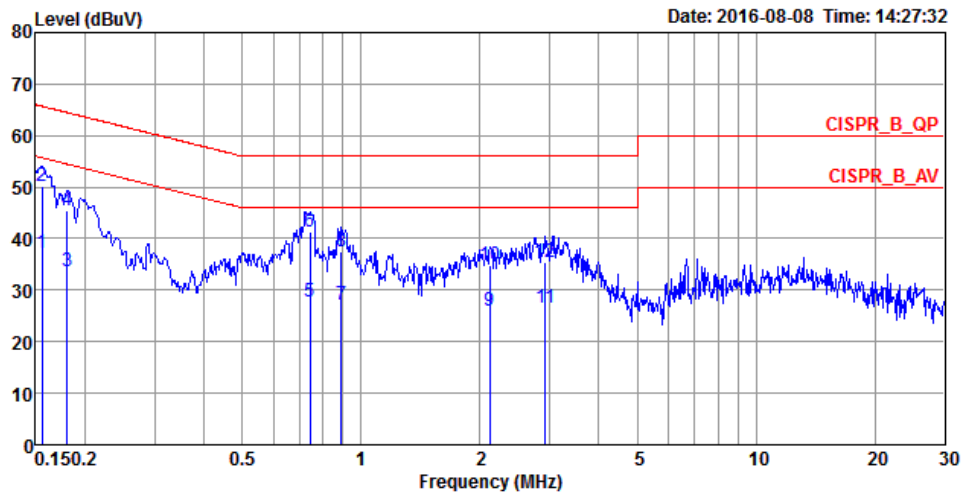

| | Freq | Level | Over Limit | Limit Line | Read Level | LISN Factor | Cable Loss | Remark | Pol/Phase |
|----|--------|-------|------------|------------|------------|-------------|------------|---------|-----------|
| | MHz | dBuV | dB | dBuV | dBuV | dB | dB | | |
| 1 | 0.1557 | 37.29 | -18.40 | 55.69 | 27.17 | 9.96 | 0.16 | Average | NEUTRAL |
| 2 | 0.1557 | 50.20 | -15.49 | 65.69 | 40.08 | 9.96 | 0.16 | QP | NEUTRAL |
| 3 | 0.1806 | 33.79 | -20.67 | 54.46 | 23.65 | 9.96 | 0.18 | Average | NEUTRAL |
| 4 | 0.1806 | 45.46 | -19.00 | 64.46 | 35.32 | 9.96 | 0.18 | QP | NEUTRAL |
| 5 | 0.7430 | 27.82 | -18.18 | 46.00 | 17.66 | 9.97 | 0.19 | Average | NEUTRAL |
| 6 | 0.7430 | 41.23 | -14.77 | 56.00 | 31.07 | 9.97 | 0.19 | QP | NEUTRAL |
| 7 | 0.8897 | 27.25 | -18.75 | 46.00 | 17.09 | 9.97 | 0.19 | Average | NEUTRAL |
| 8 | 0.8897 | 37.53 | -18.47 | 56.00 | 27.37 | 9.97 | 0.19 | QP | NEUTRAL |
| 9 | 2.1213 | 25.91 | -20.09 | 46.00 | 15.66 | 9.99 | 0.26 | Average | NEUTRAL |
| 10 | 2.1213 | 34.84 | -21.16 | 56.00 | 24.59 | 9.99 | 0.26 | QP | NEUTRAL |
| 11 | 2.9307 | 26.67 | -19.33 | 46.00 | 16.37 | 10.01 | 0.29 | Average | NEUTRAL |
| 12 | 2.9307 | 35.55 | -20.45 | 56.00 | 25.25 | 10.01 | 0.29 | QP | NEUTRAL |

Note:

Level = Read Level + LISN Factor + Cable Loss.

4.2. 26dB Bandwidth and 99% Occupied Bandwidth Measurement

4.2.1. Limit

No restriction limits.

4.2.2. Measuring Instruments and Setting

Please refer to section 5 of equipments list in this report. The following table is the setting of the spectrum analyzer.

| 26dB Bandwidth | |
|------------------------|--|
| Spectrum Parameters | Setting |
| Attenuation | Auto |
| Span Frequency | > 26dB Bandwidth |
| RBW | Approximately 1% of the emission bandwidth |
| VBW | VBW > RBW |
| Detector | Peak |
| Trace | Max Hold |
| Sweep Time | Auto |
| 99% Occupied Bandwidth | |
| Spectrum Parameters | Setting |
| Span | 1.5 times to 5.0 times the OBW |
| RBW | 1 % to 5 % of the OBW |
| VBW | $\geq 3 \times \text{RBW}$ |
| Detector | Peak |
| Trace | Max Hold |

4.2.3. Test Procedures

For Radiated 26dB Bandwidth and 99% Occupied Bandwidth Measurement:

1. The transmitter was radiated to the spectrum analyzer in peak hold mode.
2. Measure the maximum width of the emission that is 26 dB down from the peak of the emission. Compare this with the RBW setting of the analyzer. Readjust RBW and repeat measurement as needed until the RBW/EBW ratio is approximately 1%.

4.2.4. Test Setup Layout

For Radiated 26dB Bandwidth and 99% Occupied Bandwidth Measurement:

This test setup layout is the same as that shown in section 4.6.4.

4.2.5. Test Deviation

There is no deviation with the original standard.

4.2.6. EUT Operation during Test

The EUT was programmed to be in continuously transmitting mode.

4.2.7. Test Result of 26dB Bandwidth and 99% Occupied Bandwidth

| | | | |
|---------------|----------|----------|-----|
| Temperature | 25°C | Humidity | 56% |
| Test Engineer | Gary Chu | | |

| Mode | Frequency | 26dB Bandwidth (MHz) | 99% Occupied Bandwidth (MHz) |
|-------------------|-----------|----------------------|------------------------------|
| 802.11a | 5180 MHz | 36.44 | 18.41 |
| | 5200 MHz | 29.83 | 17.11 |
| | 5240 MHz | 33.57 | 18.41 |
| | 5260 MHz | 30.44 | 17.02 |
| | 5300 MHz | 22.44 | 16.85 |
| | 5320 MHz | 27.39 | 17.19 |
| | 5500 MHz | 29.30 | 16.93 |
| | 5580 MHz | 39.57 | 24.49 |
| | 5700 MHz | 30.00 | 17.28 |
| | 5745 MHz | 42.44 | 26.83 |
| | 5785 MHz | 40.35 | 26.05 |
| | 5825 MHz | 43.30 | 28.65 |
| 802.11n MCS0 HT20 | 5180 MHz | 24.70 | 17.80 |
| | 5200 MHz | 26.78 | 17.89 |
| | 5240 MHz | 25.57 | 17.89 |
| | 5260 MHz | 32.17 | 18.06 |
| | 5300 MHz | 21.74 | 17.89 |
| | 5320 MHz | 28.87 | 17.97 |
| | 5500 MHz | 24.70 | 17.89 |
| | 5580 MHz | 25.39 | 17.97 |
| | 5700 MHz | 36.87 | 19.28 |
| | 5745 MHz | 34.78 | 18.41 |
| | 5785 MHz | 42.35 | 26.05 |
| | 5825 MHz | 34.96 | 18.41 |
| 802.11n MCS0 HT40 | 5190 MHz | 41.30 | 36.61 |
| | 5230 MHz | 70.87 | 37.34 |
| | 5270 MHz | 80.29 | 39.22 |
| | 5310 MHz | 41.88 | 36.32 |
| | 5510 MHz | 41.74 | 36.32 |
| | 5550 MHz | 56.96 | 36.76 |
| | 5670 MHz | 59.42 | 36.76 |
| | 5755 MHz | 57.97 | 36.90 |
| | 5795 MHz | 56.52 | 36.90 |

Straddle Channel

| Mode | Frequency | 26dB BW (MHz) | 99% OBW (MHz) | 26dB BW F1 (MHz) | 99% OBW T1 (MHz) | UNII 2C 26dB BW (MHz) | UNII 3 26dB BW (MHz) | UNII 2C 99% BW (MHz) | UNII 3 99% BW (MHz) |
|-------------------|-----------|---------------------|---------------------|------------------------|------------------------|--------------------------------|-------------------------------|----------------------------|---------------------------|
| 802.11a | 5720 MHz | 42.96 | 28.39 | 5698.09 | 5705.76 | 26.91 | 16.04 | 19.24 | 9.15 |
| 802.11n MCS0 HT20 | 5720 MHz | 46.52 | 29.96 | 5696.52 | 5705.15 | 28.48 | 18.04 | 19.85 | 10.11 |
| 802.11n MCS0 HT40 | 5710 MHz | 49.13 | 36.76 | 5685.07 | 5691.77 | 39.93 | 9.20 | 33.23 | 3.52 |

26dB Bandwidth and 99% Occupied Bandwidth Plot on Configuration IEEE 802.11a / Ant. 1 + Ant. 2 / 5180 MHz

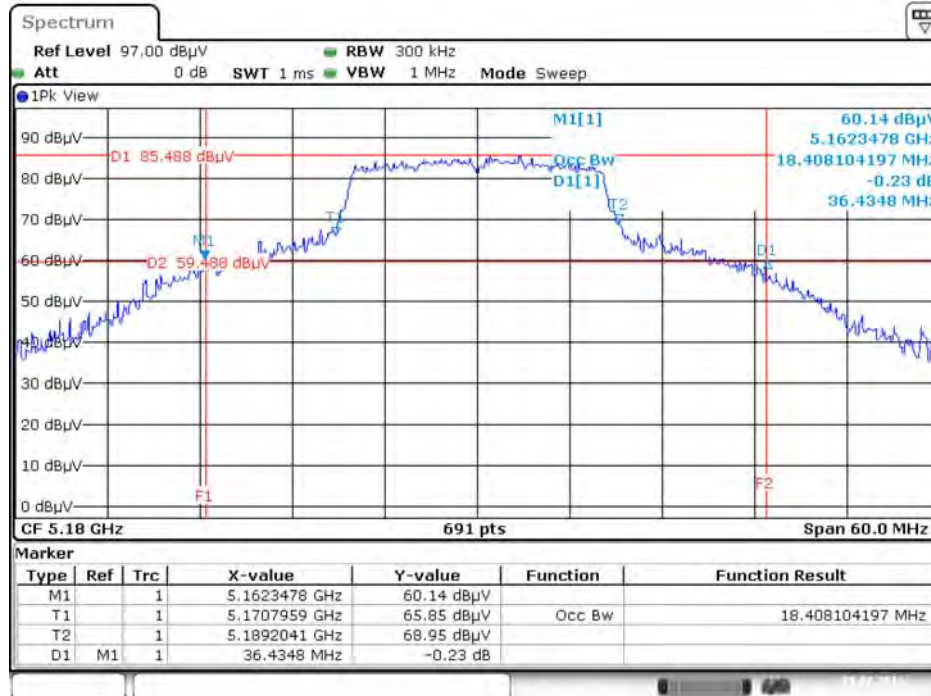

Date: 29.JUL.2016 14:03:22

26dB Bandwidth and 99% Occupied Bandwidth Plot on Configuration IEEE 802.11a / Ant. 1 + Ant. 2 / 5200 MHz

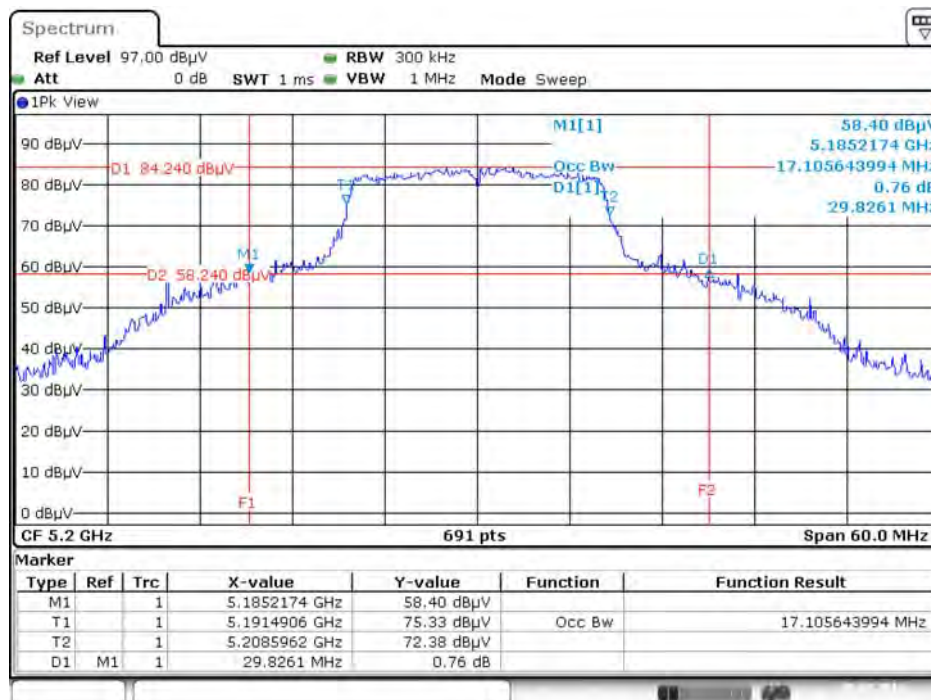

Date: 29.JUL.2016 14:05:03

26dB Bandwidth and 99% Occupied Bandwidth Plot on Configuration IEEE 802.11a / Ant. 1 + Ant. 2 / 5240 MHz

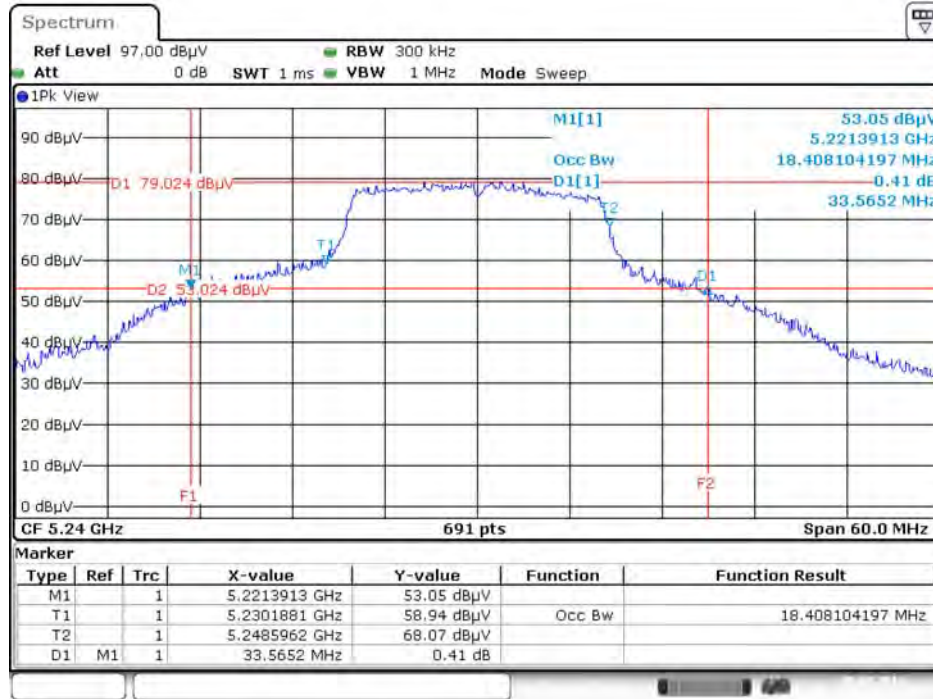

Date: 29.JUL.2016 14:06:26

26dB Bandwidth and 99% Occupied Bandwidth Plot on Configuration IEEE 802.11a / Ant. 1 + Ant. 2 / 5260 MHz

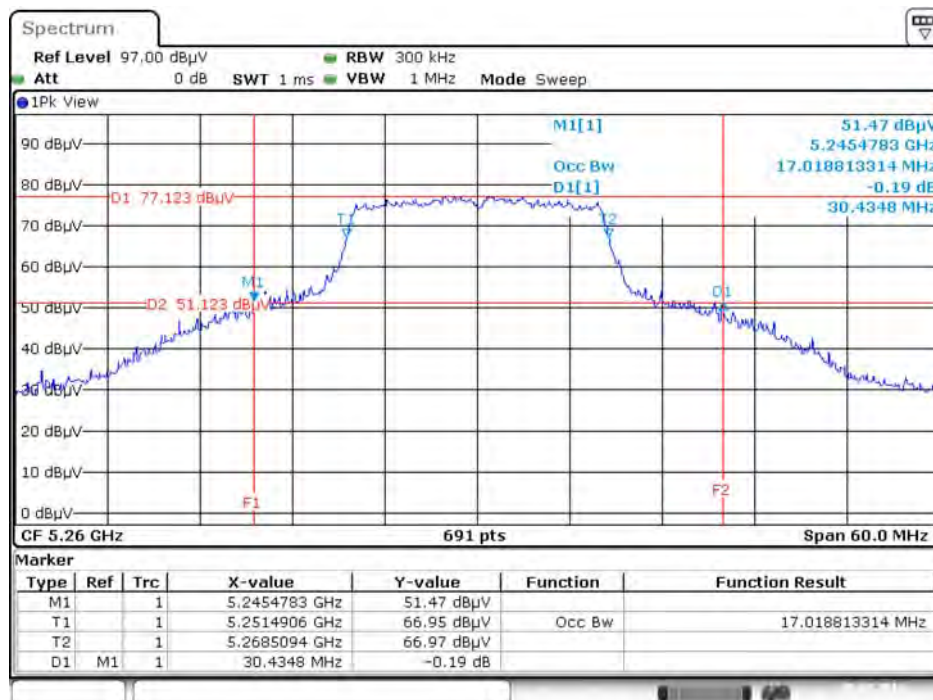

Date: 29.JUL.2016 14:07:20

26dB Bandwidth and 99% Occupied Bandwidth Plot on Configuration IEEE 802.11a / Ant. 1 + Ant. 2 / 5300 MHz

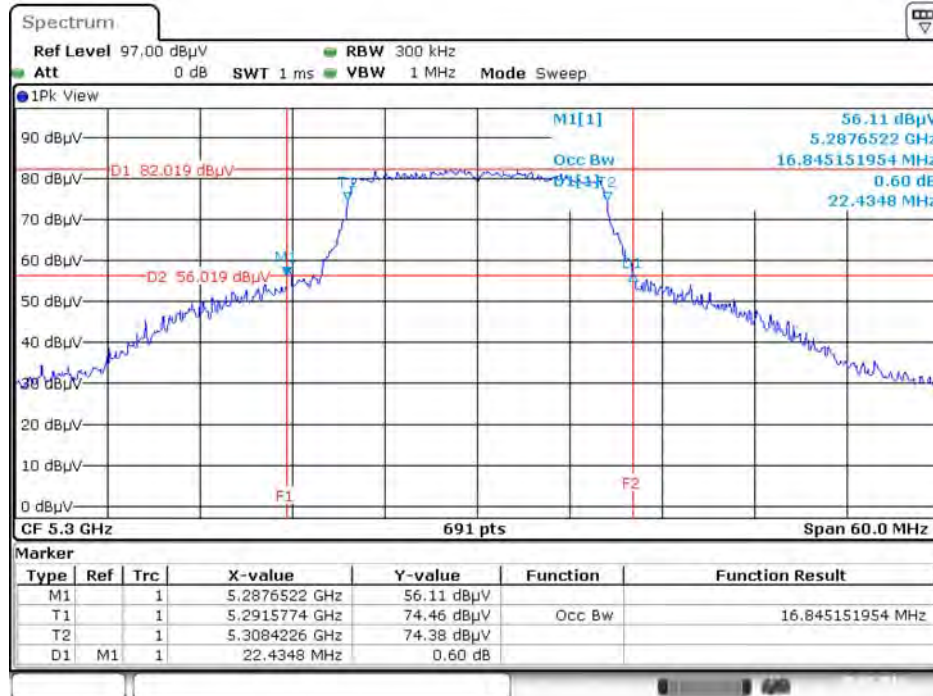

Date: 29.JUL.2016 14:08:12

26dB Bandwidth and 99% Occupied Bandwidth Plot on Configuration IEEE 802.11a / Ant. 1 + Ant. 2 / 5320 MHz

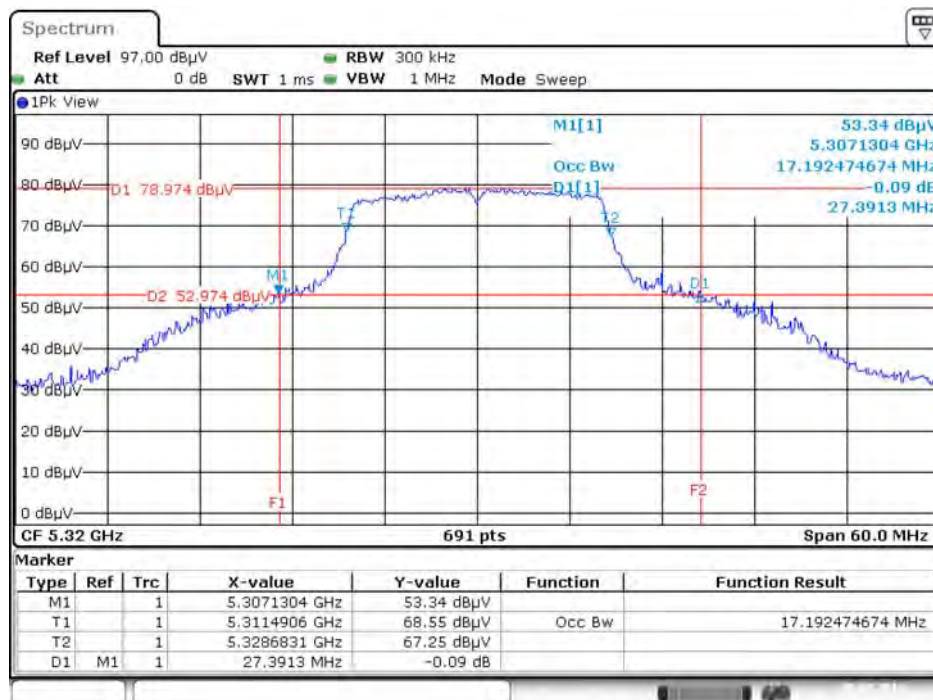

Date: 29.JUL.2016 14:09:04

26dB Bandwidth and 99% Occupied Bandwidth Plot on Configuration IEEE 802.11a / Ant. 1 + Ant. 2 / 5500 MHz

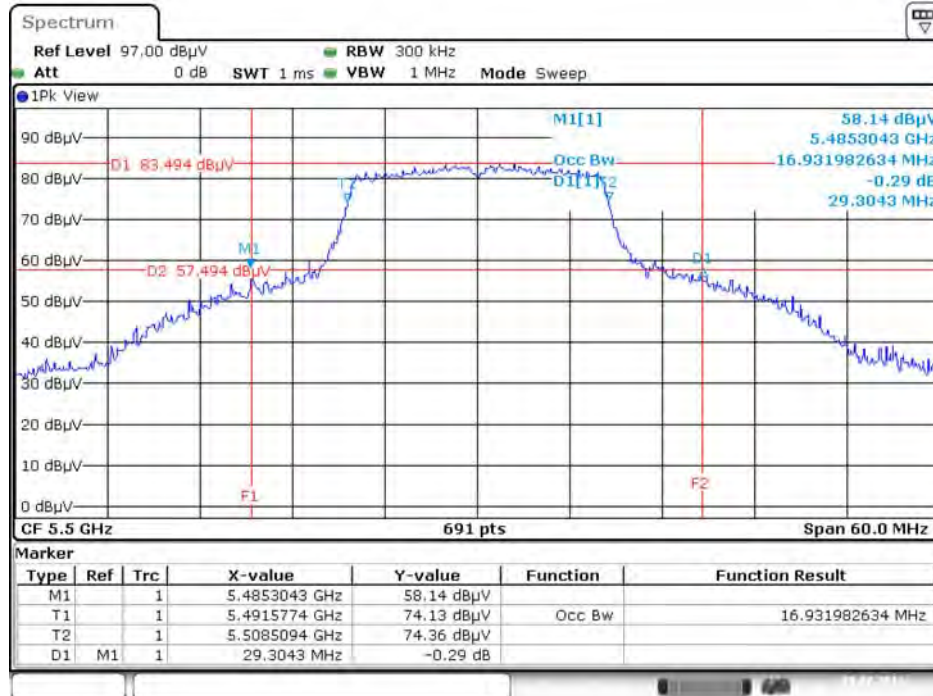

Date: 29.JUL.2016 14:10:00

26dB Bandwidth and 99% Occupied Bandwidth Plot on Configuration IEEE 802.11a / Ant. 1 + Ant. 2 / 5580 MHz

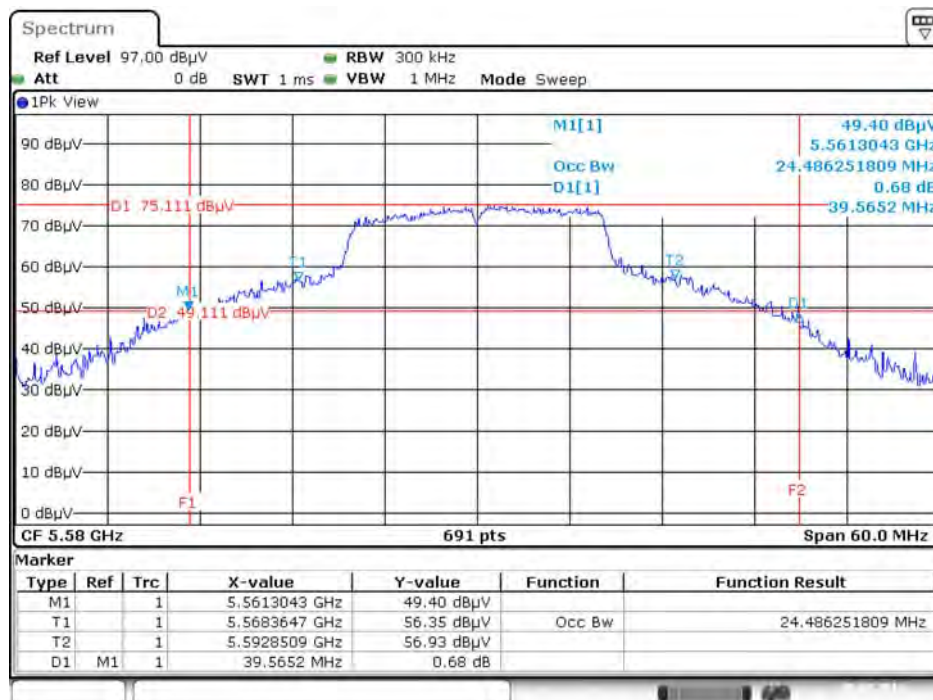

Date: 29.JUL.2016 14:10:56

26dB Bandwidth and 99% Occupied Bandwidth Plot on Configuration IEEE 802.11a / Ant. 1 + Ant. 2 / 5700 MHz

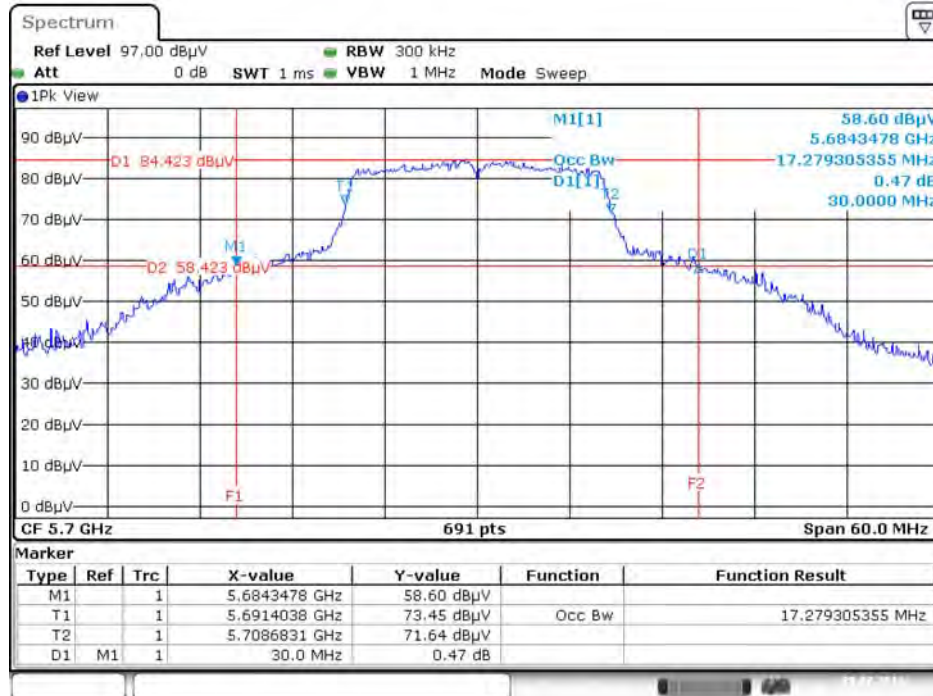

Date: 29.JUL.2016 14:11:45

26dB Bandwidth and 99% Occupied Bandwidth Plot on Configuration IEEE 802.11a / Ant. 1 + Ant. 2 / 5745 MHz

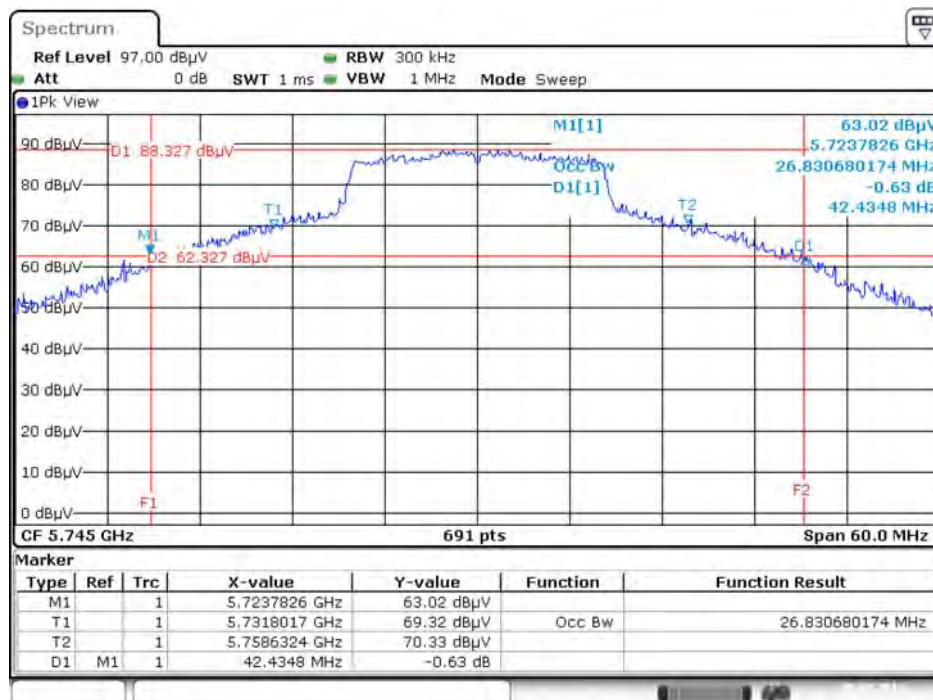

Date: 29.JUL.2016 14:17:36

26dB Bandwidth and 99% Occupied Bandwidth Plot on Configuration IEEE 802.11a / Ant. 1 + Ant. 2 / 5785 MHz

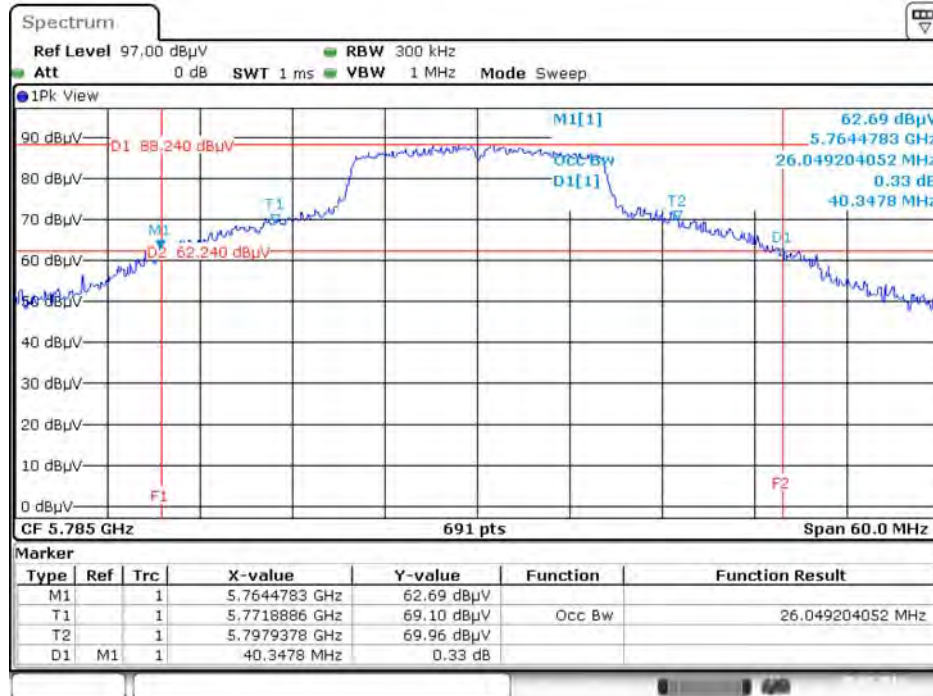

Date: 29.JUL.2016 14:20:16

26dB Bandwidth and 99% Occupied Bandwidth Plot on Configuration IEEE 802.11a / Ant. 1 + Ant. 2 / 5825 MHz

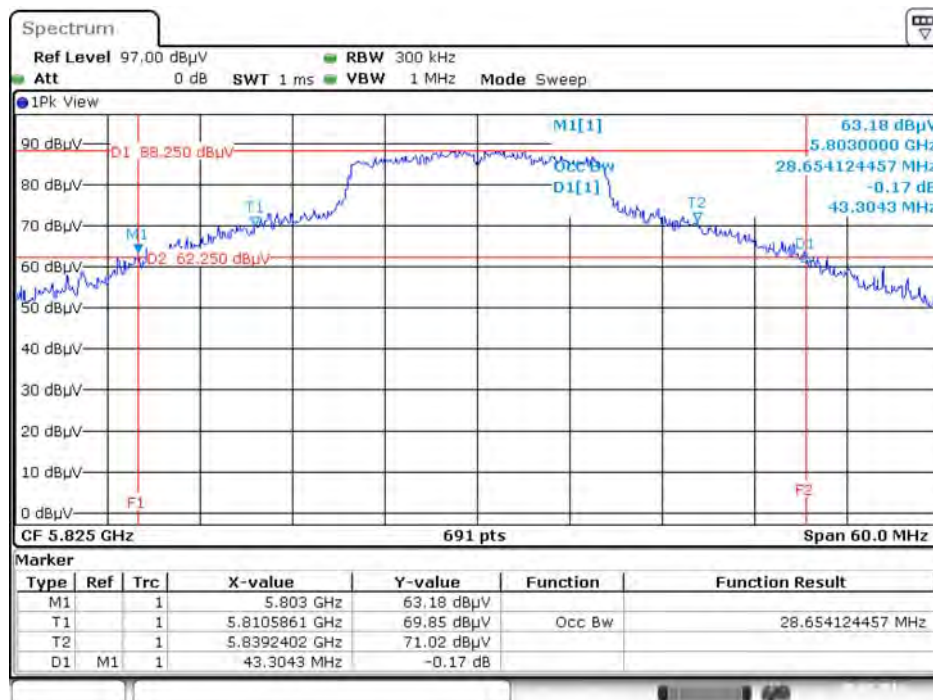

Date: 29.JUL.2016 14:22:18

26dB Bandwidth and 99% Occupied Bandwidth Plot on Configuration IEEE 802.11n MCS0 HT20 / Ant. 1 + Ant. 2 / 5180 MHz

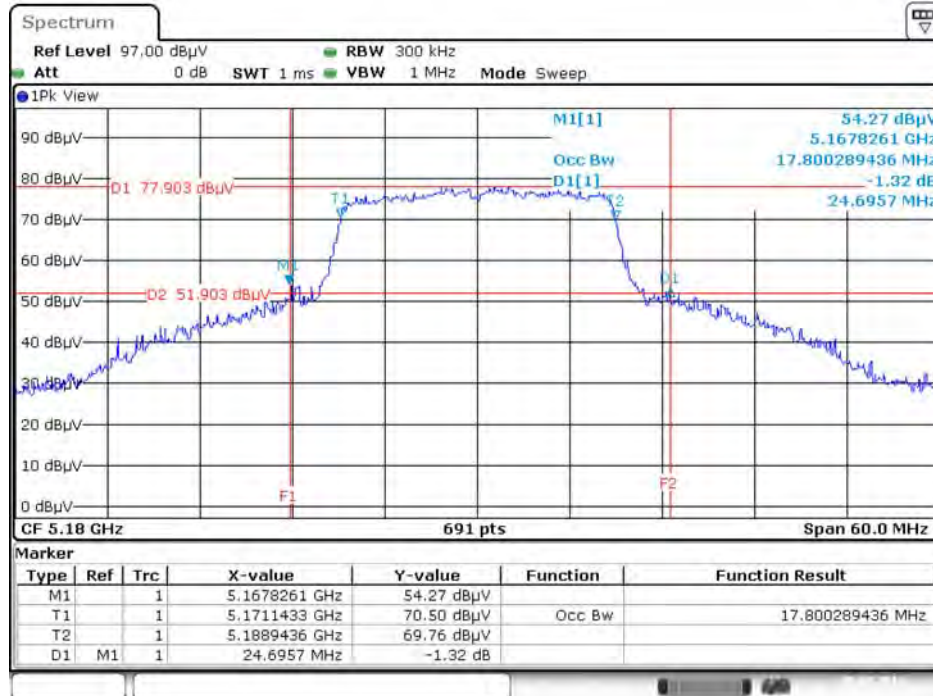

Date: 29.JUL.2016 14:24:26

26dB Bandwidth and 99% Occupied Bandwidth Plot on Configuration IEEE 802.11n MCS0 HT20 / Ant. 1 + Ant. 2 / 5200 MHz

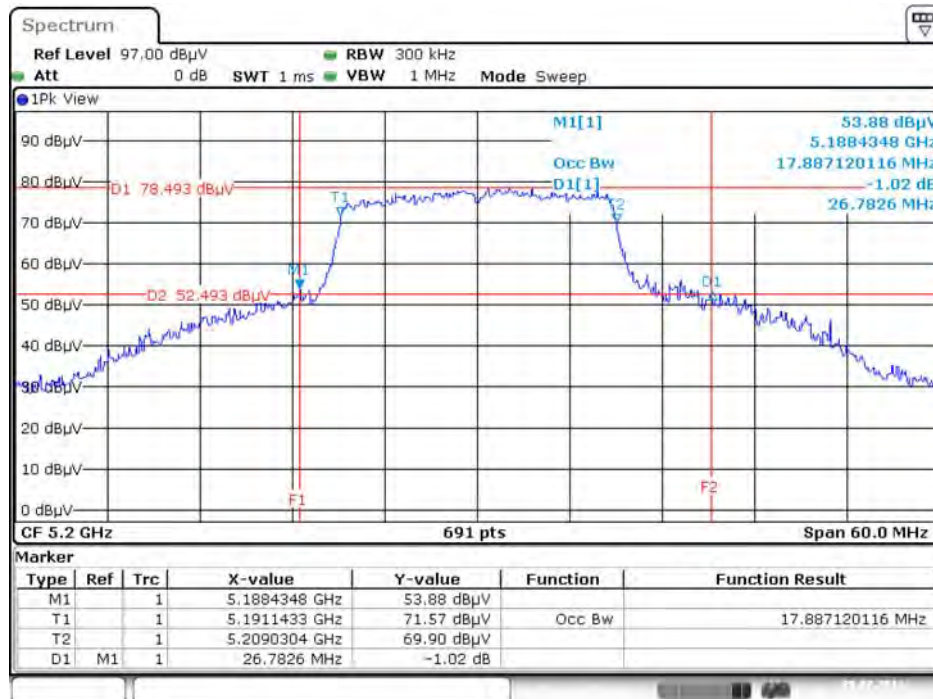

Date: 29.JUL.2016 14:26:31

26dB Bandwidth and 99% Occupied Bandwidth Plot on Configuration IEEE 802.11n MCS0 HT20 / Ant. 1 + Ant. 2 / 5240 MHz

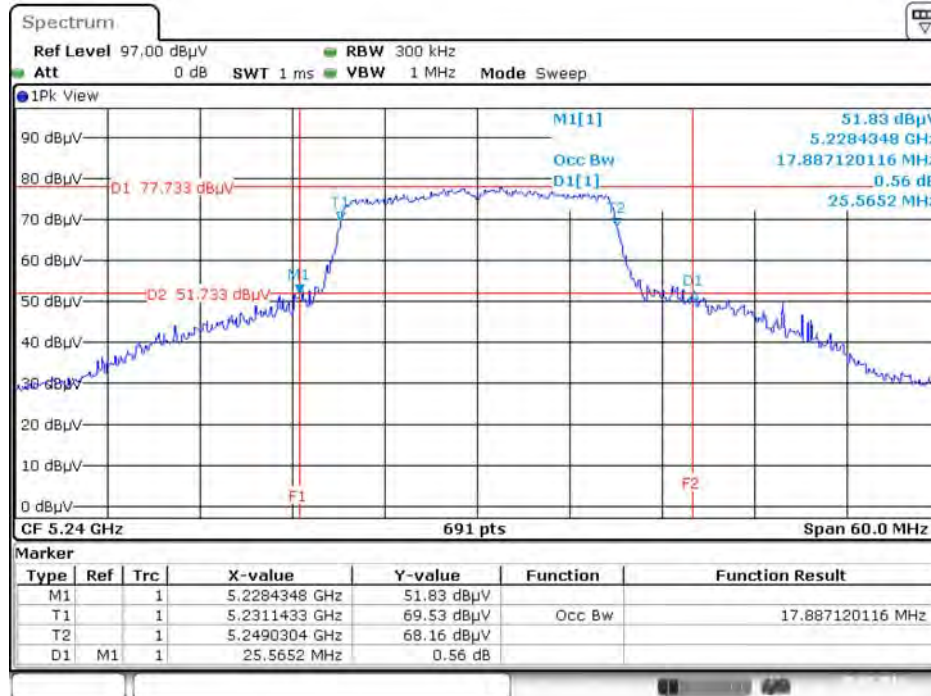

Date: 29.JUL.2016 14:27:29

26dB Bandwidth and 99% Occupied Bandwidth Plot on Configuration IEEE 802.11n MCS0 HT20 / Ant. 1 + Ant. 2 / 5260 MHz

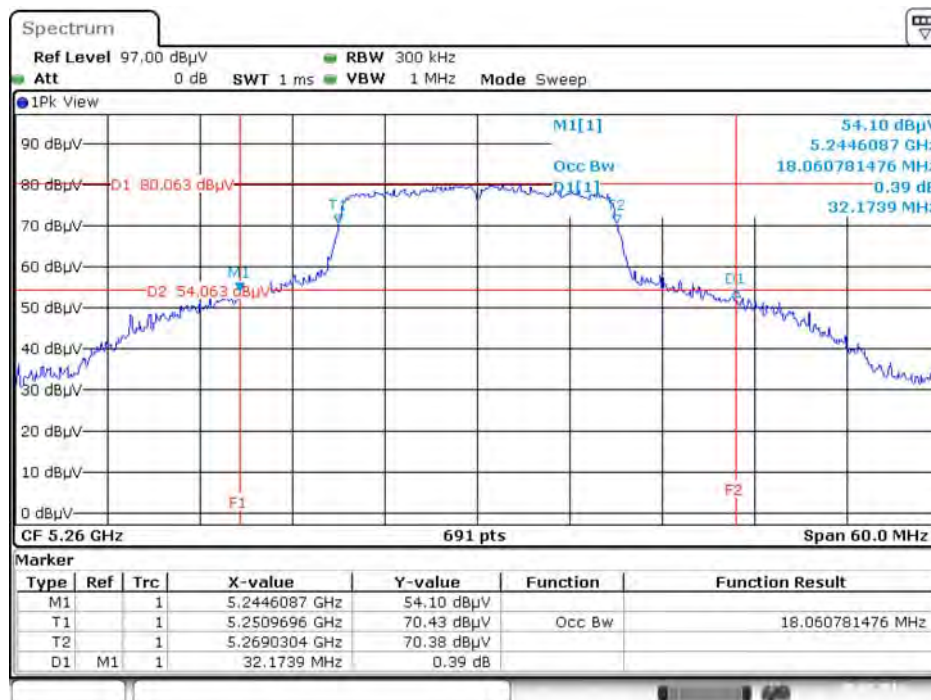

Date: 29.JUL.2016 14:32:48

26dB Bandwidth and 99% Occupied Bandwidth Plot on Configuration IEEE 802.11n MCS0 HT20 / Ant. 1 + Ant. 2 / 5300 MHz

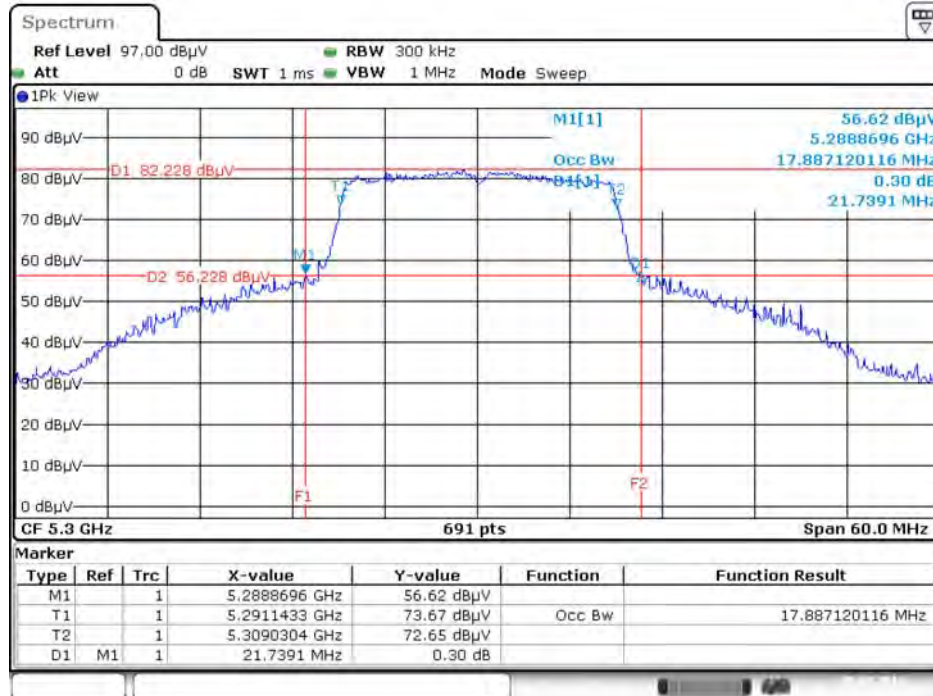

Date: 29.JUL.2016 14:38:37

26dB Bandwidth and 99% Occupied Bandwidth Plot on Configuration IEEE 802.11n MCS0 HT20 / Ant. 1 + Ant. 2 / 5320 MHz

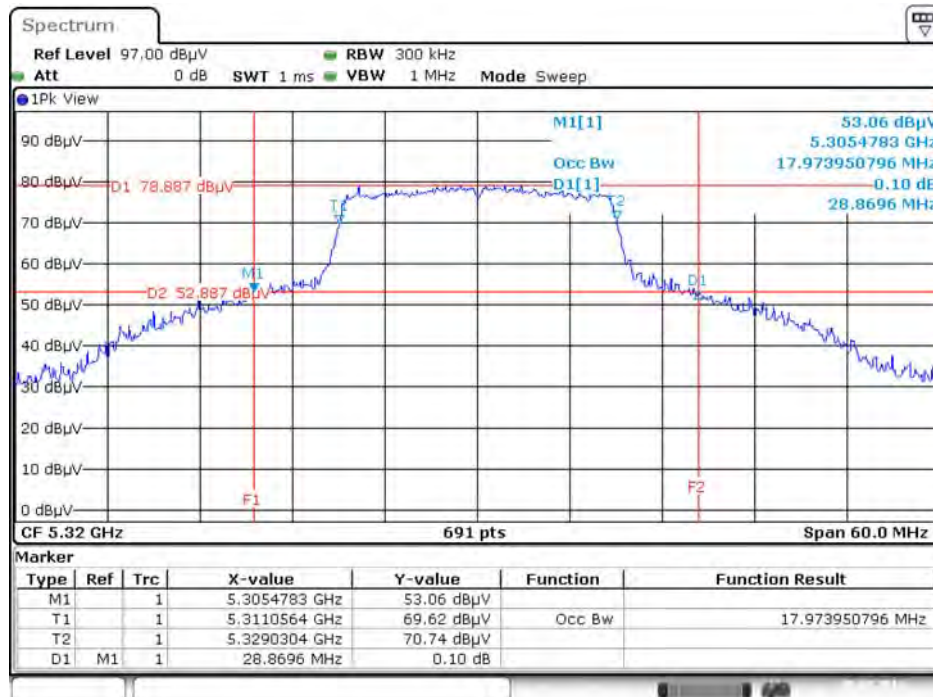

Date: 29.JUL.2016 14:39:39

26dB Bandwidth and 99% Occupied Bandwidth Plot on Configuration IEEE 802.11n MCS0 HT20 / Ant. 1 + Ant. 2/ 5500 MHz

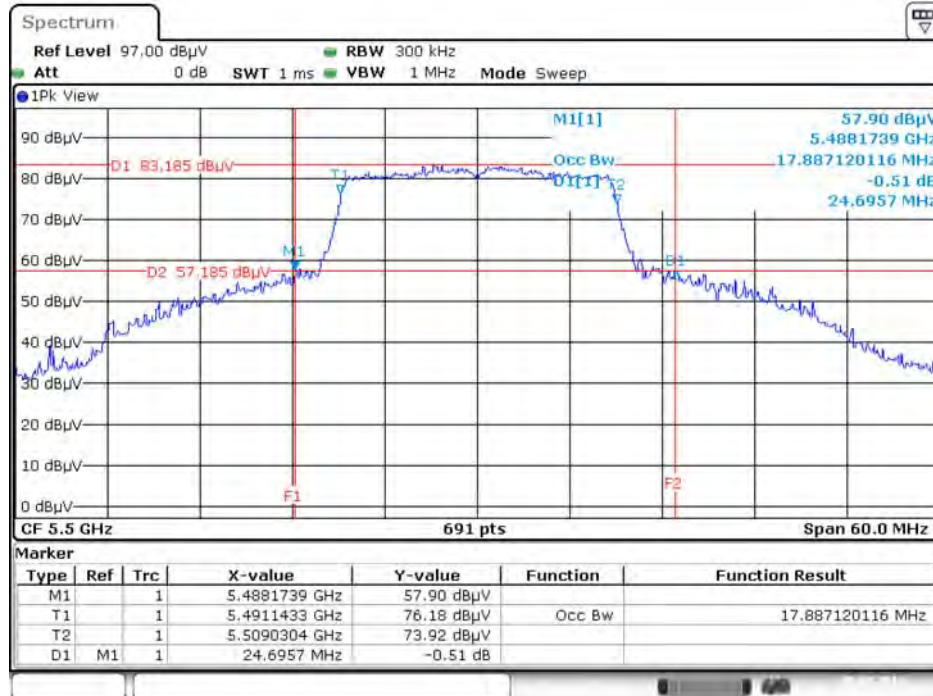

Date: 29.JUL.2016 14:41:03

26dB Bandwidth and 99% Occupied Bandwidth Plot on Configuration IEEE 802.11n MCS0 HT20 / Ant. 1 + Ant. 2 / 5580 MHz

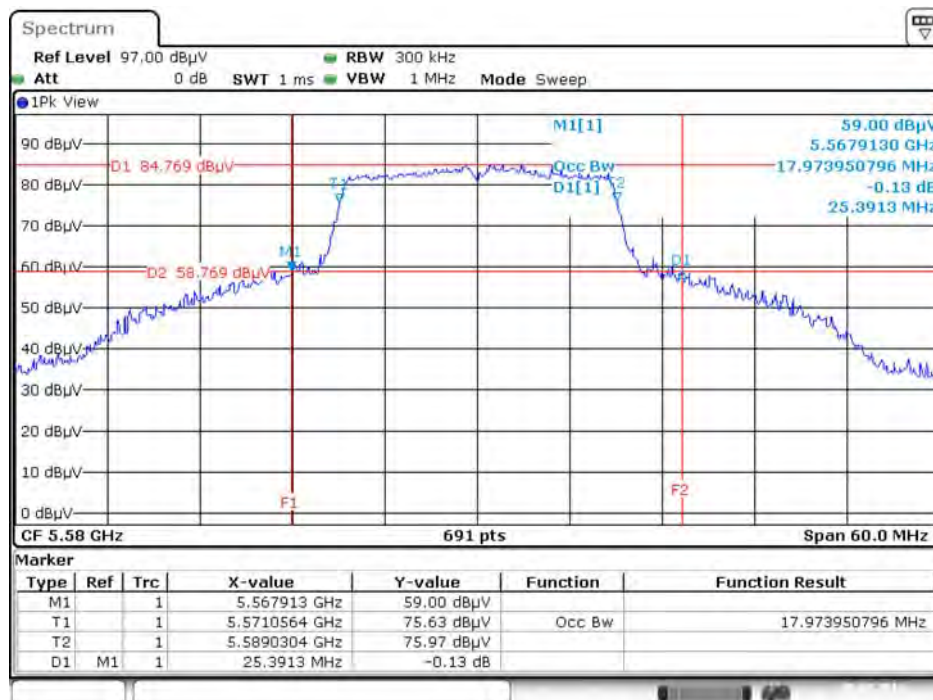

Date: 29.JUL.2016 14:43:07

26dB Bandwidth and 99% Occupied Bandwidth Plot on Configuration IEEE 802.11n MCS0 HT20 / Ant. 1 + Ant. 2 / 5700 MHz

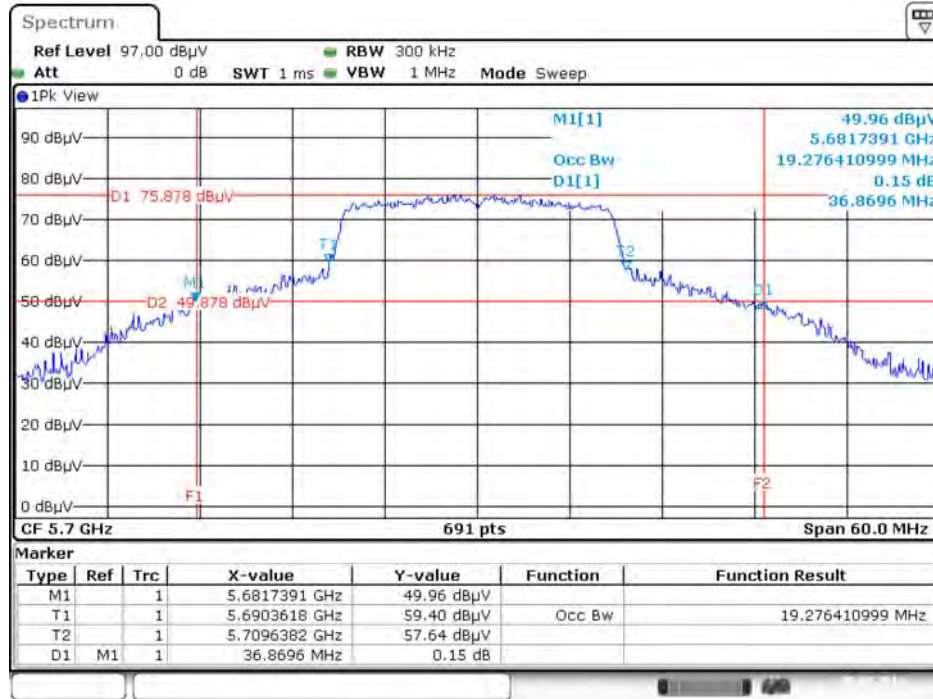

Date: 29.JUL.2016 14:43:55

26dB Bandwidth and 99% Occupied Bandwidth Plot on Configuration IEEE 802.11n MCS0 HT20 / Ant. 1 + Ant. 2 / 5745 MHz

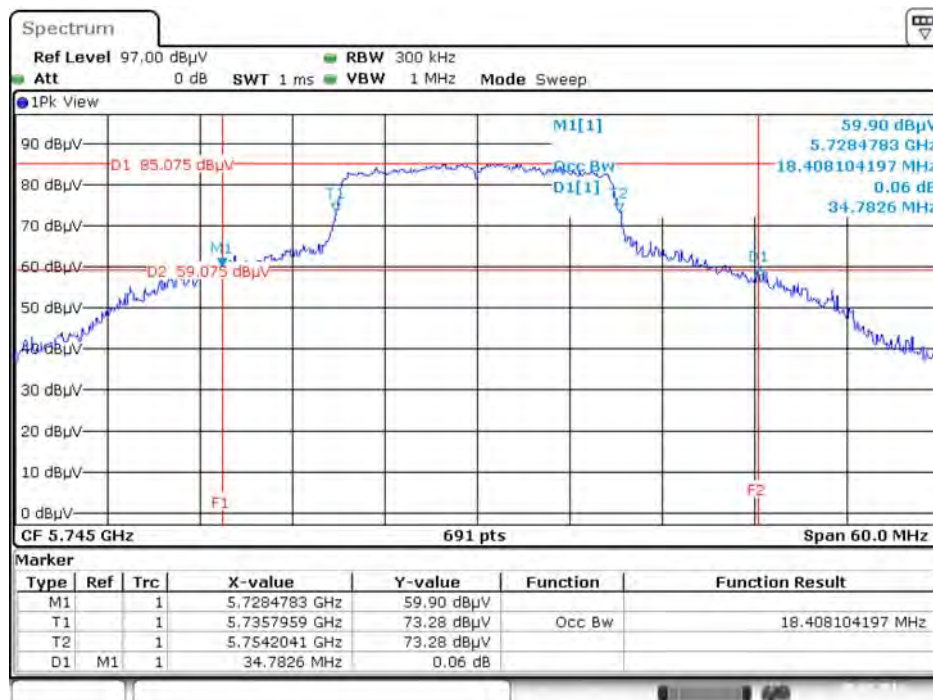

Date: 29.JUL.2016 14:45:39

26dB Bandwidth and 99% Occupied Bandwidth Plot on Configuration IEEE 802.11n MCS0 HT20 / Ant. 1 + Ant. 2 / 5785 MHz

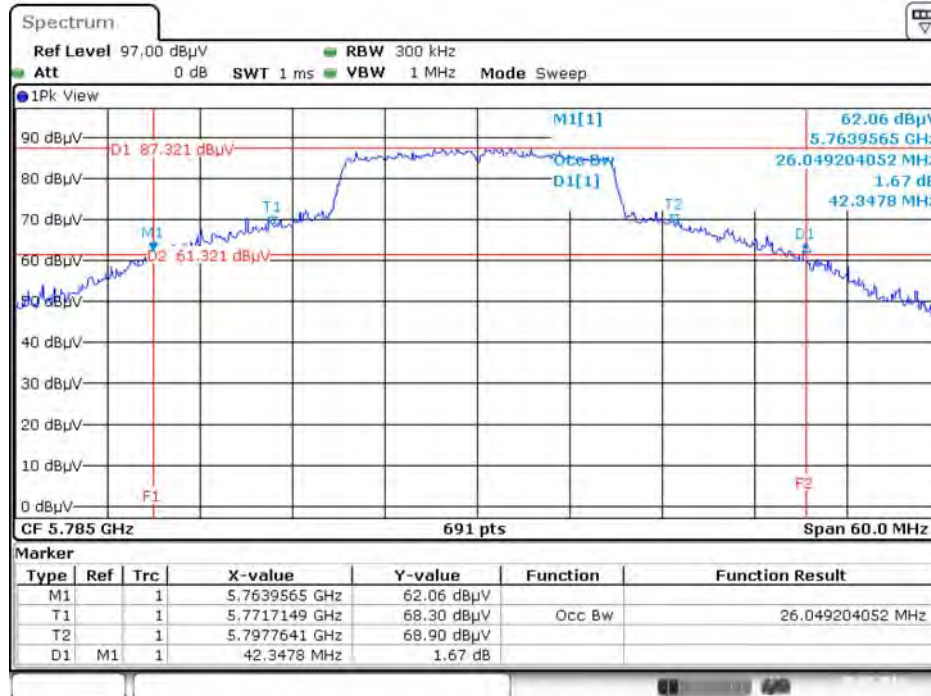

Date: 29.JUL.2016 14:47:15

26dB Bandwidth and 99% Occupied Bandwidth Plot on Configuration IEEE 802.11n MCS0 HT20 / Ant. 1 + Ant. 2 / 5825 MHz

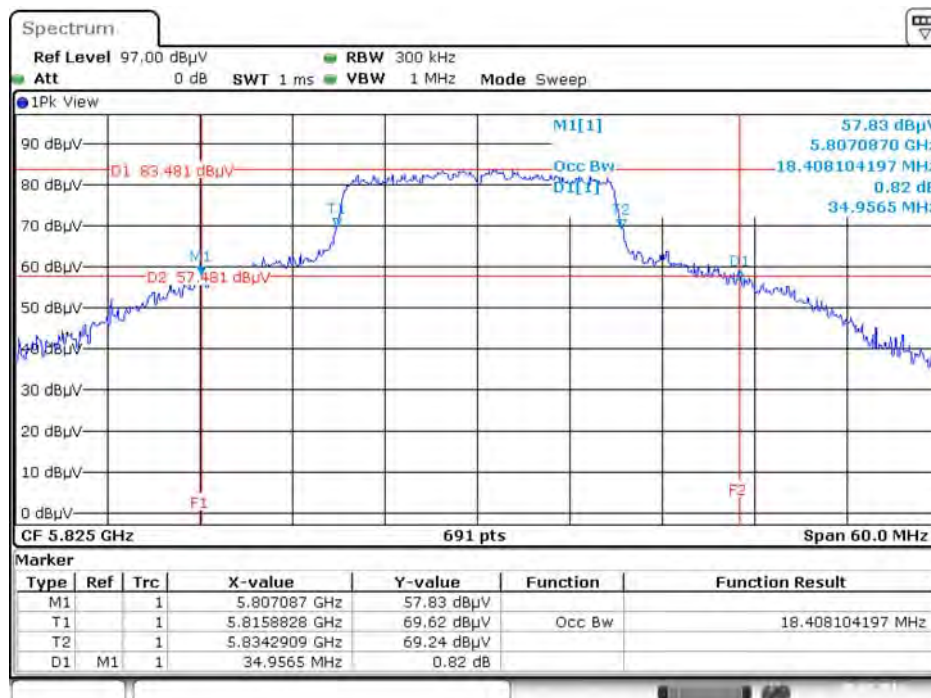

Date: 29.JUL.2016 14:51:44

26dB Bandwidth and 99% Occupied Bandwidth Plot on Configuration IEEE 802.11n MCS0 HT40 / Ant. 1 + Ant. 2 / 5190 MHz

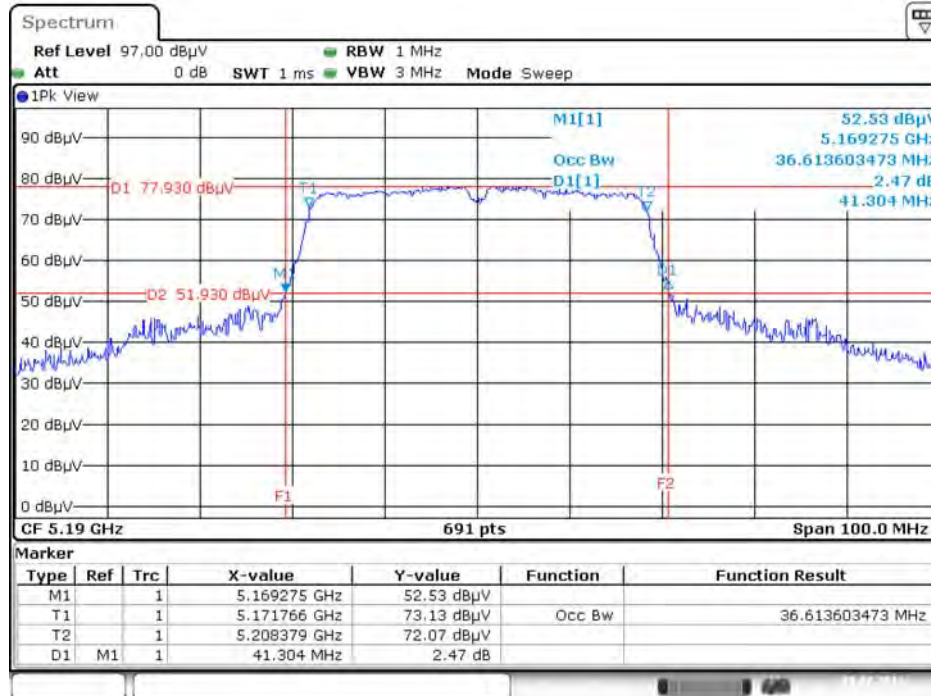

Date: 29.JUL.2016 14:57:06

26dB Bandwidth and 99% Occupied Bandwidth Plot on Configuration IEEE 802.11n MCS0 HT40 / Ant. 1 + Ant. 2 / 5230 MHz

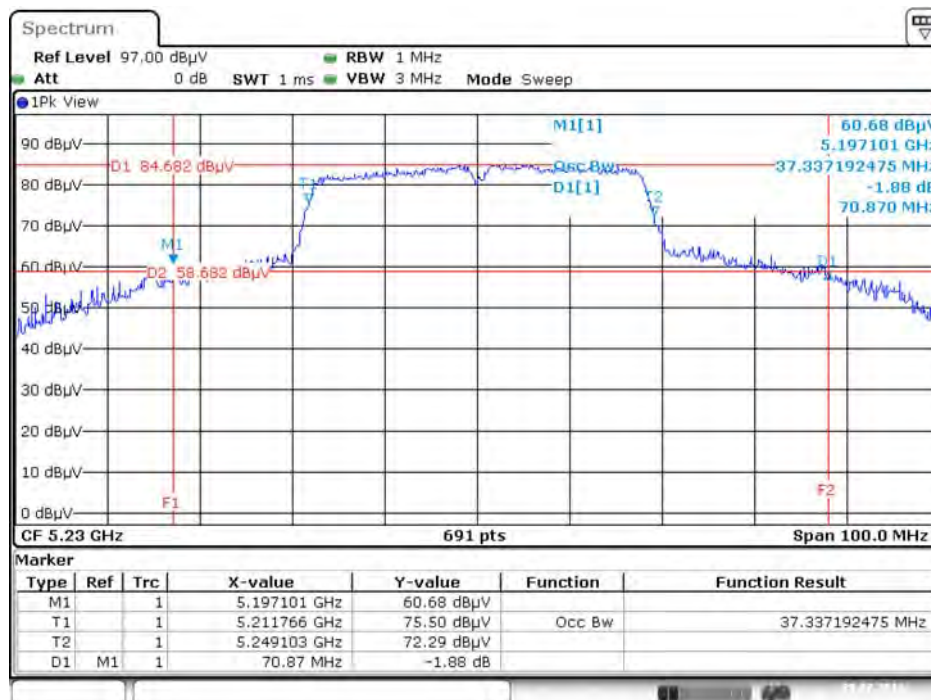

Date: 29.JUL.2016 14:59:00

26dB Bandwidth and 99% Occupied Bandwidth Plot on Configuration IEEE 802.11n MCS0 HT40 / Ant. 1 + Ant. 2 / 5270 MHz

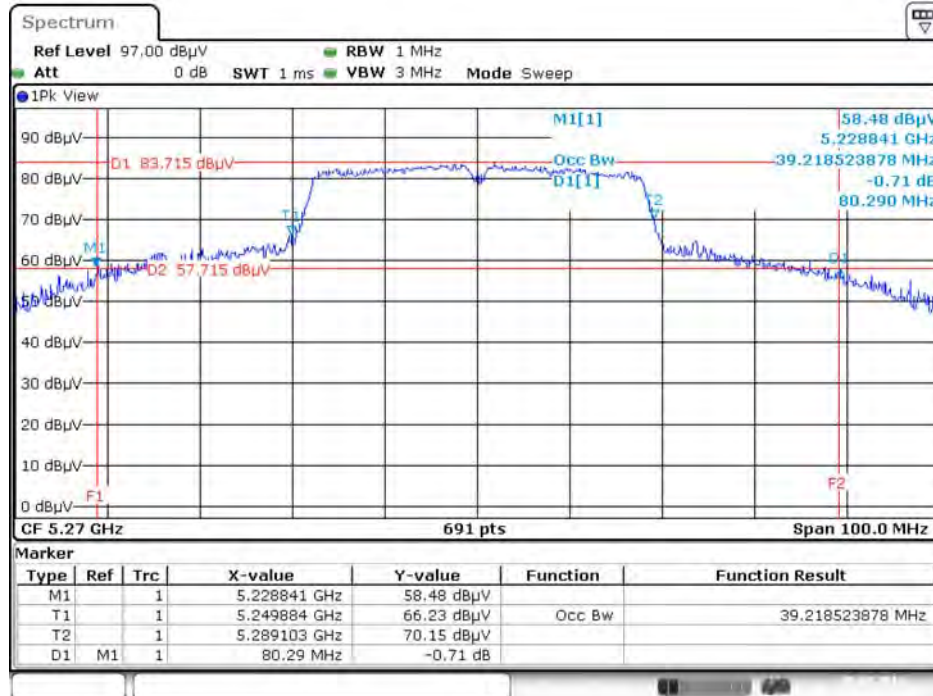

Date: 29.JUL.2016 15:00:20

26dB Bandwidth and 99% Occupied Bandwidth Plot on Configuration IEEE 802.11n MCS0 HT40 / Ant. 1 + Ant. 2 / 5310 MHz

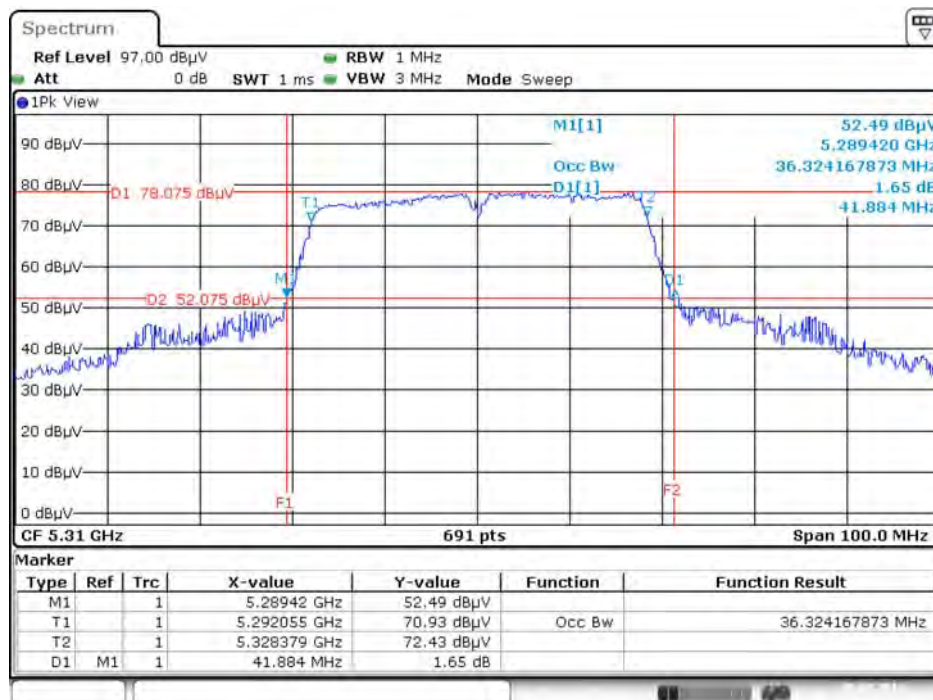

Date: 29.JUL.2016 15:01:42

26dB Bandwidth and 99% Occupied Bandwidth Plot on Configuration IEEE 802.11n MCS0 HT40 / Ant. 1 + Ant. 2 / 5510 MHz

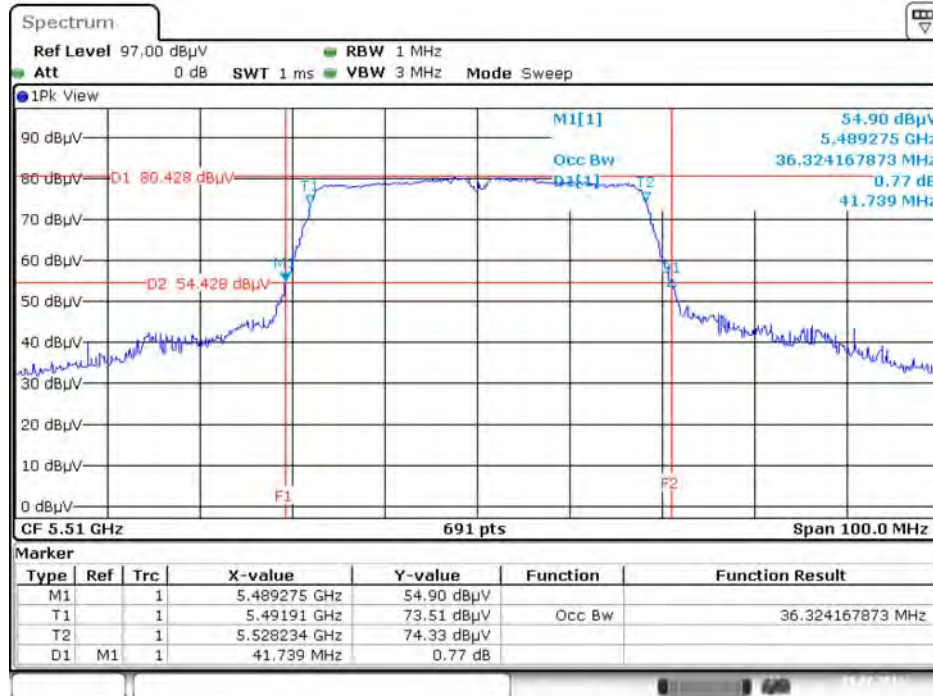

Date: 29.JUL.2016 15:03:28

26dB Bandwidth and 99% Occupied Bandwidth Plot on Configuration IEEE 802.11n MCS0 HT40 / Ant. 1 + Ant. 2 / 5550 MHz

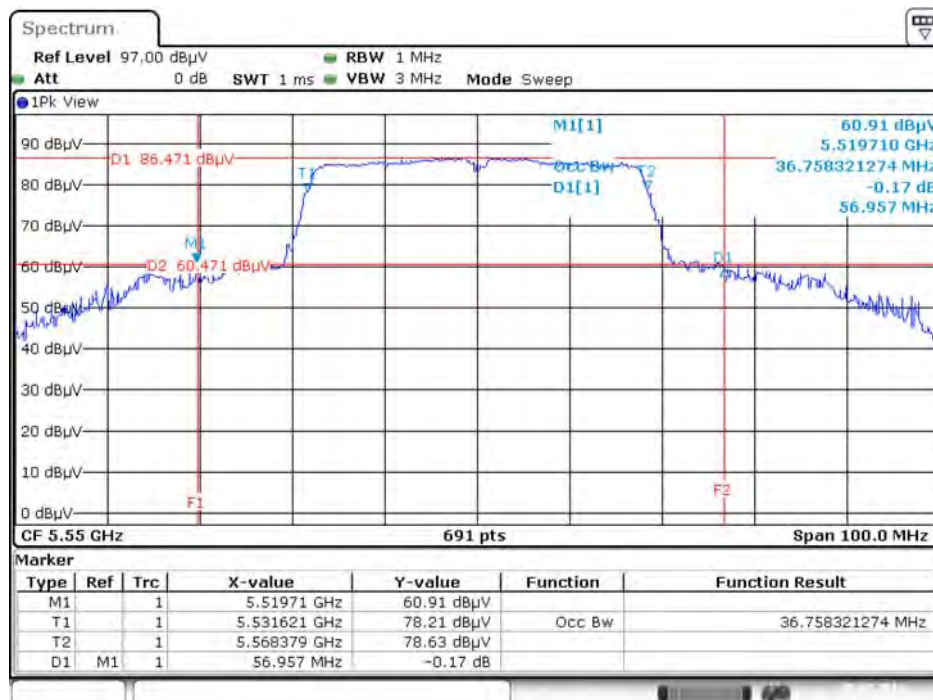

Date: 29.JUL.2016 15:05:21

26dB Bandwidth and 99% Occupied Bandwidth Plot on Configuration IEEE 802.11n MCS0 HT40 / Ant. 1 + Ant. 2 / 5670 MHz

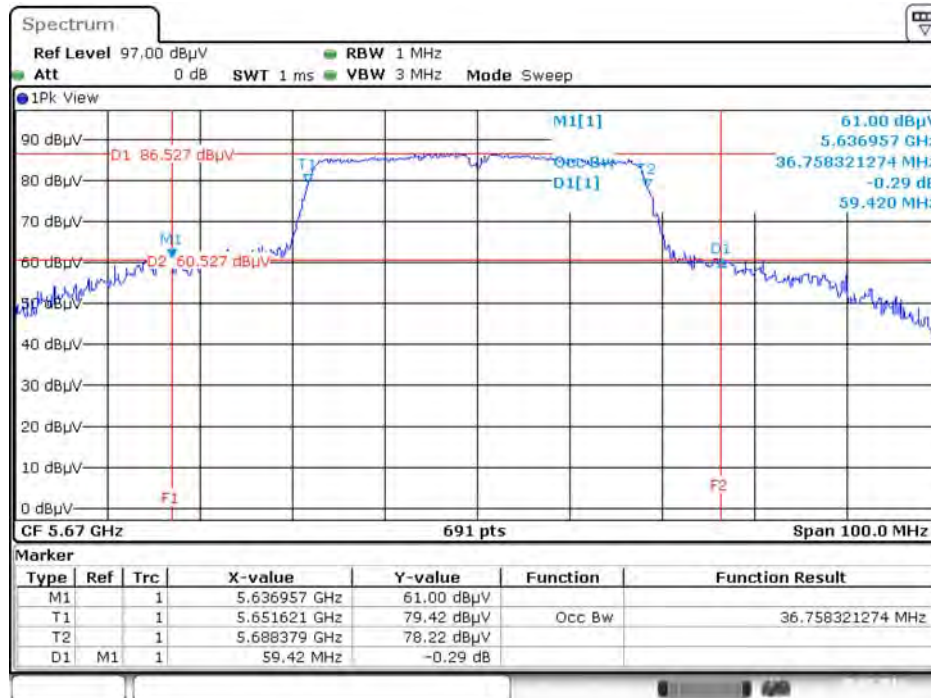

Date: 29.JUL.2016 15:06:36

26dB Bandwidth and 99% Occupied Bandwidth Plot on Configuration IEEE 802.11n MCS0 HT40 / Ant. 1 + Ant. 2 / 5755 MHz

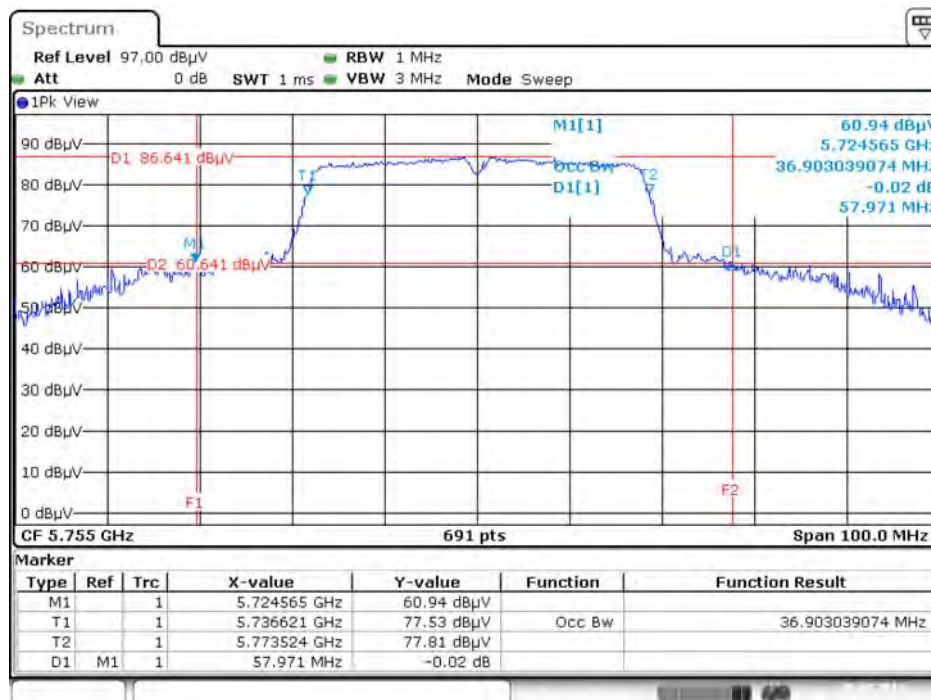

Date: 29.JUL.2016 15:09:34

26dB Bandwidth and 99% Occupied Bandwidth Plot on Configuration IEEE 802.11n MCS0 HT40 / Ant. 1 + Ant. 2/ 5795 MHz

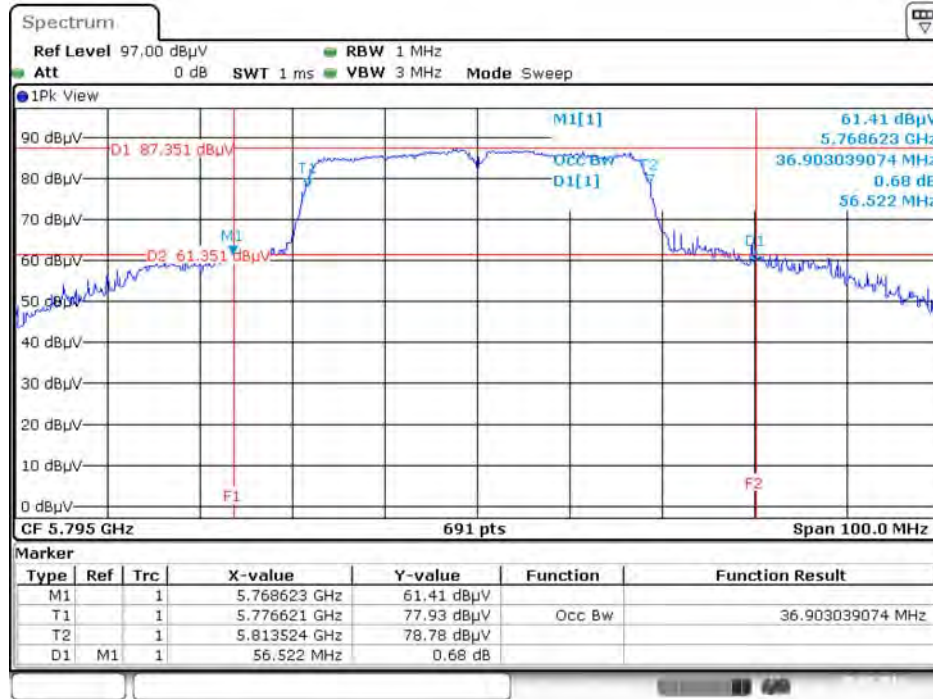

Date: 29 JUL 2016 15:10:17

Straddle Channel

26dB Bandwidth and 99% Occupied Bandwidth Plot on Configuration IEEE 802.11a / Ant. 1 + Ant. 2 / 5720 MHz

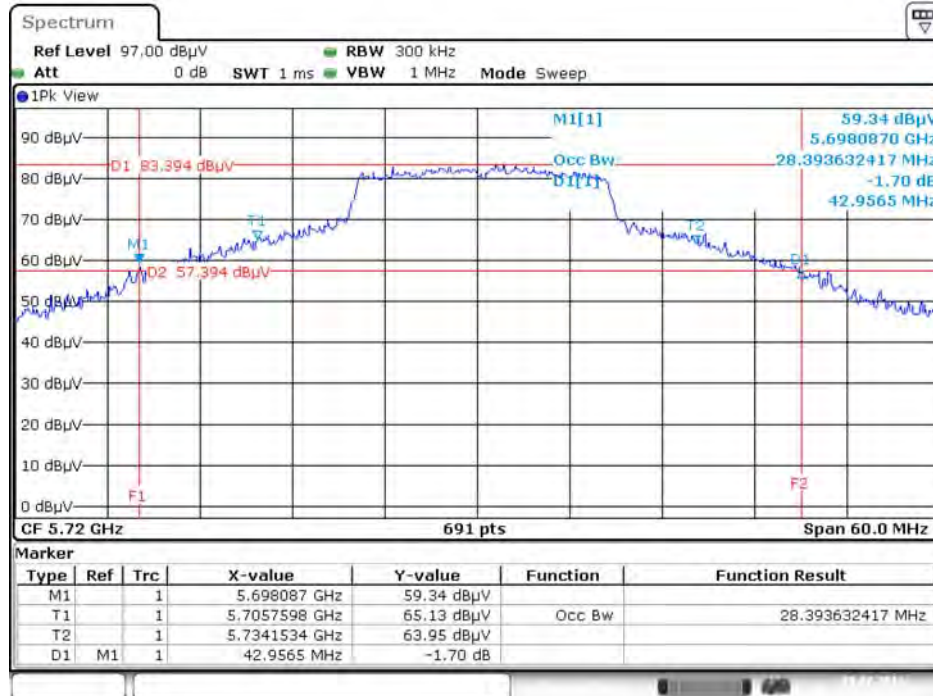

Date: 29.JUL.2016 16:27:22

26dB Bandwidth and 99% Occupied Bandwidth Plot on Configuration IEEE 802.11n MCS0 HT20 / Ant. 1 + Ant. 2 / 5720 MHz

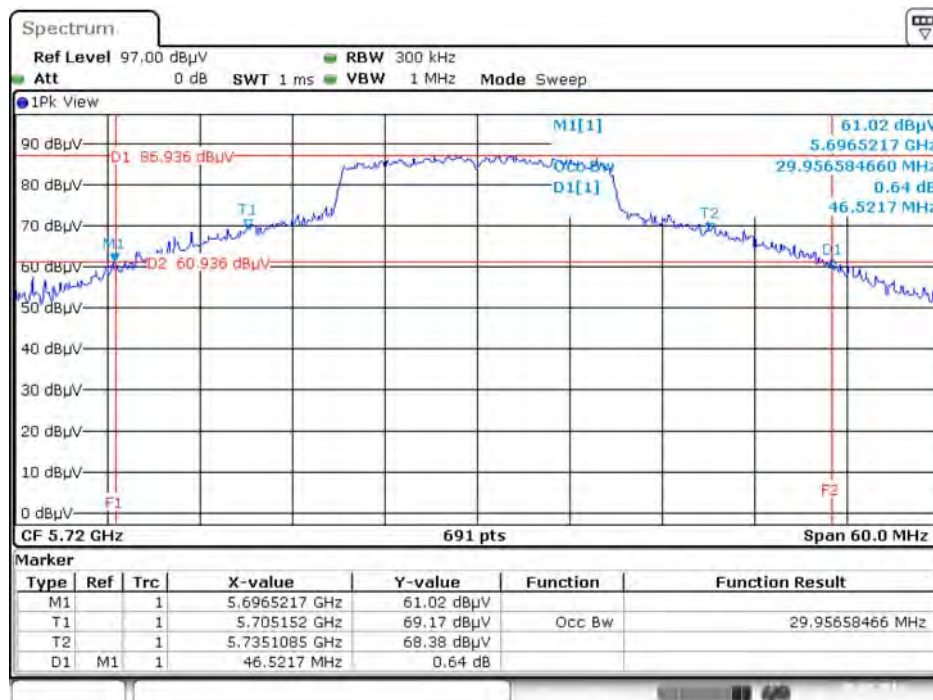

Date: 29.JUL.2016 16:35:39

26dB Bandwidth and 99% Occupied Bandwidth Plot on Configuration IEEE 802.11n MCS0 HT40 /
Ant. 1 + Ant. 2 / 5710 MHz

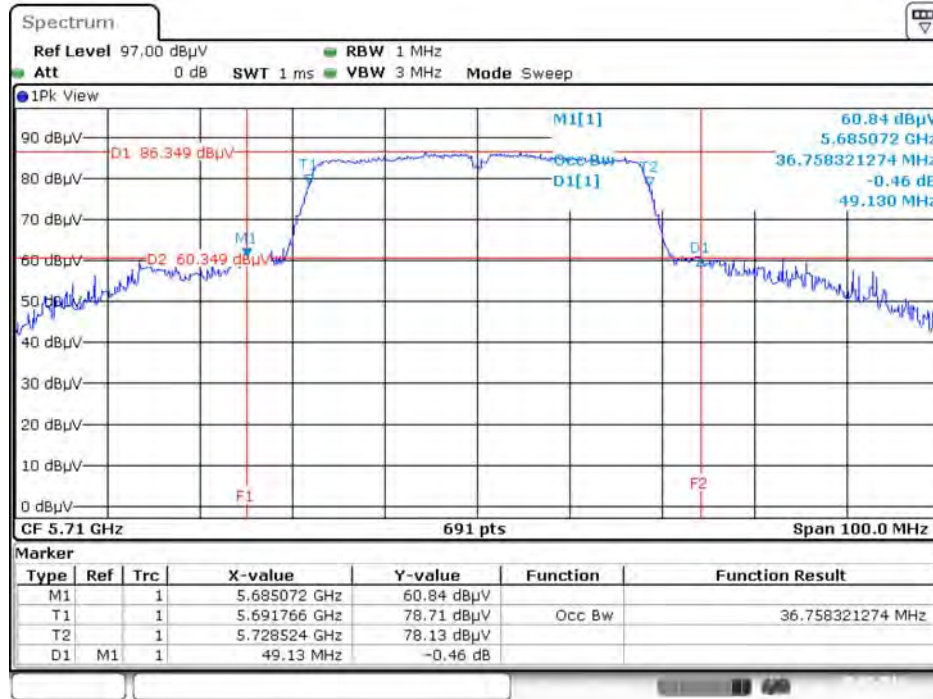

Date: 29 JUL 2016 16:43:18

4.3. 6dB Spectrum Bandwidth Measurement

4.3.1. Limit

For digital modulation systems, the minimum 6dB bandwidth shall be at least 500 kHz.

4.3.2. Measuring Instruments and Setting

Please refer to section 5 of equipments list in this report. The following table is the setting of spectrum analyzer.

| 6dB Spectrum Bandwidth | |
|------------------------|----------------------------|
| Spectrum Parameters | Setting |
| Attenuation | Auto |
| Span Frequency | > 6dB Bandwidth |
| RBW | 100kHz |
| VBW | $\geq 3 \times \text{RBW}$ |
| Detector | Peak |
| Trace | Max Hold |
| Sweep Time | Auto |

4.3.3. Test Procedures

For Radiated 6dB Bandwidth Measurement:

1. The transmitter was radiated to the spectrum analyzer in peak hold mode.
2. Test was performed in accordance with KDB789033 D02 v01r03 for Compliance Testing of Unlicensed National Information Infrastructure (U-NII) Devices - section (C) Emission Bandwidth.
3. Multiple antenna system was performed in accordance with KDB662911 D01 v02r01 Emissions Testing of Transmitters with Multiple Outputs in the Same Band.
4. Measured the spectrum width with power higher than 6dB below carrier.

4.3.4. Test Setup Layout

For Radiated 6dB Bandwidth Measurement:

This test setup layout is the same as that shown in section 4.6.4.

4.3.5. Test Deviation

There is no deviation with the original standard.

4.3.6. EUT Operation during Test

The EUT was programmed to be in continuously transmitting mode.

4.3.7. Test Result of 6dB Spectrum Bandwidth

| | | | |
|---------------|----------|----------|-----|
| Temperature | 25°C | Humidity | 56% |
| Test Engineer | Gary Chu | | |

| Mode | Frequency | 6dB Bandwidth (MHz) | Min. Limit (kHz) | Test Result |
|----------------------|-----------|---------------------|------------------|-------------|
| 802.11a | 5745 MHz | 16.41 | 500 | Complies |
| | 5785 MHz | 16.46 | 500 | Complies |
| | 5825 MHz | 16.35 | 500 | Complies |
| 802.11n MCS0 HT20 | 5745 MHz | 17.33 | 500 | Complies |
| | 5785 MHz | 17.22 | 500 | Complies |
| | 5825 MHz | 17.33 | 500 | Complies |
| 802.11n MCS0 HT40 | 5755 MHz | 35.13 | 500 | Complies |
| | 5795 MHz | 33.74 | 500 | Complies |

Straddle Channel

| Mode | Frequency | 6dB BW (MHz) | 6dB BW M1 (MHz) | UNII 3 BW (MHz) | Min. Limit (kHz) | Test Result |
|----------------------|-----------|--------------|-----------------|-----------------|------------------|-------------|
| 802.11a | 5720 MHz | 15.94 | 5712.17 | 3.12 | 500 | Complies |
| 802.11n MCS0 HT20 | 5720 MHz | 16.70 | 5711.42 | 3.12 | 500 | Complies |
| 802.11n MCS0 HT40 | 5710 MHz | 35.25 | 5692.38 | 2.62 | 500 | Complies |

Note: All the test values were listed in the report.

For plots, only the channel with worse result was shown.

6 dB Bandwidth Plot on Configuration IEEE 802.11a / Ant. 1 + Ant. 2 / 5825 MHz

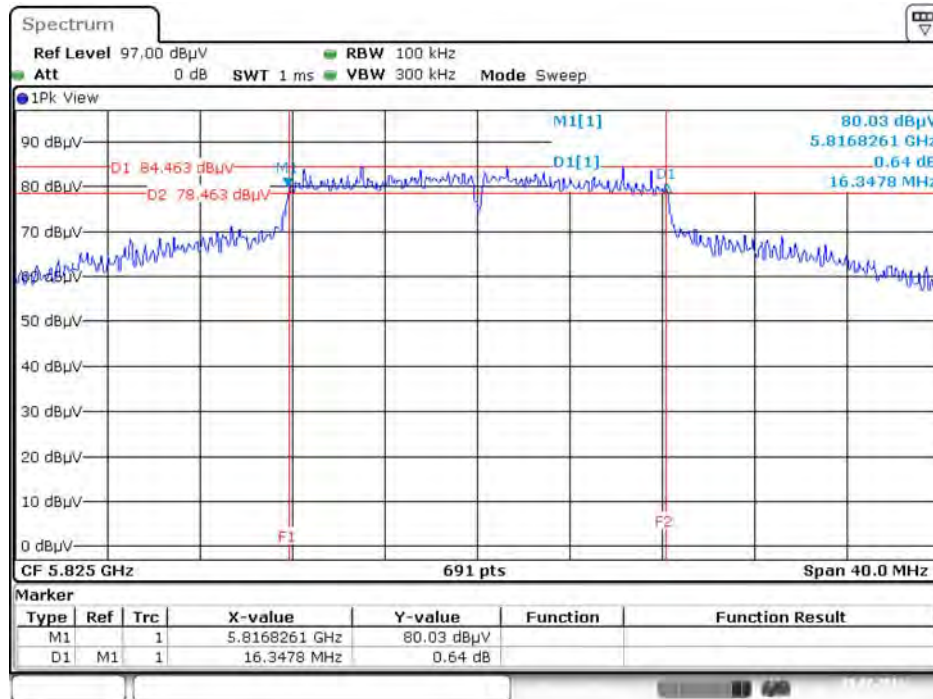

Date: 29 JUL 2016 16:08:51

6 dB Bandwidth Plot on Configuration IEEE 802.11n MCS0 HT20 / Ant. 1 + Ant. 2 / 5785 MHz

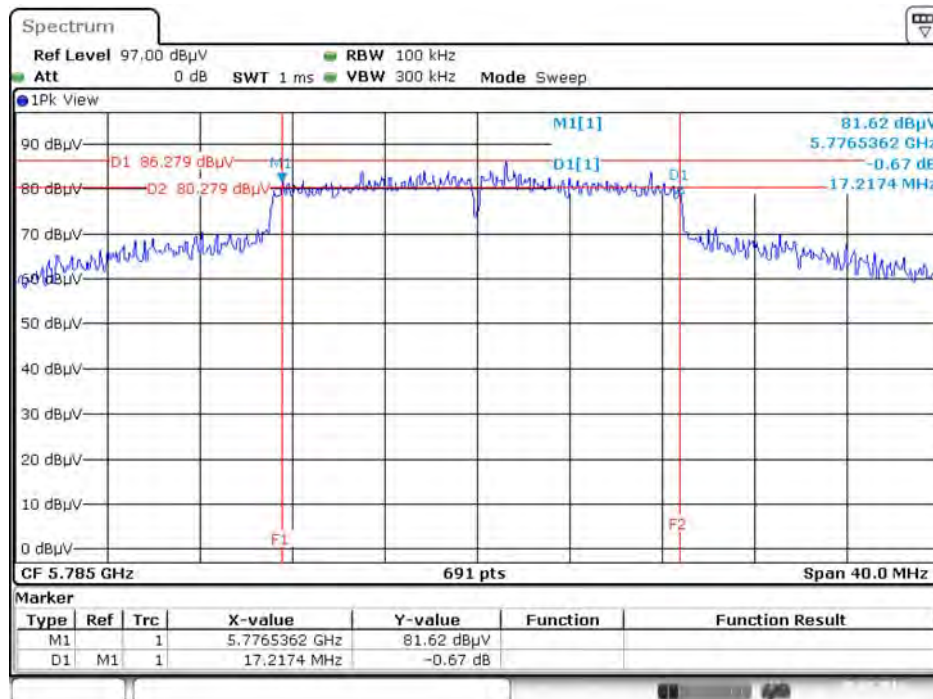

Date: 29 JUL 2016 15:56:13

6 dB Bandwidth Plot on Configuration IEEE 802.11n MCS0 HT40 / Ant. 1 + Ant. 2 / 5755 MHz

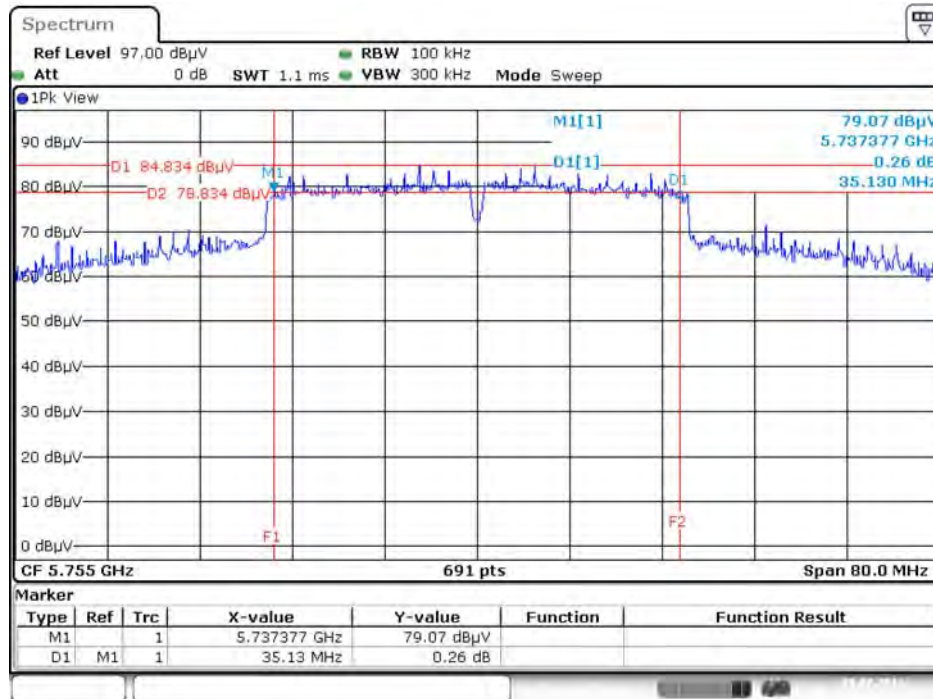

Date: 29 JUL 2016 16:04:01

Straddle Channel

6 dB Bandwidth Plot on Configuration IEEE 802.11a / Ant. 1 + Ant. 2 / 5720 MHz

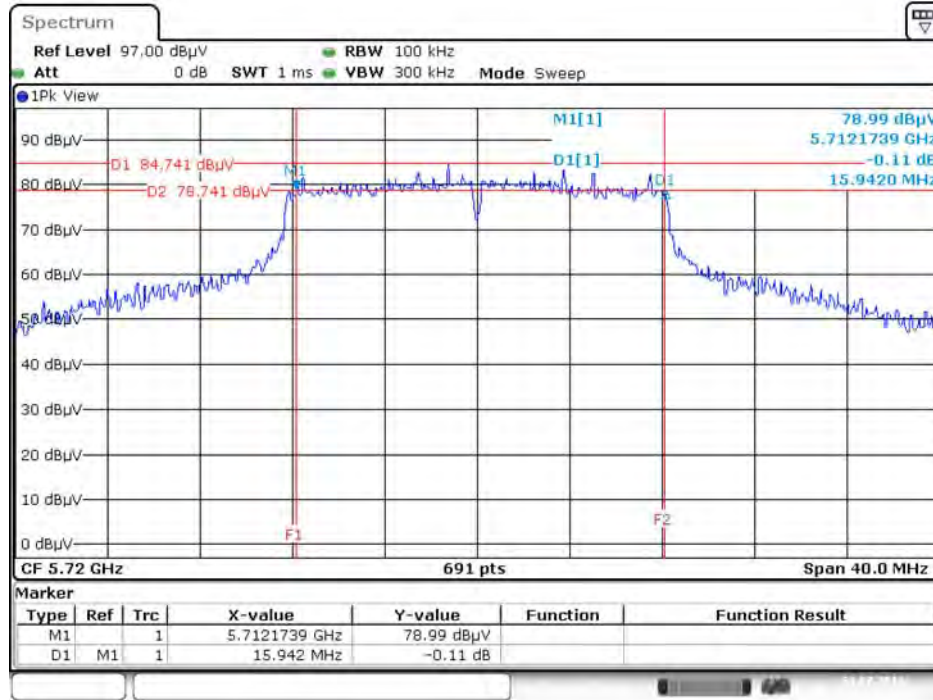

Date: 31.JUL.2016 10:52:00

6 dB Bandwidth Plot on Configuration IEEE 802.11n MCS0 HT20 / Ant. 1 + Ant. 2 / 5720 MHz

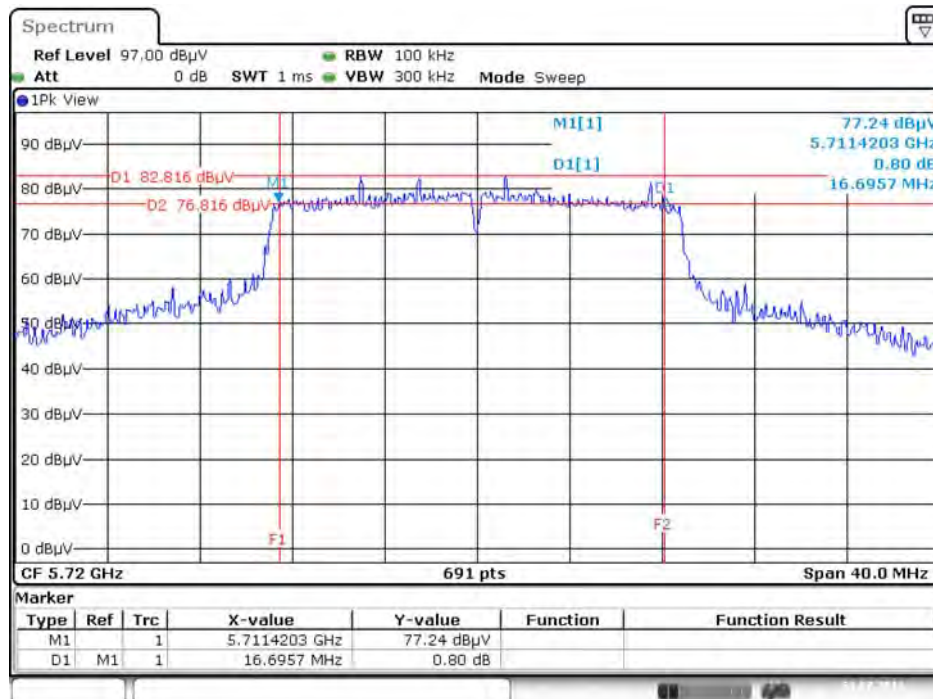

Date: 31.JUL.2016 10:53:03

6 dB Bandwidth Plot on Configuration IEEE 802.11n MCS0 HT40 / Ant. 1 + Ant. 2 / 5710 MHz

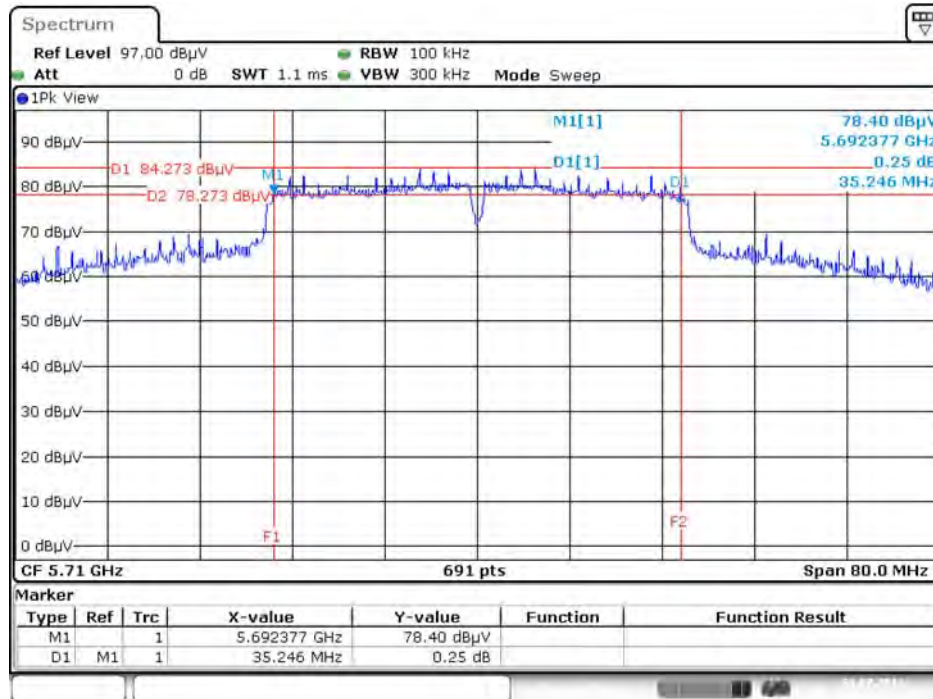

Date: 31.JUL.2016 10:54:37

4.4. Maximum Conducted Output Power Measurement

4.4.1. Limit

| Frequency Band | Limit |
|---|--|
| <input checked="" type="checkbox"/> 5.15~5.25 GHz | |
| Operating Mode | |
| <input type="checkbox"/> Outdoor access point | <p>The maximum conducted output power over the frequency band of operation shall not exceed 1 W (30dBm) provided the maximum antenna gain does not exceed 6 dBi. If transmitting antennas of directional gain greater than 6 dBi are used, both the maximum conducted output power and the maximum power spectral density shall be reduced by the amount in dB that the directional gain of the antenna exceeds 6 dBi. The maximum e.i.r.p. at any elevation angle above 30 degrees as measured from the horizon must not exceed 125 mW (21 dBm).</p> |
| <input type="checkbox"/> Indoor access point | <p>The maximum conducted output power over the frequency band of operation shall not exceed 1 W (30dBm) provided the maximum antenna gain does not exceed 6 dBi. If transmitting antennas of directional gain greater than 6 dBi are used, both the maximum conducted output power and the maximum power spectral density shall be reduced by the amount in dB that the directional gain of the antenna exceeds 6 dBi.</p> |
| <input type="checkbox"/> Fixed point-to-point access points | <p>The maximum conducted output power over the frequency band of operation shall not exceed 1 W (30dBm). Fixed point-to-point U-NII devices may employ antennas with directional gain up to 23 dBi without any corresponding reduction in the maximum conducted output power or maximum power spectral density. For fixed point-to-point transmitters that employ a directional antenna gain greater than 23 dBi, a 1 dB reduction in maximum conducted output power and maximum power spectral density is required for each 1 dB of antenna gain in excess of 23 dBi.</p> |
| <input checked="" type="checkbox"/> Client devices | <p>The maximum conducted output power over the frequency band of operation shall not exceed 250 mW (23.98dBm) provided the maximum antenna gain does not exceed 6 dBi. If transmitting antennas of directional gain greater than 6 dBi are used, both the maximum conducted output power and the maximum power spectral density shall be reduced by the amount in dB that the directional gain of the antenna exceeds 6 dBi.</p> |

| | | |
|-------------------------------------|-----------------|--|
| <input checked="" type="checkbox"/> | 5.25-5.35 GHz | The maximum conducted output power over the frequency bands of operation shall not exceed the lesser of 250 mW (23.98dBm) or 11 dBm 10 log B, where B is the 26 dB emission bandwidth in megahertz. If transmitting antennas of directional gain greater than 6 dBi are used, both the maximum conducted output power and the maximum power spectral density shall be reduced by the amount in dB that the directional gain of the antenna exceeds 6 dBi. |
| <input checked="" type="checkbox"/> | 5.470-5.725 GHz | |
| <input checked="" type="checkbox"/> | 5.725~5.85 GHz | The maximum conducted output power over the frequency band of operation shall not exceed 1 W (30dBm). If transmitting antennas of directional gain greater than 6 dBi are used, both the maximum conducted output power and the maximum power spectral density shall be reduced by the amount in dB that the directional gain of the antenna exceeds 6 dBi. However, fixed point-to-point U-NII devices operating in this band may employ transmitting antennas with directional gain greater than 6 dBi without any corresponding reduction in transmitter conducted power. |

4.4.2. Measuring Instruments and Setting

For straddle channel:

Please refer to section 5 of equipments list in this report. The following table is the setting of the spectrum analyzer.

| Spectrum Parameter | Setting |
|--------------------|--|
| Attenuation | Auto |
| Span Frequency | Encompass the entire emissions bandwidth (EBW) of the signal |
| RBW | 1000 kHz |
| VBW | 3000 kHz |
| Detector | RMS |
| Trace | Average Sweep count 100 |
| Sweep Time | Auto |

For other channel:

Please refer to section 5 of equipments list in this report. The following table is the setting of the power meter.

| Power Meter Parameter | Setting |
|-----------------------|--|
| Bandwidth | 50MHz bandwidth is greater than the EUT emission bandwidth |
| Detector | AVERAGE |

4.4.3. Test Procedures

For other channel:

The transmitter output (antenna port) was connected to the spectrum analyzer.

For straddle channel:

1. The transmitter output (antenna port) was connected to the power meter.
2. Test was performed in accordance with KDB789033 D02 v01r03 for Compliance Testing of Unlicensed National Information Infrastructure (U-NII) Devices - section (E) Maximum conducted output power =>3. Measurement using a Power Meter (PM) =>b) Method PM-G (Measurement using a gated RF average power meter).
3. Multiple antenna systems was performed in accordance with KDB662911 D01 v02r01 Emissions Testing of Transmitters with Multiple Outputs in the Same Band.
4. When measuring maximum conducted output power with multiple antenna systems, add every result of the values by mathematic formula.

4.4.4. Test Setup Layout

For straddle channel:

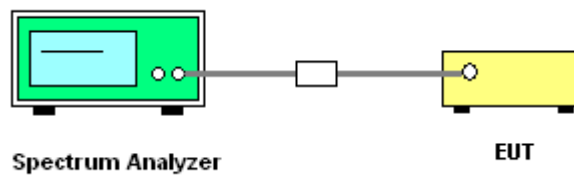

For other channel:

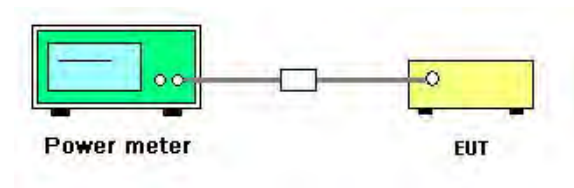

4.4.5. Test Deviation

There is no deviation with the original standard.

4.4.6. EUT Operation during Test

The EUT was programmed to be in continuously transmitting mode.

4.4.7. Test Result of Maximum Conducted Output Power

| | | | |
|---------------|----------|-----------|-----------------------------|
| Temperature | 25°C | Humidity | 56% |
| Test Engineer | Gary Chu | Test Date | Jul. 29, 2016~Aug. 13, 2016 |

| Mode | Frequency | Conducted Power (dBm) | | | Max. Limit (dBm) | Result |
|----------------------|-----------|-----------------------|--------|-------|------------------|----------|
| | | Ant. 1 | Ant. 2 | Total | | |
| 802.11a | 5180 MHz | 18.41 | 18.51 | 21.47 | 23.46 | Complies |
| | 5200 MHz | 18.56 | 18.32 | 21.45 | 23.46 | Complies |
| | 5240 MHz | 18.08 | 18.05 | 21.08 | 23.46 | Complies |
| | 5260 MHz | 18.50 | 18.38 | 21.45 | 23.46 | Complies |
| | 5300 MHz | 18.51 | 18.42 | 21.48 | 23.46 | Complies |
| | 5320 MHz | 18.32 | 18.09 | 21.22 | 23.46 | Complies |
| | 5500 MHz | 17.95 | 18.01 | 20.99 | 23.46 | Complies |
| | 5580 MHz | 18.35 | 18.45 | 21.41 | 23.46 | Complies |
| | 5700 MHz | 17.00 | 17.21 | 20.12 | 23.46 | Complies |
| | 5745 MHz | 19.22 | 19.43 | 22.34 | 29.48 | Complies |
| | 5785 MHz | 18.88 | 19.22 | 22.06 | 29.48 | Complies |
| | 5825 MHz | 19.21 | 19.64 | 22.44 | 29.48 | Complies |
| 802.11n MCS0 HT20 | 5180 MHz | 18.43 | 18.67 | 21.56 | 23.46 | Complies |
| | 5200 MHz | 18.64 | 18.32 | 21.49 | 23.46 | Complies |
| | 5240 MHz | 17.42 | 17.63 | 20.54 | 23.46 | Complies |
| | 5260 MHz | 18.71 | 18.29 | 21.52 | 23.46 | Complies |
| | 5300 MHz | 18.53 | 18.46 | 21.51 | 23.46 | Complies |
| | 5320 MHz | 18.59 | 18.12 | 21.37 | 23.46 | Complies |
| | 5500 MHz | 18.16 | 18.16 | 21.17 | 23.46 | Complies |
| | 5580 MHz | 18.19 | 18.67 | 21.45 | 23.46 | Complies |
| | 5700 MHz | 16.11 | 16.33 | 19.23 | 23.46 | Complies |
| | 5745 MHz | 19.69 | 19.98 | 22.85 | 29.48 | Complies |
| | 5785 MHz | 19.29 | 19.74 | 22.53 | 29.48 | Complies |
| | 5825 MHz | 19.77 | 19.98 | 22.89 | 29.48 | Complies |

Note: Max. antenna gain=6.52dBi >6dBi.

5GHz band 1~3 power limit= $23.98 - (6.52 - 6) = 23.46\text{dBm}$.

5GHz band 4 power limit= $30 - (6.52 - 6) = 29.48\text{dBm}$.

| Mode | Frequency | Conducted Power (dBm) | | | Max. Limit (dBm) | Result |
|----------------------|-----------|-----------------------|--------|-------|------------------|----------|
| | | Ant. 1 | Ant. 2 | Total | | |
| 802.11n MCS0 HT40 | 5190 MHz | 15.24 | 15.4 | 18.33 | 23.46 | Complies |
| | 5230 MHz | 18.69 | 18.83 | 21.77 | 23.46 | Complies |
| | 5270 MHz | 18.76 | 19.13 | 21.96 | 23.46 | Complies |
| | 5310 MHz | 14.54 | 14.86 | 17.71 | 23.46 | Complies |
| | 5510 MHz | 11.40 | 11.86 | 14.65 | 23.46 | Complies |
| | 5550 MHz | 18.46 | 18.48 | 21.48 | 23.46 | Complies |
| | 5670 MHz | 15.95 | 16.15 | 19.06 | 23.46 | Complies |
| | 5755 MHz | 18.29 | 18.69 | 21.50 | 29.48 | Complies |
| | 5795 MHz | 18.81 | 19.23 | 22.04 | 29.48 | Complies |

Note: Max. antenna gain=6.52dBi >6dBi.

5GHz band 1~3 power limit= $23.98 - (6.52 - 6) = 23.46\text{dBm}$.

5GHz band 4 power limit= $30 - (6.52 - 6) = 29.48\text{dBm}$.

Straddle Channel

| Mode | Frequency | Conducted Power (dBm) | | | Max. Power Limit (dBm) | Result |
|-------------------|-----------------------|-----------------------|--------|-------|------------------------|----------|
| | | Ant. 1 | Ant. 2 | Total | | |
| 802.11a | 5720 MHz (UNII 2C) | 16.90 | 17.00 | 19.96 | 23.46 | Complies |
| | 5720 MHz (UNII 3) | 10.60 | 9.09 | 12.92 | 29.48 | Complies |
| 802.11n MCS0 HT20 | 5720 MHz (UNII 2C) | 17.41 | 17.56 | 20.50 | 23.46 | Complies |
| | 5720 MHz (UNII 3) | 11.57 | 11.79 | 14.69 | 29.48 | Complies |
| 802.11n MCS0 HT40 | 5710 MHz (UNII 2C) | 20.61 | 20.26 | 23.45 | 23.46 | Complies |
| | 5710 MHz (UNII 3) | 9.84 | 9.57 | 12.72 | 29.48 | Complies |

Note: Max. antenna gain=6.52dBi >6dBi.

(UNII 2C) power limit= $23.98 - (6.52 - 6) = 23.46\text{dBm}$.

(UNII 3) power limit= $30 - (6.52 - 6) = 29.48\text{dBm}$.

Note: All the test values were listed in the report.

For plots, only the straddle channel result was shown.

Straddle Channel

Conducted Output Power Plot on Configuration IEEE 802.11a / Ant. 1 / 5720 MHz (UNII 2C)

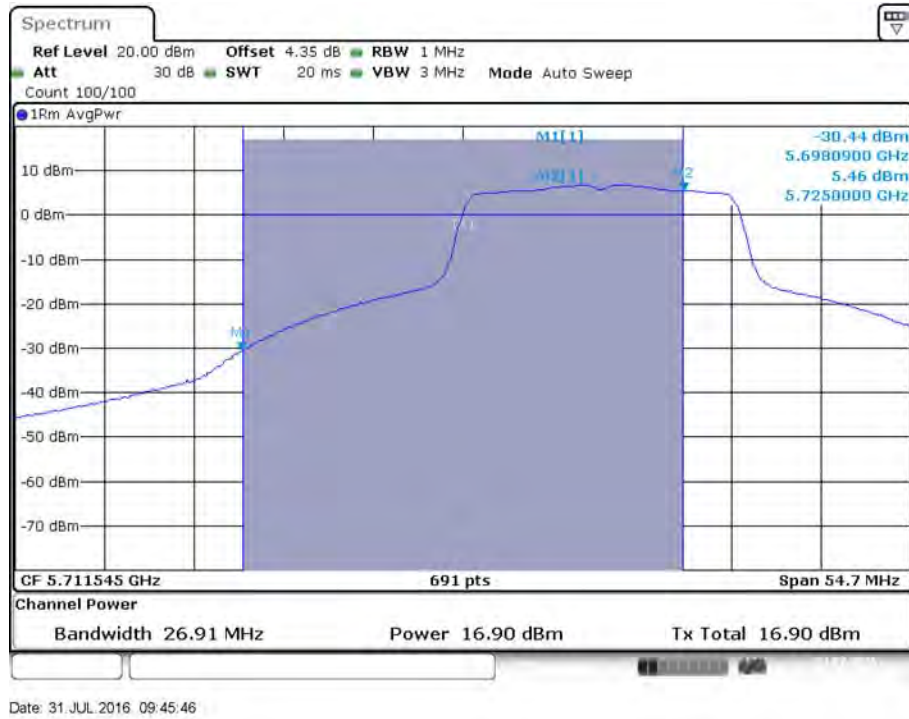

Conducted Output Power Plot on Configuration IEEE 802.11a / Ant. 2 / 5720 MHz (UNII 2C)

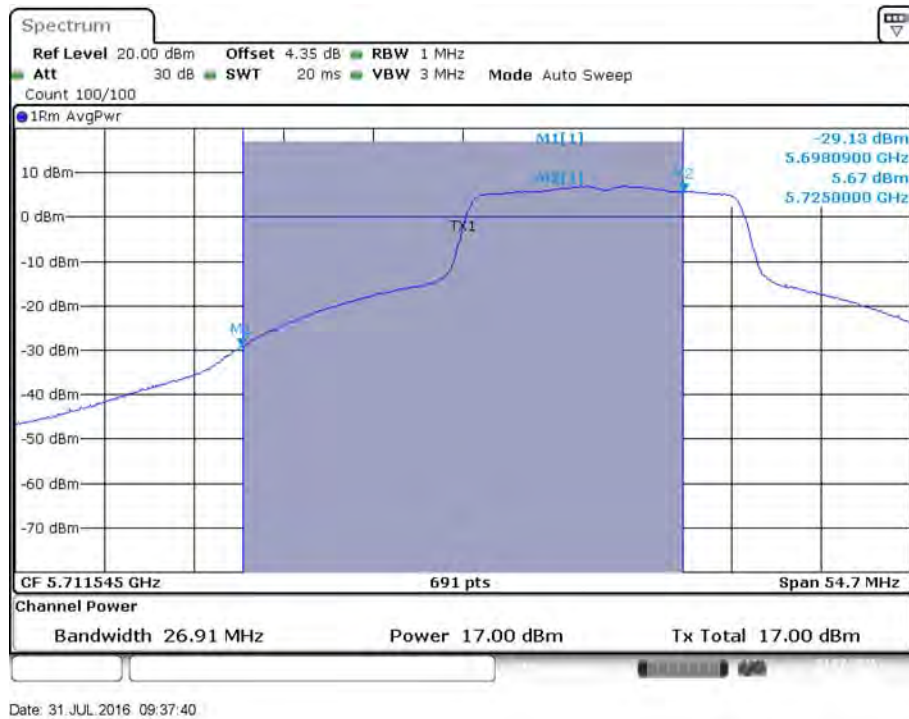

Conducted Output Power Plot on Configuration IEEE 802.11a / Ant. 1 / 5720 MHz (UNII 3)

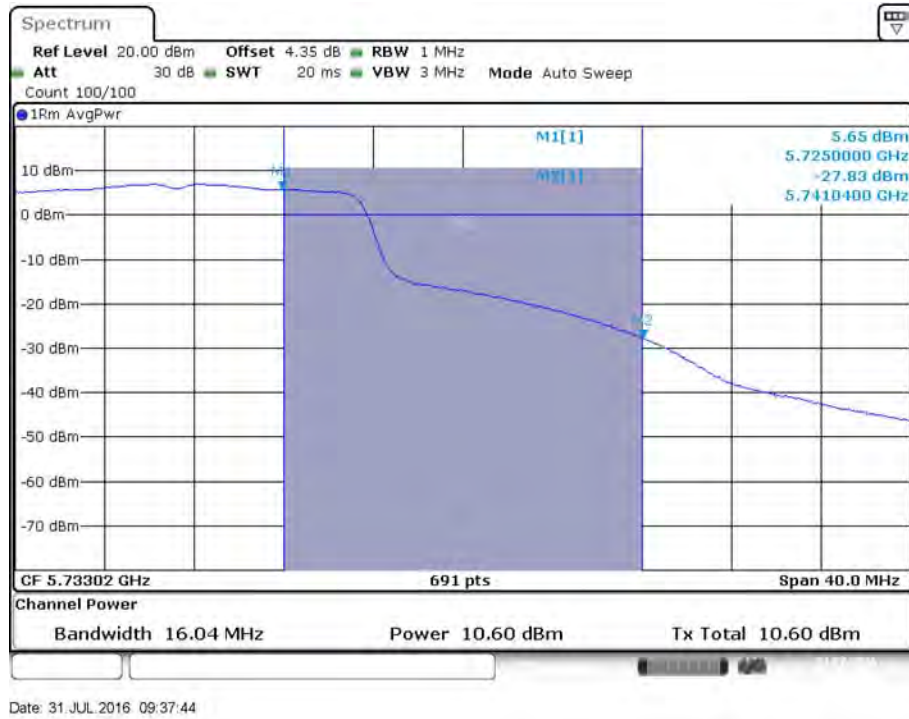

Conducted Output Power Plot on Configuration IEEE 802.11a / Ant. 2 / 5720 MHz (UNII 3)

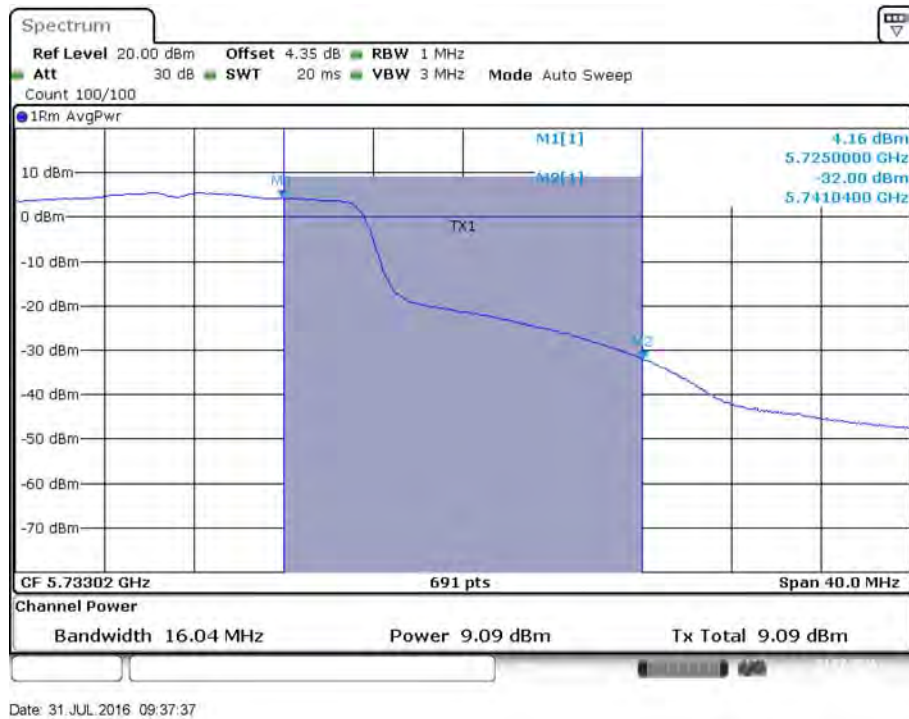

Conducted Output Power Plot on Configuration IEEE 802.11n MCS0 HT20 / Ant. 1 / 5720 MHz (UNII 2C)

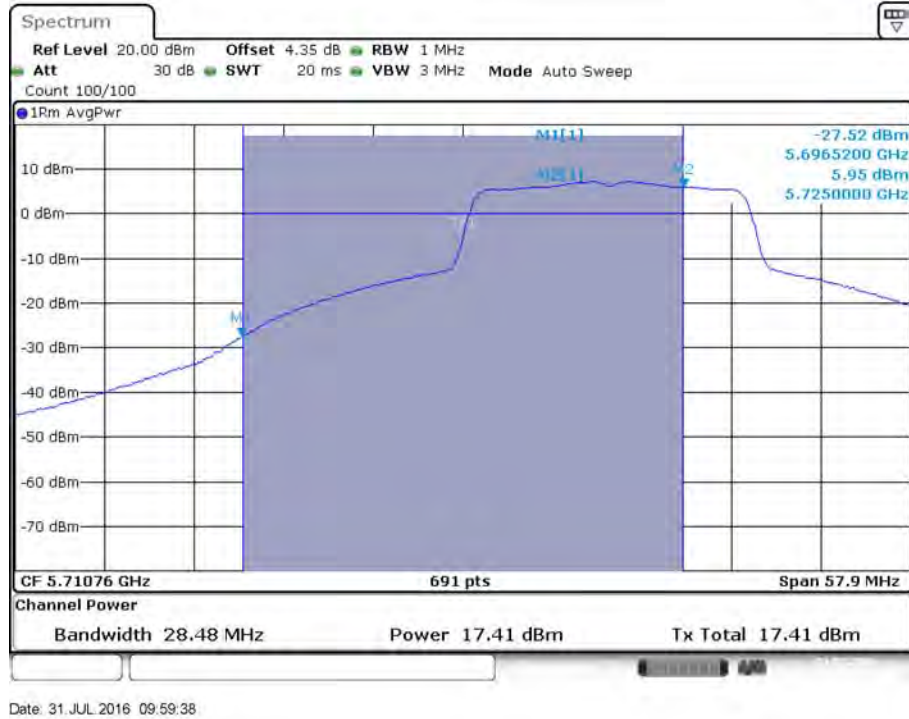

Conducted Output Power Plot on Configuration IEEE 802.11n MCS0 HT20 / Ant. 2 / 5720 MHz (UNII 2C)

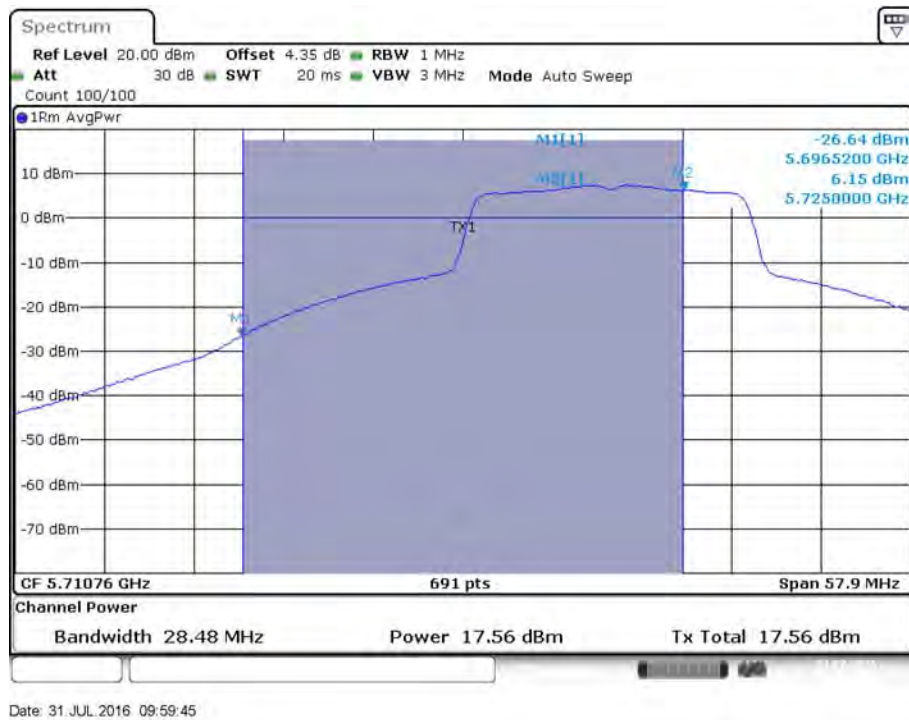

Conducted Output Power Plot on Configuration IEEE 802.11n MCS0 HT20 / Ant. 1 / 5720 MHz (UNII 3)

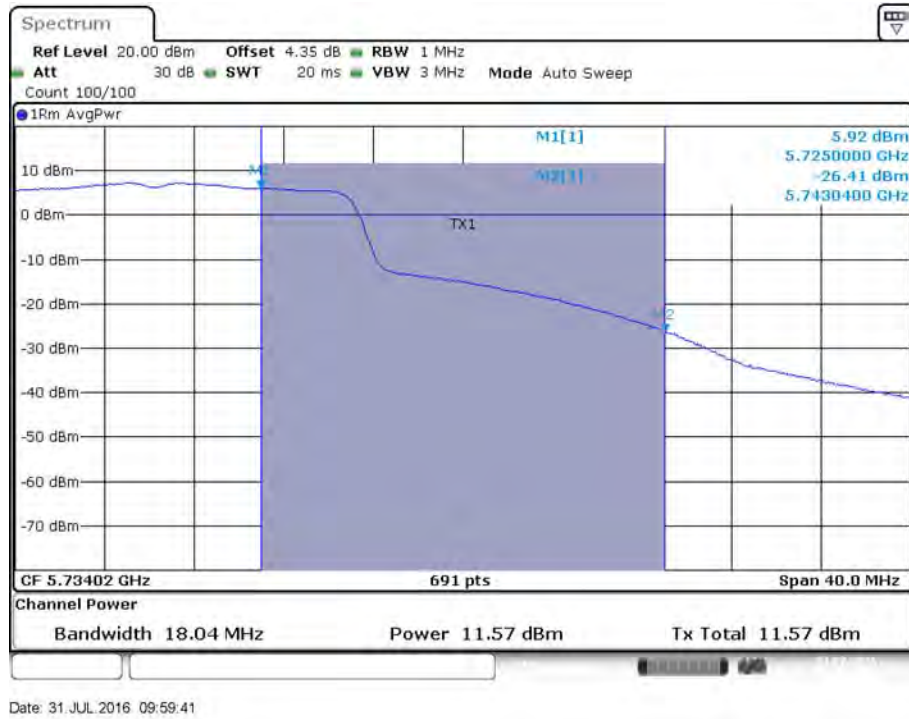

Conducted Output Power Plot on Configuration IEEE 802.11n MCS0 HT20 / Ant. 2 / 5720 MHz (UNII 3)



Conducted Output Power Plot on Configuration IEEE 802.11n MCS0 HT40 / Ant. 1 / 5710 MHz (UNII 2C)

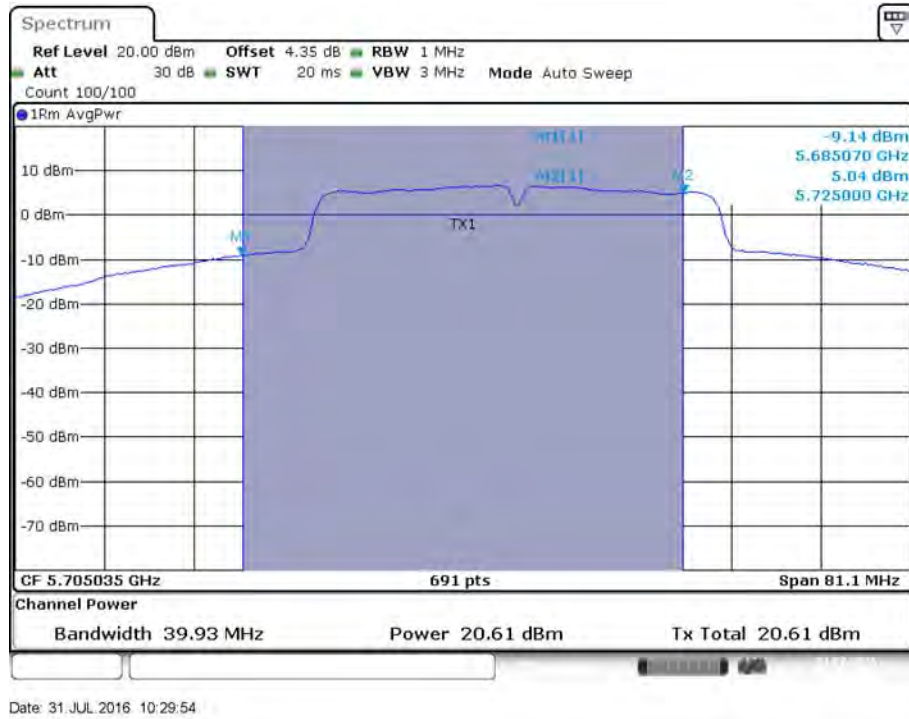

Conducted Output Power Plot on Configuration IEEE 802.11n MCS0 HT40 / Ant. 2 / 5710 MHz (UNII 2C)

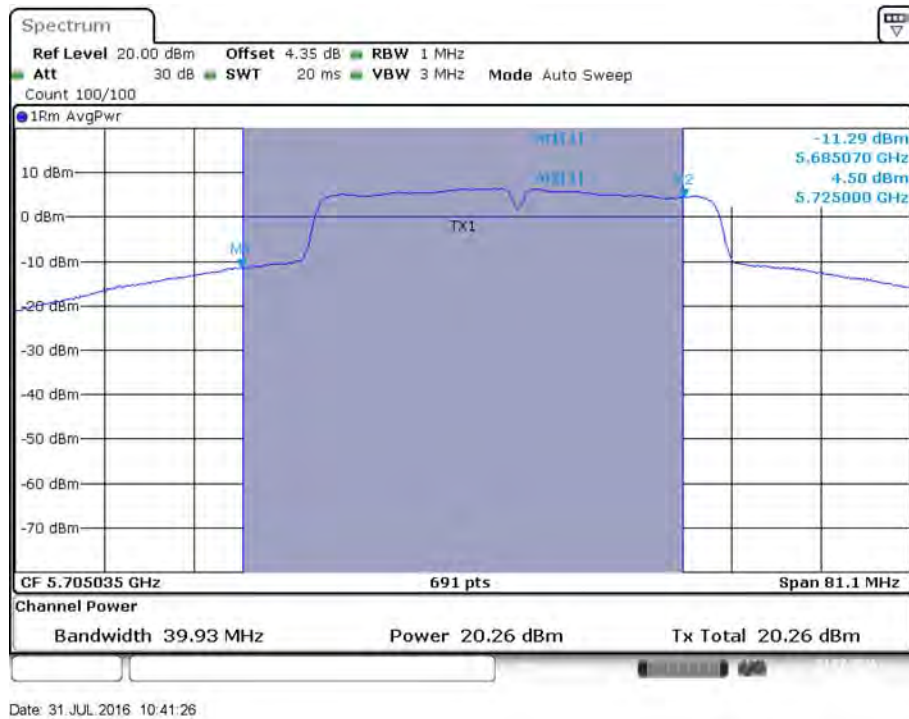

Conducted Output Power Plot on Configuration IEEE 802.11n MCS0 HT40 / Ant. 1 / 5710 MHz (UNII 3)

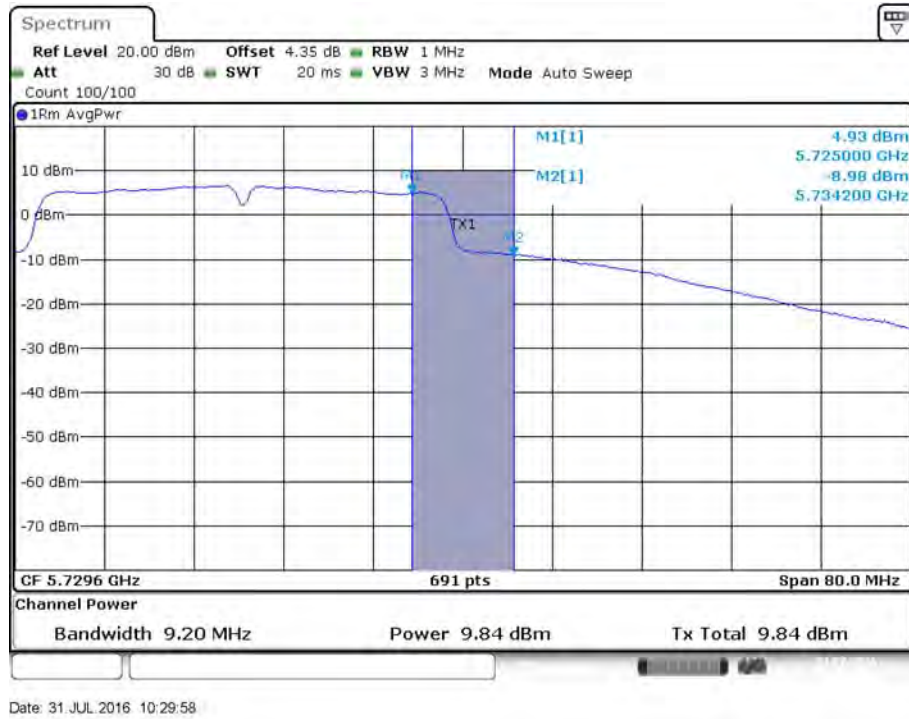

Conducted Output Power Plot on Configuration IEEE 802.11n MCS0 HT40 / Ant. 2 / 5710 MHz (UNII 3)

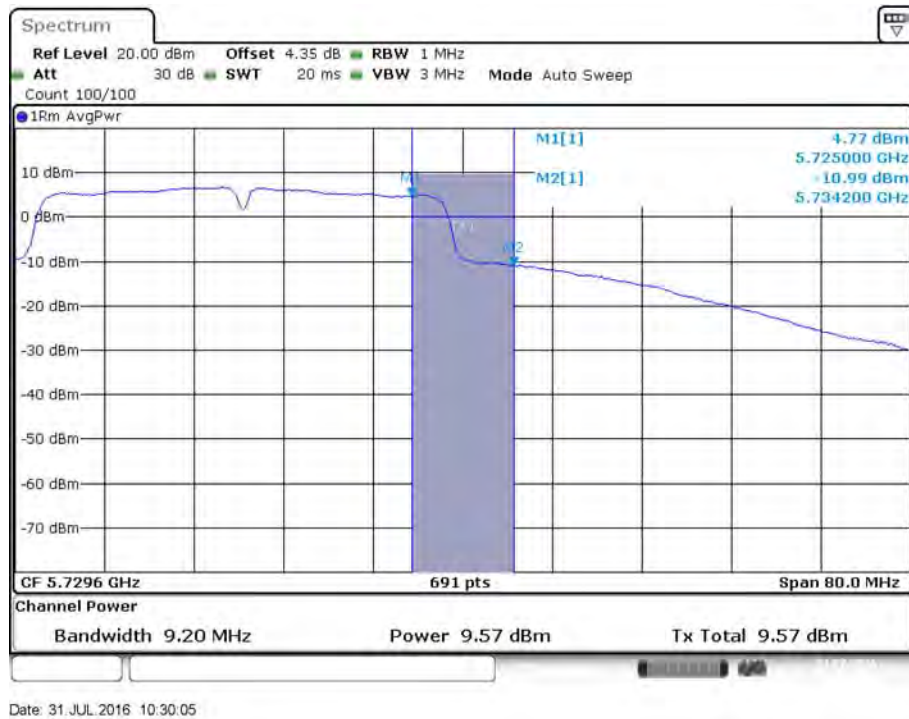

4.5. Power Spectral Density Measurement

4.5.1. Limit

The following table is power spectral density limits and decrease power density limit rule refer to section 4.4.1.

| Frequency Band | | Limit |
|-------------------------------------|------------------------------------|---------------|
| <input checked="" type="checkbox"/> | 5.15~5.25 GHz | |
| | Operating Mode | |
| <input type="checkbox"/> | Outdoor access point | 17 dBm/MHz |
| <input type="checkbox"/> | Indoor access point | 17 dBm/MHz |
| <input type="checkbox"/> | Fixed point-to-point access points | 17 dBm/MHz |
| <input checked="" type="checkbox"/> | Client devices | 11 dBm/MHz |
| <input checked="" type="checkbox"/> | 5.25-5.35 GHz | 11 dBm/MHz |
| <input checked="" type="checkbox"/> | 5.470-5.725 GHz | 11 dBm/MHz |
| <input checked="" type="checkbox"/> | 5.725~5.85 GHz | 30 dBm/500kHz |

4.5.2. Measuring Instruments and Setting

Please refer to section 5 of equipments list in this report. The following table is the setting of the spectrum analyzer.

| Spectrum Parameter | Setting |
|--|--|
| Attenuation | Auto |
| Span Frequency | Encompass the entire emissions bandwidth (EBW) of the signal |
| RBW | 1000 kHz |
| VBW | 3000 kHz |
| Detector | RMS |
| Trace | AVERAGE |
| Sweep Time | Auto |
| Trace Average | 100 times |
| Note: If measurement bandwidth of Maximum PSD is specified in 500 kHz, add $10\log(500\text{kHz}/\text{RBW})$ to the measured result, whereas RBW (< 500 kHz) is the reduced resolution bandwidth of the spectrum analyzer set during measurement. | |

4.5.3. Test Procedures

1. The transmitter output (antenna port) was connected RF switch to the spectrum analyzer.
2. Test was performed in accordance with KDB789033 D02 v01r03 for Compliance Testing of Unlicensed National Information Infrastructure (U-NII) Devices - section (F) Maximum Power Spectral Density (PSD).
3. Multiple antenna systems was performed in accordance KDB662911 D01 v02r01 in-Band Power Spectral Density (PSD) Measurements and sum the spectra across the outputs.
4. For 5.725~5.85 GHz, the measured result of PSD level must add $10\log(500\text{kHz}/\text{RBW})$ and the final result should ≤ 30 dBm.

4.5.4. Test Setup Layout

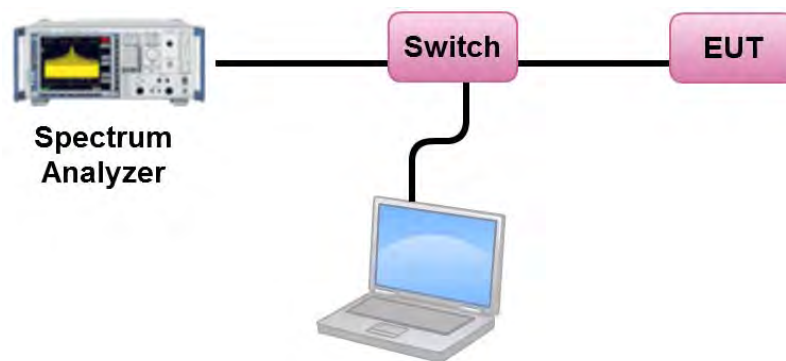

4.5.5. Test Deviation

There is no deviation with the original standard.

4.5.6. EUT Operation during Test

The EUT was programmed to be in continuously transmitting mode.

4.5.7. Test Result of Power Spectral Density

| | | | |
|---------------|----------|-----------|-----------------------------|
| Temperature | 25°C | Humidity | 56% |
| Test Engineer | Gary Chu | Test Date | Jul. 29, 2016~Aug. 13, 2016 |

Configuration IEEE 802.11a / Ant. 1 + Ant. 2

| Channel | Frequency | Power Density (dBm/MHz) | Max. Limit (dBm/MHz) | Result |
|---------|-----------|-------------------------|----------------------|----------|
| 36 | 5180 MHz | 7.96 | 8.22 | Complies |
| 40 | 5200 MHz | 8.17 | 8.22 | Complies |
| 48 | 5240 MHz | 8.07 | 8.22 | Complies |
| 52 | 5260 MHz | 8.08 | 8.22 | Complies |
| 60 | 5300 MHz | 8.09 | 8.22 | Complies |
| 64 | 5320 MHz | 8.00 | 8.22 | Complies |
| 100 | 5500 MHz | 8.04 | 8.22 | Complies |
| 116 | 5580 MHz | 8.01 | 8.22 | Complies |
| 140 | 5700 MHz | 6.68 | 8.22 | Complies |

Note: $Directional\ Gain = 10\log\left[\frac{\sum_{j=1}^{N_{SS}}\left\{\sum_{K=1}^{N_{ANT}}g_{j,k}\right\}^2}{N_{ANT}}\right] = 8.78\text{dBi} > 6\text{dBi}$, so limit = $11 - (8.78 - 6) = 8.22\text{dBm/MHz}$.

| Channel | Frequency | Power Density (dBm/MHz) | 10log(500kHz/RBW) Factor (dB) | Power Density (dBm/500kHz) | Power Density Limit (dBm/500kHz) | Result |
|---------|-----------|-------------------------|-------------------------------|----------------------------|----------------------------------|----------|
| 149 | 5745 MHz | 8.82 | -3.01 | 5.81 | 27.22 | Complies |
| 157 | 5785 MHz | 8.61 | -3.01 | 5.60 | 27.22 | Complies |
| 165 | 5825 MHz | 9.20 | -3.01 | 6.19 | 27.22 | Complies |

Note: $Directional\ Gain = 10\log\left[\frac{\sum_{j=1}^{N_{SS}}\left\{\sum_{K=1}^{N_{ANT}}g_{j,k}\right\}^2}{N_{ANT}}\right] = 8.78\text{dBi} > 6\text{dBi}$, so limit = $30 - (8.78 - 6) = 27.22\text{dBm/500kHz}$.

Configuration IEEE 802.11n MCS0 HT20 / Ant. 1 + Ant. 2

| Channel | Frequency | Power Density (dBm/MHz) | Max. Limit (dBm/MHz) | Result |
|---------|-----------|-------------------------|----------------------|----------|
| 36 | 5180 MHz | 8.10 | 8.22 | Complies |
| 40 | 5200 MHz | 8.06 | 8.22 | Complies |
| 48 | 5240 MHz | 7.05 | 8.22 | Complies |
| 52 | 5260 MHz | 8.17 | 8.22 | Complies |
| 60 | 5300 MHz | 8.15 | 8.22 | Complies |
| 64 | 5320 MHz | 8.01 | 8.22 | Complies |
| 100 | 5500 MHz | 8.13 | 8.22 | Complies |
| 116 | 5580 MHz | 8.03 | 8.22 | Complies |
| 140 | 5700 MHz | 5.93 | 8.22 | Complies |

Note: $Directional\ Gain = 10 \log \left[\frac{\sum_{j=1}^{N_{SS}} \left\{ \sum_{K=1}^{N_{ANT}} g_{j,k} \right\}^2}{N_{ANT}} \right] = 8.78\text{dBi} > 6\text{dBi}$, so limit = $11 - (8.78 - 6) = 8.22\text{dBm/MHz}$.

| Channel | Frequency | Power Density (dBm/MHz) | 10log(500kHz/RBW) Factor (dB) | Power Density (dBm/500kHz) | Power Density Limit (dBm/500kHz) | Result |
|---------|-----------|-------------------------|-------------------------------|----------------------------|----------------------------------|----------|
| 149 | 5745 MHz | 9.43 | -3.01 | 6.42 | 27.22 | Complies |
| 157 | 5785 MHz | 9.21 | -3.01 | 6.20 | 27.22 | Complies |
| 165 | 5825 MHz | 9.65 | -3.01 | 6.64 | 27.22 | Complies |

Note: $Directional\ Gain = 10 \log \left[\frac{\sum_{j=1}^{N_{SS}} \left\{ \sum_{K=1}^{N_{ANT}} g_{j,k} \right\}^2}{N_{ANT}} \right] = 8.78\text{dBi} > 6\text{dBi}$, so limit = $30 - (8.78 - 6) = 27.22\text{dBm/500kHz}$.

Configuration IEEE 802.11n MCS0 HT40 / Ant. 1 + Ant. 2

| Channel | Frequency | Power Density (dBm/MHz) | Max. Limit (dBm/MHz) | Result |
|---------|-----------|-------------------------|----------------------|----------|
| 38 | 5190 MHz | 1.93 | 8.22 | Complies |
| 46 | 5230 MHz | 5.51 | 8.22 | Complies |
| 54 | 5270 MHz | 5.55 | 8.22 | Complies |
| 62 | 5310 MHz | 1.68 | 8.22 | Complies |
| 102 | 5510 MHz | -1.26 | 8.22 | Complies |
| 110 | 5550 MHz | 5.24 | 8.22 | Complies |
| 134 | 5670 MHz | 2.67 | 8.22 | Complies |

Note: $Directional\ Gain = 10\log\left[\frac{\sum_{j=1}^{N_{SS}}\left\{\sum_{K=1}^{N_{ANT}}g_{j,k}\right\}^2}{N_{ANT}}\right] = 8.78\text{dBi} > 6\text{dBi}$, so limit = $11 - (8.78 - 6) = 8.22\text{dBm/MHz}$.

| Channel | Frequency | Power Density (dBm/MHz) | 10log(500kHz/RBW) Factor (dB) | Power Density (dBm/500kHz) | Power Density Limit (dBm/500kHz) | Result |
|---------|-----------|-------------------------|-------------------------------|----------------------------|----------------------------------|----------|
| 151 | 5755 MHz | 5.11 | -3.01 | 2.10 | 27.22 | Complies |
| 159 | 5795 MHz | 5.78 | -3.01 | 2.77 | 27.22 | Complies |

Note: $Directional\ Gain = 10\log\left[\frac{\sum_{j=1}^{N_{SS}}\left\{\sum_{K=1}^{N_{ANT}}g_{j,k}\right\}^2}{N_{ANT}}\right] = 8.78\text{dBi} > 6\text{dBi}$, so limit = $30 - (8.78 - 6) = 27.22\text{dBm/500kHz}$.

Straddle Channel
Configuration IEEE 802.11a / Ant. 1 + Ant. 2

| Channel | Frequency | Power Density (dBm/MHz) | Max. Limit (dBm/MHz) | Result |
|---------|-----------------------|-------------------------|----------------------|----------|
| 144 | 5720 MHz (UNII 2C) | 7.89 | 8.22 | Complies |

Note: $Directional\ Gain = 10\log\left[\frac{\sum_{j=1}^{N_{SS}}\left\{\sum_{K=1}^{N_{ANT}}g_{j,k}\right\}^2}{N_{ANT}}\right] = 8.78\text{dBi} > 6\text{dBi}$, so limit = $11 - (8.78 - 6) = 8.22\text{dBm/MHz}$.

| Channel | Frequency | Power Density (dBm/MHz) | 10log(500kHz/RBW) Factor (dB) | Power Density (dBm/500kHz) | Power Density Limit (dBm/500kHz) | Result |
|---------|----------------------|-------------------------|-------------------------------|----------------------------|----------------------------------|----------|
| 144 | 5720 MHz (UNII 3) | 6.55 | -3.01 | 3.54 | 27.22 | Complies |

Note: $Directional\ Gain = 10\log\left[\frac{\sum_{j=1}^{N_{SS}}\left\{\sum_{K=1}^{N_{ANT}}g_{j,k}\right\}^2}{N_{ANT}}\right] = 8.78\text{dBi} > 6\text{dBi}$, so limit = $30 - (8.78 - 6) = 27.22\text{dBm/500kHz}$.

Configuration IEEE 802.11n MCS0 HT20 / Ant. 1 + Ant. 2

| Channel | Frequency | Power Density (dBm/MHz) | Max. Limit (dBm/MHz) | Result |
|---------|-----------------------|-------------------------|----------------------|----------|
| 144 | 5720 MHz (UNII 2C) | 8.20 | 8.22 | Complies |

Note: $Directional\ Gain = 10\log\left[\frac{\sum_{j=1}^{N_{SS}}\left\{\sum_{K=1}^{N_{ANT}}g_{j,k}\right\}^2}{N_{ANT}}\right] = 8.78\text{dBi} > 6\text{dBi}$, so limit = $11 - (8.78 - 6) = 8.22\text{dBm/MHz}$.

| Channel | Frequency | Power Density (dBm/MHz) | 10log(500kHz/RBW) Factor (dB) | Power Density (dBm/500kHz) | Power Density Limit (dBm/500kHz) | Result |
|---------|----------------------|-------------------------|-------------------------------|----------------------------|----------------------------------|----------|
| 144 | 5720 MHz (UNII 3) | 6.93 | -3.01 | 3.92 | 27.22 | Complies |

Note: $Directional\ Gain = 10\log\left[\frac{\sum_{j=1}^{N_{SS}}\left\{\sum_{K=1}^{N_{ANT}}g_{j,k}\right\}^2}{N_{ANT}}\right] = 8.78\text{dBi} > 6\text{dBi}$, so limit = $30 - (8.78 - 6) = 27.22\text{dBm/500kHz}$.

Configuration IEEE 802.11n MCS0 HT40 / Ant. 1 + Ant. 2

| Channel | Frequency | Power Density (dBm/MHz) | Max. Limit (dBm/MHz) | Result |
|---------|-----------------------|-------------------------|----------------------|----------|
| 142 | 5710 MHz (UNII 2C) | 8.07 | 8.22 | Complies |

Note: $Directional\ Gain = 10\log\left[\frac{\sum_{j=1}^{N_{SS}}\left\{\sum_{K=1}^{N_{ANT}}g_{j,k}\right\}^2}{N_{ANT}}\right] = 8.78\text{dBi} > 6\text{dBi}$, so limit = $11 - (8.78 - 6) = 8.22\text{dBm/MHz}$.

| Channel | Frequency | Power Density (dBm/MHz) | 10log(500kHz/RBW) Factor (dB) | Power Density (dBm/500kHz) | Power Density Limit (dBm/500kHz) | Result |
|---------|----------------------|-------------------------|-------------------------------|----------------------------|----------------------------------|----------|
| 142 | 5710 MHz (UNII 3) | 6.36 | -3.01 | 3.35 | 27.22 | Complies |

Note: $Directional\ Gain = 10\log\left[\frac{\sum_{j=1}^{N_{SS}}\left\{\sum_{K=1}^{N_{ANT}}g_{j,k}\right\}^2}{N_{ANT}}\right] = 8.78\text{dBi} > 6\text{dBi}$, so limit = $30 - (8.78 - 6) = 27.22\text{dBm/500kHz}$.

Note: All the test values were listed in the report.

For plots, only the channel with worse result was shown.

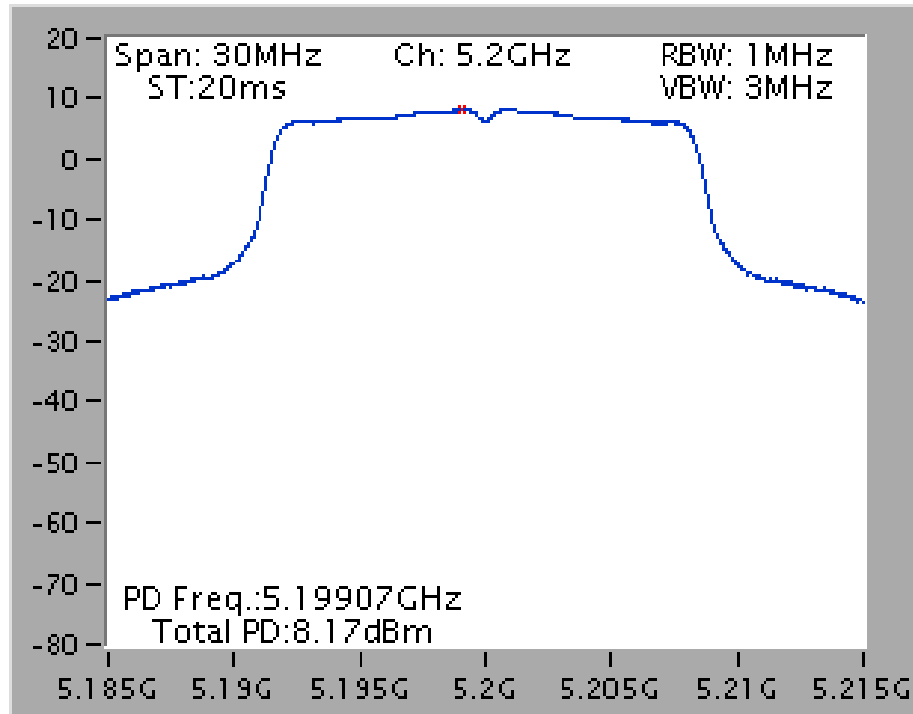
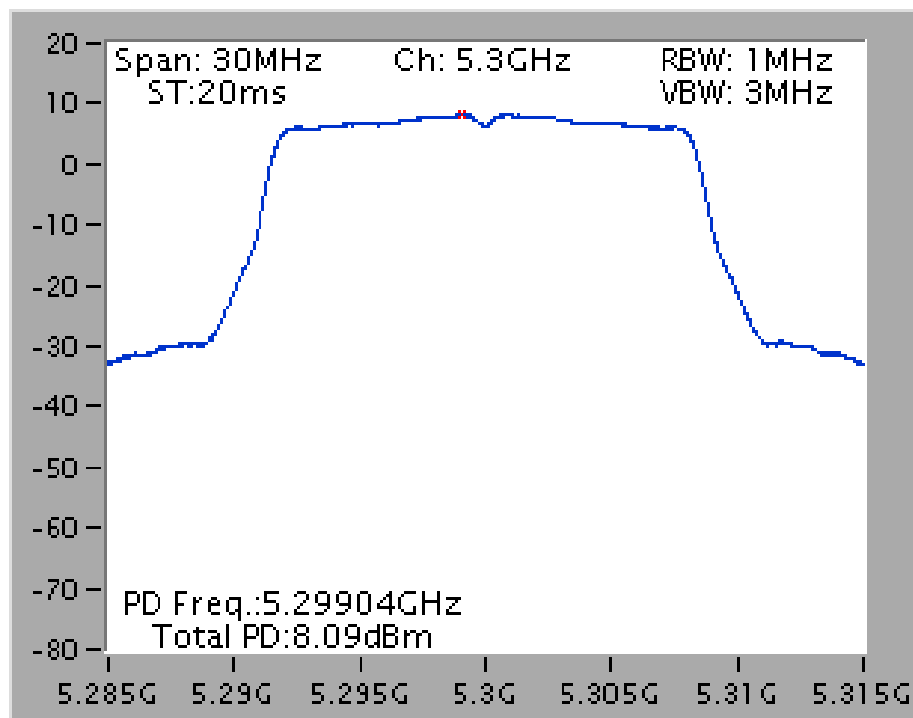
Power Density Plot on Configuration IEEE 802.11a / Ant. 1 + Ant. 2 / 5200 MHz**Power Density Plot on Configuration IEEE 802.11a / Ant. 1 + Ant. 2 / 5300 MHz**

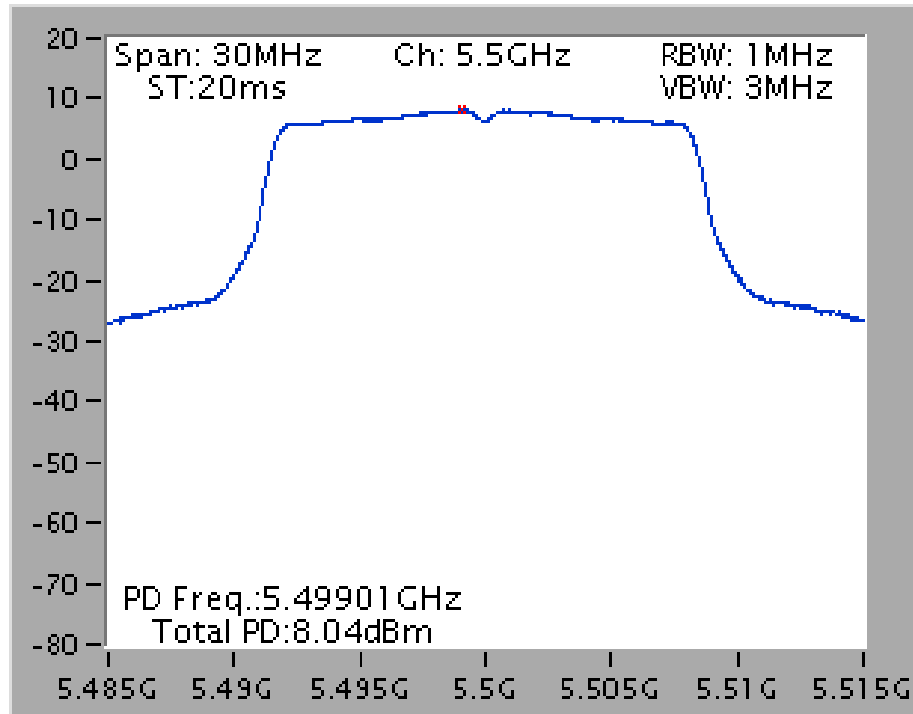
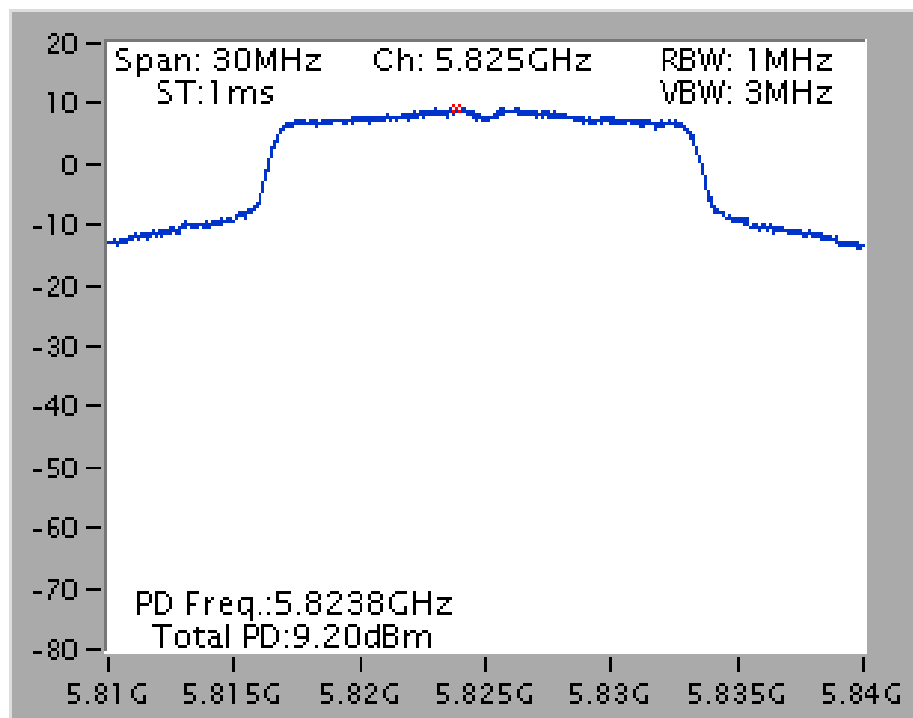
Power Density Plot on Configuration IEEE 802.11a / Ant. 1 + Ant. 2 / 5500 MHz**Power Density Plot on Configuration IEEE 802.11a / Ant. 1 + Ant. 2 / 5825 MHz**

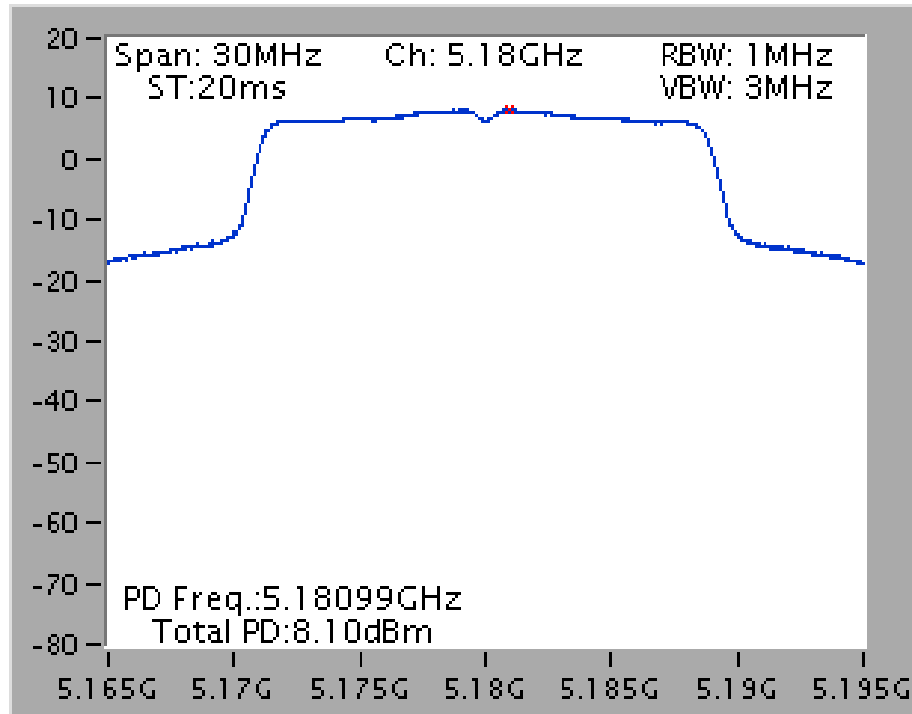
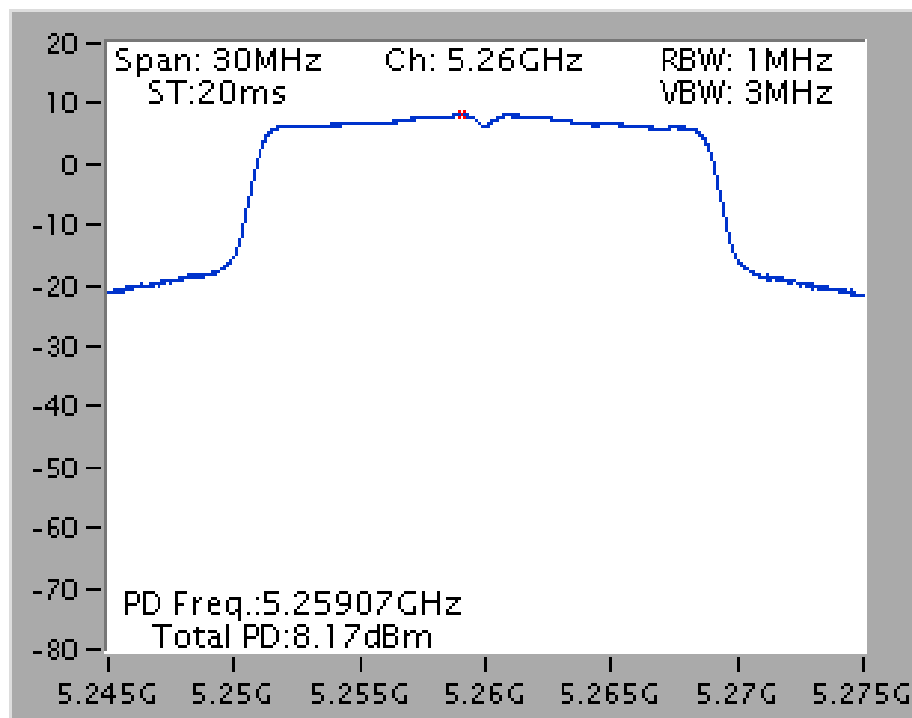
Power Density Plot on Configuration IEEE 802.11n MCS0 HT20 / Ant. 1 + Ant. 2 / 5180 MHz**Power Density Plot on Configuration IEEE 802.11n MCS0 HT20 / Ant. 1 + Ant. 2 / 5260 MHz**

Power Density Plot on Configuration IEEE 802.11n MCS0 HT20 / Ant. 1 + Ant. 2 / 5500 MHz

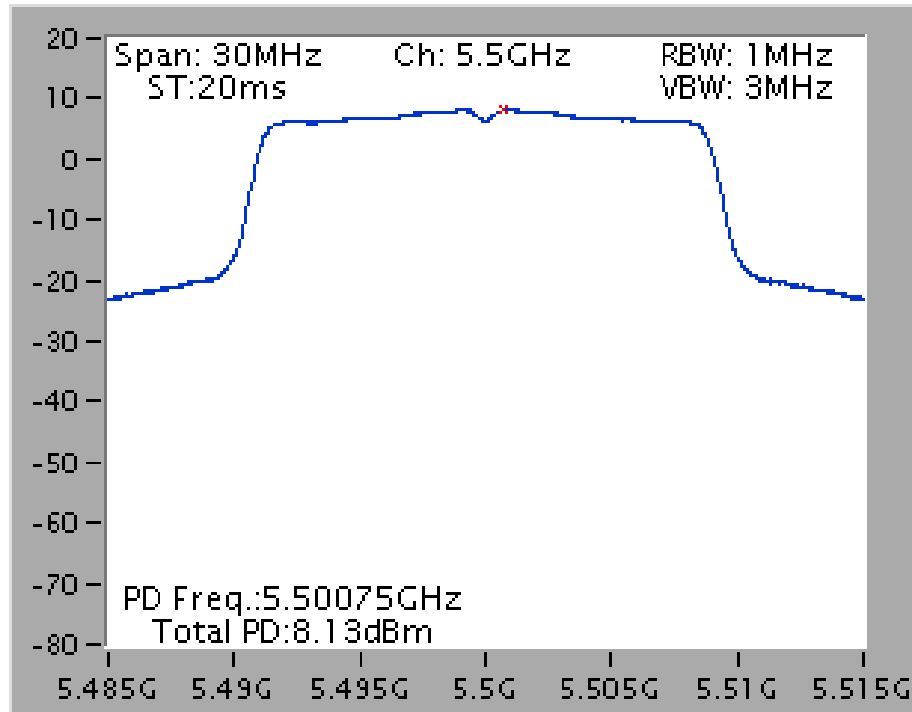

Power Density Plot on Configuration IEEE 802.11n MCS0 HT20 / Ant. 1 + Ant. 2 / 5825 MHz

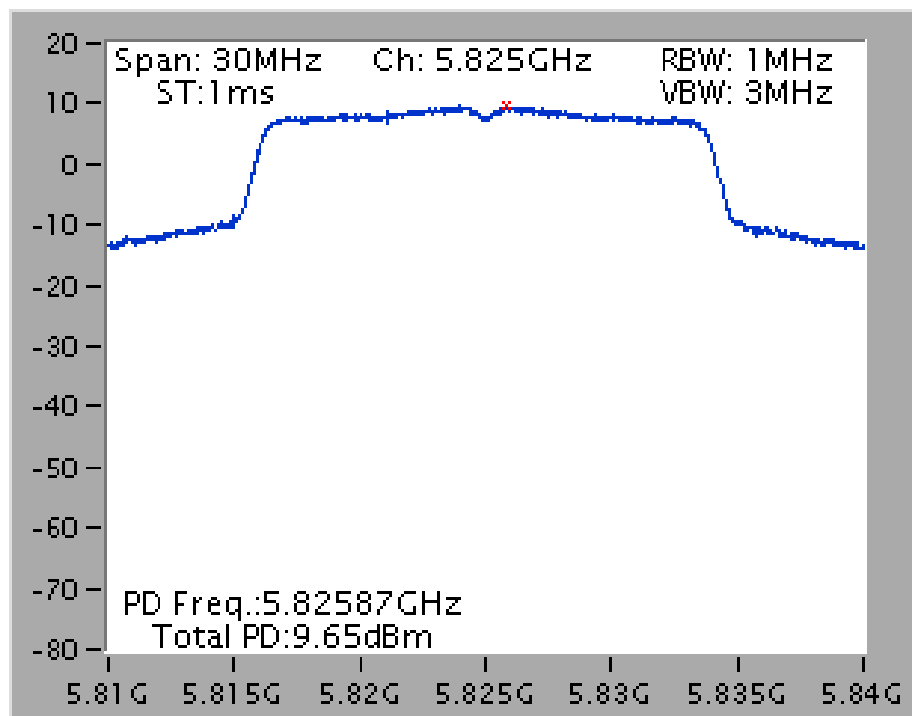

Power Density Plot on Configuration IEEE 802.11n MCS0 HT40 / Ant. 1 + Ant. 2 / 5230 MHz

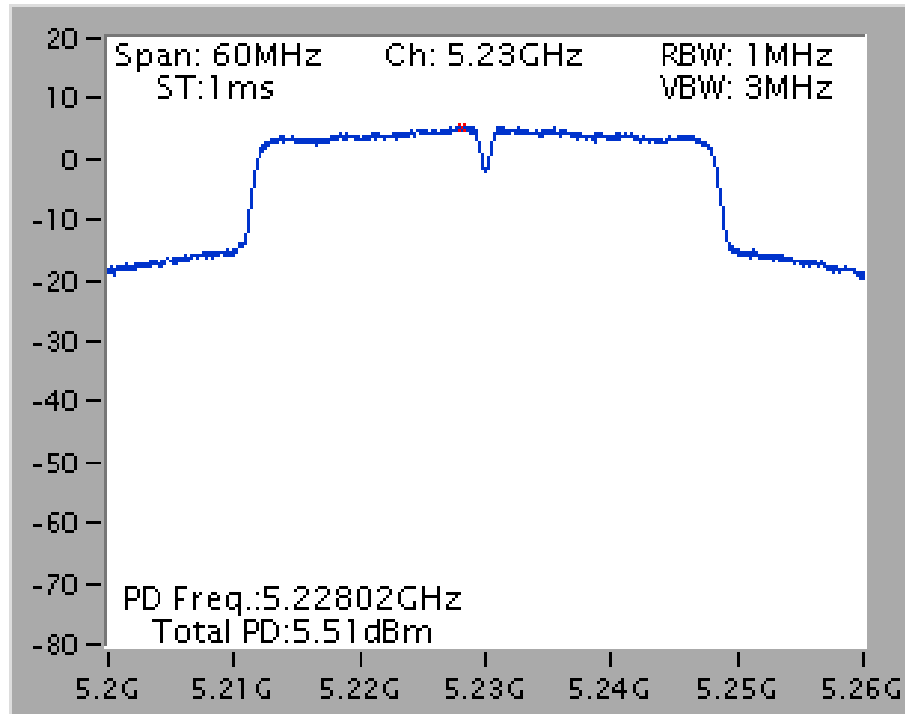

Power Density Plot on Configuration IEEE 802.11n MCS0 HT40 / Ant. 1 + Ant. 2 / 5270 MHz

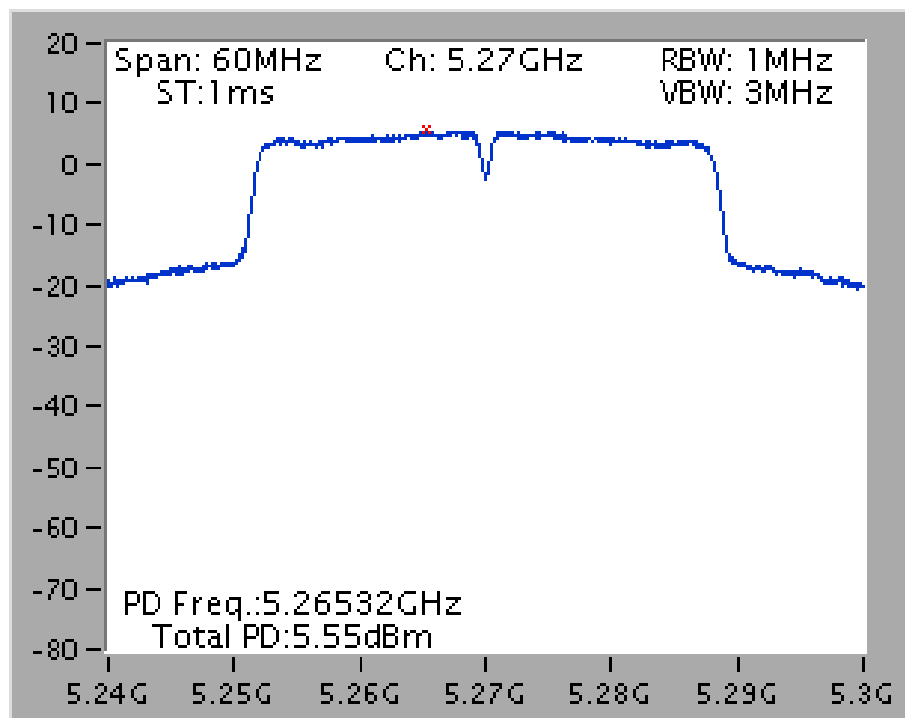

Power Density Plot on Configuration IEEE 802.11n MCS0 HT40 / Ant. 1 + Ant. 2 / 5550 MHz

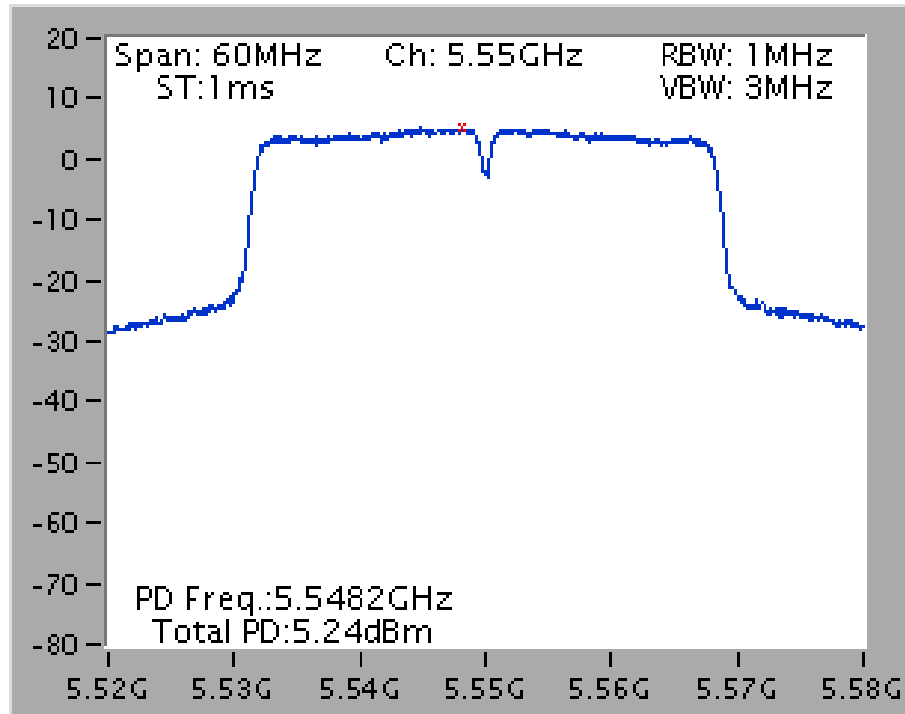

Power Density Plot on Configuration IEEE 802.11n MCS0 HT40 / Ant. 1 + Ant. 2 / 5795 MHz

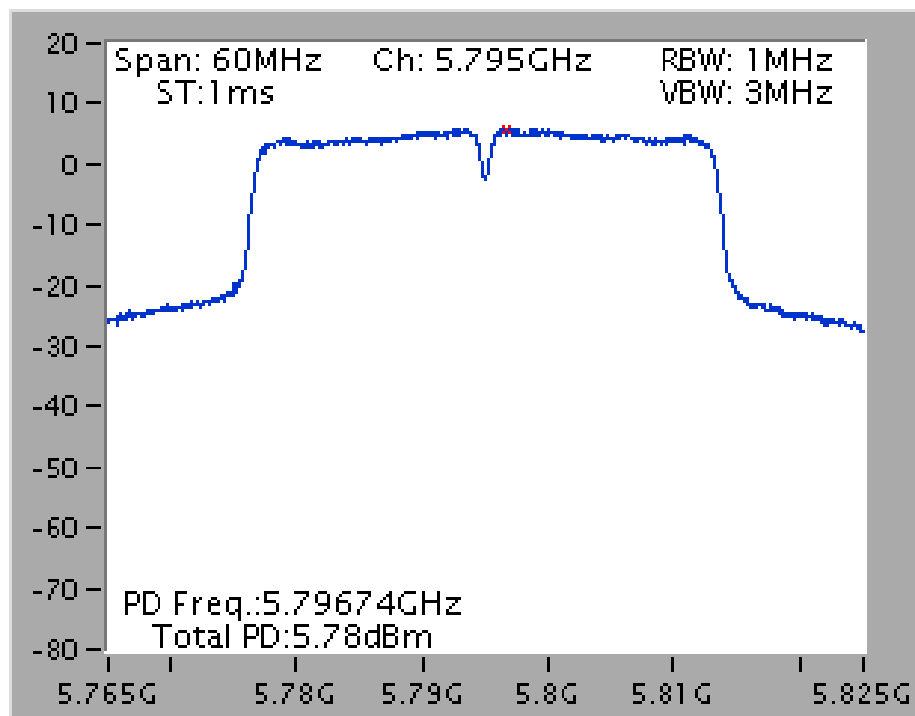

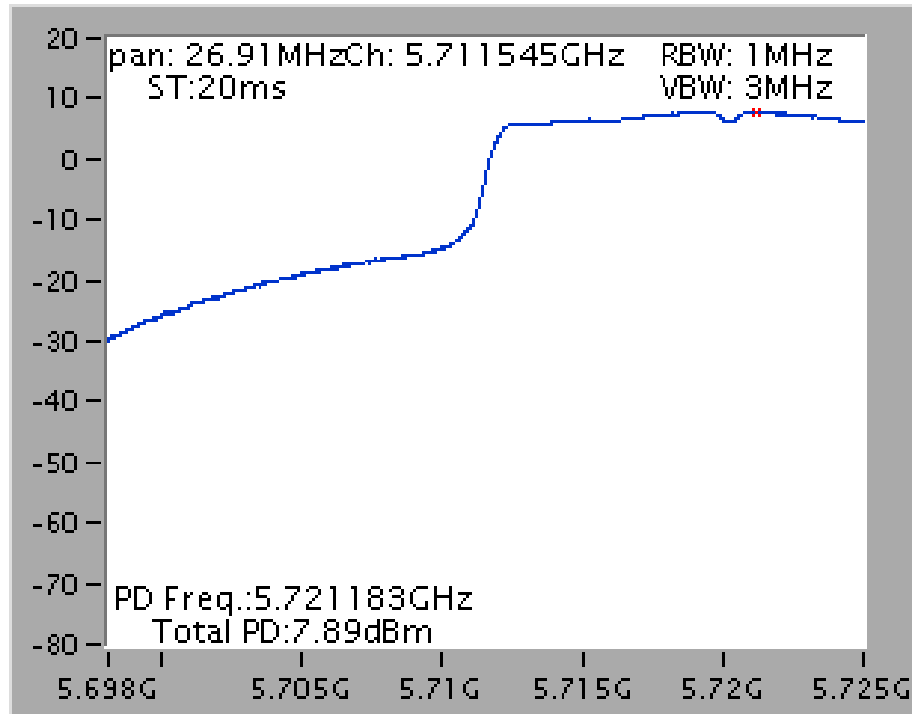
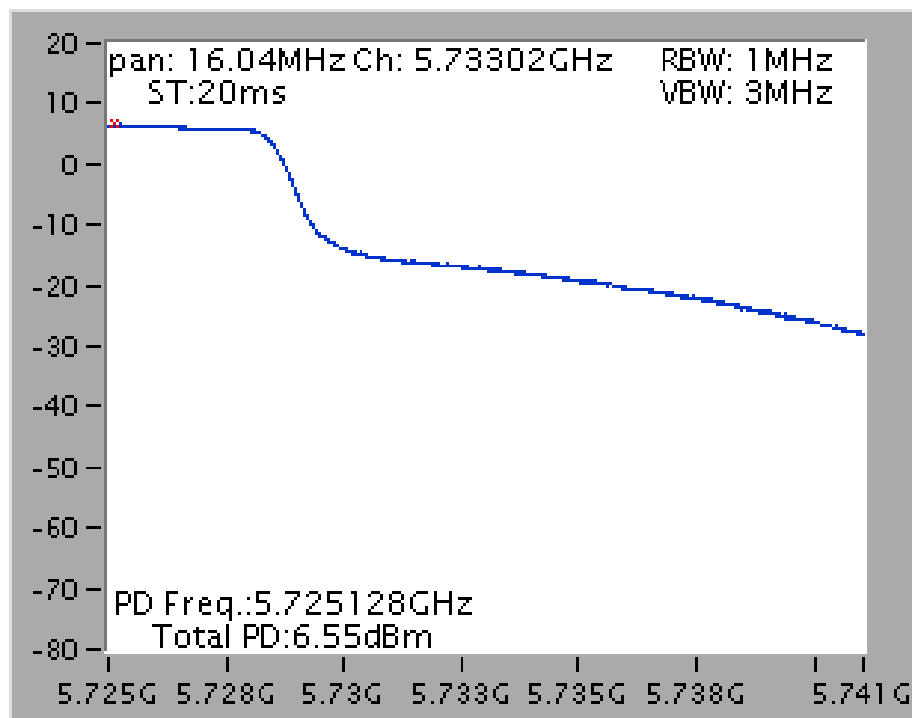
Straddle Channel**Power Density Plot on Configuration IEEE 802.11a / Ant. 1 + Ant. 2 / 5720 MHz (UNII 2C)****Power Density Plot on Configuration IEEE 802.11a / Ant. 1 + Ant. 2 / 5720 MHz (UNII 3)**

Power Density Plot on Configuration IEEE 802.11n MCS0 HT20 / Ant. 1 + Ant. 2 / 5720 MHz (UNII 2C)

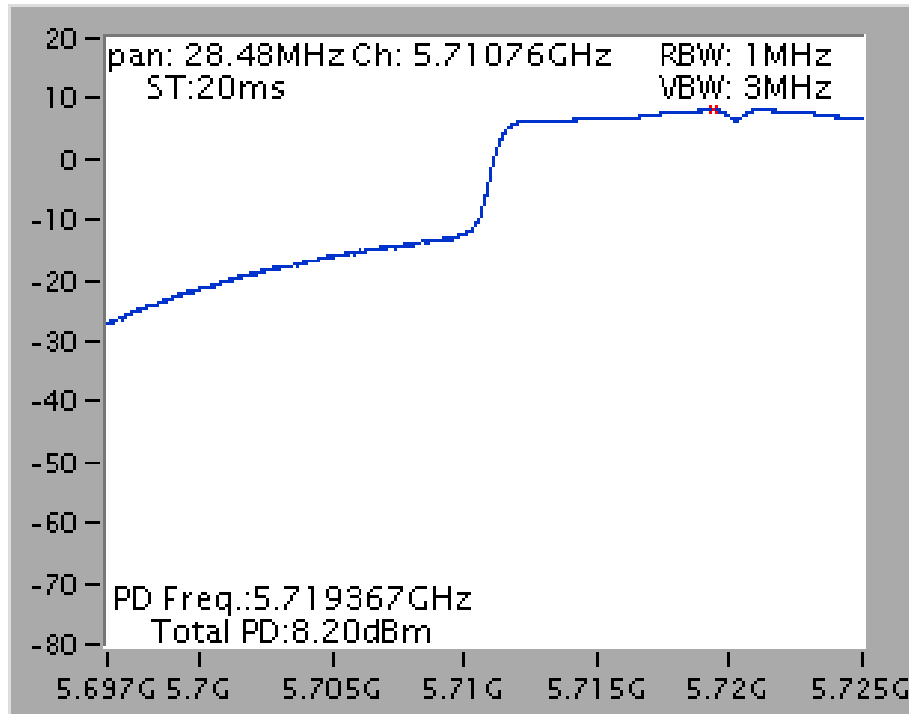

Power Density Plot on Configuration IEEE 802.11n MCS0 HT20 / Ant. 1 + Ant. 2 / 5720 MHz (UNII 3)

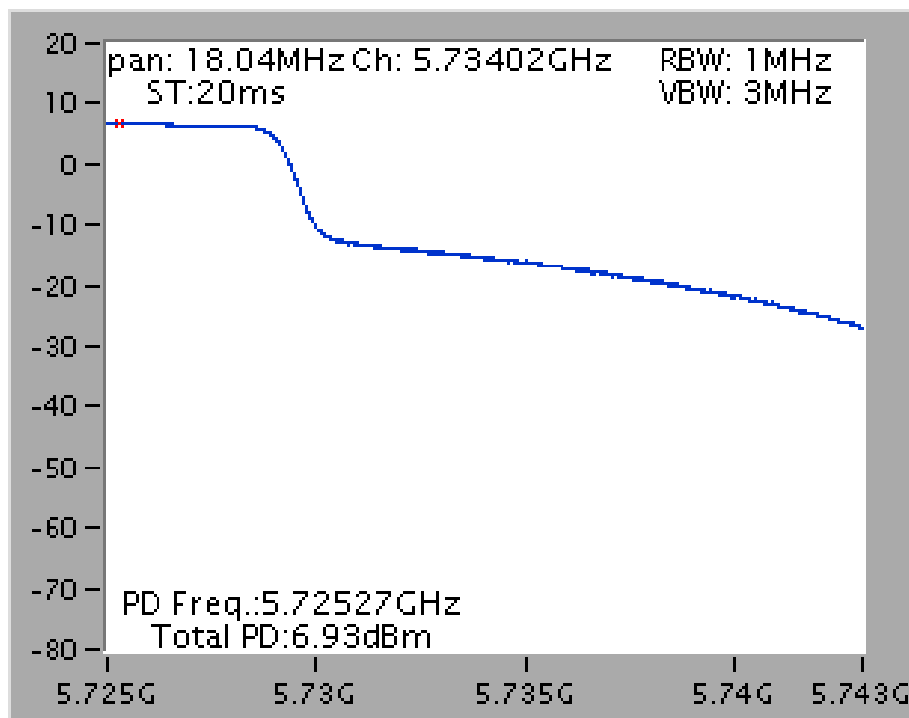

Power Density Plot on Configuration IEEE 802.11n MCS0 HT40 / Ant. 1 + Ant. 2 / 5710 MHz (UNII 2C)

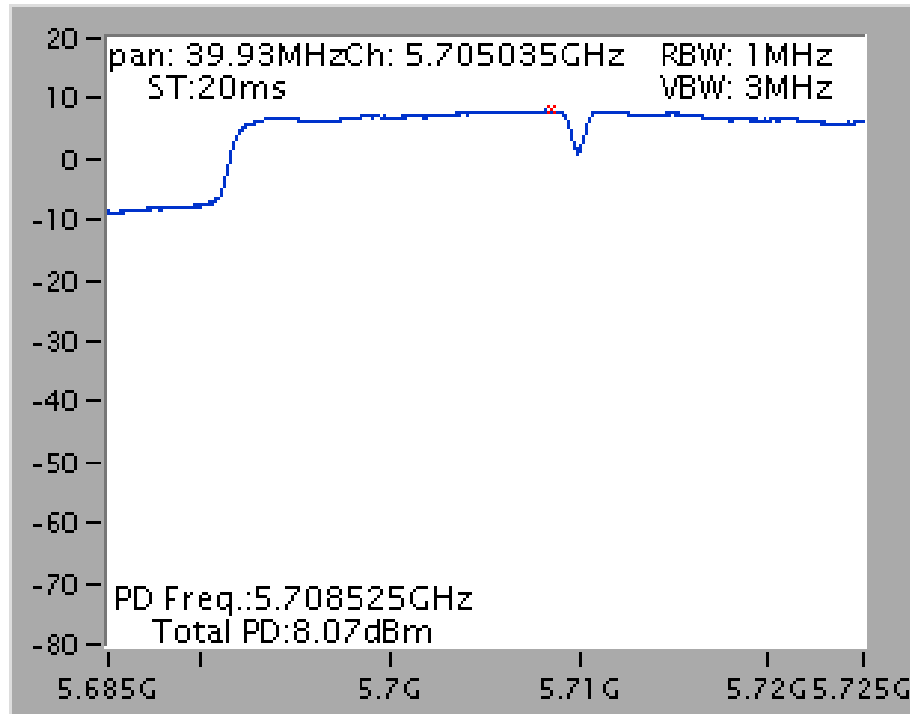

Power Density Plot on Configuration IEEE 802.11n MCS0 HT40 / Ant. 1 + Ant. 2 / 5710 MHz (UNII 3)

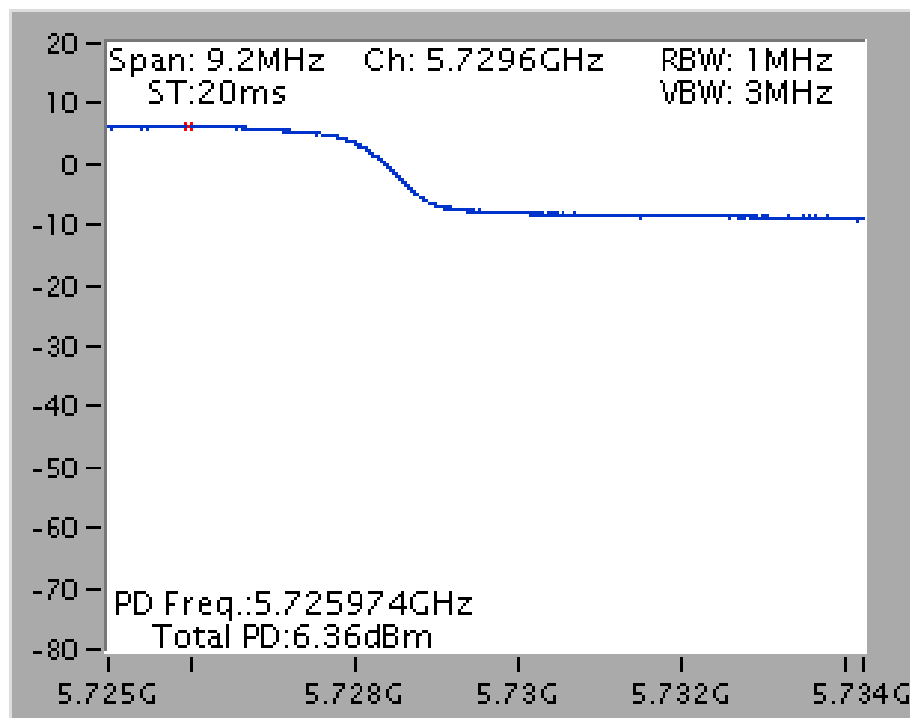

4.6. Radiated Emissions Measurement

4.6.1. Limit

For transmitters operating in the 5.15-5.35 GHz band: all emissions outside of the 5.15-5.35 GHz band shall not exceed an e.i.r.p. of -27 dBm/MHz.

For transmitters operating in the 5.470-5.725 GHz band: all emissions outside of the 5.47-5.725 GHz band shall not exceed an e.i.r.p. of -27 dBm/MHz.

For transmitters operating in the 5.725-5.85 GHz band: all emissions shall be limited to a level of -27 dBm/MHz at 75 MHz or more above or below the band edge increasing linearly to 10 dBm/MHz at 25 MHz above or below the band edge, and from 25 MHz above or below the band edge increasing linearly to a level of 15.6 dBm/MHz at 5 MHz above or below the band edge, and from 5 MHz above or below the band edge increasing linearly to a level of 27 dBm/MHz at the band edge.

In addition, In case the emission fall within the restricted band specified on 15.205(a), then the 15.209(a) limit in the table below has to be followed.

| Frequencies (MHz) | Field Strength (micovolts/meter) | Measurement Distance (meters) |
|----------------------|-------------------------------------|----------------------------------|
| 0.009~0.490 | 2400/F(kHz) | 300 |
| 0.490~1.705 | 24000/F(kHz) | 30 |
| 1.705~30.0 | 30 | 30 |
| 30~88 | 100 | 3 |
| 88~216 | 150 | 3 |
| 216~960 | 200 | 3 |
| Above 960 | 500 | 3 |

4.6.2. Measuring Instruments and Setting

Please refer to section 5 of equipments list in this report. The following table is the setting of spectrum analyzer and receiver.

| Spectrum Parameter | Setting |
|---|---|
| Attenuation | Auto |
| Start Frequency | 1000 MHz |
| Stop Frequency | 40 GHz |
| RBW / VBW (Emission in restricted band) | 1 MHz / 3MHz for Peak, 1 MHz / 1/T for Average |
| RBW / VBW (Emission in non-restricted band) | 1MHz / 3MHz for peak |

| Receiver Parameter | Setting |
|------------------------|-----------------------------------|
| Attenuation | Auto |
| Start ~ Stop Frequency | 9kHz~150kHz / RBW 200Hz for QP |
| Start ~ Stop Frequency | 150kHz~30MHz / RBW 9kHz for QP |
| Start ~ Stop Frequency | 30MHz~1000MHz / RBW 120kHz for QP |

4.6.3. Test Procedures

1. Configure the EUT according to ANSI C63.10. The EUT was placed on the top of the turntable 1.5 meter above ground. The phase center of the receiving antenna mounted on the top of a height-variable antenna tower was placed 1m & 3m far away from the turntable.
2. Power on the EUT and all the supporting units. The turntable was rotated by 360 degrees to determine the position of the highest radiation.
3. The height of the broadband receiving antenna was varied between one meter and four meters above ground to find the maximum emissions field strength of both horizontal and vertical polarization.
4. For each suspected emissions, the antenna tower was scan (from 1 M to 4 M) and then the turntable was rotated (from 0 degree to 360 degrees) to find the maximum reading.
5. Set the test-receiver system to Peak or CISPR quasi-peak Detect Function with specified bandwidth under Maximum Hold Mode.
6. For emissions above 1GHz, use 1MHz VBW and 3MHz RBW for peak reading. Then 1MHz RBW and 1/T VBW for average reading in spectrum analyzer.
7. If the emissions level of the EUT in peak mode was 3 dB lower than the average limit specified, then testing will be stopped and peak values of EUT will be reported, otherwise, the emissions which do not have 3 dB margin will be repeated one by one using the quasi-peak method for below 1GHz.
8. For testing above 1GHz, the emissions level of the EUT in peak mode was lower than average limit (that means the emissions level in peak mode also complies with the limit in average mode), then testing will be stopped and peak values of EUT will be reported, otherwise, the emissions will be measured in average mode again and reported.
9. In case the emission is lower than 30MHz, loop antenna has to be used for measurement and the recorded data should be QP measured by receiver. High – Low scan is not required in this case.

4.6.4. Test Setup Layout

For Radiated Emissions: 9kHz ~30MHz

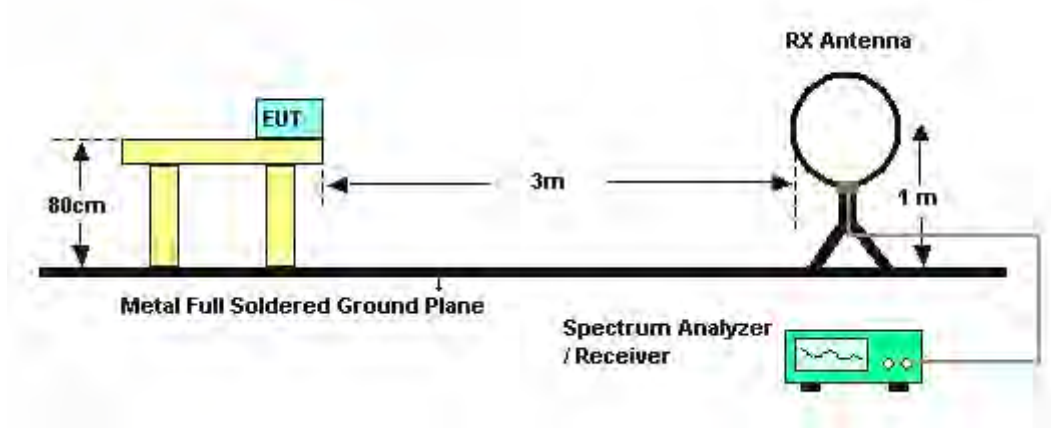

For Radiated Emissions: 30MHz~1GHz

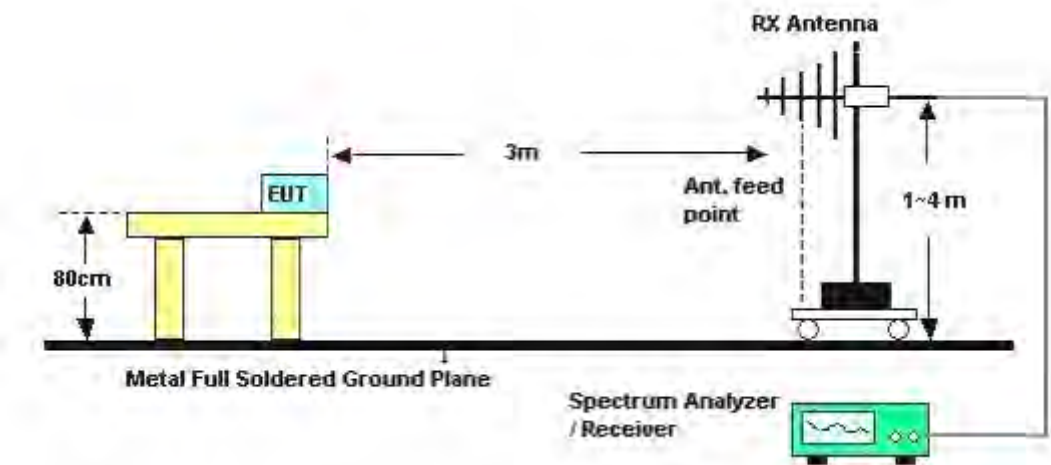

For Radiated Emissions: Above 1GHz

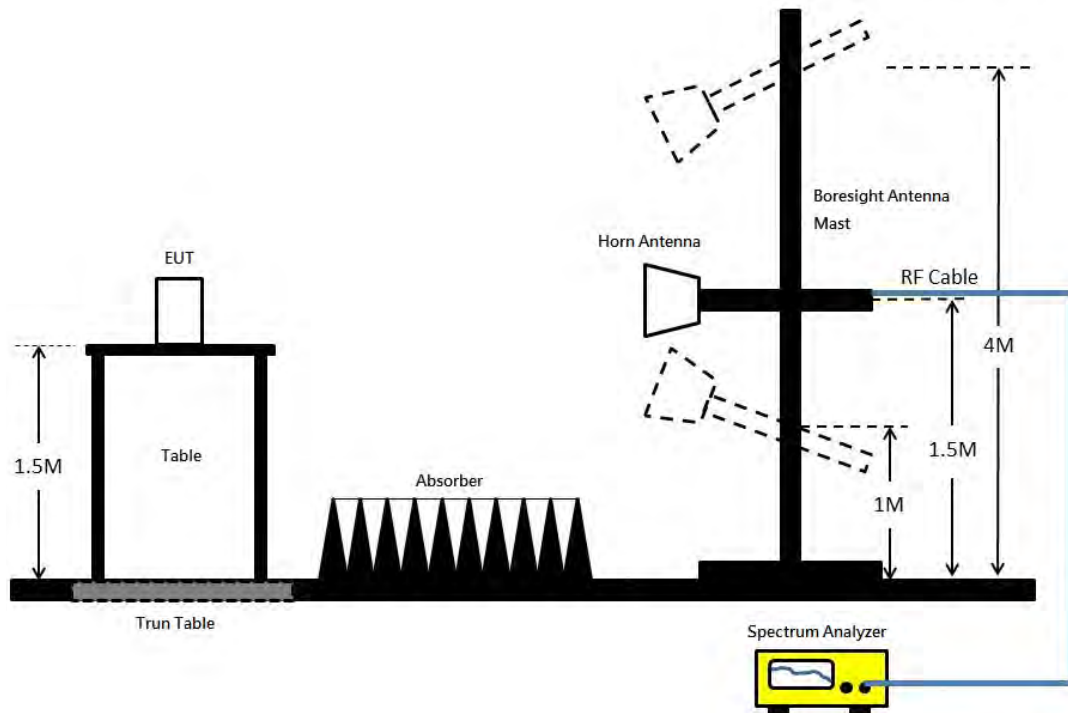

4.6.5. Test Deviation

There is no deviation with the original standard.

4.6.6. EUT Operation during Test

The EUT was programmed to be in continuously transmitting mode.

4.6.7. Results of Radiated Emissions (9kHz~30MHz)

| | | | |
|----------------------|----------------------|-----------------------|-------------|
| Temperature | 22.2°C | Humidity | 51% |
| Test Engineer | John Tang, Zero Chen | Configurations | Normal Link |
| Test Date | Aug. 01, 2016 | Test Mode | Mode 1 |

| Freq. (MHz) | Level (dBuV) | Over Limit (dB) | Limit Line (dBuV) | Remark |
|--------------------|---------------------|------------------------|--------------------------|---------------|
| - | - | - | - | See Note |

Note:

The amplitude of spurious emissions that are attenuated by more than 20dB below the permissible value has no need to be reported.

Distance extrapolation factor = $40 \log(\text{specific distance} / \text{test distance})$ (dB);

Limit line = specific limits (dBuV) + distance extrapolation factor.

4.6.8. Results of Radiated Emissions (30MHz~1GHz)

| | | | |
|---------------|----------------------|----------------|-------------|
| Temperature | 22.2°C | Humidity | 51% |
| Test Engineer | John Tang, Zero Chen | Configurations | Normal Link |
| Test Mode | Mode 1 | | |

Horizontal

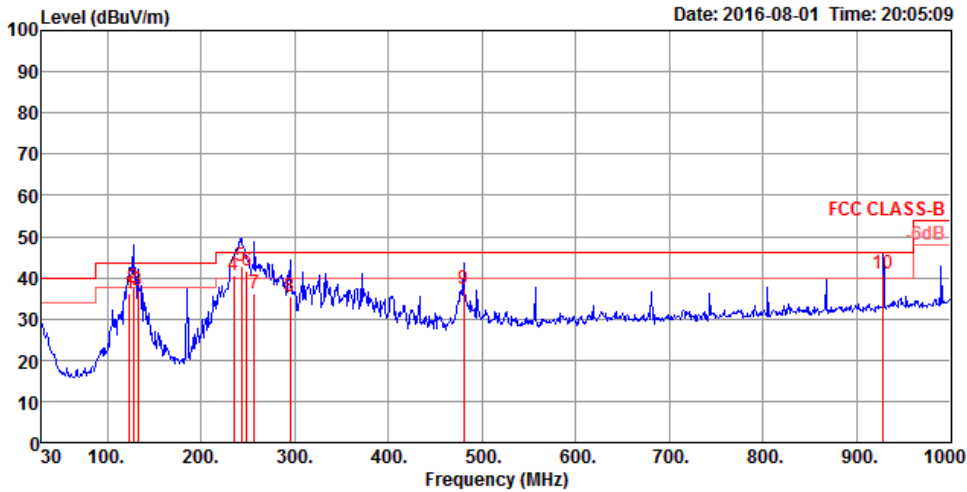

| | Freq | Level | Limit | Over | Read | Cable | Antenna | Preamp | A/Pos | T/Pos | Remark | Pol/Phase |
|----|--------|--------|--------|--------|-------|-------|---------|--------|-------|-------|--------|------------|
| | MHz | dBuV/m | dBuV/m | dB | dBuV | dB | dB/m | dB | cm | deg | | |
| 1 | 124.09 | 36.33 | 43.50 | -7.17 | 48.77 | 0.96 | 18.97 | 32.37 | 100 | 192 | QP | HORIZONTAL |
| 2 | 127.97 | 37.76 | 43.50 | -5.74 | 50.30 | 0.98 | 18.85 | 32.37 | 200 | 167 | QP | HORIZONTAL |
| 3 | 132.82 | 36.96 | 43.50 | -6.54 | 49.71 | 0.99 | 18.63 | 32.37 | 200 | 148 | QP | HORIZONTAL |
| 4 | 234.67 | 40.53 | 46.00 | -5.47 | 53.58 | 1.31 | 17.95 | 32.31 | 150 | 164 | QP | HORIZONTAL |
| 5 | 243.40 | 42.95 | 46.00 | -3.05 | 55.30 | 1.33 | 18.63 | 32.31 | 150 | 156 | QP | HORIZONTAL |
| 6 | 249.22 | 41.85 | 46.00 | -4.15 | 53.77 | 1.34 | 19.04 | 32.30 | 100 | 149 | QP | HORIZONTAL |
| 7 | 256.98 | 36.04 | 46.00 | -9.96 | 47.30 | 1.36 | 19.68 | 32.30 | 150 | 142 | QP | HORIZONTAL |
| 8 | 294.81 | 35.38 | 46.00 | -10.62 | 46.29 | 1.47 | 19.90 | 32.28 | 100 | 128 | QP | HORIZONTAL |
| 9 | 480.08 | 37.26 | 46.00 | -8.74 | 44.00 | 1.90 | 23.71 | 32.35 | 200 | 3 | QP | HORIZONTAL |
| 10 | 928.22 | 40.85 | 46.00 | -5.15 | 41.74 | 2.63 | 27.94 | 31.46 | 100 | 88 | QP | HORIZONTAL |

Vertical

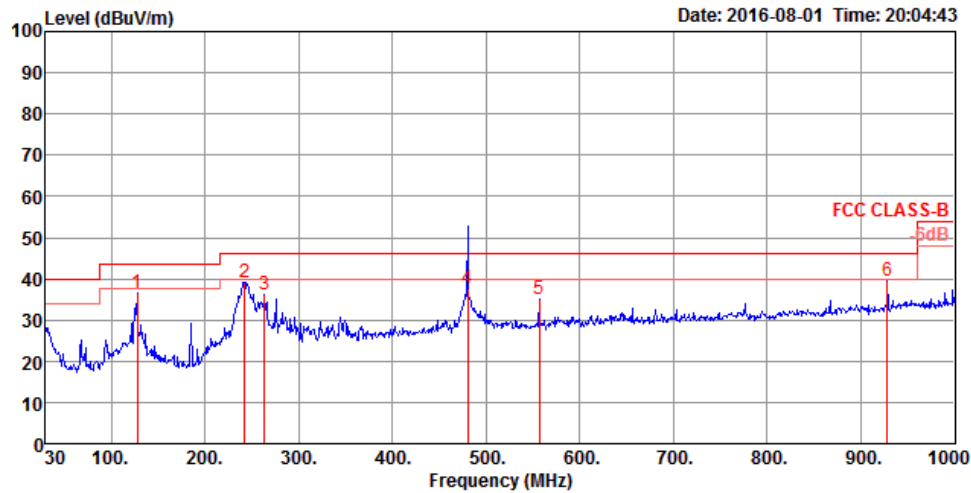

| | Freq | Level | Limit Line | Over Limit | Read Level | CableAntenna Loss | Preamp Factor | A/Pos | T/Pos | Remark | Pol/Phase |
|---|--------|--------|------------|------------|------------|-------------------|---------------|-------|-------|----------|-----------|
| | MHz | dBuV/m | dBuV/m | dB | dBuV | dB | dB/m | dB | cm | deg | |
| 1 | 127.97 | 36.44 | 43.50 | -7.06 | 48.98 | 0.98 | 18.85 | 32.37 | 200 | 103 Peak | VERTICAL |
| 2 | 242.43 | 39.17 | 46.00 | -6.83 | 51.58 | 1.32 | 18.58 | 32.31 | 200 | 90 Peak | VERTICAL |
| 3 | 263.77 | 36.08 | 46.00 | -9.92 | 47.21 | 1.38 | 19.79 | 32.30 | 150 | 110 Peak | VERTICAL |
| 4 | 480.08 | 37.76 | 46.00 | -8.24 | 44.50 | 1.90 | 23.71 | 32.35 | 100 | 216 QP | VERTICAL |
| 5 | 556.71 | 35.08 | 46.00 | -10.92 | 40.55 | 2.04 | 24.88 | 32.39 | 100 | 272 Peak | VERTICAL |
| 6 | 928.22 | 39.63 | 46.00 | -6.37 | 40.52 | 2.63 | 27.94 | 31.46 | 100 | 239 Peak | VERTICAL |

Note:

The amplitude of spurious emissions which are attenuated by more than 20 dB below the permissible value has no need to be reported.

Emission level (dBuV/m) = 20 log Emission level (uV/m).

Corrected Reading: Antenna Factor + Cable Loss + Read Level - Preamp Factor = Level.

4.6.9. Results for Radiated Emissions (1GHz~40GHz)

| | | | |
|----------------------|----------------------|-----------------------|--------------------------------------|
| Temperature | 22.2°C | Humidity | 51% |
| Test Engineer | John Tang, Zero Chen | Configurations | IEEE 802.11a CH 36 / Ant. 1 + Ant. 2 |
| Test Date | Jul. 27, 2016 | | |

Horizontal

| | Freq | Level | Limit Line | Over Limit | Read Level | CableAntenna Loss | Antenna Factor | Preamp Factor | A/Pos | T/Pos | Remark | Pol/Phase |
|---|----------|--------|------------|------------|------------|-------------------|----------------|---------------|-------|-------|---------|------------|
| | MHz | dBuV/m | dBuV/m | dB | dBuV | dB | dB/m | dB | cm | deg | | |
| 1 | 15535.22 | 46.69 | 54.00 | -7.31 | 32.06 | 11.73 | 38.25 | 35.35 | 101 | 91 | Average | HORIZONTAL |
| 2 | 15538.48 | 59.79 | 74.00 | -14.21 | 45.16 | 11.73 | 38.25 | 35.35 | 101 | 91 | Peak | HORIZONTAL |

Vertical

| | Freq | Level | Limit Line | Over Limit | Read Level | CableAntenna Loss | Antenna Factor | Preamp Factor | A/Pos | T/Pos | Remark | Pol/Phase |
|---|----------|--------|------------|------------|------------|-------------------|----------------|---------------|-------|-------|---------|-----------|
| | MHz | dBuV/m | dBuV/m | dB | dBuV | dB | dB/m | dB | cm | deg | | |
| 1 | 15535.06 | 46.20 | 54.00 | -7.80 | 31.57 | 11.73 | 38.25 | 35.35 | 142 | 169 | Average | VERTICAL |
| 2 | 15544.54 | 59.18 | 74.00 | -14.82 | 44.55 | 11.73 | 38.25 | 35.35 | 142 | 169 | Peak | VERTICAL |

| | | | |
|----------------------|----------------------|-----------------------|--------------------------------------|
| Temperature | 22.2°C | Humidity | 51% |
| Test Engineer | John Tang, Zero Chen | Configurations | IEEE 802.11a CH 40 / Ant. 1 + Ant. 2 |
| Test Date | Jul. 27, 2016 | | |

Horizontal

| | Freq | Level | Limit Line | Over Limit | Read Level | CableAntenna Loss | Antenna Factor | Preamp Factor | A/Pos | T/Pos | Remark | Pol/Phase |
|---|----------|--------|------------|------------|------------|-------------------|----------------|---------------|-------|-------|---------|------------|
| | MHz | dBuV/m | dBuV/m | dB | dBuV | dB | dB/m | dB | cm | deg | | |
| 1 | 10395.04 | 43.44 | 54.00 | -10.56 | 28.72 | 9.96 | 39.59 | 34.83 | 201 | 218 | Average | HORIZONTAL |
| 2 | 10395.10 | 56.35 | 74.00 | -17.65 | 41.63 | 9.96 | 39.59 | 34.83 | 201 | 218 | Peak | HORIZONTAL |

Vertical

| | Freq | Level | Limit Line | Over Limit | Read Level | CableAntenna Loss | Antenna Factor | Preamp Factor | A/Pos | T/Pos | Remark | Pol/Phase |
|---|----------|--------|------------|------------|------------|-------------------|----------------|---------------|-------|-------|---------|-----------|
| | MHz | dBuV/m | dBuV/m | dB | dBuV | dB | dB/m | dB | cm | deg | | |
| 1 | 10399.64 | 56.60 | 74.00 | -17.40 | 41.90 | 9.96 | 39.59 | 34.85 | 140 | 112 | Peak | VERTICAL |
| 2 | 10400.66 | 43.55 | 54.00 | -10.45 | 28.85 | 9.96 | 39.59 | 34.85 | 140 | 112 | Average | VERTICAL |

| | | | |
|----------------------|----------------------|-----------------------|--------------------------------------|
| Temperature | 22.2°C | Humidity | 51% |
| Test Engineer | John Tang, Zero Chen | Configurations | IEEE 802.11a CH 48 / Ant. 1 + Ant. 2 |
| Test Date | Jul. 27, 2016 | | |

Horizontal

| | Freq | Level | Limit Line | Over Limit | Read Level | CableAntenna Loss | Antenna Factor | Preamp Factor | A/Pos | T/Pos | Remark | Pol/Phase |
|---|----------|--------|------------|------------|------------|-------------------|----------------|---------------|-------|-------|---------|------------|
| | MHz | dBuV/m | dBuV/m | dB | dBuV | dB | dB/m | dB | cm | deg | | |
| 1 | 15716.96 | 45.80 | 54.00 | -8.20 | 31.35 | 11.80 | 38.03 | 35.38 | 109 | 161 | Average | HORIZONTAL |
| 2 | 15720.72 | 59.81 | 74.00 | -14.19 | 45.36 | 11.80 | 38.03 | 35.38 | 109 | 161 | Peak | HORIZONTAL |

Vertical

| | Freq | Level | Limit Line | Over Limit | Read Level | CableAntenna Loss | Antenna Factor | Preamp Factor | A/Pos | T/Pos | Remark | Pol/Phase |
|---|----------|--------|------------|------------|------------|-------------------|----------------|---------------|-------|-------|---------|-----------|
| | MHz | dBuV/m | dBuV/m | dB | dBuV | dB | dB/m | dB | cm | deg | | |
| 1 | 15720.16 | 58.95 | 74.00 | -15.05 | 44.50 | 11.80 | 38.03 | 35.38 | 144 | 245 | Peak | VERTICAL |
| 2 | 15720.86 | 45.81 | 54.00 | -8.19 | 31.36 | 11.80 | 38.03 | 35.38 | 144 | 245 | Average | VERTICAL |



| | | | |
|----------------------|----------------------|-----------------------|--------------------------------------|
| Temperature | 22.2°C | Humidity | 51% |
| Test Engineer | John Tang, Zero Chen | Configurations | IEEE 802.11a CH 52 / Ant. 1 + Ant. 2 |
| Test Date | Jul. 27, 2016 | | |

Horizontal

| | Freq | Level | Limit Line | Over Limit | Read Level | CableAntenna Loss | Antenna Factor | Preamp Factor | A/Pos | T/Pos | Remark | Pol/Phase |
|---|----------|--------|------------|------------|------------|-------------------|----------------|---------------|-------|-------|---------|------------|
| | MHz | dBuV/m | dBuV/m | dB | dBuV | dB | dB/m | dB | cm | deg | | |
| 1 | 15777.02 | 45.54 | 54.00 | -8.46 | 31.14 | 11.82 | 37.97 | 35.39 | 141 | 212 | Average | HORIZONTAL |
| 2 | 15778.00 | 58.67 | 74.00 | -15.33 | 44.27 | 11.82 | 37.97 | 35.39 | 141 | 212 | Peak | HORIZONTAL |

Vertical

| | Freq | Level | Limit Line | Over Limit | Read Level | CableAntenna Loss | Antenna Factor | Preamp Factor | A/Pos | T/Pos | Remark | Pol/Phase |
|---|----------|--------|------------|------------|------------|-------------------|----------------|---------------|-------|-------|---------|-----------|
| | MHz | dBuV/m | dBuV/m | dB | dBuV | dB | dB/m | dB | cm | deg | | |
| 1 | 15777.80 | 59.90 | 74.00 | -14.10 | 45.50 | 11.82 | 37.97 | 35.39 | 103 | 127 | Peak | VERTICAL |
| 2 | 15780.50 | 47.12 | 54.00 | -6.88 | 32.72 | 11.82 | 37.97 | 35.39 | 103 | 127 | Average | VERTICAL |

| | | | |
|----------------------|----------------------|-----------------------|--------------------------------------|
| Temperature | 22.2°C | Humidity | 51% |
| Test Engineer | John Tang, Zero Chen | Configurations | IEEE 802.11a CH 60 / Ant. 1 + Ant. 2 |
| Test Date | Jul. 27, 2016 | | |

Horizontal

| | Freq | Level | Limit Line | Over Limit | Read Level | Cable Loss | Antenna Factor | Preamp Factor | A/Pos | T/Pos | Remark | Pol/Phase |
|---|----------|--------|------------|------------|------------|------------|----------------|---------------|-------|-------|---------|------------|
| | MHz | dBuV/m | dBuV/m | dB | dBuV | dB | dB/m | dB | cm | deg | | |
| 1 | 10596.28 | 44.67 | 54.00 | -9.33 | 29.68 | 10.07 | 39.88 | 34.96 | 111 | 120 | Average | HORIZONTAL |
| 2 | 10599.64 | 57.54 | 74.00 | -16.46 | 42.55 | 10.07 | 39.88 | 34.96 | 111 | 120 | Peak | HORIZONTAL |
| 3 | 15896.48 | 46.06 | 54.00 | -7.94 | 31.78 | 11.87 | 37.81 | 35.40 | 150 | 208 | Average | HORIZONTAL |
| 4 | 15902.58 | 58.60 | 74.00 | -15.40 | 44.32 | 11.87 | 37.81 | 35.40 | 150 | 208 | Peak | HORIZONTAL |

Vertical

| | Freq | Level | Limit Line | Over Limit | Read Level | Cable Loss | Antenna Factor | Preamp Factor | A/Pos | T/Pos | Remark | Pol/Phase |
|---|----------|--------|------------|------------|------------|------------|----------------|---------------|-------|-------|---------|-----------|
| | MHz | dBuV/m | dBuV/m | dB | dBuV | dB | dB/m | dB | cm | deg | | |
| 1 | 10603.28 | 57.76 | 74.00 | -16.24 | 42.77 | 10.07 | 39.88 | 34.96 | 158 | 201 | Peak | VERTICAL |
| 2 | 10604.92 | 44.55 | 54.00 | -9.45 | 29.57 | 10.07 | 39.88 | 34.97 | 158 | 201 | Average | VERTICAL |
| 3 | 15900.00 | 46.09 | 54.00 | -7.91 | 31.81 | 11.87 | 37.81 | 35.40 | 139 | 250 | Average | VERTICAL |
| 4 | 15901.22 | 58.84 | 74.00 | -15.16 | 44.56 | 11.87 | 37.81 | 35.40 | 139 | 250 | Peak | VERTICAL |

| | | | |
|----------------------|----------------------|-----------------------|--------------------------------------|
| Temperature | 22.2°C | Humidity | 51% |
| Test Engineer | John Tang, Zero Chen | Configurations | IEEE 802.11a CH 64 / Ant. 1 + Ant. 2 |
| Test Date | Jul. 27, 2016 | | |

Horizontal

| | Freq | Level | Limit Line | Over Limit | Read Level | Cable Loss | Antenna Factor | Preamp Factor | A/Pos | T/Pos | Remark | Pol/Phase |
|---|----------|--------|------------|------------|------------|------------|----------------|---------------|-------|-------|---------|------------|
| | MHz | dBuV/m | dBuV/m | dB | dBuV | dB | dB/m | dB | cm | deg | | |
| 1 | 10638.90 | 57.24 | 74.00 | -16.76 | 42.25 | 10.08 | 39.90 | 34.99 | 183 | 224 | Peak | HORIZONTAL |
| 2 | 10643.86 | 44.35 | 54.00 | -9.65 | 29.36 | 10.08 | 39.90 | 34.99 | 183 | 224 | Average | HORIZONTAL |
| 3 | 15955.92 | 59.29 | 74.00 | -14.71 | 45.06 | 11.89 | 37.75 | 35.41 | 156 | 278 | Peak | HORIZONTAL |
| 4 | 15964.94 | 46.33 | 54.00 | -7.67 | 32.10 | 11.89 | 37.75 | 35.41 | 156 | 278 | Average | HORIZONTAL |

Vertical

| | Freq | Level | Limit Line | Over Limit | Read Level | Cable Loss | Antenna Factor | Preamp Factor | A/Pos | T/Pos | Remark | Pol/Phase |
|---|----------|--------|------------|------------|------------|------------|----------------|---------------|-------|-------|---------|-----------|
| | MHz | dBuV/m | dBuV/m | dB | dBuV | dB | dB/m | dB | cm | deg | | |
| 1 | 10635.48 | 44.64 | 54.00 | -9.36 | 29.63 | 10.08 | 39.90 | 34.97 | 239 | 243 | Average | VERTICAL |
| 2 | 10640.96 | 57.47 | 74.00 | -16.53 | 42.48 | 10.08 | 39.90 | 34.99 | 239 | 243 | Peak | VERTICAL |
| 3 | 15955.56 | 46.43 | 54.00 | -7.57 | 32.20 | 11.89 | 37.75 | 35.41 | 192 | 210 | Average | VERTICAL |
| 4 | 15958.24 | 59.56 | 74.00 | -14.44 | 45.33 | 11.89 | 37.75 | 35.41 | 192 | 210 | Peak | VERTICAL |



| | | | |
|----------------------|----------------------|-----------------------|---------------------------------------|
| Temperature | 22.2°C | Humidity | 51% |
| Test Engineer | John Tang, Zero Chen | Configurations | IEEE 802.11a CH 100 / Ant. 1 + Ant. 2 |
| Test Date | Jul. 27, 2016 | | |

Horizontal

| | Freq | Level | Limit Line | Over Limit | Read Level | CableAntenna Loss | Antenna Factor | Preamp Factor | A/Pos | T/Pos | Remark | Pol/Phase |
|---|----------|--------|------------|------------|------------|-------------------|----------------|---------------|-------|-------|---------|------------|
| | MHz | dBuV/m | dBuV/m | dB | dBuV | dB | dB/m | dB | cm | deg | | |
| 1 | 10995.08 | 44.09 | 54.00 | -9.91 | 28.84 | 10.25 | 40.17 | 35.17 | 105 | 174 | Average | HORIZONTAL |
| 2 | 11003.24 | 56.84 | 74.00 | -17.16 | 41.54 | 10.27 | 40.20 | 35.17 | 105 | 174 | Peak | HORIZONTAL |

Vertical

| | Freq | Level | Limit Line | Over Limit | Read Level | CableAntenna Loss | Antenna Factor | Preamp Factor | A/Pos | T/Pos | Remark | Pol/Phase |
|---|----------|--------|------------|------------|------------|-------------------|----------------|---------------|-------|-------|---------|-----------|
| | MHz | dBuV/m | dBuV/m | dB | dBuV | dB | dB/m | dB | cm | deg | | |
| 1 | 10995.68 | 56.65 | 74.00 | -17.35 | 41.40 | 10.25 | 40.17 | 35.17 | 141 | 94 | Peak | VERTICAL |
| 2 | 10997.96 | 43.97 | 54.00 | -10.03 | 28.67 | 10.27 | 40.20 | 35.17 | 141 | 94 | Average | VERTICAL |



| | | | |
|----------------------|----------------------|-----------------------|---------------------------------------|
| Temperature | 22.2°C | Humidity | 51% |
| Test Engineer | John Tang, Zero Chen | Configurations | IEEE 802.11a CH 116 / Ant. 1 + Ant. 2 |
| Test Date | Jul. 27, 2016 | | |

Horizontal

| | Freq | Level | Limit Line | Over Limit | Read Level | CableAntenna Loss | Antenna Factor | Preamp Factor | A/Pos | T/Pos | Remark | Pol/Phase |
|---|----------|--------|------------|------------|------------|-------------------|----------------|---------------|-------|-------|---------|------------|
| | MHz | dBuV/m | dBuV/m | dB | dBuV | dB | dB/m | dB | cm | deg | | |
| 1 | 11157.80 | 44.32 | 54.00 | -9.68 | 29.03 | 10.35 | 40.13 | 35.19 | 165 | 305 | Average | HORIZONTAL |
| 2 | 11159.40 | 57.14 | 74.00 | -16.86 | 41.85 | 10.35 | 40.13 | 35.19 | 165 | 305 | Peak | HORIZONTAL |

Vertical

| | Freq | Level | Limit Line | Over Limit | Read Level | CableAntenna Loss | Antenna Factor | Preamp Factor | A/Pos | T/Pos | Remark | Pol/Phase |
|---|----------|--------|------------|------------|------------|-------------------|----------------|---------------|-------|-------|---------|-----------|
| | MHz | dBuV/m | dBuV/m | dB | dBuV | dB | dB/m | dB | cm | deg | | |
| 1 | 11162.84 | 44.47 | 54.00 | -9.53 | 29.18 | 10.35 | 40.13 | 35.19 | 100 | 282 | Average | VERTICAL |
| 2 | 11163.08 | 57.60 | 74.00 | -16.40 | 42.31 | 10.35 | 40.13 | 35.19 | 100 | 282 | Peak | VERTICAL |

| | | | |
|----------------------|----------------------|-----------------------|---------------------------------------|
| Temperature | 22.2°C | Humidity | 51% |
| Test Engineer | John Tang, Zero Chen | Configurations | IEEE 802.11a CH 140 / Ant. 1 + Ant. 2 |
| Test Date | Jul. 27, 2016 | | |

Horizontal

| | Freq | Level | Limit Line | Over Limit | Read Level | CableAntenna Loss | Antenna Factor | Preamp Factor | A/Pos | T/Pos | Remark | Pol/Phase |
|---|----------|--------|------------|------------|------------|-------------------|----------------|---------------|-------|-------|---------|------------|
| | MHz | dBuV/m | dBuV/m | dB | dBuV | dB | dB/m | dB | cm | deg | | |
| 1 | 11401.80 | 58.18 | 74.00 | -15.82 | 42.91 | 10.45 | 40.04 | 35.22 | 182 | 76 | Peak | HORIZONTAL |
| 2 | 11401.90 | 44.81 | 54.00 | -9.19 | 29.54 | 10.45 | 40.04 | 35.22 | 182 | 76 | Average | HORIZONTAL |

Vertical

| | Freq | Level | Limit Line | Over Limit | Read Level | CableAntenna Loss | Antenna Factor | Preamp Factor | A/Pos | T/Pos | Remark | Pol/Phase |
|---|----------|--------|------------|------------|------------|-------------------|----------------|---------------|-------|-------|---------|-----------|
| | MHz | dBuV/m | dBuV/m | dB | dBuV | dB | dB/m | dB | cm | deg | | |
| 1 | 11398.44 | 57.96 | 74.00 | -16.04 | 42.69 | 10.45 | 40.04 | 35.22 | 142 | 153 | Peak | VERTICAL |
| 2 | 11398.62 | 44.83 | 54.00 | -9.17 | 29.56 | 10.45 | 40.04 | 35.22 | 142 | 153 | Average | VERTICAL |



| | | | |
|----------------------|----------------------|-----------------------|---------------------------------------|
| Temperature | 22.2°C | Humidity | 51% |
| Test Engineer | John Tang, Zero Chen | Configurations | IEEE 802.11a CH 149 / Ant. 1 + Ant. 2 |
| Test Date | Jul. 27, 2016 | | |

Horizontal

| | Freq | Level | Limit Line | Over Limit | Read Level | CableAntenna Loss | Antenna Factor | Preamp Factor | A/Pos | T/Pos | Remark | Pol/Phase |
|---|----------|--------|------------|------------|------------|-------------------|----------------|---------------|-------|-------|---------|------------|
| | MHz | dBuV/m | dBuV/m | dB | dBuV | dB | dB/m | dB | cm | deg | | |
| 1 | 11487.74 | 56.84 | 74.00 | -17.16 | 41.57 | 10.50 | 40.00 | 35.23 | 140 | 48 | Peak | HORIZONTAL |
| 2 | 11488.48 | 44.21 | 54.00 | -9.79 | 28.94 | 10.50 | 40.00 | 35.23 | 140 | 48 | Average | HORIZONTAL |

Vertical

| | Freq | Level | Limit Line | Over Limit | Read Level | CableAntenna Loss | Antenna Factor | Preamp Factor | A/Pos | T/Pos | Remark | Pol/Phase |
|---|----------|--------|------------|------------|------------|-------------------|----------------|---------------|-------|-------|---------|-----------|
| | MHz | dBuV/m | dBuV/m | dB | dBuV | dB | dB/m | dB | cm | deg | | |
| 1 | 11487.78 | 58.05 | 74.00 | -15.95 | 42.78 | 10.50 | 40.00 | 35.23 | 182 | 128 | Peak | VERTICAL |
| 2 | 11494.48 | 44.12 | 54.00 | -9.88 | 28.85 | 10.50 | 40.00 | 35.23 | 182 | 128 | Average | VERTICAL |



| | | | |
|----------------------|----------------------|-----------------------|---------------------------------------|
| Temperature | 22.2°C | Humidity | 51% |
| Test Engineer | John Tang, Zero Chen | Configurations | IEEE 802.11a CH 157 / Ant. 1 + Ant. 2 |
| Test Date | Jul. 27, 2016 | | |

Horizontal

| | Freq | Level | Limit Line | Over Limit | Read Level | Cable Loss | Antenna Factor | Preamp Factor | A/Pos | T/Pos | Remark | Pol/Phase |
|---|----------|--------|------------|------------|------------|------------|----------------|---------------|-------|-------|---------|------------|
| | MHz | dBuV/m | dBuV/m | dB | dBuV | dB | dB/m | dB | cm | deg | | |
| 1 | 11566.96 | 43.82 | 54.00 | -10.18 | 28.65 | 10.53 | 39.87 | 35.23 | 172 | 107 | Average | HORIZONTAL |
| 2 | 11573.36 | 57.44 | 74.00 | -16.56 | 42.27 | 10.53 | 39.87 | 35.23 | 172 | 107 | Peak | HORIZONTAL |

Vertical

| | Freq | Level | Limit Line | Over Limit | Read Level | Cable Loss | Antenna Factor | Preamp Factor | A/Pos | T/Pos | Remark | Pol/Phase |
|---|----------|--------|------------|------------|------------|------------|----------------|---------------|-------|-------|---------|-----------|
| | MHz | dBuV/m | dBuV/m | dB | dBuV | dB | dB/m | dB | cm | deg | | |
| 1 | 11568.46 | 56.71 | 74.00 | -17.29 | 41.54 | 10.53 | 39.87 | 35.23 | 212 | 90 | Peak | VERTICAL |
| 2 | 11573.90 | 44.46 | 54.00 | -9.54 | 29.29 | 10.53 | 39.87 | 35.23 | 212 | 90 | Average | VERTICAL |

| | | | |
|----------------------|----------------------|-----------------------|---------------------------------------|
| Temperature | 22.2°C | Humidity | 51% |
| Test Engineer | John Tang, Zero Chen | Configurations | IEEE 802.11a CH 165 / Ant. 1 + Ant. 2 |
| Test Date | Jul. 27, 2016 | | |

Horizontal

| | Freq | Level | Limit Line | Over Limit | Read Level | CableAntenna Loss | Antenna Factor | Preamp Factor | A/Pos | T/Pos | Remark | Pol/Phase |
|---|----------|--------|------------|------------|------------|-------------------|----------------|---------------|-------|-------|---------|------------|
| | MHz | dBuV/m | dBuV/m | dB | dBuV | dB | dB/m | dB | cm | deg | | |
| 1 | 11649.84 | 57.55 | 74.00 | -16.45 | 42.48 | 10.56 | 39.73 | 35.22 | 136 | 145 | Peak | HORIZONTAL |
| 2 | 11653.18 | 43.58 | 54.00 | -10.42 | 28.55 | 10.58 | 39.67 | 35.22 | 136 | 145 | Average | HORIZONTAL |

Vertical

| | Freq | Level | Limit Line | Over Limit | Read Level | CableAntenna Loss | Antenna Factor | Preamp Factor | A/Pos | T/Pos | Remark | Pol/Phase |
|---|----------|--------|------------|------------|------------|-------------------|----------------|---------------|-------|-------|---------|-----------|
| | MHz | dBuV/m | dBuV/m | dB | dBuV | dB | dB/m | dB | cm | deg | | |
| 1 | 11646.12 | 56.37 | 74.00 | -17.63 | 41.30 | 10.56 | 39.73 | 35.22 | 102 | 237 | Peak | VERTICAL |
| 2 | 11654.14 | 43.40 | 54.00 | -10.60 | 28.37 | 10.58 | 39.67 | 35.22 | 102 | 237 | Average | VERTICAL |



| | | | |
|----------------------|----------------------|-----------------------|---|
| Temperature | 22.2°C | Humidity | 51% |
| Test Engineer | John Tang, Zero Chen | Configurations | IEEE 802.11n MCS0 HT20 CH 36 / Ant. 1 + Ant. 2 |
| Test Date | Jul. 27, 2016 | | |

Horizontal

| | Freq | Level | Limit Line | Over Limit | Read Level | CableAntenna Loss | Antenna Factor | Preamp Factor | A/Pos | T/Pos | Remark | Pol/Phase |
|---|----------|--------|------------|------------|------------|-------------------|----------------|---------------|-------|-------|---------|------------|
| | MHz | dBuV/m | dBuV/m | dB | dBuV | dB | dB/m | dB | cm | deg | | |
| 1 | 15535.46 | 59.98 | 74.00 | -14.02 | 45.35 | 11.73 | 38.25 | 35.35 | 182 | 223 | Peak | HORIZONTAL |
| 2 | 15537.52 | 46.48 | 54.00 | -7.52 | 31.85 | 11.73 | 38.25 | 35.35 | 182 | 223 | Average | HORIZONTAL |

Vertical

| | Freq | Level | Limit Line | Over Limit | Read Level | CableAntenna Loss | Antenna Factor | Preamp Factor | A/Pos | T/Pos | Remark | Pol/Phase |
|---|----------|--------|------------|------------|------------|-------------------|----------------|---------------|-------|-------|---------|-----------|
| | MHz | dBuV/m | dBuV/m | dB | dBuV | dB | dB/m | dB | cm | deg | | |
| 1 | 15543.60 | 46.99 | 54.00 | -7.01 | 32.36 | 11.73 | 38.25 | 35.35 | 225 | 124 | Average | VERTICAL |
| 2 | 15544.76 | 59.37 | 74.00 | -14.63 | 44.74 | 11.73 | 38.25 | 35.35 | 225 | 124 | Peak | VERTICAL |



| | | | |
|----------------------|----------------------|-----------------------|---|
| Temperature | 22.2°C | Humidity | 51% |
| Test Engineer | John Tang, Zero Chen | Configurations | IEEE 802.11n MCS0 HT20 CH 40 / Ant. 1 + Ant. 2 |
| Test Date | Jul. 27, 2016 | | |

Horizontal

| | Freq | Level | Limit Line | Over Limit | Read Level | Cable Loss | Antenna Factor | Preamp Factor | A/Pos | T/Pos | Remark | Pol/Phase |
|---|----------|--------|------------|------------|------------|------------|----------------|---------------|-------|-------|---------|------------|
| | MHz | dBuV/m | dBuV/m | dB | dBuV | dB | dB/m | dB | cm | deg | | |
| 1 | 15775.94 | 45.65 | 54.00 | -8.35 | 31.25 | 11.82 | 37.97 | 35.39 | 177 | 152 | Average | HORIZONTAL |
| 2 | 15782.08 | 58.36 | 74.00 | -15.64 | 43.99 | 11.84 | 37.92 | 35.39 | 177 | 152 | Peak | HORIZONTAL |

Vertical

| | Freq | Level | Limit Line | Over Limit | Read Level | Cable Loss | Antenna Factor | Preamp Factor | A/Pos | T/Pos | Remark | Pol/Phase |
|---|----------|--------|------------|------------|------------|------------|----------------|---------------|-------|-------|---------|-----------|
| | MHz | dBuV/m | dBuV/m | dB | dBuV | dB | dB/m | dB | cm | deg | | |
| 1 | 15776.78 | 45.68 | 54.00 | -8.32 | 31.28 | 11.82 | 37.97 | 35.39 | 135 | 241 | Average | VERTICAL |
| 2 | 15783.24 | 58.72 | 74.00 | -15.28 | 44.35 | 11.84 | 37.92 | 35.39 | 135 | 241 | Peak | VERTICAL |



| | | | |
|----------------------|----------------------|-----------------------|---|
| Temperature | 22.2°C | Humidity | 51% |
| Test Engineer | John Tang, Zero Chen | Configurations | IEEE 802.11n MCS0 HT20 CH 48 / Ant. 1 + Ant. 2 |
| Test Date | Jul. 27, 2016 | | |

Horizontal

| | Freq | Level | Limit Line | Over Limit | Read Level | Cable Loss | Antenna Factor | Preamp Factor | A/Pos | T/Pos | Remark | Pol/Phase |
|---|----------|--------|------------|------------|------------|------------|----------------|---------------|-------|-------|---------|------------|
| | MHz | dBuV/m | dBuV/m | dB | dBuV | dB | dB/m | dB | cm | deg | | |
| 1 | 15777.06 | 46.66 | 54.00 | -7.34 | 32.26 | 11.82 | 37.97 | 35.39 | 150 | 198 | Average | HORIZONTAL |
| 2 | 15783.80 | 58.38 | 74.00 | -15.62 | 44.01 | 11.84 | 37.92 | 35.39 | 150 | 198 | Peak | HORIZONTAL |

Vertical

| | Freq | Level | Limit Line | Over Limit | Read Level | Cable Loss | Antenna Factor | Preamp Factor | A/Pos | T/Pos | Remark | Pol/Phase |
|---|----------|--------|------------|------------|------------|------------|----------------|---------------|-------|-------|---------|-----------|
| | MHz | dBuV/m | dBuV/m | dB | dBuV | dB | dB/m | dB | cm | deg | | |
| 1 | 15782.34 | 45.66 | 54.00 | -8.34 | 31.29 | 11.84 | 37.92 | 35.39 | 101 | 287 | Average | VERTICAL |
| 2 | 15782.58 | 58.05 | 74.00 | -15.95 | 43.68 | 11.84 | 37.92 | 35.39 | 101 | 287 | Peak | VERTICAL |

| | | | |
|----------------------|----------------------|-----------------------|---|
| Temperature | 22.2°C | Humidity | 51% |
| Test Engineer | John Tang, Zero Chen | Configurations | IEEE 802.11n MCS0 HT20 CH 52 / Ant. 1 + Ant. 2 |
| Test Date | Jul. 27, 2016 | | |

Horizontal

| | Freq | Level | Limit Line | Over Limit | Read Level | CableAntenna Loss | Antenna Factor | Preamp Factor | A/Pos | T/Pos | Remark | Pol/Phase |
|---|----------|--------|------------|------------|------------|-------------------|----------------|---------------|-------|-------|---------|------------|
| | MHz | dBuV/m | dBuV/m | dB | dBuV | dB | dB/m | dB | cm | deg | | |
| 1 | 15249.76 | 47.60 | 54.00 | -6.40 | 31.83 | 11.62 | 39.44 | 35.29 | 138 | 228 | Average | HORIZONTAL |
| 2 | 15257.64 | 60.56 | 74.00 | -13.44 | 44.80 | 11.62 | 39.44 | 35.30 | 138 | 228 | Peak | HORIZONTAL |

Vertical

| | Freq | Level | Limit Line | Over Limit | Read Level | CableAntenna Loss | Antenna Factor | Preamp Factor | A/Pos | T/Pos | Remark | Pol/Phase |
|---|----------|--------|------------|------------|------------|-------------------|----------------|---------------|-------|-------|---------|-----------|
| | MHz | dBuV/m | dBuV/m | dB | dBuV | dB | dB/m | dB | cm | deg | | |
| 1 | 15250.04 | 61.19 | 74.00 | -12.81 | 45.42 | 11.62 | 39.44 | 35.29 | 178 | 149 | Peak | VERTICAL |
| 2 | 15250.26 | 47.46 | 54.00 | -6.54 | 31.69 | 11.62 | 39.44 | 35.29 | 178 | 149 | Average | VERTICAL |

| | | | |
|----------------------|----------------------|-----------------------|---|
| Temperature | 22.2°C | Humidity | 51% |
| Test Engineer | John Tang, Zero Chen | Configurations | IEEE 802.11n MCS0 HT20 CH 60 / Ant. 1 + Ant. 2 |
| Test Date | Jul. 27, 2016 | | |

Horizontal

| | Freq | Level | Limit Line | Over Limit | Read Level | CableAntenna Loss | Antenna Factor | Preamp Factor | A/Pos | T/Pos | Remark | Pol/Phase |
|---|----------|--------|---------------|---------------|---------------|----------------------|-------------------|------------------|-------|-------|---------|------------|
| | MHz | dBuV/m | dBuV/m | dB | dBuV | dB | dB/m | dB | cm | deg | | |
| 1 | 10602.30 | 44.16 | 54.00 | -9.84 | 29.17 | 10.07 | 39.88 | 34.96 | 141 | 260 | Average | HORIZONTAL |
| 2 | 10604.66 | 57.04 | 74.00 | -16.96 | 42.06 | 10.07 | 39.88 | 34.97 | 141 | 260 | Peak | HORIZONTAL |
| 3 | 15897.50 | 46.23 | 54.00 | -7.77 | 31.95 | 11.87 | 37.81 | 35.40 | 114 | 301 | Average | HORIZONTAL |
| 4 | 15900.04 | 59.07 | 74.00 | -14.93 | 44.79 | 11.87 | 37.81 | 35.40 | 114 | 301 | Peak | HORIZONTAL |

Vertical

| | Freq | Level | Limit Line | Over Limit | Read Level | CableAntenna Loss | Antenna Factor | Preamp Factor | A/Pos | T/Pos | Remark | Pol/Phase |
|---|----------|--------|---------------|---------------|---------------|----------------------|-------------------|------------------|-------|-------|---------|-----------|
| | MHz | dBuV/m | dBuV/m | dB | dBuV | dB | dB/m | dB | cm | deg | | |
| 1 | 10599.98 | 44.68 | 54.00 | -9.32 | 29.69 | 10.07 | 39.88 | 34.96 | 101 | 244 | Average | VERTICAL |
| 2 | 10600.96 | 58.00 | 74.00 | -16.00 | 43.01 | 10.07 | 39.88 | 34.96 | 101 | 244 | Peak | VERTICAL |
| 3 | 15901.96 | 46.06 | 54.00 | -7.94 | 31.78 | 11.87 | 37.81 | 35.40 | 112 | 297 | Average | VERTICAL |
| 4 | 15903.80 | 59.39 | 74.00 | -14.61 | 45.11 | 11.87 | 37.81 | 35.40 | 112 | 297 | Peak | VERTICAL |



| | | | |
|----------------------|----------------------|-----------------------|---|
| Temperature | 22.2°C | Humidity | 51% |
| Test Engineer | John Tang, Zero Chen | Configurations | IEEE 802.11n MCS0 HT20 CH 64 / Ant. 1 + Ant. 2 |
| Test Date | Jul. 27, 2016 | | |

Horizontal

| | Freq | Level | Limit | Over | Read | CableAntenna | Preamp | A/Pos | T/Pos | Remark | Pol/Phase | |
|---|----------|--------|--------|--------|-------|--------------|--------|-------|-------|--------|-----------|------------|
| | MHz | dBuV/m | dBuV/m | dB | dBuV | dB | dB/m | dB | cm | deg | | |
| 1 | 10635.60 | 44.68 | 54.00 | -9.32 | 29.67 | 10.08 | 39.90 | 34.97 | 147 | 220 | Average | HORIZONTAL |
| 2 | 10643.98 | 57.92 | 74.00 | -16.08 | 42.93 | 10.08 | 39.90 | 34.99 | 147 | 220 | Peak | HORIZONTAL |
| 3 | 15963.32 | 59.62 | 74.00 | -14.38 | 45.39 | 11.89 | 37.75 | 35.41 | 242 | 24 | Peak | HORIZONTAL |
| 4 | 15964.08 | 46.51 | 54.00 | -7.49 | 32.28 | 11.89 | 37.75 | 35.41 | 242 | 24 | Average | HORIZONTAL |

Vertical

| | Freq | Level | Limit | Over | Read | CableAntenna | Preamp | A/Pos | T/Pos | Remark | Pol/Phase | |
|---|----------|--------|--------|--------|-------|--------------|--------|-------|-------|--------|-----------|----------|
| | MHz | dBuV/m | dBuV/m | dB | dBuV | dB | dB/m | dB | cm | deg | | |
| 1 | 10638.22 | 44.57 | 54.00 | -9.43 | 29.56 | 10.08 | 39.90 | 34.97 | 191 | 159 | Average | VERTICAL |
| 2 | 10644.56 | 57.78 | 74.00 | -16.22 | 42.79 | 10.08 | 39.90 | 34.99 | 191 | 159 | Peak | VERTICAL |
| 3 | 15956.26 | 46.70 | 54.00 | -7.30 | 32.47 | 11.89 | 37.75 | 35.41 | 202 | 79 | Average | VERTICAL |
| 4 | 15958.28 | 60.15 | 74.00 | -13.85 | 45.92 | 11.89 | 37.75 | 35.41 | 202 | 79 | Peak | VERTICAL |

| | | | |
|----------------------|----------------------|-----------------------|--|
| Temperature | 22.2°C | Humidity | 51% |
| Test Engineer | John Tang, Zero Chen | Configurations | IEEE 802.11n MCS0 HT20 CH 100 / Ant. 1 + Ant. 2 |
| Test Date | Jul. 27, 2016 | | |

Horizontal

| | Freq | Level | Limit Line | Over Limit | Read Level | Cable Loss | Antenna Factor | Preamp Factor | A/Pos | T/Pos | Remark | Pol/Phase |
|---|----------|--------|------------|------------|------------|------------|----------------|---------------|-------|-------|---------|------------|
| | MHz | dBuV/m | dBuV/m | dB | dBuV | dB | dB/m | dB | cm | deg | | |
| 1 | 10996.48 | 44.18 | 54.00 | -9.82 | 28.88 | 10.27 | 40.20 | 35.17 | 138 | 240 | Average | HORIZONTAL |
| 2 | 11003.08 | 57.34 | 74.00 | -16.66 | 42.04 | 10.27 | 40.20 | 35.17 | 138 | 240 | Peak | HORIZONTAL |

Vertical

| | Freq | Level | Limit Line | Over Limit | Read Level | Cable Loss | Antenna Factor | Preamp Factor | A/Pos | T/Pos | Remark | Pol/Phase |
|---|----------|--------|------------|------------|------------|------------|----------------|---------------|-------|-------|---------|-----------|
| | MHz | dBuV/m | dBuV/m | dB | dBuV | dB | dB/m | dB | cm | deg | | |
| 1 | 10995.52 | 44.19 | 54.00 | -9.81 | 28.94 | 10.25 | 40.17 | 35.17 | 100 | 307 | Average | VERTICAL |
| 2 | 10999.98 | 56.59 | 74.00 | -17.41 | 41.29 | 10.27 | 40.20 | 35.17 | 100 | 307 | Peak | VERTICAL |



| | | | |
|----------------------|----------------------|-----------------------|---|
| Temperature | 22.2°C | Humidity | 51% |
| Test Engineer | John Tang, Zero Chen | Configurations | IEEE 802.11n MCS0 HT20 CH 116 / Ant. 1 + Ant. 2 |
| Test Date | Jul. 27, 2016 | | |

Horizontal

| | Freq | Level | Limit Line | Over Limit | Read Level | Cable Loss | Antenna Factor | Preamp Factor | A/Pos | T/Pos | Remark | Pol/Phase |
|---|----------|--------|------------|------------|------------|------------|----------------|---------------|-------|-------|---------|------------|
| | MHz | dBuV/m | dBuV/m | dB | dBuV | dB | dB/m | dB | cm | deg | | |
| 1 | 11157.26 | 44.76 | 54.00 | -9.24 | 29.47 | 10.35 | 40.13 | 35.19 | 205 | 208 | Average | HORIZONTAL |
| 2 | 11163.80 | 58.14 | 74.00 | -15.86 | 42.85 | 10.35 | 40.13 | 35.19 | 205 | 208 | Peak | HORIZONTAL |

Vertical

| | Freq | Level | Limit Line | Over Limit | Read Level | Cable Loss | Antenna Factor | Preamp Factor | A/Pos | T/Pos | Remark | Pol/Phase |
|---|----------|--------|------------|------------|------------|------------|----------------|---------------|-------|-------|---------|-----------|
| | MHz | dBuV/m | dBuV/m | dB | dBuV | dB | dB/m | dB | cm | deg | | |
| 1 | 11157.42 | 44.61 | 54.00 | -9.39 | 29.32 | 10.35 | 40.13 | 35.19 | 196 | 176 | Average | VERTICAL |
| 2 | 11159.46 | 57.40 | 74.00 | -16.60 | 42.11 | 10.35 | 40.13 | 35.19 | 196 | 176 | Peak | VERTICAL |

| | | | |
|----------------------|----------------------|-----------------------|--|
| Temperature | 22.2°C | Humidity | 51% |
| Test Engineer | John Tang, Zero Chen | Configurations | IEEE 802.11n MCS0 HT20 CH 140 / Ant. 1 + Ant. 2 |
| Test Date | Jul. 27, 2016 | | |

Horizontal

| | Freq | Level | Limit Line | Over Limit | Read Level | CableAntenna Loss | Antenna Factor | Preamp Factor | A/Pos | T/Pos | Remark | Pol/Phase |
|---|----------|--------|------------|------------|------------|-------------------|----------------|---------------|-------|-------|---------|------------|
| | MHz | dBuV/m | dBuV/m | dB | dBuV | dB | dB/m | dB | cm | deg | | |
| 1 | 11401.10 | 45.13 | 54.00 | -8.87 | 29.86 | 10.45 | 40.04 | 35.22 | 158 | 99 | Average | HORIZONTAL |
| 2 | 11404.16 | 57.82 | 74.00 | -16.18 | 42.55 | 10.45 | 40.04 | 35.22 | 158 | 99 | Peak | HORIZONTAL |

Vertical

| | Freq | Level | Limit Line | Over Limit | Read Level | CableAntenna Loss | Antenna Factor | Preamp Factor | A/Pos | T/Pos | Remark | Pol/Phase |
|---|----------|--------|------------|------------|------------|-------------------|----------------|---------------|-------|-------|---------|-----------|
| | MHz | dBuV/m | dBuV/m | dB | dBuV | dB | dB/m | dB | cm | deg | | |
| 1 | 11397.62 | 45.09 | 54.00 | -8.91 | 29.82 | 10.45 | 40.04 | 35.22 | 171 | 116 | Average | VERTICAL |
| 2 | 11403.10 | 58.17 | 74.00 | -15.83 | 42.90 | 10.45 | 40.04 | 35.22 | 171 | 116 | Peak | VERTICAL |

| | | | |
|----------------------|----------------------|-----------------------|--|
| Temperature | 22.2°C | Humidity | 51% |
| Test Engineer | John Tang, Zero Chen | Configurations | IEEE 802.11n MCS0 HT20 CH 149 / Ant. 1 + Ant. 2 |
| Test Date | Jul. 27, 2016 | | |

Horizontal

| | Freq | Level | Limit Line | Over Limit | Read Level | CableAntenna Loss | Antenna Factor | Preamp Factor | A/Pos | T/Pos | Remark | Pol/Phase |
|---|----------|--------|------------|------------|------------|-------------------|----------------|---------------|-------|-------|---------|------------|
| | MHz | dBuV/m | dBuV/m | dB | dBuV | dB | dB/m | dB | cm | deg | | |
| 1 | 11480.00 | 47.85 | 54.00 | -6.15 | 32.59 | 10.48 | 40.01 | 35.23 | 122 | 191 | Average | HORIZONTAL |
| 2 | 11480.00 | 57.38 | 74.00 | -16.62 | 42.12 | 10.48 | 40.01 | 35.23 | 122 | 191 | Peak | HORIZONTAL |

Vertical

| | Freq | Level | Limit Line | Over Limit | Read Level | CableAntenna Loss | Antenna Factor | Preamp Factor | A/Pos | T/Pos | Remark | Pol/Phase |
|---|----------|--------|------------|------------|------------|-------------------|----------------|---------------|-------|-------|---------|-----------|
| | MHz | dBuV/m | dBuV/m | dB | dBuV | dB | dB/m | dB | cm | deg | | |
| 1 | 11488.61 | 58.77 | 74.00 | -15.23 | 43.50 | 10.50 | 40.00 | 35.23 | 158 | 273 | Peak | VERTICAL |
| 2 | 11489.10 | 48.14 | 54.00 | -5.86 | 32.87 | 10.50 | 40.00 | 35.23 | 158 | 273 | Average | VERTICAL |



| | | | |
|----------------------|----------------------|-----------------------|--|
| Temperature | 22.2°C | Humidity | 51% |
| Test Engineer | John Tang, Zero Chen | Configurations | IEEE 802.11n MCS0 HT20 CH 157 / Ant. 1 + Ant. 2 |
| Test Date | Jul. 27, 2016 | | |

Horizontal

| | Freq | Level | Limit Line | Over Limit | Read Level | CableAntenna Loss | Antenna Factor | Preamp Factor | A/Pos | T/Pos | Remark | Pol/Phase |
|---|----------|--------|------------|------------|------------|-------------------|----------------|---------------|-------|-------|---------|------------|
| | MHz | dBuV/m | dBuV/m | dB | dBuV | dB | dB/m | dB | cm | deg | | |
| 1 | 11569.82 | 60.72 | 74.00 | -13.28 | 45.55 | 10.53 | 39.87 | 35.23 | 138 | 186 | Peak | HORIZONTAL |
| 2 | 11569.86 | 48.92 | 54.00 | -5.08 | 33.75 | 10.53 | 39.87 | 35.23 | 138 | 186 | Average | HORIZONTAL |

Vertical

| | Freq | Level | Limit Line | Over Limit | Read Level | CableAntenna Loss | Antenna Factor | Preamp Factor | A/Pos | T/Pos | Remark | Pol/Phase |
|---|----------|--------|------------|------------|------------|-------------------|----------------|---------------|-------|-------|---------|-----------|
| | MHz | dBuV/m | dBuV/m | dB | dBuV | dB | dB/m | dB | cm | deg | | |
| 1 | 11570.02 | 58.54 | 74.00 | -15.46 | 43.37 | 10.53 | 39.87 | 35.23 | 175 | 355 | Peak | VERTICAL |
| 2 | 11570.03 | 49.52 | 54.00 | -4.48 | 34.35 | 10.53 | 39.87 | 35.23 | 175 | 355 | Average | VERTICAL |



| | | | |
|----------------------|----------------------|-----------------------|--|
| Temperature | 22.2°C | Humidity | 51% |
| Test Engineer | John Tang, Zero Chen | Configurations | IEEE 802.11n MCS0 HT20 CH 165 / Ant. 1 + Ant. 2 |
| Test Date | Jul. 27, 2016 | | |

Horizontal

| | Freq | Level | Limit Line | Over Limit | Read Level | CableAntenna Loss | Antenna Factor | Preamp Factor | A/Pos | T/Pos | Remark | Pol/Phase |
|---|----------|--------|------------|------------|------------|-------------------|----------------|---------------|-------|-------|---------|------------|
| | MHz | dBuV/m | dBuV/m | dB | dBuV | dB | dB/m | dB | cm | deg | | |
| 1 | 11650.32 | 47.99 | 54.00 | -6.01 | 32.92 | 10.56 | 39.73 | 35.22 | 142 | 154 | Average | HORIZONTAL |
| 2 | 11656.40 | 60.02 | 74.00 | -13.98 | 44.99 | 10.58 | 39.67 | 35.22 | 142 | 154 | Peak | HORIZONTAL |

Vertical

| | Freq | Level | Limit Line | Over Limit | Read Level | CableAntenna Loss | Antenna Factor | Preamp Factor | A/Pos | T/Pos | Remark | Pol/Phase |
|---|----------|--------|------------|------------|------------|-------------------|----------------|---------------|-------|-------|---------|-----------|
| | MHz | dBuV/m | dBuV/m | dB | dBuV | dB | dB/m | dB | cm | deg | | |
| 1 | 11649.44 | 48.04 | 54.00 | -5.96 | 32.97 | 10.56 | 39.73 | 35.22 | 101 | 89 | Average | VERTICAL |
| 2 | 11649.68 | 60.47 | 74.00 | -13.53 | 45.40 | 10.56 | 39.73 | 35.22 | 101 | 89 | Peak | VERTICAL |

| | | | |
|----------------------|----------------------|-----------------------|---|
| Temperature | 22.2°C | Humidity | 51% |
| Test Engineer | John Tang, Zero Chen | Configurations | IEEE 802.11n MCS0 HT40 CH 38 / Ant. 1 + Ant. 2 |
| Test Date | Jul. 27, 2016 | | |

Horizontal

| | Freq | Level | Limit Line | Over Limit | Read Level | Cable Loss | Antenna Factor | Preamp Factor | A/Pos | T/Pos | Remark | Pol/Phase |
|---|----------|--------|------------|------------|------------|------------|----------------|---------------|-------|-------|---------|------------|
| | MHz | dBuV/m | dBuV/m | dB | dBuV | dB | dB/m | dB | cm | deg | | |
| 1 | 15573.36 | 46.07 | 54.00 | -7.93 | 31.49 | 11.75 | 38.19 | 35.36 | 117 | 192 | Average | HORIZONTAL |
| 2 | 15576.92 | 58.52 | 74.00 | -15.48 | 43.94 | 11.75 | 38.19 | 35.36 | 117 | 192 | Peak | HORIZONTAL |

Vertical

| | Freq | Level | Limit Line | Over Limit | Read Level | Cable Loss | Antenna Factor | Preamp Factor | A/Pos | T/Pos | Remark | Pol/Phase |
|---|----------|--------|------------|------------|------------|------------|----------------|---------------|-------|-------|---------|-----------|
| | MHz | dBuV/m | dBuV/m | dB | dBuV | dB | dB/m | dB | cm | deg | | |
| 1 | 15574.12 | 46.09 | 54.00 | -7.91 | 31.51 | 11.75 | 38.19 | 35.36 | 190 | 206 | Average | VERTICAL |
| 2 | 15578.52 | 59.46 | 74.00 | -14.54 | 44.88 | 11.75 | 38.19 | 35.36 | 190 | 206 | Peak | VERTICAL |



| | | | |
|----------------------|----------------------|-----------------------|---|
| Temperature | 22.2°C | Humidity | 51% |
| Test Engineer | John Tang, Zero Chen | Configurations | IEEE 802.11n MCS0 HT40 CH 46 / Ant. 1 + Ant. 2 |
| Test Date | Jul. 27, 2016 | | |

Horizontal

| | Freq | Level | Limit Line | Over Limit | Read Level | Cable Loss | Antenna Factor | Preamp Factor | A/Pos | T/Pos | Remark | Pol/Phase |
|---|----------|--------|------------|------------|------------|------------|----------------|---------------|-------|-------|---------|------------|
| | MHz | dBuV/m | dBuV/m | dB | dBuV | dB | dB/m | dB | cm | deg | | |
| 1 | 15686.36 | 45.80 | 54.00 | -8.20 | 31.31 | 11.78 | 38.08 | 35.37 | 117 | 198 | Average | HORIZONTAL |
| 2 | 15692.04 | 58.82 | 74.00 | -15.18 | 44.36 | 11.80 | 38.03 | 35.37 | 117 | 198 | Peak | HORIZONTAL |

Vertical

| | Freq | Level | Limit Line | Over Limit | Read Level | Cable Loss | Antenna Factor | Preamp Factor | A/Pos | T/Pos | Remark | Pol/Phase |
|---|----------|--------|------------|------------|------------|------------|----------------|---------------|-------|-------|---------|-----------|
| | MHz | dBuV/m | dBuV/m | dB | dBuV | dB | dB/m | dB | cm | deg | | |
| 1 | 15684.48 | 45.81 | 54.00 | -8.19 | 31.32 | 11.78 | 38.08 | 35.37 | 162 | 136 | Average | VERTICAL |
| 2 | 15693.08 | 58.62 | 74.00 | -15.38 | 44.16 | 11.80 | 38.03 | 35.37 | 162 | 136 | Peak | VERTICAL |

| | | | |
|----------------------|----------------------|-----------------------|---|
| Temperature | 22.2°C | Humidity | 51% |
| Test Engineer | John Tang, Zero Chen | Configurations | IEEE 802.11n MCS0 HT40 CH 54 / Ant. 1 + Ant. 2 |
| Test Date | Jul. 27, 2016 | | |

Horizontal

| | Freq | Level | Limit Line | Over Limit | Read Level | Cable Loss | Antenna Factor | Preamp Factor | A/Pos | T/Pos | Remark | Pol/Phase |
|---|----------|--------|---------------|---------------|---------------|---------------|-------------------|------------------|-------|-------|---------|------------|
| | MHz | dBuV/m | dBuV/m | dB | dBuV | dB | dB/m | dB | cm | deg | | |
| 1 | 15816.12 | 45.38 | 54.00 | -8.62 | 31.02 | 11.84 | 37.92 | 35.40 | 189 | 121 | Average | HORIZONTAL |
| 2 | 15816.60 | 59.06 | 74.00 | -14.94 | 44.70 | 11.84 | 37.92 | 35.40 | 189 | 121 | Peak | HORIZONTAL |

Vertical

| | Freq | Level | Limit Line | Over Limit | Read Level | Cable Loss | Antenna Factor | Preamp Factor | A/Pos | T/Pos | Remark | Pol/Phase |
|---|----------|--------|---------------|---------------|---------------|---------------|-------------------|------------------|-------|-------|---------|-----------|
| | MHz | dBuV/m | dBuV/m | dB | dBuV | dB | dB/m | dB | cm | deg | | |
| 1 | 15801.68 | 45.56 | 54.00 | -8.44 | 31.19 | 11.84 | 37.92 | 35.39 | 160 | 187 | Average | VERTICAL |
| 2 | 15818.68 | 57.81 | 74.00 | -16.19 | 43.45 | 11.84 | 37.92 | 35.40 | 160 | 187 | Peak | VERTICAL |



| | | | |
|----------------------|----------------------|-----------------------|--|
| Temperature | 22.2°C | Humidity | 51% |
| Test Engineer | John Tang, Zero Chen | Configurations | IEEE 802.11nMCS0 HT40 CH 62 / Ant. 1 + Ant. 2 |
| Test Date | Jul. 27, 2016 | | |

Horizontal

| | Freq | Level | Limit Line | Over Limit | Read Level | CableAntenna Loss | Antenna Factor | Preamp Factor | A/Pos | T/Pos | Remark | Pol/Phase |
|---|----------|--------|------------|------------|------------|-------------------|----------------|---------------|-------|-------|---------|------------|
| | MHz | dBuV/m | dBuV/m | dB | dBuV | dB | dB/m | dB | cm | deg | | |
| 1 | 10622.12 | 56.86 | 74.00 | -17.14 | 41.85 | 10.08 | 39.90 | 34.97 | 142 | 206 | Peak | HORIZONTAL |
| 2 | 10624.24 | 44.56 | 54.00 | -9.44 | 29.55 | 10.08 | 39.90 | 34.97 | 142 | 206 | Average | HORIZONTAL |
| 3 | 15935.56 | 59.24 | 74.00 | -14.76 | 45.01 | 11.89 | 37.75 | 35.41 | 169 | 251 | Peak | HORIZONTAL |
| 4 | 15936.60 | 46.42 | 54.00 | -7.58 | 32.19 | 11.89 | 37.75 | 35.41 | 169 | 251 | Average | HORIZONTAL |

Vertical

| | Freq | Level | Limit Line | Over Limit | Read Level | CableAntenna Loss | Antenna Factor | Preamp Factor | A/Pos | T/Pos | Remark | Pol/Phase |
|---|----------|--------|------------|------------|------------|-------------------|----------------|---------------|-------|-------|---------|-----------|
| | MHz | dBuV/m | dBuV/m | dB | dBuV | dB | dB/m | dB | cm | deg | | |
| 1 | 10628.32 | 58.16 | 74.00 | -15.84 | 43.15 | 10.08 | 39.90 | 34.97 | 104 | 126 | Peak | VERTICAL |
| 2 | 10629.88 | 44.76 | 54.00 | -9.24 | 29.75 | 10.08 | 39.90 | 34.97 | 104 | 126 | Average | VERTICAL |
| 3 | 15931.36 | 59.15 | 74.00 | -14.85 | 44.92 | 11.89 | 37.75 | 35.41 | 119 | 167 | Peak | VERTICAL |
| 4 | 15939.36 | 46.45 | 54.00 | -7.55 | 32.22 | 11.89 | 37.75 | 35.41 | 119 | 167 | Average | VERTICAL |



| | | | |
|----------------------|----------------------|-----------------------|--|
| Temperature | 22.2°C | Humidity | 51% |
| Test Engineer | John Tang, Zero Chen | Configurations | IEEE 802.11n MCS0 HT40 CH 102 / Ant. 1 + Ant. 2 |
| Test Date | Jul. 27, 2016 | | |

Horizontal

| | Freq | Level | Limit Line | Over Limit | Read Level | Cable Loss | Antenna Factor | Preamp Factor | A/Pos | T/Pos | Remark | Pol/Phase |
|---|----------|--------|------------|------------|------------|------------|----------------|---------------|-------|-------|---------|------------|
| | MHz | dBuV/m | dBuV/m | dB | dBuV | dB | dB/m | dB | cm | deg | | |
| 1 | 11026.20 | 44.20 | 54.00 | -9.80 | 28.90 | 10.27 | 40.20 | 35.17 | 209 | 168 | Average | HORIZONTAL |
| 2 | 11027.56 | 56.68 | 74.00 | -17.32 | 41.38 | 10.27 | 40.20 | 35.17 | 209 | 168 | Peak | HORIZONTAL |

Vertical

| | Freq | Level | Limit Line | Over Limit | Read Level | Cable Loss | Antenna Factor | Preamp Factor | A/Pos | T/Pos | Remark | Pol/Phase |
|---|----------|--------|------------|------------|------------|------------|----------------|---------------|-------|-------|---------|-----------|
| | MHz | dBuV/m | dBuV/m | dB | dBuV | dB | dB/m | dB | cm | deg | | |
| 1 | 11020.88 | 44.05 | 54.00 | -9.95 | 28.75 | 10.27 | 40.20 | 35.17 | 169 | 231 | Average | VERTICAL |
| 2 | 11027.08 | 56.66 | 74.00 | -17.34 | 41.36 | 10.27 | 40.20 | 35.17 | 169 | 231 | Peak | VERTICAL |

| | | | |
|----------------------|----------------------|-----------------------|--|
| Temperature | 22.2°C | Humidity | 51% |
| Test Engineer | John Tang, Zero Chen | Configurations | IEEE 802.11n MCS0 HT40 CH 110 / Ant. 1 + Ant. 2 |
| Test Date | Jul. 27, 2016 | | |

Horizontal

| | Freq | Level | Limit Line | Over Limit | Read Level | CableAntenna Loss | Antenna Factor | Preamp Factor | A/Pos | T/Pos | Remark | Pol/Phase |
|---|----------|--------|---------------|---------------|---------------|----------------------|-------------------|------------------|-------|-------|---------|------------|
| | MHz | dBuV/m | dBuV/m | dB | dBuV | dB | dB/m | dB | cm | deg | | |
| 1 | 11095.76 | 44.62 | 54.00 | -9.38 | 29.33 | 10.31 | 40.16 | 35.18 | 118 | 285 | Average | HORIZONTAL |
| 2 | 11096.76 | 57.49 | 74.00 | -16.51 | 42.20 | 10.31 | 40.16 | 35.18 | 118 | 285 | Peak | HORIZONTAL |

Vertical

| | Freq | Level | Limit Line | Over Limit | Read Level | CableAntenna Loss | Antenna Factor | Preamp Factor | A/Pos | T/Pos | Remark | Pol/Phase |
|---|----------|--------|---------------|---------------|---------------|----------------------|-------------------|------------------|-------|-------|---------|-----------|
| | MHz | dBuV/m | dBuV/m | dB | dBuV | dB | dB/m | dB | cm | deg | | |
| 1 | 11097.06 | 57.73 | 74.00 | -16.27 | 42.44 | 10.31 | 40.16 | 35.18 | 124 | 207 | Peak | VERTICAL |
| 2 | 11097.92 | 44.80 | 54.00 | -9.20 | 29.51 | 10.31 | 40.16 | 35.18 | 124 | 207 | Average | VERTICAL |



| | | | |
|----------------------|----------------------|-----------------------|--|
| Temperature | 22.2°C | Humidity | 51% |
| Test Engineer | John Tang, Zero Chen | Configurations | IEEE 802.11n MCS0 HT40 CH 134 / Ant. 1 + Ant. 2 |
| Test Date | Jul. 27, 2016 | | |

Horizontal

| | Freq | Level | Limit Line | Over Limit | Read Level | CableAntenna Loss | Antenna Factor | Preamp Factor | A/Pos | T/Pos | Remark | Pol/Phase |
|---|----------|--------|------------|------------|------------|-------------------|----------------|---------------|-------|-------|---------|------------|
| | MHz | dBuV/m | dBuV/m | dB | dBuV | dB | dB/m | dB | cm | deg | | |
| 1 | 11415.06 | 45.00 | 54.00 | -9.00 | 29.73 | 10.45 | 40.04 | 35.22 | 193 | 218 | Average | HORIZONTAL |
| 2 | 11417.92 | 58.19 | 74.00 | -15.81 | 42.91 | 10.47 | 40.03 | 35.22 | 193 | 218 | Peak | HORIZONTAL |

Vertical

| | Freq | Level | Limit Line | Over Limit | Read Level | CableAntenna Loss | Antenna Factor | Preamp Factor | A/Pos | T/Pos | Remark | Pol/Phase |
|---|----------|--------|------------|------------|------------|-------------------|----------------|---------------|-------|-------|---------|-----------|
| | MHz | dBuV/m | dBuV/m | dB | dBuV | dB | dB/m | dB | cm | deg | | |
| 1 | 11420.86 | 58.11 | 74.00 | -15.89 | 42.83 | 10.47 | 40.03 | 35.22 | 146 | 164 | Peak | VERTICAL |
| 2 | 11423.12 | 44.82 | 54.00 | -9.18 | 29.54 | 10.47 | 40.03 | 35.22 | 146 | 164 | Average | VERTICAL |

| | | | |
|----------------------|----------------------|-----------------------|--|
| Temperature | 22.2°C | Humidity | 51% |
| Test Engineer | John Tang, Zero Chen | Configurations | IEEE 802.11n MCS0 HT40 CH 151 / Ant. 1 + Ant. 2 |
| Test Date | Jul. 27, 2016 | | |

Horizontal

| | Freq | Level | Limit Line | Over Limit | Read Level | CableAntenna Loss | Antenna Factor | Preamp Factor | A/Pos | T/Pos | Remark | Pol/Phase |
|---|----------|--------|---------------|---------------|---------------|----------------------|-------------------|------------------|-------|-------|---------|------------|
| | MHz | dBuV/m | dBuV/m | dB | dBuV | dB | dB/m | dB | cm | deg | | |
| 1 | 11509.72 | 57.83 | 74.00 | -16.17 | 42.56 | 10.50 | 40.00 | 35.23 | 206 | 255 | Peak | HORIZONTAL |
| 2 | 11514.92 | 44.43 | 54.00 | -9.57 | 29.16 | 10.50 | 40.00 | 35.23 | 206 | 255 | Average | HORIZONTAL |

Vertical

| | Freq | Level | Limit Line | Over Limit | Read Level | CableAntenna Loss | Antenna Factor | Preamp Factor | A/Pos | T/Pos | Remark | Pol/Phase |
|---|----------|--------|---------------|---------------|---------------|----------------------|-------------------|------------------|-------|-------|---------|-----------|
| | MHz | dBuV/m | dBuV/m | dB | dBuV | dB | dB/m | dB | cm | deg | | |
| 1 | 11506.58 | 44.28 | 54.00 | -9.72 | 29.01 | 10.50 | 40.00 | 35.23 | 160 | 195 | Average | VERTICAL |
| 2 | 11513.74 | 57.39 | 74.00 | -16.61 | 42.12 | 10.50 | 40.00 | 35.23 | 160 | 195 | Peak | VERTICAL |

| | | | |
|----------------------|----------------------|-----------------------|--|
| Temperature | 22.2°C | Humidity | 51% |
| Test Engineer | John Tang, Zero Chen | Configurations | IEEE 802.11n MCS0 HT40 CH 159 / Ant. 1 + Ant. 2 |
| Test Date | Jul. 27, 2016 | | |

Horizontal

| | Freq | Level | Limit Line | Over Limit | Read Level | CableAntenna Loss | Antenna Factor | Preamp Factor | A/Pos | T/Pos | Remark | Pol/Phase |
|---|----------|--------|---------------|---------------|---------------|----------------------|-------------------|------------------|-------|-------|---------|------------|
| | MHz | dBuV/m | dBuV/m | dB | dBuV | dB | dB/m | dB | cm | deg | | |
| 1 | 11586.70 | 57.20 | 74.00 | -16.80 | 42.07 | 10.55 | 39.80 | 35.22 | 105 | 121 | Peak | HORIZONTAL |
| 2 | 11591.14 | 44.33 | 54.00 | -9.67 | 29.20 | 10.55 | 39.80 | 35.22 | 105 | 121 | Average | HORIZONTAL |

Vertical

| | Freq | Level | Limit Line | Over Limit | Read Level | CableAntenna Loss | Antenna Factor | Preamp Factor | A/Pos | T/Pos | Remark | Pol/Phase |
|---|----------|--------|---------------|---------------|---------------|----------------------|-------------------|------------------|-------|-------|---------|-----------|
| | MHz | dBuV/m | dBuV/m | dB | dBuV | dB | dB/m | dB | cm | deg | | |
| 1 | 11585.40 | 44.20 | 54.00 | -9.80 | 29.07 | 10.55 | 39.80 | 35.22 | 134 | 75 | Average | VERTICAL |
| 2 | 11587.30 | 57.57 | 74.00 | -16.43 | 42.44 | 10.55 | 39.80 | 35.22 | 134 | 75 | Peak | VERTICAL |



Straddle Channel

| | | | |
|----------------------|----------------------|-----------------------|---------------------------------------|
| Temperature | 22.2°C | Humidity | 51% |
| Test Engineer | John Tang, Zero Chen | Configurations | IEEE 802.11a CH 144 / Ant. 1 + Ant. 2 |
| Test Date | Jul. 27, 2016 | | |

Horizontal

| | Freq | Level | Limit Line | Over Limit | Read Level | CableAntenna Loss | Antenna Factor | Preamp Factor | A/Pos | T/Pos | Remark | Pol/Phase |
|---|----------|--------|------------|------------|------------|-------------------|----------------|---------------|-------|-------|---------|------------|
| | MHz | dBuV/m | dBuV/m | dB | dBuV | dB | dB/m | dB | cm | deg | | |
| 1 | 11438.20 | 44.48 | 54.00 | -9.52 | 29.21 | 10.47 | 40.03 | 35.23 | 193 | 30 | Average | HORIZONTAL |
| 2 | 11441.98 | 57.73 | 74.00 | -16.27 | 42.46 | 10.47 | 40.03 | 35.23 | 193 | 30 | Peak | HORIZONTAL |

Vertical

| | Freq | Level | Limit Line | Over Limit | Read Level | CableAntenna Loss | Antenna Factor | Preamp Factor | A/Pos | T/Pos | Remark | Pol/Phase |
|---|----------|--------|------------|------------|------------|-------------------|----------------|---------------|-------|-------|---------|-----------|
| | MHz | dBuV/m | dBuV/m | dB | dBuV | dB | dB/m | dB | cm | deg | | |
| 1 | 11440.42 | 44.70 | 54.00 | -9.30 | 29.43 | 10.47 | 40.03 | 35.23 | 159 | 106 | Average | VERTICAL |
| 2 | 11442.00 | 58.41 | 74.00 | -15.59 | 43.14 | 10.47 | 40.03 | 35.23 | 159 | 106 | Peak | VERTICAL |

| | | | |
|----------------------|----------------------|-----------------------|--|
| Temperature | 22.2°C | Humidity | 51% |
| Test Engineer | John Tang, Zero Chen | Configurations | IEEE 802.11n MCS0 HT20 CH 144 / Ant. 1 + Ant. 2 |
| Test Date | Jul. 27, 2016 | | |

Horizontal

| | Freq | Level | Limit Line | Over Limit | Read Level | CableAntenna Loss | Antenna Factor | Preamp Factor | A/Pos | T/Pos | Remark | Pol/Phase |
|---|----------|--------|------------|------------|------------|-------------------|----------------|---------------|-------|-------|---------|------------|
| | MHz | dBuV/m | dBuV/m | dB | dBuV | dB | dB/m | dB | cm | deg | | |
| 1 | 11435.06 | 60.17 | 74.00 | -13.83 | 44.90 | 10.47 | 40.03 | 35.23 | 141 | 166 | Peak | HORIZONTAL |
| 2 | 11435.14 | 46.83 | 54.00 | -7.17 | 31.56 | 10.47 | 40.03 | 35.23 | 141 | 166 | Average | HORIZONTAL |

Vertical

| | Freq | Level | Limit Line | Over Limit | Read Level | CableAntenna Loss | Antenna Factor | Preamp Factor | A/Pos | T/Pos | Remark | Pol/Phase |
|---|----------|--------|------------|------------|------------|-------------------|----------------|---------------|-------|-------|---------|-----------|
| | MHz | dBuV/m | dBuV/m | dB | dBuV | dB | dB/m | dB | cm | deg | | |
| 1 | 11439.80 | 59.46 | 74.00 | -14.54 | 44.19 | 10.47 | 40.03 | 35.23 | 170 | 92 | Peak | VERTICAL |
| 2 | 11442.64 | 46.92 | 54.00 | -7.08 | 31.65 | 10.47 | 40.03 | 35.23 | 170 | 92 | Average | VERTICAL |



| | | | |
|----------------------|----------------------|-----------------------|---|
| Temperature | 22.2°C | Humidity | 51% |
| Test Engineer | John Tang, Zero Chen | Configurations | IEEE 802.11n MCS0 HT40 CH 142 / Ant. 1 + Ant. 2 |
| Test Date | Jul. 27, 2016 | | |

Horizontal

| | Freq | Level | Limit Line | Over Limit | Read Level | Cable Loss | Antenna Factor | Preamp Factor | A/Pos | T/Pos | Remark | Pol/Phase |
|---|----------|--------|------------|------------|------------|------------|----------------|---------------|-------|-------|---------|------------|
| | MHz | dBuV/m | dBuV/m | dB | dBuV | dB | dB/m | dB | cm | deg | | |
| 1 | 11417.86 | 45.06 | 54.00 | -8.94 | 29.78 | 10.47 | 40.03 | 35.22 | 150 | 155 | Average | HORIZONTAL |
| 2 | 11422.14 | 59.24 | 74.00 | -14.76 | 43.96 | 10.47 | 40.03 | 35.22 | 150 | 155 | Peak | HORIZONTAL |

Vertical

| | Freq | Level | Limit Line | Over Limit | Read Level | Cable Loss | Antenna Factor | Preamp Factor | A/Pos | T/Pos | Remark | Pol/Phase |
|---|----------|--------|------------|------------|------------|------------|----------------|---------------|-------|-------|---------|-----------|
| | MHz | dBuV/m | dBuV/m | dB | dBuV | dB | dB/m | dB | cm | deg | | |
| 1 | 11420.20 | 45.02 | 54.00 | -8.98 | 29.74 | 10.47 | 40.03 | 35.22 | 123 | 139 | Average | VERTICAL |
| 2 | 11424.12 | 58.07 | 74.00 | -15.93 | 42.79 | 10.47 | 40.03 | 35.22 | 123 | 139 | Peak | VERTICAL |

Note:

The amplitude of spurious emissions that are attenuated by more than 20dB below the permissible value has no need to be reported.

Emission level (dBuV/m) = 20 log Emission level (uV/m).

Corrected Reading: Antenna Factor + Cable Loss + Read Level - Preamp Factor = Level.

4.7. Band Edge Emissions Measurement

4.7.1. Limit

For transmitters operating in the 5.15-5.35 GHz band: all emissions outside of the 5.15-5.35 GHz band shall not exceed an e.i.r.p. of -27 dBm/MHz.

For transmitters operating in the 5.470-5.725 GHz band: all emissions outside of the 5.47-5.725 GHz band shall not exceed an e.i.r.p. of -27 dBm/MHz.

For transmitters operating in the 5.725-5.85 GHz band: all emissions shall be limited to a level of -27 dBm/MHz at 75 MHz or more above or below the band edge increasing linearly to 10 dBm/MHz at 25 MHz above or below the band edge, and from 25 MHz above or below the band edge increasing linearly to a level of 15.6 dBm/MHz at 5 MHz above or below the band edge, and from 5 MHz above or below the band edge increasing linearly to a level of 27 dBm/MHz at the band edge.

In addition, In case the emission fall within the restricted band specified on 15.205(a), then the 15.209(a) limit in the table below has to be followed.

| Frequencies (MHz) | Field Strength (micровolts/meter) | Measurement Distance (meters) |
|-------------------|-----------------------------------|-------------------------------|
| 0.009~0.490 | 2400/F(kHz) | 300 |
| 0.490~1.705 | 24000/F(kHz) | 30 |
| 1.705~30.0 | 30 | 30 |
| 30~88 | 100 | 3 |
| 88~216 | 150 | 3 |
| 216~960 | 200 | 3 |
| Above 960 | 500 | 3 |

4.7.2. Measuring Instruments and Setting

Please refer to section 5 of equipments list in this report. The following table is the setting of the spectrum analyzer.

| Spectrum Parameter | Setting |
|---|---|
| Attenuation | Auto |
| Span Frequency | 100 MHz |
| RBW / VBW (Emission in restricted band) | 1 MHz / 3MHz for Peak, 1 MHz / 1/T for Average |
| RBW / VBW (Emission in non-restricted band) | 1 MHz / 3MHz for Peak |

4.7.3. Test Procedures

The test procedure is the same as section 4.6.3.

4.7.4. Test Setup Layout

This test setup layout is the same as that shown in section 4.6.4.

4.7.5. Test Deviation

There is no deviation with the original standard.

4.7.6. EUT Operation during Test

The EUT was programmed to be in continuously transmitting mode.

4.7.7. Test Result of Band Edge and Fundamental Emissions

| | | | |
|---------------|----------------------|----------------|--|
| Temperature | 22.2°C | Humidity | 51% |
| Test Engineer | John Tang, Zero Chen | Configurations | IEEE 802.11a CH 36, 40, 48 / Ant. 1 + Ant. 2 |

Channel 36

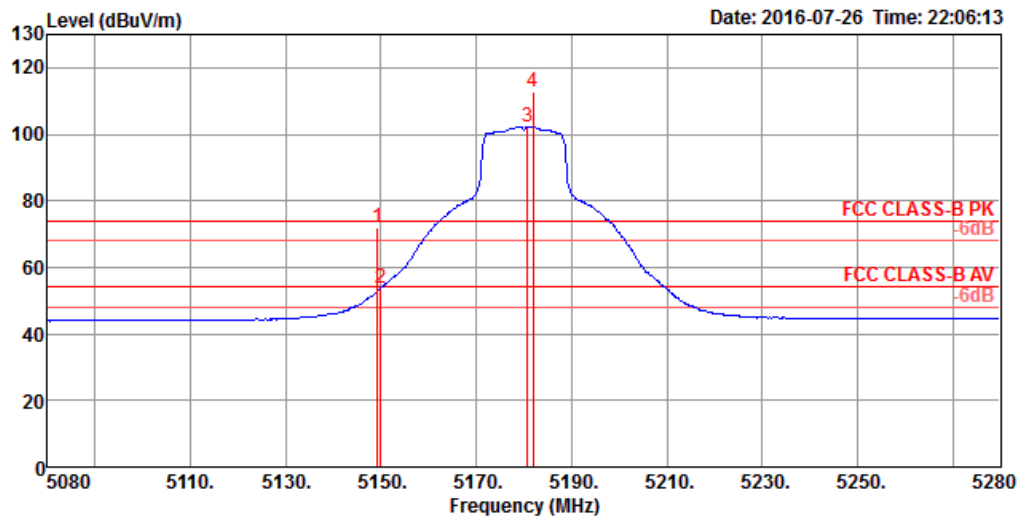

| | Freq | Level | Limit Line | Over Limit | Read Level | Cable Loss | Antenna Factor | Preamp Factor | A/Pos | T/Pos | Remark | Pol/Phase |
|---|---------|--------|------------|------------|------------|------------|----------------|---------------|-------|-------|---------|------------|
| | MHz | dBuV/m | dBuV/m | dB | dBuV | dB | dB/m | dB | cm | deg | | |
| 1 | 5149.20 | 71.86 | 74.00 | -2.14 | 66.77 | 6.51 | 31.52 | 32.94 | 100 | 317 | Peak | HORIZONTAL |
| 2 | 5150.00 | 53.91 | 54.00 | -0.09 | 48.82 | 6.51 | 31.52 | 32.94 | 100 | 317 | Average | HORIZONTAL |
| 3 | 5180.80 | 102.33 | | | 97.19 | 6.53 | 31.55 | 32.94 | 100 | 317 | Average | HORIZONTAL |
| 4 | 5182.00 | 112.49 | | | 107.35 | 6.53 | 31.55 | 32.94 | 100 | 317 | Peak | HORIZONTAL |

Item 3, 4 are the fundamental frequency at 5180 MHz.

Channel 40

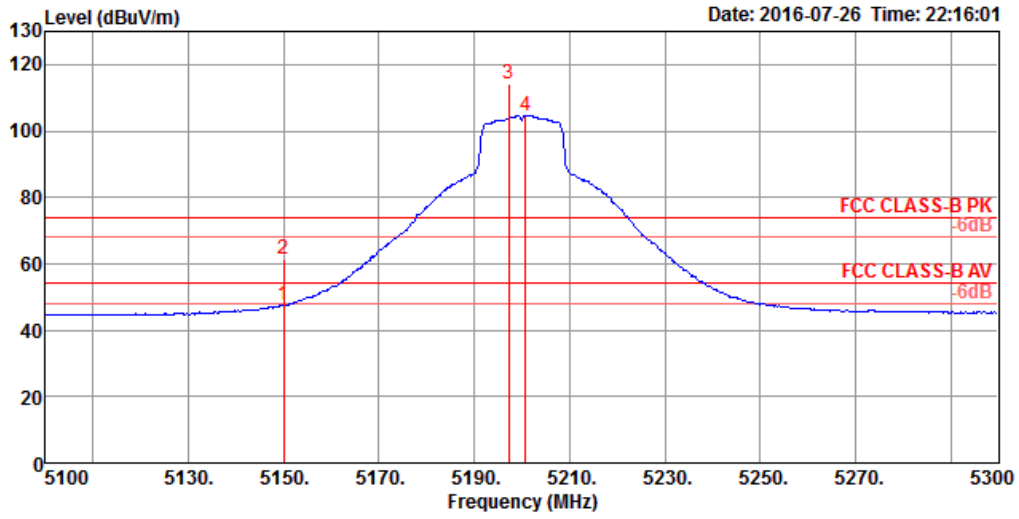

| | Freq | Level | Limit Line | Over Limit | Read Level | CableAntenna Loss | Preamp Factor | A/Pos | T/Pos | Remark | Pol/Phase |
|---|---------|--------|------------|------------|------------|-------------------|---------------|-------|-------|-------------|------------|
| | MHz | dBuV/m | dBuV/m | dB | dBuV | dB | dB/m | dB | cm | deg | |
| 1 | 5150.00 | 47.49 | 54.00 | -6.51 | 42.40 | 6.51 | 31.52 | 32.94 | 101 | 318 Average | HORIZONTAL |
| 2 | 5150.00 | 61.48 | 74.00 | -12.52 | 56.39 | 6.51 | 31.52 | 32.94 | 101 | 318 Peak | HORIZONTAL |
| 3 | 5197.20 | 114.21 | | | 109.05 | 6.54 | 31.56 | 32.94 | 101 | 318 Peak | HORIZONTAL |
| 4 | 5200.80 | 104.61 | | | 99.45 | 6.54 | 31.56 | 32.94 | 101 | 318 Average | HORIZONTAL |

Item 3, 4 are the fundamental frequency at 5200 MHz.

Channel 48

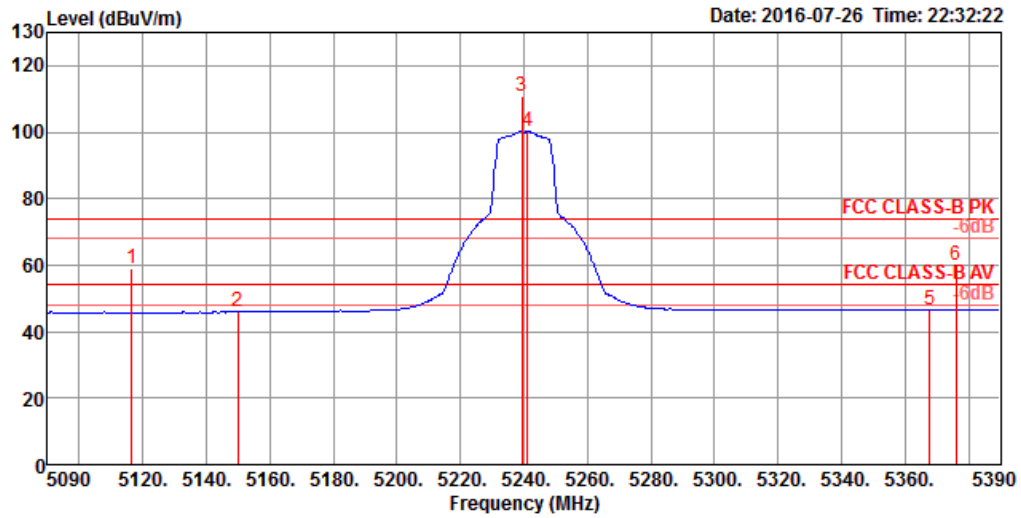

| | Freq | Level | Limit Line | Over Limit | Read Level | CableAntenna Loss | Preamp Factor | A/Pos | T/Pos | Remark | Pol/Phase | |
|---|---------|--------|------------|------------|------------|-------------------|---------------|-------|-------|--------|-----------|----------|
| | MHz | dBuV/m | dBuV/m | dB | dBuV | dB | dB/m | dB | cm | deg | | |
| 1 | 5116.40 | 59.12 | 74.00 | -14.88 | 54.08 | 6.48 | 31.50 | 32.94 | 101 | 360 | Peak | VERTICAL |
| 2 | 5150.00 | 45.83 | 54.00 | -8.17 | 40.74 | 6.51 | 31.52 | 32.94 | 101 | 360 | Average | VERTICAL |
| 3 | 5239.40 | 110.91 | | | 105.69 | 6.57 | 31.59 | 32.94 | 101 | 360 | Peak | VERTICAL |
| 4 | 5241.20 | 100.17 | | | 94.95 | 6.57 | 31.59 | 32.94 | 101 | 360 | Average | VERTICAL |
| 5 | 5367.80 | 46.70 | 54.00 | -7.30 | 41.27 | 6.67 | 31.69 | 32.93 | 101 | 360 | Average | VERTICAL |
| 6 | 5376.20 | 59.84 | 74.00 | -14.16 | 54.39 | 6.68 | 31.70 | 32.93 | 101 | 360 | Peak | VERTICAL |

Item 3, 4 are the fundamental frequency at 5240 MHz.

| | | | |
|---------------|----------------------|----------------|--|
| Temperature | 22.2°C | Humidity | 51% |
| Test Engineer | John Tang, Zero Chen | Configurations | IEEE 802.11a CH 52, 60, 64 / Ant. 1 + Ant. 2 |

Channel 52

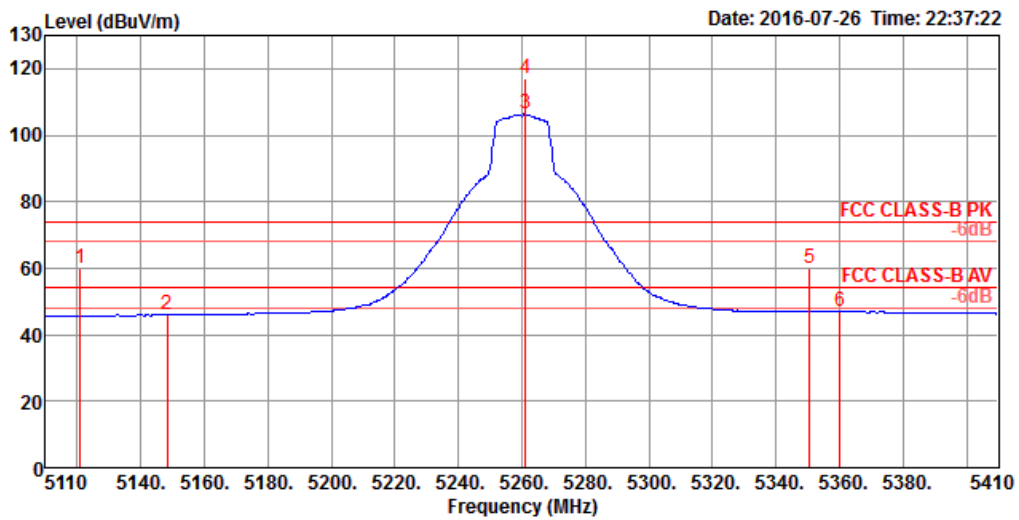

| | Freq | Level | Limit | Over | Read | CableAntenna | Preamp | A/Pos | T/Pos | Remark | Pol/Phase |
|---|---------|--------|--------|--------|--------|--------------|--------|-------|-------|-------------|------------|
| | MHz | dBuV/m | dBuV/m | dB | dBuV | dB | dB/m | dB | cm | deg | |
| 1 | 5120.80 | 59.87 | 74.00 | -14.13 | 54.83 | 6.48 | 31.50 | 32.94 | 101 | 317 Peak | HORIZONTAL |
| 2 | 5148.40 | 45.97 | 54.00 | -8.03 | 40.88 | 6.51 | 31.52 | 32.94 | 101 | 317 Average | HORIZONTAL |
| 3 | 5261.20 | 106.36 | | | 101.09 | 6.59 | 31.61 | 32.93 | 101 | 317 Average | HORIZONTAL |
| 4 | 5261.20 | 117.11 | | | 111.84 | 6.59 | 31.61 | 32.93 | 101 | 317 Peak | HORIZONTAL |
| 5 | 5350.60 | 59.89 | 74.00 | -14.11 | 54.48 | 6.66 | 31.68 | 32.93 | 101 | 317 Peak | HORIZONTAL |
| 6 | 5360.20 | 46.94 | 54.00 | -7.06 | 41.51 | 6.67 | 31.69 | 32.93 | 101 | 317 Average | HORIZONTAL |

Item 3, 4 are the fundamental frequency at 5260 MHz.

Channel 60

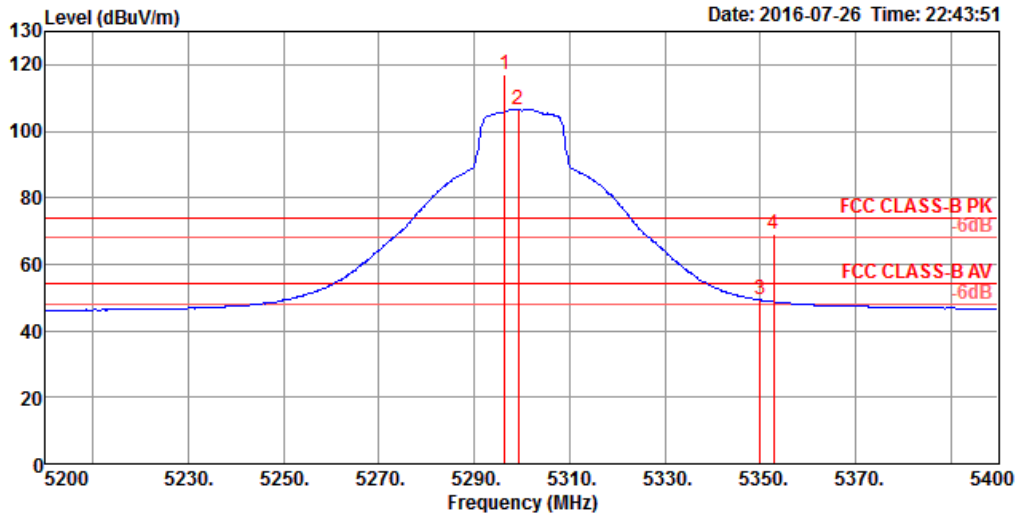

| | Freq | Level | Limit Line | Over Limit | Read Level | CableAntenna Loss | Preamp Factor | A/Pos | T/Pos | Remark | Pol/Phase |
|-----|---------|--------|------------|------------|------------|-------------------|---------------|-------|-------|-------------|------------|
| | MHz | dBuV/m | dBuV/m | dB | dBuV | dB | dB/m | dB | cm | deg | |
| 1 0 | 5296.40 | 117.21 | | | 111.88 | 6.62 | 31.64 | 32.93 | 104 | 316 Peak | HORIZONTAL |
| 2 0 | 5299.20 | 106.70 | | | 101.37 | 6.62 | 31.64 | 32.93 | 104 | 316 Average | HORIZONTAL |
| 3 | 5350.00 | 49.25 | 54.00 | -4.75 | 43.84 | 6.66 | 31.68 | 32.93 | 104 | 316 Average | HORIZONTAL |
| 4 | 5352.80 | 69.23 | 74.00 | -4.77 | 63.82 | 6.66 | 31.68 | 32.93 | 104 | 316 Peak | HORIZONTAL |

Item 1, 2 are the fundamental frequency at 5300 MHz.

Channel 64

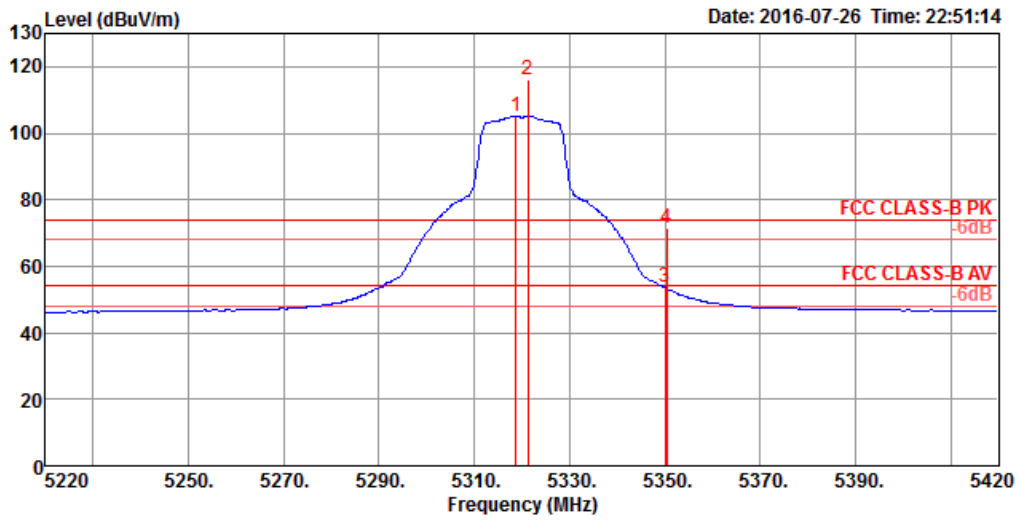

| | Freq | Level | Limit Line | Over Limit | Read Level | CableAntenna Loss | Preamp Factor | A/Pos | T/Pos | Remark | Pol/Phase |
|-----|---------|--------|------------|------------|------------|-------------------|---------------|-------|-------|-------------|------------|
| | MHz | dBuV/m | dBuV/m | dB | dBuV | dB | dB/m | dB | cm | deg | |
| 1 0 | 5318.80 | 105.26 | | | 99.91 | 6.63 | 31.65 | 32.93 | 100 | 314 Average | HORIZONTAL |
| 2 0 | 5321.20 | 115.99 | | | 110.64 | 6.63 | 31.65 | 32.93 | 100 | 314 Peak | HORIZONTAL |
| 3 | 5350.00 | 53.56 | 54.00 | -0.44 | 48.15 | 6.66 | 31.68 | 32.93 | 100 | 314 Average | HORIZONTAL |
| 4 | 5350.40 | 71.59 | 74.00 | -2.41 | 66.18 | 6.66 | 31.68 | 32.93 | 100 | 314 Peak | HORIZONTAL |

Item 1, 2 are the fundamental frequency at 5320 MHz.

| | | | |
|----------------------|----------------------|-----------------------|---|
| Temperature | 22.2°C | Humidity | 51% |
| Test Engineer | John Tang, Zero Chen | Configurations | IEEE 802.11a CH 100, 116, 140 / Ant. 1 + Ant. 2 |

Channel 100

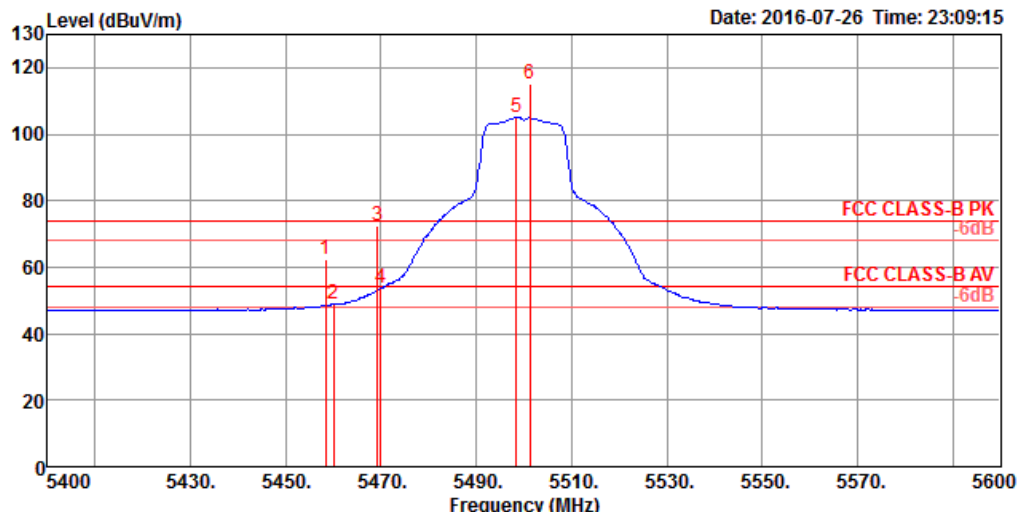

| | Freq | Level | Limit Line | Over Limit | Read Level | CableAntenna Loss | Preamp Factor | A/Pos | T/Pos | Remark | Pol/Phase |
|---|---------|--------|------------|------------|------------|-------------------|---------------|-------|-------|-------------|------------|
| | MHz | dBuV/m | dBuV/m | dB | dBuV | dB | dB/m | dB | cm | deg | |
| 1 | 5458.40 | 62.24 | 74.00 | -11.76 | 56.67 | 6.73 | 31.76 | 32.92 | 100 | 313 Peak | HORIZONTAL |
| 2 | 5460.00 | 48.80 | 54.00 | -5.20 | 43.23 | 6.73 | 31.76 | 32.92 | 100 | 313 Average | HORIZONTAL |
| 3 | 5469.20 | 72.33 | 74.00 | -1.67 | 66.73 | 6.74 | 31.78 | 32.92 | 100 | 313 Peak | HORIZONTAL |
| 4 | 5470.00 | 53.60 | 54.00 | -0.40 | 48.00 | 6.74 | 31.78 | 32.92 | 100 | 313 Average | HORIZONTAL |
| 5 | 5498.40 | 105.02 | | | 99.38 | 6.76 | 31.80 | 32.92 | 100 | 313 Average | HORIZONTAL |
| 6 | 5501.20 | 115.15 | | | 109.51 | 6.76 | 31.80 | 32.92 | 100 | 313 Peak | HORIZONTAL |

Item 5, 6 are the fundamental frequency at 5500 MHz.

Channel 116

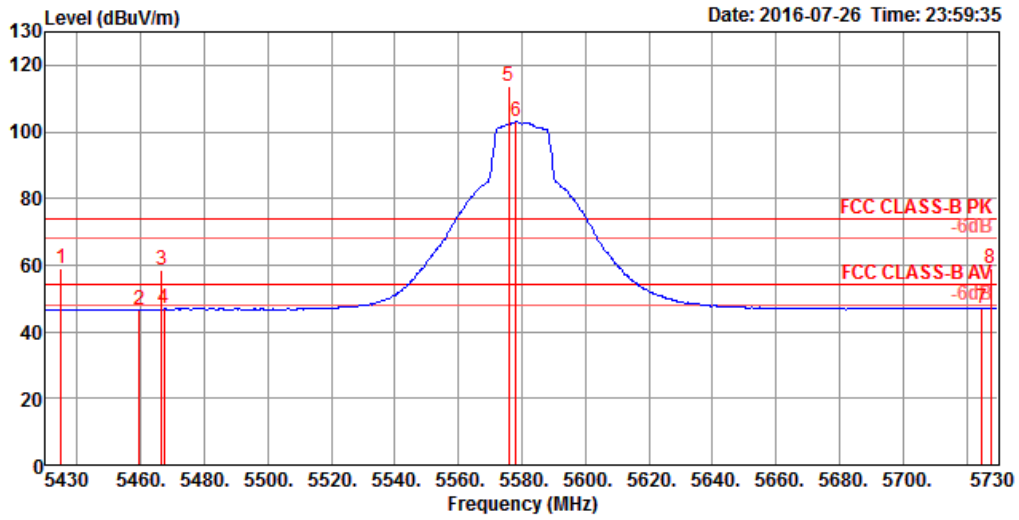

| | Freq | Level | Limit Line | Over Limit | Read Level | CableAntenna Loss | Preamp Factor | A/Pos | T/Pos | Remark | Pol/Phase |
|---|---------|--------|------------|------------|------------|-------------------|---------------|-------|-------|-------------|-----------|
| | MHz | dBuV/m | dBuV/m | dB | dBuV | dB | dB/m | dB | cm | deg | |
| 1 | 5434.80 | 58.79 | 74.00 | -15.21 | 53.24 | 6.72 | 31.75 | 32.92 | 101 | 332 Peak | VERTICAL |
| 2 | 5459.40 | 46.67 | 54.00 | -7.33 | 41.10 | 6.73 | 31.76 | 32.92 | 101 | 332 Average | VERTICAL |
| 3 | 5466.40 | 58.55 | 74.00 | -15.45 | 52.95 | 6.74 | 31.78 | 32.92 | 101 | 332 Peak | VERTICAL |
| 4 | 5467.20 | 46.79 | 54.00 | -7.21 | 41.19 | 6.74 | 31.78 | 32.92 | 101 | 332 Average | VERTICAL |
| 5 | 5575.80 | 113.66 | | | 107.90 | 6.81 | 31.90 | 32.95 | 101 | 332 Peak | VERTICAL |
| 6 | 5578.20 | 102.95 | | | 97.20 | 6.81 | 31.90 | 32.96 | 101 | 332 Average | VERTICAL |
| 7 | 5725.00 | 46.93 | 54.00 | -7.07 | 40.92 | 6.93 | 32.08 | 33.00 | 101 | 332 Average | VERTICAL |
| 8 | 5727.60 | 59.22 | 74.00 | -14.78 | 53.22 | 6.93 | 32.08 | 33.01 | 101 | 332 Peak | VERTICAL |

Item 5, 6 are the fundamental frequency at 5580 MHz.

Channel 140

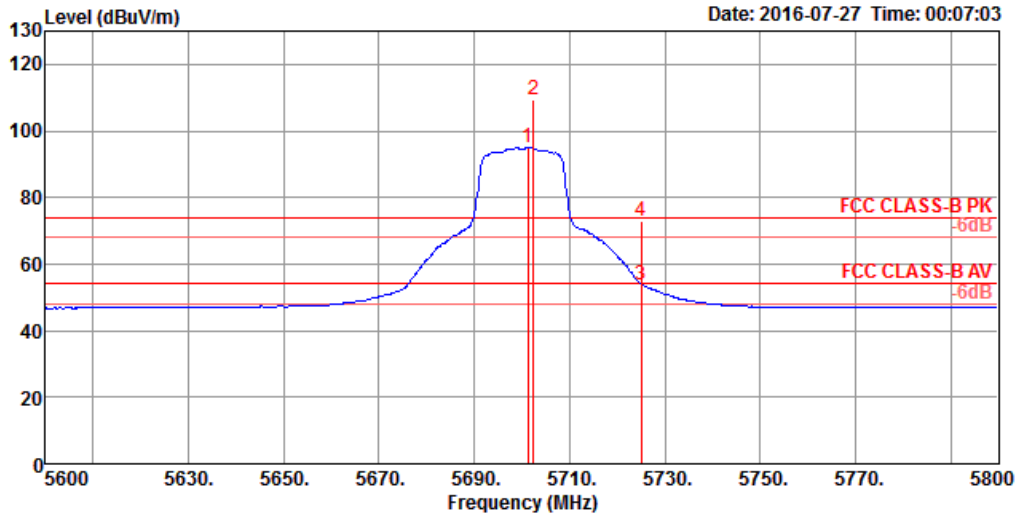

| | Freq | Level | Limit Line | Over Limit | Read Level | CableAntenna Loss | Preamp Factor | A/Pos | T/Pos | Remark | Pol/Phase |
|-----|---------|--------|------------|------------|------------|-------------------|---------------|-------|-------|-----------|-----------|
| | MHz | dBuV/m | dBuV/m | dB | dBuV | dB | dB/m | dB | cm | deg | |
| 1 0 | 5701.20 | 94.80 | | | 88.86 | 6.90 | 32.04 | 33.00 | 100 | 1 Average | VERTICAL |
| 2 0 | 5702.40 | 109.49 | | | 103.55 | 6.90 | 32.04 | 33.00 | 100 | 1 Peak | VERTICAL |
| 3 | 5725.00 | 53.81 | 54.00 | -0.19 | 47.80 | 6.93 | 32.08 | 33.00 | 100 | 1 Average | VERTICAL |
| 4 | 5725.00 | 72.99 | 74.00 | -1.01 | 66.98 | 6.93 | 32.08 | 33.00 | 100 | 1 Peak | VERTICAL |

Item 1, 2 are the fundamental frequency at 5700 MHz.

| | | | |
|----------------------|----------------------|-----------------------|--|
| Temperature | 22.2°C | Humidity | 51% |
| Test Engineer | John Tang, Zero Chen | Configurations | IEEE 802.11a CH 149, 157, 165 / Ant. 1 + Ant. 2 |

Channel 149

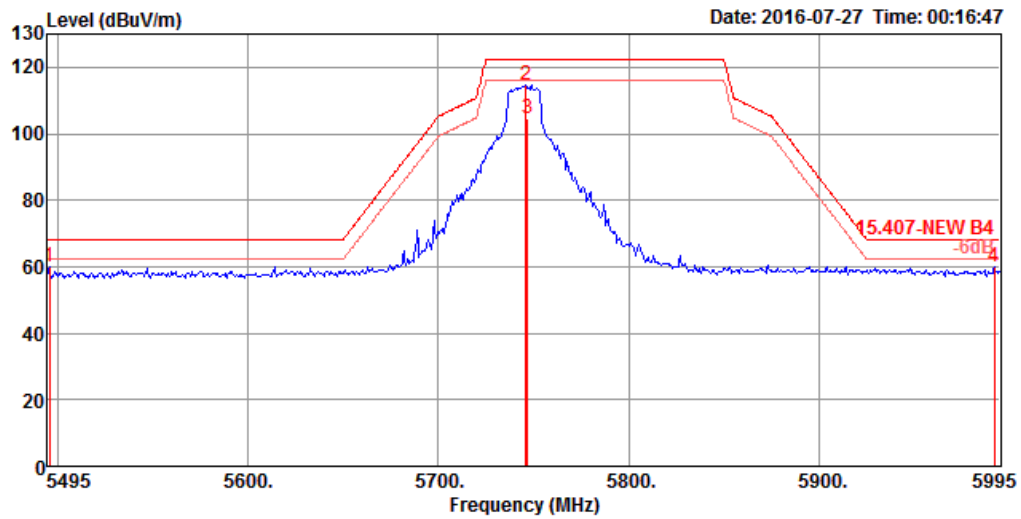

| | Freq | Level | Limit Line | Over Limit | Read Level | Cable Loss | Antenna Factor | Preamp Factor | A/Pos | T/Pos | Remark | Pol/Phase |
|---|---------|--------|------------|------------|------------|------------|----------------|---------------|-------|-------|---------|------------|
| | MHz | dBuV/m | dBuV/m | dB | dBuV | dB | dB/m | dB | cm | deg | | |
| 1 | 5496.00 | 59.92 | 68.20 | -8.28 | 54.28 | 6.76 | 31.80 | 32.92 | 100 | 296 | Peak | HORIZONTAL |
| 2 | 5746.00 | 114.74 | | | 108.72 | 6.94 | 32.10 | 33.02 | 100 | 296 | Peak | HORIZONTAL |
| 3 | 5747.00 | 104.49 | | | 98.47 | 6.94 | 32.10 | 33.02 | 100 | 296 | Average | HORIZONTAL |
| 4 | 5992.00 | 60.01 | 68.20 | -8.19 | 53.69 | 7.04 | 32.38 | 33.10 | 100 | 296 | Peak | HORIZONTAL |

Item 2, 3 are the fundamental frequency at 5745 MHz.

Channel 157

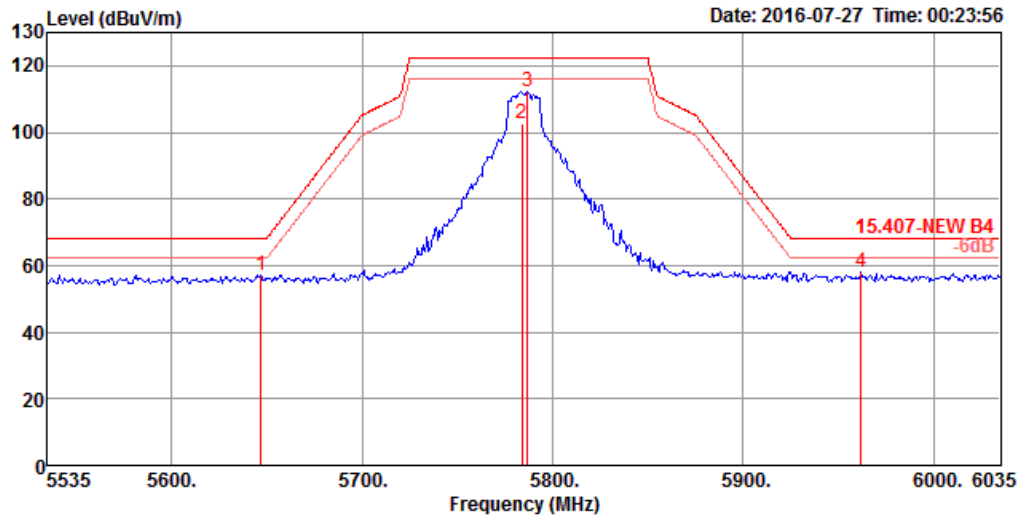

| | Freq | Level | Limit Line | Over Limit | Read Level | Cable Loss | Antenna Factor | Preamp Factor | A/Pos | T/Pos | Remark | Pol/Phase |
|---|---------|--------|------------|------------|------------|------------|----------------|---------------|-------|-------|---------|------------|
| | MHz | dBuV/m | dBuV/m | dB | dBuV | dB | dB/m | dB | cm | deg | | |
| 1 | 5647.00 | 57.12 | 68.20 | -11.08 | 51.26 | 6.86 | 31.98 | 32.98 | 100 | 296 | Peak | HORIZONTAL |
| 2 | 5784.00 | 102.53 | | | 96.45 | 6.97 | 32.14 | 33.03 | 100 | 296 | Average | HORIZONTAL |
| 3 | 5787.00 | 112.45 | | | 106.37 | 6.97 | 32.14 | 33.03 | 100 | 296 | Peak | HORIZONTAL |
| 4 | 5962.00 | 58.09 | 68.20 | -10.11 | 51.79 | 7.04 | 32.36 | 33.10 | 100 | 296 | Peak | HORIZONTAL |

Item 2, 3 are the fundamental frequency at 5785 MHz.

Channel 165

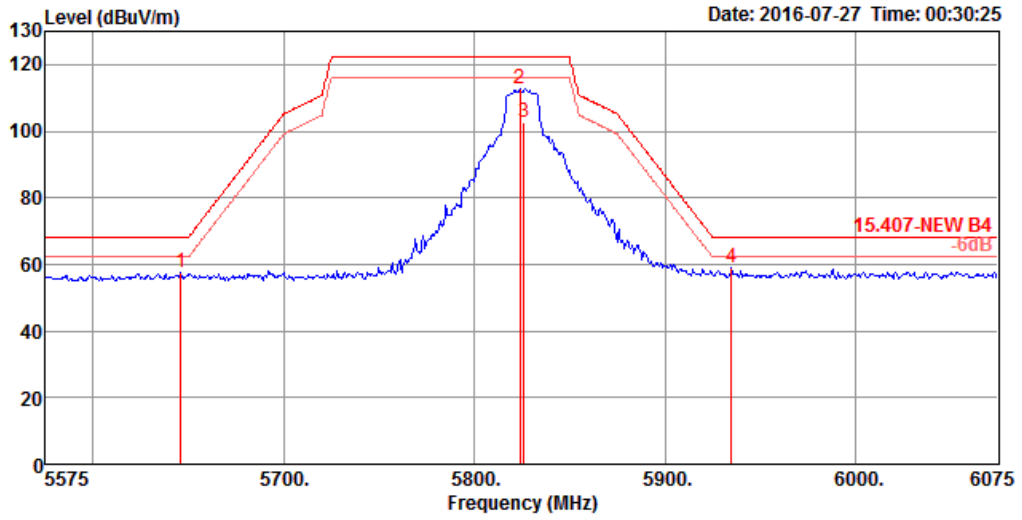

| | Freq | Level | Limit Line | Over Limit | Read Level | CableAntenna Loss | Preamp Factor | A/Pos | T/Pos | Remark | Pol/Phase |
|---|---------|--------|------------|------------|------------|-------------------|---------------|-------|-------|-------------|------------|
| | MHz | dBuV/m | dBuV/m | dB | dBuV | dB | dB/m | dB | cm | deg | |
| 1 | 5646.00 | 57.74 | 68.20 | -10.46 | 51.88 | 6.86 | 31.98 | 32.98 | 100 | 294 Peak | HORIZONTAL |
| 2 | 5824.00 | 112.76 | | | 106.62 | 6.99 | 32.20 | 33.05 | 100 | 294 Peak | HORIZONTAL |
| 3 | 5826.00 | 102.54 | | | 96.40 | 6.99 | 32.20 | 33.05 | 100 | 294 Average | HORIZONTAL |
| 4 | 5935.00 | 59.24 | 68.20 | -8.96 | 52.97 | 7.03 | 32.32 | 33.08 | 100 | 294 Peak | HORIZONTAL |

Item 2, 3 are the fundamental frequency at 5825 MHz.

| | | | |
|----------------------|----------------------|-----------------------|--|
| Temperature | 22.2°C | Humidity | 51% |
| Test Engineer | John Tang, Zero Chen | Configurations | IEEE 802.11n MCS0 HT20 CH 36, 40, 48 / Ant. 1 + Ant. 2 |

Channel 36

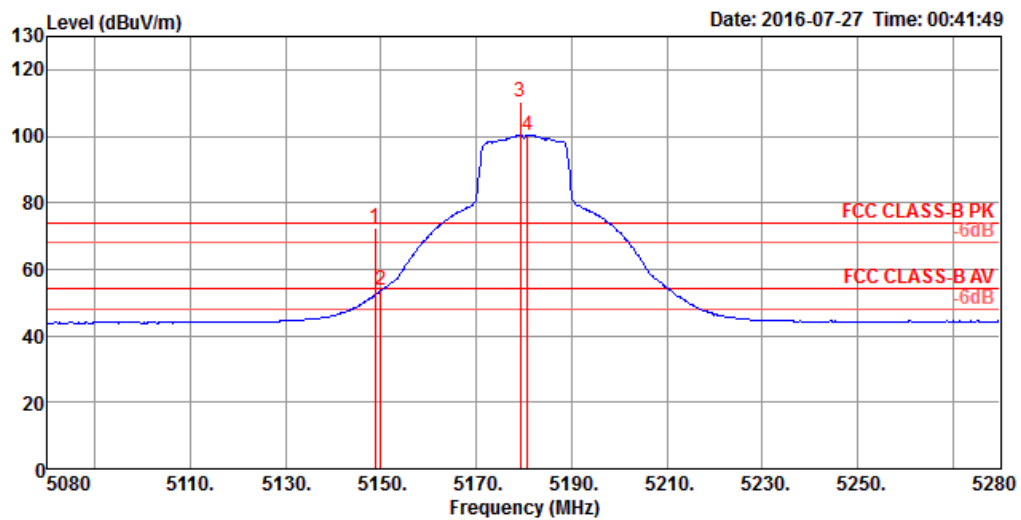

| | Freq | Level | Limit Line | Over Limit | Read Level | CableAntenna Loss | Preamp Factor | A/Pos | T/Pos | Remark | Pol/Phase | |
|-----|---------|--------|------------|------------|------------|-------------------|---------------|-------|-------|--------|-----------|------------|
| | MHz | dBuV/m | dBuV/m | dB | dBuV | dB | dB/m | dB | cm | deg | | |
| 1 | 5148.80 | 72.67 | 74.00 | -1.33 | 67.58 | 6.51 | 31.52 | 32.94 | 107 | 260 | Peak | HORIZONTAL |
| 2 | 5150.00 | 53.60 | 54.00 | -0.40 | 48.51 | 6.51 | 31.52 | 32.94 | 107 | 260 | Average | HORIZONTAL |
| 3 0 | 5179.20 | 110.36 | | | 105.22 | 6.53 | 31.55 | 32.94 | 107 | 260 | Peak | HORIZONTAL |
| 4 0 | 5180.80 | 100.29 | | | 95.15 | 6.53 | 31.55 | 32.94 | 107 | 260 | Average | HORIZONTAL |

Item 3, 4 are the fundamental frequency at 5180 MHz.

Channel 40

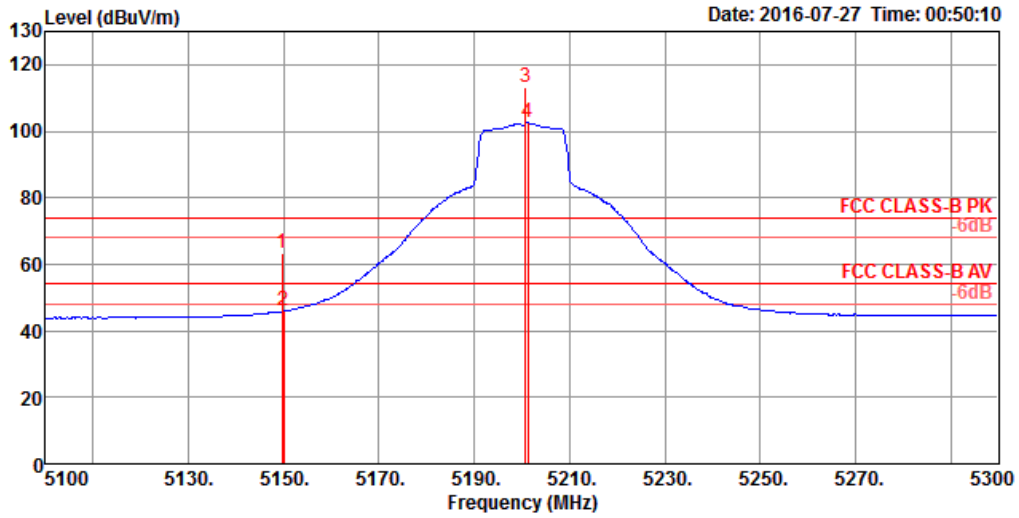

| | Freq | Level | Limit Line | Over Limit | Read Level | CableAntenna Loss | Preamp Factor | A/Pos | T/Pos | Remark | Pol/Phase |
|---|---------|--------|------------|------------|------------|-------------------|---------------|-------|-------|-------------|------------|
| | MHz | dBuV/m | dBuV/m | dB | dBuV | dB | dB/m | dB | cm | deg | |
| 1 | 5149.60 | 63.52 | 74.00 | -10.48 | 58.43 | 6.51 | 31.52 | 32.94 | 100 | 314 Peak | HORIZONTAL |
| 2 | 5150.00 | 45.84 | 54.00 | -8.16 | 40.75 | 6.51 | 31.52 | 32.94 | 100 | 314 Average | HORIZONTAL |
| 3 | 5200.80 | 113.20 | | | 108.04 | 6.54 | 31.56 | 32.94 | 100 | 314 Peak | HORIZONTAL |
| 4 | 5201.20 | 102.44 | | | 97.28 | 6.54 | 31.56 | 32.94 | 100 | 314 Average | HORIZONTAL |

Item 3, 4 are the fundamental frequency at 5200 MHz.

Channel 48

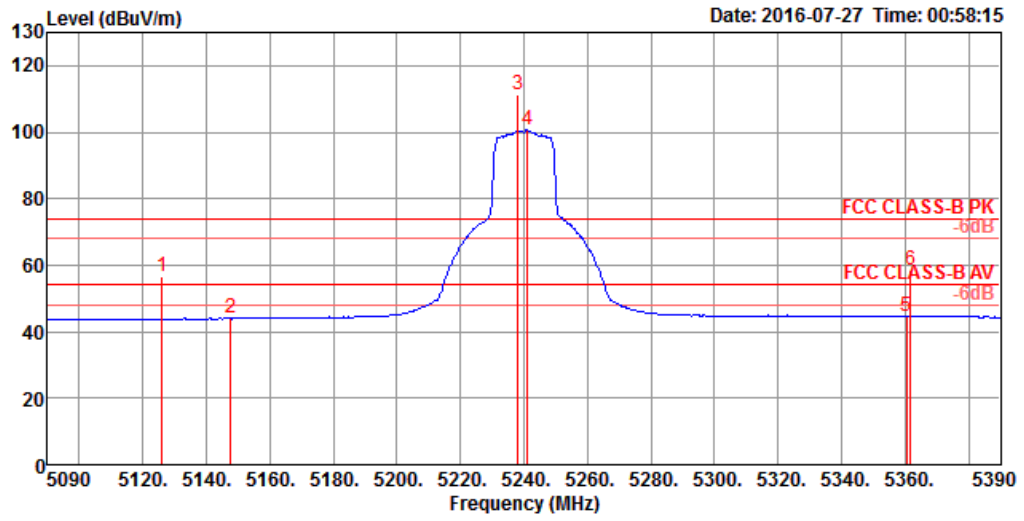

| | Freq | Level | Limit Line | Over Limit | Read Level | CableAntenna Loss | Preamp Factor | A/Pos | T/Pos | Remark | Pol/Phase |
|---|---------|--------|------------|------------|------------|-------------------|---------------|-------|-------|-------------|------------|
| | MHz | dBuV/m | dBuV/m | dB | dBuV | dB | dB/m | dB | cm | deg | |
| 1 | 5126.00 | 56.40 | 74.00 | -17.60 | 51.36 | 6.48 | 31.50 | 32.94 | 102 | 317 Peak | HORIZONTAL |
| 2 | 5147.60 | 43.95 | 54.00 | -10.05 | 38.86 | 6.51 | 31.52 | 32.94 | 102 | 317 Average | HORIZONTAL |
| 3 | 5238.20 | 111.51 | | | 106.29 | 6.57 | 31.59 | 32.94 | 102 | 317 Peak | HORIZONTAL |
| 4 | 5241.20 | 100.61 | | | 95.39 | 6.57 | 31.59 | 32.94 | 102 | 317 Average | HORIZONTAL |
| 5 | 5360.60 | 44.75 | 54.00 | -9.25 | 39.32 | 6.67 | 31.69 | 32.93 | 102 | 317 Average | HORIZONTAL |
| 6 | 5361.80 | 58.38 | 74.00 | -15.62 | 52.95 | 6.67 | 31.69 | 32.93 | 102 | 317 Peak | HORIZONTAL |

Item 3, 4 are the fundamental frequency at 5240 MHz.

| | | | |
|----------------------|----------------------|-----------------------|--|
| Temperature | 22.2°C | Humidity | 51% |
| Test Engineer | John Tang, Zero Chen | Configurations | IEEE 802.11n MCS0 HT20 CH 52, 60, 64 / Ant. 1 + Ant. 2 |

Channel 52

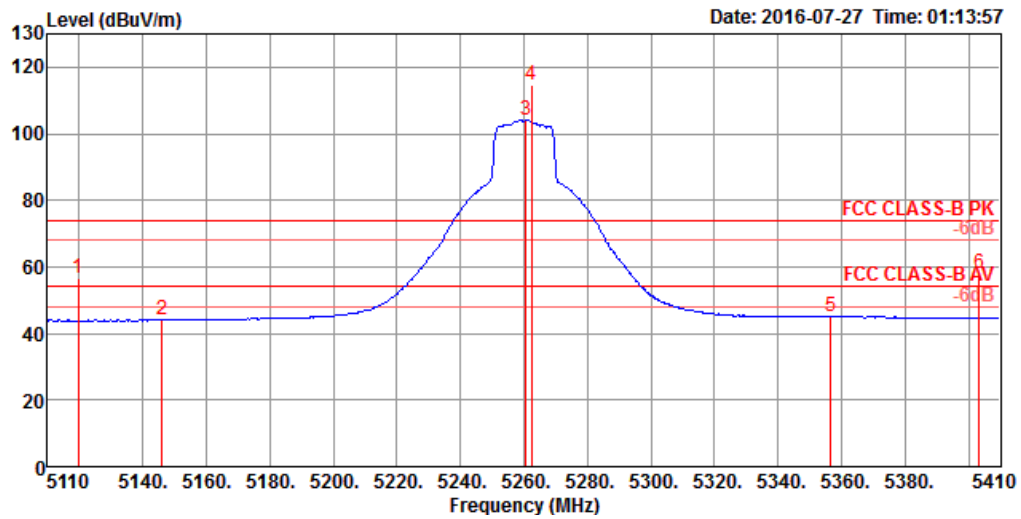

| | Freq | Level | Limit Line | Over Limit | Read Level | CableAntenna Loss | Preamp Factor | Preamp Factor | A/Pos | T/Pos | Remark | Pol/Phase |
|---|---------|--------|------------|------------|------------|-------------------|---------------|---------------|-------|-------|---------|------------|
| | MHz | dBuV/m | dBuV/m | dB | dBuV | dB | dB/m | dB | cm | deg | | |
| 1 | 5119.60 | 56.70 | 74.00 | -17.30 | 51.66 | 6.48 | 31.50 | 32.94 | 100 | 314 | Peak | HORIZONTAL |
| 2 | 5146.00 | 44.10 | 54.00 | -9.90 | 39.01 | 6.51 | 31.52 | 32.94 | 100 | 314 | Average | HORIZONTAL |
| 3 | 5260.60 | 104.26 | | | 98.99 | 6.59 | 31.61 | 32.93 | 100 | 314 | Average | HORIZONTAL |
| 4 | 5262.40 | 114.84 | | | 109.55 | 6.60 | 31.62 | 32.93 | 100 | 314 | Peak | HORIZONTAL |
| 5 | 5356.60 | 45.08 | 54.00 | -8.92 | 39.65 | 6.67 | 31.69 | 32.93 | 100 | 314 | Average | HORIZONTAL |
| 6 | 5403.40 | 58.20 | 74.00 | -15.80 | 52.70 | 6.70 | 31.73 | 32.93 | 100 | 314 | Peak | HORIZONTAL |

Item 3, 4 are the fundamental frequency at 5260 MHz.

Channel 60

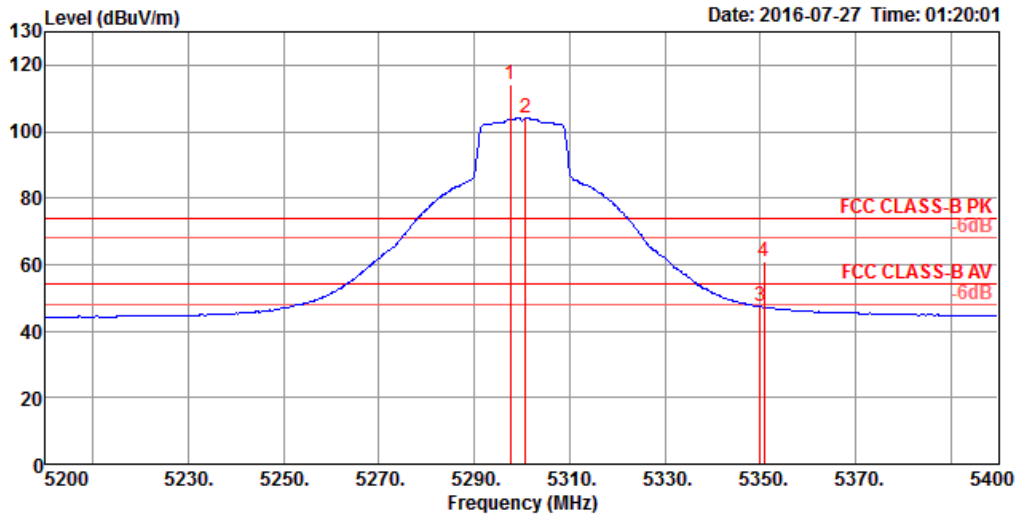

| | Freq | Level | Limit Line | Over Limit | Read Level | CableAntenna Loss | Preamp Factor | A/Pos | T/Pos | Remark | Pol/Phase |
|---|---------|--------|------------|------------|------------|-------------------|---------------|-------|-------|-------------|------------|
| | MHz | dBuV/m | dBuV/m | dB | dBuV | dB | dB/m | dB | cm | deg | |
| 1 | 5297.60 | 114.26 | | | 108.93 | 6.62 | 31.64 | 32.93 | 100 | 315 Peak | HORIZONTAL |
| 2 | 5300.80 | 103.98 | | | 98.65 | 6.62 | 31.64 | 32.93 | 100 | 315 Average | HORIZONTAL |
| 3 | 5350.00 | 47.51 | 54.00 | -6.49 | 42.10 | 6.66 | 31.68 | 32.93 | 100 | 315 Average | HORIZONTAL |
| 4 | 5350.80 | 61.02 | 74.00 | -12.98 | 55.61 | 6.66 | 31.68 | 32.93 | 100 | 315 Peak | HORIZONTAL |

Item 1, 2 are the fundamental frequency at 5300 MHz.

Channel 64

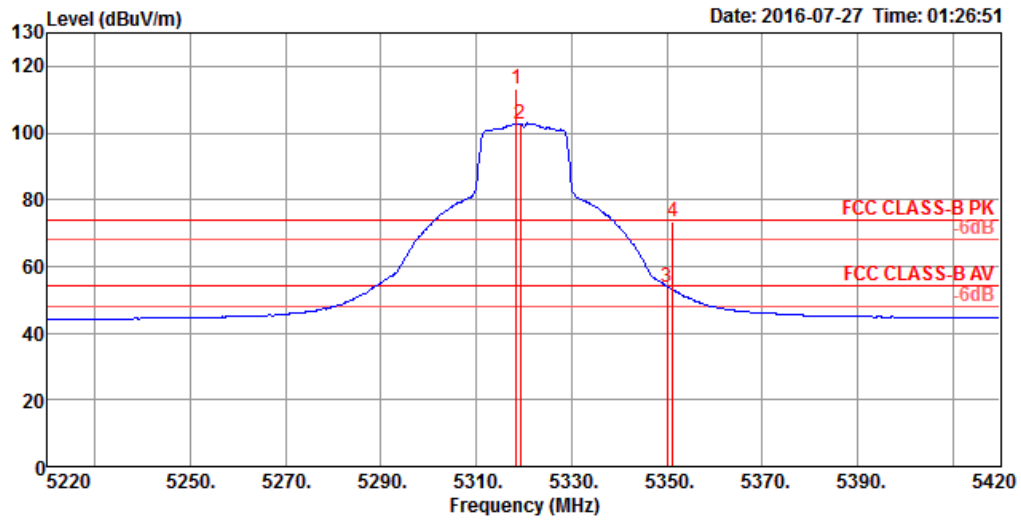

| | | Limit | Over | Read | CableAntenna | Preamp | A/Pos | T/Pos | | | | | |
|---|------|---------|--------|-------|--------------|--------|--------|-------|--------|-----------|---------|------------|------------|
| | Freq | Line | Limit | Level | Loss | Factor | Factor | | Remark | Pol/Phase | | | |
| | MHz | dBuV/m | dBuV/m | dB | dBuV | dB | dB/m | dB | cm | deg | | | |
| 1 | 0 | 5318.40 | 113.31 | | 107.96 | 6.63 | 31.65 | 32.93 | 103 | 313 | Peak | HORIZONTAL | |
| 2 | 0 | 5319.20 | 102.88 | | 97.53 | 6.63 | 31.65 | 32.93 | 103 | 313 | Average | HORIZONTAL | |
| 3 | | 5350.00 | 53.94 | 54.00 | -0.06 | 48.53 | 6.66 | 31.68 | 32.93 | 103 | 313 | Average | HORIZONTAL |
| 4 | | 5351.20 | 73.48 | 74.00 | -0.52 | 68.07 | 6.66 | 31.68 | 32.93 | 103 | 313 | Peak | HORIZONTAL |

Item 1, 2 are the fundamental frequency at 5320 MHz.

| | | | |
|----------------------|----------------------|-----------------------|---|
| Temperature | 22.2°C | Humidity | 51% |
| Test Engineer | John Tang, Zero Chen | Configurations | IEEE 802.11n MCS0 HT20 CH 100, 116, 140 / Ant. 1 + Ant. 2 |

Channel 100

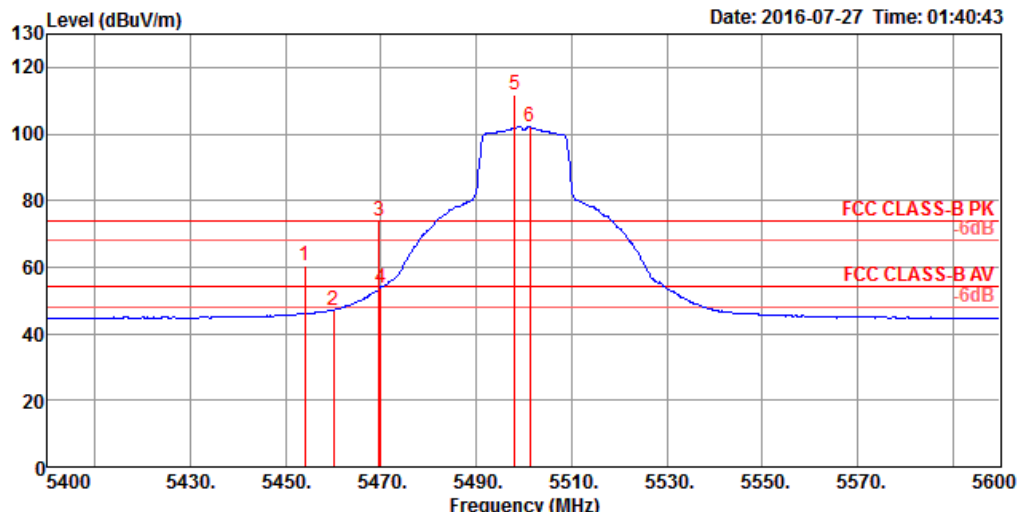

| | Freq | Level | Limit Line | Over Limit | Read Level | Cable Loss | Antenna Factor | Preamp Factor | A/Pos | T/Pos | Remark | Pol/Phase |
|---|---------|--------|------------|------------|------------|------------|----------------|---------------|-------|-------|---------|------------|
| | MHz | dBuV/m | dBuV/m | dB | dBuV | dB | dB/m | dB | cm | deg | | |
| 1 | 5454.00 | 60.50 | 74.00 | -13.50 | 54.93 | 6.73 | 31.76 | 32.92 | 103 | 317 | Peak | HORIZONTAL |
| 2 | 5460.00 | 47.13 | 54.00 | -6.87 | 41.56 | 6.73 | 31.76 | 32.92 | 103 | 317 | Average | HORIZONTAL |
| 3 | 5469.60 | 73.66 | 74.00 | -0.34 | 68.06 | 6.74 | 31.78 | 32.92 | 103 | 317 | Peak | HORIZONTAL |
| 4 | 5470.00 | 53.94 | 54.00 | -0.06 | 48.34 | 6.74 | 31.78 | 32.92 | 103 | 317 | Average | HORIZONTAL |
| 5 | 5498.00 | 111.96 | | | 06.32 | 6.76 | 31.80 | 32.92 | 103 | 317 | Peak | HORIZONTAL |
| 6 | 5501.20 | 102.14 | | | 96.50 | 6.76 | 31.80 | 32.92 | 103 | 317 | Average | HORIZONTAL |

Item 5, 6 are the fundamental frequency at 5500 MHz.

Channel 116

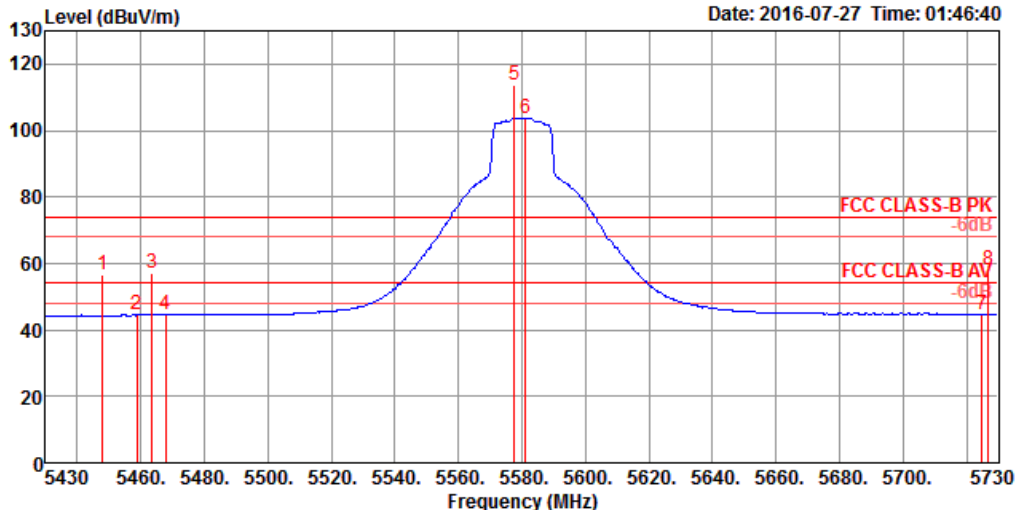

| | Freq | Level | Limit Line | Over Limit | Read Level | CableAntenna Loss | Preamp Factor | A/Pos | T/Pos | Remark | Pol/Phase |
|---|---------|--------|------------|------------|------------|-------------------|---------------|-------|-------|-------------|------------|
| | MHz | dBuV/m | dBuV/m | dB | dBuV | dB | dB/m | dB | cm | deg | |
| 1 | 5448.00 | 56.84 | 74.00 | -17.16 | 51.27 | 6.73 | 31.76 | 32.92 | 101 | 315 Peak | HORIZONTAL |
| 2 | 5458.80 | 44.44 | 54.00 | -9.56 | 38.87 | 6.73 | 31.76 | 32.92 | 101 | 315 Average | HORIZONTAL |
| 3 | 5463.60 | 57.08 | 74.00 | -16.92 | 51.48 | 6.74 | 31.78 | 32.92 | 101 | 315 Peak | HORIZONTAL |
| 4 | 5467.80 | 44.69 | 54.00 | -9.31 | 39.09 | 6.74 | 31.78 | 32.92 | 101 | 315 Average | HORIZONTAL |
| 5 | 5577.60 | 113.54 | | | 107.78 | 6.81 | 31.90 | 32.95 | 101 | 315 Peak | HORIZONTAL |
| 6 | 5581.20 | 103.84 | | | 98.09 | 6.81 | 31.90 | 32.96 | 101 | 315 Average | HORIZONTAL |
| 7 | 5725.00 | 44.74 | 54.00 | -9.26 | 38.73 | 6.93 | 32.08 | 33.00 | 101 | 315 Average | HORIZONTAL |
| 8 | 5727.00 | 57.92 | 74.00 | -16.08 | 51.92 | 6.93 | 32.08 | 33.01 | 101 | 315 Peak | HORIZONTAL |

Item 5, 6 are the fundamental frequency at 5580 MHz.

Channel 140

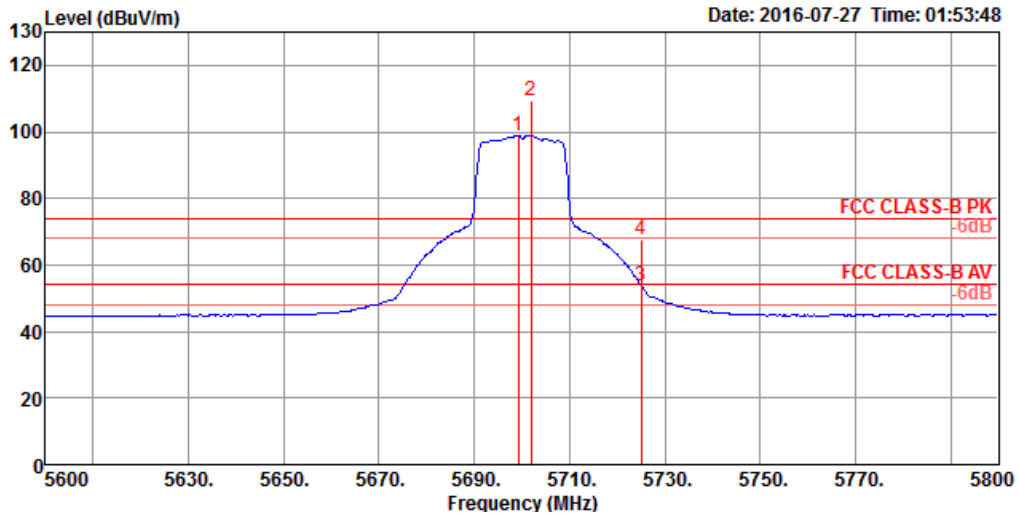

| | Freq | Level | Limit Line | Over Limit | Read Level | CableAntenna Loss | Preamp Factor | A/Pos | T/Pos | Remark | Pol/Phase |
|-----|---------|--------|------------|------------|------------|-------------------|---------------|-------|-------|-------------|------------|
| | MHz | dBuV/m | dBuV/m | dB | dBuV | dB | dB/m | dB | cm | deg | |
| 1 0 | 5699.20 | 98.93 | | | 92.99 | 6.90 | 32.04 | 33.00 | 103 | 313 Average | HORIZONTAL |
| 2 0 | 5702.00 | 109.39 | | | 103.45 | 6.90 | 32.04 | 33.00 | 103 | 313 Peak | HORIZONTAL |
| 3 | 5725.00 | 53.54 | 54.00 | -0.46 | 47.53 | 6.93 | 32.08 | 33.00 | 103 | 313 Average | HORIZONTAL |
| 4 | 5725.00 | 67.52 | 74.00 | -6.48 | 61.51 | 6.93 | 32.08 | 33.00 | 103 | 313 Peak | HORIZONTAL |

Item 1, 2 are the fundamental frequency at 5700 MHz.

| | | | |
|----------------------|----------------------|-----------------------|---|
| Temperature | 22.2°C | Humidity | 51% |
| Test Engineer | John Tang, Zero Chen | Configurations | IEEE 802.11n MCS0 HT20 CH 149, 157, 165 / Ant. 1 + Ant. 2 |

Channel 149

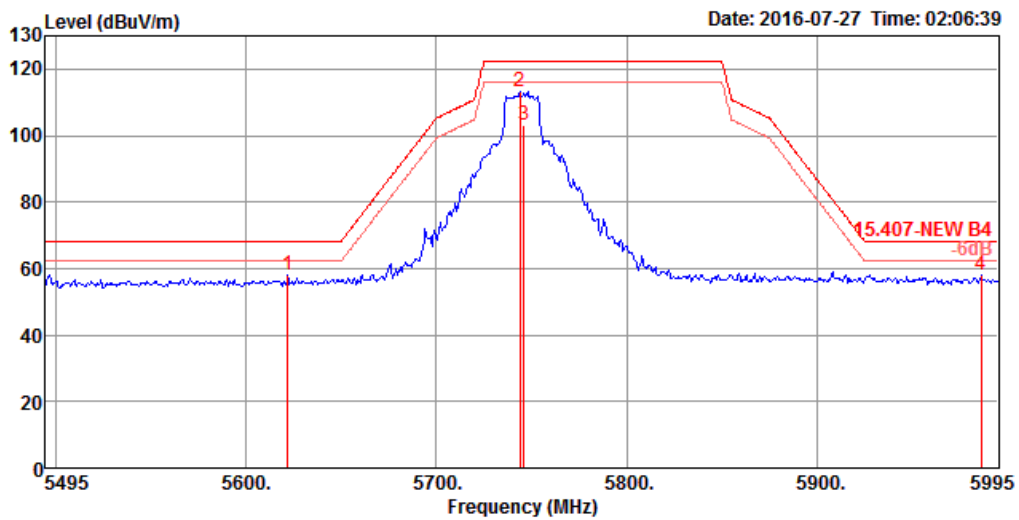

| | Freq | Level | Limit Line | Over Limit | Read Level | CableAntenna Loss | Preamp Factor | A/Pos | T/Pos | Remark | Pol/Phase |
|---|---------|--------|------------|------------|------------|-------------------|---------------|-------|-------|-------------|------------|
| | MHz | dBuV/m | dBuV/m | dB | dBuV | dB | dB/m | dB | cm | deg | |
| 1 | 5622.00 | 58.02 | 68.20 | -10.18 | 52.22 | 6.83 | 31.94 | 32.97 | 102 | 315 Peak | HORIZONTAL |
| 2 | 5744.00 | 113.13 | | | 107.10 | 6.94 | 32.10 | 33.01 | 102 | 315 Peak | HORIZONTAL |
| 3 | 5746.00 | 103.00 | | | 96.98 | 6.94 | 32.10 | 33.02 | 102 | 315 Average | HORIZONTAL |
| 4 | 5986.00 | 57.94 | 68.20 | -10.26 | 51.62 | 7.04 | 32.38 | 33.10 | 102 | 315 Peak | HORIZONTAL |

Item 2, 3 are the fundamental frequency at 5745 MHz.

Channel 157

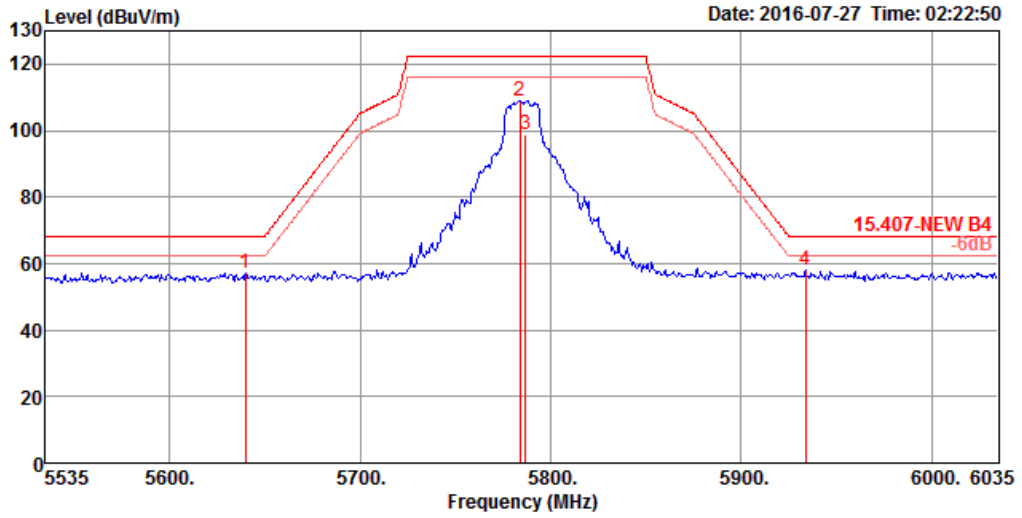

| | Freq | Level | Limit Line | Over Limit | Read Level | CableAntenna Loss | Preamp Factor | A/Pos | T/Pos | Remark | Pol/Phase |
|---|---------|--------|------------|------------|------------|-------------------|---------------|-------|-------|-----------|-----------|
| | MHz | dBuV/m | dBuV/m | dB | dBuV | dB | dB/m | dB | cm | deg | |
| 1 | 5640.00 | 57.27 | 68.20 | -10.93 | 51.44 | 6.85 | 31.96 | 32.98 | 111 | 2 Peak | VERTICAL |
| 2 | 5784.00 | 109.04 | | | 102.96 | 6.97 | 32.14 | 33.03 | 111 | 2 Peak | VERTICAL |
| 3 | 5787.00 | 98.93 | | | 92.85 | 6.97 | 32.14 | 33.03 | 111 | 2 Average | VERTICAL |
| 4 | 5934.00 | 58.06 | 68.20 | -10.14 | 51.79 | 7.03 | 32.32 | 33.08 | 111 | 2 Peak | VERTICAL |

Item 2, 3 are the fundamental frequency at 5785 MHz.

Channel 165

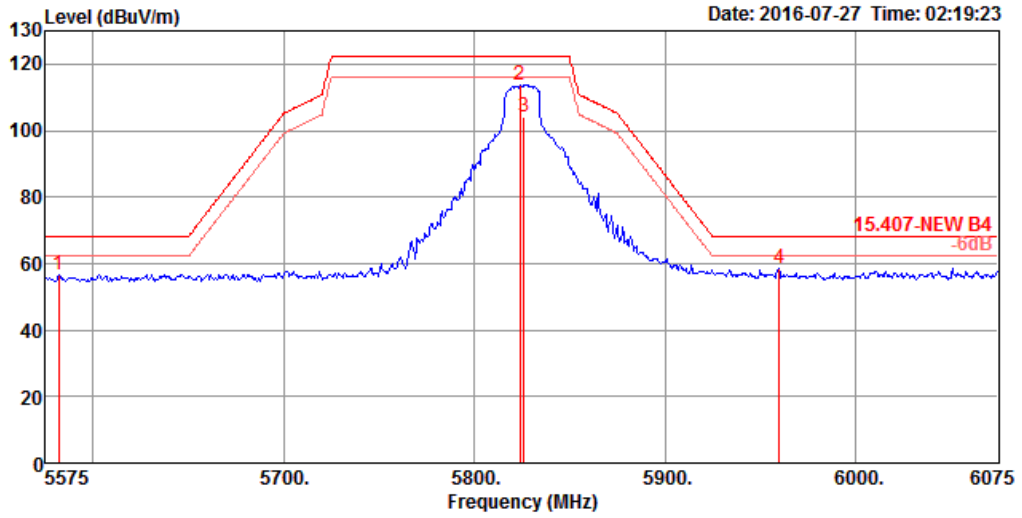

| | Freq | Level | Limit Line | Over Limit | Read Level | CableAntenna Loss | Preamp Factor | A/Pos | T/Pos | Remark | Pol/Phase |
|---|---------|--------|------------|------------|------------|-------------------|---------------|-------|-------|-------------|------------|
| | MHz | dBuV/m | dBuV/m | dB | dBuV | dB | dB/m | dB | cm | deg | |
| 1 | 5582.00 | 56.68 | 68.20 | -11.52 | 50.93 | 6.81 | 31.90 | 32.96 | 103 | 312 Peak | HORIZONTAL |
| 2 | 5824.00 | 113.81 | | | 107.67 | 6.99 | 32.20 | 33.05 | 103 | 312 Peak | HORIZONTAL |
| 3 | 5826.00 | 104.18 | | | 98.04 | 6.99 | 32.20 | 33.05 | 103 | 312 Average | HORIZONTAL |
| 4 | 5960.00 | 58.71 | 68.20 | -9.49 | 52.41 | 7.04 | 32.36 | 33.10 | 103 | 312 Peak | HORIZONTAL |

Item 2, 3 are the fundamental frequency at 5825 MHz.

| | | | |
|----------------------|----------------------|-----------------------|--|
| Temperature | 22.2°C | Humidity | 51% |
| Test Engineer | John Tang, Zero Chen | Configurations | IEEE 802.11n MCS0 HT40 CH 38, 46 / Ant. 1 + Ant. 2 |

Channel 38

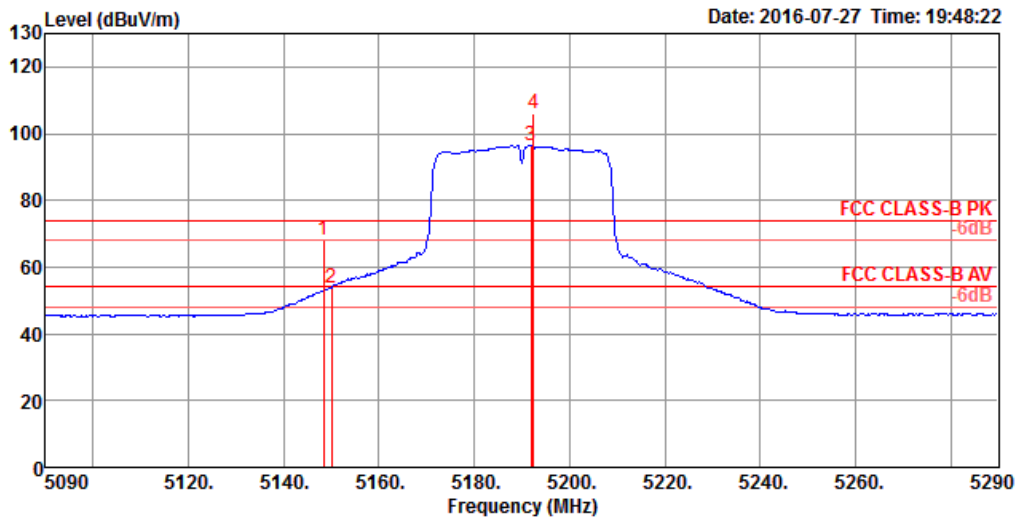

| | Freq | Level | Limit Line | Over Limit | Read Level | CableAntenna Loss | Preamp Factor | A/Pos | T/Pos | Remark | Pol/Phase |
|---|---------|--------|------------|------------|------------|-------------------|---------------|-------|-------|-------------|------------|
| | MHz | dBuV/m | dBuV/m | dB | dBuV | dB | dB/m | dB | cm | deg | |
| 1 | 5148.40 | 67.93 | 74.00 | -6.07 | 62.84 | 6.51 | 31.52 | 32.94 | 105 | 254 Peak | HORIZONTAL |
| 2 | 5150.00 | 53.71 | 54.00 | -0.29 | 48.62 | 6.51 | 31.52 | 32.94 | 105 | 254 Average | HORIZONTAL |
| 3 | 5192.00 | 96.32 | | | 91.16 | 6.54 | 31.56 | 32.94 | 105 | 254 Average | HORIZONTAL |
| 4 | 5192.40 | 105.90 | | | 100.74 | 6.54 | 31.56 | 32.94 | 105 | 254 Peak | HORIZONTAL |

Item 3, 4 are the fundamental frequency at 5190 MHz.

Channel 46

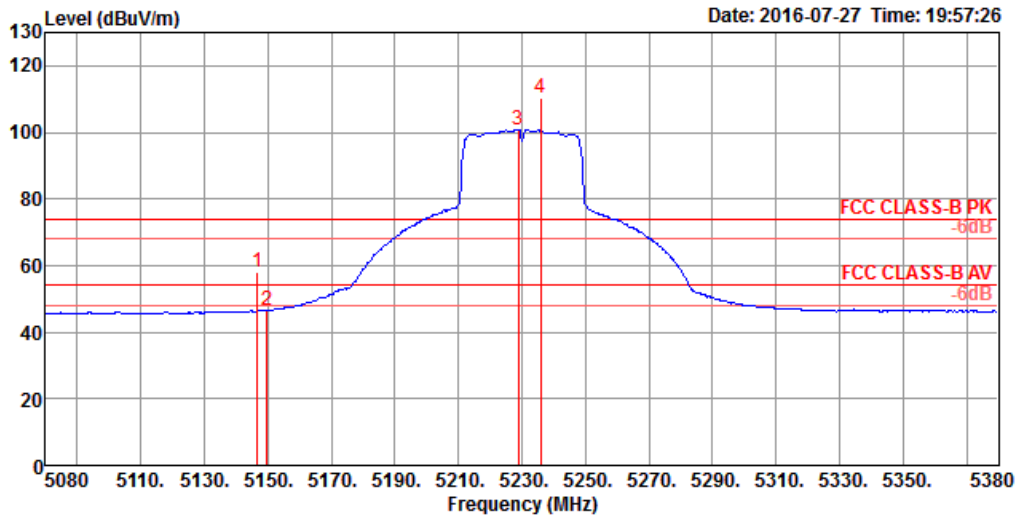

| | Freq | Level | Limit Line | Over Limit | Read Level | CableAntenna Loss | Preamp Factor | A/Pos | T/Pos | Remark | Pol/Phase | |
|---|---------|--------|------------|------------|------------|-------------------|---------------|-------|-------|--------|-----------|------------|
| | MHz | dBuV/m | dBuV/m | dB | dBuV | dB | dB/m | dB | cm | deg | | |
| 1 | 5146.60 | 57.86 | 74.00 | -16.14 | 52.77 | 6.51 | 31.52 | 32.94 | 102 | 313 | Peak | HORIZONTAL |
| 2 | 5149.60 | 46.67 | 54.00 | -7.33 | 41.58 | 6.51 | 31.52 | 32.94 | 102 | 313 | Average | HORIZONTAL |
| 3 | 5228.80 | 100.62 | | | 95.42 | 6.56 | 31.58 | 32.94 | 102 | 313 | Average | HORIZONTAL |
| 4 | 5236.00 | 110.36 | | | 105.14 | 6.57 | 31.59 | 32.94 | 102 | 313 | Peak | HORIZONTAL |

Item 3, 4 are the fundamental frequency at 5230 MHz.

| | | | |
|----------------------|----------------------|-----------------------|--|
| Temperature | 22.2°C | Humidity | 51% |
| Test Engineer | John Tang, Zero Chen | Configurations | IEEE 802.11n MCS0 HT40 CH 54, 62 / Ant. 1 + Ant. 2 |

Channel 54

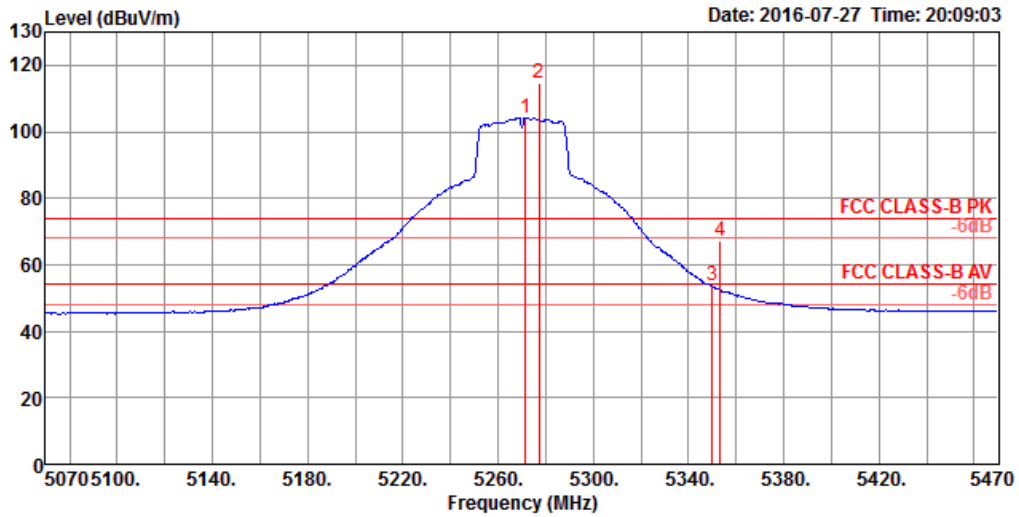

| | Freq | Level | Limit Line | Over Limit | Read Level | Cable Loss | Antenna Factor | Preamp Factor | A/Pos | T/Pos | Remark | Pol/Phase |
|---|---------|--------|------------|------------|------------|------------|----------------|---------------|-------|-------|---------|------------|
| | MHz | dBuV/m | dBuV/m | dB | dBuV | dB | dB/m | dB | cm | deg | | |
| 1 | 5271.60 | 104.26 | | | 98.97 | 6.60 | 31.62 | 32.93 | 100 | 314 | Average | HORIZONTAL |
| 2 | 5277.20 | 114.47 | | | 109.18 | 6.60 | 31.62 | 32.93 | 100 | 314 | Peak | HORIZONTAL |
| 3 | 5350.00 | 53.60 | 54.00 | -0.40 | 48.19 | 6.66 | 31.68 | 32.93 | 100 | 314 | Average | HORIZONTAL |
| 4 | 5353.20 | 67.18 | 74.00 | -6.82 | 61.77 | 6.66 | 31.68 | 32.93 | 100 | 314 | Peak | HORIZONTAL |

Item 1, 2 are the fundamental frequency at 5270 MHz.

Channel 62

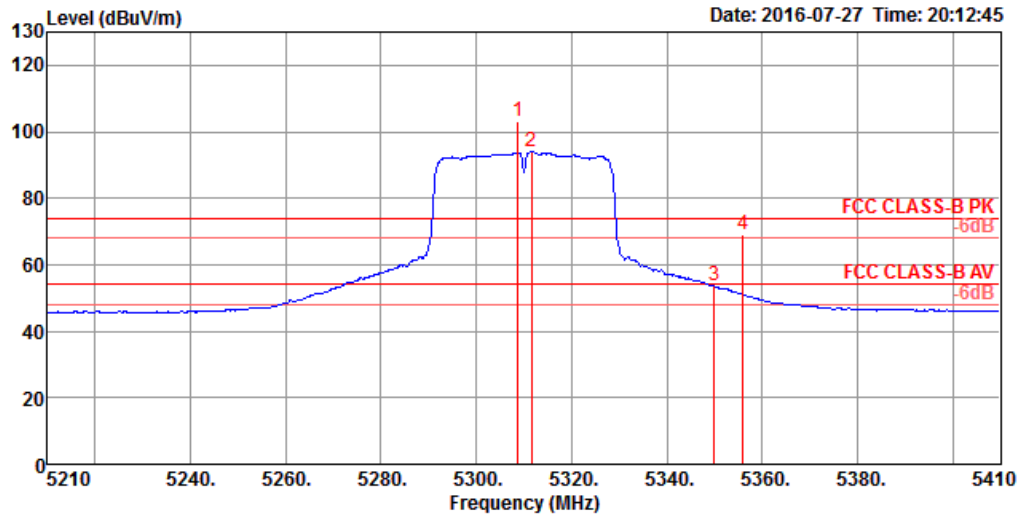

| | Freq | Level | Limit Line | Over Limit | Read Level | CableAntenna Loss | Preamp Factor | A/Pos | T/Pos | Remark | Pol/Phase | |
|---|---------|--------|------------|------------|------------|-------------------|---------------|-------|-------|--------|-----------|------------|
| | MHz | dBuV/m | dBuV/m | dB | dBuV | dB | dB/m | dB | cm | deg | | |
| 1 | 5308.80 | 103.23 | | | 97.88 | 6.63 | 31.65 | 32.93 | 101 | 316 | Peak | HORIZONTAL |
| 2 | 5311.60 | 93.93 | | | 88.58 | 6.63 | 31.65 | 32.93 | 101 | 316 | Average | HORIZONTAL |
| 3 | 5350.00 | 53.56 | 54.00 | -0.44 | 48.15 | 6.66 | 31.68 | 32.93 | 101 | 316 | Average | HORIZONTAL |
| 4 | 5356.00 | 69.15 | 74.00 | -4.85 | 63.72 | 6.67 | 31.69 | 32.93 | 101 | 316 | Peak | HORIZONTAL |

Item 1, 2 are the fundamental frequency at 5310 MHz.

| | | | |
|----------------------|----------------------|-----------------------|---|
| Temperature | 22.2°C | Humidity | 51% |
| Test Engineer | John Tang, Zero Chen | Configurations | IEEE 802.11n MCS0 HT40 CH 102, 110, 134 / Ant. 1 + Ant. 2 |

Channel 102

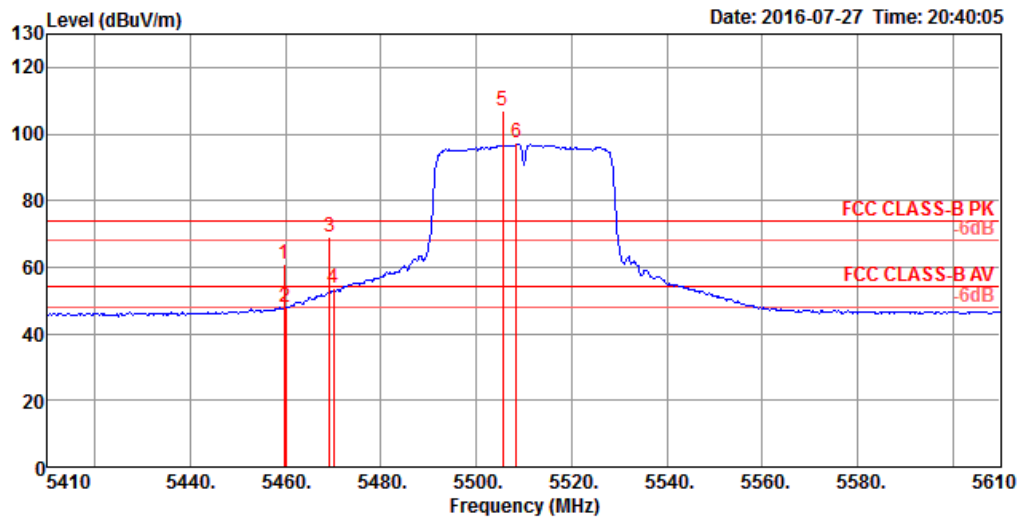

| | Freq | Level | Limit Line | Over Limit | Read Level | CableAntenna Loss | Preamp Factor | A/Pos | T/Pos | Remark | Pol/Phase |
|---|---------|--------|------------|------------|------------|-------------------|---------------|-------|-------|-------------|------------|
| | MHz | dBuV/m | dBuV/m | dB | dBuV | dB | dB/m | dB | cm | deg | |
| 1 | 5459.60 | 60.90 | 74.00 | -13.10 | 55.33 | 6.73 | 31.76 | 32.92 | 100 | 317 Peak | HORIZONTAL |
| 2 | 5460.00 | 48.11 | 54.00 | -5.89 | 42.54 | 6.73 | 31.76 | 32.92 | 100 | 317 Average | HORIZONTAL |
| 3 | 5469.20 | 68.86 | 74.00 | -5.14 | 63.26 | 6.74 | 31.78 | 32.92 | 100 | 317 Peak | HORIZONTAL |
| 4 | 5470.00 | 53.52 | 54.00 | -0.48 | 47.92 | 6.74 | 31.78 | 32.92 | 100 | 317 Average | HORIZONTAL |
| 5 | 5505.60 | 107.13 | | | 101.50 | 6.76 | 31.80 | 32.93 | 100 | 317 Peak | HORIZONTAL |
| 6 | 5508.40 | 97.40 | | | 91.77 | 6.76 | 31.80 | 32.93 | 100 | 317 Average | HORIZONTAL |

Item 5, 6 are the fundamental frequency at 5510 MHz.

Channel 110

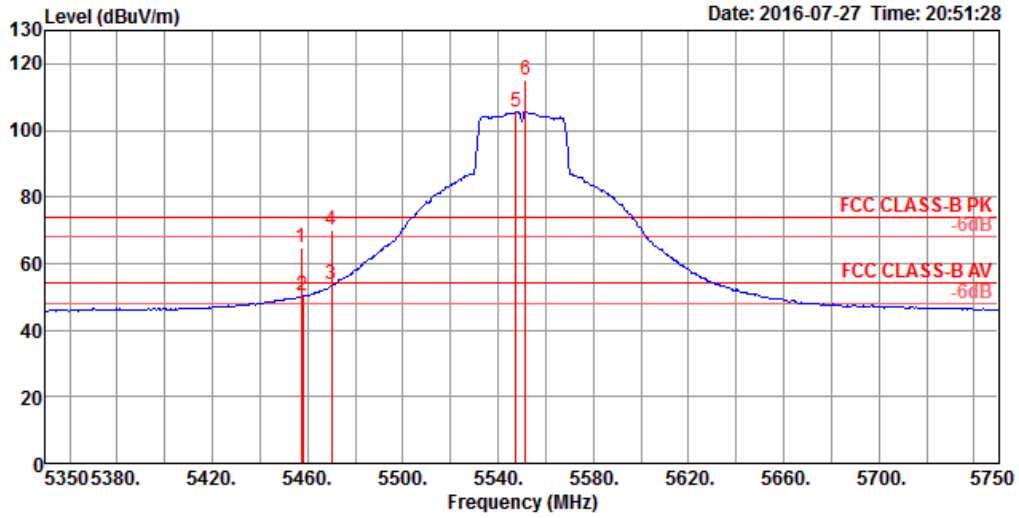

| | Freq | Level | Limit Line | Over Limit | Read Level | CableAntenna Loss | Preamp Factor | A/Pos | T/Pos | Remark | Pol/Phase |
|---|---------|--------|------------|------------|------------|-------------------|---------------|-------|-------|-------------|------------|
| | MHz | dBuV/m | dBuV/m | dB | dBuV | dB | dB/m | dB | cm | deg | |
| 1 | 5457.20 | 64.93 | 74.00 | -9.07 | 59.36 | 6.73 | 31.76 | 32.92 | 100 | 315 Peak | HORIZONTAL |
| 2 | 5458.00 | 50.35 | 54.00 | -3.65 | 44.78 | 6.73 | 31.76 | 32.92 | 100 | 315 Average | HORIZONTAL |
| 3 | 5470.00 | 53.52 | 54.00 | -0.48 | 47.92 | 6.74 | 31.78 | 32.92 | 100 | 315 Average | HORIZONTAL |
| 4 | 5470.00 | 70.21 | 74.00 | -3.79 | 64.61 | 6.74 | 31.78 | 32.92 | 100 | 315 Peak | HORIZONTAL |
| 5 | 5547.60 | 105.42 | | | 99.71 | 6.79 | 31.86 | 32.94 | 100 | 315 Average | HORIZONTAL |
| 6 | 5551.60 | 115.19 | | | 109.48 | 6.79 | 31.86 | 32.94 | 100 | 315 Peak | HORIZONTAL |

Item 5, 6 are the fundamental frequency at 5550 MHz.

Channel 134

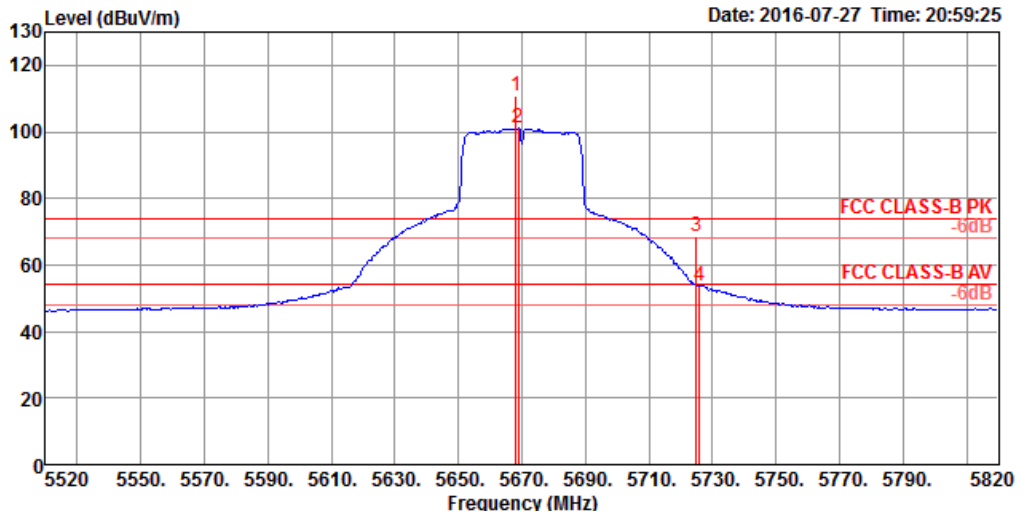

| | Freq | Level | Limit Line | Over Limit | Read Level | CableAntenna Loss | Preamp Factor | A/Pos | T/Pos | Remark | Pol/Phase |
|-----|---------|--------|------------|------------|------------|-------------------|---------------|-------|-------|-------------|------------|
| | MHz | dBuV/m | dBuV/m | dB | dBuV | dB | dB/m | dB | cm | deg | |
| 1 0 | 5668.20 | 110.81 | | | 104.92 | 6.87 | 32.00 | 32.98 | 100 | 313 Peak | HORIZONTAL |
| 2 0 | 5668.80 | 101.03 | | | 95.14 | 6.87 | 32.00 | 32.98 | 100 | 313 Average | HORIZONTAL |
| 3 | 5725.00 | 68.70 | 74.00 | -5.30 | 62.69 | 6.93 | 32.08 | 33.00 | 100 | 313 Peak | HORIZONTAL |
| 4 | 5725.80 | 53.87 | 54.00 | -0.13 | 47.86 | 6.93 | 32.08 | 33.00 | 100 | 313 Average | HORIZONTAL |

Item 1, 2 are the fundamental frequency at 5670 MHz.

| | | | |
|----------------------|----------------------|-----------------------|--|
| Temperature | 22.2°C | Humidity | 51% |
| Test Engineer | John Tang, Zero Chen | Configurations | IEEE 802.11n MCS0 HT40 CH 151, 159 / Ant. 1 + Ant. 2 |

Channel 151

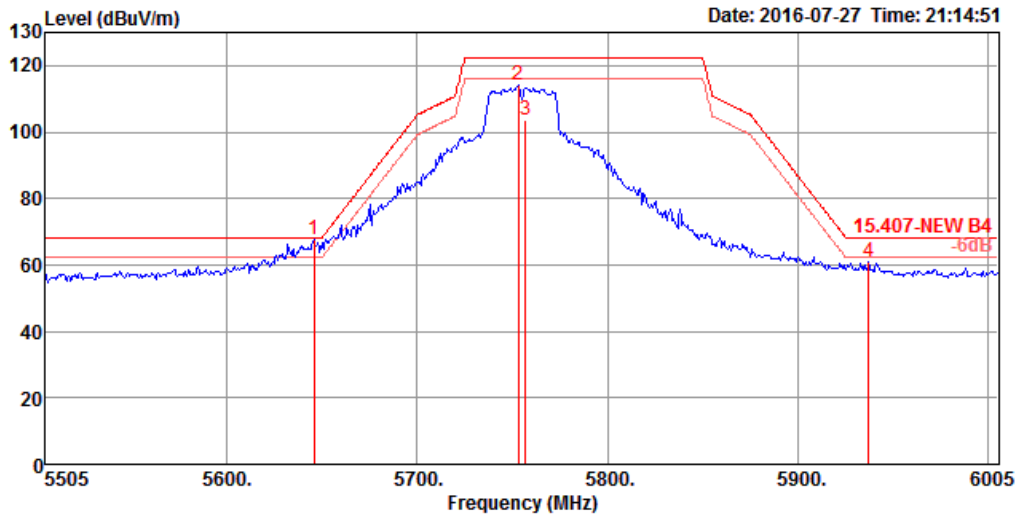

| | Freq | Level | Limit Line | Over Limit | Read Level | CableAntenna Loss | Preamp Factor | A/Pos | T/Pos | Remark | Pol/Phase |
|---|---------|--------|------------|------------|------------|-------------------|---------------|-------|-------|-------------|------------|
| | MHz | dBuV/m | dBuV/m | dB | dBuV | dB | dB/m | dB | cm | deg | |
| 1 | 5646.00 | 67.85 | 68.20 | -0.35 | 61.99 | 6.86 | 31.98 | 32.98 | 102 | 313 Peak | HORIZONTAL |
| 2 | 5753.00 | 114.29 | | | 108.27 | 6.94 | 32.10 | 33.02 | 102 | 313 Peak | HORIZONTAL |
| 3 | 5757.00 | 103.55 | | | 97.50 | 6.95 | 32.12 | 33.02 | 102 | 313 Average | HORIZONTAL |
| 4 | 5937.00 | 61.06 | 68.20 | -7.14 | 54.80 | 7.03 | 32.32 | 33.09 | 102 | 313 Peak | HORIZONTAL |

Item 2, 3 are the fundamental frequency at 5755 MHz.

Channel 159

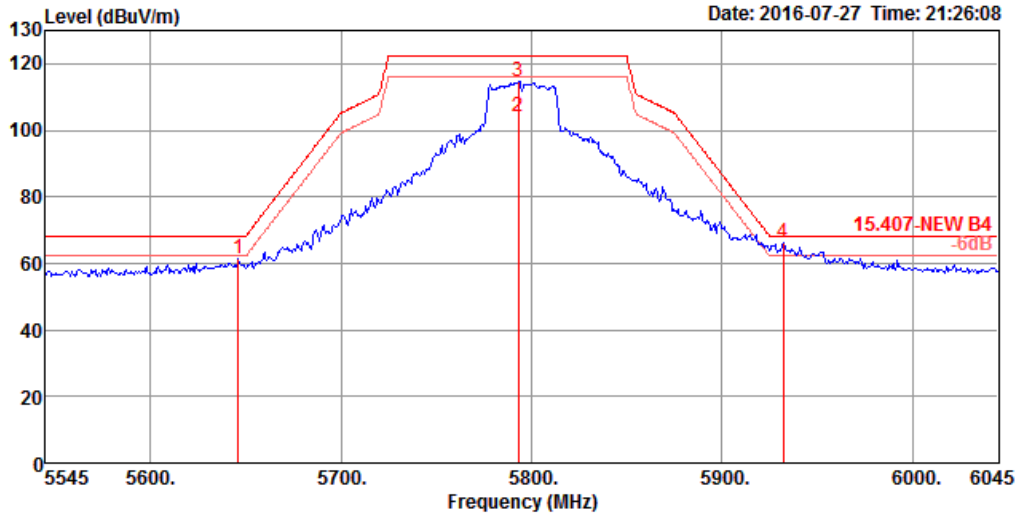

| | Freq | Level | Limit Line | Over Limit | Read Level | CableAntenna Loss | Preamp Factor | A/Pos | T/Pos | Remark | Pol/Phase |
|---|---------|--------|------------|------------|------------|-------------------|---------------|-------|-------|-------------|------------|
| | MHz | dBuV/m | dBuV/m | dB | dBuV | dB | dB/m | dB | cm | deg | |
| 1 | 5646.00 | 61.19 | 68.20 | -7.01 | 55.33 | 6.86 | 31.98 | 32.98 | 100 | 312 Peak | HORIZONTAL |
| 2 | 5793.00 | 104.13 | | | 98.02 | 6.98 | 32.16 | 33.03 | 100 | 312 Average | HORIZONTAL |
| 3 | 5793.00 | 114.85 | | | 108.74 | 6.98 | 32.16 | 33.03 | 100 | 312 Peak | HORIZONTAL |
| 4 | 5932.00 | 66.32 | 68.20 | -1.88 | 60.05 | 7.03 | 32.32 | 33.08 | 100 | 312 Peak | HORIZONTAL |

Item 2, 3 are the fundamental frequency at 5795 MHz.

Straddle Channel

| | | | |
|----------------------|----------------------|-----------------------|---------------------------------------|
| Temperature | 22.2°C | Humidity | 51% |
| Test Engineer | John Tang, Zero Chen | Configurations | IEEE 802.11a CH 144 / Ant. 1 + Ant. 2 |

Channel 144 (UNII 2C)

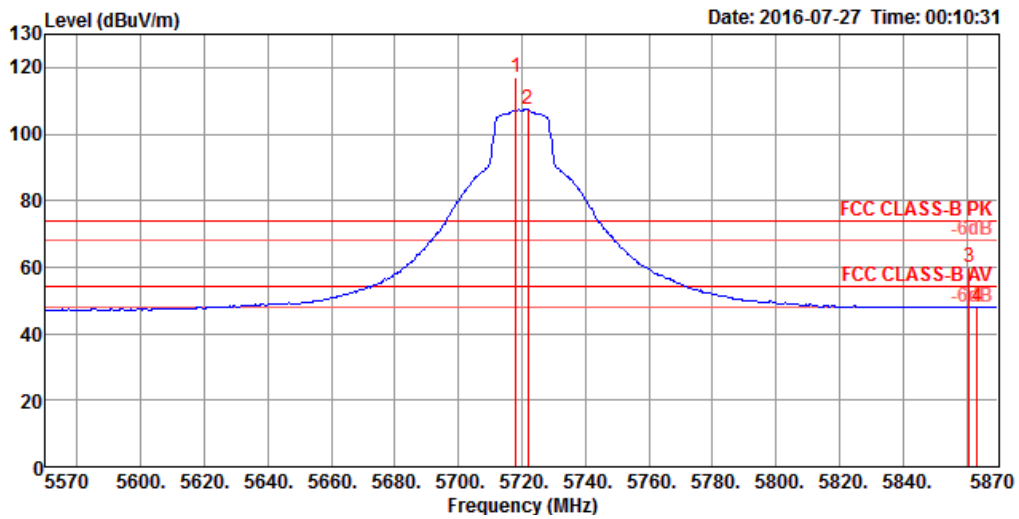

| | Freq | Level | Limit Line | Over Limit | Read Level | Cable Loss | Antenna Factor | Preamp Factor | A/Pos | T/Pos | Remark | Pol/Phase |
|---|---------|--------|------------|------------|------------|------------|----------------|---------------|-------|-------|---------|------------|
| | MHz | dBuV/m | dBuV/m | dB | dBuV | dB | dB/m | dB | cm | deg | | |
| 1 | 5718.20 | 116.96 | | | 110.99 | 6.91 | 32.06 | 33.00 | 100 | 313 | Peak | HORIZONTAL |
| 2 | 5721.80 | 107.32 | | | 101.35 | 6.91 | 32.06 | 33.00 | 100 | 313 | Average | HORIZONTAL |
| 3 | 5861.00 | 60.09 | 74.00 | -13.91 | 53.91 | 7.00 | 32.24 | 33.06 | 100 | 313 | Peak | HORIZONTAL |
| 4 | 5863.40 | 48.15 | 54.00 | -5.85 | 41.97 | 7.00 | 32.24 | 33.06 | 100 | 313 | Average | HORIZONTAL |

Item 1, 2 are the fundamental frequency at 5720 MHz.

Channel 144 (UNII 3)

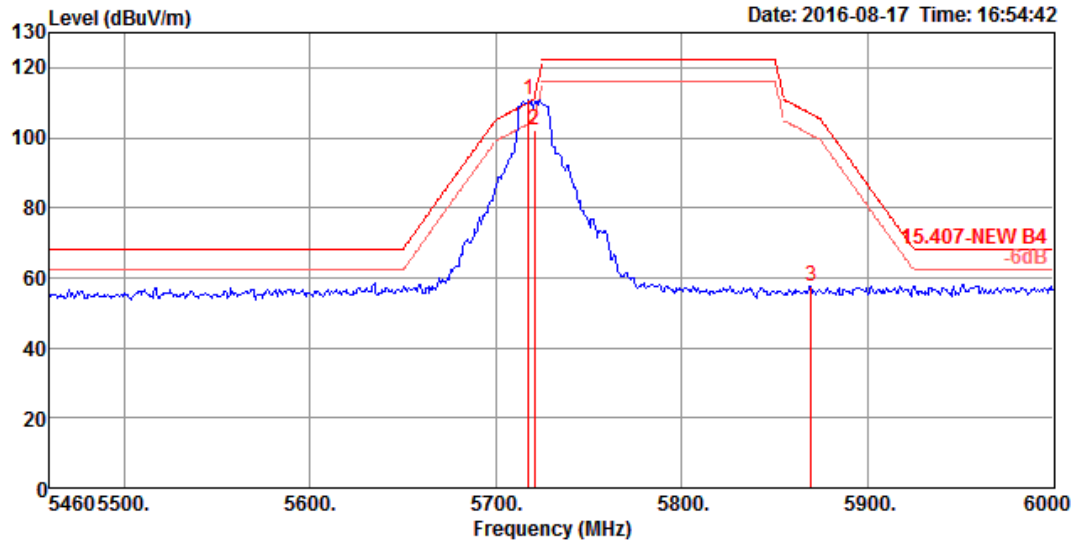

| | Freq | Level | Limit | Over | Read | Cable | Preamp | Antenna | | T/Pos | A/Pos | Remark |
|---|---------|--------|--------|--------|--------|-------|--------|---------|-----------|-------|-------|---------|
| | MHz | dBuV/m | dBuV/m | dB | dBuV | dB | dB | dB/m | Pol/Phase | deg | cm | |
| 1 | 5717.40 | 110.98 | | | 105.01 | 6.91 | 33.00 | 32.06 | VERTICAL | 276 | 286 | Peak |
| 2 | 5720.87 | 102.01 | | | 96.04 | 6.91 | 33.00 | 32.06 | VERTICAL | 276 | 286 | Average |
| 3 | 5869.40 | 57.56 | 106.77 | -49.21 | 51.38 | 7.00 | 33.06 | 32.24 | VERTICAL | 276 | 286 | Peak |

Item 1, 2 are the fundamental frequency at 5720 MHz.

| | | | |
|----------------------|----------------------|-----------------------|--|
| Temperature | 22.2°C | Humidity | 51% |
| Test Engineer | John Tang, Zero Chen | Configurations | IEEE 802.11n MCS0 HT20 CH 144 / Ant. 1 + Ant. 2 |

Channel 144 (UNII 2C)

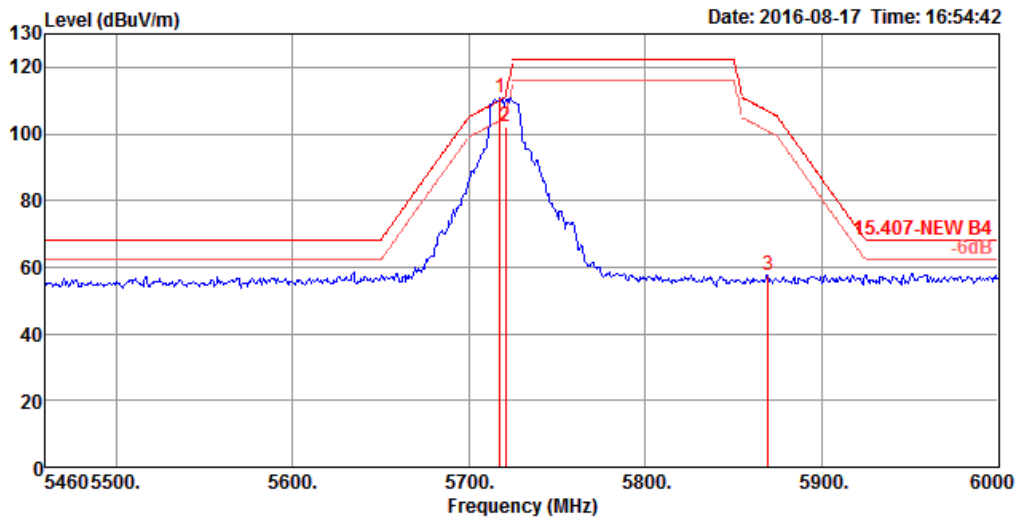

| | Freq | Level | Limit | Over | Read | Cable | Preamp | Antenna | | T/Pos | A/Pos | Remark |
|---|---------|--------|--------|--------|--------|-------|--------|---------|-----------|-------|-------|---------|
| | MHz | dBuV/m | dBuV/m | dB | dBuV | dB | dB | dB/m | Pol/Phase | deg | cm | |
| 1 | 5717.40 | 110.98 | | | 105.01 | 6.91 | 33.00 | 32.06 | VERTICAL | 276 | 286 | Peak |
| 2 | 5720.87 | 102.01 | | | 96.04 | 6.91 | 33.00 | 32.06 | VERTICAL | 276 | 286 | Average |
| 3 | 5869.40 | 57.56 | 106.77 | -49.21 | 51.38 | 7.00 | 33.06 | 32.24 | VERTICAL | 276 | 286 | Peak |

Item 1, 2 are the fundamental frequency at 5720 MHz.

Channel 144 (UNII 3)

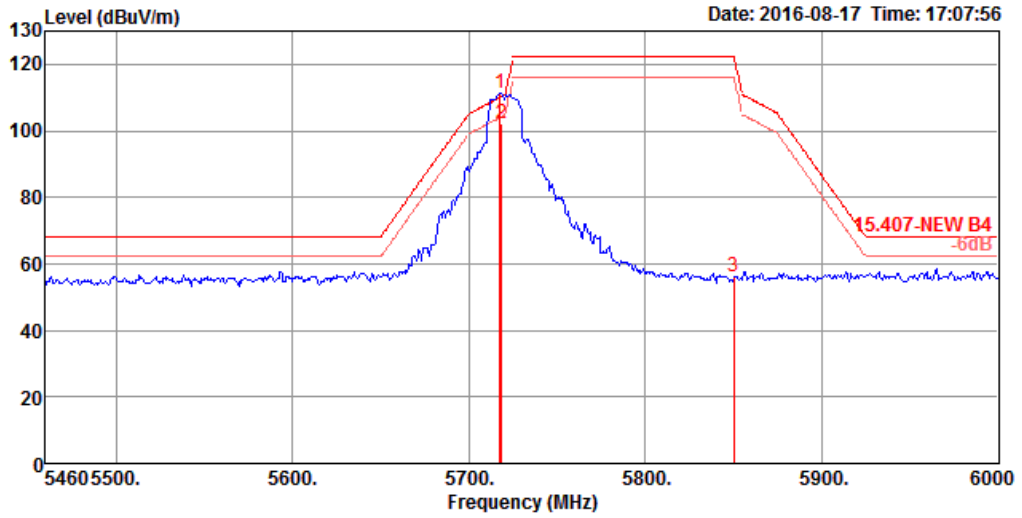

| | Freq | Level | Limit Line | Over Limit | Read Level | Cable Loss | Preamp Factor | Antenna Factor | Pol/Phase | T/Pos | A/Pos | Remark |
|---|---------|--------|------------|------------|------------|------------|---------------|----------------|-----------|-------|-------|---------|
| | MHz | dBuV/m | dBuV/m | dB | dBuV | dB | dB | dB/m | | deg | cm | |
| 1 | 5717.40 | 111.38 | | | 105.41 | 6.91 | 33.00 | 32.06 | VERTICAL | 85 | 299 | Peak |
| 2 | 5718.26 | 102.29 | | | 96.32 | 6.91 | 33.00 | 32.06 | VERTICAL | 85 | 299 | Average |
| 3 | 5850.00 | 56.31 | 122.20 | -65.89 | 50.14 | 7.00 | 33.05 | 32.22 | VERTICAL | 85 | 299 | Peak |

Item 1, 2 are the fundamental frequency at 5720 MHz.

| | | | |
|----------------------|----------------------|-----------------------|--|
| Temperature | 22.2°C | Humidity | 51% |
| Test Engineer | John Tang, Zero Chen | Configurations | IEEE 802.11n MCS0 HT40 CH 142 / Ant. 1 + Ant. 2 |

Channel 142 (UNII 2C)

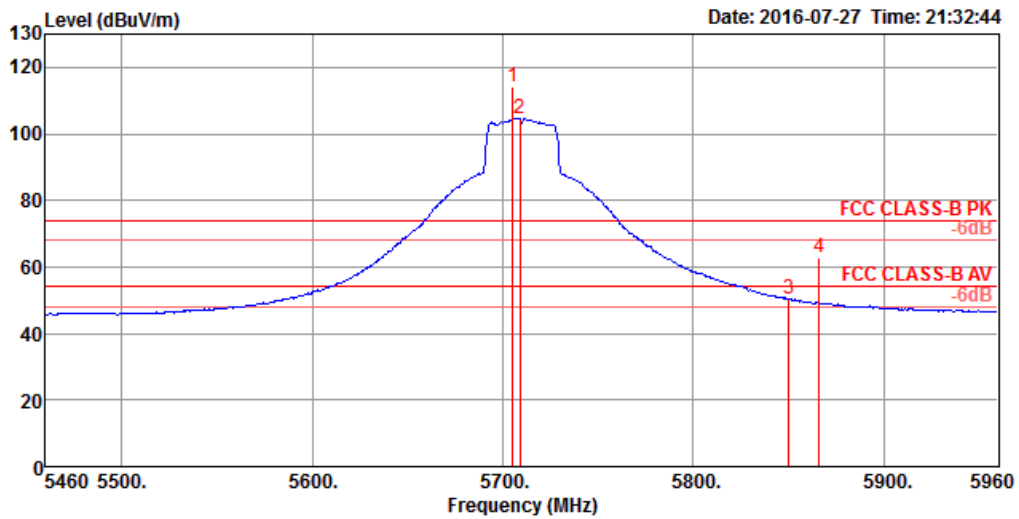

| | Freq | Level | Limit Line | Over Limit | Read Level | Cable Loss | Antenna Factor | Preamp Factor | A/Pos | T/Pos | Remark | Pol/Phase |
|---|---------|--------|------------|------------|------------|------------|----------------|---------------|-------|-------|---------|------------|
| | MHz | dBuV/m | dBuV/m | dB | dBuV | dB | dB/m | dB | cm | deg | | |
| 1 | 5705.00 | 114.24 | | | 108.30 | 6.90 | 32.04 | 33.00 | 100 | 314 | Peak | HORIZONTAL |
| 2 | 5709.00 | 104.69 | | | 98.72 | 6.91 | 32.06 | 33.00 | 100 | 314 | Average | HORIZONTAL |
| 3 | 5850.00 | 50.32 | 54.00 | -3.68 | 44.15 | 7.00 | 32.22 | 33.05 | 100 | 314 | Average | HORIZONTAL |
| 4 | 5866.00 | 62.87 | 74.00 | -11.13 | 56.69 | 7.00 | 32.24 | 33.06 | 100 | 314 | Peak | HORIZONTAL |

Item 1, 2 are the fundamental frequency at 5710 MHz.

Channel 142 (UNII 3)

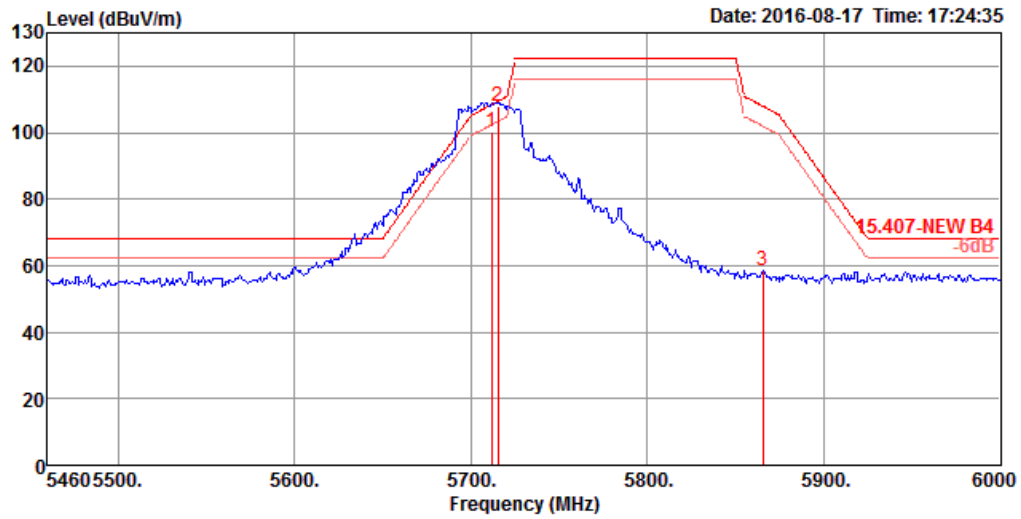

| | Freq | Level | Limit Line | Over Limit | Read Level | Cable Loss | Preamp Factor | Antenna Factor | Pol/Phase | T/Pos | A/Pos | Remark |
|---|---------|--------|------------|------------|------------|------------|---------------|----------------|-----------|-------|-------|---------|
| | MHz | dBuV/m | dBuV/m | dB | dBuV | dB | dB | dB/m | | deg | cm | |
| 1 | 5711.74 | 100.10 | | | 94.13 | 6.91 | 33.00 | 32.06 | VERTICAL | 83 | 314 | Average |
| 2 | 5715.21 | 107.82 | | | 101.85 | 6.91 | 33.00 | 32.06 | VERTICAL | 83 | 314 | Peak |
| 3 | 5865.40 | 58.51 | 107.89 | -49.38 | 52.33 | 7.00 | 33.06 | 32.24 | VERTICAL | 83 | 314 | Peak |

Item 1, 2 are the fundamental frequency at 5710 MHz.

Note:

Emission level (dBuV/m) = 20 log Emission level (uV/m)

Corrected Reading: Antenna Factor + Cable Loss + Read Level - Preamp Factor = Level

4.8. Frequency Stability Measurement

4.8.1. Limit

In-band emission is maintained within the band of operation under all conditions of normal operation as specified in the user's manual.

The transmitter center frequency tolerance shall be ± 20 ppm maximum for the 5 GHz band (IEEE 802.11n specification).

4.8.2. Measuring Instruments and Setting

Please refer to section 5 of equipments list in this report. The following table is the setting of the spectrum analyzer.

| Spectrum Parameter | Setting |
|--------------------|--|
| Attenuation | Auto |
| Span Frequency | Entire absence of modulation emissions bandwidth |
| RBW | 10 kHz |
| VBW | 10 kHz |
| Sweep Time | Auto |

4.8.3. Test Procedures

1. The transmitter output (antenna port) was connected to the spectrum analyzer.
2. EUT have transmitted absence of modulation signal and fixed channelize.
3. Set the spectrum analyzer span to view the entire absence of modulation emissions bandwidth.
4. Set RBW = 10 kHz, VBW = 10 kHz with peak detector and maxhold settings.
5. f_c is declaring of channel frequency. Then the frequency error formula is $(f_c - f) / f_c \times 10^6$ ppm and the limit is less than ± 20 ppm (IEEE 802.11n specification).
6. Allow sufficient time (approximately 30 min) for the temperature of the chamber to stabilize, turn the EUT on and measure the operating frequency after 2, 5, and 10 minutes.
7. The test extreme voltage is to change the primary supply voltage from 85 to 115 percent of the nominal value
8. Extreme temperature is $-30^\circ\text{C} \sim 50^\circ\text{C}$.

4.8.4. Test Setup Layout

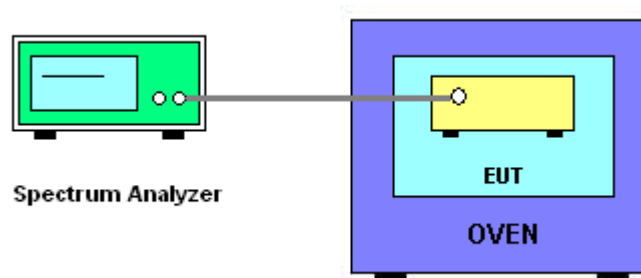

4.8.5. Test Deviation

There is no deviation with the original standard.

4.8.6. EUT Operation during Test

The EUT was programmed to be in continuously un-modulation transmitting mode.

4.8.7. Test Result of Frequency Stability

| | | | |
|---------------|----------|-----------|-----------------------------|
| Temperature | 25°C | Humidity | 56% |
| Test Engineer | Gary Chu | Test Date | Jul. 29, 2016~Aug. 13, 2016 |

Mode: 20 MHz / Ant. 1

Voltage vs. Frequency Stability

| Voltage (V) | Measurement Frequency (MHz) | | | |
|----------------------|-----------------------------|-----------|-----------|-----------|
| | 5200 MHz | | | |
| | 0 Minute | 2 Minute | 5 Minute | 10 Minute |
| 126.50 | 5200.0579 | 5200.0569 | 5200.0564 | 5200.0561 |
| 110.00 | 5200.0575 | 5200.0569 | 5200.0560 | 5200.0554 |
| 93.50 | 5200.0573 | 5200.0566 | 5200.0563 | 5200.0560 |
| Max. Deviation (MHz) | 0.0579 | 0.0569 | 0.0564 | 0.0561 |
| Max. Deviation (ppm) | 11.13 | 10.94 | 10.85 | 10.79 |
| Result | Complies | | | |

Temperature vs. Frequency Stability

| Temperature (°C) | Measurement Frequency (MHz) | | | |
|----------------------|-----------------------------|-----------|-----------|-----------|
| | 5200 MHz | | | |
| | 0 Minute | 2 Minute | 5 Minute | 10 Minute |
| -30 | 5200.0637 | 5200.0629 | 5200.0621 | 5200.0612 |
| -20 | 5200.0623 | 5200.0616 | 5200.0608 | 5200.0607 |
| -10 | 5200.0606 | 5200.0599 | 5200.0598 | 5200.0596 |
| 0 | 5200.0586 | 5200.0580 | 5200.0574 | 5200.0567 |
| 10 | 5200.0576 | 5200.0570 | 5200.0563 | 5200.0558 |
| 20 | 5200.0575 | 5200.0569 | 5200.0561 | 5200.0560 |
| 30 | 5200.0518 | 5200.0508 | 5200.0499 | 5200.0492 |
| 40 | 5200.0510 | 5200.0501 | 5200.0497 | 5200.0487 |
| 50 | 5200.0490 | 5200.0480 | 5200.0472 | 5200.0470 |
| Max. Deviation (MHz) | 0.0637 | 0.0629 | 0.0621 | 0.0612 |
| Max. Deviation (ppm) | 12.25 | 12.10 | 11.94 | 11.77 |
| Result | Complies | | | |

Voltage vs. Frequency Stability

| Voltage | Measurement Frequency (MHz) | | | |
|----------------------|-----------------------------|-----------|-----------|-----------|
| (V) | 5300 MHz | | | |
| | 0 Minute | 2 Minute | 5 Minute | 10 Minute |
| 126.50 | 5300.0443 | 5300.0442 | 5300.0435 | 5300.0431 |
| 110.00 | 5300.0435 | 5300.0425 | 5300.0419 | 5300.0418 |
| 93.50 | 5300.0426 | 5300.0416 | 5300.0413 | 5300.0411 |
| Max. Deviation (MHz) | 0.0443 | 0.0442 | 0.0435 | 0.0431 |
| Max. Deviation (ppm) | 8.36 | 8.34 | 8.21 | 8.13 |
| Result | Complies | | | |

Temperature vs. Frequency Stability

| Temperature | Measurement Frequency (MHz) | | | |
|----------------------|-----------------------------|-----------|-----------|-----------|
| (°C) | 5300 MHz | | | |
| | 0 Minute | 2 Minute | 5 Minute | 10 Minute |
| -30 | 5300.0515 | 5300.0506 | 5300.0500 | 5300.0490 |
| -20 | 5300.0498 | 5300.0492 | 5300.0491 | 5300.0488 |
| -10 | 5300.0481 | 5300.0472 | 5300.0468 | 5300.0460 |
| 0 | 5300.0464 | 5300.0462 | 5300.0461 | 5300.0457 |
| 10 | 5300.0447 | 5300.0438 | 5300.0432 | 5300.0424 |
| 20 | 5300.0435 | 5300.0432 | 5300.0424 | 5300.0423 |
| 30 | 5300.0428 | 5300.0419 | 5300.0416 | 5300.0410 |
| 40 | 5300.0420 | 5300.0416 | 5300.0414 | 5300.0413 |
| 50 | 5300.0406 | 5300.0404 | 5300.0403 | 5300.0393 |
| Max. Deviation (MHz) | 0.0515 | 0.0506 | 0.0500 | 0.0490 |
| Max. Deviation (ppm) | 9.72 | 9.55 | 9.43 | 9.25 |
| Result | Complies | | | |

Voltage vs. Frequency Stability

| Voltage | Measurement Frequency (MHz) | | | |
|----------------------|-----------------------------|-----------|-----------|-----------|
| (V) | 5580 MHz | | | |
| | 0 Minute | 2 Minute | 5 Minute | 10 Minute |
| 126.50 | 5580.0588 | 5580.0587 | 5580.0585 | 5580.0580 |
| 110.00 | 5580.0580 | 5580.0579 | 5580.0577 | 5580.0575 |
| 93.50 | 5580.0576 | 5580.0568 | 5580.0564 | 5580.0561 |
| Max. Deviation (MHz) | 0.0588 | 0.0587 | 0.0585 | 0.0580 |
| Max. Deviation (ppm) | 10.54 | 10.52 | 10.48 | 10.39 |
| Result | Complies | | | |

Temperature vs. Frequency Stability

| Temperature | Measurement Frequency (MHz) | | | |
|----------------------|-----------------------------|-----------|-----------|-----------|
| (°C) | 5580 MHz | | | |
| | 0 Minute | 2 Minute | 5 Minute | 10 Minute |
| -30 | 5580.0521 | 5580.0513 | 5580.0512 | 5580.0511 |
| -20 | 5580.0527 | 5580.0524 | 5580.0516 | 5580.0511 |
| -10 | 5580.0536 | 5580.0527 | 5580.0517 | 5580.0513 |
| 0 | 5580.0551 | 5580.0543 | 5580.0533 | 5580.0528 |
| 10 | 5580.0566 | 5580.0563 | 5580.0562 | 5580.0552 |
| 20 | 5580.0580 | 5580.0577 | 5580.0573 | 5580.0566 |
| 30 | 5580.0610 | 5580.0601 | 5580.0599 | 5580.0598 |
| 40 | 5580.0628 | 5580.0621 | 5580.0620 | 5580.0619 |
| 50 | 5580.0646 | 5580.0639 | 5580.0634 | 5580.0627 |
| Max. Deviation (MHz) | 0.0646 | 0.0639 | 0.0634 | 0.0627 |
| Max. Deviation (ppm) | 11.58 | 11.45 | 11.36 | 11.24 |
| Result | Complies | | | |

Voltage vs. Frequency Stability

| Voltage | Measurement Frequency (MHz) | | | |
|----------------------|-----------------------------|-----------|-----------|-----------|
| (V) | 5785 MHz | | | |
| | 0 Minute | 2 Minute | 5 Minute | 10 Minute |
| 126.50 | 5785.0155 | 5785.0151 | 5785.0144 | 5785.0138 |
| 110.00 | 5785.0145 | 5785.0138 | 5785.0130 | 5785.0122 |
| 93.50 | 5785.0137 | 5785.0132 | 5785.0122 | 5785.0117 |
| Max. Deviation (MHz) | 0.0155 | 0.0151 | 0.0144 | 0.0138 |
| Max. Deviation (ppm) | 2.68 | 2.61 | 2.49 | 2.39 |
| Result | Complies | | | |

Temperature vs. Frequency Stability

| Temperature | Measurement Frequency (MHz) | | | |
|----------------------|-----------------------------|-----------|-----------|-----------|
| (°C) | 5785 MHz | | | |
| | 0 Minute | 2 Minute | 5 Minute | 10 Minute |
| -30 | 5785.0119 | 5785.0116 | 5785.0108 | 5785.0098 |
| -20 | 5785.0123 | 5785.0116 | 5785.0111 | 5785.0105 |
| -10 | 5785.0138 | 5785.0134 | 5785.0133 | 5785.0129 |
| 0 | 5785.0140 | 5785.0134 | 5785.0126 | 5785.0116 |
| 10 | 5785.0141 | 5785.0135 | 5785.0127 | 5785.0125 |
| 20 | 5785.0145 | 5785.0139 | 5785.0135 | 5785.0129 |
| 30 | 5785.0178 | 5785.0170 | 5785.0161 | 5785.0160 |
| 40 | 5785.0196 | 5785.0195 | 5785.0186 | 5785.0183 |
| 50 | 5785.0203 | 5785.0194 | 5785.0188 | 5785.0187 |
| Max. Deviation (MHz) | 0.0203 | 0.0195 | 0.0188 | 0.0187 |
| Max. Deviation (ppm) | 3.51 | 3.37 | 3.25 | 3.23 |
| Result | Complies | | | |

Mode: 40 MHz / Ant. 1

Voltage vs. Frequency Stability

| Voltage | Measurement Frequency (MHz) | | | |
|----------------------|-----------------------------|-----------|-----------|-----------|
| (V) | 5190 MHz | | | |
| | 0 Minute | 2 Minute | 5 Minute | 10 Minute |
| 126.50 | 5190.0874 | 5190.0869 | 5190.0862 | 5190.0861 |
| 110.00 | 5190.0870 | 5190.0861 | 5190.0858 | 5190.0848 |
| 93.50 | 5190.0863 | 5190.0854 | 5190.0849 | 5190.0842 |
| Max. Deviation (MHz) | 0.0874 | 0.0869 | 0.0862 | 0.0861 |
| Max. Deviation (ppm) | 16.84 | 16.74 | 16.61 | 16.59 |
| Result | Complies | | | |

Temperature vs. Frequency Stability

| Temperature | Measurement Frequency (MHz) | | | |
|----------------------|-----------------------------|-----------|-----------|-----------|
| (°C) | 5190 MHz | | | |
| | 0 Minute | 2 Minute | 5 Minute | 10 Minute |
| -30 | 5190.0916 | 5190.0914 | 5190.0905 | 5190.0899 |
| -20 | 5190.0907 | 5190.0904 | 5190.0894 | 5190.0888 |
| -10 | 5190.0889 | 5190.0880 | 5190.0870 | 5190.0866 |
| 0 | 5190.0887 | 5190.0879 | 5190.0871 | 5190.0865 |
| 10 | 5190.0876 | 5190.0870 | 5190.0863 | 5190.0854 |
| 20 | 5190.0870 | 5190.0866 | 5190.0861 | 5190.0851 |
| 30 | 5190.0840 | 5190.0831 | 5190.0830 | 5190.0822 |
| 40 | 5190.0823 | 5190.0814 | 5190.0810 | 5190.0800 |
| 50 | 5190.0816 | 5190.0811 | 5190.0806 | 5190.0802 |
| Max. Deviation (MHz) | 0.0916 | 0.0914 | 0.0905 | 0.0899 |
| Max. Deviation (ppm) | 17.65 | 17.61 | 17.44 | 17.32 |
| Result | Complies | | | |

Voltage vs. Frequency Stability

| Voltage | Measurement Frequency (MHz) | | | |
|----------------------|-----------------------------|-----------|-----------|-----------|
| (V) | 5310 MHz | | | |
| | 0 Minute | 2 Minute | 5 Minute | 10 Minute |
| 126.50 | 5310.0880 | 5310.0878 | 5310.0871 | 5310.0867 |
| 110.00 | 5310.0870 | 5310.0864 | 5310.0855 | 5310.0848 |
| 93.50 | 5310.0869 | 5310.0865 | 5310.0857 | 5310.0854 |
| Max. Deviation (MHz) | 0.0880 | 0.0878 | 0.0871 | 0.0867 |
| Max. Deviation (ppm) | 16.57 | 16.53 | 16.40 | 16.33 |
| Result | Complies | | | |

Temperature vs. Frequency Stability

| Temperature | Measurement Frequency (MHz) | | | |
|----------------------|-----------------------------|-----------|-----------|-----------|
| (°C) | 5310 MHz | | | |
| | 0 Minute | 2 Minute | 5 Minute | 10 Minute |
| -30 | 5310.0924 | 5310.0914 | 5310.0911 | 5310.0909 |
| -20 | 5310.0906 | 5310.0898 | 5310.0895 | 5310.0891 |
| -10 | 5310.0904 | 5310.0902 | 5310.0894 | 5310.0890 |
| 0 | 5310.0886 | 5310.0879 | 5310.0873 | 5310.0864 |
| 10 | 5310.0877 | 5310.0874 | 5310.0871 | 5310.0866 |
| 20 | 5310.0870 | 5310.0861 | 5310.0851 | 5310.0843 |
| 30 | 5310.0830 | 5310.0829 | 5310.0827 | 5310.0823 |
| 40 | 5310.0826 | 5310.0822 | 5310.0812 | 5310.0809 |
| 50 | 5310.0811 | 5310.0807 | 5310.0805 | 5310.0804 |
| Max. Deviation (MHz) | 0.0924 | 0.0914 | 0.0911 | 0.0909 |
| Max. Deviation (ppm) | 17.40 | 17.21 | 17.16 | 17.12 |
| Result | Complies | | | |

Voltage vs. Frequency Stability

| Voltage | Measurement Frequency (MHz) | | | |
|----------------------|-----------------------------|-----------|-----------|-----------|
| (V) | 5550 MHz | | | |
| | 0 Minute | 2 Minute | 5 Minute | 10 Minute |
| 126.50 | 5550.0445 | 5550.0442 | 5550.0441 | 5550.0434 |
| 110.00 | 5550.0435 | 5550.0429 | 5550.0421 | 5550.0419 |
| 93.50 | 5550.0430 | 5550.0428 | 5550.0418 | 5550.0412 |
| Max. Deviation (MHz) | 0.0445 | 0.0442 | 0.0441 | 0.0434 |
| Max. Deviation (ppm) | 8.02 | 7.96 | 7.95 | 7.82 |
| Result | Complies | | | |

Temperature vs. Frequency Stability

| Temperature | Measurement Frequency (MHz) | | | |
|----------------------|-----------------------------|-----------|-----------|-----------|
| (°C) | 5550 MHz | | | |
| | 0 Minute | 2 Minute | 5 Minute | 10 Minute |
| -30 | 5550.0373 | 5550.0367 | 5550.0357 | 5550.0351 |
| -20 | 5550.0377 | 5550.0367 | 5550.0366 | 5550.0359 |
| -10 | 5550.0397 | 5550.0394 | 5550.0385 | 5550.0381 |
| 0 | 5550.0408 | 5550.0405 | 5550.0399 | 5550.0397 |
| 10 | 5550.0424 | 5550.0421 | 5550.0416 | 5550.0409 |
| 20 | 5550.0435 | 5550.0426 | 5550.0416 | 5550.0411 |
| 30 | 5550.0479 | 5550.0475 | 5550.0471 | 5550.0463 |
| 40 | 5550.0499 | 5550.0493 | 5550.0489 | 5550.0487 |
| 50 | 5550.0504 | 5550.0503 | 5550.0494 | 5550.0485 |
| Max. Deviation (MHz) | 0.0504 | 0.0503 | 0.0494 | 0.0487 |
| Max. Deviation (ppm) | 9.08 | 9.06 | 8.90 | 8.77 |
| Result | Complies | | | |

Voltage vs. Frequency Stability

| Voltage | Measurement Frequency (MHz) | | | |
|----------------------|-----------------------------|-----------|-----------|-----------|
| (V) | 5755 MHz | | | |
| | 0 Minute | 2 Minute | 5 Minute | 10 Minute |
| 126.50 | 5755.0442 | 5755.0436 | 5755.0430 | 5755.0421 |
| 110.00 | 5755.0435 | 5755.0429 | 5755.0426 | 5755.0422 |
| 93.50 | 5755.0433 | 5755.0432 | 5755.0424 | 5755.0416 |
| Max. Deviation (MHz) | 0.0442 | 0.0436 | 0.0430 | 0.0422 |
| Max. Deviation (ppm) | 7.68 | 7.58 | 7.47 | 7.33 |
| Result | Complies | | | |

Temperature vs. Frequency Stability

| Temperature | Measurement Frequency (MHz) | | | |
|----------------------|-----------------------------|-----------|-----------|-----------|
| (°C) | 5755 MHz | | | |
| | 0 Minute | 2 Minute | 5 Minute | 10 Minute |
| -30 | 5755.0392 | 5755.0389 | 5755.0382 | 5755.0374 |
| -20 | 5755.0404 | 5755.0403 | 5755.0395 | 5755.0389 |
| -10 | 5755.0406 | 5755.0397 | 5755.0392 | 5755.0382 |
| 0 | 5755.0410 | 5755.0405 | 5755.0401 | 5755.0394 |
| 10 | 5755.0429 | 5755.0426 | 5755.0419 | 5755.0416 |
| 20 | 5755.0435 | 5755.0433 | 5755.0431 | 5755.0422 |
| 30 | 5755.0439 | 5755.0430 | 5755.0429 | 5755.0419 |
| 40 | 5755.0454 | 5755.0451 | 5755.0448 | 5755.0443 |
| 50 | 5755.0463 | 5755.0460 | 5755.0453 | 5755.0443 |
| Max. Deviation (MHz) | 0.0463 | 0.0460 | 0.0453 | 0.0443 |
| Max. Deviation (ppm) | 8.05 | 7.99 | 7.87 | 7.70 |
| Result | Complies | | | |

4.9. Antenna Requirements

4.9.1. Limit

Except for special regulations, the Low-power Radio-frequency Devices must not be equipped with any jacket for installing an antenna with extension cable. An intentional radiator shall be designed to ensure that no antenna other than that furnished by the responsible party shall be used with the device. The use of a permanently attached antenna or of an antenna that uses a unique coupling to the intentional radiator shall be considered sufficient to comply with the provisions of this Section. The manufacturer may design the unit so that the user can replace a broken antenna, but the use of a standard antenna jack or electrical connector is prohibited. Further, this requirement does not apply to intentional radiators that must be professionally installed.

4.9.2. Antenna Connector Construction

Please refer to section 3.3 in this test report; antenna connector complied with the requirements.

5. LIST OF MEASURING EQUIPMENTS

| Instrument | Manufacturer | Model No. | Serial No. | Characteristics | Calibration Date | Remark |
|----------------------------|--------------|------------------|---------------|------------------|------------------|-----------------------|
| LISN | Schwarzbeck | NSLK 8127 | 8127650 | 9kHz ~ 30MHz | Nov. 16, 2015 | Conduction (CO02-CB) |
| LISN | Schwarzbeck | NSLK 8127 | 8127478 | 9kHz ~ 30MHz | Nov. 13, 2015 | Conduction (CO02-CB) |
| EMI Receiver | Agilent | N9038A | MY52260140 | 9kHz ~ 8.4GHz | Jan. 18, 2016 | Conduction (CO02-CB) |
| COND Cable | Woken | Cable | 01 | 0.15MHz ~ 30MHz | Dec. 01, 2015 | Conduction (CO02-CB) |
| Software | Audix | E3 | 6.120210n | - | N.C.R. | Conduction (CO02-CB) |
| Pulse Limiter | Schwarzbeck | VTSD 9561F | 9561-F073 | 9kHz ~ 30MHz | Sep. 30, 2015 | Conduction (CO02-CB) |
| Bilog Antenna | TESEQ | CBL6112D | 37880 | 20MHz ~ 2GHz | Sep. 03, 2015 | Radiation (03CH01-CB) |
| Horn Antenna | EMCO | 3115 | 00075790 | 750MHz ~ 18GHz | Oct. 22, 2015 | Radiation (03CH01-CB) |
| Horn Antenna | Schwarzbeck | BBHA 9170 | BBHA9170252 | 15GHz ~ 40GHz | Jul. 25, 2016 | Radiation (03CH01-CB) |
| Pre-Amplifier | Agilent | 8447D | 2944A10991 | 0.1MHz ~ 1.3GHz | Mar. 15, 2016 | Radiation (03CH01-CB) |
| Pre-Amplifier | Agilent | 8449B | 3008A02310 | 1GHz ~ 26.5GHz | Jan. 18, 2016 | Radiation (03CH01-CB) |
| Pre-Amplifier | WM | TF-130N-R1 | 923365 | 26GHz ~ 40GHz | Nov. 13, 2015 | Radiation (03CH01-CB) |
| Spectrum Analyzer | R&S | FSP40 | 100056 | 9kHz ~ 40GHz | Oct. 27, 2015 | Radiation (03CH01-CB) |
| EMI Test | R&S | ESCS | 100355 | 9kHz ~ 2.75GHz | May 16, 2016 | Radiation (03CH01-CB) |
| RF Cable-low | Woken | Low Cable-1 | N/A | 30 MHz ~ 1 GHz | Nov. 02, 2015 | Radiation (03CH01-CB) |
| RF Cable-high | Woken | High Cable-16 | N/A | 1 GHz ~ 18 GHz | Nov. 02, 2015 | Radiation (03CH01-CB) |
| RF Cable-high | Woken | High Cable-17 | N/A | 1 GHz ~ 18 GHz | Nov. 02, 2015 | Radiation (03CH01-CB) |
| RF Cable-high | Woken | High Cable-40G-1 | N/A | 18GHz ~ 40 GHz | Nov. 02, 2015 | Radiation (03CH01-CB) |
| RF Cable-high | Woken | High Cable-40G-2 | N/A | 18GHz ~ 40 GHz | Nov. 02, 2015 | Radiation (03CH01-CB) |
| Test Software | Audix | E3 | 6.2009-I0-7 | N/A | N/A | Radiation (03CH01-CB) |
| Loop Antenna | Teseq | HLA 6120 | 24155 | 9kHz - 30 MHz | Mar. 16, 2016* | Radiation (03CH01-CB) |
| Spectrum analyzer | R&S | FSV40 | 100979 | 9kHz~40GHz | Dec. 09, 2015 | Conducted (TH01-CB) |
| Temp. and Humidity Chamber | Ten Billion | TTH-D3SP | TBN-931011 | -30~100 degree | Jun. 03, 2016 | Conducted (TH01-CB) |
| RF Cable-high | Woken | RG402 | High Cable-6 | 1 GHz – 26.5 GHz | Nov. 02, 2015 | Conducted (TH01-CB) |
| RF Cable-high | Woken | RG402 | High Cable-7 | 1 GHz – 26.5 GHz | Nov. 02, 2015 | Conducted (TH01-CB) |
| RF Cable-high | Woken | RG402 | High Cable-8 | 1 GHz – 26.5 GHz | Nov. 02, 2015 | Conducted (TH01-CB) |
| RF Cable-high | Woken | RG402 | High Cable-9 | 1 GHz – 26.5 GHz | Nov. 02, 2015 | Conducted (TH01-CB) |
| RF Cable-high | Woken | RG402 | High Cable-10 | 1 GHz – 26.5 GHz | Nov. 02, 2015 | Conducted (TH01-CB) |
| Power Sensor | Agilent | U2021XA | MY53410001 | 50MHz~18GHz | Nov. 02, 2015 | Conducted (TH01-CB) |

Note: Calibration Interval of instruments listed above is one year.

“*” Calibration Interval of instruments listed above is two years.

N.C.R. means Non-Calibration required.

6. MEASUREMENT UNCERTAINTY

| Test Items | Uncertainty | Remark |
|--------------------------------------|-----------------------|--------------------------|
| Conducted Emission (150kHz ~ 30MHz) | 3.2 dB | Confidence levels of 95% |
| Radiated Emission (30MHz ~ 1,000MHz) | 3.6 dB | Confidence levels of 95% |
| Radiated Emission (1GHz ~ 18GHz) | 3.7 dB | Confidence levels of 95% |
| Radiated Emission (18GHz ~ 40GHz) | 3.5 dB | Confidence levels of 95% |
| Conducted Emission | 1.7 dB | Confidence levels of 95% |
| Output Power Measurement | 1.33 dB | Confidence levels of 95% |
| Power Density Measurement | 1.27 dB | Confidence levels of 95% |
| Bandwidth Measurement | 9.74×10^{-8} | Confidence levels of 95% |
| Frequency Stability | 6.06×10^{-8} | Confidence levels of 95% |

Appendix B. Radiated Emission Co-location Report

1. Results of Radiated Emissions for Co-located

| | | | |
|---------------|--|----------------|-------------------------|
| Temperature | 22.2°C | Humidity | 51% |
| Test Engineer | John Tang, Zero Chen | Configurations | 2.4GHz WLAN + Bluetooth |
| Test Mode | Mode 2. EUT Z axis - 2.4GHz WLAN function + Bluetooth function | | |

Horizontal

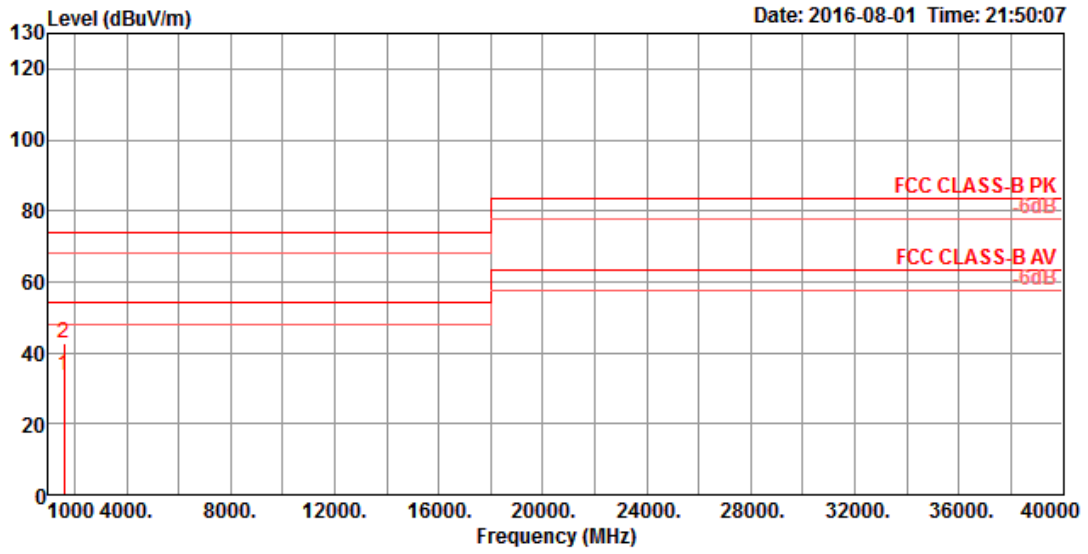

| | Freq | Level | Limit Line | Over Limit | Read Level | CableAntenna Loss | Preamp Factor | A/Pos | T/Pos | Remark | Pol/Phase |
|---|---------|--------|------------|------------|------------|-------------------|---------------|-------|-------|------------|------------|
| | MHz | dBuV/m | dBuV/m | dB | dBuV | dB | dB/m | dB | cm | deg | |
| 1 | 1608.76 | 33.62 | 54.00 | -20.38 | 36.30 | 4.56 | 25.59 | 32.83 | 113 | 78 Average | HORIZONTAL |
| 2 | 1609.00 | 42.92 | 74.00 | -31.08 | 45.58 | 4.57 | 25.60 | 32.83 | 113 | 78 Peak | HORIZONTAL |

Vertical

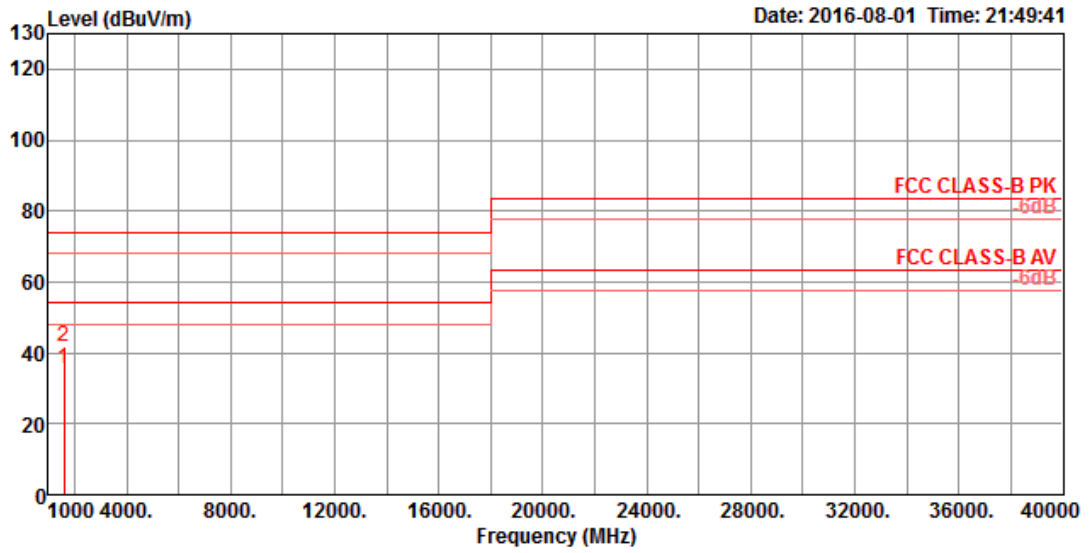

| | Freq | Level | Limit | Over | Read | CableAntenna | Preamp | A/Pos | T/Pos | Remark | Pol/Phase |
|---|---------|--------|--------|--------|-------|--------------|--------|-------|-------|-------------|-----------|
| | MHz | dBuV/m | dBuV/m | dB | dBuV | dB | dB/m | dB | cm | deg | |
| 1 | 1608.92 | 35.62 | 54.00 | -18.38 | 38.28 | 4.57 | 25.60 | 32.83 | 103 | 221 Average | VERTICAL |
| 2 | 1609.06 | 41.78 | 74.00 | -32.22 | 44.44 | 4.57 | 25.60 | 32.83 | 103 | 221 Peak | VERTICAL |

| | | | |
|---------------|--|----------------|-----------------------|
| Temperature | 22.2°C | Humidity | 51% |
| Test Engineer | John Tang, Zero Chen | Configurations | 5GHz WLAN + Bluetooth |
| Test Mode | Mode 4. EUT Z axis - 5GHz WLAN function + Bluetooth function | | |

Horizontal

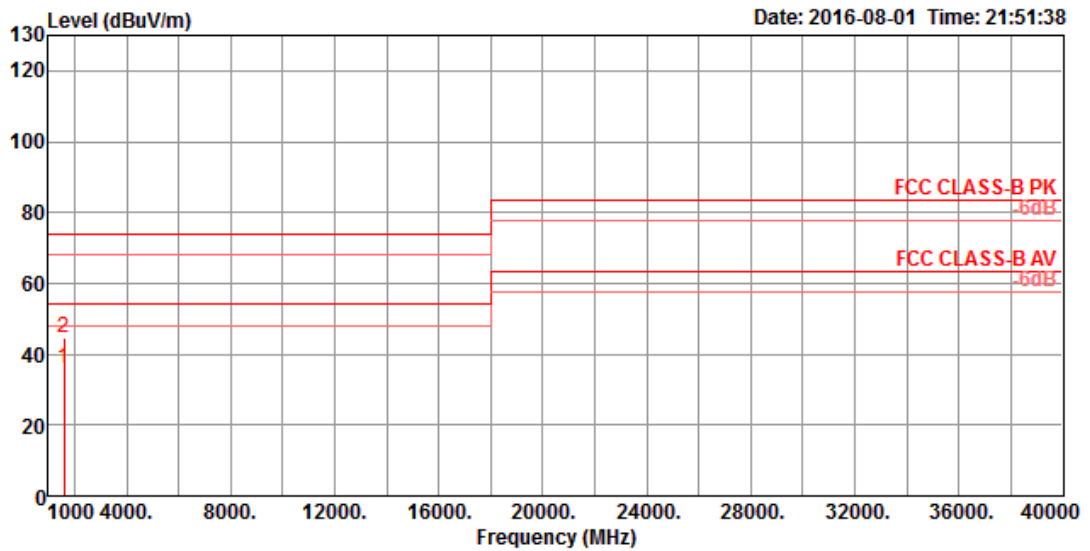

| | Freq | Level | Limit | Over | Read | CableAntenna | Preamp | A/Pos | T/Pos | Remark | Pol/Phase |
|---|---------|--------|--------|--------|-------|--------------|--------|-------|-------|-------------|------------|
| | MHz | dBuV/m | dBuV/m | dB | dBuV | dB | dB/m | dB | cm | deg | |
| 1 | 1608.86 | 35.83 | 54.00 | -18.17 | 38.49 | 4.57 | 25.60 | 32.83 | 115 | 321 Average | HORIZONTAL |
| 2 | 1609.04 | 44.62 | 74.00 | -29.38 | 47.28 | 4.57 | 25.60 | 32.83 | 115 | 321 Peak | HORIZONTAL |

Vertical

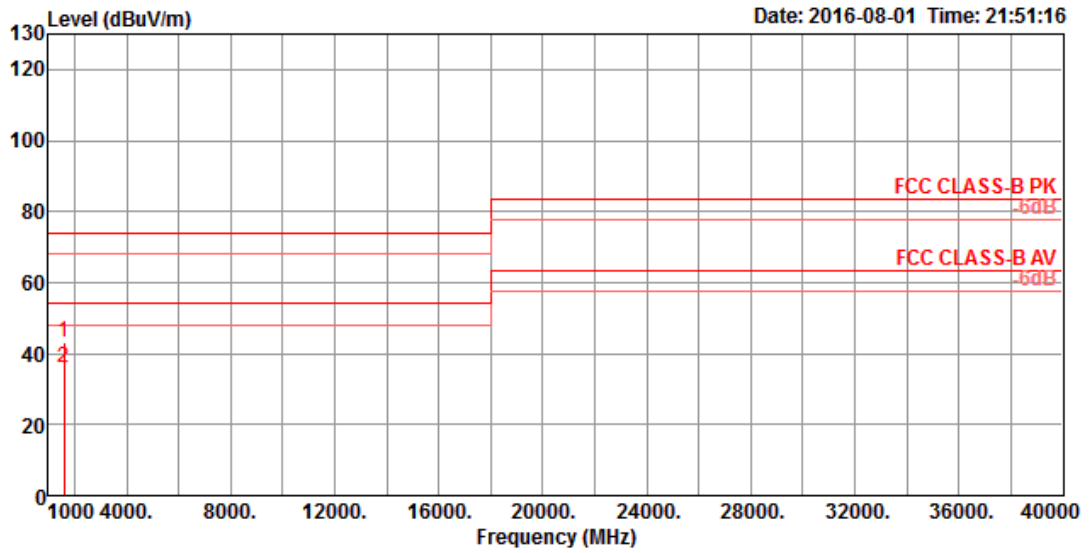

| | Freq | Level | Limit Line | Over Limit | Read Level | CableAntenna Loss | Antenna Factor | Preamp Factor | A/Pos | T/Pos | Remark | Pol/Phase |
|---|---------|--------|------------|------------|------------|-------------------|----------------|---------------|-------|-------|---------|-----------|
| | MHz | dBuV/m | dBuV/m | dB | dBuV | dB | dB/m | dB | cm | deg | | |
| 1 | 1608.60 | 43.18 | 74.00 | -30.82 | 45.86 | 4.56 | 25.59 | 32.83 | 104 | 278 | Peak | VERTICAL |
| 2 | 1608.86 | 35.78 | 54.00 | -18.22 | 38.44 | 4.57 | 25.60 | 32.83 | 104 | 278 | Average | VERTICAL |