

FCC Test Report

FCC ID : NKR-DHUBW69
Equipment : 802.11 abgn/ac 2x2 module with BT
Model No. : DHUB-W69
Brand Name : WNC
Applicant : Wistron NeWeb Corp.
Address : 20 Park Avenue II, Hsinchu Science Park,
Hsinchu 308, Taiwan, R.O.C.
Standard : 47 CFR FCC Part 15.247
Received Date : Dec. 16, 2015
Tested Date : Jan. 11 ~ Jan. 27, 2016

We, International Certification Corp., would like to declare that the tested sample has been evaluated and in compliance with the requirement of the above standards. The test results contained in this report refer exclusively to the product. It may be duplicated completely for legal use with the approval of the applicant. It shall not be reproduced except in full without the written approval of our laboratory.

Approved & Reviewed by:



Gary Chang / Manager



Table of Contents

1	GENERAL DESCRIPTION	5
1.1	Information.....	5
1.2	Local Support Equipment List	7
1.3	Test Setup Chart	7
1.4	Test Equipment List and Calibration Data.....	8
1.5	Test Standards	9
1.6	Measurement Uncertainty	9
2	TEST CONFIGURATION	10
2.1	Testing Condition	10
2.2	The Worst Test Modes and Channel Details	10
3	TRANSMITTER TEST RESULTS.....	11
3.1	Conducted Emissions.....	11
3.2	6dB and Occupied Bandwidth	16
3.3	RF Output Power	18
3.4	Power Spectral Density	20
3.5	Emissions in Restricted Frequency Bands.....	22
3.6	Emissions in non-restricted Frequency Bands	44
4	TEST LABORATORY INFORMATION	47

Release Record

Report No.	Version	Description	Issued Date
FR5D1601AE	Rev. 01	Initial issue	Feb. 05, 2016

Summary of Test Results

FCC Rules	Test Items	Measured	Result
15.207	AC Power Line Conducted Emissions	[dBuV]: 0.156MHz 52.37 (Margin -13.28dB) - QP	Pass
15.247(d) 15.209	Radiated Emissions	[dBuV/m at 3m]: 246.31MHz 43.59 (Margin -2.41dB) - PK	Pass
15.247(b)(3)	Maximum Output Power	Power [dBm]: 9.38	Pass
15.247(a)(2)	6dB Bandwidth	Meet the requirement of limit	Pass
15.247(e)	Power Spectral Density	Meet the requirement of limit	Pass
15.203	Antenna Requirement	Meet the requirement of limit	Pass

1 General Description

1.1 Information

1.1.1 Specification of the Equipment under Test (EUT)

RF General Information				
Frequency Range (MHz)	Bluetooth Mode	Ch. Freq. (MHz)	Channel Number	Data Rate
2400-2483.5	V4.1 LE	2402-2480	0-39 [40]	1 Mbps

Note 1: Bluetooth LE (Low energy) uses GFSK modulation.

1.1.2 Antenna Details

Ant. No.	Model	Type	Connector	Gain (dBi)	Cable length (mm)
1	DHUB-W69_BT_81.EEW15.GLC	PIFA	IPEX	-1.45	500
2	DHUB-W69_BT_81.EEW15.GLE	PIFA	IPEX	-1.93	670
3	DHUB-W69_BT_81.EEW15.GLF	PIFA	IPEX	-2.01	700
4	E48u	PIFA	UFL	1.41	960
5	E55u	PIFA	UFL	2.51	510
6	M55	PIFA	UFL	2.61	460
7	M65	PIFA	UFL	2.01	720

Note:

- 1) Ant. No.1~3 will be used with Wi-Fi on board antenna.
Ant. No.1 with highest gain and No.3 with longest cable were selected for final testing.
- 2) Ant. No.4~7 will be used with Wi-Fi external antennas.
Ant. No.6 with highest gain and No.4 with longest cable were selected for final testing.

1.1.3 Power Supply Type of Equipment under Test (EUT)

Power Supply Type	5Vdc from host
--------------------------	----------------

1.1.4 Accessories

N/A

1.1.5 Channel List

Frequency band (MHz)				2400~2483.5			
Channel	Frequency (MHz)	Channel	Frequency (MHz)	Channel	Frequency (MHz)	Channel	Frequency (MHz)
37	2402	9	2422	18	2442	28	2462
0	2404	10	2424	19	2444	29	2464
1	2406	38	2426	20	2446	30	2466
2	2408	11	2428	21	2448	31	2468
3	2410	12	2430	22	2450	32	2470
4	2412	13	2432	23	2452	33	2472
5	2414	14	2434	24	2454	34	2474
6	2416	15	2436	25	2456	35	2476
7	2418	16	2438	26	2458	36	2478
8	2420	17	2440	27	2460	39	2480

1.1.6 Test Tool and Duty Cycle

Test tool	Blue Tool, V1.8.8.6
Duty cycle of test signal (%)	66.74%
Duty Factor (dB)	1.76

1.1.7 Power Setting

Modulation Mode	Test Frequency (MHz)		
	2402	2440	2480
GFSK/1Mbps	Default	Default	Default

1.2 Local Support Equipment List

Support Equipment List					
No.	Equipment	Brand	Model	FCC ID	Signal cable / Length (m)
1	Notebook	DELL	Latitude E6440	DoC	USB, 1m non-shielded.

1.3 Test Setup Chart

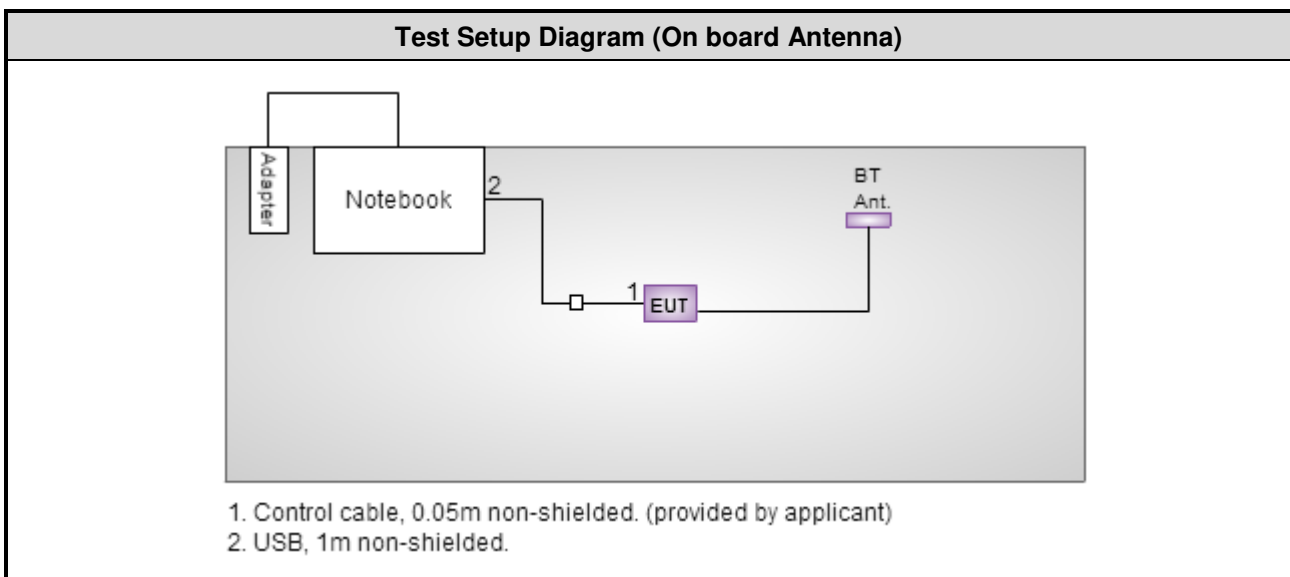

Note: The distance between Wi-Fi antenna and BT antenna is 40cm.

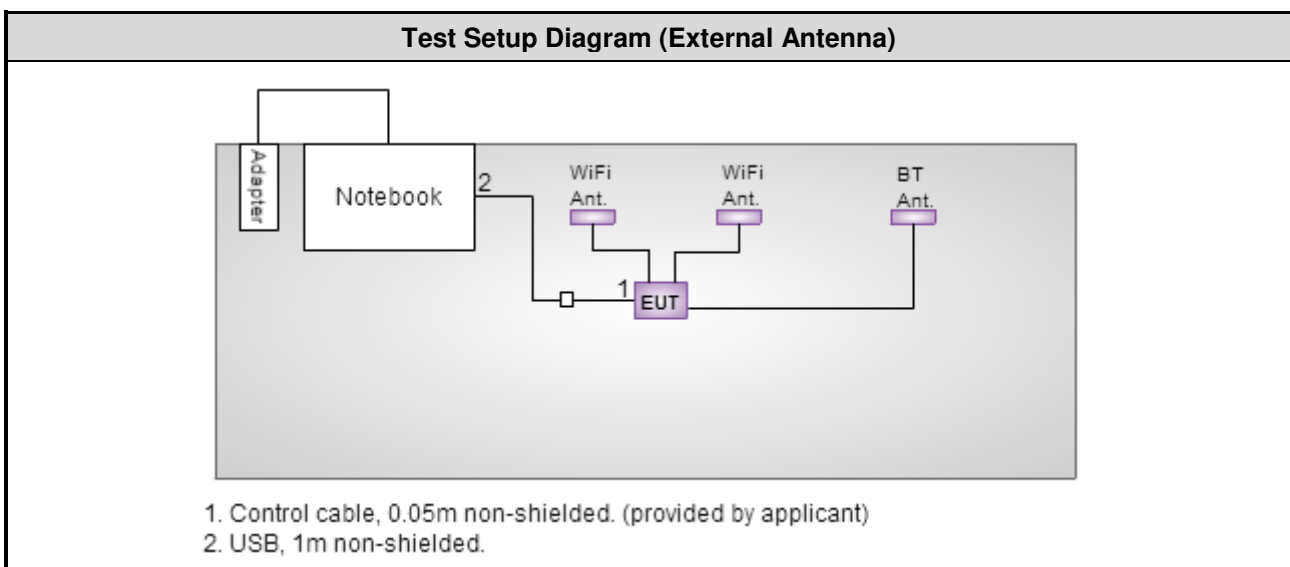

Note:

- 1) The distance between 2 Wi-Fi antennas is 15cm.
- 2) The distance between Wi-Fi antenna and BT antenna is 40cm.

1.4 Test Equipment List and Calibration Data

Test Item	Conducted Emission				
Test Site	Conduction room 1 / (CO01-WS)				
Instrument	Manufacturer	Model No.	Serial No.	Calibration Date	Calibration Until
EMC Receiver	R&S	ESCS 30	100169	Oct. 21, 2015	Oct. 20, 2016
LISN	SCHWARZBECK	Schwarzbeck 8127	8127-667	Nov. 13, 2015	Nov. 12, 2016
LISN (Support Unit)	SCHWARZBECK	Schwarzbeck 8127	8127-666	Nov. 26, 2015	Nov. 25, 2016
RF Cable-CON	EMC	EMCCFD300-BM-BM-6000	50821	Dec. 21, 2015	Dec. 20, 2016
50 ohm terminal (Support Unit)	NA	50	04	Apr. 15, 2015	Apr. 14, 2016
Measurement Software	AUDIX	e3	6.120210k	NA	NA

Note: Calibration Interval of instruments listed above is one year.

Test Item	Radiated Emission				
Test Site	966 chamber1 / (03CH01-WS)				
Instrument	Manufacturer	Model No.	Serial No.	Calibration Date	Calibration Until
Spectrum Analyzer	R&S	FSV40	101498	Dec. 13, 2015	Dec. 12, 2016
Receiver	R&S	ESR3	101658	Nov. 04, 2015	Nov. 03, 2016
Bilog Antenna	SCHWARZBECK	VULB9168	VULB9168-522	Aug. 20, 2015	Aug. 19, 2016
Horn Antenna 1G-18G	SCHWARZBECK	BBHA 9120 D	BBHA 9120 D 1096	Dec. 16, 2015	Dec. 15, 2016
Horn Antenna 18G-40G	SCHWARZBECK	BBHA 9170	BBHA 9170517	Nov. 04, 2015	Nov. 03, 2016
Loop Antenna	R&S	HFH2-Z2	11900	Nov. 16, 2015	Nov. 15, 2016
Loop Antenna Cable	KOAX KABEL	101354-BW	101354-BW	Dec. 10, 2015	Dec. 09, 2016
Preamplifier	Burgeon	BPA-530	SN:100219	Sep. 10, 2015	Sep. 09, 2016
Preamplifier	Agilent	83017A	MY39501308	Oct. 02, 2015	Oct. 01, 2016
Preamplifier	EMC	EMC184045B	980192	Sep. 01, 2015	Aug. 31, 2016
RF Cable	HUBER+SUHNER	SUCOFLEX104	MY16014/4	Dec. 10, 2015	Dec. 09, 2016
RF Cable	HUBER+SUHNER	SUCOFLEX104	MY16019/4	Dec. 10, 2015	Dec. 09, 2016
RF Cable	HUBER+SUHNER	SUCOFLEX104	MY16139/4	Dec. 10, 2015	Dec. 09, 2016
LF cable 3M	Woken	CFD400NL-LW	CFD400NL-001	Dec. 10, 2015	Dec. 09, 2016
LF cable 10M	Woken	CFD400NL-LW	CFD400NL-002	Dec. 10, 2015	Dec. 09, 2016
Measurement Software	AUDIX	e3	6.120210g	NA	NA

Note: Calibration Interval of instruments listed above is one year.

Test Item	RF Conducted				
Test Site	(TH01-WS)				
Instrument	Manufacturer	Model No.	Serial No.	Calibration Date	Calibration Until
Spectrum Analyzer	R&S	FSV40	101063	Feb. 03, 2015	Feb. 02, 2016
Power Meter	Anritsu	ML2495A	1241002	Sep. 21, 2015	Sep. 20, 2016
Power Sensor	Anritsu	MA2411B	1207366	Sep. 21, 2015	Sep. 20, 2016
Measurement Software	Sporton	Sporton_1	1.3.30	NA	NA

Note: Calibration Interval of instruments listed above is one year.

1.5 Test Standards

According to the specification of EUT, the EUT must comply with following standards and KDB documents.

47 CFR FCC Part 15.247

ANSI C63.10-2013

FCC KDB 558074 D01 DTS Meas Guidance v03r04

1.6 Measurement Uncertainty

ISO/IEC 17025 requires that an estimate of the measurement uncertainties associated with the emissions test results be included in the report. The measurement uncertainties given below are based on a 95% confidence level (based on a coverage factor ($k=2$))

Measurement Uncertainty	
Parameters	Uncertainty
Bandwidth	± 34.134 Hz
Conducted power	± 0.808 dB
Power density	± 0.463 dB
Conducted emission	± 2.670 dB
AC conducted emission	± 2.90 dB
Radiated emission ≤ 1 GHz	± 3.66 dB
Radiated emission > 1 GHz	± 5.63 dB

2 Test Configuration

2.1 Testing Condition

Test Item	Test Site	Ambient Condition	Tested By
AC Conduction	CO01-WS	17°C / 59%	Sky Huang
Radiated Emissions	03CH01-WS	18-23°C / 60-64%	Warren Lee Aska Huang
RF Conducted	TH01-WS	22°C / 64%	Alex Huang

➤ FCC site registration No.: 657002

➤ IC site registration No.: 10807A-1

2.2 The Worst Test Modes and Channel Details

Test item	Mode	Test Frequency (MHz)	Data Rate	Test Configuration
AC Power Line Conducted Emissions	BT LE	2402	1Mbps	1, 3
Radiated Emissions ≤ 1GHz	BT LE	2402	1Mbps	1, 2, 3, 4
Radiated Emissions > 1GHz	BT LE	2402, 2440, 2480	1Mbps	1, 3
Maximum Output Power	BT LE	2402, 2440, 2480	1Mbps	3
6dB bandwidth				
Power spectral density				

NOTE:

- The EUT and its antenna were pretested with 3 orientations placed on the table for the radiated emission measurement – X, Y, and Z-plane. The worst case for EUT and its antenna were listed below and were shown in this report.
- The following antennas are selected for final testing as below configurations:
For antennas equipped with Wi-Fi on board antenna: EUT: X-plane, Antenna: X-plane
 - Configuration 1: Ant. No.1 with highest gain (model DHUB-W69_BT_81.EEW15.GLC)
 - Configuration 2: Ant. No.3 with longest (model DHUB-W69_BT_81.EEW15.GLF)**For antennas equipped with Wi-Fi on external antennas:** EUT: X-plane, Antenna: Y-plane
 - Configuration 3: Ant. No.6 with highest gain (model M55)
 - Configuration 4: Ant. No.4 with longest cable (model E48u)

3 Transmitter Test Results

3.1 Conducted Emissions

3.1.1 Limit of Conducted Emissions

Conducted Emissions Limit		
Frequency Emission (MHz)	Quasi-Peak	Average
0.15-0.5	66 - 56 *	56 - 46 *
0.5-5	56	46
5-30	60	50

Note 1: * Decreases with the logarithm of the frequency.

3.1.2 Test Procedures

1. The device is placed on a test table, raised 80 cm above the reference ground plane. The vertical conducting plane is located 40 cm to the rear of the device.
2. The device is connected to line impedance stabilization network (LISN) and other accessories are connected to other LISN. Measured levels of AC power line conducted emission are across the 50 Ω LISN port.
3. AC conducted emission measurements is made over frequency range from 150 kHz to 30 MHz.
4. This measurement was performed with AC 120V/60Hz

3.1.3 Test Setup

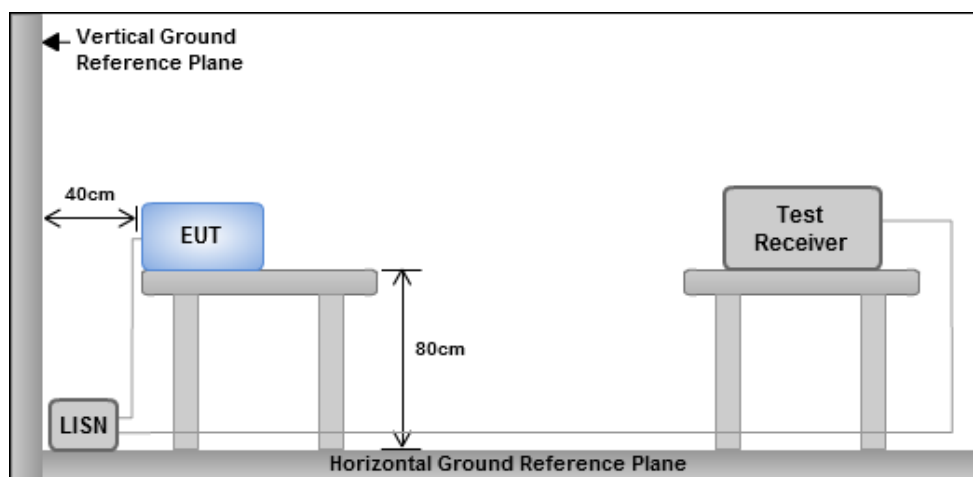

Note: 1. Support units were connected to second LISN.

2. Both of LISNs (AMN) are 80 cm from EUT and at least 80 cm from other units and other metal planes

3.1.4 Test Result of Conducted Emissions

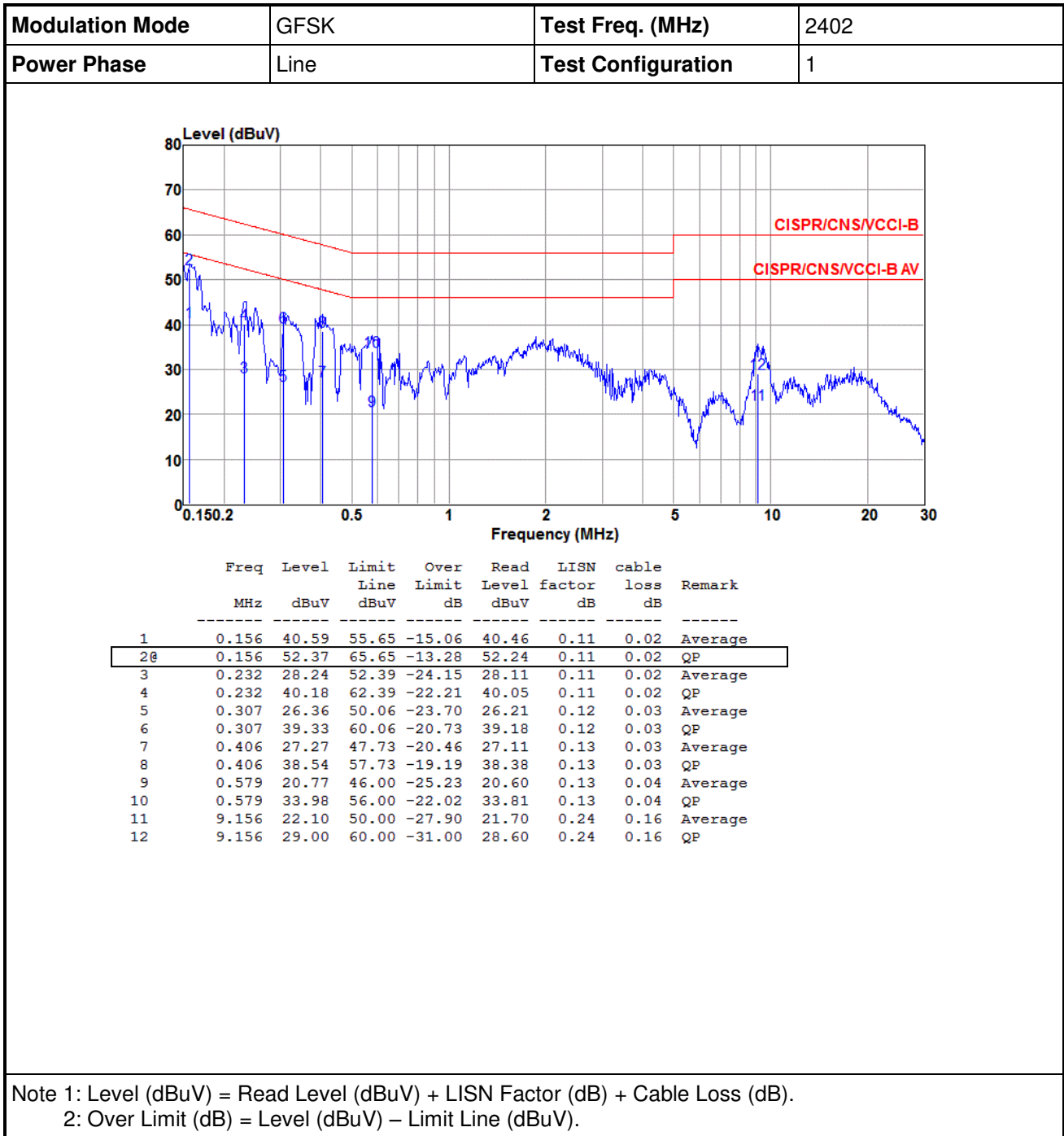

Modulation Mode	GFSK	Test Freq. (MHz)	2402
Power Phase	Neutral	Test Configuration	1

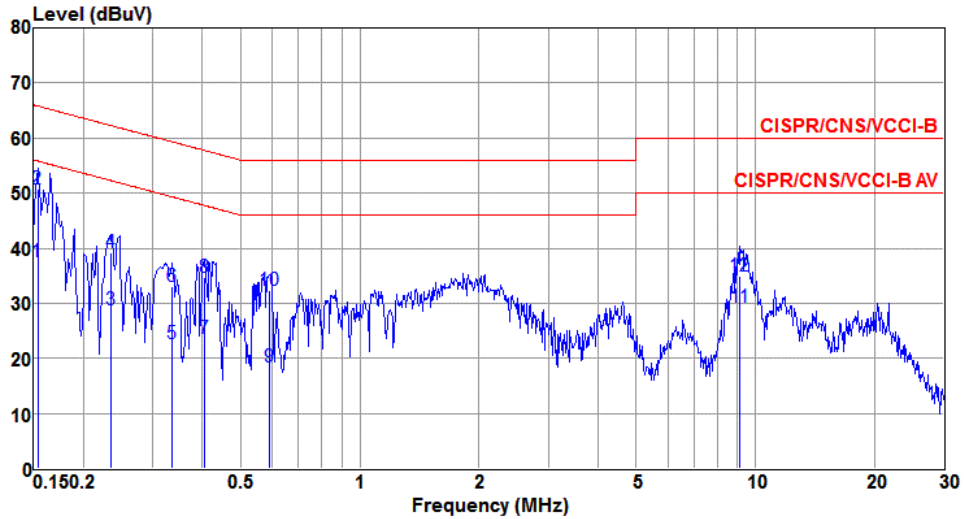

	Freq MHz	Level dBuV	Limit Line dBuV	Over Limit dB	Read Level dBuV	LISN factor dB	cable loss dB	Remark
1	0.153	37.65	55.82	-18.17	37.50	0.13	0.02	Average
2@	0.153	50.65	65.82	-15.17	50.50	0.13	0.02	QP
3	0.234	28.89	52.30	-23.41	28.76	0.11	0.02	Average
4	0.234	39.26	62.30	-23.04	39.13	0.11	0.02	QP
5	0.336	22.66	49.31	-26.65	22.50	0.13	0.03	Average
6	0.336	33.03	59.31	-26.28	32.87	0.13	0.03	QP
7	0.404	23.69	47.77	-24.08	23.52	0.14	0.03	Average
8	0.404	34.69	57.77	-23.08	34.52	0.14	0.03	QP
9	0.592	18.48	46.00	-27.52	18.30	0.14	0.04	Average
10	0.592	32.41	56.00	-23.59	32.23	0.14	0.04	QP
11	9.156	29.39	50.00	-20.61	28.97	0.26	0.16	Average
12	9.156	34.87	60.00	-25.13	34.45	0.26	0.16	QP

Note 1: Level (dBuV) = Read Level (dBuV) + LISN Factor (dB) + Cable Loss (dB).
 2: Over Limit (dB) = Level (dBuV) – Limit Line (dBuV).

Modulation Mode	GFSK	Test Freq. (MHz)	2402
Power Phase	Line	Test Configuration	3

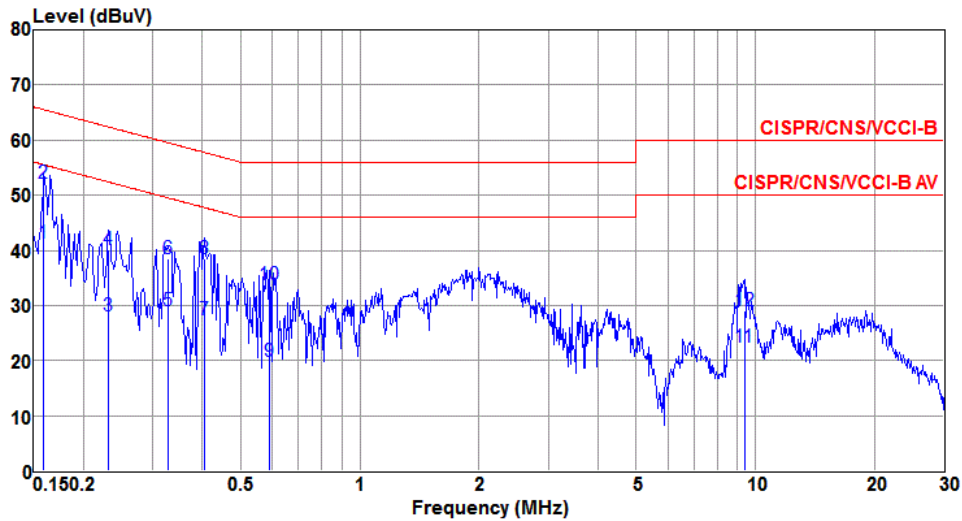

	Freq MHz	Level dBuV	Limit Line dBuV	Over Limit dB	Read Level dBuV	LISN factor dB	cable loss dB	Remark
1	0.159	41.38	55.52	-14.14	41.25	0.11	0.02	Average
2@	0.159	52.11	65.52	-13.41	51.98	0.11	0.02	QP
3	0.232	28.18	52.39	-24.21	28.05	0.11	0.02	Average
4	0.232	40.24	62.39	-22.15	40.11	0.11	0.02	QP
5	0.327	28.96	49.53	-20.57	28.81	0.12	0.03	Average
6	0.327	38.52	59.53	-21.01	38.37	0.12	0.03	QP
7	0.406	27.27	47.73	-20.46	27.11	0.13	0.03	Average
8	0.406	38.54	57.73	-19.19	38.38	0.13	0.03	QP
9	0.592	19.85	46.00	-26.15	19.68	0.13	0.04	Average
10	0.592	33.78	56.00	-22.22	33.61	0.13	0.04	QP
11	9.401	22.32	50.00	-27.68	21.92	0.24	0.16	Average
12	9.401	28.92	60.00	-31.08	28.52	0.24	0.16	QP

Note 1: Level (dBuV) = Read Level (dBuV) + LISN Factor (dB) + Cable Loss (dB).
 2: Over Limit (dB) = Level (dBuV) – Limit Line (dBuV).

Modulation Mode	GFSK	Test Freq. (MHz)	2402
Power Phase	Neutral	Test Configuration	3

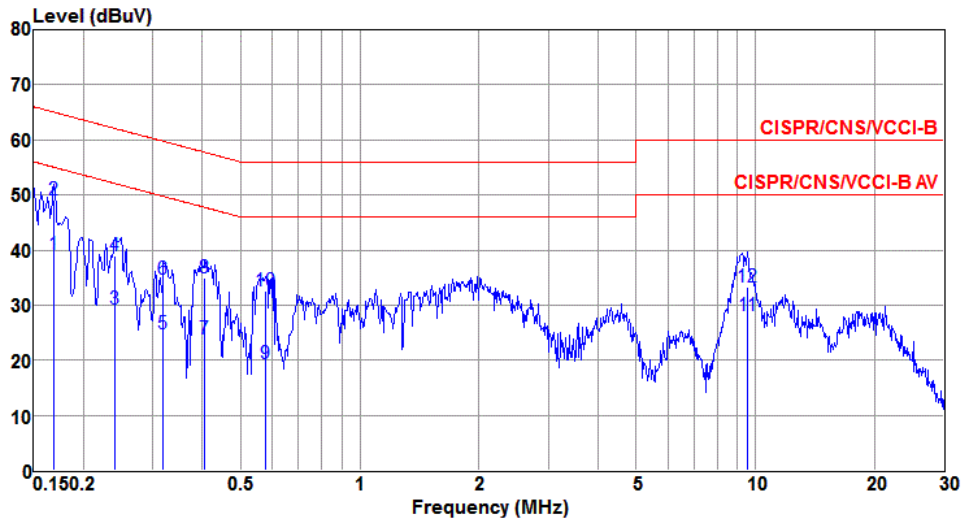

	Freq MHz	Level dBuV	Limit Line dBuV	Over Limit dB	Read Level dBuV	LISN factor dB	cable loss dB	Remark
1	0.169	39.07	55.03	-15.96	38.93	0.12	0.02	Average
2②	0.169	49.09	65.03	-15.94	48.95	0.12	0.02	QP
3	0.240	29.20	52.08	-22.88	29.07	0.11	0.02	Average
4	0.240	38.99	62.08	-23.09	38.86	0.11	0.02	QP
5	0.318	24.90	49.75	-24.85	24.74	0.13	0.03	Average
6	0.318	34.81	59.75	-24.94	34.65	0.13	0.03	QP
7	0.406	23.95	47.73	-23.78	23.78	0.14	0.03	Average
8	0.406	34.91	57.73	-22.82	34.74	0.14	0.03	QP
9	0.579	19.34	46.00	-26.66	19.16	0.14	0.04	Average
10	0.579	32.61	56.00	-23.39	32.43	0.14	0.04	QP
11	9.552	27.99	50.00	-22.01	27.57	0.26	0.16	Average
12	9.552	33.37	60.00	-26.63	32.95	0.26	0.16	QP

Note 1: Level (dBuV) = Read Level (dBuV) + LISN Factor (dB) + Cable Loss (dB).
 2: Over Limit (dB) = Level (dBuV) – Limit Line (dBuV).

3.2 6dB and Occupied Bandwidth

3.2.1 Limit of 6dB Bandwidth

The minimum 6dB bandwidth shall be at least 500 kHz.

3.2.2 Test Procedures

6dB Bandwidth

1. Set resolution bandwidth (RBW) = 100 kHz, Video bandwidth = 300 kHz.
2. Detector = Peak, Trace mode = max hold.
3. Sweep = auto couple, Allow the trace to stabilize.
4. Measure the maximum width of the emission that is constrained by the frequencies associated with the two outermost amplitude points (upper and lower) that are attenuated by 6dB relative to the maximum level measured in the fundamental emission.

Occupied Bandwidth

1. Set resolution bandwidth (RBW) = 30 kHz, Video bandwidth = 100 kHz.
2. Detector = Sample, Trace mode = max hold.
3. Sweep = auto couple, Allow the trace to stabilize.
4. Use the OBW measurement function of spectrum analyzer to measure the occupied bandwidth.

3.2.3 Test Setup

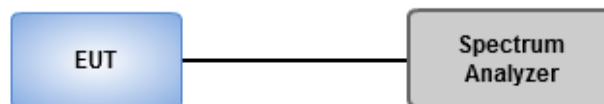

3.2.4 Test Result of 6dB and Occupied Bandwidth

Mode	Freq. (MHz)	6dB Bandwidth (MHz)	99% Occupied Bandwidth (MHz)	Limit of 6dB Bandwidth (kHz)
BT LE	2402	0.709	1.05	500
BT LE	2440	0.713	1.05	500
BT LE	2480	0.709	1.05	500

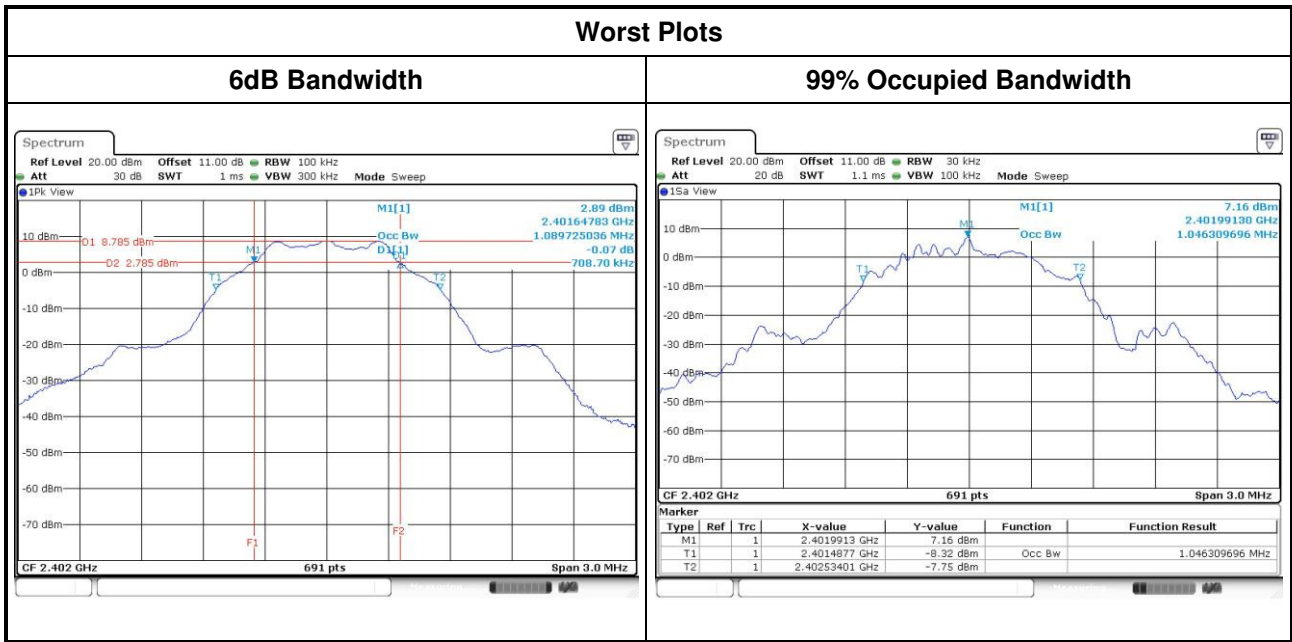

3.3 RF Output Power

3.3.1 Limit of RF Output Power

Conducted power shall not exceed 1Watt.

- Antenna gain \leq 6dBi, no any corresponding reduction is in output power limit.
- Antenna gain $>$ 6dBi
 - Non Fixed, point to point operations.
The conducted output power from the intentional radiator shall be reduced by the amount in dB that the directional gain of the antenna exceeds 6 dB
 - Fixed, point to point operations
Systems operating in the 2400–2483.5 MHz band that are used exclusively for fixed, point-to-point Operations, maximum peak output power of the intentional radiator is reduced by 1 dB for every 3 dB that the directional gain of the antenna exceeds 6 dBi.

Systems operating in the 5725–5850 MHz band that are used exclusively for fixed, point-to-point operations ,no any corresponding reduction is in transmitter peak output power

3.3.2 Test Procedures

- Maximum Peak Conducted Output Power
 - Spectrum analyzer**
 1. Set RBW = 1MHz, VBW = 3MHz, Detector = Peak.
 2. Sweep time = auto, Trace mode = max hold, Allow trace to fully stabilize.
 3. Use the spectrum analyzer channel power measurement function with the band limits set equal to the DTS bandwidth edges.
 - Power meter**
 1. A broadband Peak RF power meter is used for output power measurement. The video bandwidth of power meter is greater than DTS bandwidth of EUT. If duty cycle of test signal is not 100 %, trigger and gating function of power meter will be enabled to capture transmission burst for measuring output power.
- Maximum Conducted Average Output Power (For reference only)
 - Power meter**
 1. A broadband Average RF power meter is used for output power measurement. The video bandwidth of power meter is greater than DTS bandwidth of EUT. If duty cycle of test signal is not 100 %, trigger and gating function of power meter will be enabled to capture transmission burst for measuring output power.

3.3.3 Test Setup

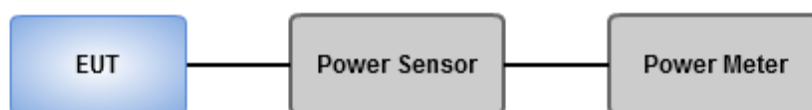

3.3.4 Test Result of Maximum Output Power

Mode	Freq. (MHz)	Peak Power			Antenna gain (dBi)	EIRP (dBm)	EIRP Limit (dBm)
		Power (mW)	Power (dBm)	Limit (dBm)			
BT LE	2402	8.670	9.38	30	2.61	11.99	36
BT LE	2440	8.590	9.34	30	2.61	11.95	36
BT LE	2480	6.397	8.06	30	2.61	10.67	36

Mode	Freq. (MHz)	AV Power (mW)	AV Power (dBm)	Limit (dBm)
BT LE	2402	8.356	9.22	---
BT LE	2440	8.222	9.15	---
BT LE	2480	6.081	7.84	---

Note: Average power is for reference only

3.4 Power Spectral Density

3.4.1 Limit of Power Spectral Density

Power spectral density shall not be greater than 8 dBm in any 3 kHz band.

3.4.2 Test Procedures

- Maximum peak conducted output power was used to demonstrate compliance to the fundamental output power limit.
 1. Set the RBW = 3kHz, VBW = 10kHz.
 2. Detector = Peak, Sweep time = auto couple.
 3. Trace mode = max hold, allow trace to fully stabilize.
 4. Use the peak marker function to determine the maximum amplitude level.
- Maximum (average) conducted output power was used to demonstrate compliance to the fundamental output power limit.
 1. Set the RBW = 100kHz, VBW = 300 kHz.
 2. Detector = RMS, Sweep time = auto couple.
 3. Set the sweep time to: $\geq 10 \times (\text{number of measurement points in sweep}) \times (\text{maximum data rate per stream})$.
 4. Perform the measurement over a single sweep.
 5. Use the peak marker function to determine the maximum amplitude level.\

3.4.3 Test Setup

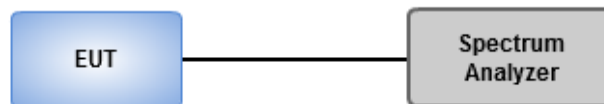

3.4.4 Test Result of Power Spectral Density

Mode	Freq. (MHz)	Total Power Spectral Density (dBm/3kHz)	Limit (dBm/3kHz)
BT LE	2402	-4.51	8
BT LE	2440	-4.82	8
BT LE	2480	-6.10	8

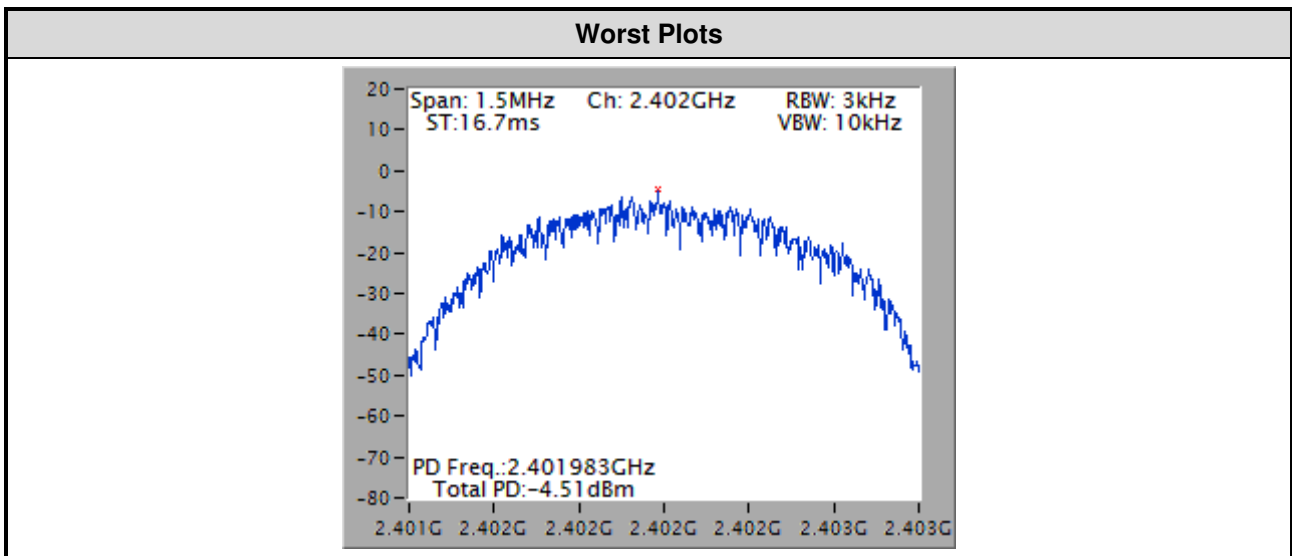

3.5 Emissions in Restricted Frequency Bands

3.5.1 Limit of Emissions in Restricted Frequency Bands

Restricted Band Emissions Limit			
Frequency Range (MHz)	Field Strength (uV/m)	Field Strength (dBuV/m)	Measure Distance (m)
0.009~0.490	2400/F(kHz)	48.5 - 13.8	300
0.490~1.705	24000/F(kHz)	33.8 - 23	30
1.705~30.0	30	29	30
30~88	100	40	3
88~216	150	43.5	3
216~960	200	46	3
Above 960	500	54	3

Note 1:
Quasi-Peak value is measured for frequency below 1GHz except for 9–90 kHz, 110–490 kHz frequency band. Peak and average value are measured for frequency above 1GHz. The limit on average radio frequency emission is as above table. The limit on peak radio frequency emissions is 20 dB above the maximum permitted average emission limit

Note 2:
Measurements may be performed at a distance other than what is specified provided. When performing measurements at a distance other than that specified, the results shall be extrapolated to the specified distance using an extrapolation factor as below, Frequency at or above 30 MHz: 20 dB/decade Frequency below 30 MHz: 40 dB/decade.

3.5.2 Test Procedures

1. Measurement is made at a semi-anechoic chamber that incorporates a turntable allowing a EUT rotation of 360°. A continuously-rotating, remotely-controlled turntable is installed at the test site to support the EUT and facilitate determination of the direction of maximum radiation for each EUT emission frequency. The EUT is placed at test table. For emissions testing at or below 1 GHz, the table height is 80 cm above the reference ground plane. For emission measurements above 1 GHz, the table height is 1.5 m
2. Measurement is made with the antenna positioned in both the horizontal and vertical planes of polarization. The measurement antenna is varied in height (1m ~ 4m) above the reference ground plane to obtain the maximum signal strength. Distance between EUT and antenna is 3 m.
3. This investigation is performed with the EUT rotated 360°, the antenna height scanned between 1 m and 4 m, and the antenna rotated to repeat the measurements for both the horizontal and vertical antenna polarizations.

Note:

1. 120kHz measurement bandwidth of test receiver and Quasi-peak detector is for radiated emission below 1GHz.
2. RBW=1MHz, VBW=3MHz and Peak detector is for peak measured value of radiated emission above 1GHz.
3. RBW=1MHz, VBW=1/T and Peak detector is for average measured value of radiated emission above 1GHz.

3.5.3 Test Setup

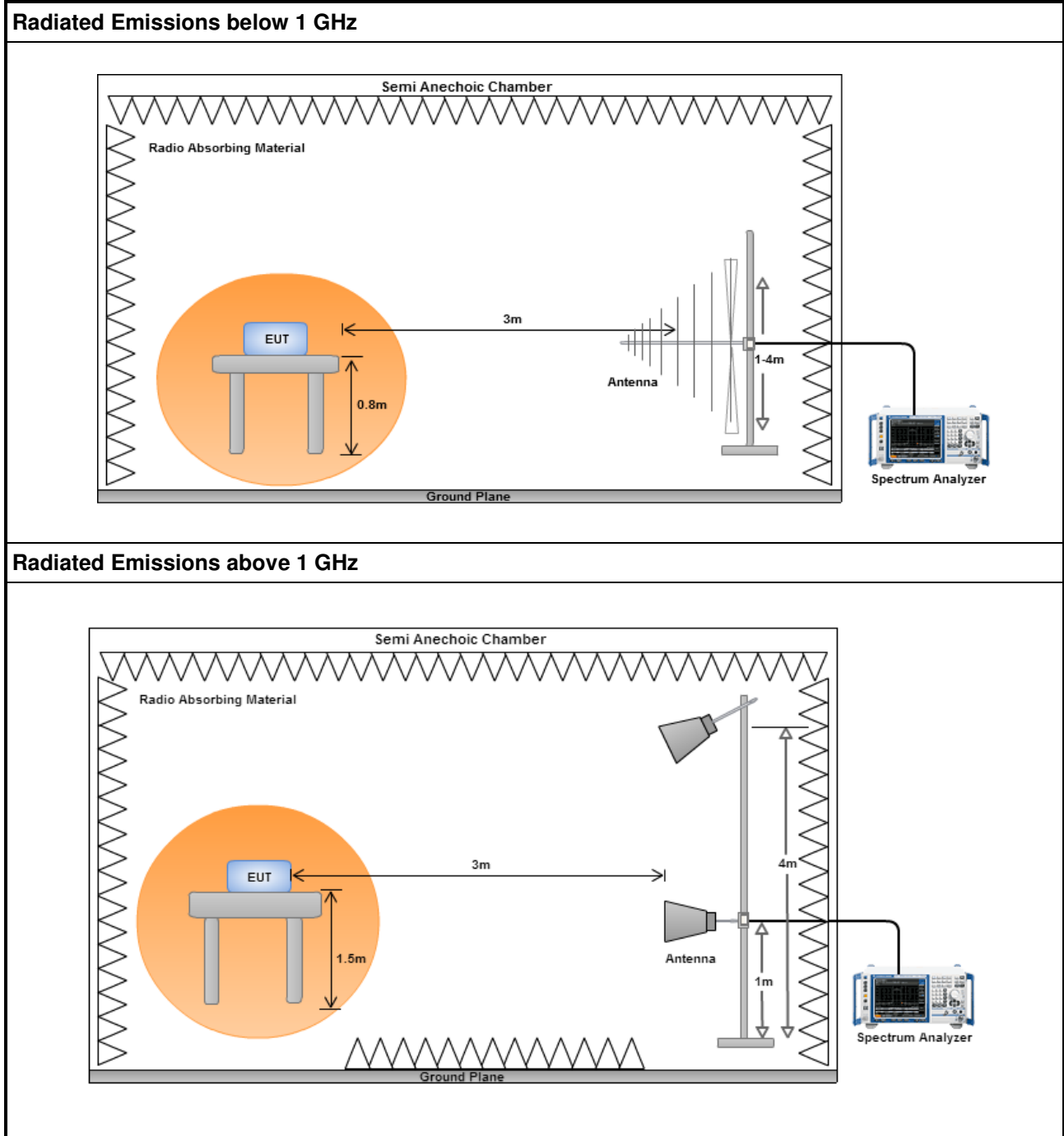

3.5.4 Transmitter Radiated Unwanted Emissions (Below 1GHz)

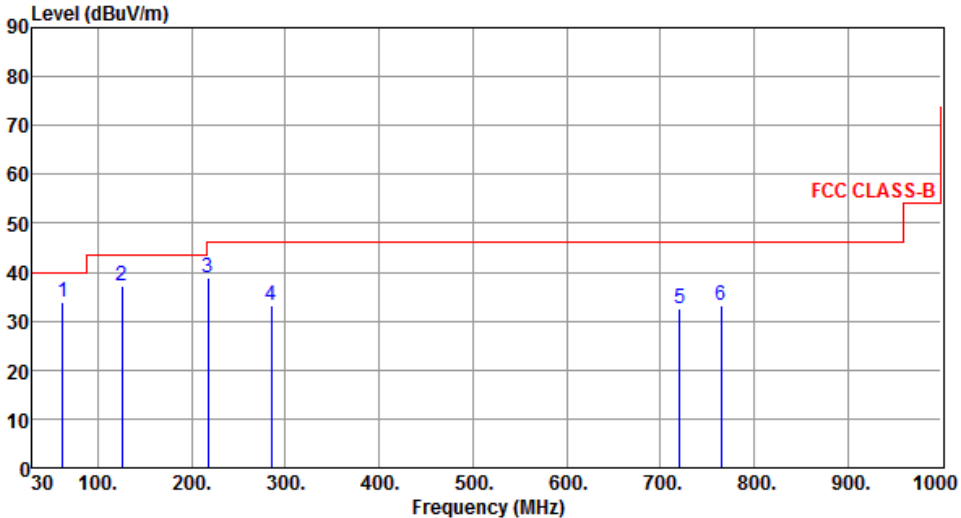
Modulation	GFSK	Test Freq. (MHz)	2402																																																																								
Polarization	Horizontal	Test Configuration	1																																																																								
 <p>The graph plots Level (dBuV/m) on the y-axis (0 to 90) against Frequency (MHz) on the x-axis (30 to 1000). A red line represents the FCC CLASS-B limit, which is 40 dBuV/m from 30 to 100 MHz, 45 dBuV/m from 100 to 200 MHz, and 50 dBuV/m from 200 to 1000 MHz. Six blue vertical lines represent emission peaks labeled 1 through 6, with their levels and frequencies detailed in the table below.</p>																																																																											
	<table border="1"> <thead> <tr> <th>Freq.</th> <th>Emission level</th> <th>Limit</th> <th>Margin</th> <th>SA reading</th> <th>Factor</th> <th>Remark</th> <th>ANT High cm</th> <th>Turn Table deg</th> </tr> <tr> <th>MHz</th> <th>dBuV/m</th> <th>dBuV/m</th> <th>dB</th> <th>dBuV</th> <th>dB</th> <th></th> <th></th> <th></th> </tr> </thead> <tbody> <tr> <td>1</td> <td>62.62</td> <td>33.99</td> <td>40.00</td> <td>-6.01</td> <td>51.98</td> <td>-17.99</td> <td>Peak</td> <td>---</td> </tr> <tr> <td>2</td> <td>125.35</td> <td>37.27</td> <td>43.50</td> <td>-6.23</td> <td>55.66</td> <td>-18.39</td> <td>Peak</td> <td>---</td> </tr> <tr> <td>3</td> <td>217.72</td> <td>38.83</td> <td>46.00</td> <td>-7.17</td> <td>57.92</td> <td>-19.09</td> <td>Peak</td> <td>---</td> </tr> <tr> <td>4</td> <td>285.04</td> <td>33.27</td> <td>46.00</td> <td>-12.73</td> <td>49.54</td> <td>-16.27</td> <td>Peak</td> <td>---</td> </tr> <tr> <td>5</td> <td>720.52</td> <td>32.58</td> <td>46.00</td> <td>-13.42</td> <td>40.19</td> <td>-7.61</td> <td>Peak</td> <td>---</td> </tr> <tr> <td>6</td> <td>765.10</td> <td>33.09</td> <td>46.00</td> <td>-12.91</td> <td>39.90</td> <td>-6.81</td> <td>Peak</td> <td>---</td> </tr> </tbody> </table>	Freq.	Emission level	Limit	Margin	SA reading	Factor	Remark	ANT High cm	Turn Table deg	MHz	dBuV/m	dBuV/m	dB	dBuV	dB				1	62.62	33.99	40.00	-6.01	51.98	-17.99	Peak	---	2	125.35	37.27	43.50	-6.23	55.66	-18.39	Peak	---	3	217.72	38.83	46.00	-7.17	57.92	-19.09	Peak	---	4	285.04	33.27	46.00	-12.73	49.54	-16.27	Peak	---	5	720.52	32.58	46.00	-13.42	40.19	-7.61	Peak	---	6	765.10	33.09	46.00	-12.91	39.90	-6.81	Peak	---		
Freq.	Emission level	Limit	Margin	SA reading	Factor	Remark	ANT High cm	Turn Table deg																																																																			
MHz	dBuV/m	dBuV/m	dB	dBuV	dB																																																																						
1	62.62	33.99	40.00	-6.01	51.98	-17.99	Peak	---																																																																			
2	125.35	37.27	43.50	-6.23	55.66	-18.39	Peak	---																																																																			
3	217.72	38.83	46.00	-7.17	57.92	-19.09	Peak	---																																																																			
4	285.04	33.27	46.00	-12.73	49.54	-16.27	Peak	---																																																																			
5	720.52	32.58	46.00	-13.42	40.19	-7.61	Peak	---																																																																			
6	765.10	33.09	46.00	-12.91	39.90	-6.81	Peak	---																																																																			
<p>Note 1: Emission Level (dBuV/m) = SA Reading (dBuV/m) + Factor* (dB) *Factor includes antenna factor , cable loss and amplifier gain Note 2: Margin (dB) = Emission level (dBuV/m) – Limit (dBuV/m). Note 3: All spurious emissions below 30MHz are more than 20 dB below the limit.</p>																																																																											

Modulation	GFSK	Test Freq. (MHz)	2402
Polarization	Vertical	Test Configuration	1

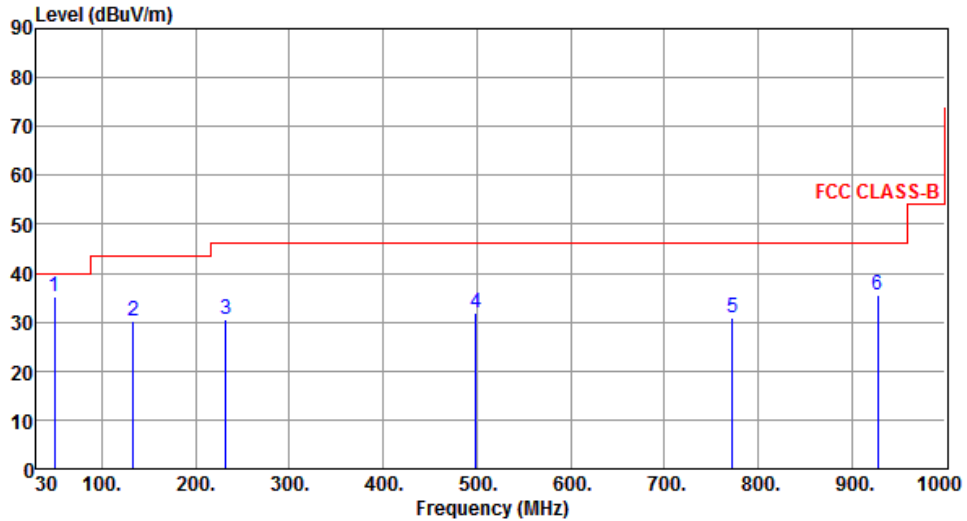

	Freq. MHz	Emission level dBuV/m	Limit dBuV/m	Margin dB	SA reading dBuV	Factor dB	Remark	ANT High cm	Turn Table deg
1	49.27	35.33	40.00	-4.67	51.68	-16.35	Peak	---	---
2	133.73	30.15	43.50	-13.35	47.77	-17.62	Peak	---	---
3	232.29	30.57	46.00	-15.43	49.01	-18.44	Peak	---	---
4	499.27	31.75	46.00	-14.25	42.88	-11.13	Peak	---	---
5	772.57	30.75	46.00	-15.25	37.49	-6.74	Peak	---	---
6	927.57	35.47	46.00	-10.53	40.28	-4.81	Peak	---	---

Note 1: Emission Level (dBuV/m) = SA Reading (dBuV/m) + Factor* (dB)

*Factor includes antenna factor , cable loss and amplifier gain

Note 2: Margin (dB) = Emission level (dBuV/m) – Limit (dBuV/m).

Note 3: All spurious emissions below 30MHz are more than 20 dB below the limit.

Modulation	GFSK	Test Freq. (MHz)	2402
Polarization	Horizontal	Test Configuration	2

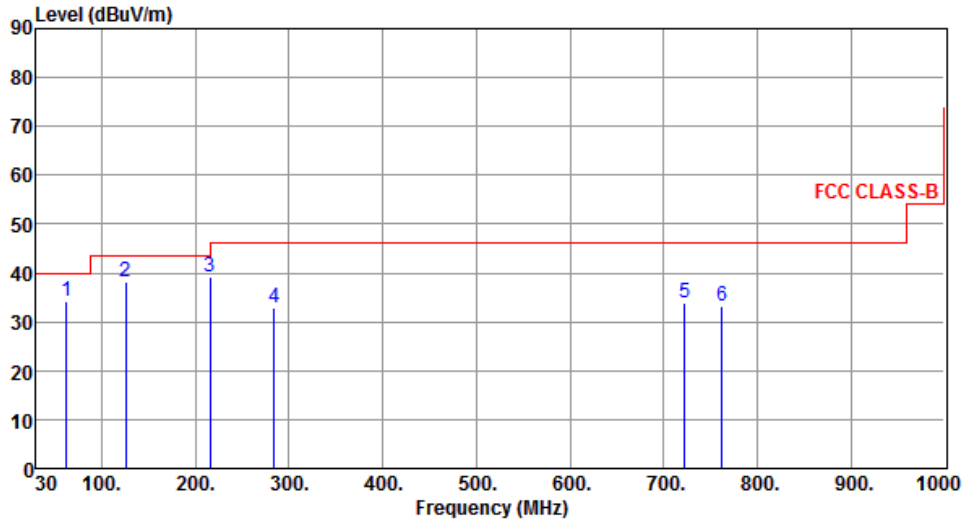

	Freq. MHz	Emission level dBuV/m	Limit dBuV/m	Margin dB	SA reading dBuV	Factor dB	Remark	ANT High cm	Turn Table deg
1	62.53	34.24	40.00	-5.76	52.21	-17.97	Peak	---	---
2	125.22	38.14	43.50	-5.36	56.54	-18.40	Peak	---	---
3	215.43	39.16	43.50	-4.34	58.33	-19.17	Peak	---	---
4	284.31	32.96	46.00	-13.04	49.25	-16.29	Peak	---	---
5	722.31	33.88	46.00	-12.12	41.43	-7.55	Peak	---	---
6	762.54	33.13	46.00	-12.87	39.95	-6.82	Peak	---	---

Note 1: Emission Level (dBuV/m) = SA Reading (dBuV/m) + Factor* (dB)

*Factor includes antenna factor, cable loss and amplifier gain

Note 2: Margin (dB) = Emission level (dBuV/m) – Limit (dBuV/m).

Note 3: All spurious emissions below 30MHz are more than 20 dB below the limit.

Modulation	GFSK	Test Freq. (MHz)	2402
Polarization	Vertical	Test Configuration	2

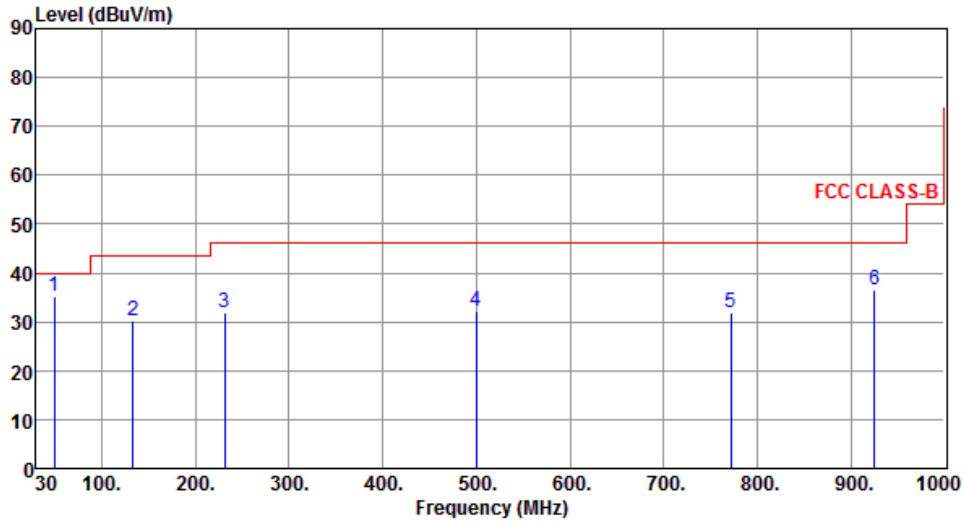

	Freq. MHz	Emission level dBuV/m	Limit dBuV/m	Margin dB	SA reading dBuV	Factor dB	Remark	ANT High cm	Turn Table deg
1	49.53	35.09	40.00	-4.91	51.44	-16.35	Peak	---	---
2	133.25	30.20	43.50	-13.30	47.87	-17.67	Peak	---	---
3	231.32	31.88	46.00	-14.12	50.38	-18.50	Peak	---	---
4	499.72	32.25	46.00	-13.75	43.38	-11.13	Peak	---	---
5	771.59	31.78	46.00	-14.22	38.53	-6.75	Peak	---	---
6	925.43	36.60	46.00	-9.40	41.44	-4.84	Peak	---	---

Note 1: Emission Level (dBuV/m) = SA Reading (dBuV/m) + Factor* (dB)

*Factor includes antenna factor , cable loss and amplifier gain

Note 2: Margin (dB) = Emission level (dBuV/m) – Limit (dBuV/m).

Note 3: All spurious emissions below 30MHz are more than 20 dB below the limit.

Modulation	GFSK	Test Freq. (MHz)	2402
Polarization	Horizontal	Test Configuration	3

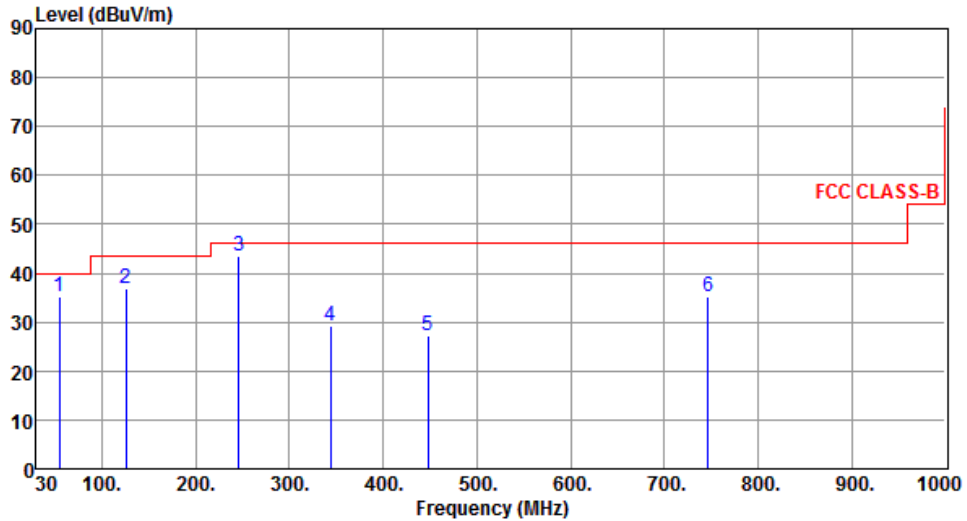

	Freq. MHz	Emission level dBuV/m	Limit dBuV/m	Margin dB	SA reading dBuV	Factor dB	Remark	ANT High cm	Turn Table deg
1	54.25	35.36	40.00	-4.64	52.21	-16.85	Peak	---	---
2	126.03	36.79	43.50	-6.71	55.13	-18.34	Peak	---	---
3	246.31	43.59	46.00	-2.41	61.39	-17.80	Peak	---	---
4	344.28	29.37	46.00	-16.63	44.28	-14.91	Peak	---	---
5	448.07	27.21	46.00	-18.79	39.42	-12.21	Peak	---	---
6	746.83	35.20	46.00	-10.80	42.21	-7.01	Peak	---	---

Note 1: Emission Level (dBuV/m) = SA Reading (dBuV/m) + Factor* (dB)

*Factor includes antenna factor , cable loss and amplifier gain

Note 2: Margin (dB) = Emission level (dBuV/m) – Limit (dBuV/m).

Note 3: All spurious emissions below 30MHz are more than 20 dB below the limit.

Modulation	GFSK	Test Freq. (MHz)	2402
Polarization	Vertical	Test Configuration	3

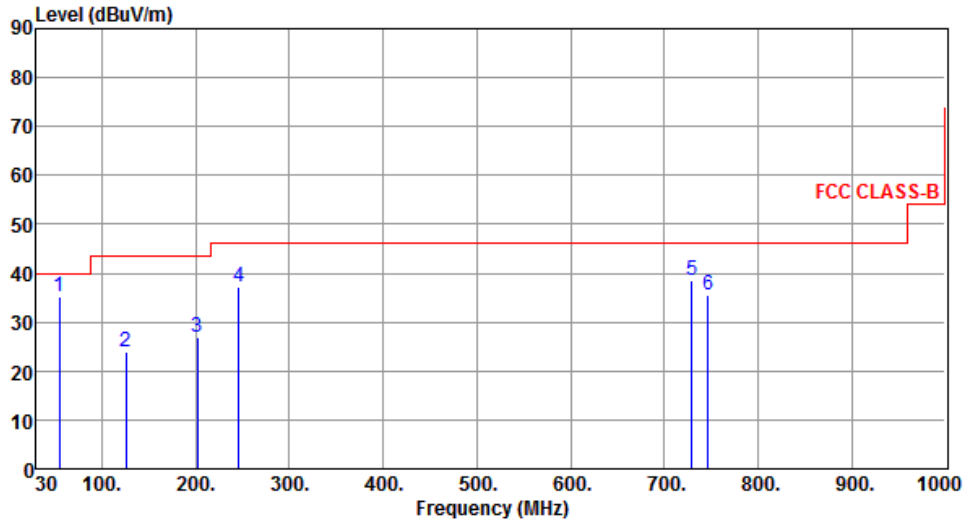

	Freq. MHz	Emission level dBuV/m	Limit dBuV/m	Margin dB	SA reading dBuV	Factor dB	Remark	ANT High cm	Turn Table deg
1	54.25	35.08	40.00	-4.92	51.93	-16.85	Peak	---	---
2	126.03	24.07	43.50	-19.43	42.41	-18.34	Peak	---	---
3	201.69	26.99	43.50	-16.51	46.29	-19.30	Peak	---	---
4	246.31	37.09	46.00	-8.91	54.89	-17.80	Peak	---	---
5	729.37	38.65	46.00	-7.35	46.05	-7.40	Peak	---	---
6	746.83	35.42	46.00	-10.58	42.43	-7.01	Peak	---	---

Note 1: Emission Level (dBuV/m) = SA Reading (dBuV/m) + Factor* (dB)

*Factor includes antenna factor , cable loss and amplifier gain

Note 2: Margin (dB) = Emission level (dBuV/m) – Limit (dBuV/m).

Note 3: All spurious emissions below 30MHz are more than 20 dB below the limit.

Modulation	GFSK	Test Freq. (MHz)	2402
Polarization	Horizontal	Test Configuration	4

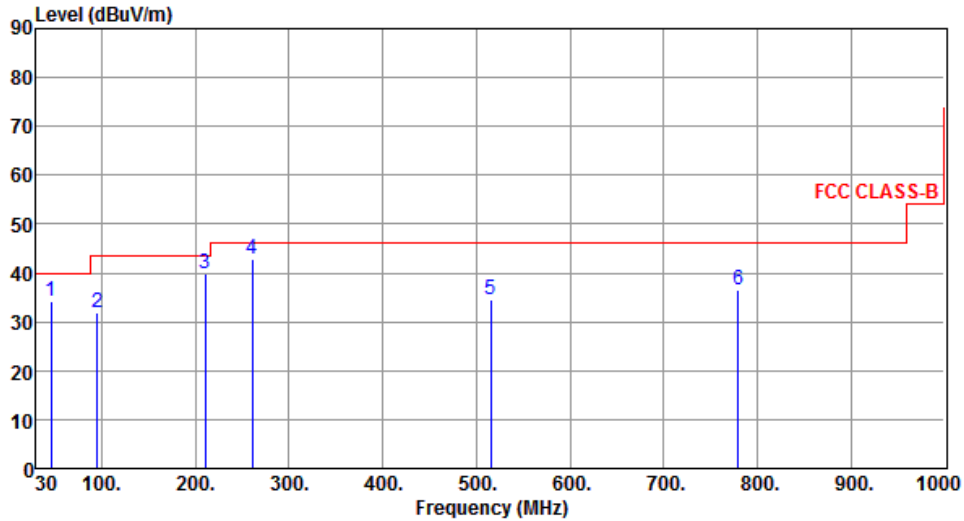

	Freq. MHz	Emission level dBuV/m	Limit dBuV/m	Margin dB	SA reading dBuV	Factor dB	Remark	ANT High cm	Turn Table deg
1	45.52	34.27	40.00	-5.73	50.58	-16.31	Peak	---	---
2	94.99	32.02	43.50	-11.48	54.18	-22.16	Peak	---	---
3	210.42	39.92	43.50	-3.58	59.26	-19.34	Peak	---	---
4	260.86	42.78	46.00	-3.22	60.13	-17.35	Peak	---	---
5	515.00	34.62	46.00	-11.38	45.54	-10.92	Peak	---	---
6	779.81	36.38	46.00	-9.62	43.06	-6.68	Peak	---	---

Note 1: Emission Level (dBuV/m) = SA Reading (dBuV/m) + Factor* (dB)

*Factor includes antenna factor , cable loss and amplifier gain

Note 2: Margin (dB) = Emission level (dBuV/m) – Limit (dBuV/m).

Note 3: All spurious emissions below 30MHz are more than 20 dB below the limit.

Modulation	GFSK	Test Freq. (MHz)	2402
Polarization	Vertical	Test Configuration	4

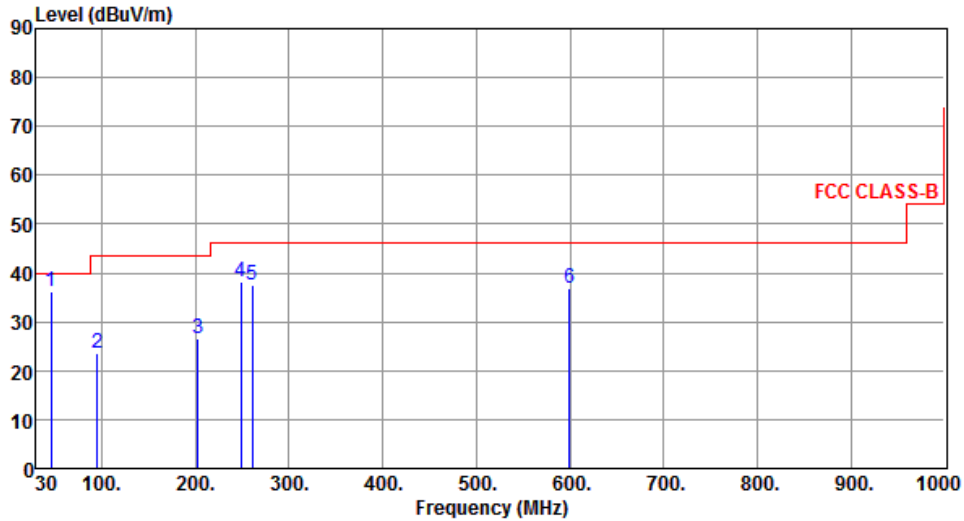

	Freq. MHz	Emission level dBuV/m	Limit dBuV/m	Margin dB	SA reading dBuV	Factor dB	Remark	ANT High cm	Turn Table deg
1	45.52	36.25	40.00	-3.75	52.56	-16.31	Peak	---	---
2	94.99	23.44	43.50	-20.06	45.60	-22.16	Peak	---	---
3	202.66	26.73	43.50	-16.77	46.03	-19.30	Peak	---	---
4	248.25	38.06	46.00	-7.94	55.81	-17.75	Peak	---	---
5	260.86	37.60	46.00	-8.40	54.95	-17.35	Peak	---	---
6	599.39	36.85	46.00	-9.15	46.38	-9.53	Peak	---	---

Note 1: Emission Level (dBuV/m) = SA Reading (dBuV/m) + Factor* (dB)

*Factor includes antenna factor , cable loss and amplifier gain

Note 2: Margin (dB) = Emission level (dBuV/m) – Limit (dBuV/m).

Note 3: All spurious emissions below 30MHz are more than 20 dB below the limit.

3.5.5 Transmitter Radiated Unwanted Emissions (Above 1GHz) for GFSK

Modulation	GFSK	Test Freq. (MHz)	2402
Polarization	Horizontal	Test Configuration	1

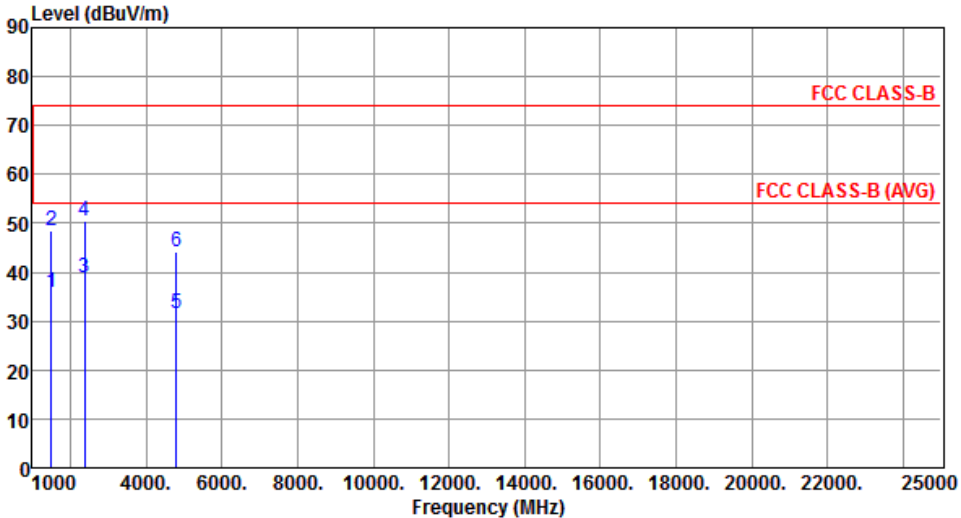

	Freq. MHz	Emission level dBuV/m	Limit dBuV/m	Margin dB	SA reading dBuV	Factor dB	Remark	ANT High cm	Turn Table deg
1	1500.00	35.81	54.00	-18.19	42.64	-6.83	Average	100	158
2	1500.00	48.62	74.00	-25.38	55.45	-6.83	Peak	100	158
3	2390.00	38.78	54.00	-15.22	42.13	-3.35	Average	129	333
4	2390.00	50.58	74.00	-23.42	53.93	-3.35	Peak	129	333
5	4804.00	31.61	54.00	-22.39	28.08	3.53	Average	100	162
6	4804.00	44.18	74.00	-29.82	40.65	3.53	Peak	100	162

Note 1: Emission Level (dBuV/m) = SA Reading (dBuV/m) + Factor* (dB)
*Factor includes antenna factor , cable loss and amplifier gain
Note 2: Margin (dB) = Emission level (dBuV/m) – Limit (dBuV/m).

Modulation	GFSK	Test Freq. (MHz)	2402
Polarization	Vertical	Test Configuration	1

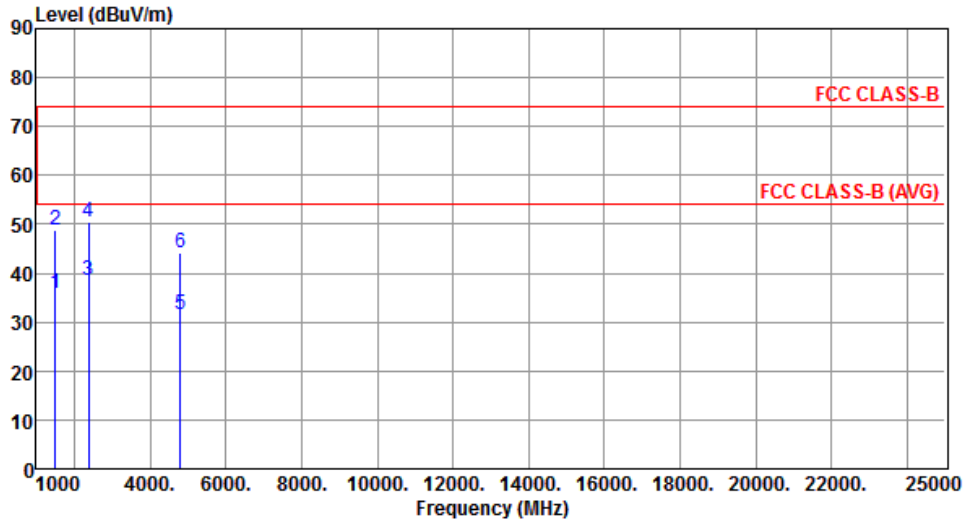

	Freq. MHz	Emission level dBuV/m	Limit dBuV/m	Margin dB	SA reading dBuV	Factor dB	Remark	ANT High cm	Turn Table deg
1	1500.00	35.80	54.00	-18.20	42.63	-6.83	Average	100	161
2	1500.00	48.73	74.00	-25.27	55.56	-6.83	Peak	100	161
3	2390.00	38.38	54.00	-15.62	41.73	-3.35	Average	100	345
4	2390.00	50.56	74.00	-23.44	53.91	-3.35	Peak	100	345
5	4804.00	31.46	54.00	-22.54	27.93	3.53	Average	100	185
6	4804.00	44.14	74.00	-29.86	40.61	3.53	Peak	100	185

Note 1: Emission Level (dBuV/m) = SA Reading (dBuV/m) + Factor* (dB)

*Factor includes antenna factor , cable loss and amplifier gain

Note 2: Margin (dB) = Emission level (dBuV/m) – Limit (dBuV/m).

Modulation	GFSK	Test Freq. (MHz)	2440
Polarization	Horizontal	Test Configuration	1

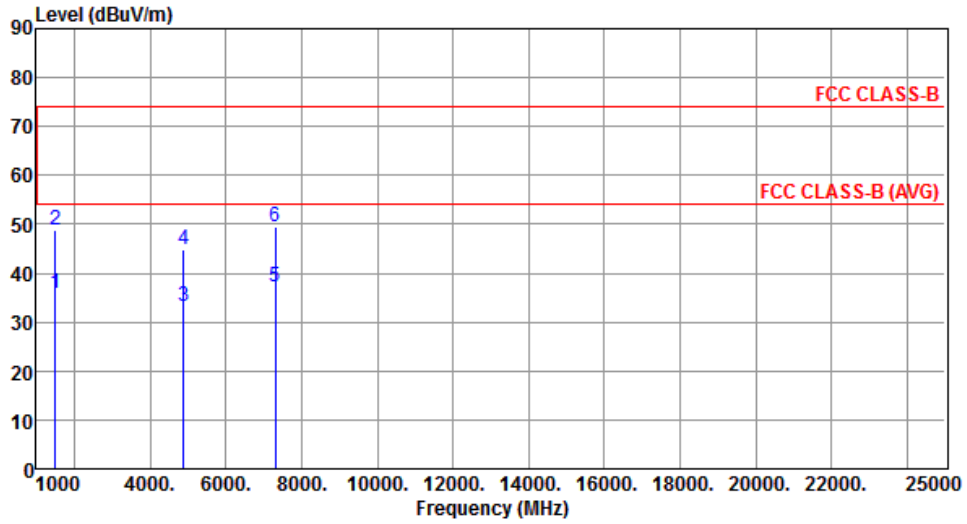

	Freq. MHz	Emission level dBuV/m	Limit dBuV/m	Margin dB	SA reading dBuV	Factor dB	Remark	ANT High cm	Turn Table deg
1	1500.00	35.85	54.00	-18.15	42.68	-6.83	Average	100	153
2	1500.00	48.97	74.00	-25.03	55.80	-6.83	Peak	100	153
3	4880.00	33.12	54.00	-20.88	29.35	3.77	Average	251	162
4	4880.00	44.77	74.00	-29.23	41.00	3.77	Peak	251	162
5	7320.00	37.15	54.00	-16.85	28.72	8.43	Average	100	222
6	7320.00	49.44	74.00	-24.56	41.01	8.43	Peak	100	222

Note 1: Emission Level (dBuV/m) = SA Reading (dBuV/m) + Factor* (dB)

*Factor includes antenna factor , cable loss and amplifier gain

Note 2: Margin (dB) = Emission level (dBuV/m) – Limit (dBuV/m).

Modulation	GFSK	Test Freq. (MHz)	2440
Polarization	Vertical	Test Configuration	1

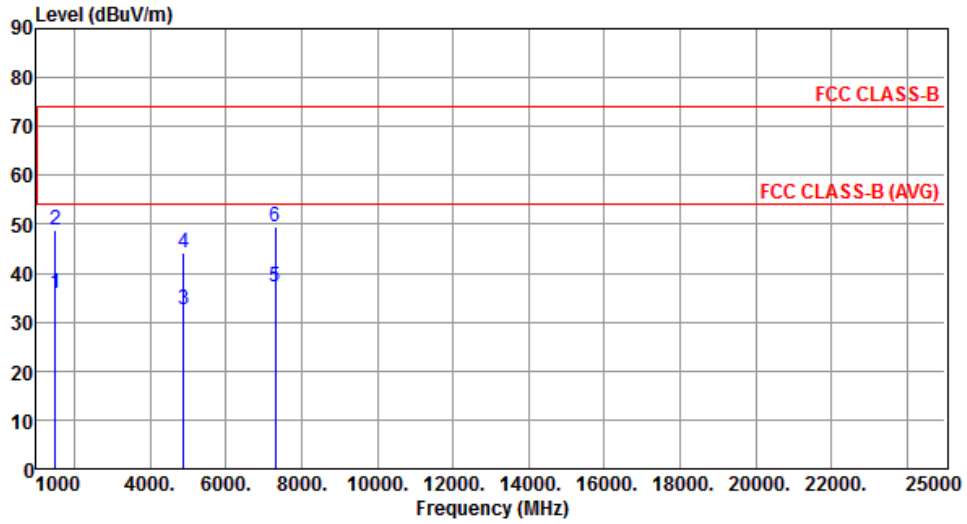

	Freq. MHz	Emission level dBuV/m	Limit dBuV/m	Margin dB	SA reading dBuV	Factor dB	Remark	ANT High cm	Turn Table deg
1	1500.00	35.72	54.00	-18.28	42.55	-6.83	Average	100	166
2	1500.00	48.87	74.00	-25.13	55.70	-6.83	Peak	100	166
3	4880.00	32.51	54.00	-21.49	28.74	3.77	Average	100	0
4	4880.00	44.30	74.00	-29.70	40.53	3.77	Peak	100	0
5	7320.00	37.30	54.00	-16.70	28.87	8.43	Average	100	142
6	7320.00	49.49	74.00	-24.51	41.06	8.43	Peak	100	142

Note 1: Emission Level (dBuV/m) = SA Reading (dBuV/m) + Factor* (dB)

*Factor includes antenna factor , cable loss and amplifier gain

Note 2: Margin (dB) = Emission level (dBuV/m) – Limit (dBuV/m).

Modulation	GFSK	Test Freq. (MHz)	2480
Polarization	Horizontal	Test Configuration	1

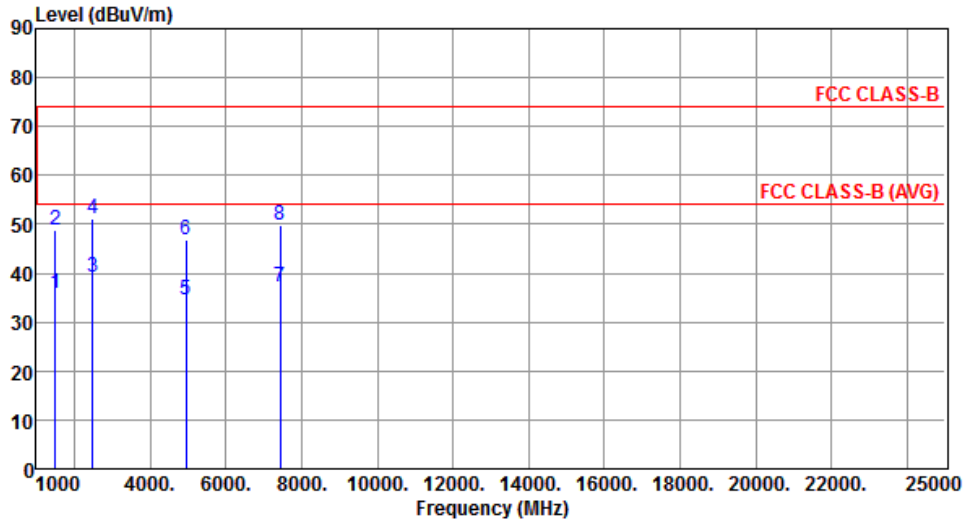

	Freq. MHz	Emission level dBuV/m	Limit dBuV/m	Margin dB	SA reading dBuV	Factor dB	Remark	ANT High cm	Turn Table deg
1	1500.00	35.78	54.00	-18.22	42.61	-6.83	Average	100	156
2	1500.00	48.96	74.00	-25.04	55.79	-6.83	Peak	100	156
3	2483.50	39.25	54.00	-14.75	42.18	-2.93	Average	123	331
4	2483.50	51.15	74.00	-22.85	54.08	-2.93	Peak	123	331
5	4960.00	34.37	54.00	-19.63	30.33	4.04	Average	100	153
6	4960.00	46.78	74.00	-27.22	42.74	4.04	Peak	100	153
7	7440.00	37.13	54.00	-16.87	28.57	8.56	Average	100	162
8	7440.00	49.69	74.00	-24.31	41.13	8.56	Peak	100	162

Note 1: Emission Level (dBuV/m) = SA Reading (dBuV/m) + Factor* (dB)

*Factor includes antenna factor , cable loss and amplifier gain

Note 2: Margin (dB) = Emission level (dBuV/m) – Limit (dBuV/m).

Modulation	GFSK	Test Freq. (MHz)	2480
Polarization	Vertical	Test Configuration	1

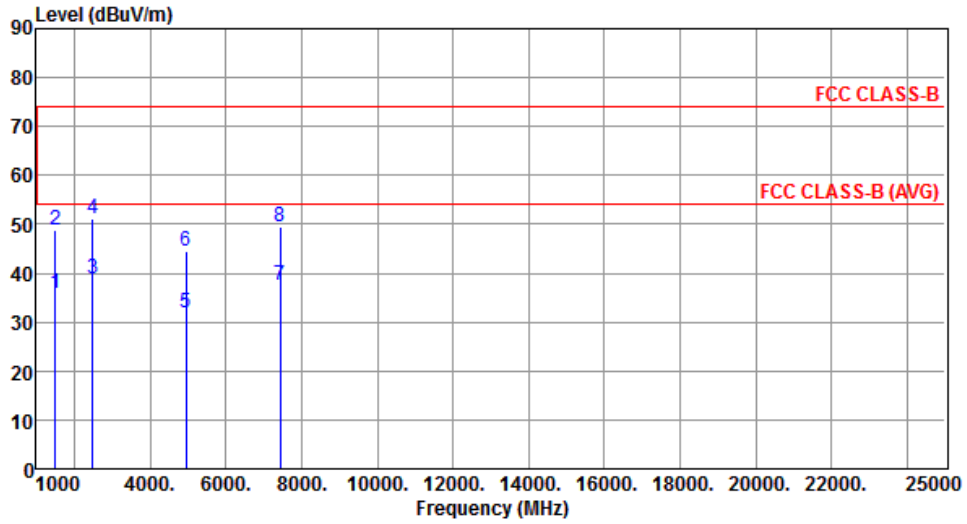

	Freq. MHz	Emission level dBuV/m	Limit dBuV/m	Margin dB	SA reading dBuV	Factor dB	Remark	ANT High cm	Turn Table deg
1	1500.00	35.78	54.00	-18.22	42.61	-6.83	Average	100	159
2	1500.00	48.99	74.00	-25.01	55.82	-6.83	Peak	100	159
3	2483.50	38.73	54.00	-15.27	41.66	-2.93	Average	100	341
4	2483.50	51.20	74.00	-22.80	54.13	-2.93	Peak	100	341
5	4960.00	31.73	54.00	-22.27	27.69	4.04	Average	100	173
6	4960.00	44.59	74.00	-29.41	40.55	4.04	Peak	100	173
7	7440.00	37.37	54.00	-16.63	28.81	8.56	Average	100	168
8	7440.00	49.63	74.00	-24.37	41.07	8.56	Peak	100	168

Note 1: Emission Level (dBuV/m) = SA Reading (dBuV/m) + Factor* (dB)

*Factor includes antenna factor , cable loss and amplifier gain

Note 2: Margin (dB) = Emission level (dBuV/m) – Limit (dBuV/m).

Modulation	GFSK	Test Freq. (MHz)	2402
Polarization	Horizontal	Test Configuration	3

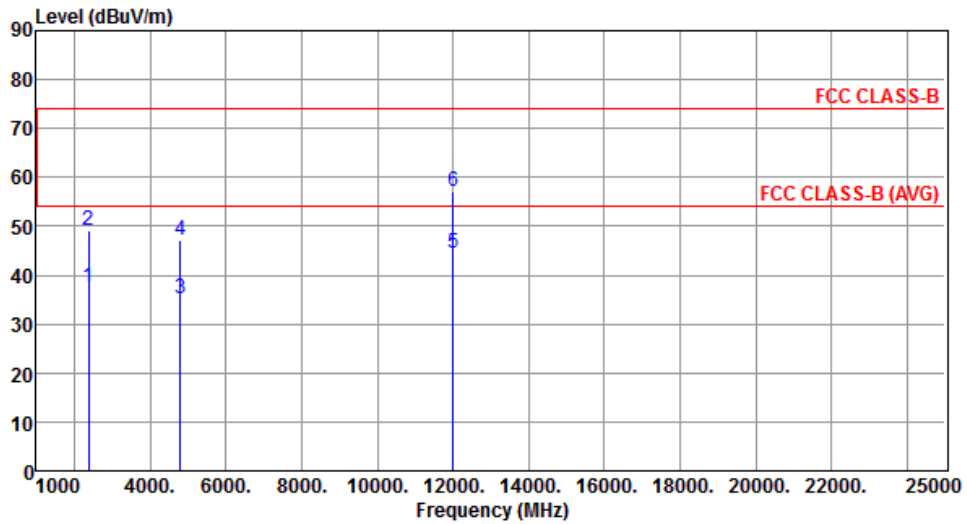

	Freq. MHz	Emission level dBuV/m	Limit dBuV/m	Margin dB	SA reading dBuV	Factor dB	Remark	ANT High cm	Turn Table deg
1	2390.00	37.61	54.00	-16.39	40.96	-3.35	Average	255	285
2	2390.00	49.30	74.00	-24.70	52.65	-3.35	Peak	255	285
3	4804.00	35.10	54.00	-18.90	31.57	3.53	Average	160	331
4	4804.00	47.29	74.00	-26.71	43.76	3.53	Peak	160	331
5	12010.00	44.38	54.00	-9.62	30.30	14.08	Average	295	117
6	12010.00	57.08	74.00	-16.92	43.00	14.08	Peak	295	117

Note 1: Emission Level (dBuV/m) = SA Reading (dBuV/m) + Factor* (dB)

*Factor includes antenna factor , cable loss and amplifier gain

Note 2: Margin (dB) = Emission level (dBuV/m) – Limit (dBuV/m).

Modulation	GFSK	Test Freq. (MHz)	2402
Polarization	Vertical	Test Configuration	3

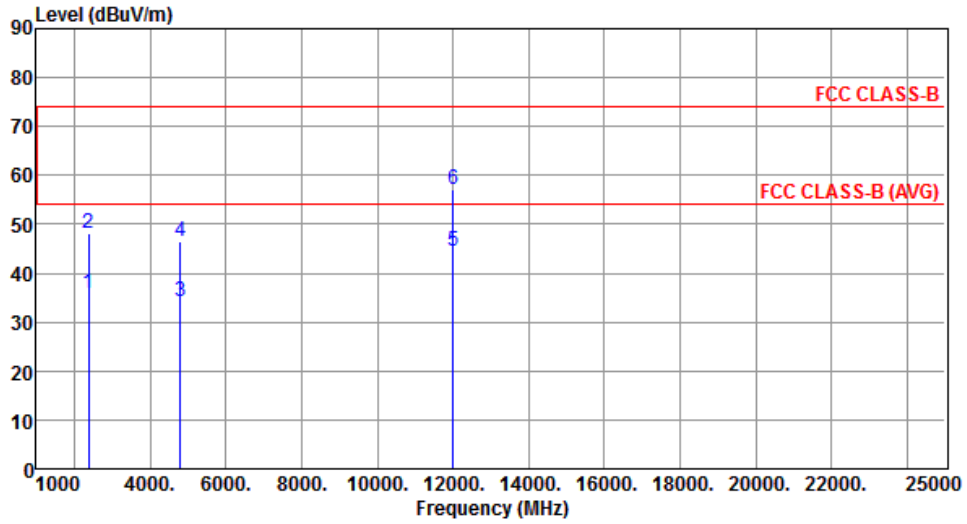

	Freq. MHz	Emission level dBuV/m	Limit dBuV/m	Margin dB	SA reading dBuV	Factor dB	Remark	ANT High cm	Turn Table deg
1	2390.00	36.02	54.00	-17.98	39.37	-3.35	Average	260	290
2	2390.00	48.12	74.00	-25.88	51.47	-3.35	Peak	260	290
3	4804.00	34.29	54.00	-19.71	30.76	3.53	Average	212	293
4	4804.00	46.60	74.00	-27.40	43.07	3.53	Peak	212	293
5	12010.00	44.47	54.00	-9.53	30.39	14.08	Average	267	147
6	12010.00	57.29	74.00	-16.71	43.21	14.08	Peak	267	147

Note 1: Emission Level (dBuV/m) = SA Reading (dBuV/m) + Factor* (dB)

*Factor includes antenna factor , cable loss and amplifier gain

Note 2: Margin (dB) = Emission level (dBuV/m) – Limit (dBuV/m).

Modulation	GFSK	Test Freq. (MHz)	2440
Polarization	Horizontal	Test Configuration	3

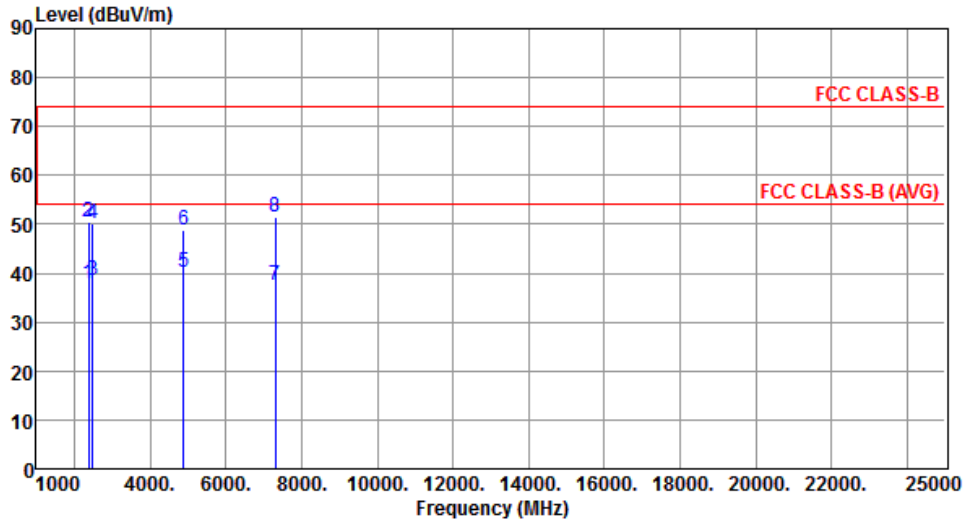

	Freq. MHz	Emission level dBuV/m	Limit dBuV/m	Margin dB	SA reading dBuV	Factor dB	Remark	ANT High cm	Turn Table deg
1	2390.00	37.89	54.00	-16.11	41.24	-3.35	Average	250	293
2	2390.00	50.42	74.00	-23.58	53.77	-3.35	Peak	250	293
3	2483.50	38.36	54.00	-15.64	41.29	-2.93	Average	250	293
4	2483.50	50.26	74.00	-23.74	53.19	-2.93	Peak	250	293
5	4880.00	40.28	54.00	-13.72	36.51	3.77	Average	129	300
6	4880.00	48.68	74.00	-25.32	44.91	3.77	Peak	129	300
7	7320.00	37.45	54.00	-16.55	29.02	8.43	Average	295	177
8	7320.00	51.54	74.00	-22.46	43.11	8.43	Peak	295	177

Note 1: Emission Level (dBuV/m) = SA Reading (dBuV/m) + Factor* (dB)

*Factor includes antenna factor , cable loss and amplifier gain

Note 2: Margin (dB) = Emission level (dBuV/m) – Limit (dBuV/m).

Modulation	GFSK	Test Freq. (MHz)	2440
Polarization	Vertical	Test Configuration	3

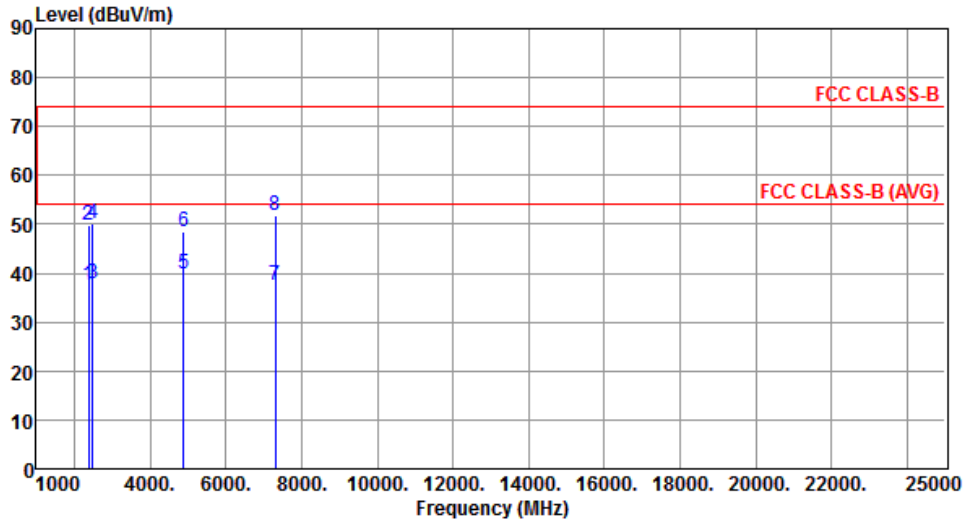

	Freq. MHz	Emission level dBuV/m	Limit dBuV/m	Margin dB	SA reading dBuV	Factor dB	Remark	ANT High cm	Turn Table deg
1	2390.00	37.60	54.00	-16.40	40.95	-3.35	Average	260	293
2	2390.00	49.74	74.00	-24.26	53.09	-3.35	Peak	260	293
3	2483.50	37.91	54.00	-16.09	40.84	-2.93	Average	260	293
4	2483.50	50.16	74.00	-23.84	53.09	-2.93	Peak	260	293
5	4880.00	39.70	54.00	-14.30	35.93	3.77	Average	210	290
6	4880.00	48.57	74.00	-25.43	44.80	3.77	Peak	210	290
7	7320.00	37.39	54.00	-16.61	28.96	8.43	Average	247	198
8	7320.00	51.66	74.00	-22.34	43.23	8.43	Peak	247	198

Note 1: Emission Level (dBuV/m) = SA Reading (dBuV/m) + Factor* (dB)

*Factor includes antenna factor , cable loss and amplifier gain

Note 2: Margin (dB) = Emission level (dBuV/m) – Limit (dBuV/m).

Modulation	GFSK	Test Freq. (MHz)	2480
Polarization	Horizontal	Test Configuration	3

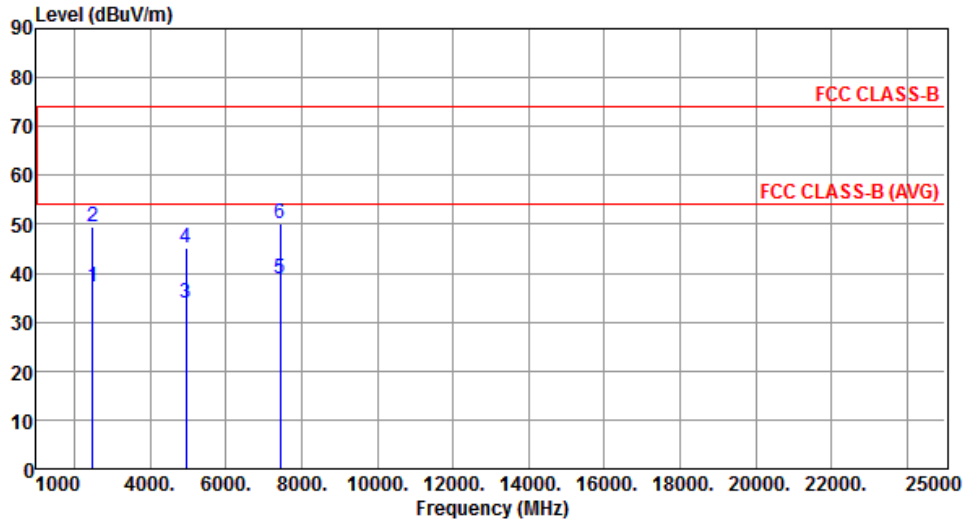

	Freq. MHz	Emission level dBuV/m	Limit dBuV/m	Margin dB	SA reading dBuV	Factor dB	Remark	ANT High cm	Turn Table deg
1	2483.50	37.30	54.00	-16.70	40.23	-2.93	Average	330	297
2	2483.50	49.47	74.00	-24.53	52.40	-2.93	Peak	330	297
3	4960.00	33.76	54.00	-20.24	29.72	4.04	Average	239	15
4	4960.00	45.00	74.00	-29.00	40.96	4.04	Peak	239	15
5	7440.00	38.71	54.00	-15.29	30.15	8.56	Average	150	267
6	7440.00	50.28	74.00	-23.72	41.72	8.56	Peak	150	267

Note 1: Emission Level (dBuV/m) = SA Reading (dBuV/m) + Factor* (dB)

*Factor includes antenna factor , cable loss and amplifier gain

Note 2: Margin (dB) = Emission level (dBuV/m) – Limit (dBuV/m).

Modulation	GFSK	Test Freq. (MHz)	2480
Polarization	Vertical	Test Configuration	3

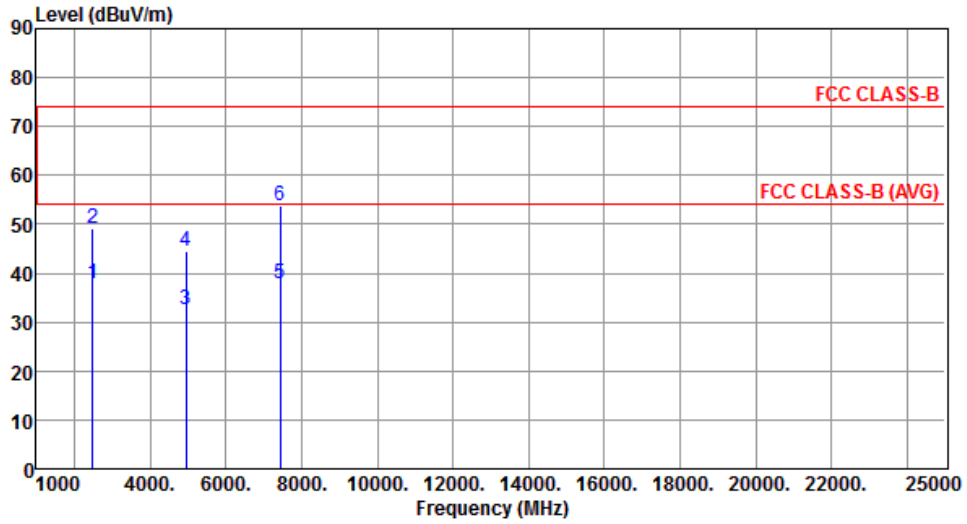

	Freq. MHz	Emission level dBuV/m	Limit dBuV/m	Margin dB	SA reading dBuV	Factor dB	Remark	ANT High cm	Turn Table deg
1	2483.50	37.96	54.00	-16.04	40.89	-2.93	Average	332	281
2	2483.50	49.23	74.00	-24.77	52.16	-2.93	Peak	332	281
3	4960.00	32.56	54.00	-21.44	28.52	4.04	Average	214	282
4	4960.00	44.62	74.00	-29.38	40.58	4.04	Peak	214	282
5	7440.00	37.76	54.00	-16.24	29.20	8.56	Average	290	245
6	7440.00	53.70	74.00	-20.30	45.14	8.56	Peak	290	245

Note 1: Emission Level (dBuV/m) = SA Reading (dBuV/m) + Factor* (dB)

*Factor includes antenna factor , cable loss and amplifier gain

Note 2: Margin (dB) = Emission level (dBuV/m) – Limit (dBuV/m).

3.6 Emissions in non-restricted Frequency Bands

3.6.1 Emissions in non-restricted frequency bands limit

The peak output power measured in any 100 kHz bandwidth outside of the authorized frequency band shall be attenuated by at least 20 dB relative to the maximum in-band peak PSD level in 100 kHz.

3.6.2 Test Procedures

Reference Level Measurement

1. Set the RBW = 100 kHz, VBW = 300 kHz, Detector = peak.
2. Set Sweep time = auto couple, Trace mode = max hold.
3. Allow trace to fully stabilize.
4. Use the peak marker function to determine the maximum amplitude level.

Unwanted Emissions Level Measurement

1. Set RBW = 100 kHz, VBW = 300 kHz, Detector = peak.
2. Trace Mode = max hold, Sweep = auto couple.
3. Allow the trace to stabilize.
4. Use peak marker function to determine maximum amplitude of all unwanted emissions within any 100 kHz bandwidth.

3.6.3 Test Setup

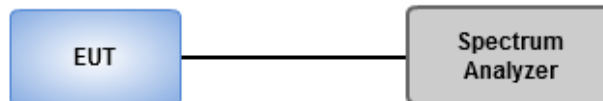

3.6.4 Test Result of Emissions in non-restricted Frequency Bands

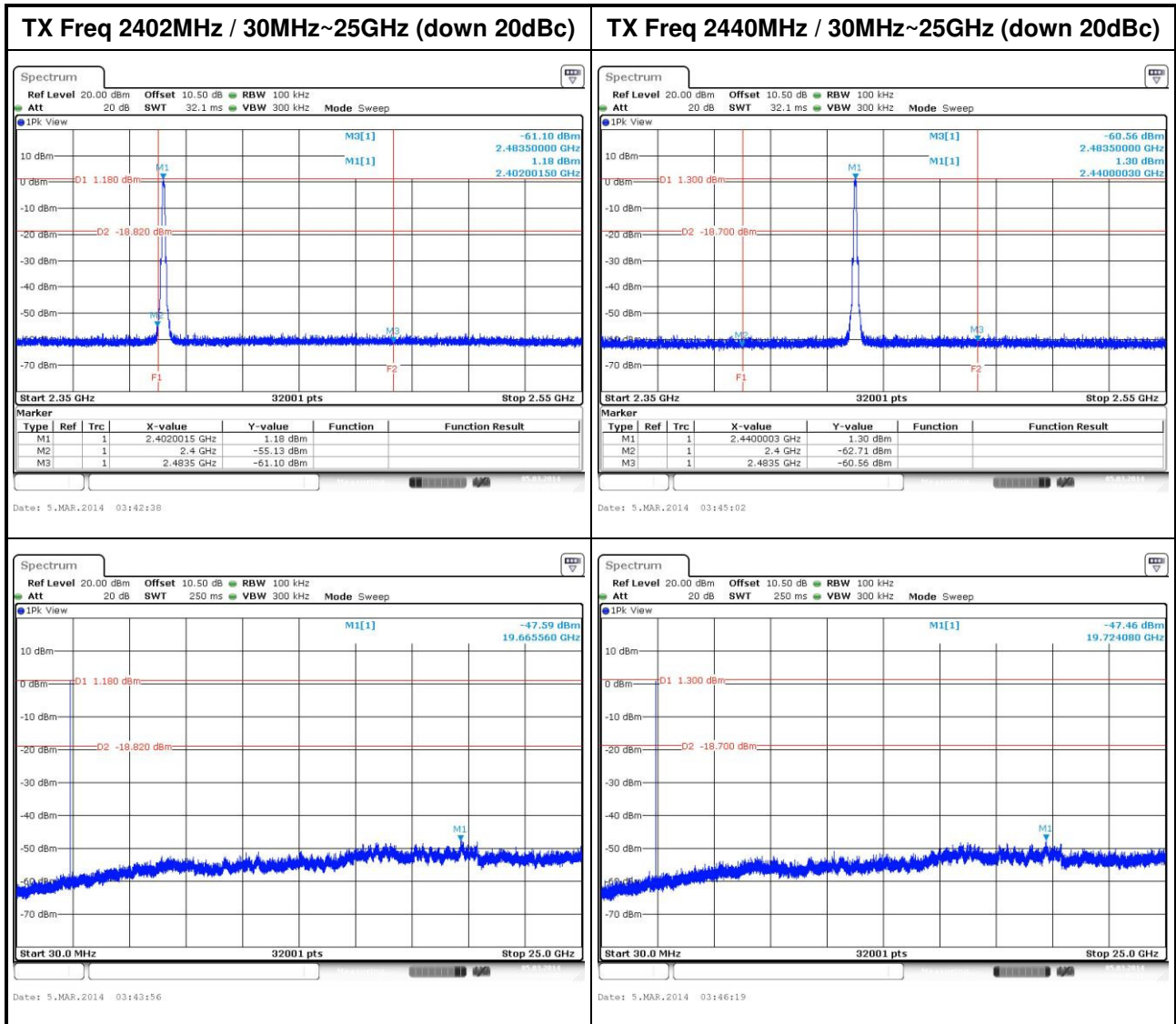

TX Freq 2480MHz / 30MHz~25GHz (down 20dBc)

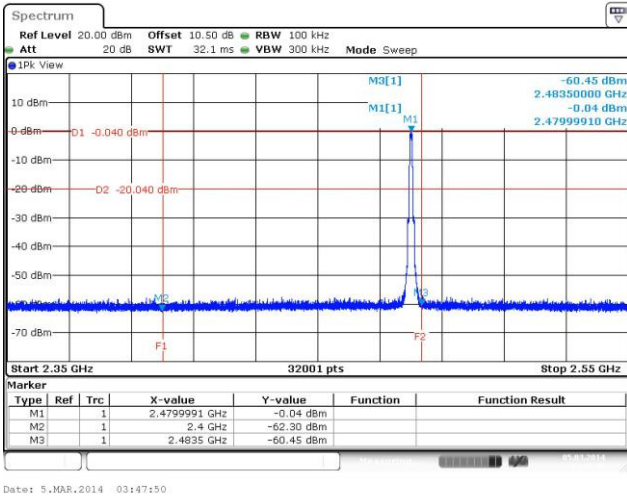

Date: 5.MAR.2014 03:47:50

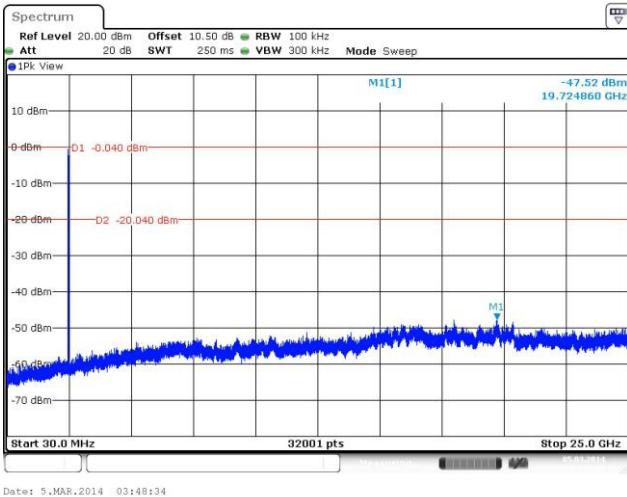

Date: 5.MAR.2014 03:48:34

4 Test laboratory information

Established in 2012, ICC provides foremost EMC & RF Testing and advisory consultation services by our skilled engineers and technicians. Our services employ a wide variety of advanced edge test equipment and one of the widest certification extents in the business.

International Certification Corp, it is our definitive objective is to institute long term, trust-based associations with our clients. The expectation we set up with our clients is based on outstanding service, practical expertise and devotion to a certified value structure. Our passion is to grant our clients with best EMC / RF services by oriented knowledgeable and accommodating staff.

Our Test sites are located at Linkou District and Kwei Shan Hsiang. Location map can be found on our website <http://www.icertifi.com.tw>.

Linkou

Tel: 886-2-2601-1640

No. 30-2, Ding Fwu Tsuen, Lin Kou
District, New Taipei City, Taiwan,
R.O.C.

Kwei Shan

Tel: 886-3-271-8666

No. 3-1, Lane 6, Wen San 3rd
St., Kwei Shan Hsiang, Tao Yuan
Hsien 333, Taiwan, R.O.C.

Kwei Shan Site II

Tel: 886-3-271-8640

No. 14-1, Lane 19, Wen San 3rd
St., Kwei Shan Hsiang, Tao Yuan
Hsien 333, Taiwan, R.O.C.

If you have any suggestion, please feel free to contact us as below information

Tel: 886-3-271-8666

Fax: 886-3-318-0155

Email: ICC_Service@icertifi.com.tw

==END==