

## FCC Test Report

**Report No.:** RF190103E04-1

**FCC ID:** NKR-CC1

**Test Model:** CC1

**Received Date:** Jan. 03, 2019

**Test Date:** Jan. 11 to 23, 2019

**Issued Date:** Feb. 15, 2019

**Applicant:** Wistron NeWeb Corp.

**Address:** 20 Park Avenue II, Hsinchu Science Park, Hsinchu 308, Taiwan, R.O.C.

**Issued By:** Bureau Veritas Consumer Products Services (H.K.) Ltd., Taoyuan Branch  
Hsin Chu Laboratory

**Lab Address:** E-2, No.1, Li Hsin 1st Road, Hsinchu Science Park, Hsinchu City 300,  
Taiwan R.O.C.

**Test Location:** E-2, No.1, Li Hsin 1st Road, Hsinchu Science Park, Hsinchu City 300,  
Taiwan R.O.C.

**FCC Registration /  
Designation Number:** 723255 / TW2022



This report is for your exclusive use. Any copying or replication of this report to or for any other person or entity, or use of our name or trademark, is permitted only with our prior written permission. This report sets forth our findings solely with respect to the test samples identified herein. The results set forth in this report are not indicative or representative of the quality or characteristics of the lot from which a test sample was taken or any similar or identical product unless specifically and expressly noted. Our report includes all of the tests requested by you and the results thereof based upon the information that you provided to us. You have 60 days from date of issuance of this report to notify us of any material error or omission caused by our negligence, provided, however, that such notice shall be in writing and shall specifically address the issue you wish to raise. A failure to raise such issue within the prescribed time shall constitute your unqualified acceptance of the completeness of this report, the tests conducted and the correctness of the report contents. Unless specific mention, the uncertainty of measurement has been explicitly taken into account to declare the compliance or non-compliance to the specification. The report must not be used by the client to claim product certification, approval, or endorsement by TAF or any government agencies.

## Table of Contents

<b>Release Control Record</b> .....	<b>4</b>
<b>1 Certificate of Conformity</b> .....	<b>5</b>
<b>2 Summary of Test Results</b> .....	<b>6</b>
2.1 Measurement Uncertainty .....	6
2.2 Modification Record .....	6
<b>3 General Information</b> .....	<b>7</b>
3.1 General Description of EUT .....	7
3.2 Description of Test Modes .....	9
3.2.1 Test Mode Applicability and Tested Channel Detail .....	10
3.3 Duty Cycle of Test Signal .....	12
3.4 Description of Support Units .....	13
3.4.1 Configuration of System under Test .....	14
3.5 General Description of Applied Standard .....	15
<b>4 Test Types and Results</b> .....	<b>16</b>
4.1 Radiated Emission and Bandedge Measurement .....	16
4.1.1 Limits of Radiated Emission and Bandedge Measurement .....	16
4.1.2 Test Instruments .....	17
4.1.3 Test Procedure .....	20
4.1.4 Deviation from Test Standard .....	20
4.1.5 Test Setup .....	21
4.1.6 EUT Operating Condition .....	22
4.1.7 Test Results .....	23
4.2 Conducted Emission Measurement .....	43
4.2.1 Limits of Conducted Emission Measurement .....	43
4.2.2 Test Instruments .....	43
4.2.3 Test Procedure .....	44
4.2.4 Deviation from Test Standard .....	44
4.2.5 Test Setup .....	44
4.2.6 EUT Operating Condition .....	44
4.2.7 Test Results .....	45
4.3 Transmit Power Measurement .....	47
4.3.1 Limits of Transmit Power Measurement .....	47
4.3.2 Test Setup .....	48
4.3.3 Test Instruments .....	48
4.3.4 Test Procedure .....	48
4.3.5 Deviation from Test Standard .....	48
4.3.6 EUT Operating Condition .....	48
4.3.7 Test Results .....	49
4.4 Occupied Bandwidth Measurement .....	51
4.4.1 Test Setup .....	51
4.4.2 Test Instruments .....	51
4.4.3 Test Procedure .....	51
4.4.4 Test Results .....	52
4.5 Peak Power Spectral Density Measurement .....	56
4.5.1 Limits of Peak Power Spectral Density Measurement .....	56
4.5.2 Test Setup .....	56
4.5.3 Test Instruments .....	56
4.5.4 Test Procedure .....	57
4.5.5 Deviation from Test Standard .....	57
4.5.6 EUT Operating Condition .....	57
4.5.7 Test Results .....	58
4.6 Frequency Stability Measurement .....	64
4.6.1 Limits of Frequency Stability Measurement .....	64

4.6.2	Test Setup.....	64
4.6.3	Test Instruments .....	64
4.6.4	Test Procedure .....	64
4.6.5	Deviation from Test Standard .....	64
4.6.6	EUT Operating Condition .....	64
4.6.7	Test Results .....	65
4.7	6dB Bandwidth Measurement .....	66
4.7.1	Limits of 6dB Bandwidth Measurement.....	66
4.7.2	Test Setup.....	66
4.7.3	Test Instruments .....	66
4.7.4	Test Procedure .....	66
4.7.5	Deviation from Test Standard .....	66
4.7.6	EUT Operating Condition .....	66
4.7.7	Test Results .....	67
<b>5</b>	<b>Pictures of Test Arrangements.....</b>	<b>69</b>
	<b>Annex A- Radiated Out of Band Emission (OOBE) Measurement (For U-NII-3 band) .....</b>	<b>70</b>
	<b>Appendix – Information of the Testing Laboratories .....</b>	<b>73</b>

### Release Control Record

Issue No.	Description	Date Issued
RF190103E04-1	Original release.	Feb. 15, 2019

## 1 Certificate of Conformity

**Product:** AP

**Brand:** WNC

**Test Model:** CC1

**Sample Status:** ENGINEERING SAMPLE

**Applicant:** Wistron NeWeb Corp.

**Test Date:** Jan. 11 to 23, 2019

**Standard:** 47 CFR FCC Part 15, Subpart E (Section 15.407)  
ANSI C63.10: 2013

The above equipment has been tested by **Bureau Veritas Consumer Products Services (H.K.) Ltd., Taoyuan Branch**, and found compliance with the requirement of the above standards. The test record, data evaluation & Equipment Under Test (EUT) configurations represented herein are true and accurate accounts of the measurements of the sample's EMC characteristics under the conditions specified in this report.

**Prepared by :**  \_\_\_\_\_, **Date:** \_\_\_\_\_ Feb. 15, 2019  
Claire Kuan / Specialist

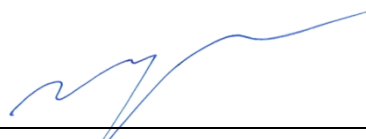
**Approved by :**  \_\_\_\_\_, **Date:** \_\_\_\_\_ Feb. 15, 2019  
May Chen / Manager

## 2 Summary of Test Results

47 CFR FCC Part 15, Subpart E (Section 15.407)			
FCC Clause	Test Item	Result	Remarks
15.407(b)(6)	AC Power Conducted Emissions	Pass	Meet the requirement of limit. Minimum passing margin is -8.08dB at 0.67734MHz.
15.407(b) (1/2/3/4(i/ii)/6)	Radiated Emissions & Band Edge Measurement*	Pass	Meet the requirement of limit. Minimum passing margin is -0.1dB at 5646.41MHz.
15.407(a)(1/2/3)	Max Average Transmit Power	Pass	Meet the requirement of limit.
---	Occupied Bandwidth Measurement	-	Reference only.
15.407(a)(1/2/3)	Peak Power Spectral Density	Pass	Meet the requirement of limit.
15.407(e)	6dB bandwidth	Pass	Meet the requirement of limit. (U-NII-3 Band only)
15.407(g)	Frequency Stability	Pass	Meet the requirement of limit.
15.203	Antenna Requirement	Pass	Antenna connector is i-pex (MHF) not a standard connector.

\*For U-NII-3 band compliance with rule part 15.407(b)(4)(i), the OOB test plots were recorded in Annex A.

Note:

Determining compliance based on the results of the compliance measurement, not taking into account measurement instrumentation uncertainty.

### 2.1 Measurement Uncertainty

Where relevant, the following measurement uncertainty levels have been estimated for tests performed on the EUT as specified in CISPR 16-4-2:

Measurement	Frequency	Expanded Uncertainty (k=2) ( $\pm$ )
Conducted Emissions at mains ports	150kHz ~ 30MHz	1.84 dB
Radiated Emissions up to 1 GHz	30MHz ~ 1GHz	4.87 dB
Radiated Emissions above 1 GHz	1GHz ~ 6GHz	5.12 dB
	6GHz ~ 18GHz	4.86 dB
	18GHz ~ 40GHz	5.24 dB

### 2.2 Modification Record

There were no modifications required for compliance.

### 3 General Information

#### 3.1 General Description of EUT

Product	AP
Brand	WNC
Test Model	CC1
Status of EUT	ENGINEERING SAMPLE
Power Supply Rating	120Vac, 0.3A, 60Hz
Modulation Type	CCK, DQPSK, DBPSK for DSSS 64QAM, 16QAM, QPSK, BPSK for OFDM 256QAM for OFDM in 11ac mode only
Modulation Technology	DSSS, OFDM
Transfer Rate	802.11b: up to 11Mbps 802.11a/g: up to 54Mbps 802.11n: up to 300Mbps 802.11ac: up to 866.7Mbps
Operating Frequency	<b>2.4GHz:</b> 2.412GHz ~ 2.462GHz <b>5GHz:</b> 5.18GHz ~ 5.24GHz, 5.745GHz ~ 5.825GHz
Number of Channel	<b>2.4GHz:</b> 802.11b, 802.11g, 802.11n (HT20): 11 802.11n (HT40): 7 <b>5GHz:</b> 802.11a, 802.11n (HT20), 802.11ac (VHT20): 9 802.11n (HT40), 802.11ac (VHT40): 4 802.11ac (VHT80): 2
Output Power	<b>2.4GHz:</b> 445.654 mW <b>5.18 ~ 5.24GHz</b> <b>CDD Mode:</b> 434.541 mW <b>Beamforming Mode</b> 412.127 mW <b>5.745 ~ 5.825GHz</b> <b>CDD Mode:</b> 438.753 mW <b>Beamforming Mode:</b> 438.753 mW
Antenna Type	Refer to Note
Antenna Connector	Refer to Note
Accessory Device	NA
Data Cable Supplied	NA

Note:

1. There are WLAN and Bluetooth technology used for the EUT.
2. Simultaneously transmission condition.

Condition	Technology		
1	WLAN (2.4GHz)	WLAN (5GHz)	Bluetooth

**Note:** The emission of the simultaneous operation has been evaluated and no non-compliance was found.

3. The antennas provided to the EUT, please refer to the following table:

<b>WLAN Directional gain table</b>			
Frequency range (GHz)	Directional Antenna Gain (dBi)	Antenna Type	Antenna Connector
2.4 ~ 2.5	3.52	PIFA	i-pex(MHF)
5.15 ~ 5.85	5.53		
<b>Bluetooth antenna spec.</b>			
Frequency range (GHz)	Antenna Net Gain (dBi)	Antenna Type	Antenna Connector
2.4 ~ 2.4835	0	CHIP	NA

Note: More detailed information, please refer to operating description.

4. The EUT incorporates a MIMO function

<b>2.4GHz Band</b>		
MODULATION MODE	TX & RX CONFIGURATION	
802.11b	2TX	2RX
802.11g	2TX	2RX
802.11n (HT20)	2TX	2RX
802.11n (HT40)	2TX	2RX
<b>5GHz Band</b>		
MODULATION MODE	TX & RX CONFIGURATION	
802.11a	2TX	2RX
802.11n (HT20)	2TX	2RX
802.11n (HT40)	2TX	2RX
802.11ac (VHT20)	2TX	2RX
802.11ac (VHT40)	2TX	2RX
802.11ac (VHT80)	2TX	2RX

Note:

- All of modulation mode support beamforming function except 2.4GHz & 802.11a modulation mode.
  - The EUT support Beamforming and CDD mode, therefore both mode were investigated and the worst case scenario was identified. The worst case data were presented in test report.
  - The modulation and bandwidth are similar for 802.11n mode for 20MHz (40MHz) and 802.11ac mode for 20MHz (40MHz), therefore investigated worst case to representative mode in test report. (Final test mode refer section 3.2.1)
5. The above EUT information is declared by manufacturer and for more detailed features description, please refers to the manufacturer's specifications or user's manual.



### 3.2 Description of Test Modes

#### FOR 5180 ~ 5240MHz

4 channels are provided for 802.11a, 802.11n (HT20), 802.11ac (VHT20):

Channel	Frequency	Channel	Frequency
36	5180 MHz	44	5220 MHz
40	5200 MHz	48	5240 MHz

2 channels are provided for 802.11n (HT40), 802.11ac (VHT40):

Channel	Frequency	Channel	Frequency
38	5190 MHz	46	5230 MHz

1 channel is provided for 802.11ac (VHT80):

Channel	Frequency
42	5210 MHz

#### FOR 5745 ~ 5825MHz:

5 channels are provided for 802.11a, 802.11n (HT20), 802.11ac (VHT20):

Channel	Frequency	Channel	Frequency
149	5745 MHz	161	5805 MHz
153	5765 MHz	165	5825 MHz
157	5785 MHz		

2 channels are provided for 802.11n (HT40), 802.11ac (VHT40):

Channel	Frequency	Channel	Frequency
151	5755 MHz	159	5795 MHz

1 channel is provided for 802.11ac (VHT80):

Channel	Frequency
155	5775 MHz

### 3.2.1 Test Mode Applicability and Tested Channel Detail

EUT Configure Mode	Applicable To				Description
	RE $\geq$ 1G	RE<1G	PLC	APCM	
-	√	√	√	√	-

Where **RE $\geq$ 1G**: Radiated Emission above 1GHz

**RE<1G**: Radiated Emission below 1GHz

**PLC**: Power Line Conducted Emission

**APCM**: Antenna Port Conducted Measurement

**Note**: The EUT had been pre-tested on the positioned of each 3 axis. The worst case was found when positioned on **Z-plane**.

#### **Radiated Emission Test (Above 1GHz):**

- Pre-Scan has been conducted to determine the worst-case mode from all possible combinations between available modulations, data rates and antenna ports (if EUT with antenna diversity architecture).
- Following channel(s) was (were) selected for the final test as listed below.

CDD Mode						
Mode	FREQ. Band (MHz)	Available Channel	Tested Channel	Modulation Technology	Modulation Type	Data Rate (Mbps)
802.11a	5180-5240	36 to 48	36, 40, 48	OFDM	BPSK	6
802.11ac (VHT20)		36 to 48	36, 40, 48	OFDM	BPSK	6.5
802.11ac (VHT40)		38 to 46	38, 46	OFDM	BPSK	13.5
802.11ac (VHT80)		42	42	OFDM	BPSK	29.3
802.11a	5745-5825	149 to 165	149, 157, 165	OFDM	BPSK	6
802.11ac (VHT20)		149 to 165	149, 157, 165	OFDM	BPSK	6.5
802.11ac (VHT40)		151 to 159	151, 159	OFDM	BPSK	13.5
802.11ac (VHT80)		155	155	OFDM	BPSK	29.3

#### **Radiated Emission Test (Below 1GHz):**

- Pre-Scan has been conducted to determine the worst-case mode from all possible combinations between available modulations, data rates and antenna ports (if EUT with antenna diversity architecture).
- Following channel(s) was (were) selected for the final test as listed below.

CDD Mode						
Mode	FREQ. Band (MHz)	Available Channel	Tested Channel	Modulation Technology	Modulation Type	Data Rate (Mbps)
802.11ac (VHT40)	5180-5240, 5745-5825	38 to 46, 151 to 159	151	OFDM	BPSK	13.5

### Power Line Conducted Emission Test:

- Pre-Scan has been conducted to determine the worst-case mode from all possible combinations between available modulations, data rates and antenna ports (if EUT with antenna diversity architecture).
- Following channel(s) was (were) selected for the final test as listed below.

CDD Mode						
Mode	FREQ. Band (MHz)	Available Channel	Tested Channel	Modulation Technology	Modulation Type	Data Rate (Mbps)
802.11ac (VHT40)	5180-5240, 5745-5825	38 to 46, 151 to 159	151	OFDM	BPSK	13.5

### Antenna Port Conducted Measurement:

- This item includes all test value of each mode, but only includes spectrum plot of worst value of each mode.
- Pre-Scan has been conducted to determine the worst-case mode from all possible combinations between available modulations, data rates and antenna ports (if EUT with antenna diversity architecture).
- Following channel(s) was (were) selected for the final test as listed below.

CDD Mode						
Mode	FREQ. Band (MHz)	Available Channel	Tested Channel	Modulation Technology	Modulation Type	Data Rate (Mbps)
802.11a	5180-5240	36 to 48	36, 40, 48	OFDM	BPSK	6
802.11ac (VHT20)		36 to 48	36, 40, 48	OFDM	BPSK	6.5
802.11ac (VHT40)		38 to 46	38, 46	OFDM	BPSK	13.5
802.11ac (VHT80)		42	42	OFDM	BPSK	29.3
802.11a	5745-5825	149 to 165	149, 157, 165	OFDM	BPSK	6
802.11ac (VHT20)		149 to 165	149, 157, 165	OFDM	BPSK	6.5
802.11ac (VHT40)		151 to 159	151, 159	OFDM	BPSK	13.5
802.11ac (VHT80)		155	155	OFDM	BPSK	29.3

### Beamforming Mode (output power only)

Mode	FREQ. Band (MHz)	Available Channel	Tested Channel	Modulation Technology	Modulation Type	Data Rate (Mbps)
802.11ac (VHT20)	5180-5240	36 to 48	36, 40, 48	OFDM	BPSK	6.5
802.11ac (VHT40)		38 to 46	38, 46	OFDM	BPSK	13.5
802.11ac (VHT80)		42	42	OFDM	BPSK	29.3
802.11ac (VHT20)	5745-5825	149 to 165	149, 157, 165	OFDM	BPSK	6.5
802.11ac (VHT40)		151 to 159	151, 159	OFDM	BPSK	13.5
802.11ac (VHT80)		155	155	OFDM	BPSK	29.3

### Test Condition:

Applicable To	Environmental Conditions	Input Power	Tested By
RE $\geq$ 1G	22deg. C, 68%RH	120Vac, 60Hz	Steven Chiang
RE $<$ 1G	24deg. C, 67%RH	120Vac, 60Hz	Steven Chiang
PLC	23deg. C, 74%RH	120Vac, 60Hz	Andy Ho
APCM	25deg. C, 60%RH	120Vac, 60Hz	Jyunchun Lin

### 3.3 Duty Cycle of Test Signal

Duty cycle of test signal is < 98%, duty factor shall be considered.

**802.11a:** Duty cycle =  $2.027/2.109 = 0.961$ , Duty factor =  $10 * \log(1/0.961) = 0.17$

**802.11ac (VHT20):** Duty cycle =  $4.97/5.465 = 0.909$ , Duty factor =  $10 * \log(1/0.909) = 0.41$

**802.11ac (VHT40):** Duty cycle =  $2.414/2.902 = 0.832$ , Duty factor =  $10 * \log(1/0.832) = 0.80$

**802.11ac (VHT80):** Duty cycle =  $3.323/3.83 = 0.868$ , Duty factor =  $10 * \log(1/0.868) = 0.62$

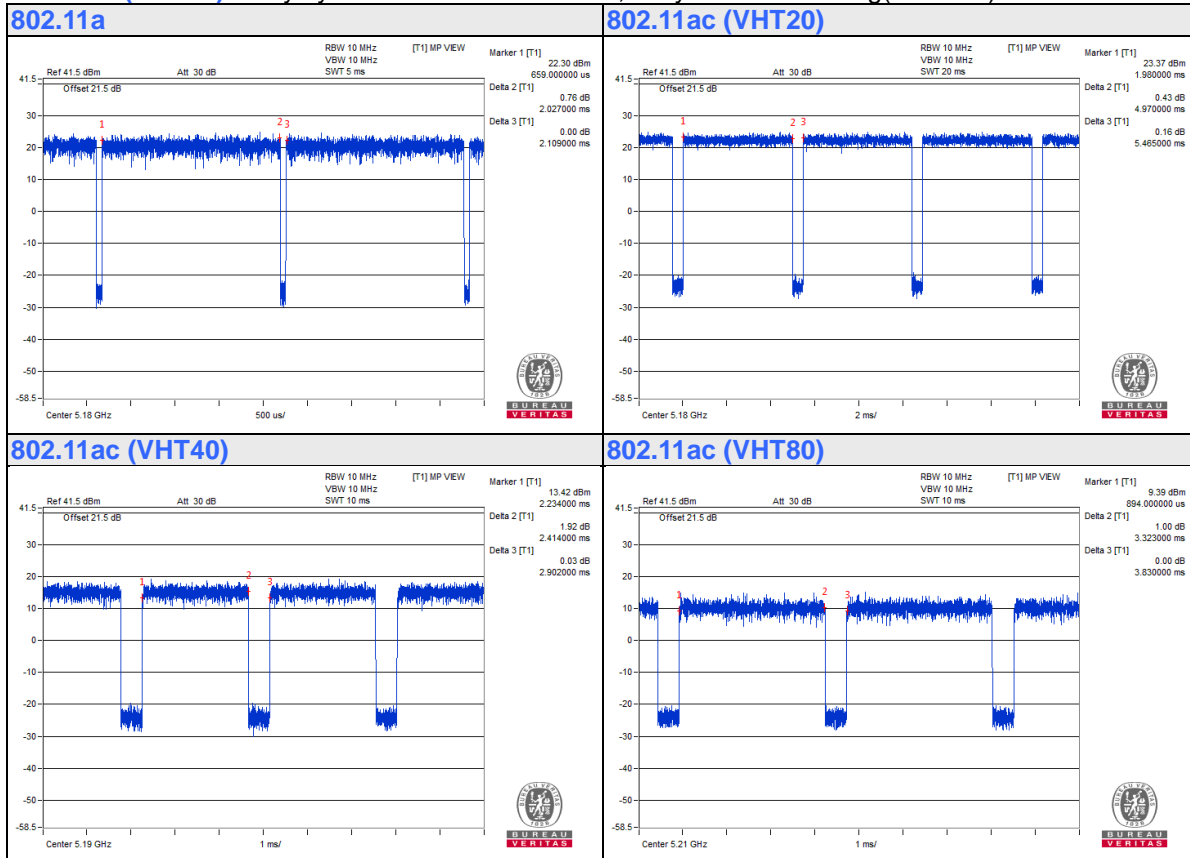

### 3.4 Description of Support Units

The EUT has been tested as an independent unit together with other necessary accessories or support units. The following support units or accessories were used to form a representative test configuration during the tests.

ID	Product	Brand	Model No.	Serial No.	FCC ID	Remarks
A.	Laptop	HP	Pavilion 14-ab023TU	5CD5340WXZ	NA	Provided by Lab

Note:

1. All power cords of the above support units are non-shielded (1.8m).

ID	Descriptions	Qty.	Length (m)	Shielding (Yes/No)	Cores (Qty.)	Remarks
1.	RJ-45 Cable	1	10	No	0	Provided by Lab

### 3.4.1 Configuration of System under Test

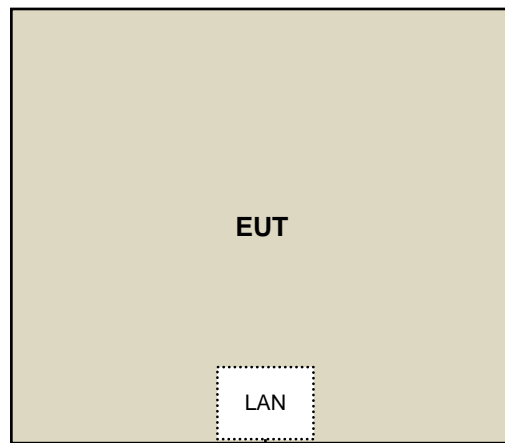

(1)



**Remote Site**

(A) Laptop

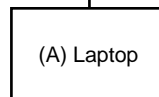

### 3.5 General Description of Applied Standard

The EUT is a RF Product. According to the specifications of the manufacturer, it must comply with the requirements of the following standards:

**FCC Part 15, Subpart E (15.407)**

**KDB 789033 D02 General UNII Test Procedure New Rules v02r01**

**KDB 662911 D01 Multiple Transmitter Output v02r01**

**ANSI C63.10-2013**

All test items have been performed and recorded as per the above standards.

## 4 Test Types and Results

### 4.1 Radiated Emission and Bandedge Measurement

#### 4.1.1 Limits of Radiated Emission and Bandedge Measurement

Radiated emissions which fall in the restricted bands must comply with the radiated emission limits specified as below table.

Frequencies (MHz)	Field Strength (microvolts/meter)	Measurement Distance (meters)
0.009 ~ 0.490	2400/F(kHz)	300
0.490 ~ 1.705	24000/F(kHz)	30
1.705 ~ 30.0	30	30
30 ~ 88	100	3
88 ~ 216	150	3
216 ~ 960	200	3
Above 960	500	3

#### NOTE:

1. The lower limit shall apply at the transition frequencies.
2. Emission level (dBuV/m) = 20 log Emission level (uV/m).
3. For frequencies above 1000MHz, the field strength limits are based on average detector, however, the peak field strength of any emission shall not exceed the maximum permitted average limits, specified above by more than 20dB under any condition of modulation.

Limits of unwanted emission out of the restricted bands

Applicable To		Limit	
789033 D02 General UNII Test Procedure New Rules v02r01		Field Strength at 3m	
		PK:74 (dBuV/m)	AV:54 (dBuV/m)
Frequency Band	Applicable To	EIRP Limit	Equivalent Field Strength at 3m
5150~5250 MHz	15.407(b)(1)	PK:-27 (dBm/MHz)	PK:68.2(dBuV/m)
5250~5350 MHz	15.407(b)(2)		
5470~5725 MHz	15.407(b)(3)		
5725~5850 MHz	<input checked="" type="checkbox"/> 15.407(b)(4)(i)	PK:-27 (dBm/MHz) <sup>*1</sup> PK:10 (dBm/MHz) <sup>*2</sup> PK:15.6 (dBm/MHz) <sup>*3</sup> PK:27 (dBm/MHz) <sup>*4</sup>	PK: 68.2(dBuV/m) <sup>*1</sup> PK:105.2 (dBuV/m) <sup>*2</sup> PK: 110.8(dBuV/m) <sup>*3</sup> PK:122.2 (dBuV/m) <sup>*4</sup>
	<input type="checkbox"/> 15.407(b)(4)(ii)	Emission limits in section 15.247(d)	
<sup>*1</sup> beyond 75 MHz or more above of the band edge.		<sup>*2</sup> below the band edge increasing linearly to 10 dBm/MHz at 25 MHz above.	
<sup>*3</sup> below the band edge increasing linearly to a level of 15.6 dBm/MHz at 5 MHz above.		<sup>*4</sup> from 5 MHz above or below the band edge increasing linearly to a level of 27 dBm/MHz at the band edge.	

#### Note:

The following formula is used to convert the equipment isotropic radiated power (eirp) to field strength:

$$E = \frac{1000000\sqrt{30P}}{3} \mu\text{V/m, where } P \text{ is the eirp (Watts).}$$



#### 4.1.2 Test Instruments

##### For OOB test item:

DESCRIPTION & MANUFACTURER	MODEL NO.	SERIAL NO.	CALIBRATED DATE	CALIBRATED UNTIL
Test Receiver Keysight	N9038A	MY54450088	July 05, 2018	July 04, 2019
Horn_Antenna SCHWARZBECK	BBHA 9120D	9120D-783	Nov. 25, 2018	Nov. 24, 2019
Pre-Amplifier Mini-Circuits	ZVA-183-S+	AMP-ZVA-03	May 10, 2018	May 09, 2019
RF Cable	EMC104-SM-SM-1200	160923	Jan. 29, 2018	Jan. 28, 2019
RF Cable	EMC104-SM-SM-2000	150318	Jan. 29, 2018	Jan. 28, 2019
RF Cable	EMC104-SM-SM-5000	150321	Jan. 29, 2018	Jan. 28, 2019
Pre-Amplifier EMCI	EMC184045SE	980387	Jan. 29, 2018	Jan. 28, 2019
Horn_Antenna SCHWARZBECK	BBHA 9170	BBHA9170608	Nov. 25, 2018	Nov. 24, 2019
RF Cable	EMC102-KM-KM-1200	160925	Jan. 29, 2018	Jan. 28, 2019
Software	ADT_Radiated_V8.7.08	NA	NA	NA
Boresight Antenna Tower & Turn Table Max-Full	MF-7802BS	MF780208530	NA	NA

##### Note:

1. The calibration interval of the above test instruments is 12 months and the calibrations are traceable to NML/ROC and NIST/USA.
2. The test was performed in 966 Chamber No. 4.
3. The CANADA Site Registration No. is 20331-2
4. Tested Date: Jan. 11, 2019

**For other test items:**

DESCRIPTION & MANUFACTURER	MODEL NO.	SERIAL NO.	CALIBRATED DATE	CALIBRATED UNTIL
Test Receiver Keysight	N9038A	MY54450088	July 05, 2018	July 04, 2019
Pre-Amplifier EMC1	EMC001340	980142	Feb. 09, 2018	Feb. 08, 2019
Loop Antenna Electro-Metrics	EM-6879	269	Sep. 07, 2018	Sep. 06, 2019
RF Cable	NA	LOOPCAB-001	Jan. 14, 2019	Jan. 13, 2020
RF Cable	NA	LOOPCAB-002	Jan. 14, 2019	Jan. 13, 2020
Pre-Amplifier Mini-Circuits	ZFL-1000VH2B	AMP-ZFL-01	Oct. 30, 2018	Oct. 29, 2019
Trilog Broadband Antenna SCHWARZBECK	VULB 9168	9168-406	Nov. 22, 2018	Nov. 21, 2019
RF Cable	8D	966-4-1	Mar. 21, 2018	Mar. 20, 2019
RF Cable	8D	966-4-2	Mar. 21, 2018	Mar. 20, 2019
RF Cable	8D	966-4-3	Mar. 21, 2018	Mar. 20, 2019
Fixed attenuator Mini-Circuits	UNAT-5+	PAD-3m-4-01	Sep. 27, 2018	Sep. 26, 2019
Horn_Antenna SCHWARZBECK	BBHA 9120D	9120D-783	Nov. 25, 2018	Nov. 24, 2019
Pre-Amplifier Mini-Circuits	ZVA-183-S+	AMP-ZVA-03	May 10, 2018	May 09, 2019
RF Cable	EMC104-SM-SM-1200	160923	Jan. 29, 2018	Jan. 28, 2019
RF Cable	EMC104-SM-SM-2000	150318	Jan. 29, 2018	Jan. 28, 2019
RF Cable	EMC104-SM-SM-5000	150321	Jan. 29, 2018	Jan. 28, 2019
Pre-Amplifier EMC1	EMC184045SE	980387	Jan. 29, 2018	Jan. 28, 2019
Horn_Antenna SCHWARZBECK	BBHA 9170	BBHA9170608	Nov. 25, 2018	Nov. 24, 2019
RF Cable	EMC102-KM-KM-1200	160925	Jan. 29, 2018	Jan. 28, 2019
Software	ADT_Radiated_V8.7.08	NA	NA	NA
Boresight Antenna Tower & Turn Table Max-Full	MF-7802BS	MF780208530	NA	NA
Spectrum Analyzer R&S	FSV40	100964	June 20, 2018	June 19, 2019
Power meter Anritsu	ML2495A	1014008	May 09, 2018	May 08, 2019
Power sensor Anritsu	MA2411B	0917122	May 09, 2018	May 08, 2019
Fixed Attenuator Mini-Circuits	MDCS18N-10	MDCS18N-10-01	Apr. 16, 2018	Apr. 15, 2019
AC Power Source Extech Electronics	6205	1440452	NA	NA
Temperature & Humidity Chamber Giant Force	GTH-150-40-SP-AR	MAA0812-008	Jan. 09, 2019	Jan. 08, 2020
True RMS Clamp Meter FLUKE	325	31130711WS	May 22, 2018	May 21, 2019

**Note:**

1. The calibration interval of the above test instruments is 12 months and the calibrations are traceable to NML/ROC and NIST/USA.
2. The test was performed in 966 Chamber No. 4.
3. The CANADA Site Registration No. is 20331-2
4. Loop antenna was used for all emissions below 30 MHz.
5. Tested Date: Jan. 18 to 23, 2019

#### 4.1.3 Test Procedure

##### **For Radiated emission below 30MHz**

- a. The EUT was placed on the top of a rotating table 0.8 meters above the ground at a 3 meter chamber room. The table was rotated 360 degrees to determine the position of the highest radiation.
- b. The EUT was set 3 meters away from the interference-receiving antenna, which was mounted on the top of a variable-height antenna tower.
- c. Parallel, perpendicular, and ground-parallel orientations of the antenna are set to make the measurement.
- d. For each suspected emission, the EUT was arranged to its worst case and the rotatable table was turned from 0 degrees to 360 degrees to find the maximum reading.
- e. The test-receiver system was set to Quasi-Peak Detect Function and Specified Bandwidth with Maximum Hold Mode.

##### **Note:**

1. The resolution bandwidth and video bandwidth of test receiver/spectrum analyzer is 9kHz at frequency below 30MHz.

##### **For Radiated emission above 30MHz**

- a. The EUT was placed on the top of a rotating table 0.8 meters (for 30MHz ~ 1GHz) / 1.5 meters (for above 1GHz) above the ground at 3 meter chamber room for test. The table was rotated 360 degrees to determine the position of the highest radiation.
- b. The EUT was set 3 meters away from the interference-receiving antenna, which was mounted on the top of a variable-height antenna tower.
- c. The height of antenna is varied from one meter to four meters above the ground to determine the maximum value of the field strength. Both horizontal and vertical polarizations of the antenna are set to make the measurement.
- d. For each suspected emission, the EUT was arranged to its worst case and then the antenna was tuned to heights from 1 meter to 4 meters and the rotatable table was turned from 0 degrees to 360 degrees to find the maximum reading.
- e. The test-receiver system was set to quasi-peak detect function and specified bandwidth with maximum hold mode when the test frequency is below 1 GHz.
- f. The test-receiver system was set to peak and average detects function and specified bandwidth with maximum hold mode when the test frequency is above 1 GHz. If the peak reading value also meets average limit, measurement with the average detector is unnecessary.

##### **Note:**

1. The resolution bandwidth and video bandwidth of test receiver/spectrum analyzer is 120kHz for Quasi-peak detection (QP) at frequency below 1GHz.
2. The resolution bandwidth of test receiver/spectrum analyzer is 1 MHz and the video bandwidth is 3 MHz for Peak detection (PK) at frequency above 1GHz.
3. The resolution bandwidth of test receiver/spectrum analyzer is 1MHz and the video bandwidth is  $\geq 1/T$  (Duty cycle < 98%) or 10Hz (Duty cycle  $\geq 98\%$ ) for Average detection (AV) at frequency above 1GHz.
4. All modes of operation were investigated and the worst-case emissions are reported.

#### 4.1.4 Deviation from Test Standard

No deviation.

#### 4.1.5 Test Setup

##### For Radiated emission below 30MHz

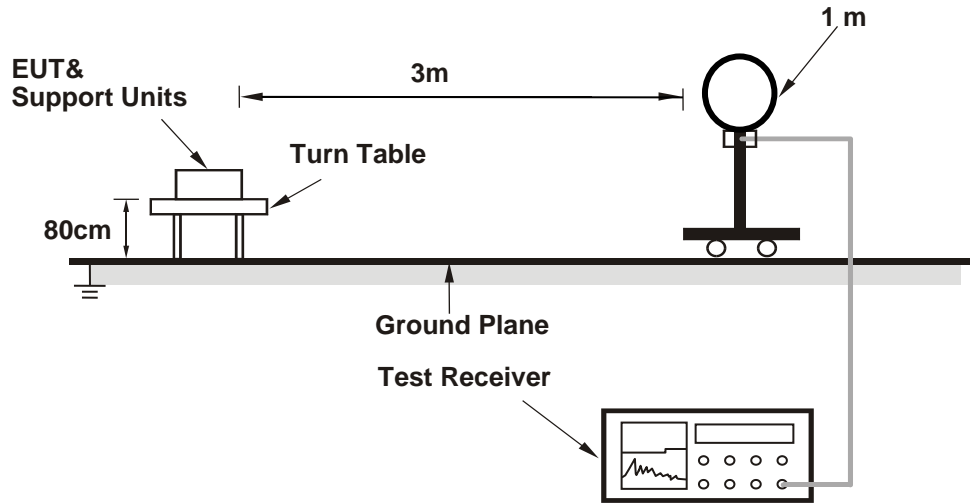

##### For Radiated emission 30MHz to 1GHz

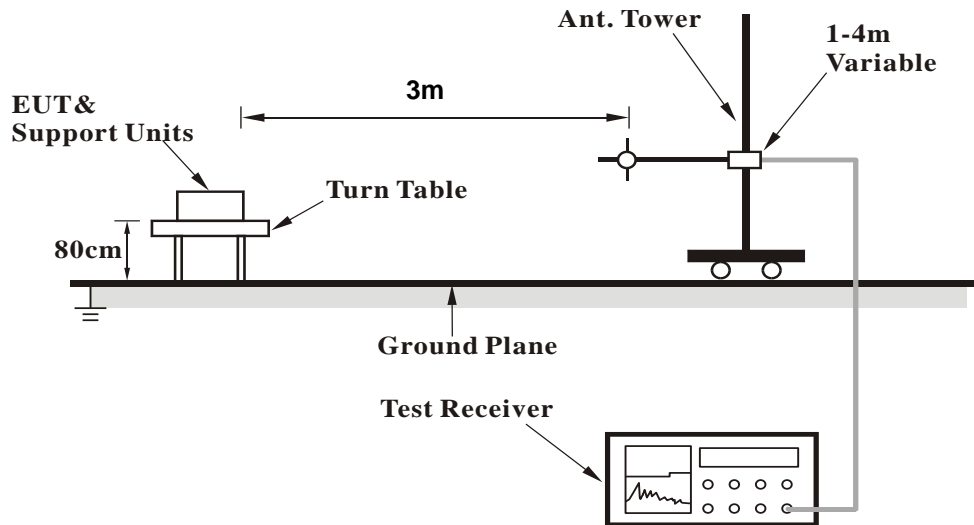

### For Radiated emission above 1GHz

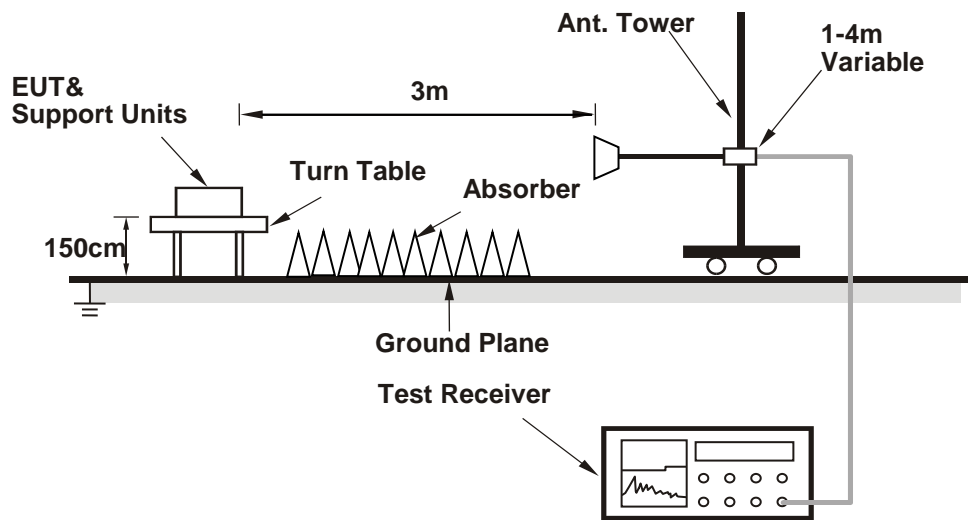

For the actual test configuration, please refer to the attached file (Test Setup Photo).

#### 4.1.6 EUT Operating Condition

- a. Connected the EUT with the Laptop which is placed on remote site.
- b. Controlling software (QSPR (version-5.0-00086)) has been activated to set the EUT on specific status.

## 4.1.7 Test Results

**CDD Mode**

## Above 1GHz Data:

## 802.11a

<b>CHANNEL</b>	TX Channel 36	<b>DETECTOR FUNCTION</b>	Peak (PK)
<b>FREQUENCY RANGE</b>	1GHz ~ 40GHz		Average (AV)

**ANTENNA POLARITY & TEST DISTANCE: HORIZONTAL AT 3 M**

NO.	FREQ. (MHz)	EMISSION LEVEL (dBuV/m)	LIMIT (dBuV/m)	MARGIN (dB)	ANTENNA HEIGHT (m)	TABLE ANGLE (Degree)	RAW VALUE (dBuV)	CORRECTION FACTOR (dB/m)
1	5150.00	65.8 PK	74.0	-8.2	1.03 H	2	62.8	3.0
2	5150.00	53.5 AV	54.0	-0.5	1.03 H	2	50.5	3.0
3	*5180.00	116.3 PK			1.03 H	2	113.4	2.9
4	*5180.00	106.1 AV			1.03 H	2	103.2	2.9
5	#10360.00	45.8 PK	68.2	-22.4	1.70 H	21	32.8	13.0
6	15540.00	57.0 PK	74.0	-17.0	2.75 H	163	43.9	13.1
7	15540.00	44.4 AV	54.0	-9.6	2.75 H	163	31.3	13.1

**ANTENNA POLARITY & TEST DISTANCE: VERTICAL AT 3 M**

NO.	FREQ. (MHz)	EMISSION LEVEL (dBuV/m)	LIMIT (dBuV/m)	MARGIN (dB)	ANTENNA HEIGHT (m)	TABLE ANGLE (Degree)	RAW VALUE (dBuV)	CORRECTION FACTOR (dB/m)
1	5150.00	62.9 PK	74.0	-11.1	1.04 V	64	59.9	3.0
2	5150.00	47.7 AV	54.0	-6.3	1.04 V	64	44.7	3.0
3	*5180.00	114.4 PK			1.04 V	64	111.5	2.9
4	*5180.00	104.3 AV			1.04 V	64	101.4	2.9
5	#10360.00	45.1 PK	68.2	-23.1	1.95 V	298	32.1	13.0
6	15540.00	55.1 PK	74.0	-18.9	1.09 V	163	42.0	13.1
7	15540.00	42.3 AV	54.0	-11.7	1.09 V	163	29.2	13.1

**REMARKS:**

1. Emission Level(dBuV/m) = Raw Value(dBuV) + Correction Factor(dB/m)
2. Correction Factor(dB/m) = Antenna Factor(dB/m) + Cable Factor(dB) – Pre-Amplifier Factor(dB)
3. The other emission levels were very low against the limit.
4. Margin value = Emission Level – Limit value
5. " \* ": Fundamental frequency.
6. " # ": The radiated frequency is out of the restricted band.

<b>CHANNEL</b>	TX Channel 40	<b>DETECTOR FUNCTION</b>	Peak (PK)
<b>FREQUENCY RANGE</b>	1GHz ~ 40GHz		Average (AV)

**ANTENNA POLARITY & TEST DISTANCE: HORIZONTAL AT 3 M**

NO.	FREQ. (MHz)	EMISSION LEVEL (dBuV/m)	LIMIT (dBuV/m)	MARGIN (dB)	ANTENNA HEIGHT (m)	TABLE ANGLE (Degree)	RAW VALUE (dBuV)	CORRECTION FACTOR (dB/m)
1	5150.00	58.1 PK	74.0	-15.9	1.30 H	3	55.1	3.0
2	5150.00	46.1 AV	54.0	-7.9	1.30 H	3	43.1	3.0
3	*5200.00	118.2 PK			1.30 H	3	115.3	2.9
4	*5200.00	108.9 AV			1.30 H	3	106.0	2.9
5	#10400.00	45.8 PK	68.2	-22.4	1.65 H	6	32.7	13.1
6	15600.00	56.6 PK	74.0	-17.4	2.74 H	166	43.6	13.0
7	15600.00	43.9 AV	54.0	-10.1	2.74 H	166	30.9	13.0

**ANTENNA POLARITY & TEST DISTANCE: VERTICAL AT 3 M**

NO.	FREQ. (MHz)	EMISSION LEVEL (dBuV/m)	LIMIT (dBuV/m)	MARGIN (dB)	ANTENNA HEIGHT (m)	TABLE ANGLE (Degree)	RAW VALUE (dBuV)	CORRECTION FACTOR (dB/m)
1	5150.00	52.3 PK	74.0	-21.7	1.03 V	57	49.3	3.0
2	5150.00	40.5 AV	54.0	-13.5	1.03 V	57	37.5	3.0
3	*5200.00	116.4 PK			1.03 V	57	113.5	2.9
4	*5200.00	107.1 AV			1.03 V	57	104.2	2.9
5	#10400.00	45.4 PK	68.2	-22.8	1.98 V	296	32.3	13.1
6	15600.00	55.3 PK	74.0	-18.7	1.09 V	178	42.3	13.0
7	15600.00	42.4 AV	54.0	-11.6	1.09 V	178	29.4	13.0

**REMARKS:**

1. Emission Level(dBuV/m) = Raw Value(dBuV) + Correction Factor(dB/m)
2. Correction Factor(dB/m) = Antenna Factor(dB/m) + Cable Factor(dB) – Pre-Amplifier Factor(dB)
3. The other emission levels were very low against the limit.
4. Margin value = Emission Level – Limit value
5. " \* ": Fundamental frequency.
6. " # ": The radiated frequency is out of the restricted band.



<b>CHANNEL</b>	TX Channel 48	<b>DETECTOR FUNCTION</b>	Peak (PK)
<b>FREQUENCY RANGE</b>	1GHz ~ 40GHz		Average (AV)

**ANTENNA POLARITY & TEST DISTANCE: HORIZONTAL AT 3 M**

NO.	FREQ. (MHz)	EMISSION LEVEL (dBuV/m)	LIMIT (dBuV/m)	MARGIN (dB)	ANTENNA HEIGHT (m)	TABLE ANGLE (Degree)	RAW VALUE (dBuV)	CORRECTION FACTOR (dB/m)
1	4922.80	56.6 PK	74.0	-17.4	2.18 H	360	54.6	2.0
2	4922.80	48.0 AV	54.0	-6.0	2.18 H	360	46.0	2.0
3	*5240.00	118.7 PK			2.18 H	360	116.2	2.5
4	*5240.00	108.5 AV			2.18 H	360	106.0	2.5
5	5406.90	50.6 PK	74.0	-23.4	2.18 H	360	47.6	3.0
6	5406.90	38.7 AV	54.0	-15.3	2.18 H	360	35.7	3.0
7	#10480.00	46.2 PK	68.2	-22.0	1.69 H	9	33.0	13.2
8	15720.00	56.8 PK	74.0	-17.2	2.69 H	175	44.4	12.4
9	15720.00	44.2 AV	54.0	-9.8	2.69 H	175	31.8	12.4

**ANTENNA POLARITY & TEST DISTANCE: VERTICAL AT 3 M**

NO.	FREQ. (MHz)	EMISSION LEVEL (dBuV/m)	LIMIT (dBuV/m)	MARGIN (dB)	ANTENNA HEIGHT (m)	TABLE ANGLE (Degree)	RAW VALUE (dBuV)	CORRECTION FACTOR (dB/m)
1	*5240.00	116.5 PK			1.04 V	68	114.0	2.5
2	*5240.00	106.4 AV			1.04 V	68	103.9	2.5
3	5350.00	47.6 PK	74.0	-26.4	1.04 V	68	44.8	2.8
4	5350.00	35.5 AV	54.0	-18.5	1.04 V	68	32.7	2.8
5	#10480.00	46.1 PK	68.2	-22.1	2.01 V	300	32.9	13.2
6	15720.00	55.4 PK	74.0	-18.6	1.06 V	171	43.0	12.4
7	15720.00	42.7 AV	54.0	-11.3	1.06 V	171	30.3	12.4

**REMARKS:**

1. Emission Level(dBuV/m) = Raw Value(dBuV) + Correction Factor(dB/m)
2. Correction Factor(dB/m) = Antenna Factor(dB/m) + Cable Factor(dB) – Pre-Amplifier Factor(dB)
3. The other emission levels were very low against the limit.
4. Margin value = Emission Level – Limit value
5. " \* ": Fundamental frequency.
6. " # ": The radiated frequency is out of the restricted band.

<b>CHANNEL</b>	TX Channel 149	<b>DETECTOR FUNCTION</b>	Peak (PK)
<b>FREQUENCY RANGE</b>	1GHz ~ 40GHz		Average (AV)

**ANTENNA POLARITY & TEST DISTANCE: HORIZONTAL AT 3 M**

NO.	FREQ. (MHz)	EMISSION LEVEL (dBuV/m)	LIMIT (dBuV/m)	MARGIN (dB)	ANTENNA HEIGHT (m)	TABLE ANGLE (Degree)	RAW VALUE (dBuV)	CORRECTION FACTOR (dB/m)
1	#5632.19	54.9 PK	68.2	-13.3	2.05 H	342	51.7	3.2
2	*5745.00	117.4 PK			2.05 H	342	113.8	3.6
3	*5745.00	108.2 AV			2.05 H	342	104.6	3.6
4	#5947.46	51.0 PK	68.2	-17.2	2.05 H	342	47.1	3.9
5	11490.00	48.3 PK	74.0	-25.7	1.20 H	298	34.5	13.8
6	11490.00	35.8 AV	54.0	-18.2	1.20 H	298	22.0	13.8
7	#17235.00	61.3 PK	68.2	-6.9	2.28 H	145	44.2	17.1

**ANTENNA POLARITY & TEST DISTANCE: VERTICAL AT 3 M**

NO.	FREQ. (MHz)	EMISSION LEVEL (dBuV/m)	LIMIT (dBuV/m)	MARGIN (dB)	ANTENNA HEIGHT (m)	TABLE ANGLE (Degree)	RAW VALUE (dBuV)	CORRECTION FACTOR (dB/m)
1	#5586.40	53.1 PK	68.2	-15.1	2.05 V	76	49.8	3.3
2	*5745.00	117.1 PK			2.05 V	76	113.5	3.6
3	*5745.00	107.1 AV			2.05 V	76	103.5	3.6
4	#6001.25	52.1 PK	68.2	-16.1	2.05 V	76	48.1	4.0
5	11490.00	48.2 PK	74.0	-25.8	1.99 V	303	34.4	13.8
6	11490.00	35.5 AV	54.0	-18.5	1.99 V	303	21.7	13.8
7	#17235.00	58.3 PK	68.2	-9.9	1.07 V	183	41.2	17.1

**REMARKS:**

1. Emission Level(dBuV/m) = Raw Value(dBuV) + Correction Factor(dB/m)
2. Correction Factor(dB/m) = Antenna Factor(dB/m) + Cable Factor(dB) – Pre-Amplifier Factor(dB)
3. The other emission levels were very low against the limit.
4. Margin value = Emission Level – Limit value
5. " \* ": Fundamental frequency.
6. " # ": The radiated frequency is out of the restricted band.

<b>CHANNEL</b>	TX Channel 157	<b>DETECTOR FUNCTION</b>	Peak (PK)
<b>FREQUENCY RANGE</b>	1GHz ~ 40GHz		Average (AV)

**ANTENNA POLARITY & TEST DISTANCE: HORIZONTAL AT 3 M**

NO.	FREQ. (MHz)	EMISSION LEVEL (dBuV/m)	LIMIT (dBuV/m)	MARGIN (dB)	ANTENNA HEIGHT (m)	TABLE ANGLE (Degree)	RAW VALUE (dBuV)	CORRECTION FACTOR (dB/m)
1	#5627.22	54.2 PK	68.2	-14.0	2.06 H	345	50.9	3.3
2	*5785.00	117.0 PK			2.06 H	345	113.4	3.6
3	*5785.00	107.2 AV			2.06 H	345	103.6	3.6
4	#5948.15	51.2 PK	68.2	-17.0	2.06 H	345	47.3	3.9
5	11570.00	49.7 PK	74.0	-24.3	1.16 H	286	36.0	13.7
6	11570.00	36.6 AV	54.0	-17.4	1.16 H	286	22.9	13.7
7	#17355.00	60.9 PK	68.2	-7.3	2.23 H	167	43.3	17.6

**ANTENNA POLARITY & TEST DISTANCE: VERTICAL AT 3 M**

NO.	FREQ. (MHz)	EMISSION LEVEL (dBuV/m)	LIMIT (dBuV/m)	MARGIN (dB)	ANTENNA HEIGHT (m)	TABLE ANGLE (Degree)	RAW VALUE (dBuV)	CORRECTION FACTOR (dB/m)
1	#5559.73	53.2 PK	68.2	-15.0	2.09 V	233	50.0	3.2
2	*5785.00	117.0 PK			2.09 V	233	113.4	3.6
3	*5785.00	106.9 AV			2.09 V	233	103.3	3.6
4	#5976.99	51.2 PK	68.2	-17.0	2.09 V	233	47.2	4.0
5	11570.00	48.5 PK	74.0	-25.5	2.02 V	331	34.8	13.7
6	11570.00	36.1 AV	54.0	-17.9	2.02 V	331	22.4	13.7
7	#17355.00	58.1 PK	68.2	-10.1	1.09 V	171	40.5	17.6

**REMARKS:**

1. Emission Level(dBuV/m) = Raw Value(dBuV) + Correction Factor(dB/m)
2. Correction Factor(dB/m) = Antenna Factor(dB/m) + Cable Factor(dB) – Pre-Amplifier Factor(dB)
3. The other emission levels were very low against the limit.
4. Margin value = Emission Level – Limit value
5. " \* ": Fundamental frequency.
6. " # ": The radiated frequency is out of the restricted band.

<b>CHANNEL</b>	TX Channel 165	<b>DETECTOR FUNCTION</b>	Peak (PK)
<b>FREQUENCY RANGE</b>	1GHz ~ 40GHz		Average (AV)

**ANTENNA POLARITY & TEST DISTANCE: HORIZONTAL AT 3 M**

NO.	FREQ. (MHz)	EMISSION LEVEL (dBuV/m)	LIMIT (dBuV/m)	MARGIN (dB)	ANTENNA HEIGHT (m)	TABLE ANGLE (Degree)	RAW VALUE (dBuV)	CORRECTION FACTOR (dB/m)
1	#5609.81	55.6 PK	68.2	-12.6	1.15 H	103	52.2	3.4
2	*5825.00	117.0 PK			1.15 H	103	113.2	3.8
3	*5825.00	106.8 AV			1.15 H	103	103.0	3.8
4	#5938.13	54.0 PK	68.2	-14.2	1.15 H	103	50.1	3.9
5	11650.00	49.0 PK	74.0	-25.0	1.22 H	301	35.4	13.6
6	11650.00	36.2 AV	54.0	-17.8	1.22 H	301	22.6	13.6
7	#17475.00	61.0 PK	68.2	-7.2	2.26 H	160	42.4	18.6

**ANTENNA POLARITY & TEST DISTANCE: VERTICAL AT 3 M**

NO.	FREQ. (MHz)	EMISSION LEVEL (dBuV/m)	LIMIT (dBuV/m)	MARGIN (dB)	ANTENNA HEIGHT (m)	TABLE ANGLE (Degree)	RAW VALUE (dBuV)	CORRECTION FACTOR (dB/m)
1	#5585.47	55.6 PK	68.2	-12.6	1.20 V	77	52.3	3.3
2	*5825.00	116.4 PK			1.20 V	77	112.6	3.8
3	*5825.00	106.2 AV			1.20 V	77	102.4	3.8
4	#5971.05	54.1 PK	68.2	-14.1	1.20 V	77	50.1	4.0
5	11650.00	48.5 PK	74.0	-25.5	2.02 V	316	34.9	13.6
6	11650.00	35.9 AV	54.0	-18.1	2.02 V	316	22.3	13.6
7	#17475.00	58.3 PK	68.2	-9.9	1.12 V	175	39.7	18.6

**REMARKS:**

1. Emission Level(dBuV/m) = Raw Value(dBuV) + Correction Factor(dB/m)
2. Correction Factor(dB/m) = Antenna Factor(dB/m) + Cable Factor(dB) – Pre-Amplifier Factor(dB)
3. The other emission levels were very low against the limit.
4. Margin value = Emission Level – Limit value
5. " \* ": Fundamental frequency.
6. " # ": The radiated frequency is out of the restricted band.

**802.11ac (VHT20)**

<b>CHANNEL</b>	TX Channel 36	<b>DETECTOR FUNCTION</b>	Peak (PK)
<b>FREQUENCY RANGE</b>	1GHz ~ 40GHz		Average (AV)

**ANTENNA POLARITY & TEST DISTANCE: HORIZONTAL AT 3 M**

NO.	FREQ. (MHz)	EMISSION LEVEL (dBuV/m)	LIMIT (dBuV/m)	MARGIN (dB)	ANTENNA HEIGHT (m)	TABLE ANGLE (Degree)	RAW VALUE (dBuV)	CORRECTION FACTOR (dB/m)
1	5150.00	64.6 PK	74.0	-9.4	2.12 H	360	61.6	3.0
2	5150.00	53.6 AV	54.0	-0.4	2.12 H	360	50.6	3.0
3	*5180.00	116.3 PK			2.12 H	360	113.4	2.9
4	*5180.00	106.1 AV			2.12 H	360	103.2	2.9
5	#10360.00	45.8 PK	68.2	-22.4	1.63 H	12	32.8	13.0
6	15540.00	56.4 PK	74.0	-17.6	2.71 H	168	43.3	13.1
7	15540.00	43.9 AV	54.0	-10.1	2.71 H	168	30.8	13.1

**ANTENNA POLARITY & TEST DISTANCE: VERTICAL AT 3 M**

NO.	FREQ. (MHz)	EMISSION LEVEL (dBuV/m)	LIMIT (dBuV/m)	MARGIN (dB)	ANTENNA HEIGHT (m)	TABLE ANGLE (Degree)	RAW VALUE (dBuV)	CORRECTION FACTOR (dB/m)
1	5150.00	61.2 PK	74.0	-12.8	1.01 V	51	58.2	3.0
2	5150.00	50.4 AV	54.0	-3.6	1.01 V	51	47.4	3.0
3	*5180.00	114.5 PK			1.01 V	51	111.6	2.9
4	*5180.00	104.3 AV			1.01 V	51	101.4	2.9
5	#10360.00	44.8 PK	68.2	-23.4	2.01 V	309	31.8	13.0
6	15540.00	55.3 PK	74.0	-18.7	1.12 V	171	42.2	13.1
7	15540.00	42.7 AV	54.0	-11.3	1.12 V	171	29.6	13.1

**REMARKS:**

1. Emission Level(dBuV/m) = Raw Value(dBuV) + Correction Factor(dB/m)
2. Correction Factor(dB/m) = Antenna Factor(dB/m) + Cable Factor(dB) – Pre-Amplifier Factor(dB)
3. The other emission levels were very low against the limit.
4. Margin value = Emission Level – Limit value
5. " \* ": Fundamental frequency.
6. " # ": The radiated frequency is out of the restricted band.

<b>CHANNEL</b>	TX Channel 40	<b>DETECTOR FUNCTION</b>	Peak (PK)
<b>FREQUENCY RANGE</b>	1GHz ~ 40GHz		Average (AV)

**ANTENNA POLARITY & TEST DISTANCE: HORIZONTAL AT 3 M**

NO.	FREQ. (MHz)	EMISSION LEVEL (dBuV/m)	LIMIT (dBuV/m)	MARGIN (dB)	ANTENNA HEIGHT (m)	TABLE ANGLE (Degree)	RAW VALUE (dBuV)	CORRECTION FACTOR (dB/m)
1	*5200.00	119.0 PK			2.13 H	358	116.1	2.9
2	*5200.00	108.8 AV			2.13 H	358	105.9	2.9
3	#10400.00	46.0 PK	68.2	-22.2	1.59 H	21	32.9	13.1
4	15600.00	56.2 PK	74.0	-17.8	2.72 H	181	43.2	13.0
5	15600.00	43.6 AV	54.0	-10.4	2.72 H	181	30.6	13.0

**ANTENNA POLARITY & TEST DISTANCE: VERTICAL AT 3 M**

NO.	FREQ. (MHz)	EMISSION LEVEL (dBuV/m)	LIMIT (dBuV/m)	MARGIN (dB)	ANTENNA HEIGHT (m)	TABLE ANGLE (Degree)	RAW VALUE (dBuV)	CORRECTION FACTOR (dB/m)
1	*5200.00	117.2 PK			1.10 V	74	114.3	2.9
2	*5200.00	106.8 AV			1.10 V	74	103.9	2.9
3	#10400.00	45.7 PK	68.2	-22.5	1.99 V	312	32.6	13.1
4	15600.00	55.3 PK	74.0	-18.7	1.06 V	184	42.3	13.0
5	15600.00	42.2 AV	54.0	-11.8	1.06 V	184	29.2	13.0

**REMARKS:**

1. Emission Level(dBuV/m) = Raw Value(dBuV) + Correction Factor(dB/m)
2. Correction Factor(dB/m) = Antenna Factor(dB/m) + Cable Factor(dB) – Pre-Amplifier Factor(dB)
3. The other emission levels were very low against the limit.
4. Margin value = Emission Level – Limit value
5. " \* ": Fundamental frequency.
6. " # ": The radiated frequency is out of the restricted band.

<b>CHANNEL</b>	TX Channel 48	<b>DETECTOR FUNCTION</b>	Peak (PK)
<b>FREQUENCY RANGE</b>	1GHz ~ 40GHz		Average (AV)

**ANTENNA POLARITY & TEST DISTANCE: HORIZONTAL AT 3 M**

NO.	FREQ. (MHz)	EMISSION LEVEL (dBuV/m)	LIMIT (dBuV/m)	MARGIN (dB)	ANTENNA HEIGHT (m)	TABLE ANGLE (Degree)	RAW VALUE (dBuV)	CORRECTION FACTOR (dB/m)
1	4927.80	57.4 PK	74.0	-16.6	2.18 H	360	55.4	2.0
2	4927.80	49.0 AV	54.0	-5.0	2.18 H	360	47.0	2.0
3	*5240.00	118.7 PK			2.18 H	360	116.2	2.5
4	*5240.00	108.7 AV			2.18 H	360	106.2	2.5
5	5403.60	51.3 PK	74.0	-22.7	2.18 H	360	48.4	2.9
6	5403.60	39.2 AV	54.0	-14.8	2.18 H	360	36.3	2.9
7	#10480.00	46.6 PK	68.2	-21.6	1.60 H	2	33.4	13.2
8	15720.00	56.7 PK	74.0	-17.3	2.79 H	155	44.3	12.4
9	15720.00	44.2 AV	54.0	-9.8	2.79 H	155	31.8	12.4

**ANTENNA POLARITY & TEST DISTANCE: VERTICAL AT 3 M**

NO.	FREQ. (MHz)	EMISSION LEVEL (dBuV/m)	LIMIT (dBuV/m)	MARGIN (dB)	ANTENNA HEIGHT (m)	TABLE ANGLE (Degree)	RAW VALUE (dBuV)	CORRECTION FACTOR (dB/m)
1	*5240.00	116.2 PK			1.07 V	54	113.7	2.5
2	*5240.00	106.4 AV			1.07 V	54	103.9	2.5
3	5350.00	51.2 PK	74.0	-22.8	1.07 V	54	48.4	2.8
4	5350.00	38.6 AV	54.0	-15.4	1.07 V	54	35.8	2.8
5	#10480.00	45.3 PK	68.2	-22.9	1.94 V	297	32.1	13.2
6	15720.00	55.1 PK	74.0	-18.9	1.05 V	183	42.7	12.4
7	15720.00	42.5 AV	54.0	-11.5	1.05 V	183	30.1	12.4

**REMARKS:**

1. Emission Level(dBuV/m) = Raw Value(dBuV) + Correction Factor(dB/m)
2. Correction Factor(dB/m) = Antenna Factor(dB/m) + Cable Factor(dB) – Pre-Amplifier Factor(dB)
3. The other emission levels were very low against the limit.
4. Margin value = Emission Level – Limit value
5. " \* ": Fundamental frequency.
6. " # ": The radiated frequency is out of the restricted band.

<b>CHANNEL</b>	TX Channel 149	<b>DETECTOR FUNCTION</b>	Peak (PK)
<b>FREQUENCY RANGE</b>	1GHz ~ 40GHz		Average (AV)

**ANTENNA POLARITY & TEST DISTANCE: HORIZONTAL AT 3 M**

NO.	FREQ. (MHz)	EMISSION LEVEL (dBuV/m)	LIMIT (dBuV/m)	MARGIN (dB)	ANTENNA HEIGHT (m)	TABLE ANGLE (Degree)	RAW VALUE (dBuV)	CORRECTION FACTOR (dB/m)
1	#5616.95	54.7 PK	68.2	-13.5	2.05 H	342	51.3	3.4
2	*5745.00	117.1 PK			2.05 H	342	113.5	3.6
3	*5745.00	107.1 AV			2.05 H	342	103.5	3.6
4	#5935.39	49.5 PK	68.2	-18.7	2.05 H	342	45.6	3.9
5	11490.00	49.2 PK	74.0	-24.8	1.26 H	313	35.4	13.8
6	11490.00	36.4 AV	54.0	-17.6	1.26 H	313	22.6	13.8
7	#17235.00	60.9 PK	68.2	-7.3	2.29 H	153	43.8	17.1

**ANTENNA POLARITY & TEST DISTANCE: VERTICAL AT 3 M**

NO.	FREQ. (MHz)	EMISSION LEVEL (dBuV/m)	LIMIT (dBuV/m)	MARGIN (dB)	ANTENNA HEIGHT (m)	TABLE ANGLE (Degree)	RAW VALUE (dBuV)	CORRECTION FACTOR (dB/m)
1	#5615.95	52.4 PK	68.2	-15.8	2.09 V	73	49.0	3.4
2	*5745.00	116.0 PK			2.09 V	73	112.4	3.6
3	*5745.00	106.4 AV			2.09 V	73	102.8	3.6
4	#5975.98	50.9 PK	68.2	-17.3	2.09 V	73	46.9	4.0
5	11490.00	48.6 PK	74.0	-25.4	2.02 V	331	34.8	13.8
6	11490.00	35.8 AV	54.0	-18.2	2.02 V	331	22.0	13.8
7	#17235.00	58.1 PK	68.2	-10.1	1.08 V	174	41.0	17.1

**REMARKS:**

1. Emission Level(dBuV/m) = Raw Value(dBuV) + Correction Factor(dB/m)
2. Correction Factor(dB/m) = Antenna Factor(dB/m) + Cable Factor(dB) – Pre-Amplifier Factor(dB)
3. The other emission levels were very low against the limit.
4. Margin value = Emission Level – Limit value
5. " \* ": Fundamental frequency.
6. " # ": The radiated frequency is out of the restricted band.



<b>CHANNEL</b>	TX Channel 157	<b>DETECTOR FUNCTION</b>	Peak (PK)
<b>FREQUENCY RANGE</b>	1GHz ~ 40GHz		Average (AV)

**ANTENNA POLARITY & TEST DISTANCE: HORIZONTAL AT 3 M**

NO.	FREQ. (MHz)	EMISSION LEVEL (dBuV/m)	LIMIT (dBuV/m)	MARGIN (dB)	ANTENNA HEIGHT (m)	TABLE ANGLE (Degree)	RAW VALUE (dBuV)	CORRECTION FACTOR (dB/m)
1	#5620.36	54.4 PK	68.2	-13.8	2.04 H	340	51.0	3.4
2	*5785.00	117.3 PK			2.04 H	340	113.7	3.6
3	*5785.00	106.8 AV			2.04 H	340	103.2	3.6
4	#6005.67	50.1 PK	68.2	-18.1	2.04 H	340	46.1	4.0
5	11570.00	48.7 PK	74.0	-25.3	1.21 H	310	35.0	13.7
6	11570.00	35.9 AV	54.0	-18.1	1.21 H	310	22.2	13.7
7	#17355.00	61.0 PK	68.2	-7.2	2.29 H	155	43.4	17.6

**ANTENNA POLARITY & TEST DISTANCE: VERTICAL AT 3 M**

NO.	FREQ. (MHz)	EMISSION LEVEL (dBuV/m)	LIMIT (dBuV/m)	MARGIN (dB)	ANTENNA HEIGHT (m)	TABLE ANGLE (Degree)	RAW VALUE (dBuV)	CORRECTION FACTOR (dB/m)
1	#5605.16	53.5 PK	68.2	-14.7	2.12 V	67	50.1	3.4
2	*5785.00	116.1 PK			2.12 V	67	112.5	3.6
3	*5785.00	106.5 AV			2.12 V	67	102.9	3.6
4	#5926.26	50.9 PK	68.2	-17.3	2.12 V	67	47.0	3.9
5	11570.00	48.3 PK	74.0	-25.7	1.99 V	321	34.6	13.7
6	11570.00	35.8 AV	54.0	-18.2	1.99 V	321	22.1	13.7
7	#17355.00	58.2 PK	68.2	-10.0	1.18 V	185	40.6	17.6

**REMARKS:**

1. Emission Level(dBuV/m) = Raw Value(dBuV) + Correction Factor(dB/m)
2. Correction Factor(dB/m) = Antenna Factor(dB/m) + Cable Factor(dB) – Pre-Amplifier Factor(dB)
3. The other emission levels were very low against the limit.
4. Margin value = Emission Level – Limit value
5. " \* ": Fundamental frequency.
6. " # ": The radiated frequency is out of the restricted band.

<b>CHANNEL</b>	TX Channel 165	<b>DETECTOR FUNCTION</b>	Peak (PK)
<b>FREQUENCY RANGE</b>	1GHz ~ 40GHz		Average (AV)

**ANTENNA POLARITY & TEST DISTANCE: HORIZONTAL AT 3 M**

NO.	FREQ. (MHz)	EMISSION LEVEL (dBuV/m)	LIMIT (dBuV/m)	MARGIN (dB)	ANTENNA HEIGHT (m)	TABLE ANGLE (Degree)	RAW VALUE (dBuV)	CORRECTION FACTOR (dB/m)
1	#5580.01	55.0 PK	68.2	-13.2	2.09 H	345	51.7	3.3
2	*5825.00	117.1 PK			2.09 H	345	113.3	3.8
3	*5825.00	106.6 AV			2.09 H	345	102.8	3.8
4	#5958.42	51.5 PK	68.2	-16.7	2.09 H	345	47.6	3.9
5	11650.00	49.2 PK	74.0	-24.8	1.22 H	305	35.6	13.6
6	11650.00	36.3 AV	54.0	-17.7	1.22 H	305	22.7	13.6
7	#17475.00	60.6 PK	68.2	-7.6	2.25 H	160	42.0	18.6

**ANTENNA POLARITY & TEST DISTANCE: VERTICAL AT 3 M**

NO.	FREQ. (MHz)	EMISSION LEVEL (dBuV/m)	LIMIT (dBuV/m)	MARGIN (dB)	ANTENNA HEIGHT (m)	TABLE ANGLE (Degree)	RAW VALUE (dBuV)	CORRECTION FACTOR (dB/m)
1	#5579.79	54.5 PK	68.2	-13.7	2.09 V	60	51.2	3.3
2	*5825.00	116.0 PK			2.09 V	60	112.2	3.8
3	*5825.00	106.2 AV			2.09 V	60	102.4	3.8
4	#5936.85	50.7 PK	68.2	-17.5	2.09 V	60	46.8	3.9
5	11650.00	48.3 PK	74.0	-25.7	2.02 V	329	34.7	13.6
6	11650.00	35.5 AV	54.0	-18.5	2.02 V	329	21.9	13.6
7	#17475.00	58.7 PK	68.2	-9.5	1.11 V	172	40.1	18.6

**REMARKS:**

1. Emission Level(dBuV/m) = Raw Value(dBuV) + Correction Factor(dB/m)
2. Correction Factor(dB/m) = Antenna Factor(dB/m) + Cable Factor(dB) – Pre-Amplifier Factor(dB)
3. The other emission levels were very low against the limit.
4. Margin value = Emission Level – Limit value
5. " \* ": Fundamental frequency.
6. " # ": The radiated frequency is out of the restricted band.

**802.11ac (VHT40)**

<b>CHANNEL</b>	TX Channel 38	<b>DETECTOR FUNCTION</b>	Peak (PK)
<b>FREQUENCY RANGE</b>	1GHz ~ 40GHz		Average (AV)

**ANTENNA POLARITY & TEST DISTANCE: HORIZONTAL AT 3 M**

NO.	FREQ. (MHz)	EMISSION LEVEL (dBuV/m)	LIMIT (dBuV/m)	MARGIN (dB)	ANTENNA HEIGHT (m)	TABLE ANGLE (Degree)	RAW VALUE (dBuV)	CORRECTION FACTOR (dB/m)
1	5150.00	66.7 PK	74.0	-7.3	1.00 H	3	63.7	3.0
2	5150.00	53.7 AV	54.0	-0.3	1.00 H	3	50.7	3.0
3	*5190.00	108.3 PK			1.00 H	3	105.4	2.9
4	*5190.00	99.6 AV			1.00 H	3	96.7	2.9
5	5350.00	50.5 PK	74.0	-23.5	1.00 H	3	47.7	2.8
6	5350.00	37.7 AV	54.0	-16.3	1.00 H	3	34.9	2.8
7	#10380.00	45.7 PK	68.2	-22.5	1.59 H	15	32.7	13.0
8	15570.00	56.7 PK	74.0	-17.3	2.75 H	181	43.7	13.0
9	15570.00	43.8 AV	54.0	-10.2	2.75 H	181	30.8	13.0

**ANTENNA POLARITY & TEST DISTANCE: VERTICAL AT 3 M**

NO.	FREQ. (MHz)	EMISSION LEVEL (dBuV/m)	LIMIT (dBuV/m)	MARGIN (dB)	ANTENNA HEIGHT (m)	TABLE ANGLE (Degree)	RAW VALUE (dBuV)	CORRECTION FACTOR (dB/m)
1	5150.00	62.1 PK	74.0	-11.9	1.00 V	55	59.1	3.0
2	5150.00	49.6 AV	54.0	-4.4	1.00 V	55	46.6	3.0
3	*5190.00	105.9 PK			1.00 V	55	103.0	2.9
4	*5190.00	97.3 AV			1.00 V	55	94.4	2.9
5	5350.00	50.3 PK	74.0	-23.7	1.00 V	55	47.5	2.8
6	5350.00	37.5 AV	54.0	-16.5	1.00 V	55	34.7	2.8
7	#10380.00	45.7 PK	68.2	-22.5	1.96 V	297	32.7	13.0
8	15570.00	52.5 PK	74.0	-21.5	1.11 V	176	39.5	13.0
9	15570.00	39.8 AV	54.0	-14.2	1.11 V	176	26.8	13.0

**REMARKS:**

1. Emission Level(dBuV/m) = Raw Value(dBuV) + Correction Factor(dB/m)
2. Correction Factor(dB/m) = Antenna Factor(dB/m) + Cable Factor(dB) – Pre-Amplifier Factor(dB)
3. The other emission levels were very low against the limit.
4. Margin value = Emission Level – Limit value
5. " \* ": Fundamental frequency.
6. " # ": The radiated frequency is out of the restricted band.

<b>CHANNEL</b>	TX Channel 46	<b>DETECTOR FUNCTION</b>	Peak (PK)
<b>FREQUENCY RANGE</b>	1GHz ~ 40GHz		Average (AV)

**ANTENNA POLARITY & TEST DISTANCE: HORIZONTAL AT 3 M**

NO.	FREQ. (MHz)	EMISSION LEVEL (dBuV/m)	LIMIT (dBuV/m)	MARGIN (dB)	ANTENNA HEIGHT (m)	TABLE ANGLE (Degree)	RAW VALUE (dBuV)	CORRECTION FACTOR (dB/m)
1	4910.00	65.4 PK	74.0	-8.6	2.14 H	5	63.4	2.0
2	4910.00	53.8 AV	54.0	-0.2	2.14 H	5	51.8	2.0
3	*5230.00	115.4 PK			2.14 H	5	112.8	2.6
4	*5230.00	105.5 AV			2.14 H	5	102.9	2.6
5	5350.00	52.1 PK	74.0	-21.9	2.14 H	5	49.3	2.8
6	5350.00	40.4 AV	54.0	-13.6	2.14 H	5	37.6	2.8
7	#10460.00	46.3 PK	68.2	-21.9	1.65 H	15	33.1	13.2
8	15690.00	56.5 PK	74.0	-17.5	2.78 H	164	44.2	12.3
9	15690.00	43.6 AV	54.0	-10.4	2.78 H	164	31.3	12.3

**ANTENNA POLARITY & TEST DISTANCE: VERTICAL AT 3 M**

NO.	FREQ. (MHz)	EMISSION LEVEL (dBuV/m)	LIMIT (dBuV/m)	MARGIN (dB)	ANTENNA HEIGHT (m)	TABLE ANGLE (Degree)	RAW VALUE (dBuV)	CORRECTION FACTOR (dB/m)
1	*5230.00	113.6 PK			1.02 V	69	111.0	2.6
2	*5230.00	103.7 AV			1.02 V	69	101.1	2.6
3	5350.00	51.9 PK	74.0	-22.1	1.02 V	69	49.1	2.8
4	5350.00	40.2 AV	54.0	-13.8	1.02 V	69	37.4	2.8
5	#10460.00	46.1 PK	68.2	-22.1	1.99 V	311	32.9	13.2
6	15690.00	55.4 PK	74.0	-18.6	1.14 V	184	43.1	12.3
7	15690.00	42.5 AV	54.0	-11.5	1.14 V	184	30.2	12.3

**REMARKS:**

1. Emission Level(dBuV/m) = Raw Value(dBuV) + Correction Factor(dB/m)
2. Correction Factor(dB/m) = Antenna Factor(dB/m) + Cable Factor(dB) – Pre-Amplifier Factor(dB)
3. The other emission levels were very low against the limit.
4. Margin value = Emission Level – Limit value
5. " \* ": Fundamental frequency.
6. " # ": The radiated frequency is out of the restricted band.

<b>CHANNEL</b>	TX Channel 151	<b>DETECTOR FUNCTION</b>	Peak (PK)
<b>FREQUENCY RANGE</b>	1GHz ~ 40GHz		Average (AV)

**ANTENNA POLARITY & TEST DISTANCE: HORIZONTAL AT 3 M**

NO.	FREQ. (MHz)	EMISSION LEVEL (dBuV/m)	LIMIT (dBuV/m)	MARGIN (dB)	ANTENNA HEIGHT (m)	TABLE ANGLE (Degree)	RAW VALUE (dBuV)	CORRECTION FACTOR (dB/m)
1	#5646.92	61.8 PK	68.2	-6.4	2.42 H	338	58.6	3.2
2	*5755.00	114.2 PK			2.42 H	338	110.6	3.6
3	*5755.00	104.9 AV			2.42 H	338	101.3	3.6
4	#5928.57	54.5 PK	68.2	-13.7	2.42 H	338	50.6	3.9
5	11510.00	49.0 PK	74.0	-25.0	1.23 H	315	35.2	13.8
6	11510.00	36.1 AV	54.0	-17.9	1.23 H	315	22.3	13.8
7	#17265.00	60.4 PK	68.2	-7.8	2.29 H	153	43.3	17.1

**ANTENNA POLARITY & TEST DISTANCE: VERTICAL AT 3 M**

NO.	FREQ. (MHz)	EMISSION LEVEL (dBuV/m)	LIMIT (dBuV/m)	MARGIN (dB)	ANTENNA HEIGHT (m)	TABLE ANGLE (Degree)	RAW VALUE (dBuV)	CORRECTION FACTOR (dB/m)
1	#5640.48	59.9 PK	68.2	-8.3	2.05 V	78	56.7	3.2
2	*5755.00	114.1 PK			2.05 V	78	110.5	3.6
3	*5755.00	104.8 AV			2.05 V	78	101.2	3.6
4	#5927.21	51.6 PK	68.2	-16.6	2.05 V	78	47.7	3.9
5	11510.00	48.5 PK	74.0	-25.5	2.07 V	312	34.7	13.8
6	11510.00	36.0 AV	54.0	-18.0	2.07 V	312	22.2	13.8
7	#17265.00	58.2 PK	68.2	-10.0	1.15 V	191	41.1	17.1

**REMARKS:**

1. Emission Level(dBuV/m) = Raw Value(dBuV) + Correction Factor(dB/m)
2. Correction Factor(dB/m) = Antenna Factor(dB/m) + Cable Factor(dB) – Pre-Amplifier Factor(dB)
3. The other emission levels were very low against the limit.
4. Margin value = Emission Level – Limit value
5. " \* ": Fundamental frequency.
6. " # ": The radiated frequency is out of the restricted band.

<b>CHANNEL</b>	TX Channel 159	<b>DETECTOR FUNCTION</b>	Peak (PK)
<b>FREQUENCY RANGE</b>	1GHz ~ 40GHz		Average (AV)

**ANTENNA POLARITY & TEST DISTANCE: HORIZONTAL AT 3 M**

NO.	FREQ. (MHz)	EMISSION LEVEL (dBuV/m)	LIMIT (dBuV/m)	MARGIN (dB)	ANTENNA HEIGHT (m)	TABLE ANGLE (Degree)	RAW VALUE (dBuV)	CORRECTION FACTOR (dB/m)
1	#5567.28	54.2 PK	68.2	-14.0	2.07 H	344	50.9	3.3
2	*5795.00	114.3 PK			2.07 H	344	110.7	3.6
3	*5795.00	104.7 AV			2.07 H	344	101.1	3.6
4	#5939.39	52.5 PK	68.2	-15.7	2.07 H	344	48.6	3.9
5	11590.00	49.1 PK	74.0	-24.9	1.20 H	299	35.5	13.6
6	11590.00	36.1 AV	54.0	-17.9	1.20 H	299	22.5	13.6
7	#17385.00	60.7 PK	68.2	-7.5	2.20 H	149	42.8	17.9

**ANTENNA POLARITY & TEST DISTANCE: VERTICAL AT 3 M**

NO.	FREQ. (MHz)	EMISSION LEVEL (dBuV/m)	LIMIT (dBuV/m)	MARGIN (dB)	ANTENNA HEIGHT (m)	TABLE ANGLE (Degree)	RAW VALUE (dBuV)	CORRECTION FACTOR (dB/m)
1	#5554.30	53.7 PK	68.2	-14.5	2.09 V	88	50.5	3.2
2	*5795.00	113.8 PK			2.09 V	88	110.2	3.6
3	*5795.00	104.5 AV			2.09 V	88	100.9	3.6
4	#5925.78	56.7 PK	68.2	-11.5	2.09 V	88	52.8	3.9
5	11590.00	48.0 PK	74.0	-26.0	2.02 V	332	34.4	13.6
6	11590.00	35.6 AV	54.0	-18.4	2.02 V	332	22.0	13.6
7	#17385.00	58.0 PK	68.2	-10.2	1.09 V	189	40.1	17.9

**REMARKS:**

1. Emission Level(dBuV/m) = Raw Value(dBuV) + Correction Factor(dB/m)
2. Correction Factor(dB/m) = Antenna Factor(dB/m) + Cable Factor(dB) – Pre-Amplifier Factor(dB)
3. The other emission levels were very low against the limit.
4. Margin value = Emission Level – Limit value
5. " \* ": Fundamental frequency.
6. " # ": The radiated frequency is out of the restricted band.

802.11ac (VHT80)

<b>CHANNEL</b>	TX Channel 42	<b>DETECTOR FUNCTION</b>	Peak (PK)
<b>FREQUENCY RANGE</b>	1GHz ~ 40GHz		Average (AV)

ANTENNA POLARITY & TEST DISTANCE: HORIZONTAL AT 3 M								
NO.	FREQ. (MHz)	EMISSION LEVEL (dBuV/m)	LIMIT (dBuV/m)	MARGIN (dB)	ANTENNA HEIGHT (m)	TABLE ANGLE (Degree)	RAW VALUE (dBuV)	CORRECTION FACTOR (dB/m)
1	5150.00	66.2 PK	74.0	-7.8	1.50 H	4	63.2	3.0
2	5150.00	53.6 AV	54.0	-0.4	1.50 H	4	50.6	3.0
3	*5210.00	104.2 PK			1.05 H	4	101.4	2.8
4	*5210.00	94.3 AV			1.05 H	4	91.5	2.8
5	5350.00	53.1 PK	74.0	-20.9	1.05 H	4	50.3	2.8
6	5350.00	42.4 AV	54.0	-11.6	1.05 H	4	39.6	2.8
7	#10420.00	46.1 PK	68.2	-22.1	1.59 H	1	33.0	13.1
8	15630.00	51.5 PK	74.0	-22.5	2.78 H	157	38.7	12.8
9	15630.00	39.0 AV	54.0	-15.0	2.78 H	157	26.2	12.8

ANTENNA POLARITY & TEST DISTANCE: VERTICAL AT 3 M								
NO.	FREQ. (MHz)	EMISSION LEVEL (dBuV/m)	LIMIT (dBuV/m)	MARGIN (dB)	ANTENNA HEIGHT (m)	TABLE ANGLE (Degree)	RAW VALUE (dBuV)	CORRECTION FACTOR (dB/m)
1	5150.00	61.8 PK	74.0	-12.2	1.06 V	51	58.8	3.0
2	5150.00	48.8 AV	54.0	-5.2	1.06 V	51	45.8	3.0
3	*5210.00	103.8 PK			1.06 V	51	101.0	2.8
4	*5210.00	92.0 AV			1.06 V	51	89.2	2.8
5	5350.00	52.9 PK	74.0	-21.1	1.06 V	51	50.1	2.8
6	5350.00	42.2 AV	54.0	-11.8	1.06 V	51	39.4	2.8
7	#10420.00	45.8 PK	68.2	-22.4	2.02 V	308	32.7	13.1
8	15630.00	51.2 PK	74.0	-22.8	1.06 V	167	38.4	12.8
9	15630.00	38.4 AV	54.0	-15.6	1.06 V	167	25.6	12.8

**REMARKS:**

1. Emission Level(dBuV/m) = Raw Value(dBuV) + Correction Factor(dB/m)
2. Correction Factor(dB/m) = Antenna Factor(dB/m) + Cable Factor(dB) – Pre-Amplifier Factor(dB)
3. The other emission levels were very low against the limit.
4. Margin value = Emission Level – Limit value
5. " \* ": Fundamental frequency.
6. " # ": The radiated frequency is out of the restricted band.

<b>CHANNEL</b>	TX Channel 155	<b>DETECTOR FUNCTION</b>	Peak (PK)
<b>FREQUENCY RANGE</b>	1GHz ~ 40GHz		Average (AV)

**ANTENNA POLARITY & TEST DISTANCE: HORIZONTAL AT 3 M**

NO.	FREQ. (MHz)	EMISSION LEVEL (dBuV/m)	LIMIT (dBuV/m)	MARGIN (dB)	ANTENNA HEIGHT (m)	TABLE ANGLE (Degree)	RAW VALUE (dBuV)	CORRECTION FACTOR (dB/m)
1	#5646.41	68.1 PK	68.2	-0.1	2.47 H	346	64.9	3.2
2	*5775.00	108.0 PK			2.47 H	346	104.4	3.6
3	*5775.00	98.6 AV			2.47 H	346	95.0	3.6
4	#5925.25	60.9 PK	68.2	-7.3	2.47 H	346	57.0	3.9
5	11550.00	49.5 PK	74.0	-24.5	1.25 H	293	35.9	13.6
6	11550.00	36.7 AV	54.0	-17.3	1.25 H	293	23.1	13.6
7	#17325.00	60.5 PK	68.2	-7.7	2.25 H	145	43.1	17.4

**ANTENNA POLARITY & TEST DISTANCE: VERTICAL AT 3 M**

NO.	FREQ. (MHz)	EMISSION LEVEL (dBuV/m)	LIMIT (dBuV/m)	MARGIN (dB)	ANTENNA HEIGHT (m)	TABLE ANGLE (Degree)	RAW VALUE (dBuV)	CORRECTION FACTOR (dB/m)
1	#5647.78	67.0 PK	68.2	-1.2	2.02 V	77	63.8	3.2
2	*5775.00	107.7 PK			2.02 V	77	104.1	3.6
3	*5775.00	98.3 AV			2.02 V	77	94.7	3.6
4	#5927.92	58.8 PK	68.2	-9.4	2.02 V	77	54.9	3.9
5	11550.00	48.6 PK	74.0	-25.4	2.05 V	303	35.0	13.6
6	11550.00	36.3 AV	54.0	-17.7	2.05 V	303	22.7	13.6
7	#17325.00	58.4 PK	68.2	-9.8	1.11 V	163	41.0	17.4

**REMARKS:**

1. Emission Level(dBuV/m) = Raw Value(dBuV) + Correction Factor(dB/m)
2. Correction Factor(dB/m) = Antenna Factor(dB/m) + Cable Factor(dB) – Pre-Amplifier Factor(dB)
3. The other emission levels were very low against the limit.
4. Margin value = Emission Level – Limit value
5. " \* ": Fundamental frequency.
6. " # ": The radiated frequency is out of the restricted band.



**Below 1GHz Data:**  
**802.11ac (VHT40)**

<b>CHANNEL</b>	TX Channel 151	<b>DETECTOR FUNCTION</b>	Quasi-Peak (QP)
<b>FREQUENCY RANGE</b>	9kHz ~ 1GHz		

ANTENNA POLARITY & TEST DISTANCE: HORIZONTAL AT 3 M								
NO.	FREQ. (MHz)	EMISSION LEVEL (dBuV/m)	LIMIT (dBuV/m)	MARGIN (dB)	ANTENNA HEIGHT (m)	TABLE ANGLE (Degree)	RAW VALUE (dBuV)	CORRECTION FACTOR (dB/m)
1	30.90	23.7 QP	40.0	-16.3	2.00 H	38	33.4	-9.7
2	125.01	36.9 QP	43.5	-6.6	1.50 H	68	46.3	-9.4
3	250.02	30.8 QP	46.0	-15.2	1.00 H	43	39.5	-8.7
4	286.78	29.4 QP	46.0	-16.6	1.00 H	28	36.8	-7.4
5	562.51	42.2 QP	46.0	-3.8	1.50 H	28	43.0	-0.8
6	874.99	40.5 QP	46.0	-5.5	1.00 H	30	35.2	5.3

**REMARKS:**

1. Emission Level(dBuV/m) = Raw Value(dBuV) + Correction Factor(dB/m)
2. Correction Factor(dB/m) = Antenna Factor(dB/m) + Cable Factor(dB) – Pre-Amplifier Factor(dB)
3. Margin value = Emission Level – Limit value
4. The emission levels were very low against the limit of frequency range 9kHz~30MHz: the amplitude of spurious emissions attenuated more than 20 dB below the permissible value to be report.

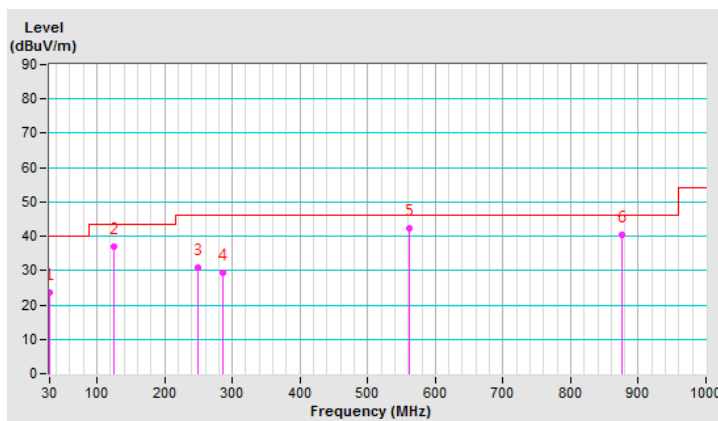

<b>CHANNEL</b>	TX Channel 151	<b>DETECTOR FUNCTION</b>	Quasi-Peak (QP)
<b>FREQUENCY RANGE</b>	9kHz ~ 1GHz		

**ANTENNA POLARITY & TEST DISTANCE: VERTICAL AT 3 M**

NO.	FREQ. (MHz)	EMISSION LEVEL (dBuV/m)	LIMIT (dBuV/m)	MARGIN (dB)	ANTENNA HEIGHT (m)	TABLE ANGLE (Degree)	RAW VALUE (dBuV)	CORRECTION FACTOR (dB/m)
1	57.31	32.8 QP	40.0	-7.2	1.00 V	98	41.4	-8.6
2	125.01	31.9 QP	43.5	-11.6	1.50 V	360	41.3	-9.4
3	250.02	30.0 QP	46.0	-16.0	2.00 V	0	38.7	-8.7
4	562.51	40.8 QP	46.0	-5.2	2.00 V	0	41.6	-0.8
5	687.51	40.8 QP	46.0	-5.2	1.50 V	360	39.1	1.7
6	874.99	36.1 QP	46.0	-9.9	1.00 V	360	30.8	5.3

**REMARKS:**

1. Emission Level(dBuV/m) = Raw Value(dBuV) + Correction Factor(dB/m)
2. Correction Factor(dB/m) = Antenna Factor(dB/m) + Cable Factor(dB) – Pre-Amplifier Factor(dB)
3. Margin value = Emission Level – Limit value
4. The emission levels were very low against the limit of frequency range 9kHz~30MHz: the amplitude of spurious emissions attenuated more than 20 dB below the permissible value to be report.

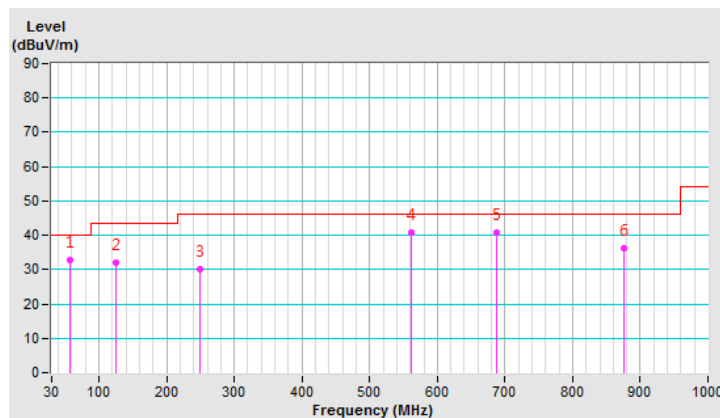

## 4.2 Conducted Emission Measurement

### 4.2.1 Limits of Conducted Emission Measurement

Frequency (MHz)	Conducted Limit (dBuV)	
	Quasi-peak	Average
0.15 - 0.5	66 - 56	56 - 46
0.50 - 5.0	56	46
5.0 - 30.0	60	50

Note: 1. The lower limit shall apply at the transition frequencies.

2. The limit decreases in line with the logarithm of the frequency in the range of 0.15 to 0.50MHz.

### 4.2.2 Test Instruments

DESCRIPTION & MANUFACTURER	MODEL NO.	SERIAL NO.	CALIBRATED DATE	CALIBRATED UNTIL
Test Receiver R&S	ESCS 30	847124/029	Oct. 24, 2018	Oct. 23, 2019
Line-Impedance Stabilization Network (for EUT) R&S	ESH3-Z5	848773/004	Oct. 22, 2018	Oct. 21, 2019
Line-Impedance Stabilization Network (for Peripheral) R&S	ENV216	100072	June 04, 2018	June 03, 2019
50 ohms Terminator	N/A	3	Oct. 22, 2018	Oct. 21, 2019
RF Cable	5D-FB	COCCAB-001	Sep. 28, 2018	Sep. 27, 2019
Fixed attenuator EMCI	STI02-2200-10	003	Mar. 16, 2018	Mar. 15, 2019
Software BVADT	BVADT_Cond_ V7.3.7.4	NA	NA	NA

**Note:**

1. The calibration interval of the above test instruments are 12 months and the calibrations are traceable to NML/ROC and NIST/USA.
2. The test was performed in Conduction 1.
3. Tested Date: Jan. 22, 2019

#### 4.2.3 Test Procedure

- The EUT was placed 0.4 meters from the conducting wall of the shielded room with EUT being connected to the power mains through a line impedance stabilization network (LISN). Other support units were connected to the power mains through another LISN. The two LISNs provide 50 ohm/ 50uH of coupling impedance for the measuring instrument.
- Both lines of the power mains connected to the EUT were checked for maximum conducted interference.
- The frequency range from 150kHz to 30MHz was searched. Emission levels under (Limit - 20dB) was not recorded.

**Note:** All modes of operation were investigated and the worst-case emissions are reported.

#### 4.2.4 Deviation from Test Standard

No deviation.

#### 4.2.5 Test Setup

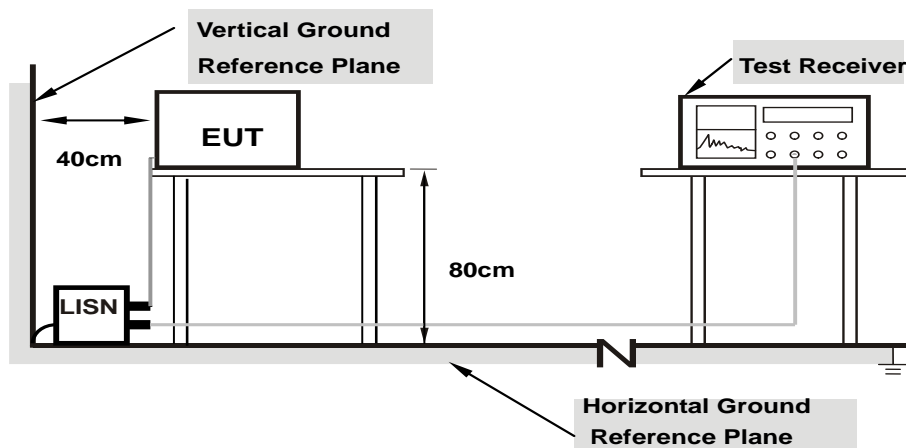

**Note: 1.Support units were connected to second LISN.**

For the actual test configuration, please refer to the attached file (Test Setup Photo).

#### 4.2.6 EUT Operating Condition

Same as 4.1.6.

#### 4.2.7 Test Results

Phase	Line (L)	Detector Function	Quasi-Peak (QP) / Average (AV)
-------	----------	-------------------	--------------------------------

No	Freq. [MHz]	Corr.	Reading Value		Emission Level		Limit		Margin	
		Factor	[dB (uV)]		[dB (uV)]		[dB (uV)]		(dB)	
	(dB)	Q.P.	AV.	Q.P.	AV.	Q.P.	AV.	Q.P.	AV.	
1	0.15000	10.03	33.56	23.11	43.59	33.14	66.00	56.00	-22.41	-22.86
2	0.18125	10.04	30.78	20.14	40.82	30.18	64.43	54.43	-23.61	-24.25
3	0.43516	10.08	27.40	20.71	37.48	30.79	57.15	47.15	-19.67	-16.36
<b>4</b>	<b>0.67734</b>	<b>10.10</b>	<b>34.73</b>	<b>27.82</b>	<b>44.83</b>	<b>37.92</b>	<b>56.00</b>	<b>46.00</b>	<b>-11.17</b>	<b>-8.08</b>
5	9.08203	10.64	25.41	17.72	36.05	28.36	60.00	50.00	-23.95	-21.64
6	15.25391	11.05	26.88	19.46	37.93	30.51	60.00	50.00	-22.07	-19.49

#### Remarks:

1. Q.P. and AV. are abbreviations of quasi-peak and average individually.
2. The emission levels of other frequencies were very low against the limit.
3. Margin value = Emission level – Limit value
4. Correction factor = Insertion loss + Cable loss
5. Emission Level = Correction Factor + Reading Value

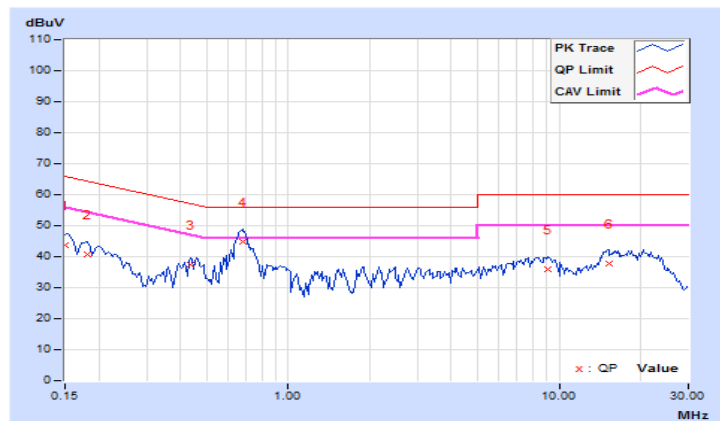

Phase	Neutral (N)	Detector Function	Quasi-Peak (QP) / Average (AV)
-------	-------------	-------------------	--------------------------------

No	Freq. [MHz]	Corr. Factor	Reading Value [dB (uV)]		Emission Level [dB (uV)]		Limit [dB (uV)]		Margin (dB)	
		(dB)	Q.P.	AV.	Q.P.	AV.	Q.P.	AV.	Q.P.	AV.
	1	0.15391	9.94	33.00	20.54	42.94	30.48	65.79	55.79	-22.85
2	0.17344	9.94	29.54	17.48	39.48	27.42	64.79	54.79	-25.31	-27.37
3	0.67734	9.99	30.67	24.10	40.66	34.09	56.00	46.00	-15.34	-11.91
4	1.30859	10.02	22.04	15.15	32.06	25.17	56.00	46.00	-23.94	-20.83
5	8.73438	10.45	22.58	15.17	33.03	25.62	60.00	50.00	-26.97	-24.38
6	19.76953	11.13	22.84	15.58	33.97	26.71	60.00	50.00	-26.03	-23.29

**Remarks:**

1. Q.P. and AV. are abbreviations of quasi-peak and average individually.
2. The emission levels of other frequencies were very low against the limit.
3. Margin value = Emission level – Limit value
4. Correction factor = Insertion loss + Cable loss
5. Emission Level = Correction Factor + Reading Value

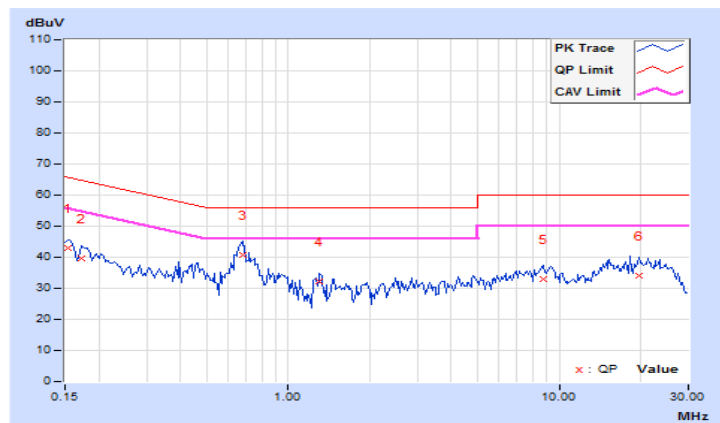

### 4.3 Transmit Power Measurement

#### 4.3.1 Limits of Transmit Power Measurement

Operation Band	EUT Category		Limit
U-NII-1		Outdoor Access Point	1 Watt (30 dBm) (Max. e.i.r.p $\leq$ 125mW(21 dBm) at any elevation angle above 30 degrees as measured from the horizon)
		Fixed point-to-point Access Point	1 Watt (30 dBm)
	√	Indoor Access Point	1 Watt (30 dBm)
		Client device	250mW (24 dBm)
U-NII-2A			250mW (24 dBm) or 11 dBm+10 log B*
U-NII-2C			250mW (24 dBm) or 11 dBm+10 log B*
U-NII-3		√	1 Watt (30 dBm)

\*B is the 26 dB emission bandwidth in megahertz

Per KDB 662911 Method of conducted output power measurement on IEEE 802.11 devices,

Array Gain = 0 dB (i.e., no array gain) for  $N_{ANT} \leq 4$ ;

Array Gain = 0 dB (i.e., no array gain) for channel widths  $\geq 40$  MHz for any  $N_{ANT}$ ;

Array Gain =  $5 \log(N_{ANT}/N_{SS})$  dB or 3 dB, whichever is less for 20-MHz channel widths with  $N_{ANT} \geq 5$ .

For power measurements on all other devices: Array Gain =  $10 \log(N_{ANT}/N_{SS})$  dB.

#### 4.3.2 Test Setup

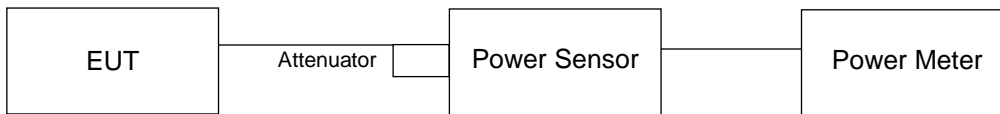

#### 4.3.3 Test Instruments

Refer to section 4.1.2 to get information of above instrument.

#### 4.3.4 Test Procedure

Method PM is used to perform output power measurement, trigger and gating function of wide band power meter is enabled to measure max output power of TX on burst. Duty factor is not added to measured value.

#### 4.3.5 Deviation from Test Standard

No deviation.

#### 4.3.6 EUT Operating Condition

The software provided by client to enable the EUT under transmission condition continuously at lowest, middle and highest channel frequencies individually.



#### 4.3.7 Test Results

##### CDD Mode

##### 802.11a

Chan.	Chan. Freq. (MHz)	Maximum Conducted Power (dBm)		Total Power (mW)	Total Power (dBm)	Limit (dBm)	Pass / Fail
		Chain 0	Chain 1				
36	5180	20.10	20.11	204.894	23.12	30	Pass
40	5200	23.17	23.12	412.607	26.16	30	Pass
48	5240	23.36	23.38	434.541	26.38	30	Pass
149	5745	22.89	23.31	408.825	26.12	30	Pass
157	5785	22.66	23.10	388.676	25.90	30	Pass
165	5825	22.55	23.04	381.259	25.81	30	Pass

##### 802.11ac (VHT20)

Chan.	Chan. Freq. (MHz)	Maximum Conducted Power (dBm)		Total Power (mW)	Total Power (dBm)	Limit (dBm)	Pass / Fail
		Chain 0	Chain 1				
36	5180	20.71	20.87	239.941	23.80	30	Pass
40	5200	22.91	22.95	392.676	25.94	30	Pass
48	5240	23.15	23.13	412.127	26.15	30	Pass
149	5745	22.60	23.19	390.419	25.92	30	Pass
157	5785	22.42	22.96	372.279	25.71	30	Pass
165	5825	22.26	22.94	365.056	25.62	30	Pass

##### 802.11ac (VHT40)

Chan.	Chan. Freq. (MHz)	Maximum Conducted Power (dBm)		Total Power (mW)	Total Power (dBm)	Limit (dBm)	Pass / Fail
		Chain 0	Chain 1				
38	5190	15.85	15.98	78.087	18.93	30	Pass
46	5230	22.26	22.32	338.875	25.30	30	Pass
151	5755	23.16	23.65	438.753	26.42	30	Pass
159	5795	22.84	23.33	407.587	26.10	30	Pass

##### 802.11ac (VHT80)

Chan.	Chan. Freq. (MHz)	Maximum Conducted Power (dBm)		Total Power (mW)	Total Power (dBm)	Limit (dBm)	Pass / Fail
		Chain 0	Chain 1				
42	5210	14.47	14.77	57.982	17.63	30	Pass
155	5775	19.83	20.29	203.066	23.08	30	Pass

## Beamforming Mode

### 802.11ac (VHT20)

Chan.	Chan. Freq. (MHz)	Maximum Conducted Power (dBm)		Total Power (mW)	Total Power (dBm)	Limit (dBm)	Pass / Fail
		Chain 0	Chain 1				
36	5180	20.71	20.87	239.941	23.80	30	Pass
40	5200	22.91	22.95	392.676	25.94	30	Pass
48	5240	23.15	23.13	412.127	26.15	30	Pass
149	5745	22.60	23.19	390.419	25.92	30	Pass
157	5785	22.42	22.96	372.279	25.71	30	Pass
165	5825	22.26	22.94	365.056	25.62	30	Pass

**Note:** Directional gain = 5.53dBi < 6dBi, so the power limit shall not be reduced.

### 802.11ac (VHT40)

Chan.	Chan. Freq. (MHz)	Maximum Conducted Power (dBm)		Total Power (mW)	Total Power (dBm)	Limit (dBm)	Pass / Fail
		Chain 0	Chain 1				
38	5190	15.85	15.98	78.087	18.93	30	Pass
46	5230	22.26	22.32	338.875	25.30	30	Pass
151	5755	23.16	23.65	438.753	26.42	30	Pass
159	5795	22.84	23.33	407.587	26.10	30	Pass

**Note:** Directional gain = 5.53dBi < 6dBi, so the power limit shall not be reduced.

### 802.11ac (VHT80)

Chan.	Chan. Freq. (MHz)	Maximum Conducted Power (dBm)		Total Power (mW)	Total Power (dBm)	Limit (dBm)	Pass / Fail
		Chain 0	Chain 1				
42	5210	14.47	14.77	57.982	17.63	30	Pass
155	5775	19.83	20.29	203.066	23.08	30	Pass

**Note:** Directional gain = 5.53dBi < 6dBi, so the power limit shall not be reduced.

## 4.4 Occupied Bandwidth Measurement

### 4.4.1 Test Setup

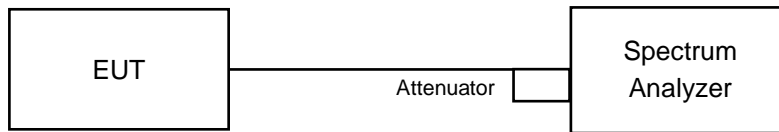

### 4.4.2 Test Instruments

Refer to section 4.1.2 to get information of above instrument.

### 4.4.3 Test Procedure

The transmitter output was connected to the spectrum analyzer through an attenuator. The bandwidth of the fundamental frequency was measured by spectrum analyzer with resolution bandwidth in the range of 1% to 5% of the anticipated emission bandwidth, and a video bandwidth at least 3x the resolution bandwidth and set the detector to SAMPLE. The width of a frequency band such that, below the lower and above the upper frequency limits, the mean powers emitted are each equal to a specified percentage 0.5 %of the total mean power of a given emission.

#### 4.4.4 Test Results

##### 802.11a

Channel	Channel Frequency (MHz)	Occupied Bandwidth (MHz)	
		Chain 0	Chain 1
36	5180	16.56	16.56
40	5200	19.44	16.68
48	5240	17.76	16.92
149	5745	16.80	18.36
157	5785	16.80	17.52
165	5825	16.80	17.64

##### 802.11ac (VHT20)

Channel	Channel Frequency (MHz)	Occupied Bandwidth (MHz)	
		Chain 0	Chain 1
36	5180	17.88	17.76
40	5200	18.48	17.88
48	5240	20.04	17.88
149	5745	17.88	19.08
157	5785	17.76	18.24
165	5825	17.76	18.24

##### 802.11ac (VHT40)

Channel	Channel Frequency (MHz)	Occupied Bandwidth (MHz)	
		Chain 0	Chain 1
38	5190	36.24	36.24
46	5230	37.68	36.72
151	5755	36.96	37.92
159	5795	36.72	38.88

##### 802.11ac (VHT80)

Channel	Channel Frequency (MHz)	Occupied Bandwidth (MHz)	
		Chain 0	Chain 1
42	5210	76.32	75.84
155	5775	76.80	76.80

### Spectrum Plot of Max Value

**802.11a / Chain 0 : CH40**

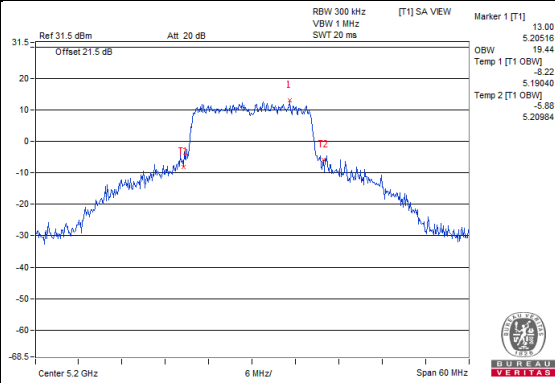

**802.11ac (VHT20) / Chain 0: CH48**

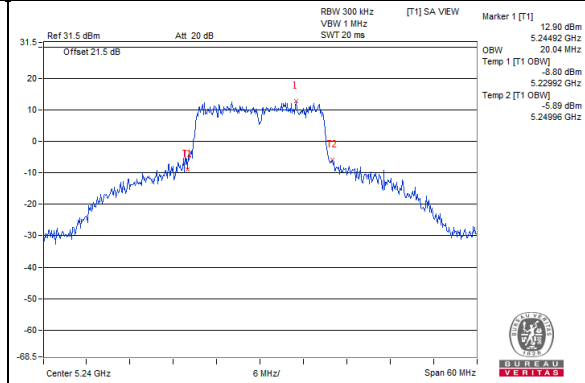

**802.11ac (VHT40) / Chain 1: CH159**

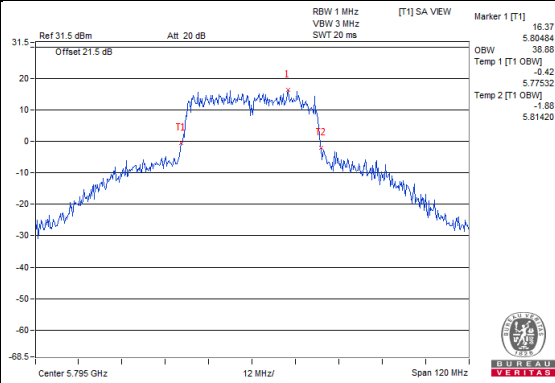

**802.11ac (VHT80) / Chain 0 : CH155**

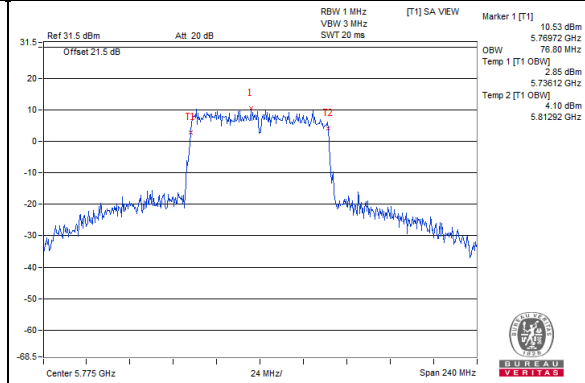

### Spectrum Plot for near by DFS band (DFS is required, if 99% OCP straddle into U-NII-2A band)

**802.11a\_Chain0 / CH48**

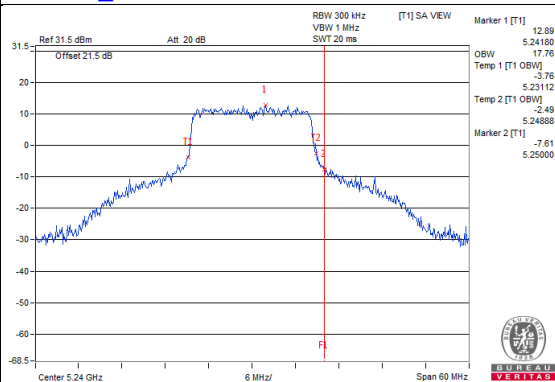

**802.11a\_Chain1 / CH48**

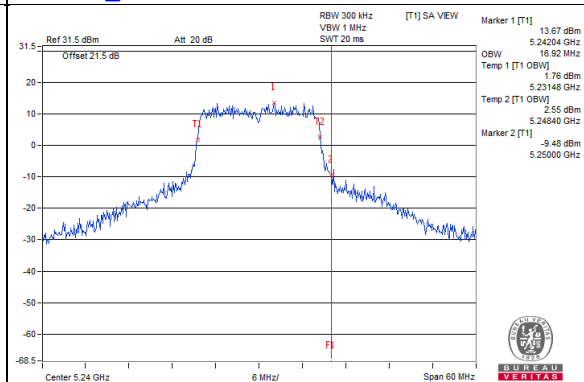

**802.11ac(VHT20)\_Chain0 / CH48**

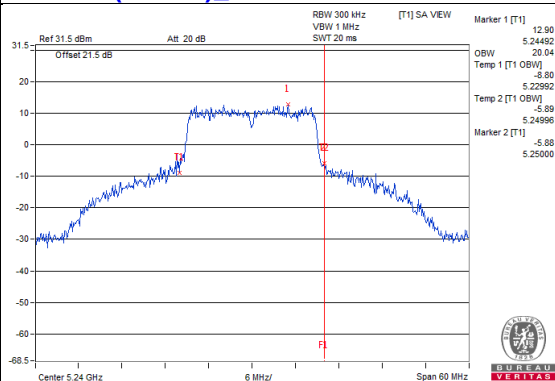

**802.11ac(VHT20)\_Chain1 / CH48**

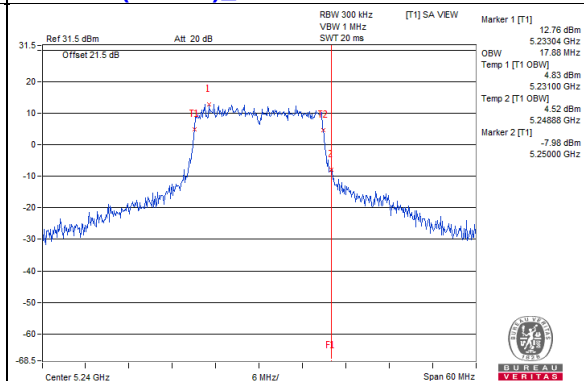

**802.11ac(VHT40)\_Chain0 / CH46**

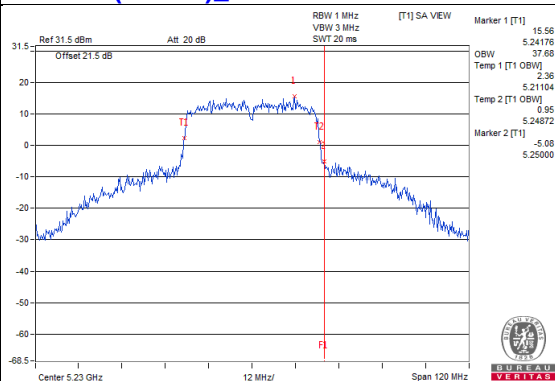

**802.11ac(VHT40)\_Chain1 / CH46**

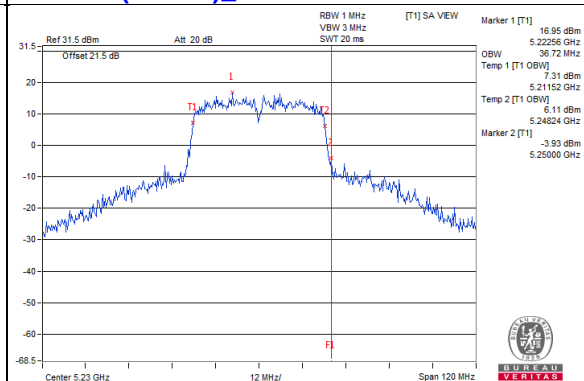

**802.11ac(VHT80)\_Chain0 / CH42**

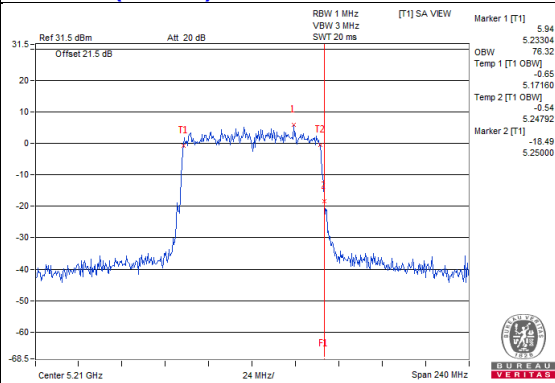

**802.11ac(VHT80)\_Chain1 / CH42**

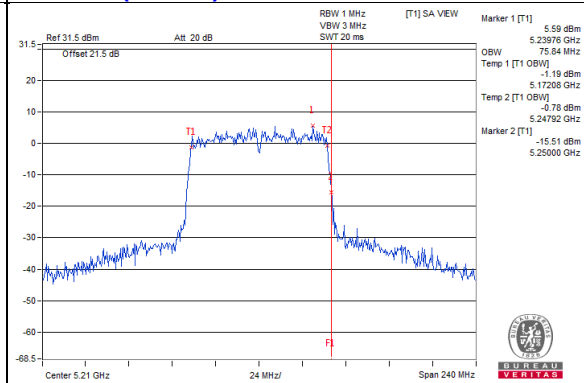

**Spectrum Plot for near by DFS band  
(DFS is required, if 99% OCP straddle into U-NII-2C band)**

**802.11a\_Chain0 / CH149**

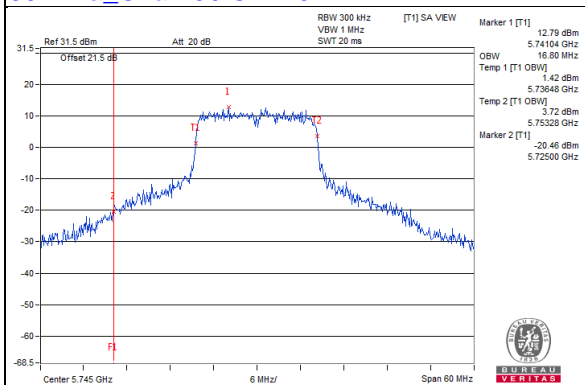

**802.11a\_Chain1 / CH149**

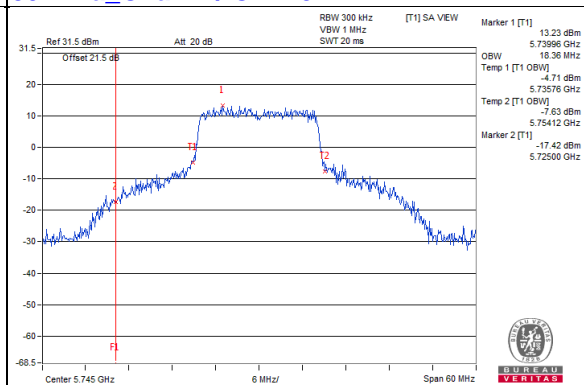

**802.11ac(VHT20)\_Chain0 / CH149**

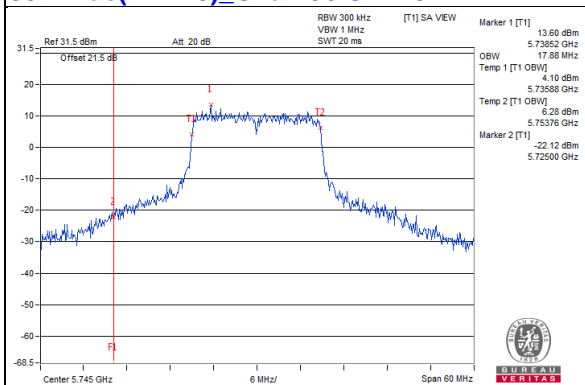

**802.11ac(VHT20)\_Chain1 / CH149**

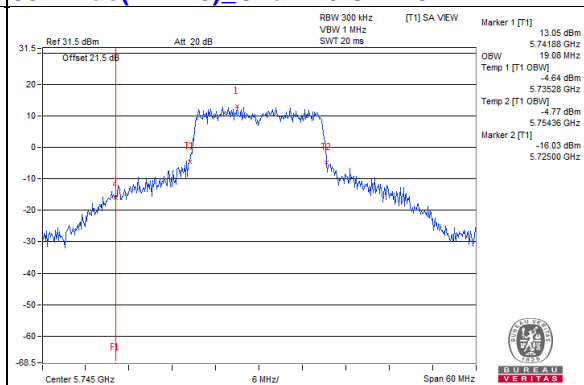

**802.11ac(VHT40)\_Chain0 / CH151**

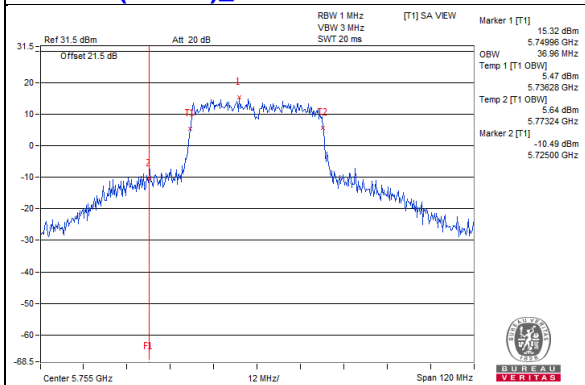

**802.11ac(VHT40)\_Chain1 / CH151**

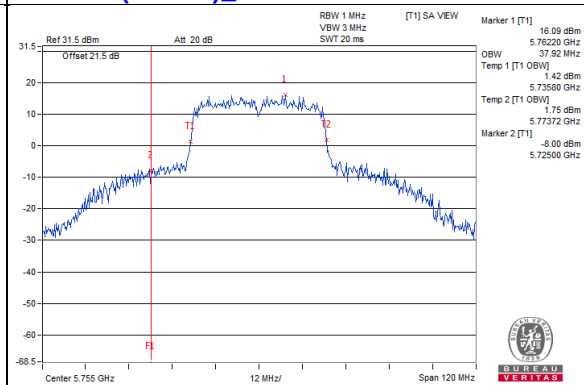

**802.11ac(VHT80)\_Chain0 / CH155**

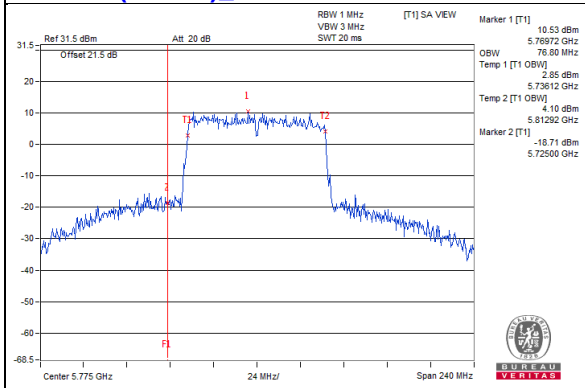

**802.11ac(VHT80)\_Chain1 / CH155**

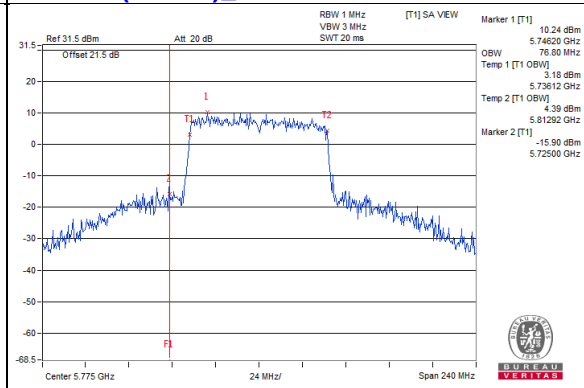

## 4.5 Peak Power Spectral Density Measurement

### 4.5.1 Limits of Peak Power Spectral Density Measurement

Operation Band	EUT Category		Limit
U-NII-1		Outdoor Access Point	17dBm/ MHz
		Fixed point-to-point Access Point	
	√	Indoor Access Point	
		Client device	11dBm/ MHz
U-NII-2A			11dBm/ MHz
U-NII-2C			11dBm/ MHz
U-NII-3	√		30dBm/ 500kHz

### 4.5.2 Test Setup

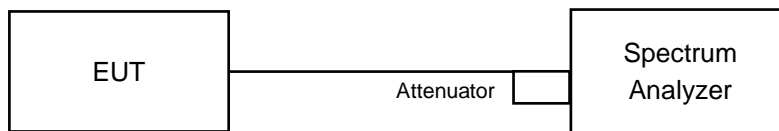

### 4.5.3 Test Instruments

Refer to section 4.1.2 to get information of above instrument.



#### 4.5.4 Test Procedure

##### **For U-NII-1 band:**

Using method SA-2

1. Set span to encompass the entire emission bandwidth (EBW) of the signal.
2. Set RBW = 1 MHz, Set VBW  $\geq$  3 MHz, Detector = RMS
3. Sweep time = auto, trigger set to "free run".
4. Trace average at least 100 traces in power averaging mode.
5. Record the max value and add  $10 \log (1/\text{duty cycle})$

##### **For U-NII-3 band:**

1. Set span to encompass the entire emission bandwidth (EBW) of the signal.
2. Set RBW = 300 kHz, Set VBW  $\geq$  1 MHz, Detector = RMS
3. Use the peak marker function to determine the maximum power level in any 300 kHz band segment within the fundamental EBW.
4. Scale the observed power level to an equivalent value in 500 kHz by adjusting (reducing) the measured power by a bandwidth correction factor (BWCF) where  $\text{BWCF} = 10 \log(500\text{kHz}/300\text{kHz})$
5. Sweep time = auto, trigger set to "free run".
6. Trace average at least 100 traces in power averaging mode.
7. Record the max value and add  $10 \log (1/\text{duty cycle})$

#### 4.5.5 Deviation from Test Standard

No deviation.

#### 4.5.6 EUT Operating Condition

Same as Item 4.3.6.

#### 4.5.7 Test Results

##### CDD Mode

##### For U-NII-1:

##### 802.11a

Chan.	Chan. Freq. (MHz)	PSD W/O Duty Factor (dBm/MHz)		Duty Factor (dB)	Total PSD With Duty Factor (dBm/MHz)	MAX. Limit (dBm/MHz)	Pass / Fail
		Chain 0	Chain 1				
36	5180	6.07	6.46	0.17	9.45	17.00	Pass
40	5200	8.37	8.58	0.17	11.66	17.00	Pass
48	5240	8.54	8.67	0.17	11.79	17.00	Pass

- Note:**
- Method a) of power density measurement of KDB 662911 is using for calculating total power density. Total power density is summing entire spectra across corresponding frequency bins on the various outputs by computer.
  - Directional gain = 5.53dBi < 6dBi, so the power density limit shall not be reduced.
  - Refer to section 3.3 for duty cycle spectrum plot.

##### 802.11ac (VHT20)

Chan.	Chan. Freq. (MHz)	PSD W/O Duty Factor (dBm/MHz)		Duty Factor (dB)	Total PSD With Duty Factor (dBm/MHz)	MAX. Limit (dBm/MHz)	Pass / Fail
		Chain 0	Chain 1				
36	5180	5.65	5.31	0.41	8.90	17.00	Pass
40	5200	3.57	5.12	0.41	7.83	17.00	Pass
48	5240	5.19	7.69	0.41	10.04	17.00	Pass

- Note:**
- Method a) of power density measurement of KDB 662911 is using for calculating total power density. Total power density is summing entire spectra across corresponding frequency bins on the various outputs by computer.
  - Directional gain = 5.53dBi < 6dBi, so the power density limit shall not be reduced.
  - Refer to section 3.3 for duty cycle spectrum plot.

### 802.11ac (VHT40)

Chan.	Chan. Freq. (MHz)	PSD W/O Duty Factor (dBm/MHz)		Duty Factor (dB)	Total PSD With Duty Factor (dBm/MHz)	MAX. Limit (dBm/MHz)	Pass / Fail
		Chain 0	Chain 1				
38	5190	-5.94	-4.70	0.8	-1.47	17.00	Pass
46	5230	3.68	1.73	0.8	6.62	17.00	Pass

- Note:**
- Method a) of power density measurement of KDB 662911 is using for calculating total power density. Total power density is summing entire spectra across corresponding frequency bins on the various outputs by computer.
  - Directional gain = 5.53dBi < 6dBi, so the power density limit shall not be reduced.
  - Refer to section 3.3 for duty cycle spectrum plot.

### 802.11ac (VHT80)

Chan.	Chan. Freq. (MHz)	PSD W/O Duty Factor (dBm/MHz)		Duty Factor (dB)	Total PSD With Duty Factor (dBm/MHz)	MAX. Limit (dBm/MHz)	Pass / Fail
		Chain 0	Chain 1				
42	5210	-5.86	-6.14	0.62	-2.37	17.00	Pass

- Note:**
- Method a) of power density measurement of KDB 662911 is using for calculating total power density. Total power density is summing entire spectra across corresponding frequency bins on the various outputs by computer.
  - Directional gain = 5.53dBi < 6dBi, so the power density limit shall not be reduced.
  - Refer to section 3.3 for duty cycle spectrum plot.

### Spectrum Plot of Worst Value

**802.11a / Chain 1 : CH48**

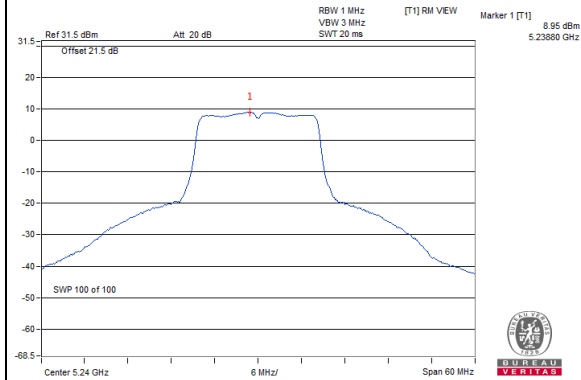

**802.11ac (VHT20) / Chain 1 : CH48**

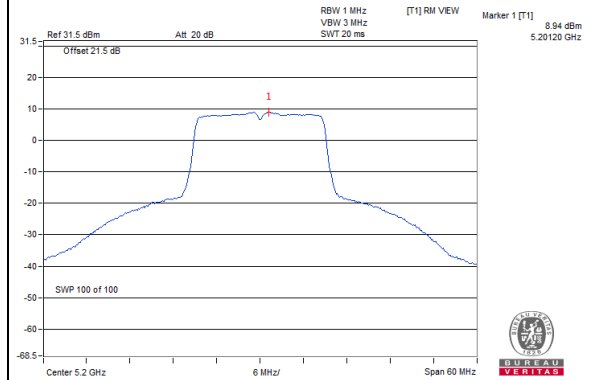

**802.11ac (VHT40) / Chain 0: CH46**

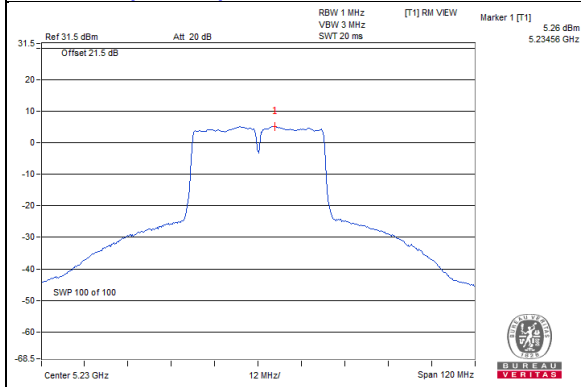

**802.11ac (VHT80) / Chain 0 : CH42**

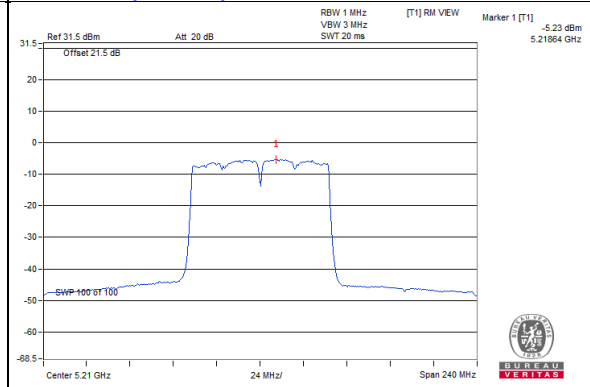

**For U-NII-3:**

**802.11a**

Chan.	Freq. (MHz)	PSD W/O Duty Factor (dBm/300kHz)		Duty Factor (dB)	Total PSD With Duty Factor		Total PSD With Duty Factor (dBm/500kHz)	Limit (dBm/500kHz)	Pass /Fail
		Chain 0	Chain 1		mW/300kHz	dBm/300kHz			
149	5745	-0.06	0.72	0.17	2.2542	3.53	5.75	30.00	Pass
157	5785	-0.36	0.31	0.17	2.0751	3.17	5.39	30.00	Pass
165	5825	-0.32	0.71	0.17	2.1918	3.41	5.63	30.00	Pass

- Note: 1. Method b) Measure and sum spectral maxima across the outputs of KDB 662911 is using for calculating total power density.  
 2. Directional gain = 5.53dBi < 6dBi, so the power density limit shall not be reduced.  
 3. Refer to section 3.3 for duty cycle spectrum plot.

**802.11ac (VHT20)**

Chan.	Freq. (MHz)	PSD W/O Duty Factor (dBm/300kHz)		Duty Factor (dB)	Total PSD With Duty Factor		Total PSD With Duty Factor (dBm/500kHz)	Limit (dBm/500kHz)	Pass /Fail
		Chain 0	Chain 1		mW/300kHz	dBm/300kHz			
149	5745	-2.13	-2.02	0.41	1.364	1.35	3.57	30.00	Pass
157	5785	-2.95	-2.65	0.41	1.1548	0.63	2.85	30.00	Pass
165	5825	-3.60	-1.75	0.41	1.2149	0.85	3.07	30.00	Pass

- Note: 1. Method b) Measure and sum spectral maxima across the outputs of KDB 662911 is using for calculating total power density.  
 2. Directional gain = 5.53dBi < 6dBi, so the power density limit shall not be reduced.  
 3. Refer to section 3.3 for duty cycle spectrum plot.

**802.11ac (VHT40)**

Chan.	Freq. (MHz)	PSD W/O Duty Factor (dBm/300kHz)		Duty Factor (dB)	Total PSD With Duty Factor		Total PSD With Duty Factor (dBm/500kHz)	Limit (dBm/500kHz)	Pass /Fail
		Chain 0	Chain 1		mW/300kHz	dBm/300kHz			
151	5755	-7.35	-6.30	0.8	0.5031	-2.98	-0.76	30.00	Pass
159	5795	-9.16	-6.83	0.8	0.3953	-4.03	-1.81	30.00	Pass

- Note: 1. Method b) Measure and sum spectral maxima across the outputs of KDB 662911 is using for calculating total power density.  
 2. Directional gain = 5.53dBi < 6dBi, so the power density limit shall not be reduced.  
 3. Refer to section 3.3 for duty cycle spectrum plot.

### 802.11ac (VHT80)

Chan.	Freq. (MHz)	PSD W/O Duty Factor (dBm/300kHz)		Duty Factor (dB)	Total PSD With Duty Factor		Total PSD With Duty Factor (dBm/500kHz)	Limit (dBm/ 500kHz)	Pass /Fail
		Chain 0	Chain 1		mW/ 300kHz	dBm/ 300kHz			
155	5775	-9.02	-9.04	0.62	0.2882	-5.40	-3.18	30.00	Pass

- Note: 1. Method b) Measure and sum spectral maxima across the outputs of KDB 662911 is using for calculating total power density.
2. Directional gain = 5.53dBi < 6dBi, so the power density limit shall not be reduced.
3. Refer to section 3.3 for duty cycle spectrum plot.

### Spectrum Plot of Worst Value

**802.11a / Chain 1 : CH149**

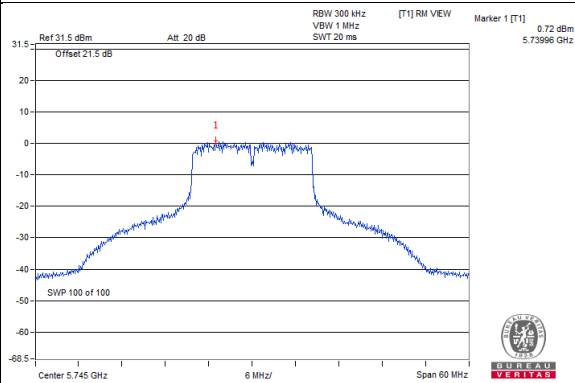

**802.11ac (VHT20) / Chain 1 : CH165**

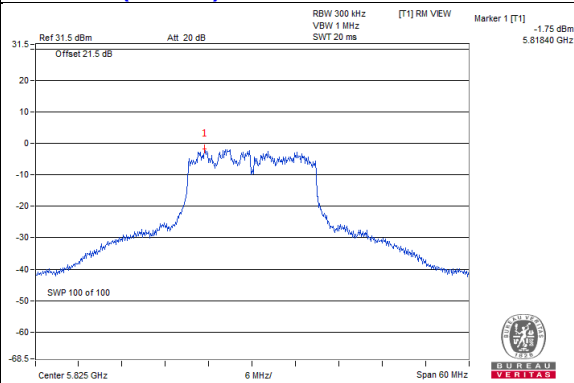

**802.11ac (VHT40) / Chain 1 : CH151**

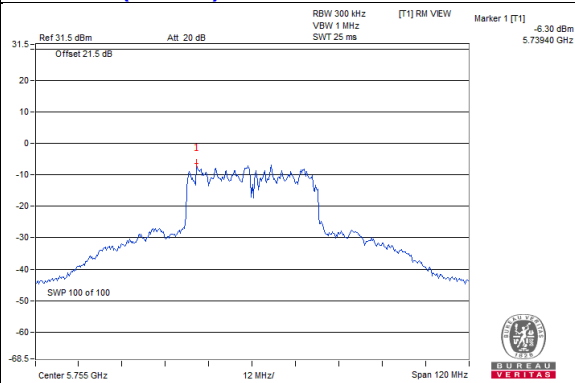

**802.11ac (VHT80) / Chain 0 : CH155**

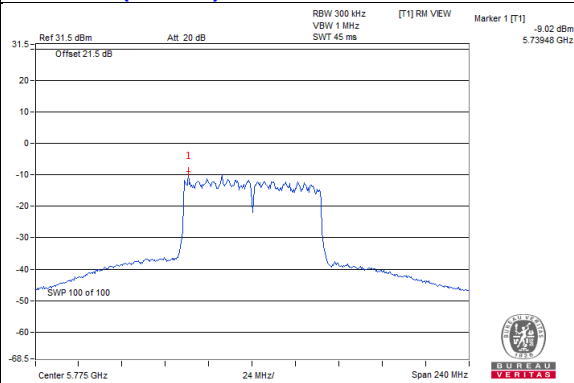

## 4.6 Frequency Stability Measurement

### 4.6.1 Limits of Frequency Stability Measurement

The frequency of the carrier signal shall be maintained within band of operation

### 4.6.2 Test Setup

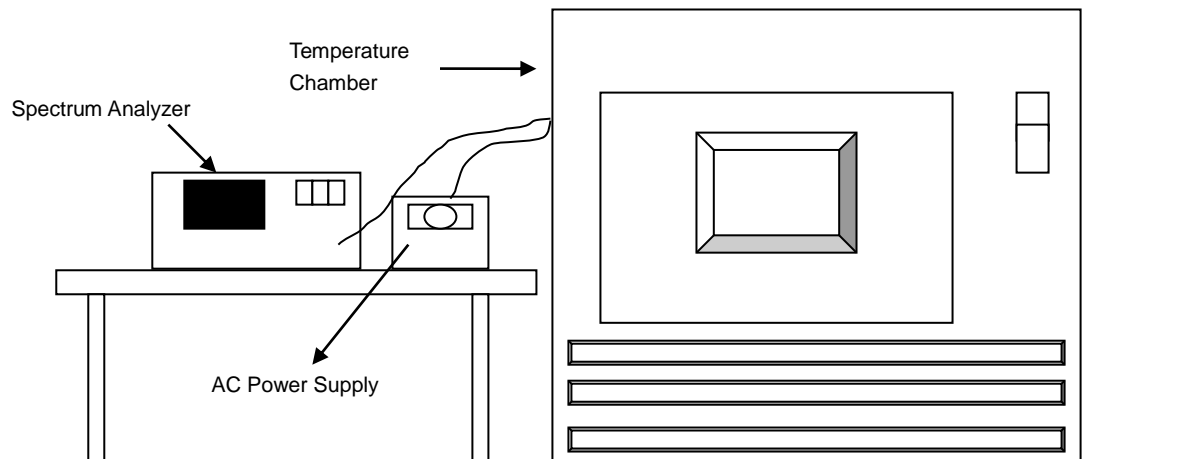

### 4.6.3 Test Instruments

Refer to section 4.1.2 to get information of above instrument.

### 4.6.4 Test Procedure

- The EUT was placed inside the environmental test chamber and powered by nominal AC voltage.
- Turn the EUT on and couple its output to a spectrum analyzer.
- Turn the EUT off and set the chamber to the highest temperature specified.
- Allow sufficient time (approximately 30 min) for the temperature of the chamber to stabilize, turn the EUT on and measure the operating frequency after 0, 2, 5, and 10 Minutes.
- Repeat step (d) with the temperature chamber set to the next desired temperature until measurements down to the lowest specified temperature have been completed.
- The test chamber was allowed to stabilize at +20 degree C for a minimum of 30 Minutes. The supply voltage was then adjusted on the EUT from 85% to 115% and the frequency record.

### 4.6.5 Deviation from Test Standard

No deviation.

### 4.6.6 EUT Operating Condition

Set the EUT transmit at un-modulation mode to test frequency stability.



## 4.6.7 Test Results

Frequency Stability Versus Temp.									
Operating Frequency: 5180 MHz									
TEMP. (°C)	Power Supply (Vac)	0 Minute		2 Minutes		5 Minutes		10 Minutes	
		Measured Frequency (MHz)	Pass/Fail	Measured Frequency (MHz)	Pass/Fail	Measured Frequency (MHz)	Pass/Fail	Measured Frequency (MHz)	Pass/Fail
50	120	5179.9931	PASS	5179.9928	PASS	5179.9939	PASS	5179.9937	PASS
40	120	5180.0076	PASS	5180.0065	PASS	5180.0083	PASS	5180.0068	PASS
30	120	5180.0281	PASS	5180.0237	PASS	5180.0265	PASS	5180.0249	PASS
20	120	5180.0137	PASS	5180.0148	PASS	5180.0135	PASS	5180.0136	PASS
10	120	5179.9904	PASS	5179.9895	PASS	5179.9902	PASS	5179.993	PASS
0	120	5179.9942	PASS	5179.9921	PASS	5179.994	PASS	5179.9963	PASS
-10	120	5179.9828	PASS	5179.9848	PASS	5179.9806	PASS	5179.9832	PASS
-20	120	5179.991	PASS	5179.9899	PASS	5179.9883	PASS	5179.9892	PASS
-30	120	5180.0154	PASS	5180.0187	PASS	5180.0168	PASS	5180.0175	PASS

Frequency Stability Versus Voltage									
Operating Frequency: 5180 MHz									
TEMP. (°C)	Power Supply (Vac)	0 Minute		2 Minutes		5 Minutes		10 Minutes	
		Measured Frequency (MHz)	Pass/Fail	Measured Frequency (MHz)	Pass/Fail	Measured Frequency (MHz)	Pass/Fail	Measured Frequency (MHz)	Pass/Fail
20	138	5180.0147	PASS	5180.0138	PASS	5180.0139	PASS	5180.0129	PASS
	120	5180.0137	PASS	5180.0148	PASS	5180.0135	PASS	5180.0136	PASS
	102	5180.0145	PASS	5180.0151	PASS	5180.0125	PASS	5180.0132	PASS

## 4.7 6dB Bandwidth Measurement

### 4.7.1 Limits of 6dB Bandwidth Measurement

The minimum of 6dB Bandwidth Measurement is 0.5MHz.

### 4.7.2 Test Setup

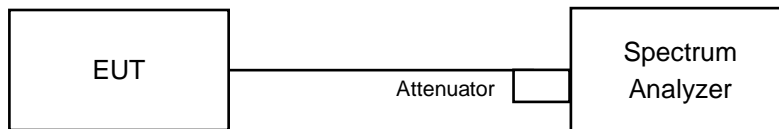

### 4.7.3 Test Instruments

Refer to section 4.1.2 to get information of above instrument.

### 4.7.4 Test Procedure

#### MEASUREMENT PROCEDURE REF

- Set resolution bandwidth (RBW) = 100kHz
- Set the video bandwidth (VBW)  $\geq 3 \times$  RBW, Detector = Peak.
- Trace mode = max hold.
- Sweep = auto couple.
- Measure the maximum width of the emission that is constrained by the frequencies associated with the two amplitude points (upper and lower) that are attenuated by 6 dB relative to the maximum level measured in the fundamental emission

### 4.7.5 Deviation from Test Standard

No deviation.

### 4.7.6 EUT Operating Condition

The software provided by client to enable the EUT under transmission condition continuously at lowest, middle and highest channel frequencies individually.

#### 4.7.7 Test Results

##### 802.11a

Channel	Frequency (MHz)	6dB Bandwidth (MHz)		Minimum Limit (MHz)	Pass / Fail
		Chain 0	Chain 1		
149	5745	16.32	16.32	0.5	Pass
157	5785	16.35	16.37	0.5	Pass
165	5825	16.37	16.39	0.5	Pass

##### 802.11ac (VHT20)

Channel	Frequency (MHz)	6dB Bandwidth (MHz)		Minimum Limit (MHz)	Pass / Fail
		Chain 0	Chain 1		
149	5745	17.59	17.62	0.5	Pass
157	5785	16.88	17.62	0.5	Pass
165	5825	16.93	17.60	0.5	Pass

##### 802.11ac (VHT40)

Channel	Frequency (MHz)	6dB Bandwidth (MHz)		Minimum Limit (MHz)	Pass / Fail
		Chain 0	Chain 1		
151	5755	33.61	33.95	0.5	Pass
159	5795	35.48	35.15	0.5	Pass

##### 802.11ac (VHT80)

Channel	Frequency (MHz)	6dB Bandwidth (MHz)		Minimum Limit (MHz)	Pass / Fail
		Chain 0	Chain 1		
155	5775	75.93	75.93	0.5	Pass

### Spectrum Plot of Worst Value

**802.11a / Chain 0 : CH149**

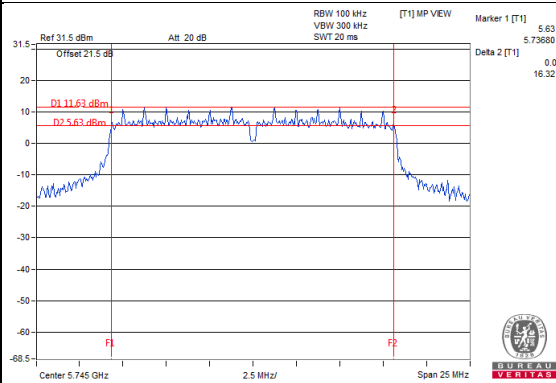

**802.11ac (VHT20) / Chain 0 : CH157**

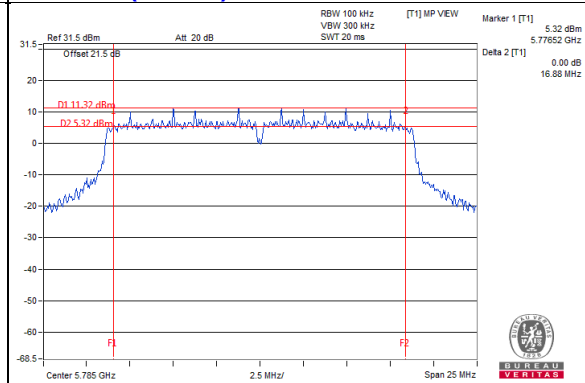

**802.11ac (VHT40) / Chain 0 : CH151**

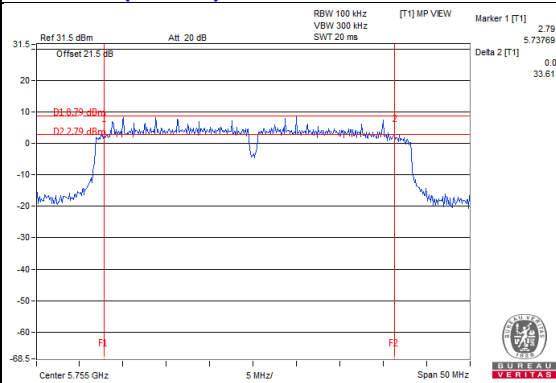

**802.11ac (VHT80) / Chain 0 : CH155**

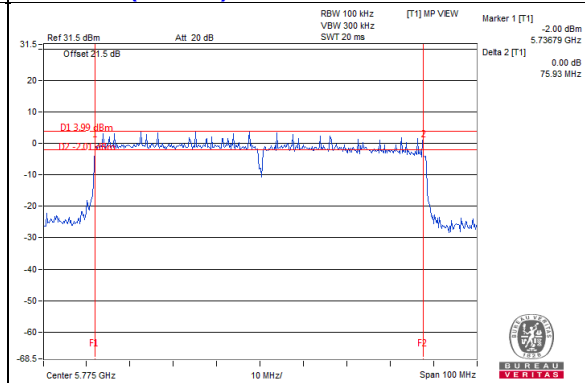

## 5 Pictures of Test Arrangements

Please refer to the attached file (Test Setup Photo).

# Annex A- Radiated Out of Band Emission (OOBE) Measurement (For U-NII-3 band)

802.11a

**CH 149 5745 MHz**

**Horizontal**

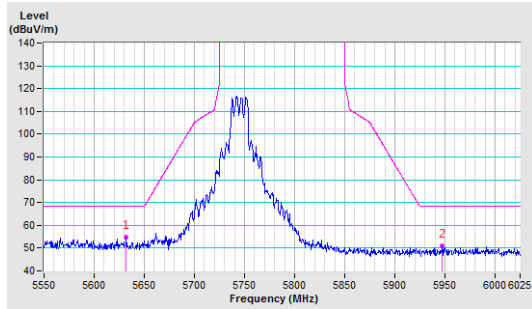

**Vertical**

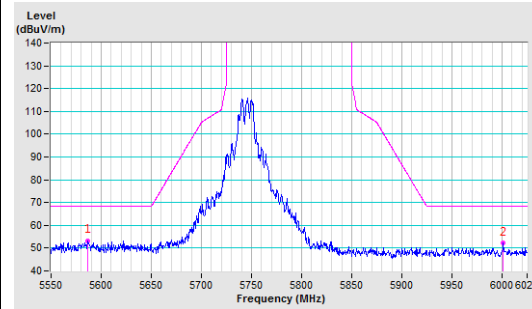

**CH 157 5785 MHz**

**Horizontal**

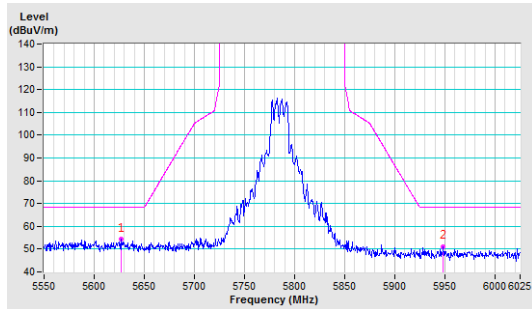

**Vertical**

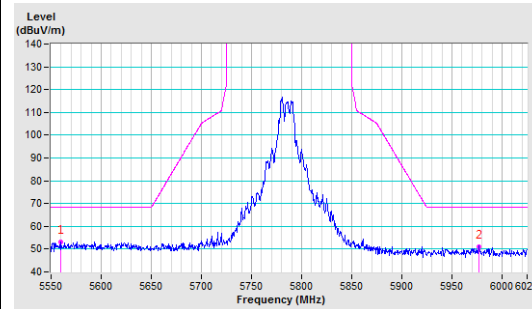

**CH 165 5825 MHz**

**Horizontal**

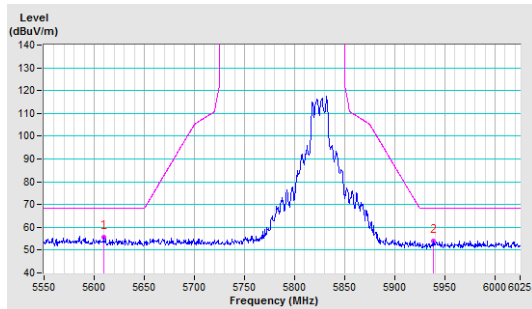

**Vertical**

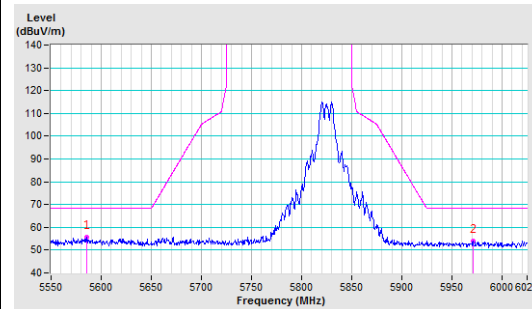

802.11ac (VHT20)

CH 149 5745 MHz

Horizontal

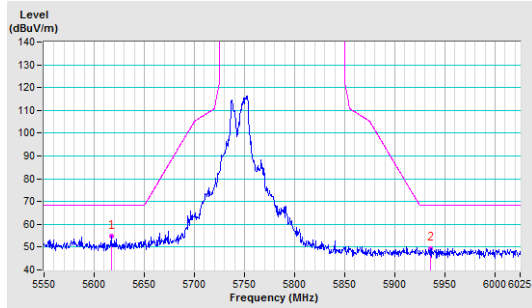

Vertical

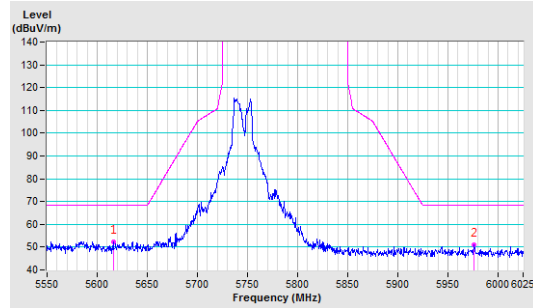

CH 157 5785 MHz

Horizontal

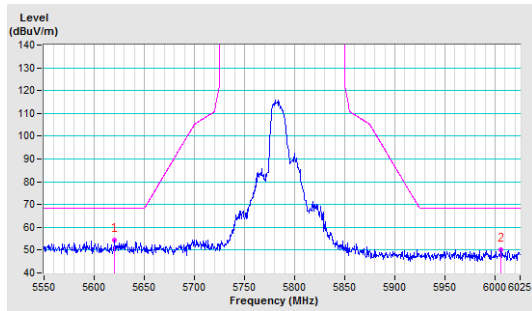

Vertical

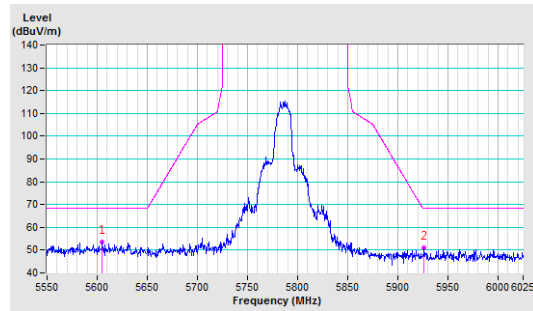

CH 165 5825 MHz

Horizontal

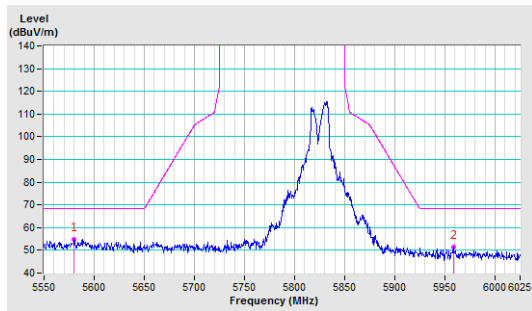

Vertical

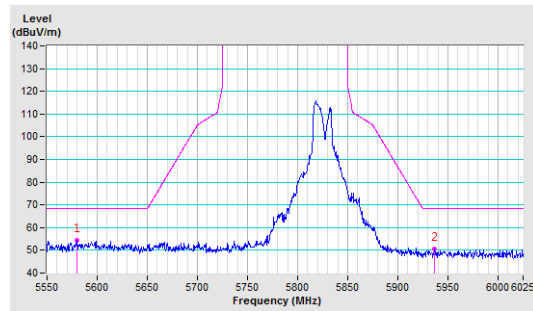

### 802.11ac (VHT40)

#### CH 151 5755 MHz

##### Horizontal

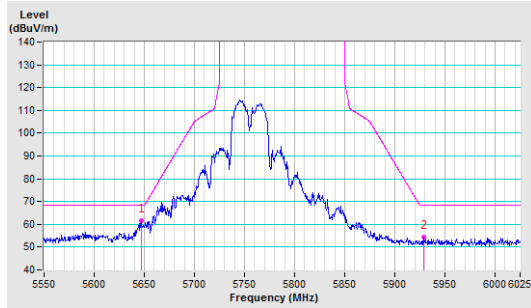

##### Vertical

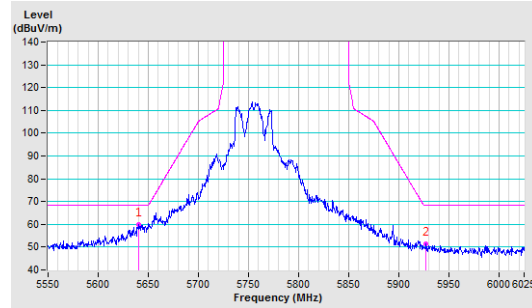

#### CH 159 5795 MHz

##### Horizontal

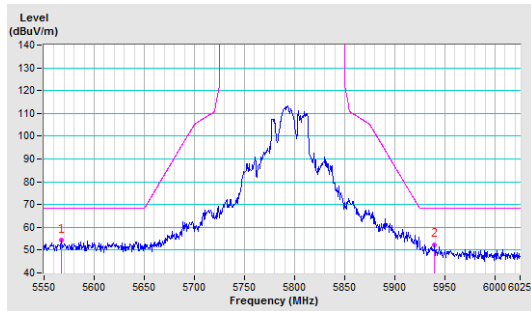

##### Vertical

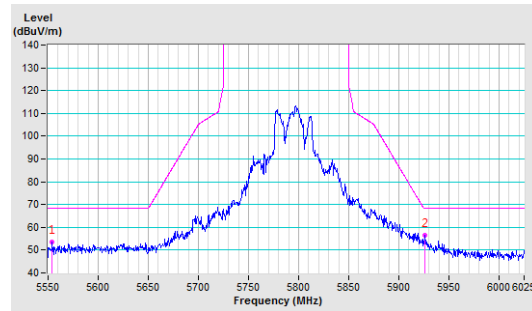

### 802.11ac (VHT80)

#### CH 155 5775 MHz

##### Horizontal

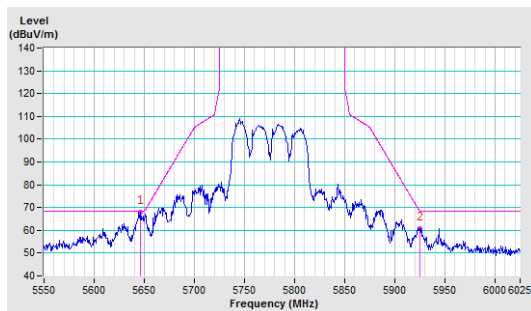

##### Vertical

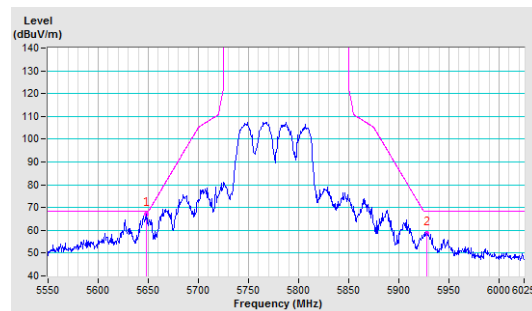



## Appendix – Information of the Testing Laboratories

We, Bureau Veritas Consumer Products Services (H.K.) Ltd., Taoyuan Branch, were founded in 1988 to provide our best service in EMC, Radio, Telecom and Safety consultation. Our laboratories are FCC recognized accredited test firms and accredited according to ISO/IEC 17025.

If you have any comments, please feel free to contact us at the following:

**Linkou EMC/RF Lab**

Tel: 886-2-26052180

Fax: 886-2-26051924

**Hsin Chu EMC/RF/Telecom Lab**

Tel: 886-3-6668565

Fax: 886-3-6668323

**Hwa Ya EMC/RF/Safety Lab**

Tel: 886-3-3183232

Fax: 886-3-3270892

**Email:** [service.adt@tw.bureauveritas.com](mailto:service.adt@tw.bureauveritas.com)

**Web Site:** [www.bureauveritas-adt.com](http://www.bureauveritas-adt.com)

The address and road map of all our labs can be found in our web site also.

--- END ---