

FCC Test Report

(PART 27)

Report No.: RF170914C07

FCC ID: NKR-CB1GA21LG2

Test Model: UMC-A21LG2

Received Date: Sep. 14, 2017

Test Date: Aug. 28, 2017 ~ Sep. 28, 2017

Issued Date: Oct. 06, 2017

Applicant: Wistron Neweb Corporation

Address: 20 Park Avenue II (or Yuanchiu 2nd Rd), Hsinchu Science Park, Hsinchu
308, Taiwan

Issued By: Bureau Veritas Consumer Products Services (H.K.) Ltd., Taoyuan Branch

Lab Address: No. 47-2, 14th Ling, Chia Pau Vil., Lin Kou Dist., New Taipei City, Taiwan
(R.O.C)

Test Location: No. 19, Hwa Ya 2nd Rd, Wen Hwa Tsuen, Kwei Shan Hsiang, Taoyuan
Hsien 333, Taiwan, R.O.C.



This report is for your exclusive use. Any copying or replication of this report to or for any other person or entity, or use of our name or trademark, is permitted only with our prior written permission. This report sets forth our findings solely with respect to the test samples identified herein. The results set forth in this report are not indicative or representative of the quality or characteristics of the lot from which a test sample was taken or any similar or identical product unless specifically and expressly noted. Our report includes all of the tests requested by you and the results thereof based upon the information that you provided to us. You have 60 days from date of issuance of this report to notify us of any material error or omission caused by our negligence, provided, however, that such notice shall be in writing and shall specifically address the issue you wish to raise. A failure to raise such issue within the prescribed time shall constitute your unqualified acceptance of the completeness of this report, the tests conducted and the correctness of the report contents. Unless specific mention, the uncertainty of measurement has been explicitly taken into account to declare the compliance or non-compliance to the specification. The report must not be used by the client to claim product certification, approval, or endorsement by TAF or any government agency

Table of Contents

Release Control Record	3
1 Certificate of Conformity	4
2 Summary of Test Results	5
2.1 Measurement Uncertainty	5
2.2 Test Site and Instruments	6
3 General Information	8
3.1 General Description of EUT	8
3.2 Configuration of System under Test	9
3.2.1 Description of Support Units	9
3.3 Test Mode Applicability and Tested Channel Detail	10
3.4 EUT Operating Conditions	11
3.5 General Description of Applied Standards	11
4 Test Types and Results	12
4.1 Output Power Measurement	12
4.1.1 Limits of Output Power Measurement	12
4.1.2 Test Procedures	12
4.1.3 Test Setup	13
4.1.4 Test Results	14
4.2 Frequency Stability Measurement	16
4.2.1 Limits of Frequency Stability Measurement	16
4.2.2 Test Procedure	16
4.2.3 Test Setup	16
4.2.4 Test Results	17
4.3 Occupied Bandwidth Measurement	19
4.3.1 Limits of Occupied Bandwidth Measurement	19
4.3.2 Test Procedure	19
4.3.3 Test Setup	19
4.3.4 Test Result	20
4.4 Band Edge Measurement	21
4.4.1 Limits of Band Edge Measurement	21
4.4.2 Test Setup	21
4.4.3 Test Procedures	21
4.4.4 Test Results	22
4.5 Peak to Average Ratio	26
4.5.1 Limits of Peak to Average Ratio Measurement	26
4.5.2 Test Setup	26
4.5.3 Test Procedures	26
4.5.4 Test Results	27
4.6 Conducted Spurious Emissions	28
4.6.1 Limits of Conducted Spurious Emissions Measurement	28
4.6.2 Test Setup	28
4.6.3 Test Procedure	28
4.6.4 Test Results	29
4.7 Radiated Emission Measurement	30
4.7.1 Limits of Radiated Emission Measurement	30
4.7.2 Test Procedure	30
4.7.3 Deviation from Test Standard	30
4.7.4 Test Setup	31
4.7.5 Test Results	32
5 Pictures of Test Arrangements	38
Appendix – Information on the Testing Laboratories	39

Release Control Record

Issue No.	Description	Date Issued
RF170914C07	Original Release	Oct. 06, 2017

1 Certificate of Conformity

Product: UMC-A21LG2

Brand: WNC

Test Model: UMC-A21LG2

Sample Status: Identical Prototype

Applicant: Wistron Neweb Corporation

Test Date: Aug. 28, 2017 ~ Sep. 28, 2017

Standards: FCC Part 27, Subpart C

The above equipment has been tested by **Bureau Veritas Consumer Products Services (H.K.) Ltd., Taoyuan Branch**, and found compliance with the requirement of the above standards. The test record, data evaluation & Equipment Under Test (EUT) configurations represented herein are true and accurate accounts of the measurements of the sample's EMC characteristics under the conditions specified in this report.

Prepared by : Evonne Liu , **Date:** Oct. 06, 2017
Evonne Liu / Specialist

Approved by : David Huang , **Date:** Oct. 06, 2017
David Huang / Project Engineer

2 Summary of Test Results

Applied Standard: FCC Part 27 & Part 2 (LTE 13)			
FCC Clause	Test Item	Result	Remarks
2.1046 27.50(b)(10)	Maximum Peak Output Power	Pass	Meet the requirement of limit.
2.1055 27.54	Frequency Stability	Pass	Meet the requirement of limit.
2.1049 27.53(g)	Occupied Bandwidth	Pass	Meet the requirement of limit.
27.50(d)(5)	Peak to Average Ratio	Pass	Meet the requirement of limit.
27.53(g)	Band Edge Measurements	Pass	Meet the requirement of limit.
2.1051 27.53(g)	Conducted Spurious Emissions	Pass	Meet the requirement of limit.
2.1053 27.53(g)(f)	Radiated Spurious Emissions	Pass	Meet the requirement of limit. Minimum passing margin is -1.03 dB at 1568 MHz.

2.1 Measurement Uncertainty

Where relevant, the following measurement uncertainty levels have been estimated for tests performed on the EUT as specified in CISPR 16-4-2:

Measurement	Frequency	Expanded Uncertainty (k=2) (±)
Conducted Emissions at mains ports	150 kHz ~ 30 MHz	2.44 dB
Radiated Emissions up to 1 GHz	30 MHz ~ 200 MHz	2.93 dB
	200 MHz ~ 1000 MHz	2.95 dB
Radiated Emissions above 1 GHz	1 GHz ~ 18 GHz	2.26 dB
	18 GHz ~ 40 GHz	1.94 dB

2.2 Test Site and Instruments

Description & Manufacturer	Model No.	Serial No.	Date of Calibration	Due Date of Calibration
Test Receiver Agilent	N9038A	MY51210203	Feb. 17, 2017	Feb. 16, 2018
Spectrum Analyzer Agilent	N9010A	MY52220314	Dec. 16, 2016	Dec. 15, 2017
Spectrum Analyzer ROHDE & SCHWARZ	FSU43	101261	Dec. 13, 2016	Dec. 12, 2017
BILOG Antenna SCHWARZBECK	VULB9168	9168-472	Dec. 26, 2016	Dec. 25, 2017
HORN Antenna SCHWARZBECK	BBHA 9120 D	9120D-969	Dec. 12, 2016	Dec. 11, 2017
Double Ridge Guide Horn Antenna EMCO	3115	5619	Dec. 15, 2016	Dec. 14, 2017
BILOG Antenna SCHWARZBECK	VULB 9168	9168-153	Dec. 13, 2016	Dec. 12, 2017
LTE Wireless Communication Test Set Keysight	E7515A	MY56030229	Mar. 03, 2017	Mar. 02, 2018
Preamplifier EMCI	EMC 012645	980115	Oct. 21, 2016	Oct. 20, 2017
Preamplifier EMCI	EMC 184045	980116	Oct. 21, 2016	Oct. 20, 2017
Preamplifier EMCI	EMC 330H	980112	Oct. 21, 2016	Oct. 20, 2017
Power Meter Anritsu	ML2495A	1145013	Mar. 07, 2017	Mar. 06, 2018
Power Sensor Anritsu	MA2411B	1126085	Mar. 07, 2017	Mar. 06, 2018
RF signal cable HUBER+SUHNNER	SUCOFLEX 104	309219/4 2950114	Oct. 21, 2016	Oct. 20, 2017
RF signal cable HUBER+SUHNNER	SUCOFLEX 104	250130/4	Oct. 21, 2016	Oct. 20, 2017
RF Coaxial Cable Worken	8D-FB	Cable-Ch10-01	Oct. 21, 2016	Oct. 20, 2017
Software BV ADT	E3 6.120103	NA	NA	NA
Antenna Tower MF	MFA-440H	NA	NA	NA
Turn Table MF	MFT-201SS	NA	NA	NA
Antenna Tower & Turn Table Controller MF	MF-7802	NA	NA	NA
Radio Communication Analyzer	MT8820C	6201300640	Aug. 16, 2017	Aug. 15, 2019
Temperature & Humidity Chamber	GTH-120-40-CP-A R	MAA1306-019	Sep. 02, 2016	Sep. 01, 2017
			Sep. 08, 2017	Sep. 07, 2018
DC Power Supply Topward	33010D	807748	Oct. 25, 2016	Oct. 24, 2018
Digital Multimeter Fluke	87-III	70360742	Jun. 30, 2017	Jun. 29, 2018
Wideband Radio Communication Tester R&S	CMW500	101802	Nov. 03, 2016	Nov. 02, 2017

- Note:
1. The calibration interval of the above test instruments is 12 / 24 months and the calibrations are traceable to NML/ROC and NIST/USA.
 2. The test was performed in HwaYa Chamber 10.
 3. The horn antenna and preamplifier (model: EMC 184045) are used only for the measurement of emission frequency above 1 GHz if tested.
 4. The IC Site Registration No. is IC7450F-10.

3 General Information

3.1 General Description of EUT

Product	UMC-A21LG2	
Brand	WNC	
Test Model	UMC-A21LG2	
Status of EUT	Identical Prototype	
Power Supply Rating	4 Vdc (host equipment)	
Modulation Type	LTE	QPSK
Frequency Range	LTE Band 13 (Channel Bandwidth: 5 MHz)	779.5 ~ 784.5 MHz
	LTE Band 13 (Channel Bandwidth: 10 MHz)	782.0 MHz
Emission Designator	LTE Band 13 (Channel Bandwidth: 5 MHz)	1M10G7D
	LTE Band 13 (Channel Bandwidth: 10 MHz)	1M08G7D
Max. ERP Power	LTE Band 13 (Channel Bandwidth: 5 MHz)	167.11mW
	LTE Band 13 (Channel Bandwidth: 10 MHz)	171.40mW
Antenna Type	Fixed External Antenna	
Accessory Device	Refer to Note as below	
Data Cable Supplied	Refer to Note as below	

Note:

- There're 2 configuraitons for the EUT listed as below.
 Main Sample: ANT 1 of A2GL2-R
 2nd Sample: ANT 2 of A21LG2
- The above EUT information is declared by manufacturer and for more detailed features description, please refer to the manufacturer's specifications or user's manual.

3.2 Configuration of System under Test

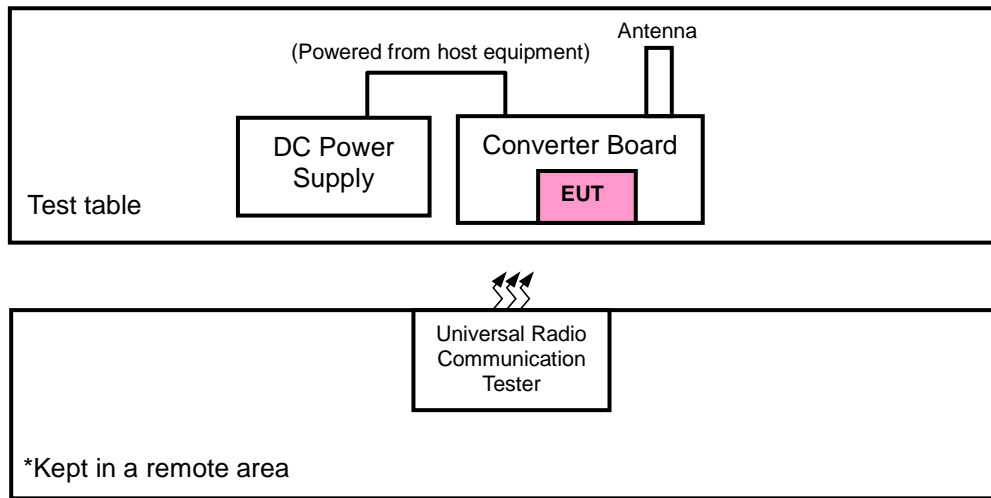

3.2.1 Description of Support Units

The EUT has been tested as an independent unit together with other necessary accessories or support units. The following support units or accessories were used to form a representative test configuration during the tests.

No.	Product	Brand	Model No.	Serial No.	FCC ID
1.	Power Supply	N/A	N/A	N/A	N/A
2.	Converter Board	N/A	N/A	N/A	N/A
3.	Wideband Radio Communication Tester	R&S	CMW500	101802	NA
4.	Antenna	N/A	N/A	N/A	N/A

No.	Signal Cable Description Of The Above Support Units
1.	N/A
2.	N/A
3.	N/A
4.	N/A

Note:

1. All power cords of the above support units are non-shielded (1.8m).
2. Items 3 acted as communication partners to transfer data.

3.3 Test Mode Applicability and Tested Channel Detail

Pre-Scan has been conducted to determine the worst-case mode from all possible combinations between available modulations, data rates, XYZ axis, and antenna ports

The worst case was found when positioned as the table below. Following channel(s) was (were) selected for the final test as listed below:

EUT Configure Mode	Discription
A	Main Sample
B	2 nd Sample

Band	ERP	Radiated Emission
LTE Band 13	X-plane	X-axis

LTE Band 13

EUT Configure Mode	Test Item	Available Channel	Tested Channel	Channel Bandwidth	Modulation	Mode
A	ERP	23205 to 23255	23205, 23230, 23255	5 MHz	QPSK	1 RB / 0 RB Offset
		23230	23230	10 MHz	QPSK	1 RB / 0 RB Offset
	Frequency Stability	23205 to 23255	23205, 23255	5 MHz	QPSK	1 RB / 0 RB Offset
		23230	23230	10 MHz	QPSK	1 RB / 0 RB Offset
	Occupied Bandwidth	23205 to 23255	23205, 23230, 23255	5 MHz	QPSK	6 RB / 0 RB Offset
		23230	23230	10 MHz	QPSK	6 RB / 0 RB Offset
	Peak to Average Ratio	23205 to 23255	23205, 23230, 23255	5 MHz	QPSK	1 RB / 0 RB Offset
		23230	23230	10 MHz	QPSK	1 RB / 0 RB Offset
	Band Edge	23205 to 23255	23205	5 MHz	QPSK	1 RB / 0 RB Offset
			23255	5 MHz	QPSK	6 RB / 0 RB Offset
		23230	23230	10 MHz	QPSK	1 RB / 0 RB Offset
			23230	10 MHz	QPSK	6 RB / 0 RB Offset
	Conducted Emission	23205 to 23255	23205, 23230, 23255	5 MHz	QPSK	1 RB / 0 RB Offset
		23230	23230	10 MHz	QPSK	1 RB / 0 RB Offset
A, B	Radiated Emission	23230	23230	10 MHz	QPSK	1 RB / 0 RB Offset

Note: This device was tested under all bandwidths, RB configurations and modulations. The worst case was found in QPSK modulation.

Test Condition:

Test Item	Environmental Conditions	Input Power	Tested By
ERP / EIRP	25 deg. C, 65 % RH	4 Vdc	Carlos Chen
Frequency Stability	25 deg. C, 65 % RH	4 Vdc	Carlos Chen
Occupied Bandwidth	25 deg. C, 65 % RH	4 Vdc	Carlos Chen
Band Edge	25 deg. C, 65 % RH	4 Vdc	Carlos Chen
Peak to Average Ratio	25 deg. C, 65 % RH	4 Vdc	Carlos Chen
Condcudeted Emission	25 deg. C, 65 % RH	4 Vdc	Carlos Chen
Radiated Emission	25 deg. C, 65 % RH	120 Vac, 60 Hz	Han Wu

3.4 EUT Operating Conditions

The EUT makes a call to the communication simulator. The communication simulator station system controlled a EUT to export maximum output power under transmission mode and specific channel frequency

3.5 General Description of Applied Standards

The EUT is a RF Product. According to the specifications of the manufacturer, it must comply with the requirements of the following standards:

FCC 47 CFR Part 2

FCC 47 CFR Part 27

KDB 971168 D01 Power Meas License Digital Systems v02r02

ANSI/TIS/EIS-603-E 2016 per KDB 442401

ANSI C63.26-2015

Note: All test items have been performed and recorded as per the above standards.

4 Test Types and Results

4.1 Output Power Measurement

4.1.1 Limits of Output Power Measurement

Portable stations (hand-held devices) operating in the 776-787 MHz band are limited to 3 watts ERP

4.1.2 Test Procedures

EIRP / ERP Measurement:

- a. All measurements were done at low, middle and high operational frequency range. RBW and VBW is 5 MHz for WCDMA and 10 MHz for LTE mode.
- b. Substitution method is used for E.I.R.P measurement. In the semi-anechoic chamber, EUT placed on the 0.8 m height of Turn Table, rotated the table around 360 degrees to search the maximum radiation power and receiver antenna shall be rotated vertical and horizontal polarization and moved height from 1 m to 4 m to find the maximum polar radiated power. The "Read Value" is the spectrum reading the maximum power value.
- c. The substitution horn antenna is substituted for EUT at the same position and signals generator export the CW signal to the substitution antenna via a tx cable. Rotated the Turn Table and moved receiving antenna to find the maximum radiation power. Adjust output power level of S.G to get a Value of spectrum reading equal to "Read Value" of step b. Record the power level of S.G.
- d. $EIRP = \text{Output power level of S.G} - \text{TX cable loss} + \text{Antenna gain of substitution horn}$. E.R.P power can be calculated form E.I.R.P power by subtracting the gain of dipole, $E.R.P \text{ power} = E.I.P.R \text{ power} - 2.15 \text{ dBi}$.

Conducted Power Measurement:

- a. The EUT was set up for the maximum power with LTE link data modulation and link up with simulator.
- b. Set the EUT to transmit under low, middle and high channel and record the power level shown on simulator.

4.1.3 Test Setup

EIRP / ERP Measurement:

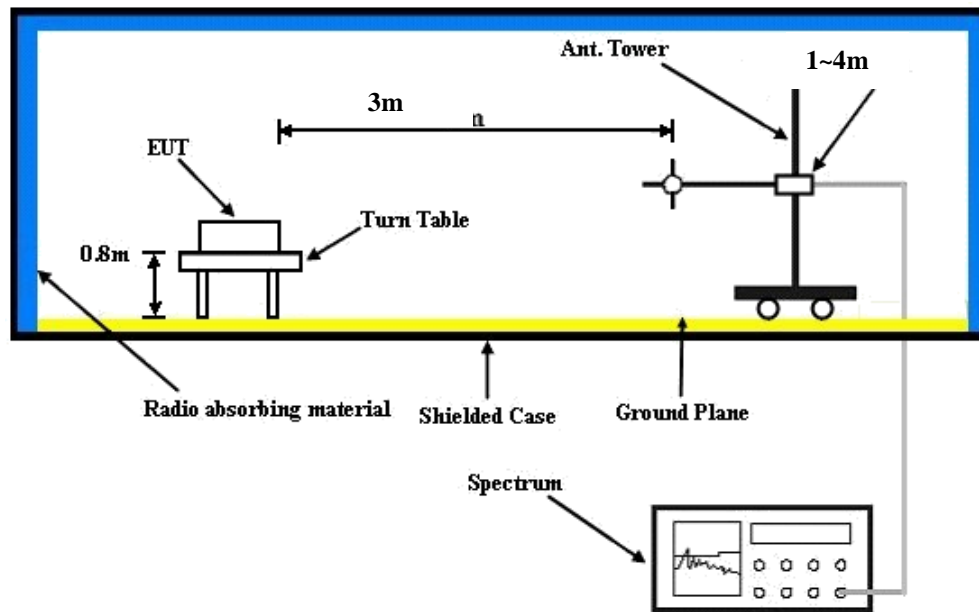

For the actual test configuration, please refer to the attached file (Test Setup Photo).

Conducted Power Measurement:



4.1.4 Test Results

Conducted Output Power (dBm)

Band / BW	RB Size	RB Offset	RB Index	QPSK			3GPP MPR (dB)
				Low Ch 23205	Mid Ch 23230	High Ch 23255	
				779.5 MHz	782.0 MHz	784.5 MHz	
13 / 5M	1	0	0	22.39	22.29	22.47	0
	1	5	3	22.36	22.27	22.44	0
	1	0	3	22.38	22.21	22.45	0
	1	5	0	22.35	22.38	22.39	0
	3	0	0	21.52	21.46	21.43	1
	3	3	3	21.45	21.31	21.53	1
	6	0	0	21.49	21.45	21.45	1
6	0	3	21.46	21.43	21.47	1	

Band / BW	RB Size	RB Offset	RB Index	QPSK	3GPP MPR (dB)
				Mid Ch 23230	
				782.0 MHz	
13 / 10M	1	0	0	22.49	0
	1	5	7	22.41	0
	1	0	3	22.42	0
	1	5	4	22.39	0
	4	0	0	22.13	0
	4	2	7	22.14	0
	6	0	0	21.57	1
	6	0	7	21.52	1

ERP Power (dBm)
Mode A

LTE Band 13							
Channel Bandwidth: 5 MHz / QPSK							
Plane	Channel	Frequency (MHz)	LVL (dBm)	Correction Factor (dB)	ERP (dBm)	ERP (mW)	Polarization (H/V)
X	23205	779.5	-16.86	32.24	13.23	21.04	H
	23230	782.0	-16.75	32.17	13.27	21.23	
	23255	784.5	-16.76	32.11	13.20	20.89	
	23205	779.5	-10.99	32.43	19.29	84.92	V
	23230	782.0	-10.88	32.42	19.39	86.90	
	23255	784.5	-11.03	32.46	19.28	84.72	

LTE Band 13							
Channel Bandwidth: 10 MHz / QPSK							
Plane	Channel	Frequency (MHz)	LVL (dBm)	Correction Factor (dB)	ERP (dBm)	ERP (mW)	Polarization (H/V)
X	23230	782.0	-16.20	32.17	13.82	24.10	H
	23230	782.0	-10.47	32.42	19.80	95.50	V

Mode B

LTE Band 13							
Channel Bandwidth: 5 MHz / QPSK							
Plane	Channel	Frequency (MHz)	LVL (dBm)	Correction Factor (dB)	ERP (dBm)	ERP (mW)	Polarization (H/V)
X	23205	779.5	-7.88	32.24	22.21	166.34	H
	23230	782.0	-7.79	32.17	22.23	167.11	
	23255	784.5	-7.95	32.11	22.01	158.85	
	23205	779.5	-15.55	32.43	14.73	29.72	V
	23230	782.0	-15.44	32.42	14.83	30.41	
	23255	784.5	-15.59	32.46	14.72	29.65	

LTE Band 13							
Channel Bandwidth: 10 MHz / QPSK							
Plane	Channel	Frequency (MHz)	LVL (dBm)	Correction Factor (dB)	ERP (dBm)	ERP (mW)	Polarization (H/V)
X	23230	782.0	-7.68	32.17	22.34	171.40	H
	23230	782.0	-15.26	32.42	15.01	31.70	V

4.2 Frequency Stability Measurement

4.2.1 Limits of Frequency Stability Measurement

The frequency stability shall be sufficient to ensure that the fundamental emissions stay within the authorized bands of operation.

4.2.2 Test Procedure

- Device is placed at the oven room. The oven room could control the temperatures and humidity. Power warm up is at least 15 min and power applied should perform before recording frequency error.
- EUT is connected the external power supply to control the DC input power. The test voltage range is from minimum to maximum working voltage. Each step shall be record the frequency error rate.
- The temperature range step is 10 degrees in this test items. All temperature levels shall be hold the ± 0.5 °C during the measurement testing. The each temperature step shall be at least 0.5 hours, consider the EUT could be test under the stability condition.

Note: The frequency error was recorded frequency error from the communication simulator.

4.2.3 Test Setup

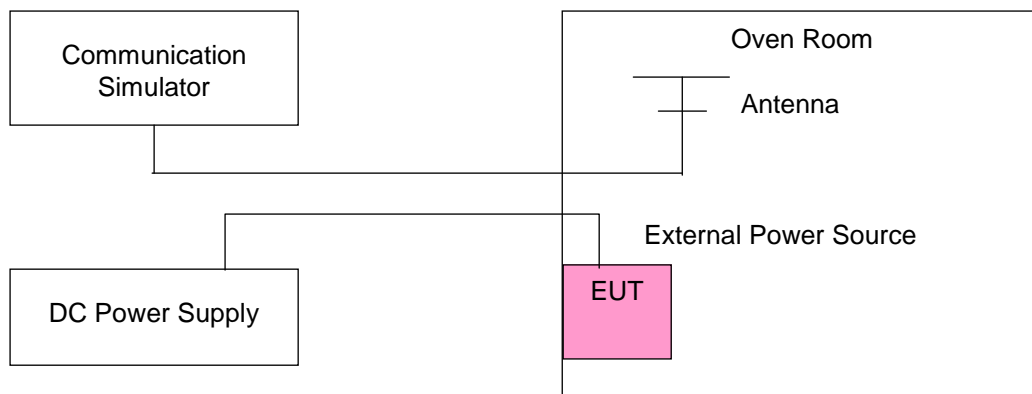

4.2.4 Test Results

Frequency Error vs. Voltage

Voltage (Volts)	LTE Band 13				Limit (ppm)
	Channel Bandwidth: 5 MHz				
	Low Channel		High Channel		
	Frequency (MHz)	Frequency Error (ppm)	Frequency (MHz)	Frequency Error (ppm)	
4.0	779.500012	0.016	784.500011	0.014	2.5
3.8	779.500013	0.016	784.500014	0.018	2.5
4.2	779.500013	0.017	784.500011	0.014	2.5

Note: The applicant defined the normal working voltage of the battery is from 3.8 Vdc to 4.2 Vdc.

Frequency Error vs. Temperature

Temp. (°C)	LTE Band 13				Limit (ppm)
	Channel Bandwidth: 5 MHz				
	Low Channel		High Channel		
	Frequency (MHz)	Frequency Error (ppm)	Frequency (MHz)	Frequency Error (ppm)	
-20	779.500013	0.017	784.500014	0.018	2.5
-10	779.500013	0.016	784.500011	0.014	2.5
0	779.500013	0.017	784.500011	0.014	2.5
10	779.500013	0.016	784.500013	0.017	2.5
20	779.499987	-0.017	784.499990	-0.013	2.5
30	779.499989	-0.014	784.499989	-0.015	2.5
40	779.499989	-0.014	784.499989	-0.015	2.5
50	779.499986	-0.018	784.499988	-0.015	2.5
60	779.499987	-0.017	784.499990	-0.013	2.5
70	779.499987	-0.017	784.499985	-0.019	2.5

Frequency Error vs. Voltage

Voltage (Volts)	LTE Band 13		Limit (ppm)
	Channel Bandwidth: 10 MHz		
	Frequency (MHz)	Frequency Error (ppm)	
4.0	782.000011	0.014	2.5
3.8	782.000013	0.017	2.5
4.2	782.000012	0.015	2.5

Note: The applicant defined the normal working voltage of the battery is from 3.8 Vdc to 4.2 Vdc.

Frequency Error vs. Temperature

Temp. (°C)	LTE Band 13		Limit (ppm)
	Channel Bandwidth: 10 MHz		
	Frequency (MHz)	Frequency Error (ppm)	
-20	782.000012	0.016	2.5
-10	782.000011	0.014	2.5
0	782.000015	0.019	2.5
10	782.000011	0.014	2.5
20	781.999989	-0.014	2.5
30	781.999989	-0.014	2.5
40	781.999989	-0.014	2.5
50	781.999989	-0.014	2.5
60	781.999988	-0.016	2.5
70	781.999989	-0.014	2.5

4.3 Occupied Bandwidth Measurement

4.3.1 Limits of Occupied Bandwidth Measurement

The width of a frequency band such that, below the lower and above the upper frequency limits, the mean powers emitted are each equal to a specified percentage 0.5 % of the total mean power of a given emission.

4.3.2 Test Procedure

- a. The conducted occupied bandwidth used the power splitter via EUT RF power connector between simulation base station and spectrum analyzer.
- b. Use OBW measurement function of Spectrum analyzer to measure 99 % occupied bandwidth.

4.3.3 Test Setup

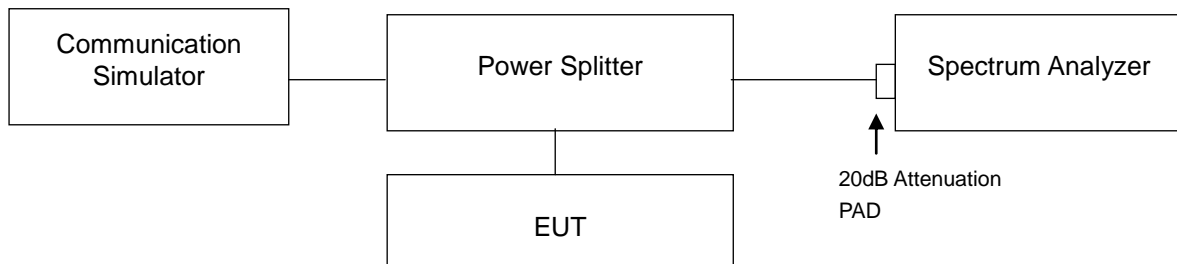

4.3.4 Test Result

LTE Band 13					
Channel Bandwidth: 5 MHz			Channel Bandwidth: 10 MHz		
Channel	Frequency (MHz)	99 % Occupied Bandwidth (MHz)	Channel	Frequency (MHz)	99 % Occupied Bandwidth (MHz)
		QPSK			QPSK
23205	779.5	1.0697	23230	782.0	1.0871
23230	782.0	1.0658			
23255	784.5	1.1005			

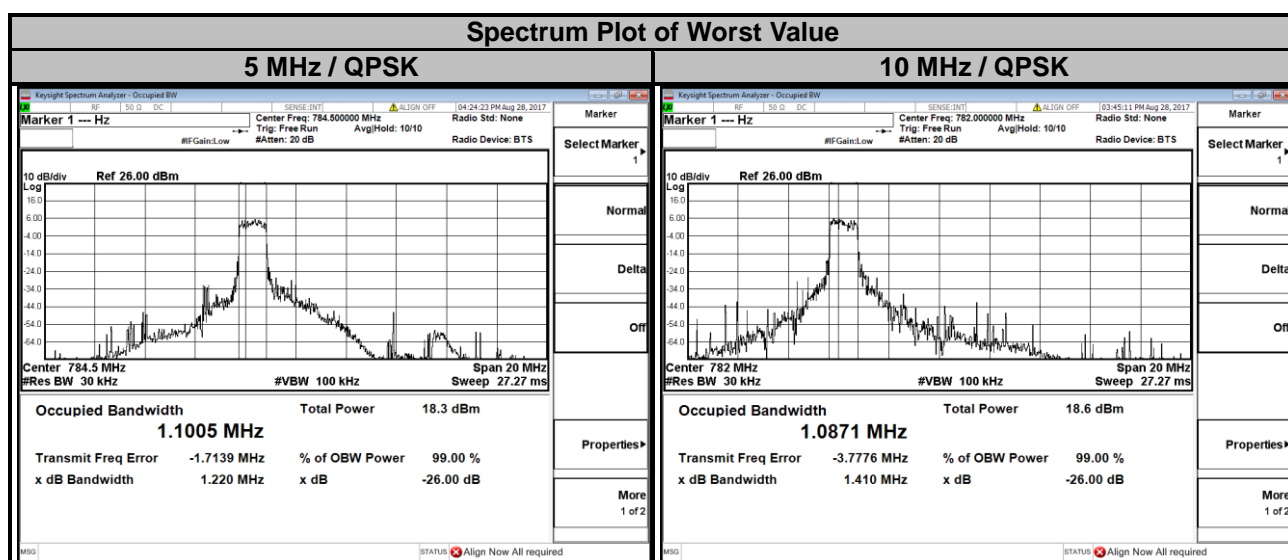

4.4 Band Edge Measurement

4.4.1 Limits of Band Edge Measurement

For operations in the 776-787 MHz band, the power of any emission outside a licensee's frequency band(s) of operation shall be attenuated below the transmitter power (P) within the licensed band(s) of operation, measured in watts, by at least $43 + 10 \log(P)$ dB. Compliance with this provision is based on the use of measurement instrumentation employing a resolution bandwidth of 100 kilohertz or greater.

However, in the 100 kilohertz bands immediately outside and adjacent to a licensee's frequency block, a resolution bandwidth of at least 30 kHz may be employed.

For operations in the 1710–1755 MHz bands, the power of any emission outside a licensee's frequency block shall be attenuated below the transmitter power (P) by at least $43 + 10 \log_{10}(P)$ dB.

4.4.2 Test Setup

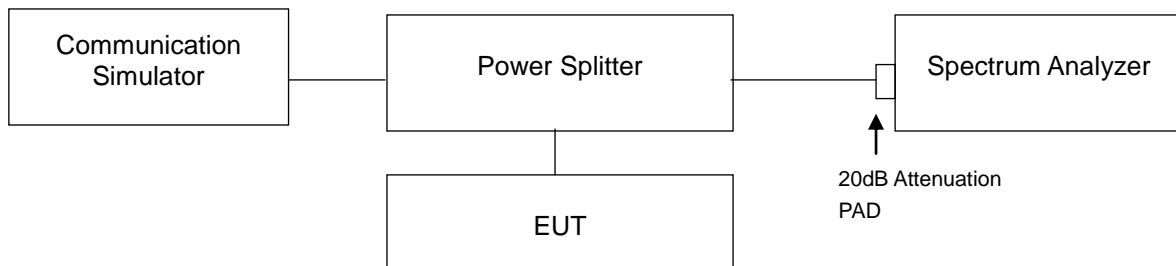

4.4.3 Test Procedures

- All measurements were done at low and high operational frequency range.
- The center frequency of spectrum is the band edge frequency and span is 1 MHz. RB of the spectrum is 100 kHz and VB of the spectrum is 300 kHz (LTE Bandwidth 5 MHz/10 MHz).
- Record the max trace plot into the test report.

4.4.4 Test Results

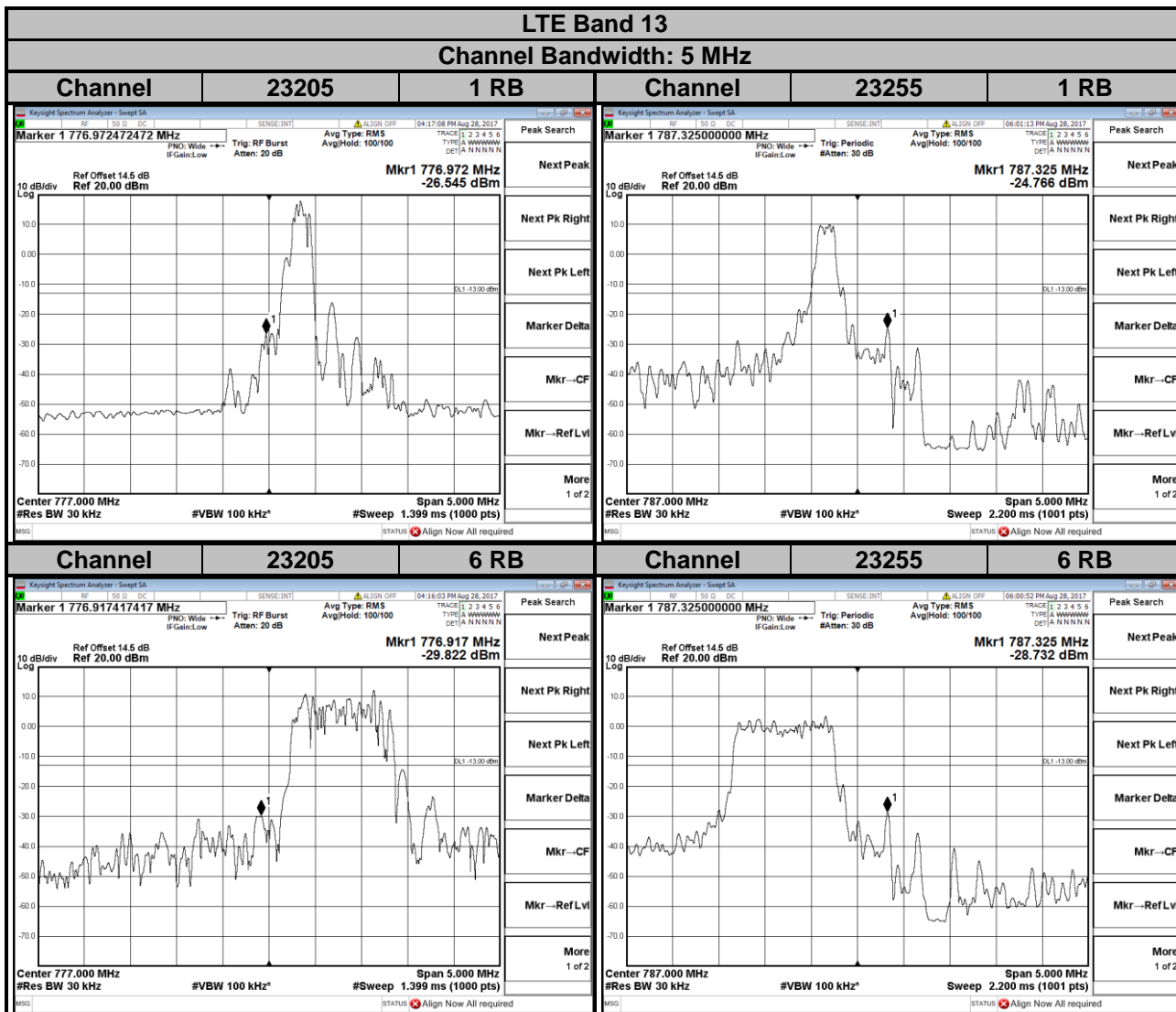

LTE Band 13
Channel Bandwidth: 10 MHz

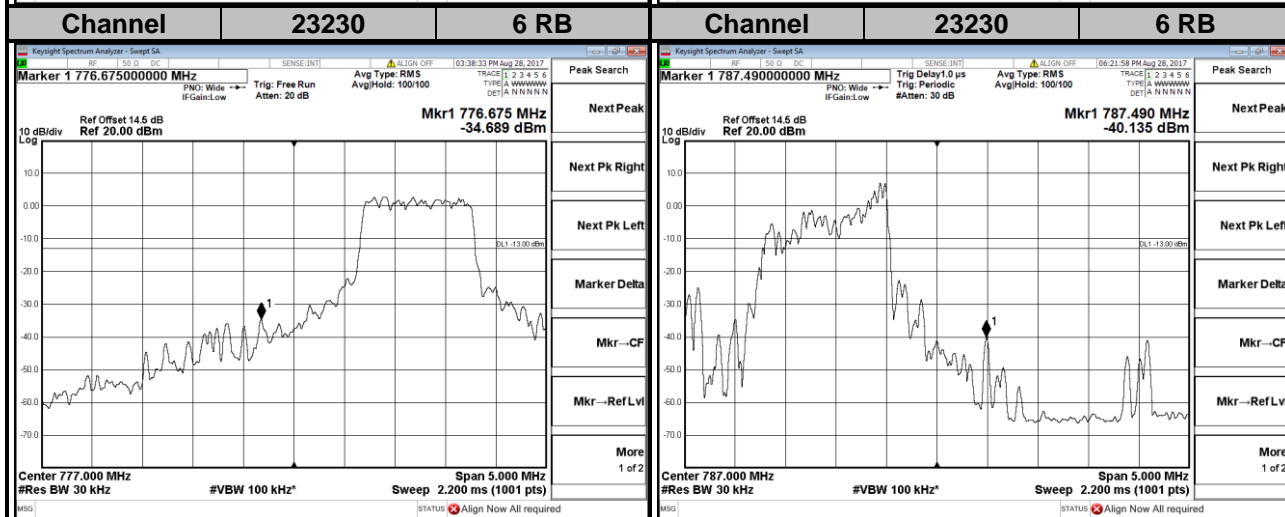
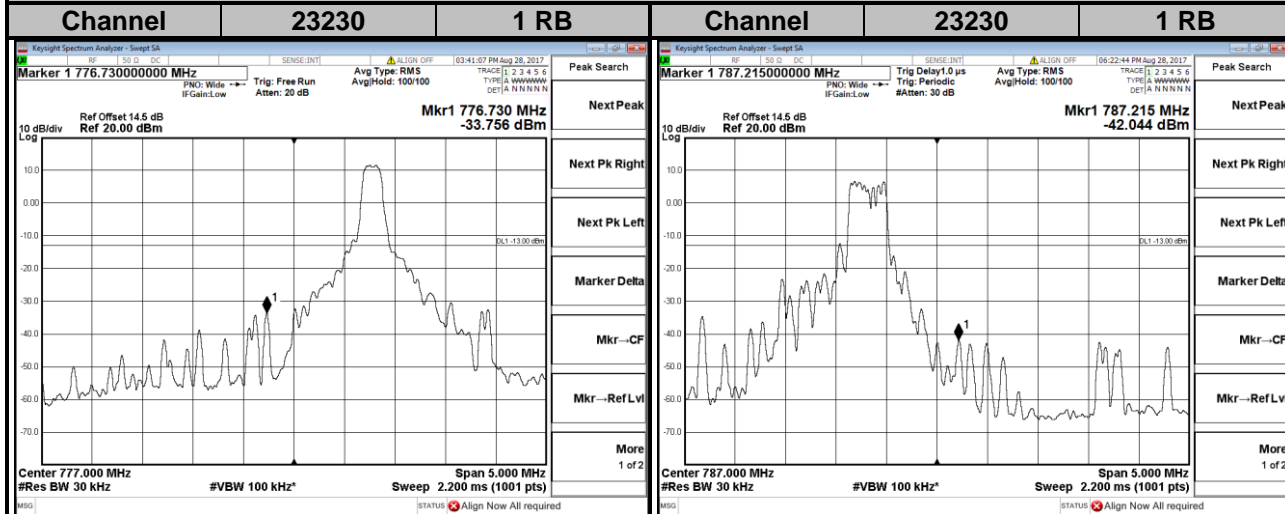

Emission Mask

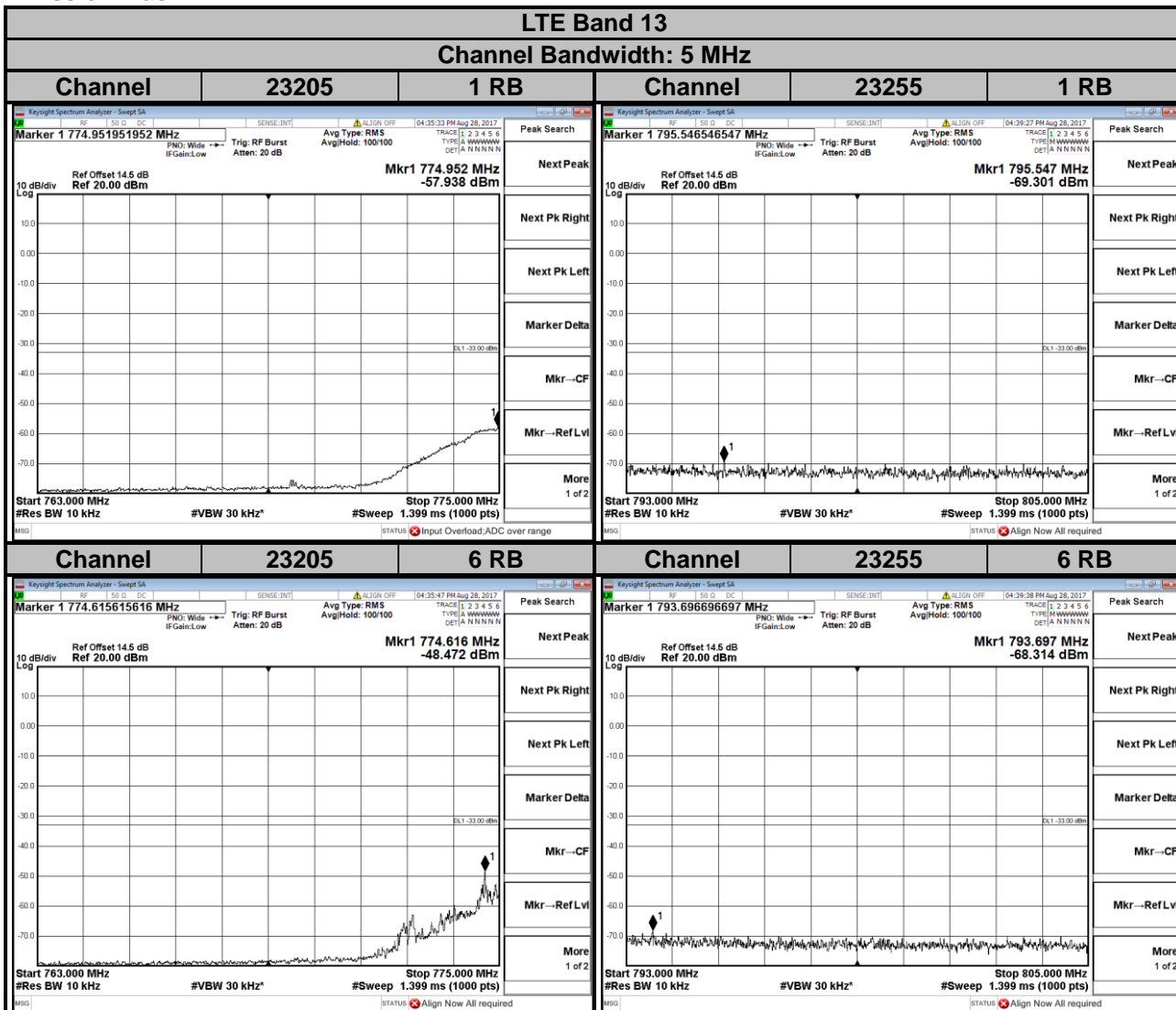

For the 763 - 775 MHz and 793 - 805 MHz band ,the FCC limit is $65+10\log(P[\text{watt}])$ in a 6.25 kHz bandwidth . Since it was not possible to set the resolution bandwidth to 6.25 kHz with the available equipment , a bandwidth of 10 kHz was used instead to show compliance. By using a 10 kHz bandwidth on the spectrum analyzer.

$$10\log(10\text{kHz}/6.25\text{kHz}) = 2.04 \text{ dB}$$

$$\text{Limit line} = -35 \text{ dBm} + 2.04 \text{ dB} = -32.96 \text{ dBm}$$

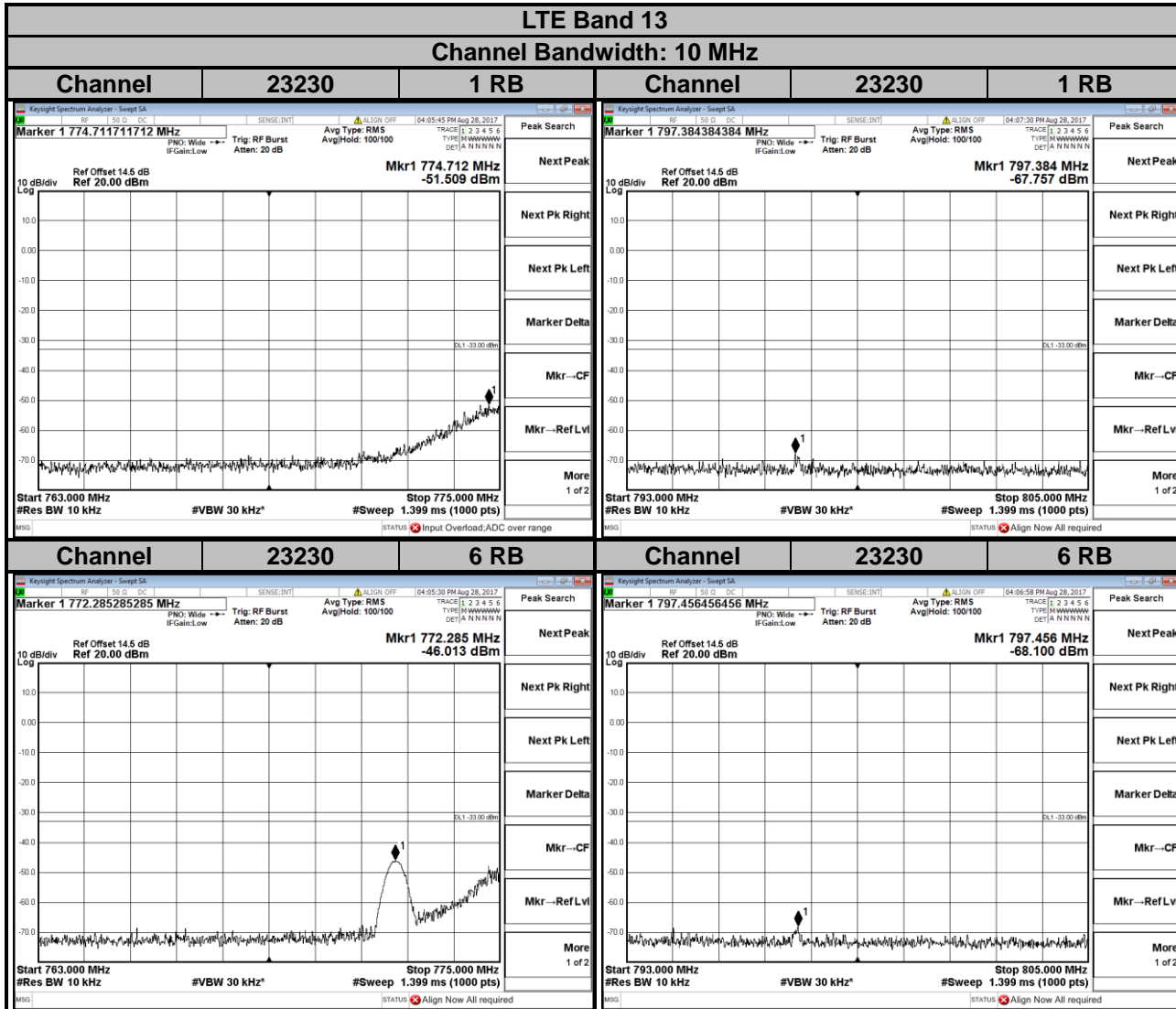

For the 763 - 775 MHz and 793 - 805 MHz band ,the FCC limit is $65+10\log(P[\text{watt}])$ in a 6.25 kHz bandwidth . Since it was not possible to set the resolution bandwidth to 6.25 kHz with the available equipment , a bandwidth of 10 kHz was used instead to show compliance. By using a 10 kHz bandwidth on the spectrum analyzer.

$$10\log(10\text{kHz}/6.25\text{kHz}) = 2.04 \text{ dB}$$

$$\text{Limit line} = -35 \text{ dBm} + 2.04 \text{ dB} = -32.96 \text{ dBm}$$

4.5 Peak to Average Ratio

4.5.1 Limits of Peak to Average Ratio Measurement

In measuring transmissions in this band using an average power technique, the peak to-average ratio (PAR) of the transmission may not exceed 13 dB.

4.5.2 Test Setup

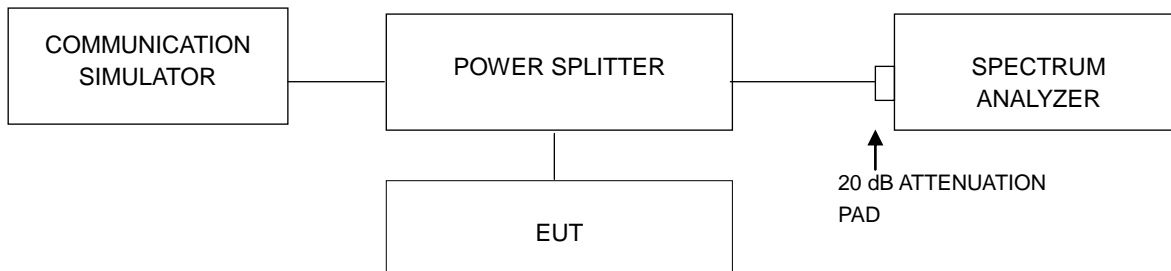

4.5.3 Test Procedures

1. Set resolution/measurement bandwidth \geq signal's occupied bandwidth;
2. Set the number of counts to a value that stabilizes the measured CCDF curve;
3. Record the maximum PAPR level associated with a probability of 0.1 %.

4.5.4 Test Results

LTE Band 13					
Channel Bandwidth: 5 MHz			Channel Bandwidth: 10 MHz		
Channel	Frequency (MHz)	Peak to Average Ratio (dB)	Channel	Frequency (MHz)	Peak to Average Ratio (dB)
		QPSK			QPSK
23205	779.5	4.25	23230	782.0	4.73
23230	782.0	4.17			
23255	784.5	4.19			

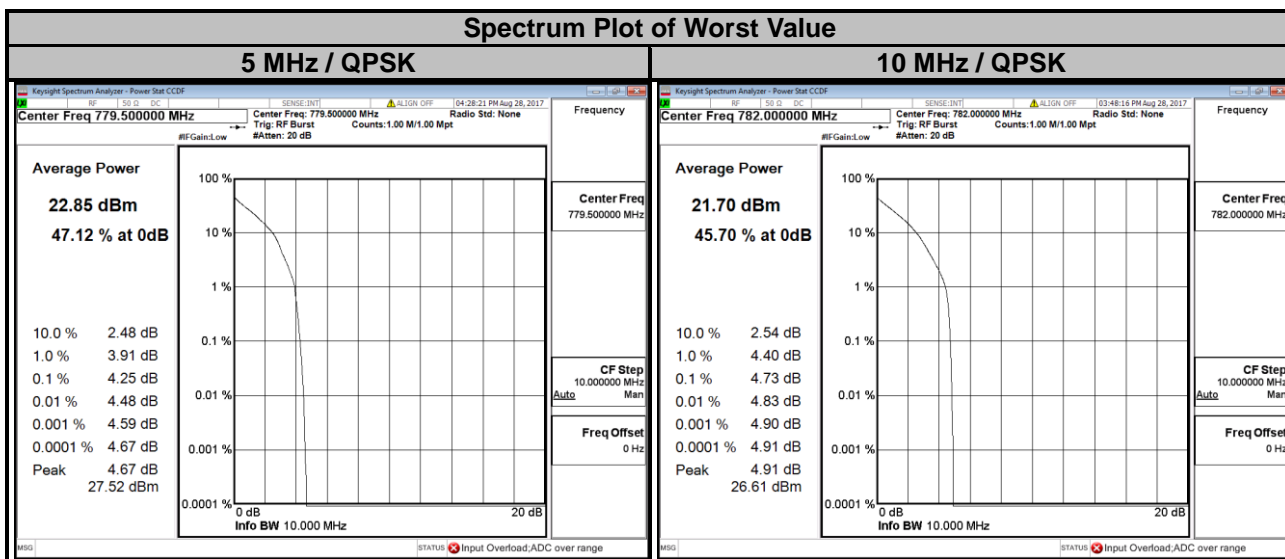

4.6 Conducted Spurious Emissions

4.6.1 Limits of Conducted Spurious Emissions Measurement

The power of any emission outside a licensee's frequency block shall be attenuated below the transmitter power (P) by at least $43 + 10 \log_{10}(P)$ dB. The limit of emission is equal to -13 dBm.

4.6.2 Test Setup

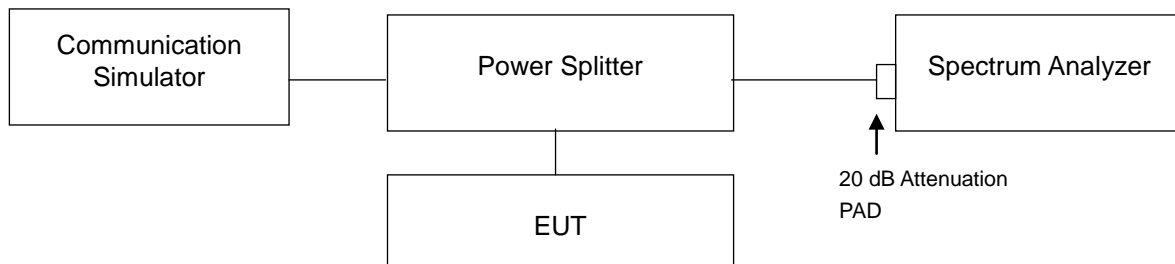

4.6.3 Test Procedure

- The EUT makes a phone call to the communication simulator. All measurements were done at low, middle and high operational frequency range.
- Measuring frequency range is from 30 MHz to 8 GHz. 10 dB attenuation pad is connected with spectrum. RBW=1 MHz and VBW=3 MHz are used for conducted emission measurement.

4.6.4 Test Results

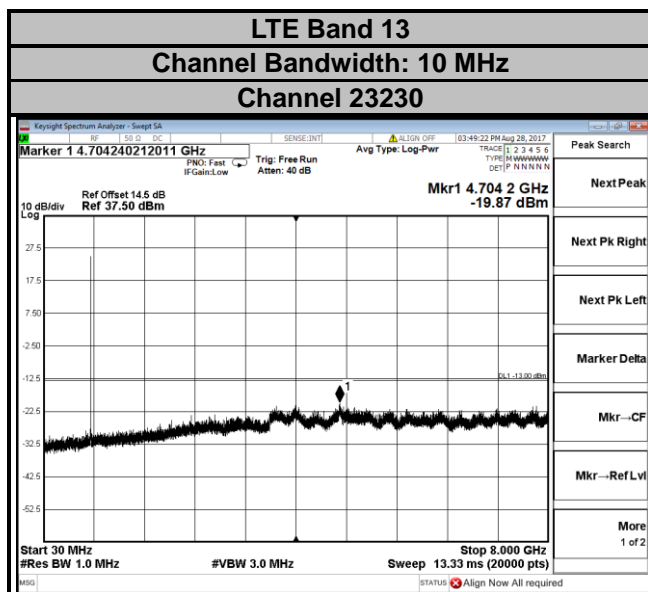
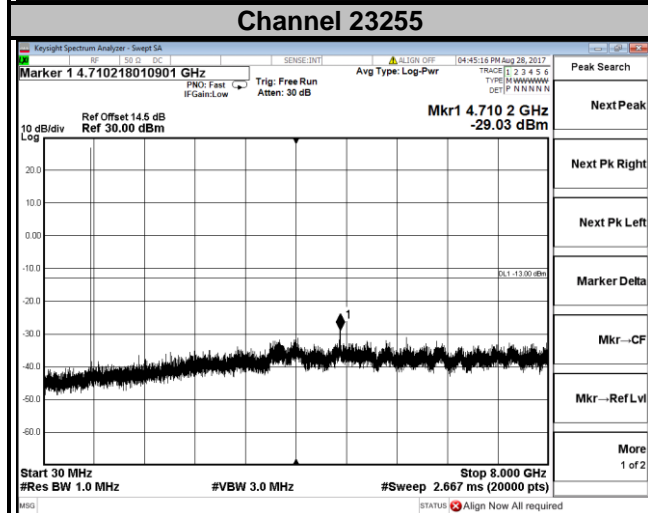
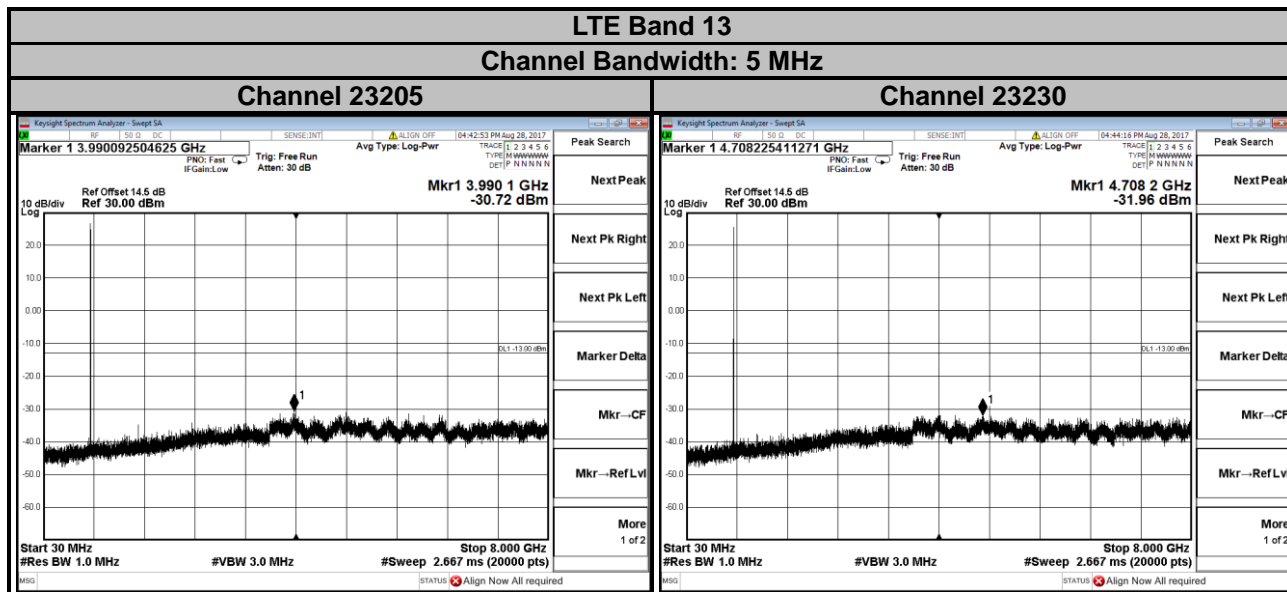

4.7 Radiated Emission Measurement

4.7.1 Limits of Radiated Emission Measurement

- a. The power of any emission outside a licensee's frequency block shall be attenuated below the transmitter power (P) by at least $43 + 10 \log_{10}(P)$ dB. The limit of emission is equal to -13 dBm.
- b. For operations in the 775-788 MHz, emissions in the band 1559-1610 MHz shall be limited to -70 dBW/MHz. The limit of emissions is equal to -40 dBm.

4.7.2 Test Procedure

- a. Substitution method is used for E.I.R.P measurement. In the semi-anechoic chamber, EUT placed on the 0.8 m height of Turn Table, rotated the table around 360 degrees to search the maximum radiation power and receiver antenna shall be rotated vertical and horizontal polarization and moved height from 1 m to 4 m to find the maximum polar radiated power. The "Read Value" is the spectrum reading the maximum power value.
- b. The substitution horn antenna is substituted for EUT at the same position and signals generator export the CW signal to the substitution antenna via a TX cable. Rotated the Turn Table and moved receiving antenna to find the maximum radiation power. Adjust output power level of S.G to get a Value of spectrum reading equal to "Read Value" of step a. Record the power level of S.G.
- c. $EIRP = \text{Output power level of S.G} - \text{TX cable loss} + \text{Antenna gain of substitution horn}$.
- d. E.R.P power can be calculated form E.I.R.P power by subtracting the gain of dipole, $E.R.P \text{ power} = E.I.P.R \text{ power} - 2.15 \text{ dBi}$.

Note: The resolution bandwidth of spectrum analyzer is 1 MHz and the video bandwidth is 3 MHz.

4.7.3 Deviation from Test Standard

No deviation.

4.7.4 Test Setup

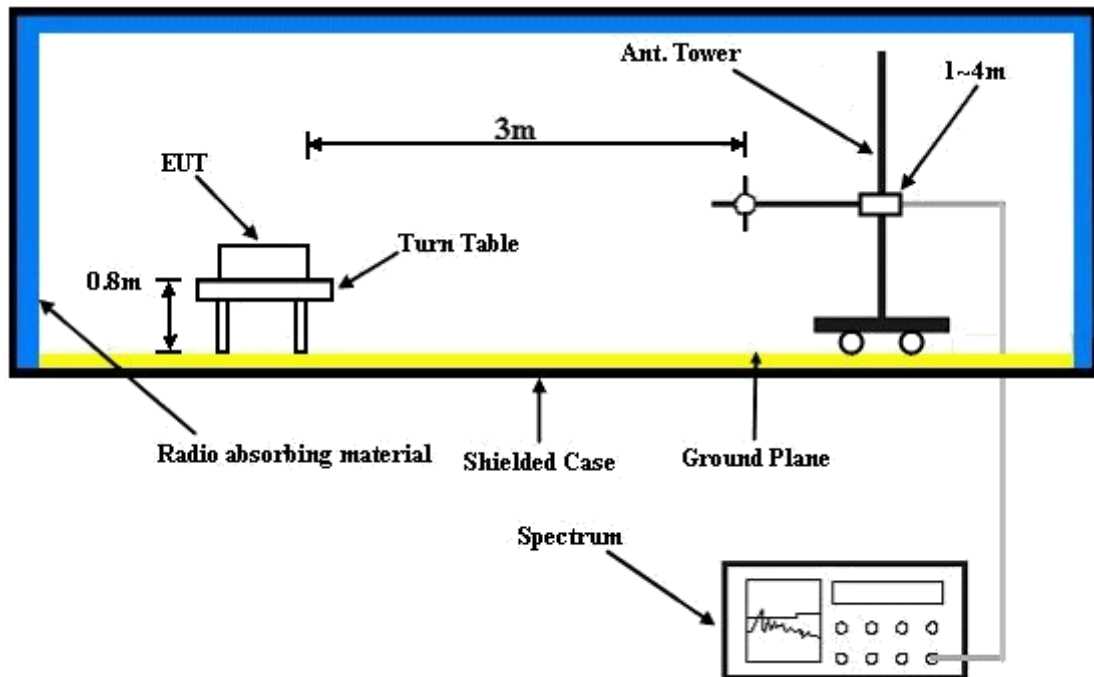

For the actual test configuration, please refer to the attached file (Test Setup Photo).

4.7.5 Test Results

LTE Band 13
 Channel Bandwidth: 10 MHz / QPSK
 Middle Channel
 Mode A



Bureau Veritas Consumer Products Services Ltd., Taoyuan Branch

A D T

Data: 5

Date: 2017-09-28

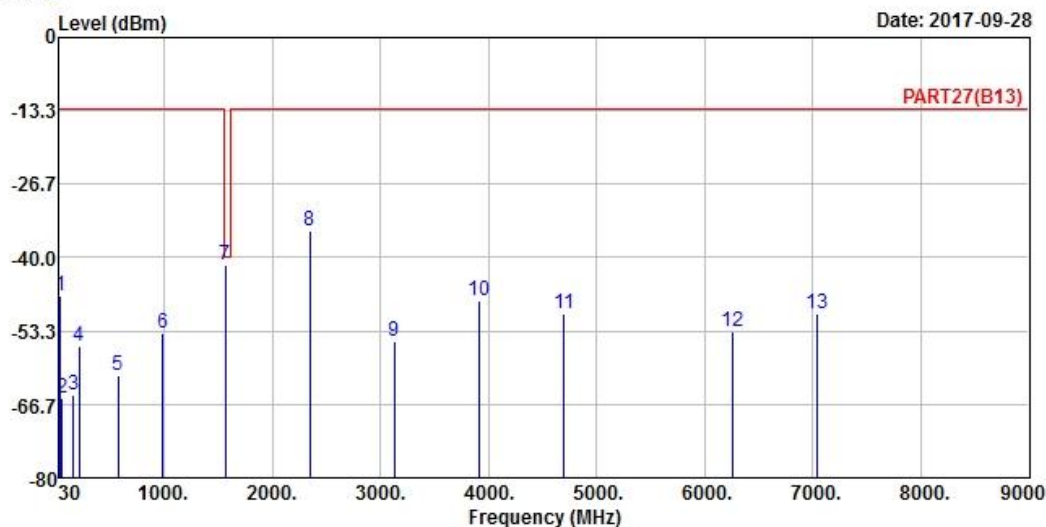

Site : 966 Chamber 5
 Condition: PART27(B13) HORIZONTAL
 Remark : LTE Band 13_QPSK_10M
 Tested by: Getaz Yang

	Freq	Level	Read Level	Limit Line	Over Limit	Factor	Remark
	MHz	dBm	dBm	dBm	dB	dB	
1	41.64	-46.83	-46.42	-13.00	-33.83	-0.41	Peak
2	54.25	-65.49	-59.42	-13.00	-52.49	-6.07	Peak
3	158.04	-64.81	-59.42	-13.00	-51.81	-5.39	Peak
4	210.42	-56.08	-48.49	-13.00	-43.08	-7.59	Peak
5	577.08	-61.47	-59.75	-13.00	-48.47	-1.72	Peak
6	988.36	-53.61	-56.78	-13.00	-40.61	3.17	Peak
7 pp	1568.00	-41.20	-26.24	-40.00	-1.20	-14.96	Peak
8	2344.00	-35.22	-24.78	-13.00	-22.22	-10.44	Peak
9	3128.00	-55.33	-46.30	-13.00	-42.33	-9.03	Peak
10	3912.00	-47.95	-40.74	-13.00	-34.95	-7.21	Peak
11	4696.00	-50.19	-47.03	-13.00	-37.19	-3.16	Peak
12	6256.00	-53.56	-54.47	-13.00	-40.56	0.91	Peak
13	7040.00	-50.32	-55.14	-13.00	-37.32	4.82	Peak



Bureau Veritas Consumer Products Services Ltd., Taoyuan Branch

A D T

Data: 6

Date: 2017-09-28

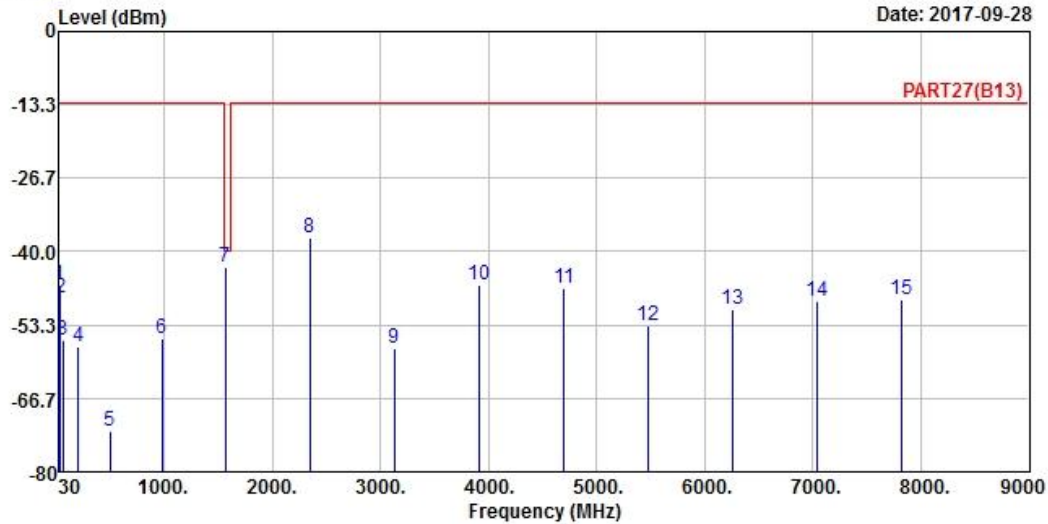

Site : 966 Chamber 5
 Condition: PART27(B13) VERTICAL
 Remark : LTE Band 13_QPSK_10M
 Tested by: Getaz Yang

	Freq	Level	Read Level	Limit Line	Over Limit	Factor	Remark
	MHz	dBm	dBm	dBm	dB	dB	
1	30.00	-45.96	-46.34	-13.00	-32.96	0.38	Peak
2	42.61	-48.33	-47.39	-13.00	-35.33	-0.94	Peak
3	61.04	-56.16	-48.42	-13.00	-43.16	-7.74	Peak
4	203.63	-57.40	-49.54	-13.00	-44.40	-7.86	Peak
5	501.42	-72.58	-68.00	-13.00	-59.58	-4.58	Peak
6	980.60	-55.72	-58.61	-13.00	-42.72	2.89	Peak
7 pp	1568.00	-42.84	-27.88	-40.00	-2.84	-14.96	Peak
8	2344.00	-37.58	-27.14	-13.00	-24.58	-10.44	Peak
9	3128.00	-57.55	-48.52	-13.00	-44.55	-9.03	Peak
10	3912.00	-45.92	-38.71	-13.00	-32.92	-7.21	Peak
11	4696.00	-46.64	-43.48	-13.00	-33.64	-3.16	Peak
12	5480.00	-53.37	-52.03	-13.00	-40.37	-1.34	Peak
13	6256.00	-50.42	-51.33	-13.00	-37.42	0.91	Peak
14	7040.00	-48.88	-53.70	-13.00	-35.88	4.82	Peak
15	7824.00	-48.83	-53.97	-13.00	-35.83	5.14	Peak

Frequency (MHz)	ERP(dBm)	Limit(dBm)	Over Limit (dB)	SPA. Reading (dBm)	S.G. Power (dBm)	TX Cable loss (dB)	TX Antenna Gain (dBi)	Polarization (H/V)	Result
1564	-41.20	-40	-1.20	-26.24	-44.19	3.31	8.45	H	Pass
2346	-35.22	-13	-22.22	-24.78	-38.73	3.83	9.49	H	Pass
3128	-55.33	-13	-42.33	-46.3	-58.34	4.41	9.57	H	Pass
3910	-47.95	-13	-34.95	-40.74	-50.53	5.07	9.80	H	Pass
4692	-50.19	-13	-37.19	-47.03	-53.55	5.45	10.96	H	Pass
6256	-53.56	-13	-40.56	-54.47	-56.86	6.3	11.75	H	Pass
7038	-50.32	-13	-37.32	-55.14	-53.20	6.74	11.77	H	Pass
1564	-42.84	-40	-2.84	-27.88	-45.83	3.31	8.45	V	Pass
2346	-37.58	-13	-24.58	-27.14	-41.09	3.83	9.49	V	Pass
3128	-57.55	-13	-44.55	-48.52	-60.56	4.41	9.57	V	Pass
3910	-45.95	-13	-32.95	-38.71	-48.53	5.07	9.80	V	Pass
4692	-46.64	-13	-33.64	-43.48	-50.00	5.45	10.96	V	Pass
5474	-53.37	-13	-40.37	-52.03	-56.40	5.81	10.99	V	Pass
6256	-50.42	-13	-37.42	-51.33	-53.72	6.3	11.75	V	Pass
7038	-48.88	-13	-35.88	-53.70	-51.76	6.74	11.77	V	Pass
7820	-48.83	-13	-35.83	-53.97	-51.03	7.11	11.46	V	Pass

Mode B



Bureau Veritas Consumer Products Services Ltd., Taoyuan Branch

A D T

Data: 5

Date: 2017-09-28

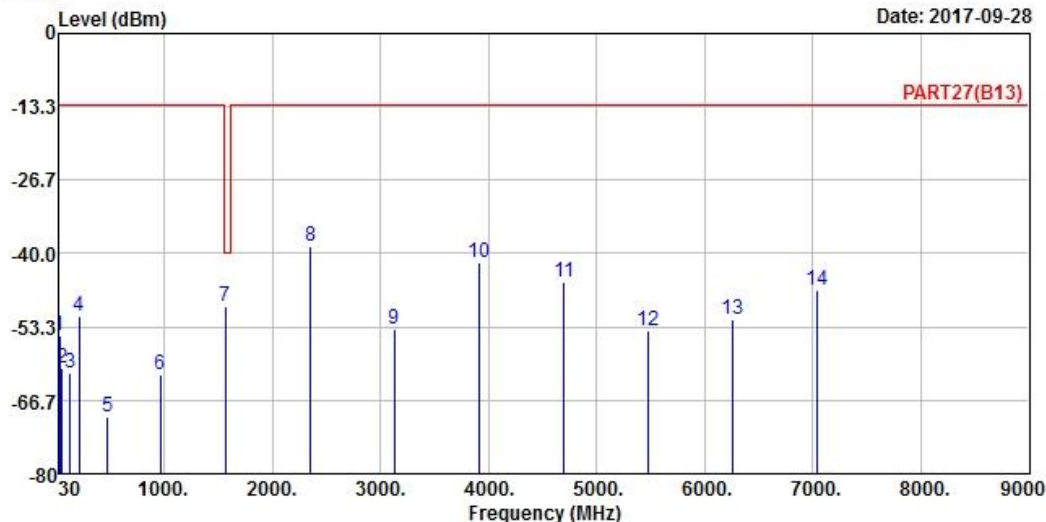

Site : 966 Chamber 5
 Condition: PART27(B13) HORIZONTAL
 Remark : LTE Band 13_QPSK_10M
 Tested by: Getaz Yang

	Freq	Level	Read Level	Limit Line	Over Limit	Factor	Remark
	MHz	dBm	dBm	dBm	dB	dB	
1	30.97	-54.92	-54.81	-13.00	-41.92	-0.11	Peak
2	54.25	-60.82	-54.75	-13.00	-47.82	-6.07	Peak
3	131.85	-61.76	-53.08	-13.00	-48.76	-8.68	Peak
4	211.39	-51.29	-43.74	-13.00	-38.29	-7.55	Peak
5	473.29	-69.68	-64.56	-13.00	-56.68	-5.12	Peak
6	965.08	-62.10	-64.45	-13.00	-49.10	2.35	Peak
7 pp	1568.00	-49.62	-34.66	-40.00	-9.62	-14.96	Peak
8	2352.00	-38.59	-28.15	-13.00	-25.59	-10.44	Peak
9	3128.00	-53.77	-44.74	-13.00	-40.77	-9.03	Peak
10	3912.00	-41.56	-34.35	-13.00	-28.56	-7.21	Peak
11	4696.00	-45.20	-42.04	-13.00	-32.20	-3.16	Peak
12	5480.00	-54.14	-52.80	-13.00	-41.14	-1.34	Peak
13	6256.00	-52.07	-52.98	-13.00	-39.07	0.91	Peak
14	7040.00	-46.66	-51.48	-13.00	-33.66	4.82	Peak



Bureau Veritas Consumer Products Services Ltd., Taoyuan Branch

A D T

Data: 6

Date: 2017-09-28

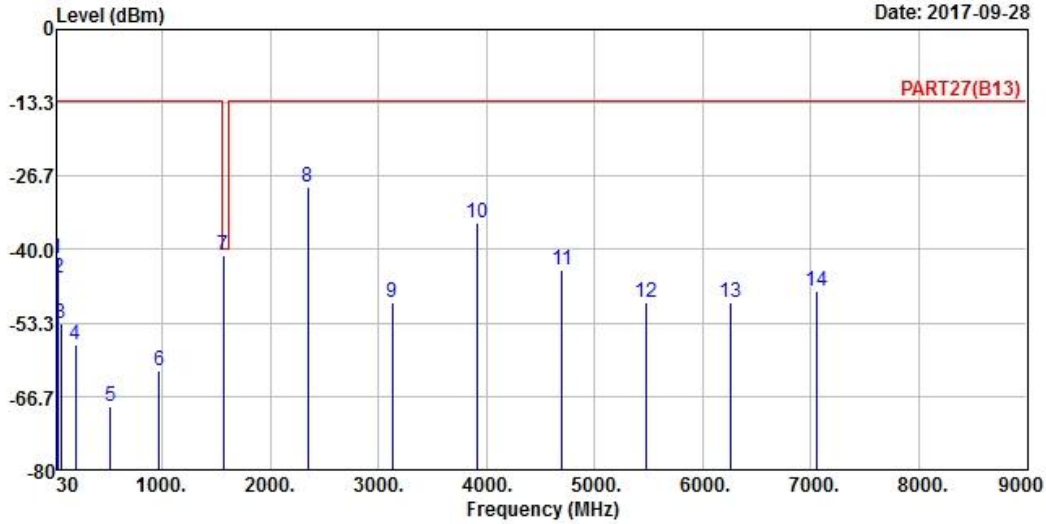

Site : 966 Chamber 5
 Condition: PART27(B13) VERTICAL
 Remark : LTE Band 13_QPSK_10M
 Tested by: Getaz Yang

	Freq	Level	Read Level	Limit Line	Over Limit	Factor	Remark
	MHz	dBm	dBm	dBm	dB	dB	
1	30.97	-41.49	-41.38	-13.00	-28.49	-0.11	Peak
2	38.73	-45.03	-45.13	-13.00	-32.03	0.10	Peak
3	64.92	-53.55	-45.52	-13.00	-40.55	-8.03	Peak
4	198.78	-57.39	-49.46	-13.00	-44.39	-7.93	Peak
5	523.73	-68.38	-64.60	-13.00	-55.38	-3.78	Peak
6	971.87	-61.95	-64.54	-13.00	-48.95	2.59	Peak
7 pp	1568.00	-41.03	-26.07	-40.00	-1.03	-14.96	Peak
8	2344.00	-28.78	-18.34	-13.00	-15.78	-10.44	Peak
9	3128.00	-49.53	-40.50	-13.00	-36.53	-9.03	Peak
10	3912.00	-35.06	-27.85	-13.00	-22.06	-7.21	Peak
11	4696.00	-43.81	-40.65	-13.00	-30.81	-3.16	Peak
12	5472.00	-49.54	-48.11	-13.00	-36.54	-1.43	Peak
13	6256.00	-49.74	-50.65	-13.00	-36.74	0.91	Peak
14	7048.00	-47.43	-52.25	-13.00	-34.43	4.82	Peak

Frequency (MHz)	ERP(dBm)	Limit(dBm)	Over Limit (dB)	SPA. Reading (dBm)	S.G. Power (dBm)	TX Cable loss (dB)	TX Antenna Gain (dBi)	Polarization (H/V)	Result
1564	-49.62	-40	-9.62	-34.66	-52.61	3.31	8.45	H	Pass
2346	-38.59	-13	-25.59	-28.15	-42.10	3.83	9.49	H	Pass
3128	-53.77	-13	-40.77	-44.74	-56.78	4.41	9.57	H	Pass
3910	-41.56	-13	-28.56	-34.35	-44.14	5.07	9.80	H	Pass
4692	-45.20	-13	-32.20	-42.04	-48.56	5.45	10.96	H	Pass
5474	-54.14	-13	-41.14	-52.80	-57.17	5.81	10.99	H	Pass
6256	-52.07	-13	-39.07	-52.98	-55.37	6.3	11.75	H	Pass
7038	-46.66	-13	-33.66	-51.48	-49.54	6.74	11.77	H	Pass
1564	-41.03	-40	-1.03	-26.07	-44.02	3.31	8.45	V	Pass
2346	-28.78	-13	-15.78	-18.34	-32.29	3.83	9.49	V	Pass
3128	-49.53	-13	-36.53	-40.5	-52.54	4.41	9.57	V	Pass
3910	-35.06	-13	-22.06	-27.85	-37.64	5.07	9.80	V	Pass
4692	-43.81	-13	-30.81	-40.65	-47.17	5.45	10.96	V	Pass
5474	-49.54	-13	-36.54	-48.11	-52.57	5.81	10.99	V	Pass
6256	-49.74	-13	-36.74	-50.65	-53.04	6.3	11.75	V	Pass
7038	-49.74	-13	-36.74	-52.25	-52.62	6.74	11.77	V	Pass

5 Pictures of Test Arrangements

Please refer to the attached file (Test Setup Photo).

Appendix – Information on the Testing Laboratories

We, Bureau Veritas Consumer Products Services (H.K.) Ltd., Taoyuan Branch, were founded in 1988 to provide our best service in EMC, Radio, Telecom and Safety consultation. Our laboratories are FCC recognized accredited test firms and accredited according to ISO/IEC 17025.

If you have any comments, please feel free to contact us at the following:

Linko EMC/RF Lab

Tel: 886-2-26052180

Fax: 886-2-26051924

Hsin Chu EMC/RF/Telecom Lab

Tel: 886-3-6668565

Fax: 886-3-6668323

Hwa Ya EMC/RF/Safety

Tel: 886-3-3183232

Fax: 886-3-3270892

Email: service.adt@tw.bureauveritas.com

Web Site: www.bureauveritas-adt.com

The address and road map of all our labs can be found in our web site also.

--- END ---