



849 NW STATE ROAD 45
NEWBERRY, FL 32669 USA
PH: 888.472.2424 OR 352.472.5500
FAX: 352.472.2030
EMAIL: TEI@TIMCOENGR.COM
[HTTP://WWW.TIMCOENGR.COM](http://WWW.TIMCOENGR.COM)

FCC TEST REPORT

Applicant	Harris Corp.
Address	1025 West NASA Boulevard Melbourne FL 32919-0001 USA
FCC ID	NK7-3166210
Model Number	NK7-3166210
Product Description	NK7-3166210 WITH PLATFORM 4M80F9W
Date Sample Received	8/20/2010
Date Tested	10/6/2010
Tested By	Nam Nguyen
Approved By	Mario de Aranzeta
Timco Report No.	2307AT10TestReport.doc
Test Results	<input checked="" type="checkbox"/> PASS <input type="checkbox"/> FAIL

THE ATTACHED REPORT SHALL NOT BE REPRODUCED EXCEPT IN FULL WITHOUT
THE WRITTEN APPROVAL OF TIMCO ENGINEERING, INC.



Test Certificate #0955-01



TABLE OF CONTENTS

STATEMENT OF COMPLIANCE 3
GENERAL INFORMATION 4
EQUIPMENT LIST 5
TEST PROCEDURE 6
RF POWER OUTPUT 7
VOICE MODULATION CHARACTERISTICS 8
AUDIO LOW PASS FILTER 8
OCCUPIED BANDWIDTH AND BAND-EDGES COMPLIANCE 9
 4M80F9W V (850): 10
 4M80F9W II(1900): 12
 4M80F9W IV (2100): 14
SPURIOUS EMISSIONS AT ANTENNA TERMINALS 16
 4M80F9W V (850): 16
 4M80F9W II(1900): 16
 4M80F9W IV (2100): 17
FIELD STRENGTH OF SPURIOUS EMISSIONS 18
 4M80F9W V (850): 18
 4M80F9W II(1900): 19
 4M80F9W IV (2100): 19
FREQUENCY STABILITY 20
 4M80F9W V (850): 20
 4M80F9W II(1900): 21
 4M80F9W IV (2100): 21

APPLICANT: Harris Corp.
FCC ID: NK7-3166210
Report #: H\Harris\2307AT10\2307AT10TestReport.doc

STATEMENT OF COMPLIANCE

This equipment has been tested in accordance with the standards identified in the referenced test report. To the best of my knowledge and belief, these tests were performed using the measurement procedures described in this report and demonstrate that the equipment complies with the appropriate standards.

I attest that the necessary measurements were made by me or under my supervision, at Timco Engineering, Inc. located at 849 N.W. State Road 45, Newberry, Florida 32669 USA.

Authorized by: Mario de Aranzeta



Signature:

Function: Engineer/ Laboratory Supervisor

Date: December 10th, 2010

Tested by: Nam Nguyen



GENERAL INFORMATION

DUT Specification

The test results relate only to the items tested.			
FCC Rule Part(s)	§ 22H, § 27L, and § 24		
DUT Description	NK7-3166210 PLATFORM WITH 4M80F9W		
FCC ID	NK7-3166210		
Model Name	NK7-3166210		
Tx Frequency	(871.4 – 891.6) (1932.4 – 1987.6) (2112.4 – 2152.6) MHz		
Max. Power Rating	0.25 Watts		
Emission Designators	4M80F9W (II, IV, V)		
Modulation(s)	4M80F9W		
User Power Control	<input type="checkbox"/> Yes	<input checked="" type="checkbox"/> No	
DUT Power Source	<input type="checkbox"/> 110–120Vac/50– 60Hz		
	<input checked="" type="checkbox"/> DC Power		
	<input type="checkbox"/> Battery Operated Exclusively		
Test Item	<input type="checkbox"/> Prototype	<input checked="" type="checkbox"/> Pre-Production	<input type="checkbox"/> Production
Type of Equipment	<input type="checkbox"/> Fixed	<input checked="" type="checkbox"/> Mobile	<input type="checkbox"/> Portable

Test Facility: The test sites used by Timco Engineering Inc. for all the test data are located at 849 NW State Road 45 Newberry, FL 32669 USA.

Test Condition: The temperature and humidity in the laboratory are controlled and were:
The temperature was 26°C with a relative humidity of 50%.

Modification to the DUT: No modification was made to the DUT during testing.

Test Exercise (e.g. software description, test signal, etc.): The DUT was placed in continuous transmit mode of operation.

APPLICANT: Harris Corp.
 FCC ID: NK7-3166210
 Report #: H\Harris\2307AT10\2307AT10TestReport.doc



EQUIPMENT LIST

Device	Manufacturer	Model	Serial Number	Cal/Char Date	Due Date
3-Meter Semi-Anechoic Chamber	Panashield	N/A	N/A	Listed 3/10/10	3/10/12
AC Voltmeter	HP	400FL	2213A14499	CAL 3/23/09	3/23/11
Antenna: Dipole Kit	Electro-Metrics	TDA-30/1-4	153	CHAR 6/10/09	6/10/11
Frequency Counter	HP	5385A	3242A07460	CAL 5/26/09	5/26/11
Hygro-Thermometer	Extech	445703	0602	CAL 1/30/09	1/30/11
Modulation Analyzer	HP	8901A	3435A06868	CAL 5/26/09	5/26/11
Digital Multimeter	Fluke	FLUKE-77-3	79510405	CAL 5/18/09	5/18/11
Analyzer Tan Tower Preamplifier	HP	8449B-H02	3008A00372	CAL 11/21/09	11/21/11
Analyzer Tan Tower Quasi-Peak Adapter	HP	85650A	3303A01690	CAL 11/22/09	11/22/11
Analyzer Tan Tower RF Preselector	HP	85685A	3221A01400	CAL 11/21/09	11/21/11
Analyzer Tan Tower Spectrum Analyzer	HP	8566B Opt 462	3138A07786 3144A20661	CAL 11/24/09	11/24/11
Temperature Chamber	Tenney Engineering	TTRC	11717-7	CHAR 4/25/10	4/25/12

APPLICANT: Harris Corp.
 FCC ID: NK7-3166210
 Report #: H\Harris\2307AT10\2307AT10TestReport.doc



TEST PROCEDURE

Power Line Conducted Interference: The procedure used was ANSI C63.4-2003 using a 50uH LISN. Both lines were observed with the DUT transmitting. The bandwidth of the spectrum analyzer was 10 kHz with an appropriate sweep speed.

Bandwidth 20 dB: The measurements were made with the spectrum analyzer's resolution bandwidth (RBW) = 1 MHz and the video bandwidth (VBW) = 3 MHz and the span set as shown on plot.

Power Output: The RF power output was measured at the antenna feed point using a peak power meter.

Antenna Conducted Emissions: The RBW = 100 kHz, VBW = 300 kHz and the span set to 10 MHz and the spectrum was scanned from 30 MHz to the 10th Harmonic of the fundamental. Above 1 GHz the resolution bandwidth was 1 MHz, the VBW = 3 MHz, and the span 50 MHz.

Radiation Interference: The test procedure used was ANSI C63.4-2003 using an Agilent spectrum receiver with pre-selector. The bandwidth (RBW) of the spectrum receiver was 100 kHz up to 1 GHz and 1 MHz above 1 GHz with an appropriate sweep speed. The VBW above 1 GHz was 3 MHz. The analyzer was calibrated in dB above a microvolt at the output of the antenna.

APPLICANT: Harris Corp.
FCC ID: NK7-3166210
Report #: H\Harris\2307AT10\2307AT10TestReport.doc

RF POWER OUTPUT

Rules Part No.: Part 2.1046(a), Part 22.913

Requirements:

Method of Measuring: This test was conducted per ANSI/TIA 603-C:2004 using the RF power as measured by connecting a 50ohm, resistive wattmeter to the RF output connector

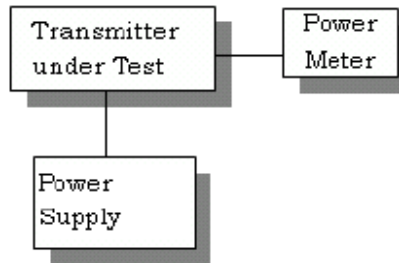

Test Data:

Channel (MHz)	Output Power (dBm)
871.40	8.45
881.50	7.47
891.60	6.69

Channel (MHz)	Output Power (dBm)
1932.40	6.58
1960.00	5.86
1987.60	4.17

Channel (MHz)	Output Power (dBm)
2112.40	6.01
2132.60	4.86
2152.60	5.11

APPLICANT: Harris Corp.
 FCC ID: NK7-3166210
 Report #: H\Harris\2307AT10\2307AT10TestReport.doc



VOICE MODULATION CHARACTERISTICS

Rules Part No.: Part 2.1047(a)

Requirements:

Method of Measurement:

Test Data: Not applicable, F9 or G9 type of emission.

AUDIO LOW PASS FILTER

Rules Part No.: Part 2.1047

Requirements:

Method of Measurement:

Test Data: This DUT does not have an audio low pass filter.

[Continued]



OCCUPIED BANDWIDTH AND BAND-EDGES COMPLIANCE

Rules Part No.: §2.1049, §22.917a, §22.917b, §24.238, and §27.53

Requirements:

Out of band emissions: The mean power of emissions must be attenuated below the mean power of the un-modulated carrier (P) on any frequency twice or more than twice the fundamental frequency by: At least $43 + 10\log(P_o) = \text{dB}$.

Please refer to the plots below.

Band-edges compliance: Measurement were performed in accordance with Part 22.917 (b)

Please refer to the plots below.

4M80F9W V (850):

Channel Frequency (MHz)	Band-edge Frequency Emission (MHz)	Amplitude at the band-edge (dBm)	Limit (dBm)
871.40	868.579	-46.14	-13
891.60	894.601	-42.56	-13

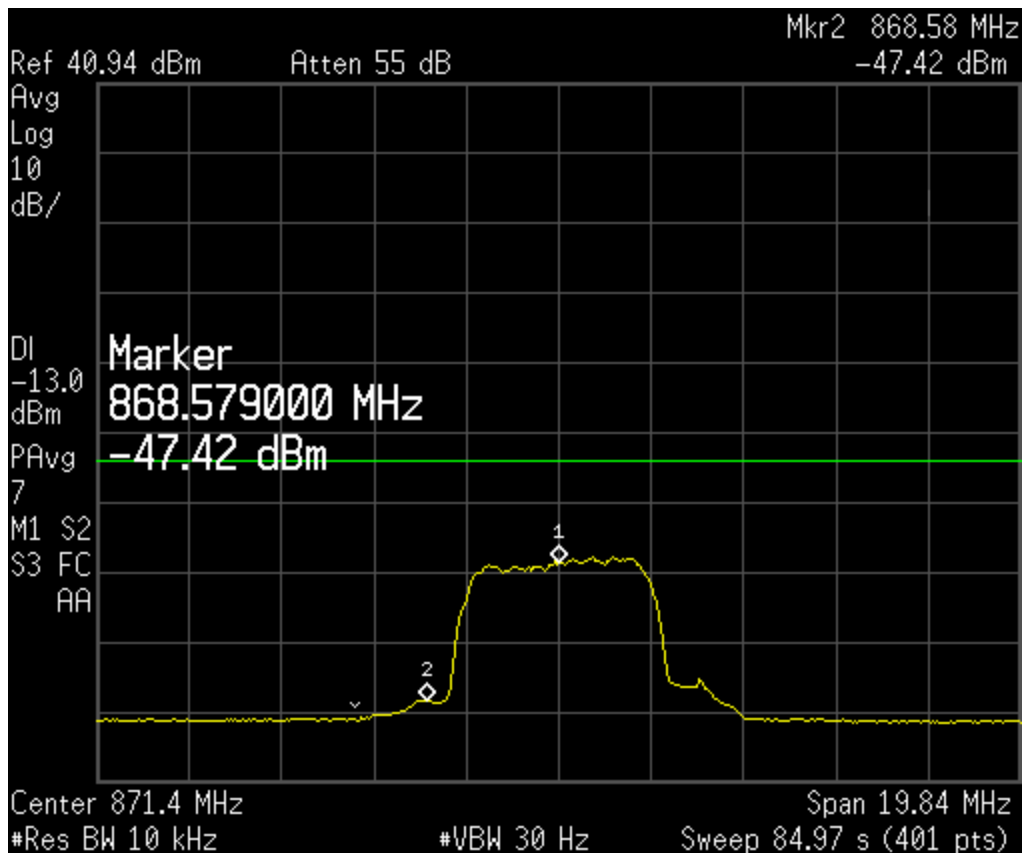

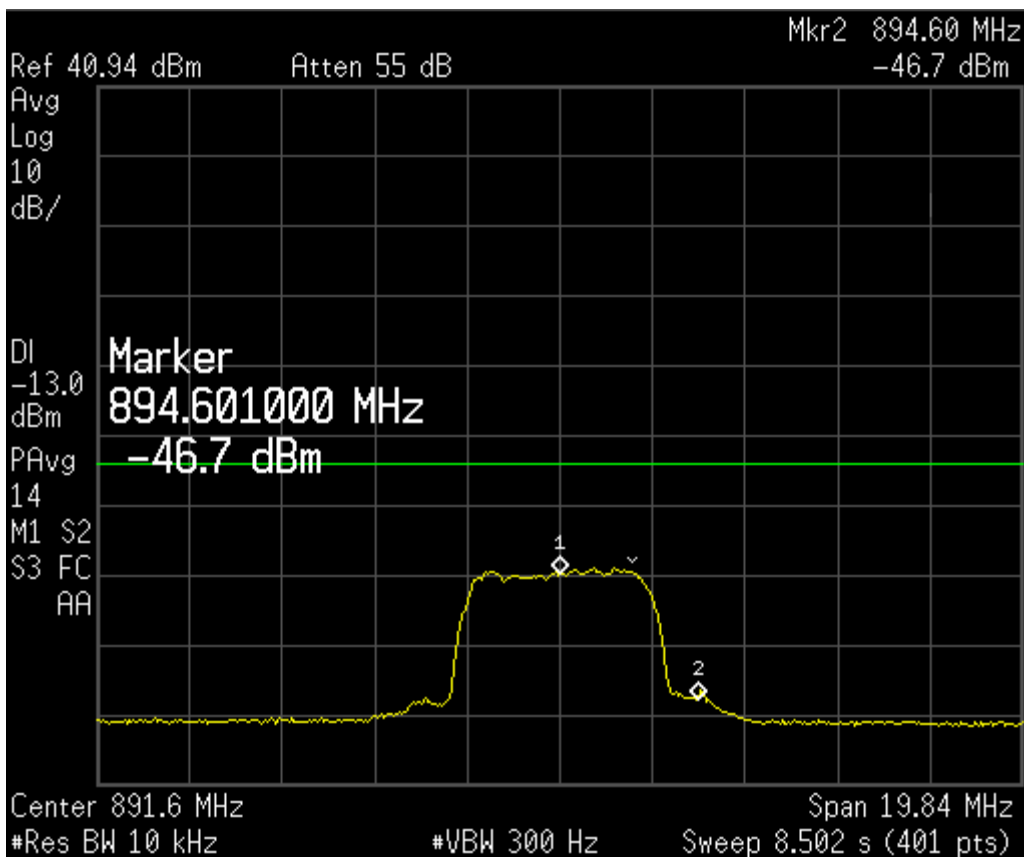

4M80F9W II (1900):

Channel Frequency (MHz)	Band-edge Frequency Emission (MHz)	Amplitude at the band-edge (dBm)	Limit (dBm)
1932.40	1929.819	-55.70	-13
1987.60	1990.661	-57.41	-13

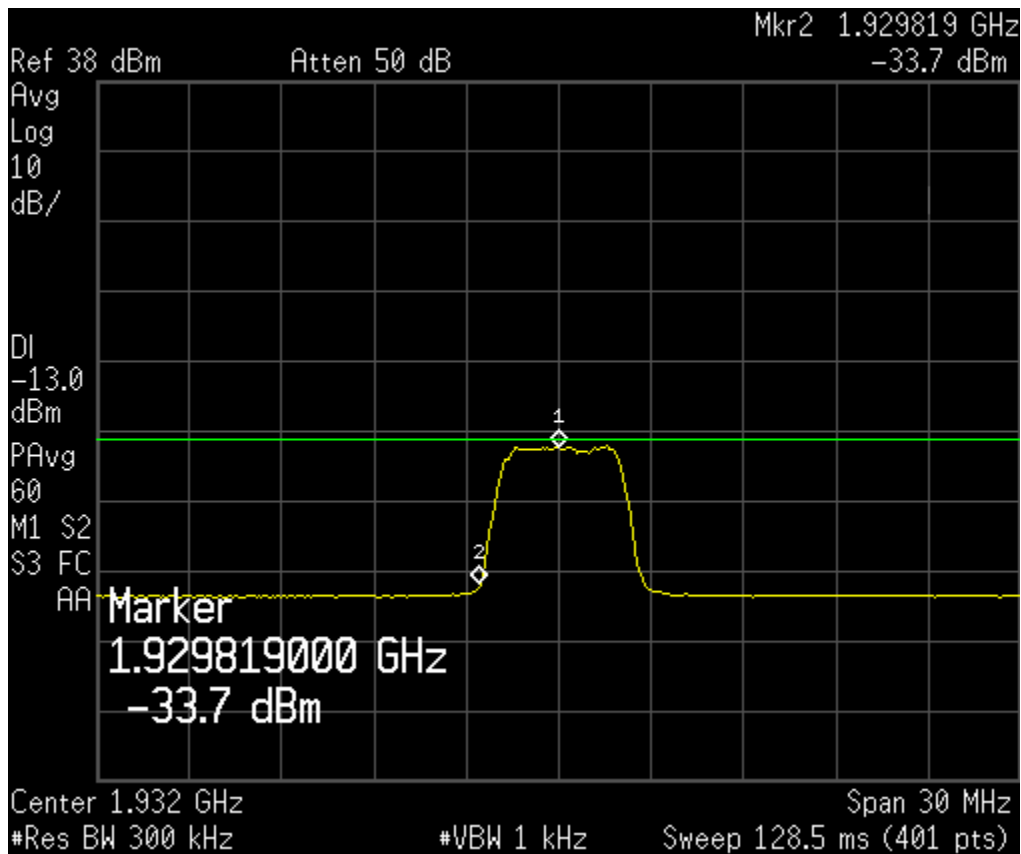

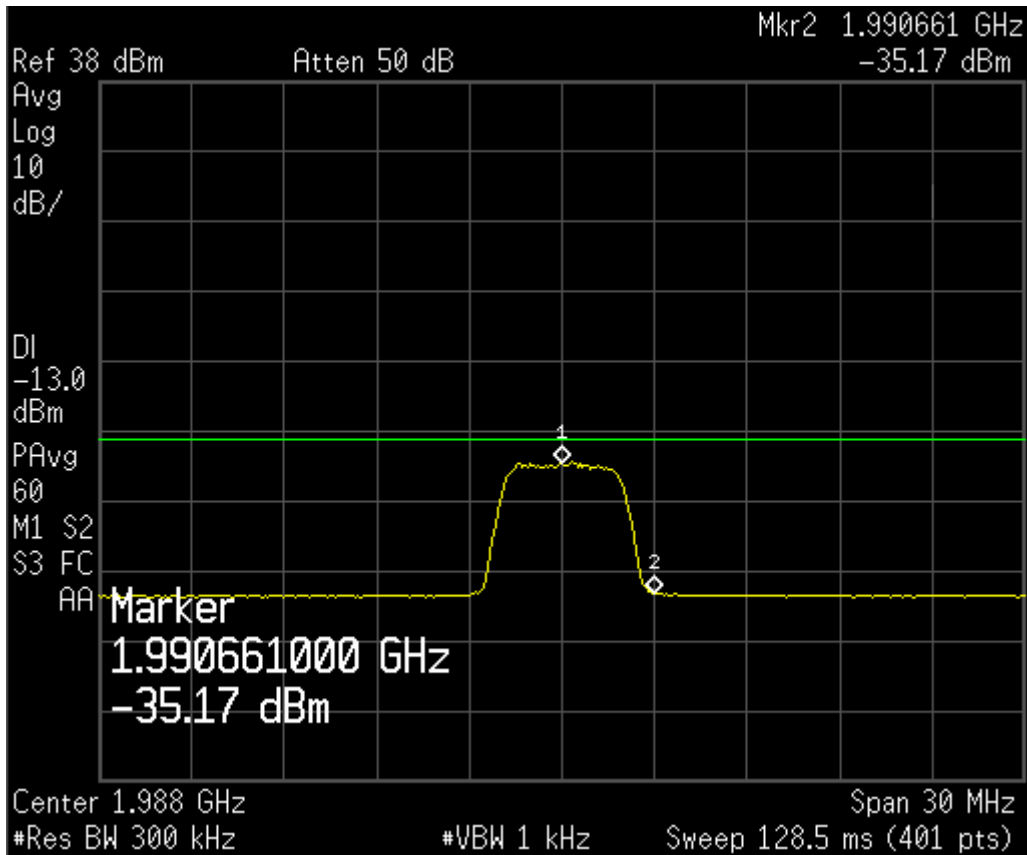



4M80F9W IV (2100):

Channel Frequency (MHz)	Band-edge Frequency Emission (MHz)	Amplitude at the band-edge (dBm)	Limit (dBm)
2112.4	2109.339	-53.46	-13
2152.6	2155.541	-57.66	-13

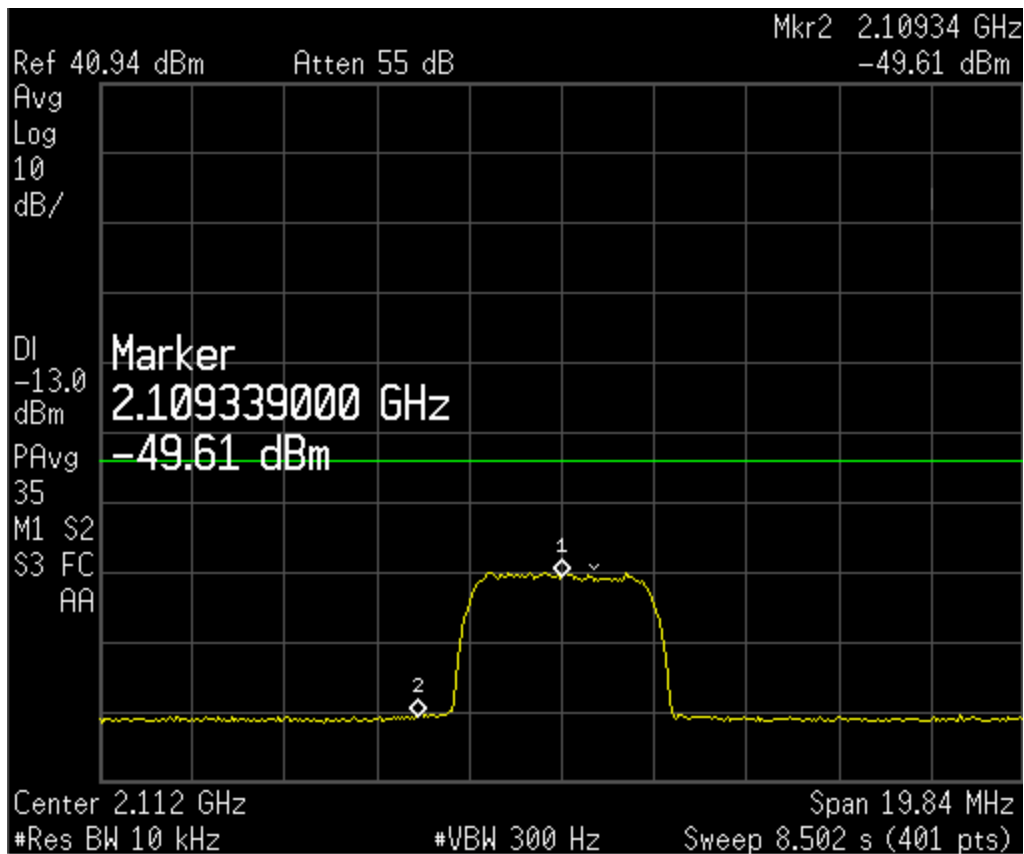

APPLICANT: Harris Corp.
 FCC ID: NK7-3166210
 Report #: H\Harris\2307AT10\2307AT10TestReport.doc



SPURIOUS EMISSIONS AT ANTENNA TERMINALS

Rules Part No.: §2.1051

Requirements: Emissions must be $43 + 10\log(P_o)$ dB below the mean power output of the transmitter.:

$$43 + 10\log(0.25) = 37.0 \text{ dB}$$

Method of Measurement: For analog modulation, the carrier was modulated 100% using a 2500 Hz tone. For digital modulation, the carrier is modulated to its maximum extent. The spectrum was scanned from 9kHz or the lowest frequency used to at least the 10th harmonic of the fundamental. The measurements were made in accordance with ANSI/TIA 603-C:2004.

4M80F9W V (850):

TF MHz	Emission MHz	dBc
871.40	1742.80	57.5
	2614.20	67.6
	3485.60	NF
	4357.00	NF
	5228.40	NF
	6099.80	NF
	6971.20	NF
	7842.60	NF
	8714.00	NF

TF MHz	Emission MHz	dBc
881.50	1763.00	58.1
	2644.50	67.8
	3526.00	NF
	4407.50	NF
	5289.00	NF
	6170.50	NF
	7052.00	NF
	7933.50	NF
	8815.00	NF

TF MHz	Emission MHz	dBc
891.60	1783.20	60.9
	2674.80	67
	3566.40	NF
	4458.00	NF
	5349.60	NF
	6241.20	NF
	7132.80	NF
	8024.40	NF
	8916.00	NF

4M80F9W II (1900):

TF MHz	Emission MHz	dBc
1932.40	3864.80	72.3
	5797.20	70.5
	7729.60	NF
	9662.00	NF
	11594.40	NF
	13526.80	NF
	15459.20	NF
	17391.60	NF
	19324.00	NF

TF MHz	Emission MHz	dBc
1960.00	3920.00	72.2
	5880.00	69.9
	7840.00	NF
	9800.00	NF
	11760.00	NF
	13720.00	NF
	15680.00	NF
	17640.00	NF
	19600.00	NF

TF MHz	Emission MHz	dBc
1987.60	3975.20	71
	5962.80	67.9
	7950.40	NF
	9938.00	NF
	11925.60	NF
	13913.20	NF
	15900.80	NF
	17888.40	NF
	19876.00	NF

NF Nothing found or ≥ 20 dB below the limit

APPLICANT: Harris Corp.
 FCC ID: NK7-3166210
 Report #: H\Harris\2307AT10\2307AT10TestReport.doc



4M80F9W IV (2100):

TF MHz	Emission MHz	dBc
2112.4	4224.80	72.9
	6337.20	68.5
	8449.60	NF
	10562.00	NF
	12674.40	NF
	14786.80	NF
	16899.20	NF
	19011.60	NF
	21124.00	NF

TF MHz	Emission MHz	dBc
2132.6	4265.20	71.7
	6397.80	66.4
	8530.40	NF
	10663.00	NF
	12795.60	NF
	14928.20	NF
	17060.80	NF
	19193.40	NF
	21326.00	NF

TF MHz	Emission MHz	dBc
2152.6	4305.20	71.9
	6457.80	68.0
	8610.40	NF
	10763.00	NF
	12915.60	NF
	15068.20	NF
	17220.80	NF
	19373.40	NF
	21526.00	NF

APPLICANT: Harris Corp.
 FCC ID: NK7-3166210
 Report #: H\Harris\2307AT10\2307AT10TestReport.doc

FIELD STRENGTH OF SPURIOUS EMISSIONS

Rules Part No.: Part 2.1053

Requirements: Emissions must be $43 + 10\log(P_o)$ dB below the mean power output of the transmitter.

$$43 + 10\log(0.25) = 37.0 \text{ dB}$$

Method of Measurements: The spectrum was scanned from 30 MHz to at least the tenth harmonic of the fundamental. This test was conducted per ANSI/TIA 603-C:2004 using the substitution method. Equipment placed 80 cm above ground on a rotating table platform. Tuned, calibrated antenna which may be raised from 1m to 4m above ground and changed in polarization.

Test Setup Diagram:

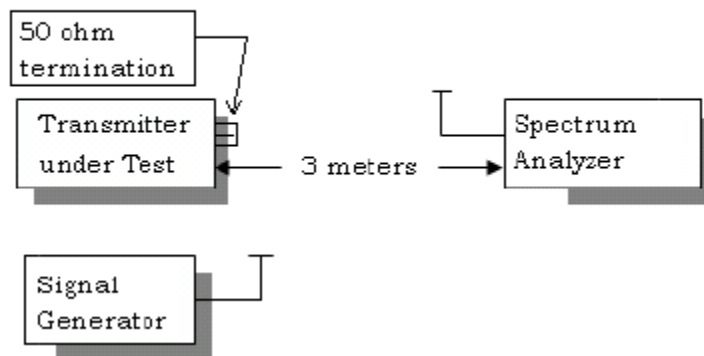

Test Data:

4M80F9W V (850):

Emission Frequency MHz	Ant. Polarity	dB Below Carrier (dBc)	Emission Frequency MHz	Ant. Polarity	dB Below Carrier (dBc)	Emission Frequency MHz	Ant. Polarity	dB Below Carrier (dBc)
871.40	0	0	881.50	0	0	891.60	0	0
1742.80	V	82.30	1763.00	V	82.25	1783.20	V	84.27
2614.20	V	77.40	2644.50	V	78.85	2674.80	V	80.34
3485.60	V	76.04	3526.00	H	76.99	3566.40	V	77.55
4357.00	V	74.82	4407.50	V	76.37	4458.00	V	75.80
5228.40	H/V	NF	5289.00	H/V	NF	5349.60	H/V	NF
6099.80	H/V	NF	6170.50	H/V	NF	6241.20	H/V	NF
6971.20	H/V	NF	7052.00	H/V	NF	7132.80	H/V	NF
7842.60	H/V	NF	7933.50	H/V	NF	8024.40	H/V	NF
8714.00	H/V	NF	8815.00	H/V	NF	8916.00	H/V	NF

APPLICANT: Harris Corp.
 FCC ID: NK7-3166210
 Report #: H\Harris\2307AT10\2307AT10TestReport.doc



4M80F9W II (1900):

Emission Frequency MHz	Ant. Polarity	dB Below Carrier (dBc)
1932.40	0	0
3864.80	V	78.30
5797.20	V	71.52
7729.60	H/V	NF
9662.00	H/V	NF
11594.40	H/V	NF
13526.80	H/V	NF
15459.20	H/V	NF
17391.60	H/V	NF
19324.00	H/V	NF

Emission Frequency MHz	Ant. Polarity	dB Below Carrier (dBc)
1960.00	0	0
3920.00	V	69.91
5880.00	V	69.21
7840.00	H/V	NF
9800.00	H/V	NF
11760.00	H/V	NF
13720.00	H/V	NF
15680.00	H/V	NF
17640.00	H/V	NF
19600.00	H/V	NF

Emission Frequency MHz	Ant. Polarity	dB Below Carrier (dBc)
1987.60	0	0
3975.20	V	78.42
5962.80	V	69.42
7950.40	H/V	NF
9938.00	H/V	NF
11925.60	H/V	NF
13913.20	H/V	NF
15900.80	H/V	NF
17888.40	H/V	NF
19876.00	H/V	NF

4M80F9W IV (2100):

Emission Frequency MHz	Ant. Polarity	dB Below Carrier (dBc)
2112.40	0	0
4224.80	V	74.50
6337.20	V	77.90
8449.60	H/V	NF
10562.00	H/V	NF
12674.40	H/V	NF
14786.80	H/V	NF
16899.20	H/V	NF
19011.60	H/V	NF
21124.00	H/V	NF

Emission Frequency MHz	Ant. Polarity	dB Below Carrier (dBc)
2132.60	0	0
4265.20	V	75.11
6397.80	V	68.57
8530.40	H/V	NF
10663.00	H/V	NF
12795.60	H/V	NF
14928.20	H/V	NF
17060.80	H/V	NF
19193.40	H/V	NF
21326.00	H/V	NF

Emission Frequency MHz	Ant. Polarity	dB Below Carrier (dBc)
2152.60	0	0
4305.20	V	79.06
6457.80	V	68.97
8610.40	H/V	NF
10763.00	H/V	NF
12915.60	H/V	NF
15068.20	H/V	NF
17220.80	H/V	NF
19373.40	H/V	NF
21526.00	H/V	NF



FREQUENCY STABILITY

Rules Part No.: Part 2.1055, Part 22.355, Part 24.235, and Part 27L

Requirements: Temperature and voltage tests were performed to verify that the frequency remains within the .00025%, 2.5ppm specification limit for.

Method of Measurement: The measurement technique is in accordance with ANSI/TIA 603-C:2004. The transmitter was placed in the temperature chamber at 25° C and allowed to stabilize for one hour. The transmitter was keyed ON for one minute during which four frequency readings were recorded at 15-second intervals. The worse case number was taken for temperature plotting. The assigned channel frequency was considered to be the reference frequency. The temperature was then reduced to -30° C after which the transmitter was again allowed to stabilize for one hour. The transmitter was keyed ON for one minute, and again frequency readings were noted at 15-second intervals. The worst case number was recorded for temperature plotting. This procedure was repeated in 10 degree increments up to + 50 degrees C.

Test Data:

4M80F9W V (850):

Reference Frequency	881.630061
---------------------	------------

TEMPERATURE °C	FREQUENCY MHz	PPM
0°C	881.631856	2.04
10°C	881.631472	1.60
20°C	881.630953	1.01
30°C	881.630682	0.70
40°C	881.629375	-0.78
50°C	881.628794	-1.44

Battery (V)	FREQUENCY MHz	PPM
-15%	881.630582	0.59
+15%	881.629864	-0.22

Device under test ceases to function below 0 °C

APPLICANT: Harris Corp.
FCC ID: NK7-3166210
Report #: H\Harris\2307AT10\2307AT10TestReport.doc



Test Data:
4M80F9W II (1900):

Reference Frequency	1960.030060
----------------------------	-------------

TEMPERATURE °C	FREQUENCY MHz	PPM
0°C	1960.034752	2.39
10°C	1960.033378	1.69
20°C	1960.031891	0.93
30°C	1960.030824	0.39
40°C	1960.029735	-0.17
50°C	1960.027384	-1.37

Battery (V)	FREQUENCY MHz	PPM
-15%	1960.030938	0.45
+15%	1960.029372	-0.35

4M80F9W IV (2100):

Reference Frequency	2132.650100
----------------------------	-------------

TEMPERATURE °C	FREQUENCY MHz	PPM
0°C	2132.654832	2.22
10°C	2132.653672	1.67
20°C	2132.651864	0.83
30°C	2132.650657	0.26
40°C	2132.649384	-0.34
50°C	2132.647658	-1.15

Battery (V)	FREQUENCY MHz	PPM
-15%	2132.650258	0.07
+15%	2132.650159	0.03

Device under test ceases to function below 0 °C