

Radar Transmitters

SITRANS LR560 (PROFIBUS PA)

Operating Instructions · 10/2010

*Draft_1.0-02
Firmware 1.00.00-32*

SITRANS

SIEMENS

Safety Guidelines: Warning notices must be observed to ensure personal safety as well as that of others, and to protect the product and the connected equipment. These warning notices are accompanied by a clarification of the level of caution to be observed.

Qualified Personnel: This device/system may only be set up and operated in conjunction with this manual. Qualified personnel are only authorized to install and operate this equipment in accordance with established safety practices and standards.

Unit Repair and Excluded Liability:

- The user is responsible for all changes and repairs made to the device by the user or the user's agent.
- All new components are to be provided by Siemens Milltronics Process Instruments.
- Restrict repair to faulty components only.
- Do not reuse faulty components.

Warning: Cardboard shipping package provides limited humidity and moisture protection. This product can only function properly and safely if it is correctly transported, stored, installed, set up, operated, and maintained.

This product is intended for use in industrial areas. Operation of this equipment in a residential area may cause interference to several frequency based communications.

Note: Always use product in accordance with specifications.

Copyright Siemens AG 2010. All Rights Reserved

Disclaimer of Liability

This document is available in bound version and in electronic version. We encourage users to purchase authorized bound manuals, or to view electronic versions as designed and authored by Siemens Milltronics Process Instruments. Siemens Milltronics Process Instruments will not be responsible for the contents of partial or whole reproductions of either bound or electronic versions.

While we have verified the contents of this manual for agreement with the instrumentation described, variations remain possible. Thus we cannot guarantee full agreement. The contents of this manual are regularly reviewed and corrections are included in subsequent editions. We welcome all suggestions for improvement.

Technical data subject to change.

MILLTRONICS® is a registered trademark of Siemens Milltronics Process Instruments.

Contact SMPI Technical Publications

at the following address:

Technical Publications
Siemens AG
Siemens Milltronics Process Instruments
1954 Technology Drive, P.O. Box 4225
Peterborough, Ontario, Canada, K9J 7B1
Email: techpubs.smpi@siemens.com

European Authorized Representative

Siemens AG
Industry Sector
76181 Karlsruhe
Deutschland

- For a selection of Siemens Milltronics level measurement manuals, go to: **www.siemens.com/processautomation**. Under Process Instrumentation, select *Level Measurement* and then go to the manual archive listed under the product family.
- For a selection of Siemens Milltronics weighing manuals, go to: **www.siemens.com/processautomation**. Under Weighing Technology, select *Continuous Weighing Systems* and then go to the manual archive listed under the product family.

Table of Contents

Safety Notes	1
Safety marking symbols	1
FCC Conformity	1
CE Electromagnetic Compatibility (EMC) Conformity	2
Industry Canada	2
The Manual	3
Application Example	3
Technical Support	3
Abbreviations and Identifications	4
SITRANS LR560 Overview	6
Programming	6
Local Display Interface (LDI)	7
Versions	7
Applications	7
Approvals and Certificates	7
Specifications	8
Power	8
Performance	8
Interface	9
Mechanical	9
Environmental	10
Process	10
Approvals	10
Programmer (infrared keypad)	11
Dimensions	12
Installation	17
Pressure Equipment Directive, PED, 97/23/EC	17
Mounting location	18
Nozzle location	18
Aimer Adjustment	19
Air Purging System	20
Purge Connection	21
Removable Display	22
Wiring	23
Power	23
Connecting SITRANS LR560	23
Basic PLC configuration with PROFIBUS PA	24
Wiring setups for hazardous area installations	25
Instructions Specific to Hazardous Area Installations	26
Local Operation	28
Activating SITRANS LR560	28
The LCD Display	
Handheld Programmer	30
Programming SITRANS LR560	31
Quick Start Wizard via the LDI push buttons	34
Quick Start Wizard via the handheld programmer	34
Requesting an Echo Profile	37

Device Address	37
Level application example	38
Operating via SIMATIC PDM	39
Functions in SIMATIC PDM	39
SIMATIC PDM Version	39
Electronic Device Description (EDD)	39
Configuring a new device	40
Set Address	40
Quick Start Wizard via SIMATIC PDM	40
Quick Start	41
Changing parameter settings using SIMATIC PDM	44
Parameters accessed via pull-down menus	44
Diagnostics	56
Security	59
Operating via FDT (Field Device Tool)	61
Device Type Manager (DTM)	61
SITRANS DTM	61
The instrument EDD	61
Configuring a new device via FDT	61
Parameter Reference	62
Quick Start	62
Quick Start Wizard	62
AFES (Auto False Echo Suppression) Wizard	63
Copy Parameters to Display	64
Copy Parameters from Display	64
Copy Firmware to Display	64
Copy Firmware from Display	65
Setup	65
Identification	65
Device	65
Sensor	66
Signal Processing	69
AIFB1	77
AIFB2	81
Measured Values	81
Filtering	81
Diagnostics	82
Echo Profile	82
Fault Reset	82
Trend	83
Electronics Temperature	83
Condensed Status	83
Allocation	84
Peak Values	86
Service	86
Demo Mode	86
Master Reset	87
Powered Hours	87
Power-on Resets	88
LCD Backlight	88

LCD Contrast.....	88
Remaining Device Lifetime	88
Remaining Sensor Lifetime.....	91
Service Schedule	94
Calibration Schedule	97
Communication.....	100
Device Address	100
PROFIBUS Ident Number	101
Security.....	101
Remote Access	101
Local Access	101
Language.....	101
Appendix A: Alphabetical Parameter List	103
Appendix B: Troubleshooting	106
Communication Troubleshooting	106
Device Status Icons	107
General Fault Codes	108
Operation Troubleshooting	112
Appendix C: Maintenance	114
Unit Repair and Excluded Liability	114
Appendix D: Technical Reference	115
Principles of Operation	115
Process Variables	115
Echo Processing	115
Process Intelligence	115
Echo Selection	116
Measurement Range	120
Measurement Response	120
Damping	121
Loss of Echo (LOE)	121
LOE Timer	121
Fail-safe Behavior	122
Temperature derating curve	123
Appendix E: PROFIBUS PA Profile Structure	124
PROFIBUS Level Device Design	124
Block Model	124
Description of the blocks	125
Appendix F: Communications via PROFIBUS PA	129
Device Configuration tool	129
SIMATIC PDM	129
Network Configuration	129
The GSD file	129
Bus Termination	129
Power Demands	129
PROFIBUS address	130
Operating as a Profile Device	130
Configuring a device	131
Configuring PROFIBUS PA with an S7-300/ 400 PLC	131
Cyclic versus Acyclic Data	131

Cyclic Data	131
Status Byte	132
Condensed Status	132
Status Byte	134
Diagnostics	135
Diagnosis reply (available cyclically)	135
Diagnosis Object (available cyclically or acyclically)	136
Acyclic Extended Diagnostics (General Fault Codes)	138
Acyclic Data	141
Appendix G: Firmware Revision History	142
Glossary	143
Index	147
LCD menu structure	151

Safety Notes

Special attention must be paid to warnings and notes highlighted from the rest of the text by grey boxes.



WARNING symbol relates to a caution symbol on the product, and means that failure to observe the necessary precautions can result in death, serious injury, and/or considerable material damage.



WARNING symbol, used when there is no corresponding caution symbol on the product, means that failure to observe the necessary precautions can result in death, serious injury, and/or considerable material damage.

Note: means important information about the product or that part of the operating manual.

Safety marking symbols

In manual	On product	Description
		Earth (ground) Terminal
		Protective Conductor Terminal
		(Label on product: yellow background.) WARNING: refer to accompanying documents (manual) for details.

FCC Conformity

US Installations only: Federal Communications Commission (FCC) rules



WARNING: Changes or modifications not expressly approved by Siemens Milltronics could void the user's authority to operate the equipment.

Notes:

- This equipment has been tested and found to comply with the limits for a Class B digital device, pursuant to Part 15 of the FCC Rules. These limits are designed to provide reasonable protection against harmful interference when the equipment is operated in a commercial environment.
- This equipment generates, uses, and can radiate radio frequency energy and, if not installed and used in accordance with the instruction manual, may cause harmful interference to radio communications.

CE Electromagnetic Compatibility (EMC) Conformity

This equipment has been tested and found to comply with the following EMC Standards:

EMC Standard	Title
CISPR 11:2004/EN 55011:1998+A1:1999&A2:2002, CLASS B	Limits and methods of measurements of radio disturbance characteristics of industrial, scientific, and medical (ISM) radio-frequency equipment.
EN 61326:1997+A1:1998+A2:2001+A3:2003 (IEC 61326:2002)	Electrical Equipment for Measurement, Control and Laboratory Use – Electromagnetic Compatibility.
EN61000-4-2:2001	Electromagnetic Compatibility (EMC) Part 4-2:Testing and measurement techniques – Electrostatic discharge immunity test.
EN61000-4-3:2002	Electromagnetic Compatibility (EMC) Part 4-3: Testing and measurement techniques – Radiated, radio-frequency, electromagnetic field immunity test.
EN61000-4-4:2004	Electromagnetic Compatibility (EMC) Part 4-4: Testing and measurement techniques – Electrical fast transient/burst immunity test.
EN61000-4-5:2001	Electromagnetic Compatibility (EMC) Part 4-5: Testing and measurement techniques – Surge immunity test.
EN61000-4-6:2004	Electromagnetic Compatibility (EMC) Part 4-6: Testing and measurement techniques – Immunity to conducted disturbances, induced by radio-frequency fields.
EN61000-4-8:2001	Electromagnetic Compatibility (EMC) Part 4-8: Testing and measurement techniques – Power frequency magnetic field immunity test.

Industry Canada

- a) Operation is subject to the following two conditions: (1) this device may not cause interference, and (2) this device must accept any interference, including interference that may cause undesired operation of the device.
- b) This device shall be installed and operated in a completely enclosed container to prevent RF emission which otherwise can interfere with aeronautical navigation. Installation shall be done by trained installers, in strict compliance with the manufacturer's instructions.
- c) The use of this device is on a "no-interference, no-protection" basis. That is, the user shall accept operations of high-powered radar in the same frequency band which may interfere with or damage this device. On the other hand, level probing devices found to interfere with primary licensing operations will be required to be removed at the user's expense.

- d) This level probing device is only permitted for installation inside enclosed containers. The installer/user of this device shall ensure that it is at least 10 km from the Penticton radio astronomy station (British Columbia latitude: 49° 19' 12" N, longitude: 119° 37' 12" W). For devices not meeting this 10 km separation (e.g. the Okanagan Valley, British Columbia) the installer/ user must coordinate with and obtain the written concurrence of the Director of the Penticton radio astronomy station before the equipment can be installed or operated. The Penticton contact is Tel: 250-493-2277/ fax: 250-493-7767. (In case of difficulty, the Manager, Radio Equipment Standards, Industry Canada, may also be contacted.)

The Manual

Notes:

- This product is intended for use in industrial areas. Operation of this equipment in a residential area may cause interference to several frequency based communications.
- Please follow the installation and operating procedures for a quick, trouble-free installation and to ensure the maximum accuracy and reliability of your SITRANS LR560.
- This manual applies to the SITRANS LR560 (PROFIBUS PA) only.

This manual will help you set up your SITRANS LR560 for optimum performance. We always welcome suggestions and comments about manual content, design, and accessibility. Please direct your comments to techpubs.smpi@siemens.com.

For other Siemens Milltronics level measurement manuals, go to: www.siemens.com/level, and look under **Level Measurement**.

Application Example

The application example used in this manual illustrates a typical installation using SITRANS LR560. (See *Level application example* on page 38.) Because there is often a range of ways to approach an application, other configurations may also apply.

In all examples, substitute your own application details. If the example does not apply to your application, check the applicable parameter reference for the available options.

Technical Support

Support is available 24 hours a day.

To find your local Siemens Automation Office address, phone number and fax number go to: www.siemens.com/automation/partner

- Click on the tab **Contact**, select **Service**, then click **Service** again to find your product group (**+Automation Technology > +Sensor Systems >+Process Instrumentation > +Level Measurement > +Continuous**). Select **Radar**.
- Select the country followed by the City/Region.
- Select **Technical Support** under **Service**.

For on-line technical support go to: www.siemens.com/automation/support-request

- Enter the device name (SITRANS LR560) or order number, then click on **Search**, and select the appropriate product type. Click on **Next**.
- You will be prompted to enter a keyword describing your issue. Then either browse the relevant documentation, or click on **Next** to email a detailed description of your issue to Siemens Technical Support staff.

Siemens IA/DT Technical Support Center: phone +49 (0)911 895 7 222

Abbreviations and Identifications

Short form	Long Form	Description	Units
AIFB	Analog Input Function Block		
CE / FM / CSA	Conformité Européenne / Factory Mutual / Canadian Standards Association	safety approval	
DCS	Distributed Control System	control room apparatus	
dK	dielectric constant		
EDD	Electronic Device Description		
ESD	Electrostatic Discharge		
FMCW	Frequency Modulated Continuous Wave	radar principle	
I_i	Input current		mA
I_o	Output current		mA
LCD	Liquid Crystal Display		
LDI	Local Display Interface	removable display with push buttons	
LUI	Local User Interface	view outputs via LCD display; make modifications via push buttons or handheld programmer	
μ s	microsecond	10^{-6}	Second
PA	Process Automation (PROFIBUS)		
PED	Pressure Equipment Directive	safety approval	
ppm	parts per million		
PV	Primary Value	measured value	

Short form	Long Form	Description	Units (cont'd)
SELV	Safety extra low voltage		
SV	Secondary Value	equivalent value	
TB	Transducer Block		
TVT	Time Varying Threshold	sensitivity threshold	
U_i	Input voltage		V
U_o	Output voltage		V

SITRANS LR560 Overview

SITRANS LR560 is a 2-wire, 78 GHz FMCW radar level transmitter for continuous monitoring of solids in vessels to a range of 100 m (329 ft). The plug and play performance is ideal for all solids applications, including those with extreme dust and high temperatures to +200 °C (+392 °F). The device consists of an electronic circuit coupled to a lens antenna and flange for quick and easy positioning.

The main benefits of using 78 GHz over devices using lower frequency are:

- very narrow beam, so device is insensitive to mounting nozzle interference and vessel obstructions.
- short wavelength yields very good reflection properties on sloped solids, so aiming towards material angle of repose is usually not necessary.

The technology is very tolerant of buildup on the lens antenna, however an air purge inlet is provided for periodic cleaning if required.

SITRANS LR560 supports PROFIBUS PA communication protocol, and SIMATIC PDM software. Signals are processed using Process Intelligence which has been field-proven in over 1,000,000 applications worldwide (ultrasonic and radar). This device supports acyclic communications from both a PROFIBUS Class I and Class II master.

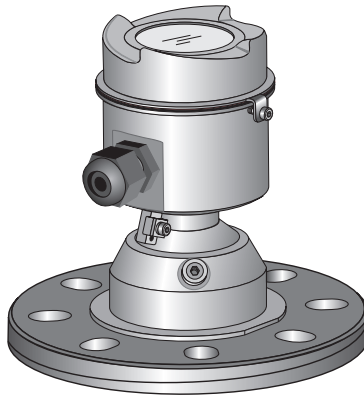

Programming

SITRANS LR560 is very easy to install and configure via an optional graphical local display interface. You can modify the built-in parameters either locally via the push buttons or using the infrared handheld programmer, or from a remote location using one of the following options:

- PROFIBUS PA (using SIMATIC PDM, FDT [such as PACTware or Fieldcare])
- HART (using 375 handheld Field Communicator, SIMATIC PDM, AMS, FDT [such as PACTware or Fieldcare]). See SITRANS LR560 (mA/HART) Instruction Manual for more information.
- Foundation Fieldbus FF (using 375 handheld Field Communicator or AMS). See SITRANS LR560 (Foundation Fieldbus) Instruction Manual for more information.

Once programmed, the graphic Local Display Interface (LDI) can be removed and used to transfer parameters to multiple SITRANS LR560s.

Local Display Interface (LDI)

- LDI may be ordered installed or added later as an option
- can be mounted in 1 of 4 positions at 90 degree intervals, for easy viewing after installation
- displays level and diagnostic information including echo profile and trend over time
- backlit for easy viewing in dimly lit areas
- allows you to copy parameters from one device to another
- provides high speed firmware transfer capabilities for future upgrades



Versions

Two different versions of the LR560 are available:

- 40 m range, 100 °C maximum process temperature
- 100 m range, 200 °C maximum process temperature

Applications

- solids bulk storage vessels
- cement powder, plastic powder/pellets, grain, flour, coal, and other applications

Approvals and Certificates

SITRANS LR560 is available with General Purpose or Hazardous approvals.

Application Type		Approval Rating	Valid for:	Wiring
Non-hazardous	General Purpose	CSA _{US/C} , FM, CE, C-TICK	N. America, Europe	See page 23
Hazardous	Non-Sparking/ Energy Limited	ATEX II 3G Ex nA/nL IIC T4 Gc	Europe	See page 25
	Dust Ignition Proof	ATEX II 1D, 1/2D, 2D IECEx SIR 09.0149X Ex ta IIIC T139 °C	Europe and International	See page 25
		FM/CSA: Class II, Div. 1, Groups E, F, G Class III T4	US/Canada	See page 26
	Non-incendive	FM/CSA: Class I, Div. 2, Groups A, B, C, D T4	US/Canada	See page 26

Specifications

Note: Siemens Milltronics makes every attempt to ensure the accuracy of these specifications but reserves the right to change them at any time.

Power

Bus powered	9 to 32 V DC, per IEC 61158-2 (PROFIBUS PA)
Current consumed	13.5 mA

Performance

Reference operating conditions according to IEC 60770-1

- ambient temperature +15 to +25 °C (+59 to +77 °F)
- humidity 45% to 75% relative humidity
- ambient pressure 860 to 1060 mbar g (86,000 to 106,000 N/m² g)

Measurement Accuracy¹⁾ (measured in accordance with IEC 60770-1)

- Maximum measured error - Greater of 25 mm (1") or 0.25 % of range from minimum detectable distance to full range

Frequency 78 to 79 GHz FMCW

Max. measurement range²⁾

- 40 m version 40 m (1.31 ft)
- 100 m version 100 m (328 ft)

Min. detectable distance 300 mm (11.8") from sensor reference point

Update time³⁾ maximum 10 seconds, depending on setting for **Response Rate (2.3.6.1)**

Influence of ambient temperature <0.003%/K (average over full temperature range, referenced to maximum range)

Dielectric constant of material measured

- for ranges up to 20 m (65.6 ft) minimum dK = 1.6
- for ranges up to 100 m (328 ft) minimum dK = 2.5

Memory

- non-volatile EEPROM
- no battery required.

¹⁾ Reference conditions: **Position Detect (2.4.5.2.)** set to Center and **Algorithm (2.4.5.1.)** set to True First Echo.

²⁾ From sensor reference point, see *Dimensions* on page 12.

³⁾ Reference conditions: **Response Rate (2.3.6.1.)** set to **FAST**.

Interface

Communication

- PROFIBUS PA 3.01

Configuration

- remote Siemens SIMATIC PDM or FDT such as PACTWARE
- local Siemens infrared handheld programmer or local control buttons

Optional removable

local display interface (LDI)¹⁾ graphic LCD, with bar graph representing level

Mechanical

Process Connections:

- universal flat-faced flanges²⁾
 - 3"/80 mm, 4"/100 mm, 6"/150 mm
 - materials stainless steel 316L (1.4404 or 1.4435), or 304
- Aimer flanges²⁾
 - 3"/80 mm, 4"/100 mm, 6"/150 mm
 - material polyurethane powder-coated cast aluminum

Enclosure

- construction 316L/1.4404 stainless steel
- conduit entry M20x1.5, or ½" NPT
- conduit entry connector M12 connector (shipped with M20 to M12 adaptor) (optional) or 7/8" connector (shipped with 1/2" NPT to 7/8" adaptor)
- ingress protection Type 4X/NEMA 4X, Type 6/NEMA 6, IP68
- lid with window polycarbonate (window material)

Lens antenna material

- construction
 - 40 m version PEI
 - 100 m version PEEK

Air Purge Connection

- equipped with female 1/8" NPT fitting

Weight

- 3" stainless steel flange model 3.15 kg (6.94 lb)

¹⁾ Display quality will be degraded in temperatures below -20 °C (-4 °F) and above +65 °C (+149 °F).

²⁾ Universal flange mates with EN 1092-1 (PN16)/ASME B16.5 (150 lb)/JIS 2220 (10K) bolt hole pattern.

Environmental

Note: Use appropriate conduit seals to maintain IP or NEMA rating.

- location indoor/ outdoor
- altitude 5000 m (16,404 ft) max.
- ambient temperature –40 to +80 °C (–40 to +176 °F)
- relative humidity suitable for outdoor
Type 4, 4X/NEMA 4, 4X, Type 6/NEMA 6, IP68 enclosure (see note above)
- installation category I
- pollution degree 4

Process

- temperature and pressure¹⁾

Versions	Stainless steel flange	Aimer flange 0.5 bar max.	Aimer flange 3.0 bar max
40 m	–40 to +100 °C (–40 to +212 °F)	–40 to +100 °C (–40 to +212 °F)	–40 to +100 °C (–40 to +212 °F)
100 m	–40 to +200 °C (–40 to +392 °F)	–40 to +200 °C (–40 to +392 °F)	–40 to +120 °C (–40 to +248 °F)

Approvals

Note: The device label lists the approvals that apply to your device.

- General CSA_{US/C}, FM, CE, C-TICK
- Radio R&TTE (Europe), FCC, Industry Canada,
- Hazardous
 - Non-sparking/
 - Energy Limited²⁾ (Europe) ATEX II 3G Ex nA/nL IIC T4 Gc
 - Dust Ignition Proof²⁾(Europe/International) ATEX II 1D, 1/2D, 2D
IECEx SIR 09.0149X
Ex ta IIIC T139 °C

¹⁾ Maximum and minimum temperatures are dependent on the process connection, antenna and O-ring materials. Use of the Easy Aimer limits maximum temperature.

²⁾ See *Non-Sparking/Energy Limited wiring (Europe) and Dust Ignition Proof wiring (Europe/International)* on page 25 for more details.

Dust Ignition Proof ¹⁾ (US/Canada)

FM/CSA:

Class II, Div. 1, Groups E, F, G

Class III T4

Non-incendive ¹⁾ (US/Canada)

FM/CSA Class I, Div. 2,

Groups A, B, C, D, T4

Programmer (infrared keypad)

Notes:

- Battery is non-replaceable with a lifetime expectancy of 10 years in normal use.
- To estimate the lifetime expectancy, check the nameplate on the back for the serial number. The first six numbers show the production date (mmddyy), for example, serial number 032608101V.

Siemens Milltronics Infrared IS (Intrinsically Safe) Hand Programmer for hazardous and all other locations (battery is non-replaceable)

- approval
FM/CSA Class I, II, III, Div. 1, Gr. A to G T6
CE
ATEX II 1GD Ex ia IIC T4 Ga
Ex iaD 20 T135 °C
IECEx SIR 09.0073 Ex ia IIC T4 Ga
Ex iaD 20 T135 °C
INMETRO Br-Ex ia IIC T4
- ambient temperature
–20 to +50 °C (–5 to +122 °F)
- interface
proprietary infrared pulse signal
- power
3 V lithium battery
- weight
150 g (0.3 lb)
- color
black
- Part Number
7ML1930-1BK

¹⁾ See *Non-incendive and Dust Ignition Proof wiring (US/Canada)* on page 26.

Dimensions

SITRANS LR560 with stainless steel Universal Flat-faced Flange

Note: Refer to *Universal Slotted Flange* on page 16 for bolt hole patterns and dimensions.

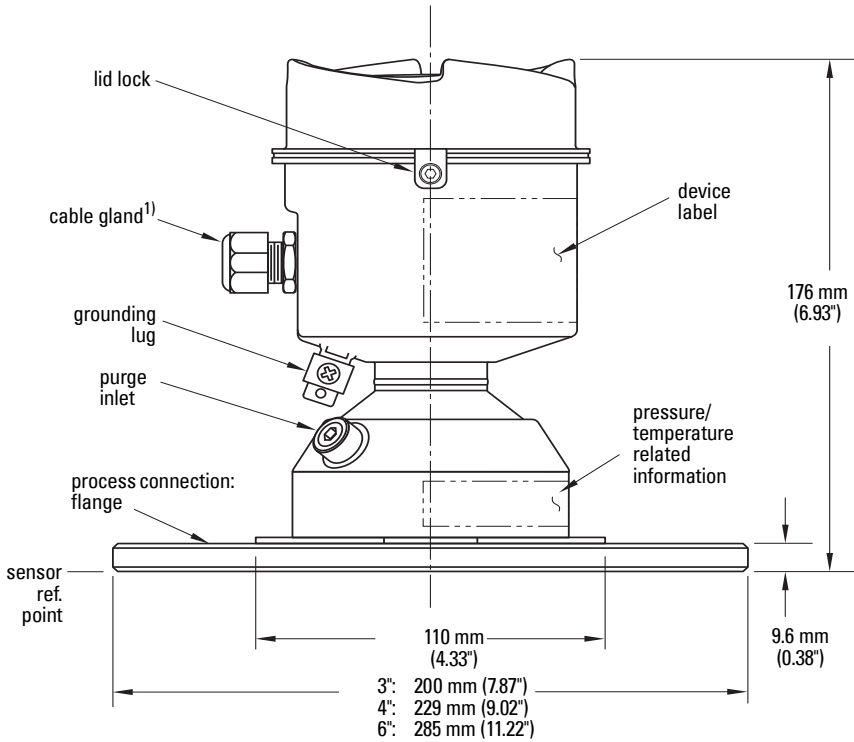

¹⁾ Shipped with product, packed in a separate bag.

SITRANS LR560 with 3" Aimer Flange

Note: Refer to *Universal Slotted Flange* on page 16 for bolt hole patterns and dimensions.

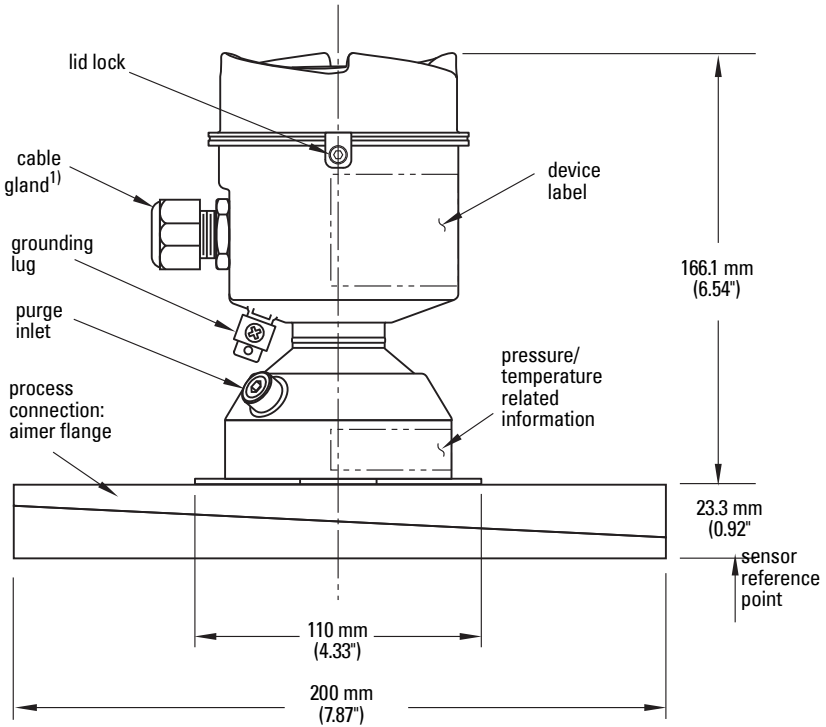

Specifications

¹⁾ Shipped with product, packed in a separate bag.

SITRANS LR560 with 4" and 6" Aimer Flange

Note: Refer to *Universal Slotted Flange* on page 16 for bolt hole patterns and dimensions.

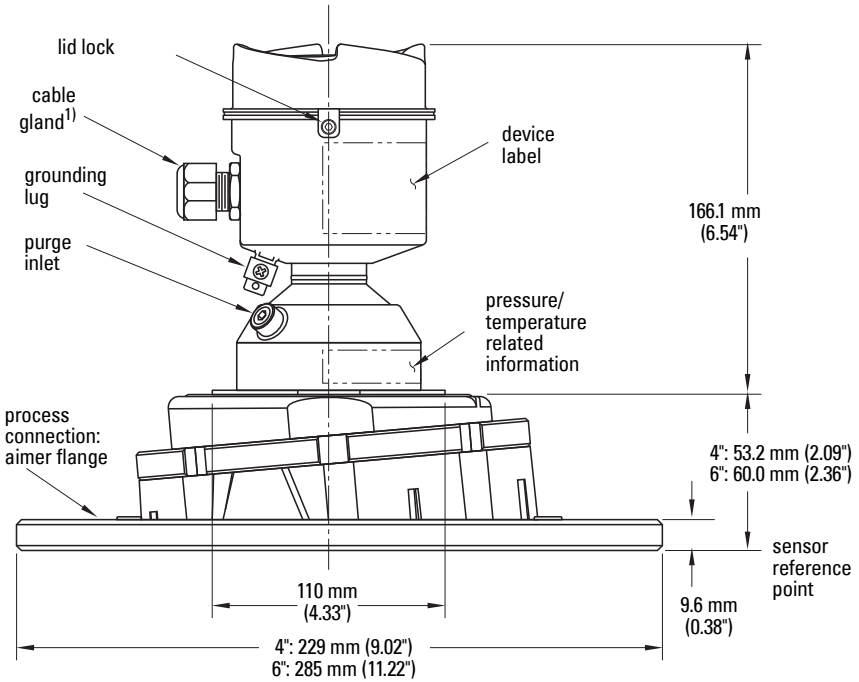

Specifications

C Spanner

A C spanner, used to loosen the aimer locking ring, is shipped with the device.

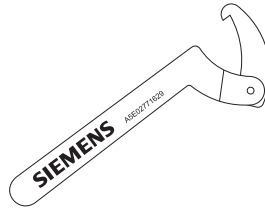

¹⁾ Shipped with product, packed in a separate bag.

Process Connection Label (Pressure Rated Versions)

For pressure-rated versions only, the process connection label lists the following information:

Item	Sample Text	Comments/Explanation
CONNECTION SERIES	ASME B16.5 / EN 1092-1 / JIS B 2220	Flange Series: dimensional pattern based on ASME B16.5/EN 1092-1/JIS B 2220 flange standards
NOM. PIPE SIZE (DN)	4 INCH / 100mm	Nominal Pipe Size: based on 150#/PN16/10K flange pressure classes
MAWP (PS)	3 BAR	Maximum Allowable Working Pressure at Design Temperature
DESIGN TEMP. (TS)	100 °C	Maximum Allowable Working Temperature
MIN. PROCESS	3 BAR AT -40 °C	Minimum Wetted Process Conditions
0F13589.5		Canadian Registration Number (CRN)
TEST PRESSURE (PT)	5.2 BAR	Production Test Pressure
TEST DATE	10/01/04	Date of Pressure Test (Year/Month/Day)
PROCESS SERIES	25785	Pressure Tag Family Series
WETTED NON-METALLIC	PEI	Sensor Lens Material
WETTED METALLICS	304L	Process Connection Material(s)
WETTED SEALS	FKM / VQM	Seal Material(s)

Universal Slotted Flange

! WARNING: The user is responsible for the selection of bolting and gasket materials which will fall within the limits of the flange and its intended use and which are suitable for the service conditions.

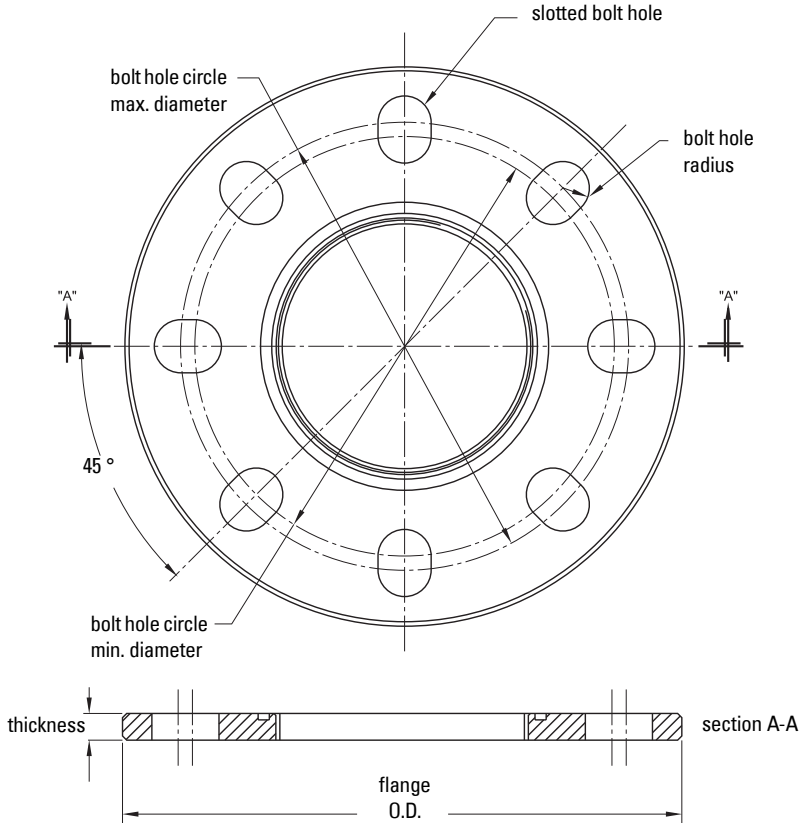

Slotted Flange Dimensions and Aimer¹⁾

Pipe Size	Flange O.D.	Thick-ness (s)	Bolt Hole Circle Max Ø	Bolt Hole Circle Min Ø	Bolt Hole radius	No. of Slotted Holes
3" or 80 mm	7.87" (200 mm)	0.38" (9.65 mm)	6.30" (160 mm)	5.91" (150 mm)	0.38" (9.65 mm)	8
4" or 100 mm	9.00" (229 mm)	0.38" (9.65 mm)	7.52" (191 mm)	6.89" (175 mm)	0.38" (9.65 mm)	8
6" or 150 mm	11.22" (285 mm)	0.38" (9.65 mm)	9.53" (242 mm)	9.45" (240 mm)	0.45" (11.5 mm)	8

¹⁾ Universal flange mates with EN 1092-1 (PN16)/ASME B16.5 (150 lb)/JIS 2220 (10K) bolt hole pattern.

Installation



• WARNINGS:

- **Installation shall be performed only by qualified personnel and in accordance with local governing regulations.**
- **SITRANS LR560 is to be used only in the manner outlined in this manual, otherwise protection provided by the device may be impaired.**
- **Never attempt to loosen, remove, or disassemble process connection or instrument housing while vessel contents are under pressure.**
- **The user is responsible for the selection of bolting and gasket materials which will fall within the limits of the flange and its intended use and which are suitable for the service conditions.**
- **Improper installation may result in loss of process pressure.**

Notes:

- For European Union and member countries, installation must be according to ETSI EN 302372.
- Refer to the device label for approval information.
- SITRANS LR560 units are pressure tested, meeting or exceeding the requirements of the ASME Boiler and Pressure Vessel Code and the European Pressure Equipment Directive.
- The serial numbers stamped in each process connection body provide a unique identification number indicating date of manufacture.
Example: MMDDYY – XXX (where MM = month, DD = day, YY = year, and XXX= sequential unit produced)
Further markings (space permitting) indicate flange configuration, size, pressure class, material, and material heat code.

Pressure Equipment Directive, PED, 97/23/EC

Note: Pertains to pressure-rated version only.

SITRANS LR560 Radar Level Measurement instrument falls below the limits of Article 3, sections 1 & 2 of the Pressure Equipment Directive (PED, 97/23/EC) as a category I pressure accessory. However, in accordance with PED, 97/23/EC, Article 3, section 3, this equipment has been designed and manufactured in accordance with Sound Engineering Practice (SEP) (see EU Commission Guideline 1/5).

Mounting location

Notes:

- Correct location is key to a successful application.
- Avoid reflective interference from vessel walls and obstructions by following the guidelines below.

Nozzle location

Notes:

- For details on avoiding false echoes, see *Auto False Echo Suppression (2.4.8.1.)* on page 118.

Beam angle

- Beam angle is the width of the cone where the energy density is half of the peak energy density.
- The peak energy density is directly in front of and in line with the antenna.
- There is a signal transmitted outside the beam angle, therefore false targets may be detected.

Emission cone

- Keep emission cone free of interference from ladders, pipes, I-beams or filling streams.
- Avoid central locations on tall, narrow vessels.
- LR560 uses circular polarization. Rotation of device is not required to optimize signal.

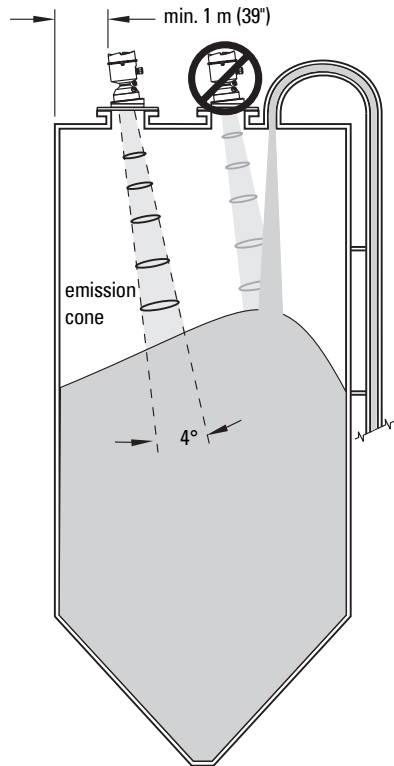

Environment

- Provide easy access for viewing the display and programming via the handheld programmer.
- Provide an environment suitable for the ambient temperature rating.

ambient temperature
-40 °C to 80 °C
(-40 °F to 176 °F)

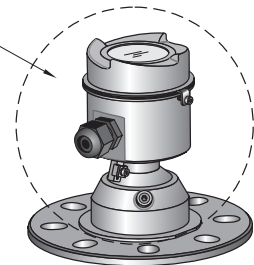

process temperature:
-40 to +100 °C (-40 to +212 °F) or
-40 to +200 °C (-40 to +392 °F) depending on the version

Sunshield

The LR560 display can be protected by an optional sunshield if the instrument will be mounted in direct sunlight.

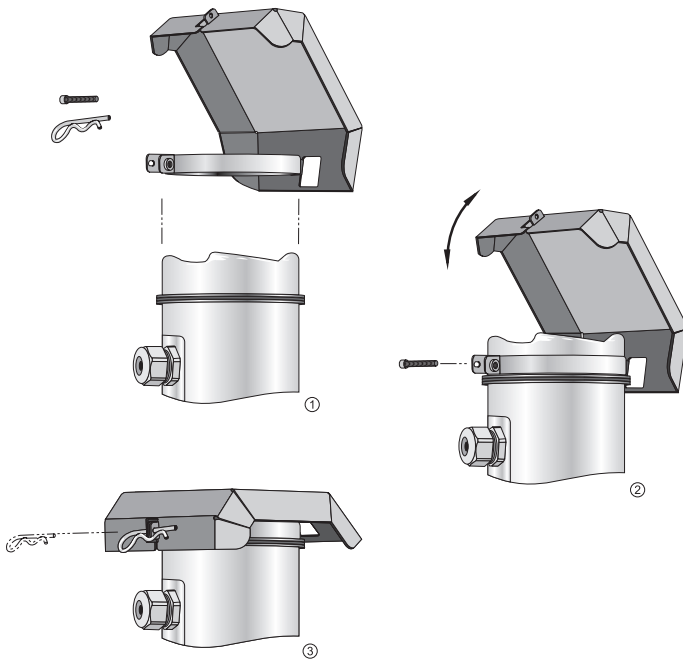

Aimer Adjustment

Note: Aiming will assist in measuring material in the cone.

3" flange

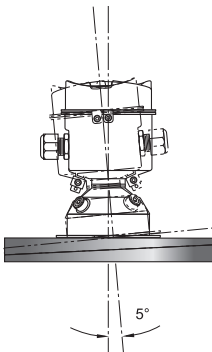

4 and 6" flange

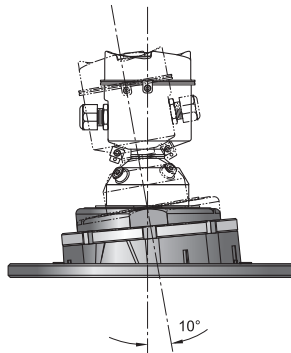

Aiming is not required for signal optimization with 78 GHz frequency.

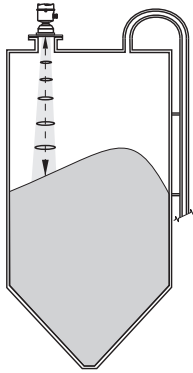

Aiming will assist in measuring material in the cone.

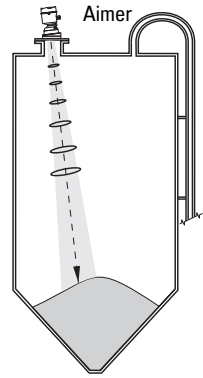

- 1) For 4" and 6" Aimer: Loosen the set screws in the locking ring.

Holding the electronics enclosure firmly, loosen the Aimer locking ring using the C spanner supplied, until the LR560 drops down slightly. The enclosure can then be turned freely.

Markings on the flange indicate minimum and maximum rotation (see *Removable Display* on page 22).

- 2) Direct SITRANS LR560 so the antenna is pointed at an angle perpendicular to the material surface, if possible.
- 3) When the desired position is reached, re-tighten the locking ring using the C spanner, and tighten set screws.
- 4) For the 3" Aimer flange, tapered split washers with pressure rated versions are provided to keep nuts and bolts perpendicular to the flange surface.

Air Purging System

For convenient cleaning, a purging inlet is provided above the antenna. The system provides an 1/8" inlet (female thread) above the antenna where clean, dry air passes to the face of the antenna lens to clean it. The customer will supply the purging air by a manual or automatic valve system.

Notes:

- Purge duration, pressure, and interval, will vary with each application. It is the user's responsibility to determine the requirements depending on the application and cleaning required.
- Short duration bursts of high pressure provide more effective cleaning than continuous low pressure air.
- It is the customer's responsibility to ensure that any vacuum or pressure in the measured vessel is maintained, considering the hole that passes through the process connection and SITRANS LR560 antenna system.

NOTE: Table continues on next page.

Air Consumption (Flow rate versus applied pressure)	
Air Pressure (psi)	Approx. inlet volume flow rate SCFM ^{a)}
20	5
40	10

Air Consumption (Flow rate versus applied pressure) (cont'd)	
50	15
80	20
100	25
110	30
Recommended 90 to 110 psi for effective cleaning.	

- a) SCFM (standard cubic feet/minute) referenced to 14.7 psia, +68 °F and 36% relative humidity (RH)

Purge Connection

- The purge connection is closed by the manufacturer, using a 1/8" plug.
- When the plug is removed to connect a purging system, the operator is responsible for ensuring that the purging circuit conforms to "Ex" requirements: for example, by fitting an NRV valve¹⁾.

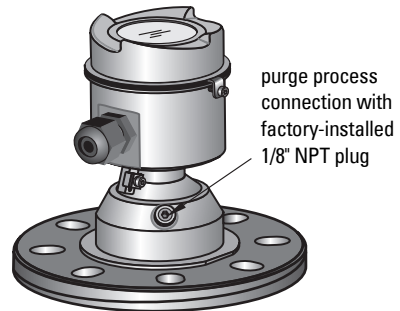

Purge airflow

- The purge airflow is designed to create a strong vortex of air that rapidly cleans the face of the lens.
- The air purge system can clean both dust and moisture off the lens.
- It can be used for periodic cleaning.

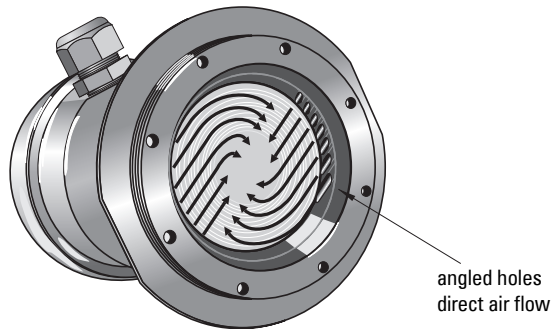

¹⁾ Air pressure in vessel can affect purge operation.

Removable Display

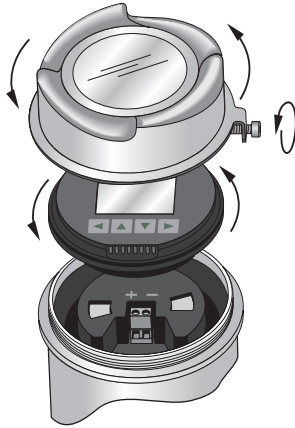

- The optional display can be rotated as required, to one of 4 positions, 90 degrees apart (see *Connecting SITRANS LR560* on page 23 for instructions).
- It can also be used to transfer parameters from one device to another. (See *Copy Parameters to Display* on page 64.)

Wiring

Power

WARNINGS:



The DC input terminals shall be supplied from a source providing electrical isolation between the input and output, in order to meet the applicable safety requirements of IEC 61010-1.



All field wiring must have insulation suitable for rated voltages.

Connecting SITRANS LR560



WARNINGS:

- Check the device label on your instrument, to verify the approval rating.
 - Use appropriate conduit seals to maintain IP or NEMA rating.
 - See *Wiring setups for hazardous area installations* on page 25.
- 1) Loosen locking screw.
 - 2) Remove LR560 lid.
 - 3) Remove optional display by gently turning the display a quarter turn counter-clockwise until it is free.
 - 4) Strip the cable jacket for approximately 70 mm (2.75") from the end of the PROFIBUS PA cable, and thread the wires through the gland¹⁾.

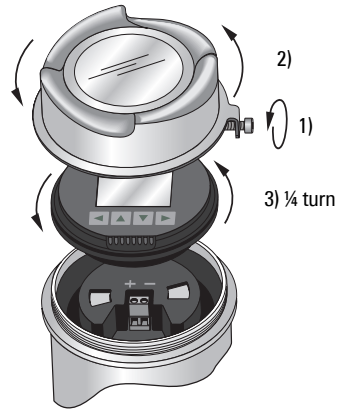

¹⁾ If cable is routed through conduit, use only approved suitable-size hubs for waterproof applications.

- Connect the wires to the terminals as shown (SITRANS LR560 PA is not polarity-sensitive.)

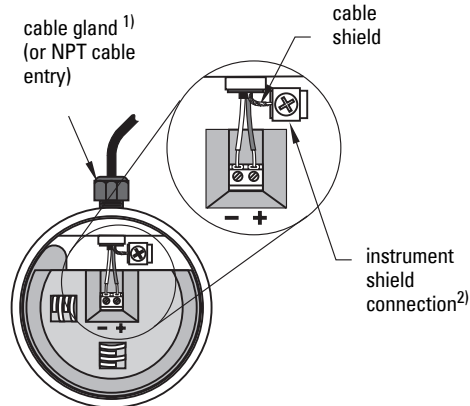

- Ground the instrument according to local regulations.
- Tighten the gland to form a good seal.
- Replace optional display and device lid.
- Secure the locking screw before programming and device configuration.

Notes:

- PROFIBUS PA must be terminated at both extreme ends of the cable for it to work properly.
- Please refer to the *PROFIBUS PA User and Installation Guidelines* (order number 2.092), available from www.profibus.com, for information on installing PROFIBUS devices.
- If a Weidmüller or other current limiting junction box is connected to this device, please ensure that the current limit is set to 40 mA or higher.

Basic PLC configuration with PROFIBUS PA

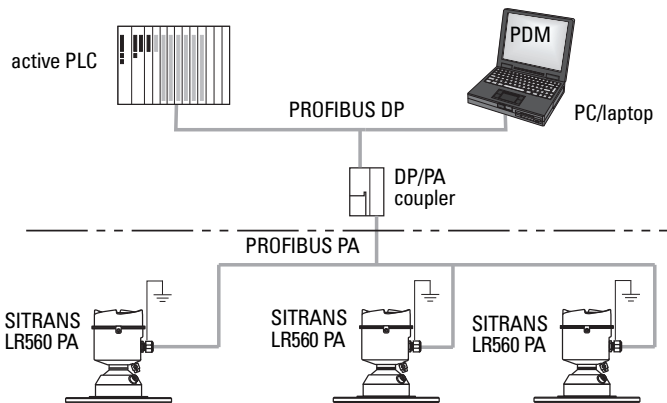

¹⁾ May be shipped with the device.

²⁾ The instrument shield connection is internally connected to the external ground lug.

Wiring setups for hazardous area installations

The following wiring options are available for hazardous area installations:

- *Non-Sparking/Energy Limited wiring (Europe) and Dust Ignition Proof wiring (Europe/International)* on page 25
- *Non-incendive and Dust Ignition Proof wiring (US/Canada)* on page 26

In all cases, check the device label on your instrument, and confirm the approval rating.

PLC configuration with PROFIBUS PA for hazardous areas

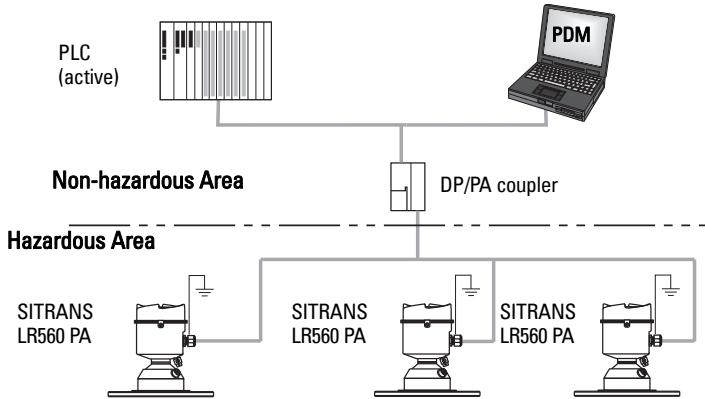

1. Non-Sparking/Energy Limited wiring (Europe) and Dust Ignition Proof wiring (Europe/International) Device label (ATEX/IECEx/C-TICK)

SIEMENS				
II 1D 1/2D 2D Ex ta IIIC T139°C Da SIRA 09ATEX9356X IECEx SIR 09.0149X Ex ta IIIC T139°C Da	SITRANS LR560 7MLxxxx-xxxx-xxxx Serial No: GYZ / A1034567 Enclosure: NEMA / TYPE 4x, 6, IP68 Amb. Temp.: -40 °C to 80 °C Input: 32 V $\frac{\square}{\square}$, Max., 13.5 mA 0518 N117 Siemens Milltronics Process Instruments Inc., Peterborough Made in Canada	 PROFIBUS PA	Sira 09ATEX4357X Ex nA II T4 Gc Un = 32 V Ex nL IIC T4 Gc FNICO: Entity: Ui = 17.5 V Ui = 32 V Ii = 570 mA Ii = 13.5 mA Pi = 7.98 W Ci < 5 nF Ci < 5 nF Li < 20 µH Li < 20 µH	II 3 G Potential Electrostatic Charging Hazard Do Not Clean With Dry Cloth Do Not Install Where Build-Up Of Charge Is Likely
Use Suitably Rated Cable De-Energize Before Removing Cover				

The ATEX certificate listed on the nameplate can be downloaded from the product page of our website at: www.siemens.com/LR560. Go to **Support > Approvals/Certificates**.

The IECEx certificate listed on the nameplate can be viewed on the IECEx website. Go to: <http://iecex.iec.ch> and click on **Ex Equipment Certificates of Conformity** then enter the certificate number IECEx SIR 09.0149X.

- For power demands see *Temperature De-Rating* on page 123.
- For wiring requirements follow local regulations.
- See also *Instructions Specific to Hazardous Area Installations* on page 26 and the ATEX certificate listed above.

2. Non-incendive and Dust Ignition Proof wiring (US/Canada) Device label (FM/CSA)

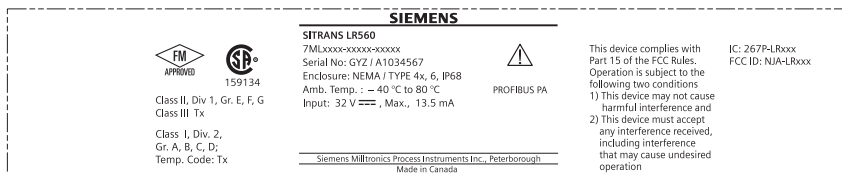

FM/CSA Class 1, Div 2 connection drawing number A5E02795836 can be downloaded from the product page of our website at: www.siemens.com/LR560 under **Support**.

- For power demands see *Temperature De-Rating* on page 123.

Instructions Specific to Hazardous Area Installations

(Reference European ATEX Directive 94/9/EC, Annex II, 1.0.6)

The following instructions apply to equipment covered by certificate numbers Sira 09ATEX9356X and Sira 09ATEX4357X:

- 1) For use and assembly and details of marking/coding, refer to the main instructions.
- 2) The equipment is certified for use as Category 1D, 1/2D and 2D equipment per certificate Sira 09ATEX9356X and may be used in hazardous zones 20, 21 and 22. The equipment is also certified for use as Category 3G equipment per certificate Sira 09ATEX4357X and may be used in hazardous zone 2.
- 3) This equipment has a maximum surface temperature of 139 °C (in an 80 °C ambient). Refer to the applicable code of practice for selection of this equipment with respect to specific dust ignition temperatures.
- 4) The equipment is certified for use in an ambient temperature range of -40 °C to 80 °C.
- 5) The equipment has not been assessed as a safety related device (as referred to by Directive 94/9/EC Annex II, clause 1.5).
- 6) Installation and inspection of this equipment shall be carried out by suitably trained and authorized personnel in accordance with the applicable code of practice.

- 7) The equipment shall be installed such that the supply cable is protected from mechanical damage. The cable shall not be subjected to tension or torque. The equipment manufacturer is not responsible for providing the supply cable.
- 8) Repair of this equipment shall be carried out by suitably trained and authorized personnel in accordance with the applicable code of practice.

Special Conditions for Safe Use

The 'X' suffix to the certificate number relates to the following special condition(s) for safe use:

- Parts of the enclosure may be non-conducting and may generate an ignition-capable level of electrostatic charge under certain extreme conditions. The user should ensure that the equipment is not installed in a location where it may be subjected to external conditions (such as high-pressure steam), which might cause a build-up of electrostatic charge on non-conducting surfaces.
- The end user must ensure that an ingress protection of at least IP65 is maintained at each entry to the enclosure by use of a blanking element or cable entry device that meets the requirements of the protection concepts type 'n' or increased safety 'e' or flameproof 'd'.
- The supply to the equipment shall be rated for a prospective short-circuit current of not more than 10 kA and shall be protected by a suitably-rated fuse.

Local Operation

SITRANS LR560 carries out its level measurement tasks according to settings made via parameters. The settings can be modified locally via the Local Display Interface (LDI) which consists of an LCD display with push buttons. You can use either the push buttons or an infrared handheld programmer to make changes.

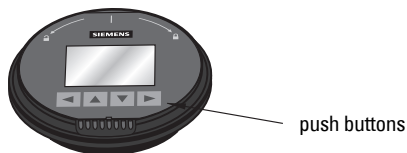

A Quick Start Wizard provides an easy step-by-step procedure to help you configure your device for a simple application. There are two ways to access the wizard:

- locally (see *Quick Start Wizard via the LDI push buttons* on page 34 or *Quick Start Wizard via the handheld programmer* on page 34)
- from a remote location (see *Quick Start Wizard via SIMATIC PDM* on page 40, or *Configuring a new device via FDT* on page 61)

See *Level application example* on page 38 for an illustration, and for the complete range of parameters, see *Parameter Reference* on page 62.

Activating SITRANS LR560

Notes:

- To enter Program mode using the push buttons, press ►. Press ◀ to return to Measurement mode.
- To toggle between Measurement and Program Mode using the handheld programmer, press **Mode** .

Power up the device. SITRANS LR560 automatically starts up in Measurement mode. A transition screen showing first the Siemens logo and then the current firmware revision is displayed while the first measurement is being processed. The first time the device is configured, you will be prompted to select a language (English, German, French, Spanish or Chinese). To change the language again, see **Language (7)** on page 101.

The LCD Display

Measurement mode

Normal operation

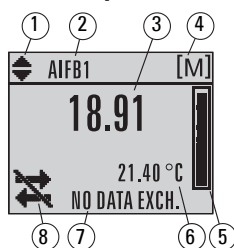

- 1 – toggle indicator¹⁾ for AIFB 1 or AIFB 2
- 2 – identifies which AIFB is source of displayed value
- 3 – measured value (level, space, or distance)
- 4 – units
- 5 – bar graph indicates level
- 6 – secondary region indicates on request²⁾ electronics temperature, echo confidence, or distance
- 7 – text area displays status messages
- 8 – device status indicator

Fault present



S: 0 LOE

- 7 – text area displays a fault code and an error message
- 8 – service required icon appears

PROGRAM mode display

Navigation view

- A visible menu bar indicates the menu list is too long to display all items.
- The depth of the item band on the menu bar indicates the length of the menu list: a deeper band indicates fewer items.
- The position of the item band indicates the approximate position of the current item in the list. A band halfway down the menu bar indicates the current item is halfway down the list.

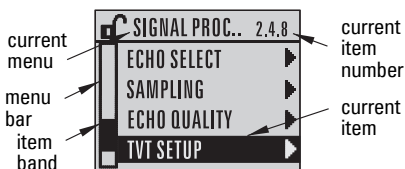

Parameter view

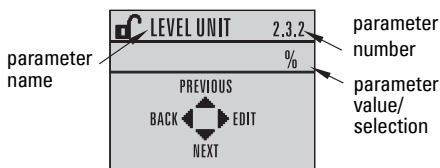

Edit view

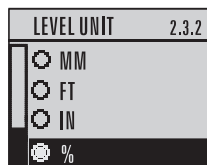

¹⁾ Press **UP** or **DOWN** arrow to switch.

²⁾ In response to a key press request. For details, see *Key functions in Measurement mode* on page 30.

Handheld Programmer

(Part No. 7ML1930-1BK)

The programmer is ordered separately.



Key functions in Measurement mode

Key	Function	Result
	Displays internal enclosure temperature reading.	New value is displayed in LCD secondary region.
	Displays echo confidence value ¹⁾ .	
	Displays distance measurement.	New value is displayed in LCD secondary region
	Mode opens PROGRAM mode.	Opens the menu level last displayed in this power cycle, unless power has been cycled since exiting PROGRAM mode or more than 10 minutes have elapsed since PROGRAM mode was used. Then top level menu will be displayed.
	RIGHT arrow opens PROGRAM mode.	Opens the top level menu.
 	UP or DOWN arrow toggles between AIFB 1 and AIFB 2.	Identifies which AIFB is the source of the displayed value.

¹⁾ See **Confidence (2.4.7.1.)** on page 74.

Programming SITRANS LR560

Notes:

- While the device is in PROGRAM mode the output remains active and continues to respond to changes in the device.
- SITRANS LR560 automatically returns to Measurement mode after a period of inactivity in PROGRAM mode (between 15 seconds and 10 minutes, depending on the menu level).

Change parameter settings and set operating conditions to suit your specific application. (For remote operation see *Operating via SIMATIC PDM* on page 39 or *Operating via FDT (Field Device Tool)* on page 61.)



Parameter menus

Note: For the complete list of parameters with instructions, see *Parameter Reference* on page 62

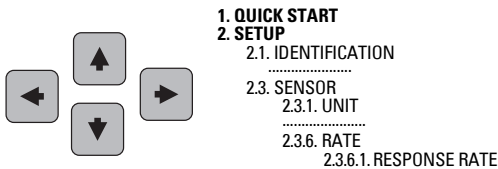
Parameters are identified by name and organized into function groups, then arranged in a 5-level menu structure (see *LCD menu structure* on page 151).



1. Enter PROGRAM mode



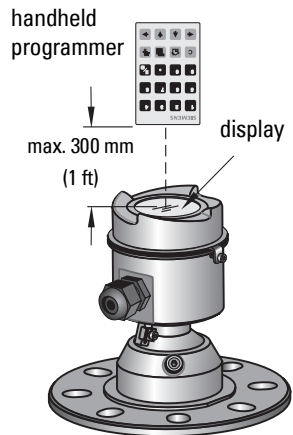



- Point the programmer at the display from a maximum distance of 300 mm (1 ft).
- **RIGHT arrow**  activates PROGRAM mode and opens menu level 1.
- **Mode**  opens the menu level last displayed in PROGRAM mode within the last 10 minutes, or menu level 1 if power has been cycled since then.



2. Navigating: key functions in Navigation mode



Notes:

- In Navigation mode **ARROW** keys move to the next menu item in the direction of the arrow.
- For Quick Access to parameters via the handheld programmer, press **Home** , then enter the menu number, for example: **3.1. Echo Profile**

Key	Name	Menu level	Function
 	UP or DOWN arrow	menu or parameter	Scroll to previous or next menu or parameter.
	RIGHT arrow	menu	Go to first parameter in the selected menu, or open next menu.
		parameter	Open Edit mode.
	LEFT arrow	menu or parameter	Open parent menu.
	Mode	menu or parameter	Change to MEASUREMENT mode.
	Home	menu or parameter	Open top level menu: menu 1.



3. Editing in PROGRAM mode

Selecting a listed option

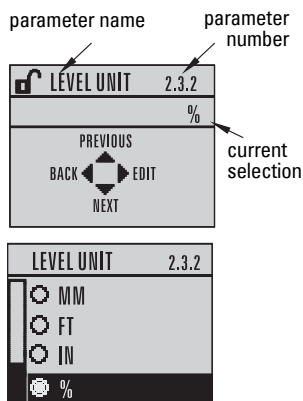
- Navigate to the desired parameter.
- Press **RIGHT arrow**  to open parameter view.
- Press **RIGHT arrow**  again to open **Edit** mode. The current selection is highlighted. Scroll to a new selection.
- Press **RIGHT arrow**  to accept it
The LCD returns to parameter view and displays the new selection.







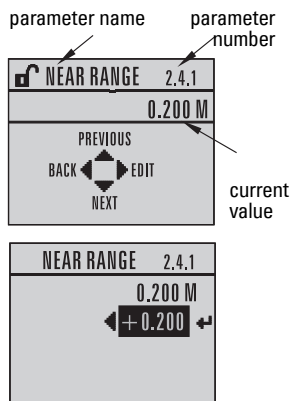



Changing a numeric value

- Navigate to the desired parameter.
- Press **RIGHT arrow**  to open parameter view. The current value is displayed.
- Press **RIGHT arrow**  again to open **Edit** mode. The current value is highlighted.
- Key in a new value.
- Press **RIGHT arrow**  to accept it. The LCD returns to parameter view and displays the new selection.



Key functions in Edit mode

Key	Name	Function	
 	UP or DOWN arrow	Selecting options	Scrolls to item.
		Alpha-Numeric editing	<ul style="list-style-type: none"> - Increments or decrements digits - Toggles plus and minus sign
	RIGHT arrow	Selecting options	<ul style="list-style-type: none"> - Accepts the data (writes the parameter) - Changes from Edit to Navigation mode
		Numeric editing	<ul style="list-style-type: none"> - Moves cursor one space to the right - or with cursor on Enter sign, accepts the data and changes from Edit to Navigation mode
	LEFT arrow	Selecting options	Cancels Edit mode without changing the parameter
		Numeric editing	<ul style="list-style-type: none"> - Moves cursor to plus/minus sign if this is the first key pressed - or moves cursor one space to the left. - or with cursor on Enter sign, cancels the entry
	Clear	Numeric editing	Erases the display.
	Decimal point	Numeric editing	Enters a decimal point.
	Plus or minus sign	Numeric editing	Changes the sign of the entered value.
 to 	Numeral	Numeric editing	Enters the corresponding character.

Quick Start Wizard via the LDI push buttons

- 1) Press **▶** to enter Program mode.
- 2) Choose **Quick Start (1.)**, and then **Quick Start Wizard (1.1.)**.
- 3) Follow the steps then choose **Finish** to save Quick Start parameter changes and return to Program menu, or press **◀** to return to Measurement mode.

To add or delete digits using the push buttons:

Note: When the Enter icon **↵** is highlighted, press **▲** to insert a digit on the right, **▼** to delete the right-most digit, **▶** to accept the value, or **◀** to cancel.

- 1) Navigate to the parameter you wish to modify and press **▶** to edit it. The value will be highlighted.
- 2) Press **▲** or **▼** to delete the highlighted value, or **◀** to modify the value from the left-most digit, starting with the plus/minus sign.
- 3) With the plus or minus sign highlighted, press **▲** or **▼** to change it. Press **▶** to highlight the next digit to the right.
- 4) Use **▲** or **▼** to modify the highlighted digit. Scroll past 9 to reach the decimal point.
- 5) When the value is complete, press **▶** until the Enter icon is highlighted **↵**, then press **▶** to accept the value.

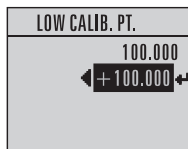

To modify a text string:

- 1) Navigate to the parameter you wish to modify and press **▶** to edit it. The string will be highlighted.
- 2) Follow the same steps as above, to add, delete, or modify characters.









Quick Start Wizard via the handheld programmer

Notes:

- The Quick Start wizard settings are inter-related and changes apply only after you choose **Finish** in the **Wizard Complete** step.
- Do not use the Quick Start wizard to modify individual parameters: see instead *Parameter Reference* on page 62. (Perform customization only after the Quick Start has been completed.)
- Default settings in the parameter tables are indicated with an asterisk (*).

1. Quick Start

1.1. Quick Start Wizard

- Point the programmer at the display from a maximum distance of 300 mm (1 ft) and press **RIGHT arrow**  to activate PROGRAM mode and open menu level 1.
- Press **RIGHT arrow**  twice, to navigate to menu item 1.1 and open the Quick Start Wizard.
- At each step, press **DOWN arrow**  to accept default values and move directly to the next item, or **RIGHT arrow**  to open Edit mode: the current selection is highlighted.
- Scroll to desired item and press **RIGHT arrow**  to store the change, then press **DOWN arrow**  to continue.
- At any time you can press **UP arrow**  to go back, or **LEFT arrow**  to cancel and return to Measurement mode.



Vessel

Select vessel construction material.

- Selecting either STEEL or CONCRETE does a functional reset (see **Master Reset (4.2)** on page 87).
- Selecting STEEL changes the setting for **Position Detect (2.4.5.2)** to Rising Edge and for **Algorithm (2.4.5.1)** to F.
- Selecting CONCRETE changes the setting for **Position Detect (2.4.5.2)** to Rising Edge and for **Algorithm (2.4.5.1)** to ALF.

Parameter View

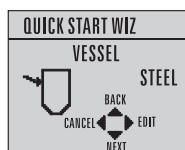

Edit mode

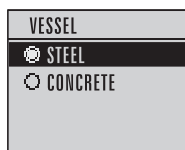

Options	*	STEEL
		CONCRETE

Response Rate

Sets the reaction speed of the device to measurement changes in the target range.

*Selecting SLOW changes setting for **Average amount (2.8.3)** to 0.9.*

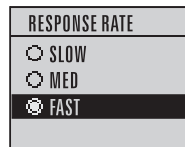
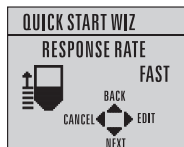

Response Rate		Vessel Fill/Empty rate/min	Filter Time Constant (2.5.8.1.)
SLOW		0.1 m/min (0.32 ft/min)	10 s
MED	*	1.0 m/min (3.28 ft/min)	10 s
FAST		10.0 m/min (32.8 ft/min)	0 s

Use a setting just faster than the maximum vessel filling or vessel emptying rate (whichever is greater).

Units

Sensor measurement units.

Options	M, CM, MM, FT, IN
	Default: M

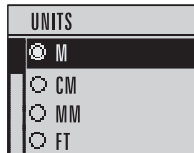
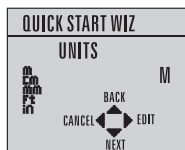

Operation

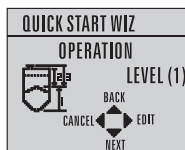

Operation	Description
LEVEL (1)	* Distance from Low Calibration Point to material surface.
SPACE (2)	Distance from High Calibration Point to material surface.
DISTANCE (3)	Distance from Sensor Reference Point to material surface.

sensor reference point
(flange face: see
Dimensions on page 12)

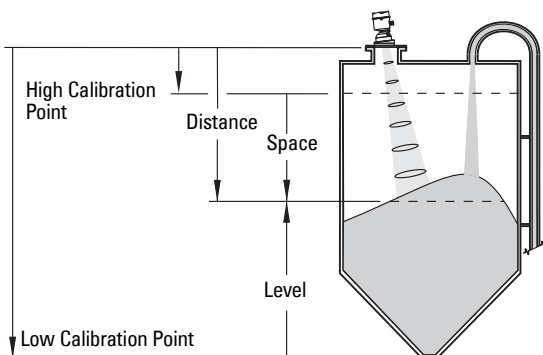

Low Calibration Point

Distance from Sensor Reference Point to Low Calibration Point: usually process empty level.

Values	Range: 0.0000 to 100.000 m
---------------	----------------------------

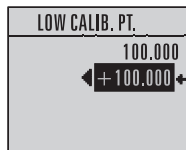
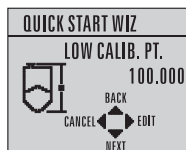

High Calibration Point

Distance from Sensor Reference Point to High Calibration Point: usually process full level.

Values	Range: 0.0000 to 100.000 m
---------------	----------------------------

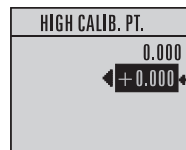

Wizard Complete

Options	BACK, CANCEL, FINISH (Display returns to 1.1 Quick Start Wizard menu when Quick Start is successfully completed.)
----------------	---







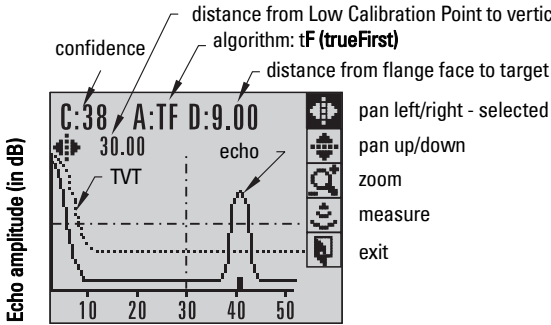
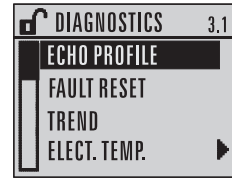

To transfer Quick Start values to the device and return to Program menu, press

DOWN arrow (**Finish**). Then press **LEFT arrow** to return to Measurement mode.

Requesting an Echo Profile

- In PROGRAM mode, navigate to: **Level Meter > Diagnostics (3.) > Echo Profile (3.1).**
- Press **RIGHT arrow**  to request a profile.





- Use **UP**  or **DOWN arrow**  to scroll to an icon. When an icon is highlighted that feature becomes active.
- To move a cross-hair, press **RIGHT arrow**  to increase the value, **LEFT arrow**  to decrease.
- To Zoom into an area, position the intersection of the cross-hairs at the center of that area, select **Zoom**, and press **RIGHT arrow** . Press **LEFT arrow**  to Zoom out.
- To update the profile, select **Measure** and press **RIGHT arrow** .
- To return to the previous menu, select **Exit** then press **RIGHT arrow** .

Device Address

Note: See *Master Reset* on page 55 to reset Device Address to 126.

The unique address of the device on the network (also called PROFIBUS address).

Values	0 - 126. Default: 126
---------------	-----------------------

- In PROGRAM mode, navigate to: **Level Meter > Communication (5.) > Device Address (5.1).**
- Press **RIGHT arrow**  twice to open parameter view and enable Edit mode.
- If required, key in a new value and press **RIGHT arrow**  to accept it. The LCD displays the new value.
- Press **Mode**  to return to Measurement mode.

Level application example

The application is a vessel that takes an average 3 hours (180 minutes) to fill and 3 weeks to empty.

$$\begin{aligned} \text{Fill rate} &= 0.08 \text{ m/minute} \text{ [(Low Cal Pt. minus High Cal Pt.) / fastest of fill or empty time]} \\ &= (15.5 \text{ m} - 1 \text{ m}) / 180 \text{ min.} \\ &= 14.5 \text{ m} / 180 \text{ min.} = 0.08 \text{ m/min.} \end{aligned}$$

Therefore SLOW response rate (0.1 m/minute) can be selected.

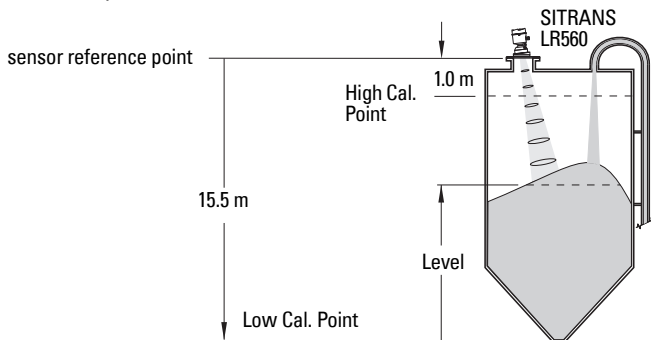

Quick Start Parameter	Setting	Description
Vessel	STEEL	Selects vessel construction material.
Response Rate	SLOW	Resets Fill Rate/ Empty Rate to 0.1 m/minute.
Units	M	Sensor measurement units.
Operation	LEVEL (1)	Material level referenced from Low Cal. Point.
Low Calibration Point	15.5	Process empty level.
High Calibration Point	1.0	Process full level.

Operating via SIMATIC PDM

SIMATIC PDM is a software tool used to commission and maintain SITRANS LR560 and other process devices. Please consult the operating instructions or online help for details on using SIMATIC PDM. (You can find more information at www.siemens.com/simatic-pdm.)

Functions in SIMATIC PDM

Notes:

- For a complete list of parameters see *Parameter Reference* on page 62.
- While the device is in PROGRAM mode the output remains active and continues to respond to changes in the device.

SIMATIC PDM monitors the process values, alarms and status signals of the device. It allows you to display, compare, adjust, verify, and simulate process device data; also to set schedules for calibration and maintenance.

Parameters are identified by name and organized into function groups. See *LCD menu structure* on page 151 for a chart¹⁾ and *Changing parameter settings using SIMATIC PDM* on page 44 for more details.

See *Parameters accessed via pull-down menus* on page 44 for parameters that do not appear in the menu structure in SIMATIC PDM.

SIMATIC PDM Version

Check the support page of our website to make sure you have the latest version of SIMATIC PDM, the most recent Service Pack (SP) and the most recent hot fix (HF). Go to:

<https://support.automation.siemens.com/WW/llisapi.dll?func=cslib.csinfo&lang=en&siteid=csius&aktprim=0&extranet=standard&vwreg=WW&objid=10806857&treeLang=en>

Electronic Device Description (EDD)

You can locate the EDD in Device Catalog, under **Sensors/Level/Echo/Siemens AG/SITRANS LR560**. The EDD revision must match the Firmware revision in the device.

To check it in PDM, go to **Level Meter > Identification > Device**.

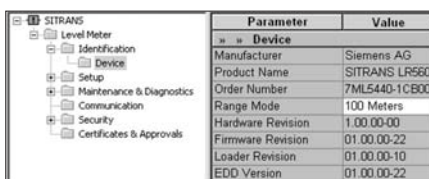

Parameter	Value
Manufacturer	Siemens AG
Product Name	SITRANS LR560
Order Number	7ML5440-1CB00
Range Mode	100 Meters
Hardware Revision	1.00.00.00
Firmware Revision	01.00.00.22
Loader Revision	01.00.00.10
EDD Version	01.00.00.22

matching
Firmware
and EDD
revisions

To install a new EDD



- 1) Go to www.siemens.com/LR560 > **Support > Software Downloads** to download the most up-to-date EDD from the product page of our website.
- 2) Save the files to your computer and extract the zipped file to an easily accessed location.
- 3) Launch **SIMATIC PDM – Manage Device Catalog**, browse to the unzipped EDD file and select it.

¹⁾ The menu structure for SIMATIC PDM is almost identical to that for the LCD.

Configuring a new device

Notes:

- Clicking on **Cancel** during an upload from device to SIMATIC PDM will result in some parameters being updated.
- Application Guides for setting up PROFIBUS PA devices with SIMATIC PDM can be downloaded from the product page of our website at: www.siemens.com/LR560.

- 1) Check that you have the most recent EDD, and if necessary update it (see *To install a new EDD* above).
- 2) Set Address via handheld programmer (default for PROFIBUS PA is 126). (See **Device Address (5.1)** on page 100, to use SIMATIC PDM.)
 - In PROGRAM mode, navigate to: **Level Meter > Communication (5.) > Device Address (5.1)**.
 - Press **RIGHT arrow**  twice, to open parameter view and enable Edit mode.
 - If required, key in a new value and press **RIGHT arrow**  to accept it. The LCD displays the new value.
 - Press **Mode**  to return to Measurement mode.
- 3) Launch SIMATIC Manager and create a new project for LR560.
- 4) Open the menu **Device – Master Reset** and click on **Factory Defaults**.
- 5) After the reset is complete click on **Close**, then upload parameters to the PC/PG.
- 6) Configure the device via the Quick Start wizard.

Set Address

Open the menu **Device – Set Address**, enter a value for **New Address**, and click on **Assign Address**.

Quick Start Wizard via SIMATIC PDM

The graphic Quick Start Wizard provides an easy step-by-step procedure that configures the device for a simple application.

Please consult the operating instructions or online help for details on using SIMATIC PDM.

- 1) If you have not already done so, check that you have the most up-to-date Electronic Device Description (EDD) for your instrument. (See *Electronic Device Description (EDD)* on page 39.)
- 2) Launch SIMATIC Manager and create a new project for LR560. Application Guides for setting up PROFIBUS PA devices with SIMATIC PDM can be downloaded from the product page of our website at: www.siemens.com/LR560.

Quick Start

Notes:

- The Quick Start wizard settings are inter-related and changes apply only after you click on **FINISH AND DOWNLOAD** at the end of the last step to save settings offline and transfer them to the device.
- Do not use the Quick Start Wizard to modify individual parameters: For quick access to echo profile parameters see *Echo Setup* on page 50, or see *Parameter Reference* on page 62 for a complete list. (Perform customization only after the Quick Start has been completed.)
- Click on **BACK** to return and revise setting or **CANCEL** to exit the Quick Start.
- For a vessel with obstructions see *Auto False Echo Suppression* on page 48.

Launch SIMATIC PDM, open the menu **Device – Wizard - Quick Start**, and follow steps 1 to 4.

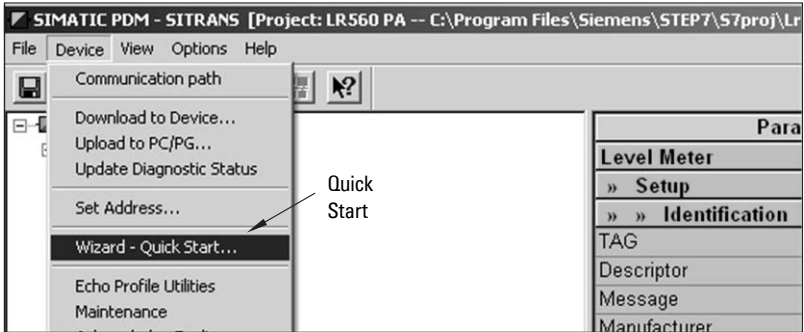

Step 1 – Identification

Note: The layout of the dialog boxes shown may vary according to the resolution setting for your computer monitor.

- 1) Click on **Read Data from Device** to upload Quick Start parameter settings from the device to the PC/PG and ensure PDM is synchronized with the device.
- 2) Click on **NEXT** to accept the default values. (Descriptor, Message, and Date fields can be left blank.)



Step 2 – Application Type

Notes:

- Selecting either STEEL or CONCRETE does a functional reset (see **Master Reset (4.2)** on page 87).
- Selecting STEEL changes the setting for **Position Detect (2.4.5.2)** to Rising Edge. and for **Algorithm (2.4.5.1)** to F.
- Selecting CONCRETE changes the setting for **Position Detect (2.4.5.2)** to Rising Edge and for **Algorithm (2.4.5.1)** to ALF.

- 1) Select the application type: steel or concrete vessel. [This changes the setting for **Position Detect (2.4.5.2)** to Rising Edge.]
- 2) Click on **NEXT**.

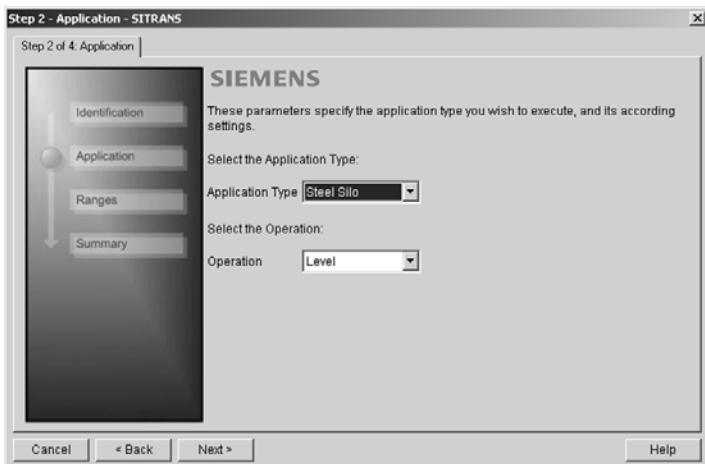

Step 3 – Range

Note: Selecting SLOW Response Rate changes setting for **Average amount (2.8.3.)** to 0.9.

Set the parameters, and click on **NEXT**.

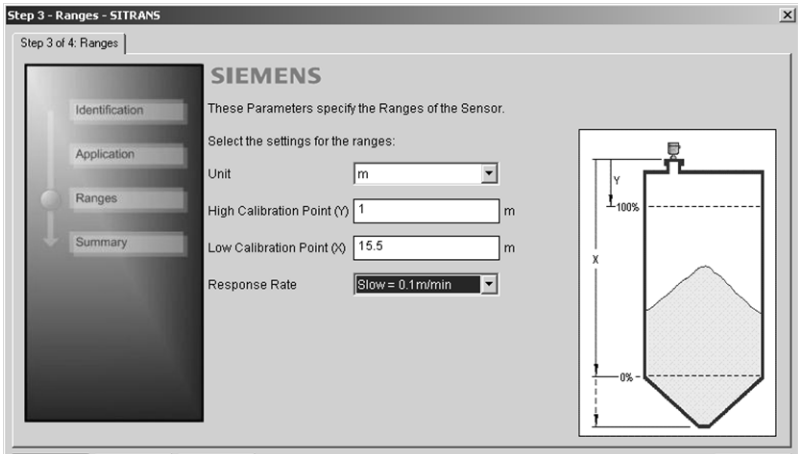

Step 4 – Summary

Check parameter settings, and click on **BACK** to return and revise values, **FINISH** to save settings offline, or **FINISH AND DOWNLOAD** to save settings offline and transfer them to the device.

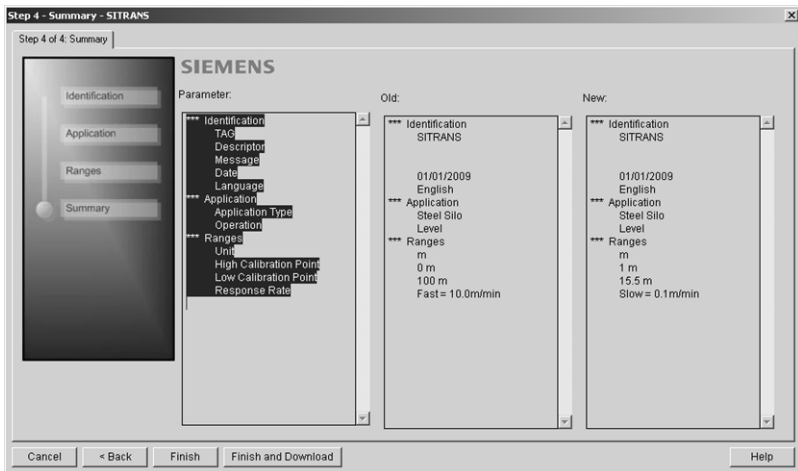

The message **Quick Start was successful** will appear. Click on **OK**.

Changing parameter settings using SIMATIC PDM

Notes:

- For a complete list of parameters, see *Parameter Reference* on page 62.
- Clicking on **Cancel** during an upload from device to SIMATIC PDM will result in some parameters being updated.

Many parameters are accessed via the 5-level menu in PDM. See *Parameters accessed via pull-down menus* on page 44 for the others.

- 1) Launch SIMATIC PDM, connect to SITRANS LR560, and upload data from the device.
- 2) Adjust parameter values in the parameter value field then press **Enter**. The status fields read **Changed**.
- 3) Open the Device menu, click on **Download to Device**, then use **File – Save**, to save parameter settings. The status fields are cleared.

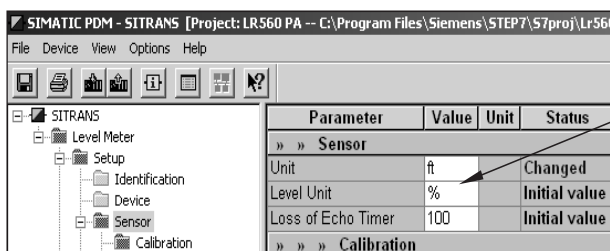

value fields

Parameters accessed via pull-down menus

You have access to a number of functions via pull-down menus from the menu bar, under **Device** or **View**.

For a complete list, see *Pull-down menus* on page 45.

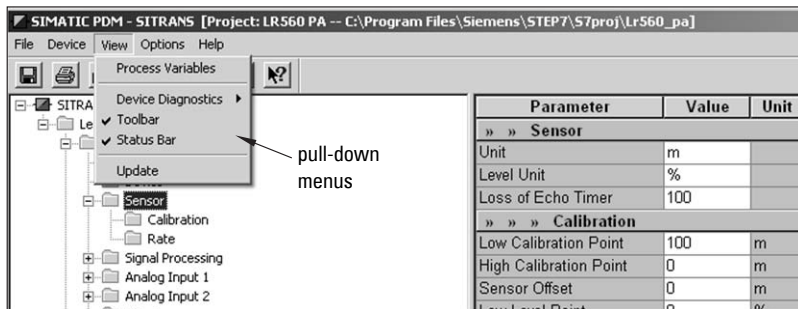

pull-down menus

Pull-down menus

Device menus	page	View menus	page
Communication path		Process Variables	56
Download to device Upload to PC/PG Update Diagnostic Status		Device Diagnostics	57
Set Address	40	Toolbar Status bar	
Wizard - Quick Start	41	Update	
Echo Profile Utilities	45		
Maintenance	50		
Acknowledge Faults	51		
Wear	51		
Simulation	52		
Write Locking	54		
Master Reset	55		

Echo Profile Utilities

Open the menu **Device – Echo Profile Utilities** and click on the appropriate tab for easy access to:

- *Echo profile* on page 46
- *Echo profile data logging* on page 46 (via *Echo profile* tab)
- *View Saved Echo Profiles* on page 46
- *TVT Shaper* on page 47
- *Auto False Echo Suppression* on page 48
- *Echo Setup* on page 50

Echo profile

Notes:

- Double click on each axis to see the Xscale and Data Scale values. Right-click or Left-click on the axis and drag to reposition the scale.
- After saving a profile click on **Close**, not the **x** button, to close the Echo Profile Utilities window, otherwise the profile will not be saved.

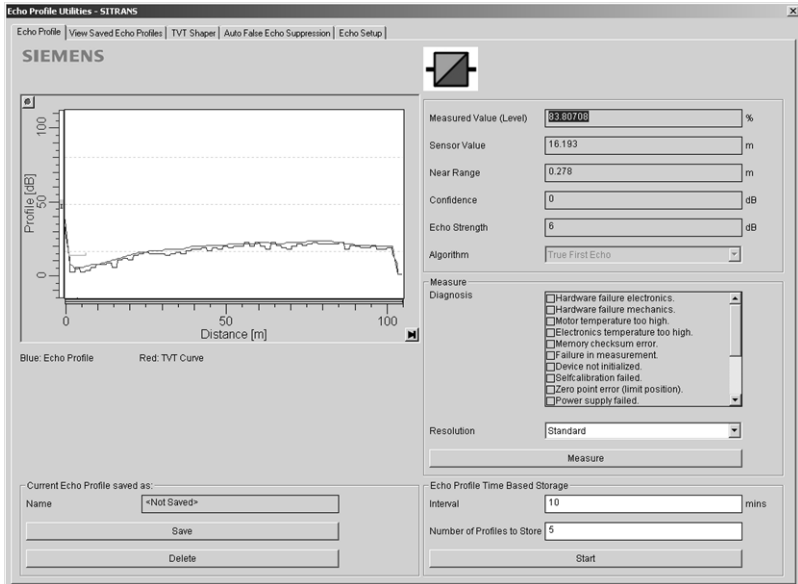

- In the **Echo Profile Utilities** window click on the tab **Echo Profile**.
- Click on the **Measure** button to update the profile. Select Standard Resolution to update the profile faster. Detailed Resolution uploads all data points.
- Click on the **Save** button and in the new window enter a name (maximum 50 characters) and click on **OK**.
- Click on **Close** to exit.

Echo profile data logging

You can store up to 60 profiles at a selected interval (maximum 60 minutes).

Inside Echo Profile Utilities, in the **Echo Profile Time Based Storage** group:

- Enter the desired interval between stored profiles.
- Enter the desired number of profiles to be stored (maximum 60).
- Click on **Start**. A message appears warning of the time delay and warning that all previous saved profiles will be overwritten. Click on **OK** to proceed. The new profiles will be saved with their date and time.
- Click on the tab **View Saved Echo Profiles** to view the stored profiles

View Saved Echo Profiles

To view a saved profile, click on the tab **View Saved Echo Profiles**.

TVT Shaper

Note: Double click on each axis to see the Xscale and Data Scale values. Right-click or Left-click on the axis and drag to reposition the scale.

This feature allows you to manually adjust the TVT to avoid false echoes caused by obstructions. (For an explanation see *Auto False Echo Suppression (2.4.8.1.)* on page 118.)

Open the menu **Device – Echo Profile Utilities** and click on the tab **TVT Shaper**.

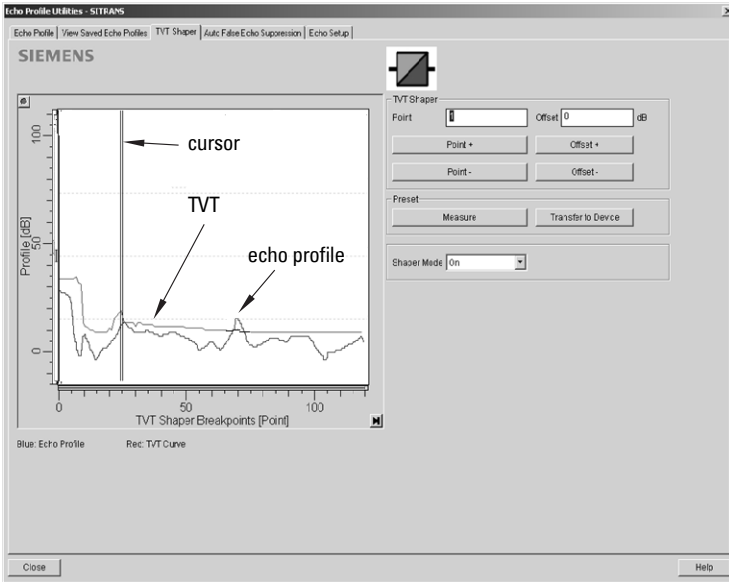

- Turn Shaper Mode **On**.
- Click on **Measure** to refresh the echo profile and load the current TVT from the device.
- Change the position of the cursor on the TVT using the **Point+** and **Point-** buttons: raise and lower the TVT using **Offset+** and **Offset-**.
- Alternatively, enter values for **Point** and **Offset** directly into the dialog boxes.
- Click on **Transfer to Device**.

Auto False Echo Suppression

Notes:

- Make sure material level is below all known obstructions at the moment Auto False Echo Suppression is used to learn a custom TVT (Time Varying Threshold). We recommend an empty or almost empty vessel.
- Note the distance to material level when the environment is learned, and set Auto False Echo Suppression Range to a shorter distance to avoid the material echo being screened out.

If you have a vessel with known obstructions, we recommend using Auto False Echo Suppression to prevent false echo detection. This feature can also be used if the device displays a false high level, or the reading is fluctuating between the correct level and a false high level.

The device learns the echo profile over the whole measurement range and the TVT is shaped around all echoes present at that moment. (See *Auto False Echo Suppression (2.4.8.1)* on page 118 for a more detailed explanation.)

The learned TVT will be applied over a specified range. The default TVT is applied over the remainder of the measurement range.

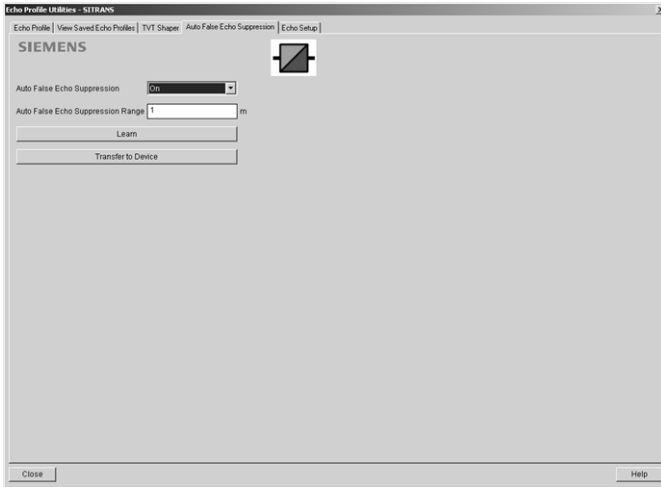

- 1) Make sure the material level is below all known obstructions.
- 2) Determine **Auto False Echo Suppression Range**. Measure the actual distance from the sensor reference point to the material surface using a rope or tape measure. Subtract 0.5 m (20") from this distance, and use the resulting value.

- 3) Open the menu **Device – Echo Profile Utilities** and click on the tab **Auto False Echo Suppression**.
- 4) Make sure **Auto False Echo Suppression** is **On**.
- 5) Enter the value for **Auto False Echo Suppression Range**.
- 6) Click on **Learn**. The message appears: **'This will learn a new echo profile. Once done it cannot be undone'**. Click on **OK**.
- 7) Once 'Auto TVT Learn' is complete, click on **Transfer to Device**. To exit, click on **Close**. Auto TVT is enabled and the learned TVT will be used.
- 8) To turn Auto False Echo Suppression off or on, reopen the **Auto False Echo Suppression** window and click on **Off** or **On**.

Before Auto False Echo Suppression

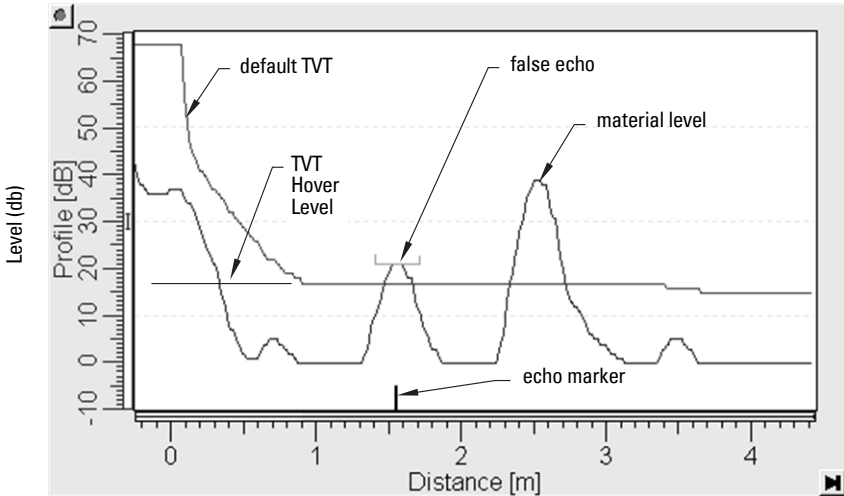

After Auto False Echo Suppression

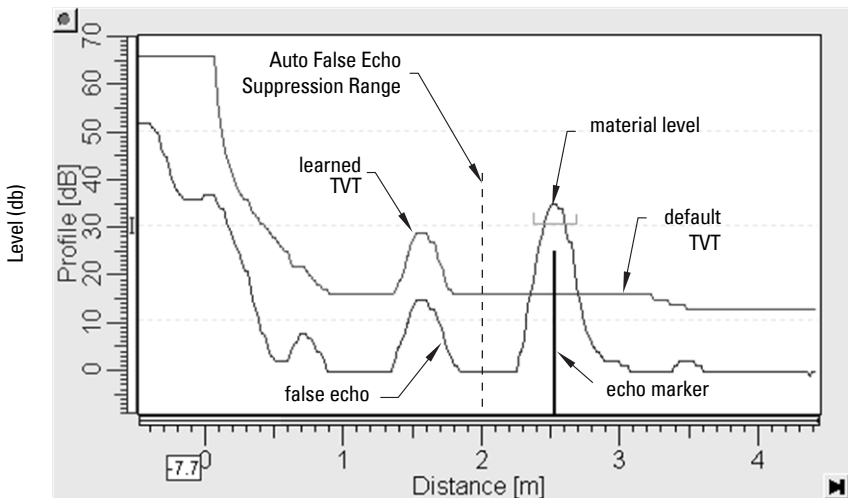

Echo Setup

Provides quick access to echo selection, filtering, and response rate parameters.

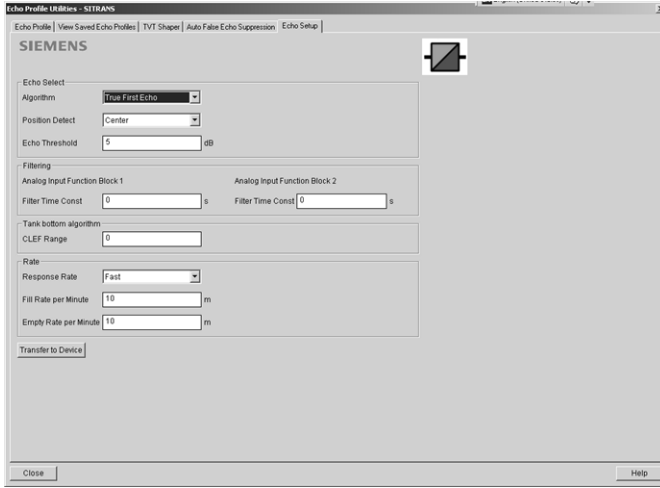

Open the menu **Device – Echo Profile Utilities** and click on **Echo Setup**.

Maintenance

You can set schedules for:

- maintenance of the device based on its projected lifetime
- maintenance of the sensor based on its projected lifetime
- service
- calibration

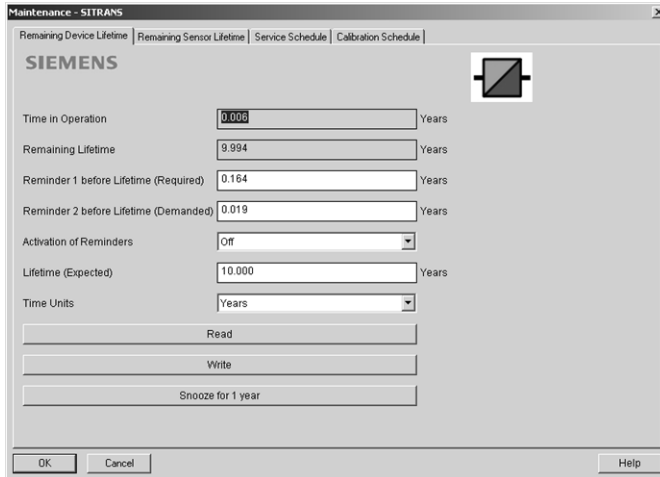

To set Device/Sensor Maintenance schedules:

- 1) Open the menu **Device – Maintenance**, and click on the **Remaining Device/Sensor Lifetime** tab.
- 2) Modify desired values, and if desired, activate reminders for either or both of **Reminder 1 (Required)/Reminder 2 (Demanded)**.
- 3) Click on **Write**.
- 4) Click on **Read**, to see the effects of your modification.
- 5) Click on **Snooze** to add a year to the Total Expected Device Life.

To set Service/Calibration schedules:

- 1) Open the menu **Device – Maintenance**, and click on the **Service/Calibration Schedule** tab.
- 2) Modify desired values, and if desired, activate reminders for either or both of **Reminder 1 (Required)/Reminder 2 (Demanded)**.
- 3) Click on **Write**.
- 4) Click on **Read**, to see the effects of your modification.
- 5) Click on **Service/Calibration Performed** to reset the schedule.

Acknowledge Faults

Open the menu **Device – Acknowledge Faults**, select the appropriate item from the Extended Diagnostics pull-down menu, and click on **Transfer**.

Wear

Reports the number of hours the device has been operating, and the number of times it has been powered up.

Open the menu **Device – Wear** to view:

- Powered Hours
- Power-on Resets

Analog Input Function Blocks

AIFB1 and AIFB2 Output Conversion

Two identical, independent Analog Input Function Blocks allow you to modify the output to the LCD and the control system by:

- input scaling
- output scaling
- setting alarms and warnings
- selecting display units, damping
- defining the response to a Fail-safe condition

Go to **Level Meter > Setup > Analog Input 1** (or **Analog Input 2**) for access to these parameters. (See *AIFB (simulation, mode and status)* on page 127 for detailed explanations.)

You can also simulate input and output values, accessed via pull-down menus: see *Simulation* on page 52.

Simulation

Notes:

- The Simulation parameter influences output to the control system.
- Make sure that simulation is disabled after simulation is complete.

For more details see *AIFB (simulation, mode and status)* on page 127.

Simulate Analog Input to AIFB1 or AIFB2

You can test your device configuration by simulating the sensor value and status being fed into the Analog Input Function Block, to ensure that your sensor calibration has been correctly carried out for your application.

- 1) Open the menu **Device – Simulation**, and select the desired function block.
- 2) Click on the tab **Simulation (Measured value)**.

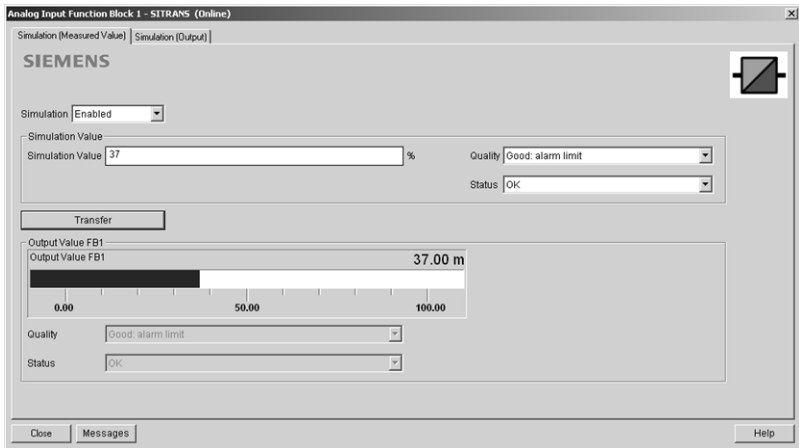

- 3) Enable simulation, enter a value in sensor units, set the desired quality and status¹⁾, and click on **Transfer**.
- 4) The substitute Output value is displayed in PDM and on the LCD display, in units defined for the function block in question. See *Simulate Output* below, to set the output mode.
- 5) After simulation is complete, disable simulation and click on **Transfer**.

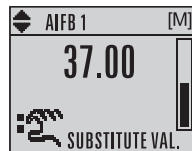

¹⁾ See *Status Byte* on page 132 for more information on status and quality.

Simulate Output

Manual (user-defined value)

- 1) Open the menu **Device – Simulation**, select function block 1 or 2, and click on the tab Simulation (Output).

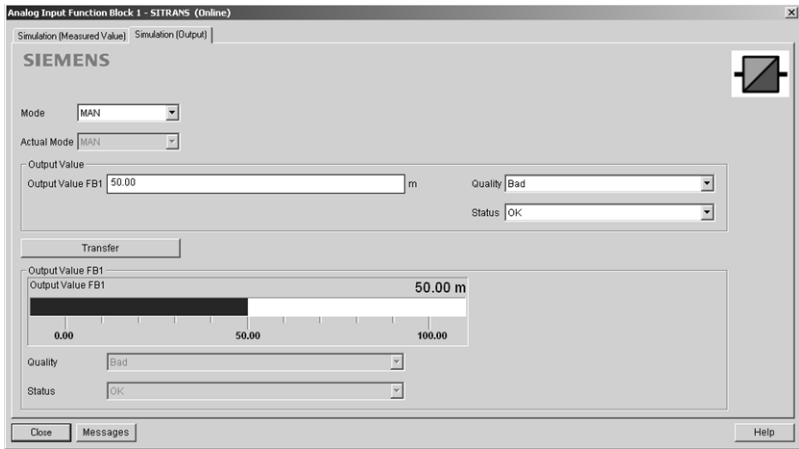

- 2) Select Manual Mode (from options AUTO, Manual, or Out of Service) and click on **Transfer**.
- 3) Enter simulated value and click on **Transfer**.
- 4) After simulation is complete, return to Simulate Output, reselect AUTO mode, and click on **Transfer**.

Out-of-Service

In Out of Service mode, an out of service status is associated with the value, telling the master that the value is invalid. This feature can be used during maintenance.

- 1) Open the menu **Device – Simulation**, select function block 1 or 2, and click on the tab Simulation (Output).
- 2) Select Out of Service Mode and click on **Transfer**.
- 3) After maintenance is complete, return to Simulate Output, reselect AUTO mode, and click on **Transfer**.

Simulate Input

Allows you to simulate the sensor value which is input to the Level Transducer Block. This tests everything between the Level Transducer Block and Output.

Ramp start	Range: –999999 to 999999. Default: 0
Ramp end	Range: –999999 to 999999. Default: 0
Number of steps	Range: 0 to 65535. Default: 1
Step length	Range: 0 to 65535. Default: 1

- 1) Open the menu **Device – Simulation**, and select **Simulation (Input)**.

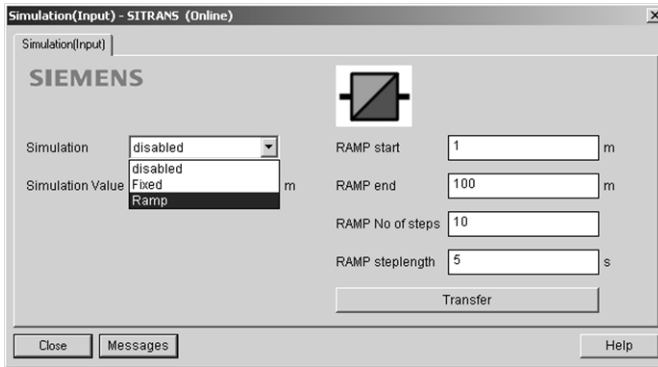

- 2) To enable simulation, select **Fixed** or **Ramp**.
- 3) If you select **Ramp**, enter the step length and number of steps.
- 4) Enter the simulated value and click on **Transfer**.
- 5) After simulation is complete, disable simulation and click on **Transfer**.

Write Locking

Prevents any changes to parameters via PDM or the hand-held programmer. If Write Locking is enabled, the data can be viewed but not modified.

To enable/disable Write Protection:

- 1) Open the menu **Device – Write Locking** and turn Write Protection **On** or **Off**.
- 2) Click on **Transfer**.

Master Reset

Notes:

- Following a reset, some degree of reprogramming may be required, depending on the option chosen below.
- While performing any reset, a loss of communications can be expected.

Options	Result
Factory Defaults	Resets all parameters to the manufacturer's default settings, with certain exceptions. The list of exceptions includes, but is not limited to: <ul style="list-style-type: none">• Message• Descriptor• Installation Date• Device Address• Write Protection• Auto False Echo Suppression Range• Learned TVT• Language
Standard Defaults	Resets all parameters, excluding device addresses and Language, to the PROFIBUS default settings. NOTE: After initiating a reset to Standard Defaults via the local user interface, allow 1-2 minutes before initiating a new command locally.
Informational	Resets parameters such as Tag.
Functional	Resets parameters that control device behavior, such as Low Calibration Pt.
Warm Start	Has the same effect as recycling power to the device
Device Address	<ul style="list-style-type: none">• Resets the PROFIBUS device address to 126• If the address lock was on, will disable the lock.

To perform a reset to Factory Defaults:

- 1) Open the menu **Device – Master Reset**, and click on **Factory Defaults**.
- 2) After the reset is complete click on **Close**, then upload parameters to the PC/PG. (If you are performing a reset after replacing the device with a different instrument, do not upload parameters to the PC/PG.)

To reset the PROFIBUS address to 126:

- 1) Open the menu **Device – Master Reset** and click on **Reset Address to '126'**.
- 2) Click on **OK**: the address will be reset to 126, and if the address lock was on, it will be disabled.

Diagnostics

You can monitor level/volume trends, function blocks, electronics temperature, and device status.

Process Variables

To compare outputs in real time open the menu **View – Process Variables**.

Process Variables

Note: To view peak sensor values, peak FB1 and FB2 values, or peak electronics temperatures, see *Device Diagnostics* on page 57.

- Sensor Value and simulation setting
- Electronics temperature
- Measured Value (level, volume¹⁾, and distance) together with quality and status.

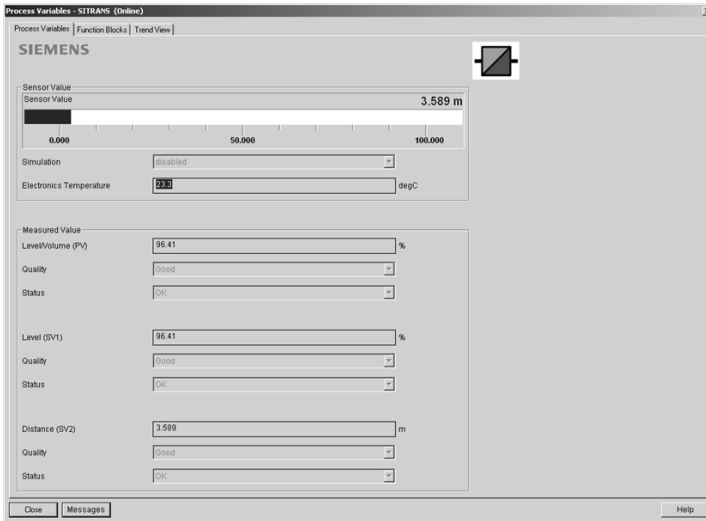

¹⁾ Not supported by LR560.

Function Blocks

Open the menu **View – Process Variables** and click on **Function Blocks** to view the channel (level or distance), operating mode (Auto, Manual, or Out of Service), quality, status, simulation setting, and summary of alarms.

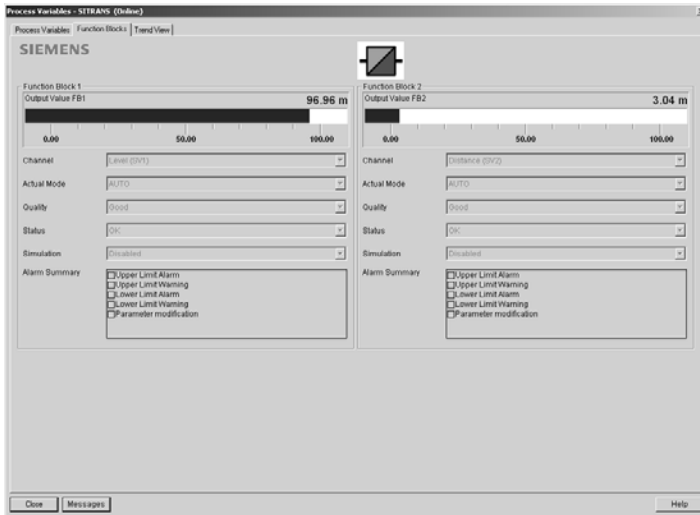

Trend View

Open the menu **View – Process Variables** and click on **Trend View** to monitor Sensor Value and values for AIFB1 and AIFB2.

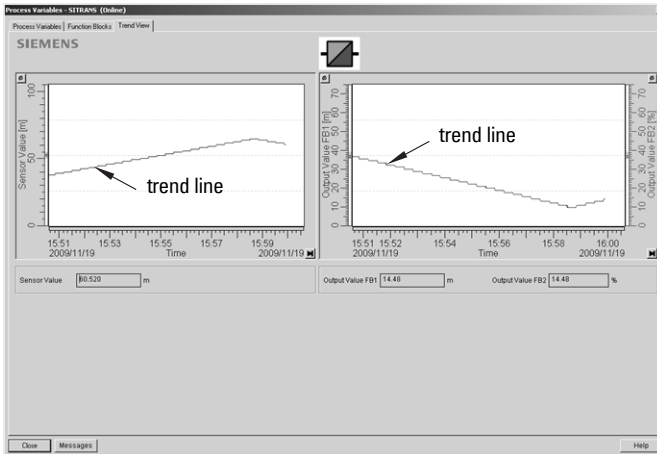

Device Diagnostics

Device Status

Open the menu **View - Device Diagnostics > Device Status** to view Diagnostics, Device Status, Extended Diagnostics, and Maintenance

Diagnostics

In the Device Status window, click on the **Diagnostics** tab, then on the **Update diagnostics** button, to update diagnostic information and refresh linked icons.

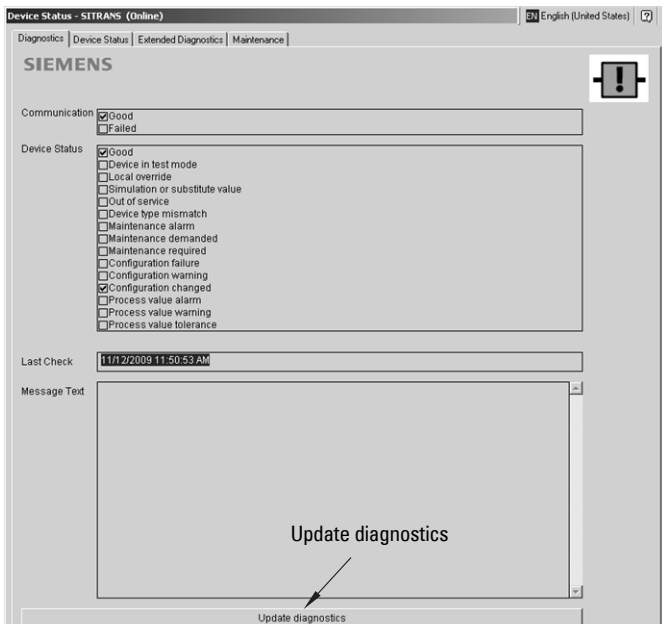

Device Status

Click on the **Device Status** tab to view peak sensor values, peak FB1 and FB2 values, and peak electronics temperatures.

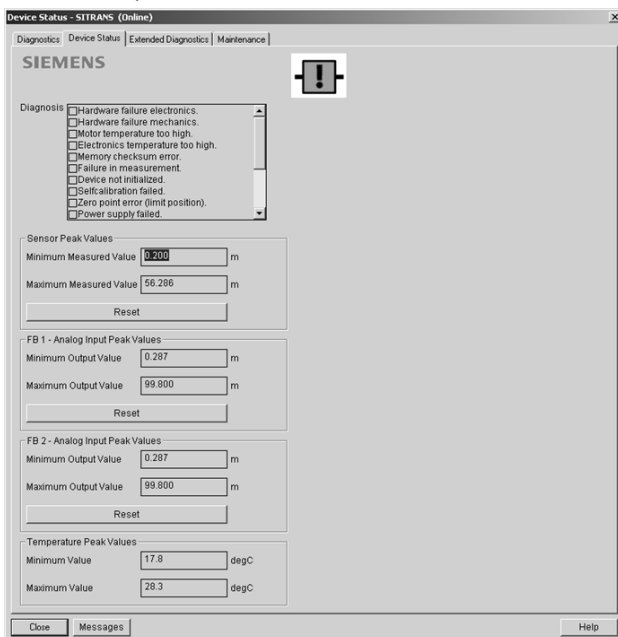

Analog Input 1/Analog Input 2

Open the menu **View – Device Diagnostics** and go to **Analog Input 1/Analog Input 2**. Click on the tab **Overview** to see the status of all warnings and alarms. Click on the tab **Alarms and Warnings** for details.

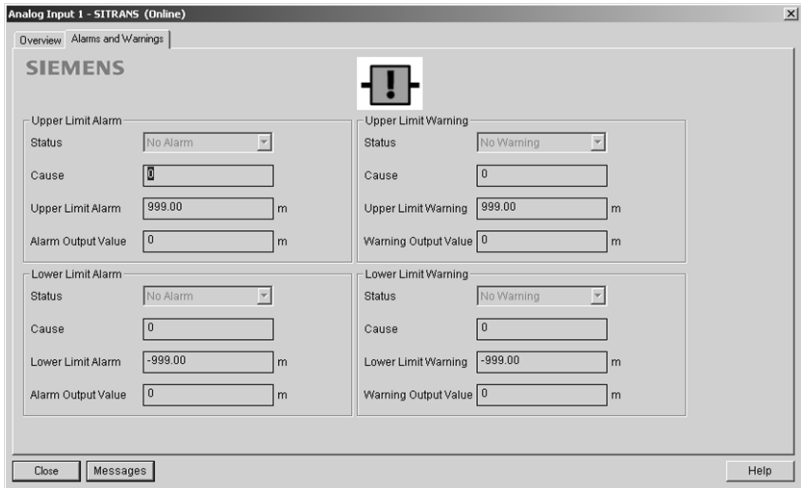

Update

Open the menu **View – Update** to refresh the screen.

Security

A password option protects security and communication control parameters from modification by a maintenance user.

When you open a project the **User** dialog window provides two options: maintenance or specialist. If a password has been set it will not be possible to open the project as a specialist without it. A maintenance user will be able to open the project without a password but will not have access to security and communication control parameters.

- 1) Open a project, double-click on the device icon, and in the **User** window select **Specialist**.
- 2) Open the menu **Options – Settings** and click on the **Password** tab.

- 3) Enter a new password and re-enter it in the **Confirmation** window. Click on **OK**.



The image shows a screenshot of the 'SIMATIC PDM settings' dialog box. The 'Password' tab is selected, and the 'User' tab is also visible. The dialog box contains three input fields for password entry: 'Old Password:', 'New Password:', and 'Confirmation:'. At the bottom of the dialog box, there are three buttons: 'OK', 'Cancel', and 'Help'.

SIMATIC PDM settings

User Password Table Font Communication Log Maintenance Station

Old Password:

New Password:

Confirmation:

OK Cancel Help

Operating via FDT (Field Device Tool)

FDT is a standard used in several software packages designed to commission and maintain field devices such as SITRANS LR560. Two commercially available FDTs are PACTware and Fieldcare.

Functionally FDT is very similar to PDM (see *Operating via SIMATIC PDM* on page 39 for more detail).

- To configure a field device via FDT you need the DTM (Device Type Manager) for the device.
- To configure a field device via SIMATIC PDM, you need the EDD (Electronic Device Description) for the device.

Device Type Manager (DTM)

A DTM is a type of software that 'plugs into' FDT. It contains the same information as an EDD but an EDD is independent of the operating system.

SITRANS DTM

- SITRANS DTM is an EDDL interpreter developed by Siemens to interpret the EDD for that device.
- To use SITRANS DTM to connect to an instrument, you must first install SITRANS DTM on your system and then install the instrument EDD written for SITRANS DTM.
- You can download SITRANS DTM from the Siemens service and support website at: <http://support.automation.siemens.com>. Click on **Product Support** then go to **Product Information/Process Instrumentation/Software & Communications**.

The instrument EDD

The SITRANS LR560 PROFIBUS PA EDD for SITRANS DTM can be downloaded from the product page of our website.

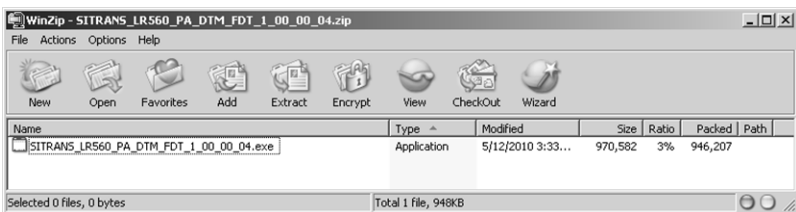





Go to www.siemens.com/LR560 under **Support** and click on **Software Downloads**.

Configuring a new device via FDT

The full process to configure a field device via FDT is outlined in an application guide which can be downloaded from the product page of our website. Go to: www.siemens.com/LR560 under **Support** and click on **Application Guides**.

Parameter Reference

Notes:

- Parameter names and menu structure are similar but not identical for SIMATIC PDM and the local display (LCD). This chapter follows the LCD menu structure, and the navigation path is provided to parameters that have a different location in SIMATIC PDM.
- Default settings in the parameter tables are indicated with an asterisk (*) unless explicitly stated.
- To enter Program mode using the device buttons, press . Press  to return to Measurement mode.
- To enter PROGRAM mode/return to Measurement mode via the handheld programmer, press **Mode** .
- For Quick Access to parameters via the handheld programmer, press **Home** , then enter the menu number, for example: **2.2.1**.





- In Navigation mode, **ARROW keys** navigate the menu in the direction of the arrow.
- Press **RIGHT Arrow** to open **Edit Mode**, or to save a modification.

Parameters are identified by name and organized into function groups. See *LCD menu structure on page 151* for a chart.

Parameters accessible via the handheld programmer are preceded by a number. Parameters not preceded by a number are accessible only via remote operation. For more details see *Operating via SIMATIC PDM on page 39*, or *Operating via FDT (Field Device Tool) on page 61*.

1. Quick Start

Wizards provide step-by-step procedures to configure the device, filter out false echoes, and upload and download parameters and firmware to the optional display for easy configuration of multiple LR560s.

Press **RIGHT arrow**  twice to open the Wizards menu. Select a wizard, press **RIGHT arrow**  to open the first step, and follow the instructions.

1.1. Quick Start Wizard

The Quick Start wizard provides an easy step-by-step procedure to configure the device for a simple application.

Note: Do not use the Quick Start wizard to modify individual parameters. (Perform customization only after the Quick Start has been completed.)

- See *Quick Start Wizard via the LDI push buttons on page 34*.
- See *Quick Start Wizard via the handheld programmer on page 34*.
- See *Quick Start Wizard via SIMATIC PDM on page 40*.

1.2. AFES (Auto False Echo Suppression) Wizard

Notes:

- Before using AFES, configure the device via the Quick Start wizard.
- Make sure material level is below all known obstructions at the moment Auto False Echo Suppression is used to learn a custom TVT (Time Varying Threshold). We recommend an empty or almost empty vessel.
- Note the distance to material level when the environment is learned, and set Auto False Echo Suppression Range to a shorter distance to avoid the material echo being screened out.

If you have a vessel with known obstructions, we recommend using AFES to prevent false echo detection.

This feature can also be used if SITRANS LR560 displays a false high level, or the reading is fluctuating between the correct level and a false high level.

a) Make sure the material level is below all known obstructions.

b) Navigate to **Level Meter > Diagnostics (3.) > Echo Profile (3.1.)** and press **RIGHT arrow**  to request a profile.

c) Determine a range that includes the false echo but not the true echo: in the example, 3.3 m.

d) Open the AFES wizard and press **DOWN arrow**  to continue.

e) Press **RIGHT arrow**  to edit Auto False Echo Suppression Range.



f) Enter the new range value and press **RIGHT arrow**  to transfer it.

g) Press **DOWN arrow**  to initiate Learn. A transition screen appears, followed by the message **Wizard Complete**.

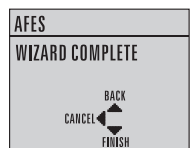
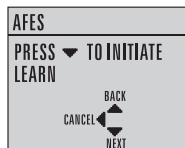
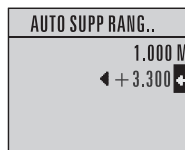
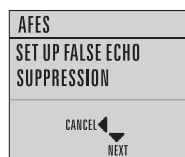
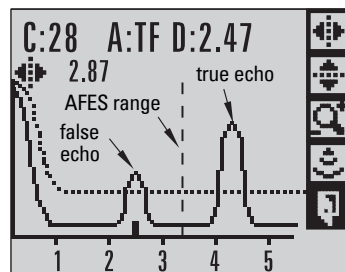
h) Press **DOWN arrow**  (**Finish**) to save AFES parameter changes and return to Program menu.



(continued on next page)

- i) Navigate to **Echo Profile (3.1.)** and press **RIGHT arrow**  to request a profile. The false echo is now screened out and the true echo selected. With Exit icon selected, press **RIGHT arrow**  to exit.
- j) Press **LEFT arrow**  twice to return to Measurement mode

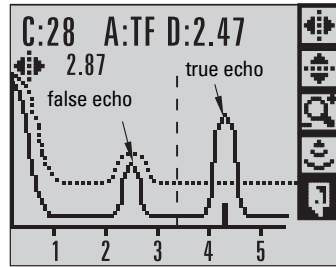

1.3. Copy Parameters to Display



See *Connecting SITRANS LR560* on page 23 for instructions on removing the local display interface.

Transfers parameter settings from a device to the local display interface.

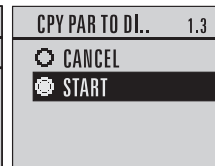
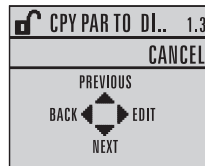

- Press **RIGHT arrow**  to Edit.
- Press **DOWN arrow**  to select
- Start** and **RIGHT arrow**  to begin the transfer.



PARAM UPLOAD is displayed, then the device returns to Measurement mode.

1.4. Copy Parameters from Display

Transfers parameter settings from the local display interface to a device.

- Press **RIGHT arrow**  to Edit.
- Press **DOWN arrow**  to select
- Start** and **RIGHT arrow**  to begin the transfer.

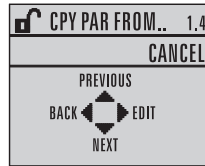

PARAM DOWNLOAD is displayed, then the device returns to Measurement mode.

1.5. Copy Firmware to Display

Transfers firmware from a device to the local display interface.

- Press **RIGHT arrow**  to Edit.
- Press **DOWN arrow**  to select
- Start** and **RIGHT arrow**  to begin the transfer.

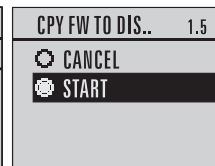
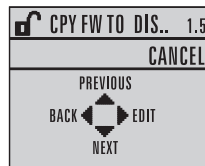



SW UPLOAD is displayed during the transfer, then the device returns to Measurement mode.

1.6. Copy Firmware from Display

Note: Do not interrupt power supply during transfer.

Transfers firmware from the local display interface to a device.

- Press **RIGHT arrow**  to Edit.
 - Press **DOWN arrow**  to select
- Start** and **RIGHT arrow**  to begin the transfer.

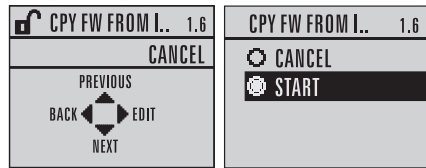

SW DOWNLOAD is displayed at the beginning of the transfer. This is followed first by a blank screen (for approximately 2 minutes), then by a progress indicator, and then by the Siemens logo with the LOE icon. When the transfer is complete, the device returns to Measurement mode.

2. Setup

Notes:

- Default settings in the parameter tables are indicated with an asterisk (*) unless explicitly stated.
- Values shown in the following tables can be entered via the handheld programmer.

2.1. Identification

2.1.1. Tag

Text that can be used in any way. A recommended use is as a unique label for a field device in a plant. Limited to 32 ASCII characters.

Note: SITRANS PDM limits the TAG field to a maximum of 24 characters.

2.1.2. Descriptor

Text that can be used in any way. Limited to 32 ASCII characters. No specific recommended use.

2.1.3. Message

Text that can be used in any way. Limited to 32 ASCII characters. No specific recommended use.

2.1.4. Installation Date

Date the device was first commissioned (text string, no format restrictions).

2.2. Device

2.2.1. Hardware Revision

Read only. Corresponds to the electronics hardware of the Field Device.

2.2.2. Firmware Revision

Read only. Corresponds to the software or firmware that is embedded in the Field Device.

2.2.3. Loader Revision

Read only. Corresponds to the software used to update the Field Device.

2.2.4. Menu timeout

Time menu stays visible before switching back to Measurement view if no key is pressed.

Values	Range: 15 to 65535 s. Default: 120 s
---------------	--------------------------------------

2.2.5. Manufacturing Date

The date of manufacture of the SITRANS LR560 (YYYYMMDD).

2.3. Sensor

2.3.1. Unit

Sensor measurement unit. Used in setting High/Low Calibration Point, and displayed on LCD and in PDM.

Values	m, cm, mm, ft, in
	Default: m

2.3.2. Level Unit

Note: We recommend leaving Level Unit set to %.

The engineering unit used for Level. High Level Point corresponds to **High Calibration Pt. (2.3.5.2.)** and Low Level Point corresponds to **Low Level Point (2.3.5.4.)**.

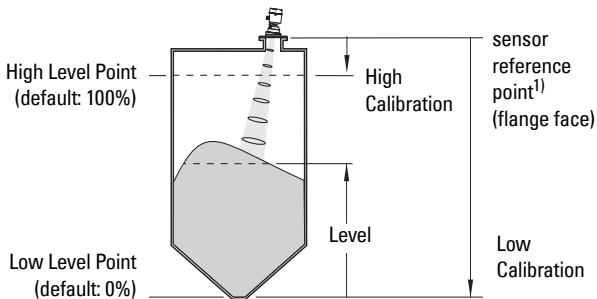

Options	m, cm, mm, ft, in, %
*	%

2.3.3. LOE Timer

Note: When a Loss of Echo occurs **Value (2.5.9.2.)** determines the material level to be reported when LOE Timer expires. See *Loss of Echo (LOE)* on page 121 for more detail.

Sets the time to elapse since the last valid reading, before the Fail-safe material level is reported.

Values	Range: 0 to 720 seconds
	Default: 100 s

¹⁾ The point on the sensor from which measurements are referenced (see *Dimensions* on page 12).

2.3.4. Temperature Unit

Selects the engineering unit to be displayed with the value representing temperature..

Options	Degrees C, F, R, or K. Default: Degrees C
----------------	---

2.3.5. Calibration

Note: We recommend using the Quick Start wizard to configure the device.

2.3.5.1. Low Calibration Pt.

Distance from sensor reference point¹⁾ to Low Calibration Point. Unit is defined in **Unit (2.3.1.)** and displayed on the LCD and in PDM.

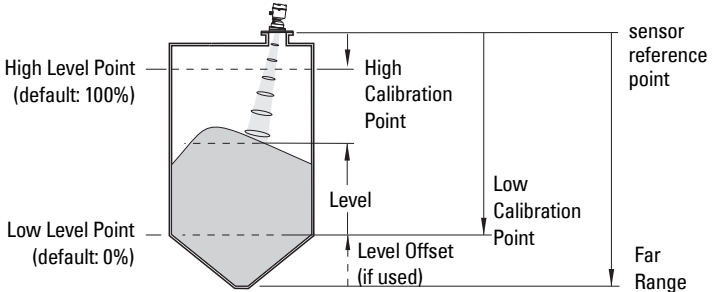

Values	Range: 0 to 100 m. Default: 100.00 m
Related parameters	Unit (2.3.1.) Far Range (2.4.2.)

2.3.5.2. High Calibration Pt.

Distance from Sensor Reference to High Calibration Point. Unit is defined in **Unit (2.3.1.)** and displayed on the LCD and in PDM.

Values	Range: 0 to 100 m. Default: 0.000 m
---------------	-------------------------------------

When setting the High Calibration Point value, note that echoes are ignored within **Near Range (2.4.1.)**

¹⁾ The point on the sensor from which measurements are referenced (see *Dimensions* on page 12.

2.3.5.3. Sensor Offset

A constant offset (negative or positive) that can be added to sensor value¹⁾ to compensate if the sensor reference point has shifted. (For example, this could result from adding a thicker gasket or reducing the standoff/nozzle height.) The units are defined in **Unit (2.3.1.)**.

Values	Range: -100 to 100. Default: 0 m
Related parameters	Unit (2.3.1.)

2.3.5.4. Low Level Point

The level when the material is at Low Calibration Point. The unit is defined in **Level Unit (2.3.2.)**.

Values	Range: -999999 to 999999. Default: 0%
---------------	--

2.3.5.5. High Level Point

The level when the material is at High Calibration Point. The unit is defined in **Level Unit (2.3.2.)**.

Values	Range: -999999 to 999999. Default: 100%
---------------	--

2.3.5.6. Level Offset

A constant offset that can be added to Level. The unit is defined in **Level Unit (2.3.2.)**.

Values	Range: -999999 to 999999. Default: 0%
---------------	--

2.3.6. Rate

Note: Default settings in the parameter tables are indicated with an asterisk (*) unless explicitly stated.

2.3.6.1. Response Rate

Notes:

- Changing Response Rate resets Fill Rate/Min (2.3.6.2.), Empty rate/Min (2.3.6.3.), and Filter Time Constant (2.5.8.1.).
- Selecting SLOW changes setting for **Average amount (2.8.3.)** to 0.9.

Sets the reaction speed of the device to measurement changes.

Response Rate (2.3.6.1.)	Fill Rate/Min (2.3.6.2.)/ Empty rate/Min (2.3.6.3.)	Filter Time Constant (2.5.8.1.)
Slow	0.1 m/min (0.32 ft/min)	10 s
* Medium	1.0 m/min (3.28 ft/min)	10 s
Fast	10.0 m/min (32.8 ft/min)	0 s

Use a setting just faster than the maximum filling or emptying rate (whichever is greater).

¹⁾ The distance from sensor reference point to target (see *Minimum Sensor Value 2.4.3.* on page 70 for an illustration).

2.3.6.2. Fill Rate/Min

Defines the maximum rate at which the reported sensor value is allowed to increase. Allows you to further adjust the SITRANS LR560 response to increases in the actual material level. Fill Rate is automatically updated whenever **Response Rate (2.3.6.1.)** is altered.

Options	Range: 0 to 999999 m / min.	
	Response Rate (2.3.6.1.)	Fill Rate
	Slow	0.1 m/min (0.32 ft/min)
	* Medium	1.0 m/min (3.28 ft/min)
	Fast	10.0 m/min (32.8 ft/min)
Related parameters	Level Unit (2.3.2.)	

Enter a value slightly greater than the maximum vessel-filling rate, in units per minute.

2.3.6.3. Empty rate/Min

Defines the maximum rate at which the reported sensor value is allowed to decrease. Adjusts the SITRANS LR560 response to decreases in the actual material level. Empty Rate is automatically updated whenever **Response Rate (2.3.6.1.)** is altered.

Options	Range: 0 to 999999 m / min.	
	Response Rate (2.3.6.1.)	Empty Rate
	Slow	0.1 m/min (0.32 ft/min)
	* Medium	1.0 m/min (3.28 ft/min)
	Fast	10.0 m/min (32.8 ft/min)
Related parameters	Level Unit (2.3.2.)	

Enter a value slightly greater than the vessel's maximum emptying rate, in units per minute.

2.4. Signal Processing

Note: Default settings in the parameter tables are indicated with an asterisk (*) unless explicitly stated.

2.4.1. Near Range

The range in front of the device (measured from the sensor reference point¹⁾) within which any echoes will be ignored. (This is sometimes referred to as "Blanking" or "Dead Zone".)

Values	Range: 0 to 105 m (0 to 344.5 ft)
	Default: 0.278 m (0.91 ft)
Related parameters	Unit (2.3.1.)

¹⁾ Flange face: see *Dimensions* on page 12.

2.4.2. Far Range

Note: Far Range can extend beyond the bottom of the vessel.

Allows the material level to drop below Low Calibration Point without generating a Loss of Echo (LOE) state. See **Low Calibration Pt. (2.3.5.1.)** on page 67 for an illustration.

Values	Range: Min. = Low Calibration Pt. Max. = 45 m (131.2 ft): 40 m device = 105 m (344.5 ft): 100 m device Default: Value for Low Calibration Pt. + 5 m (16.4 ft)
Related parameters	Unit (2.3.1.) CLEF Range (2.4.5.4.)

Use this feature if the measured surface can drop below Low Calibration Point in normal operation. See *Far Range (2.4.2.)* on page 120 for more detail.

2.4.3. Minimum Sensor Value

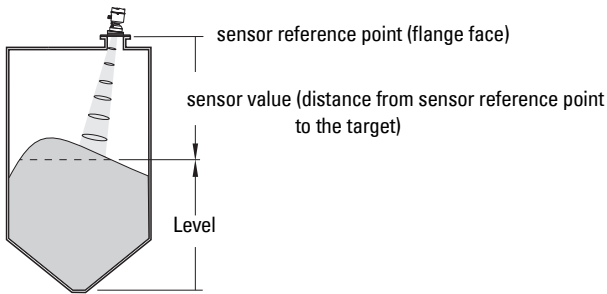

Read Only. Defines the minimum usable value for the measuring range, in units defined in **Unit (2.3.1.)**.

(Default = 0.0 m)

- Open the menu **View – Device Diagnostics > Device Status**, and click on the **Device Status** tab.
- Check **Sensor Peak Values**.

2.4.4. Maximum Sensor Value

Read Only. Defines the minimum usable value for the measuring range, in units defined in **Unit (2.3.1.)**.

(Default : 105 m for 100 m device, 45 m for 40 m device)

- Open the menu **View – Device Diagnostics > Device Status**, and click on the **Device Status** tab.
- Check **Sensor Peak Values**.

2.4.5. Echo select

2.4.5.1. Algorithm

Selects the algorithm to be applied to the echo profile to extract the true echo.

Options		ALF	Area Largest First
		A	Echo Area
		L	Largest echo
	*	F	First Echo
		AL	Area Largest
		AF	Area First
		LF	Largest First
		BLF	Best F-L (First and Largest)
		BL	Best L (Largest)
		BF	Best F (First)
			Last
		TF	true First echo

2.4.5.2. Position Detect

Note: Selecting Steel or Concrete vessel type in the Quick Start wizard changes the setting for **Position Detect (2.4.5.2.)** to Rising Edge.

Defines where on the echo the distance measurement is determined. See Position Detect (2.4.5.2.) on page 116 for more detail.

Options	*	Rising Edge (yields highest stability on sloped targets)
		Center (yields higher accuracy on flat, non-sloped targets)
		Hybrid (Center and CLEF)
		CLEF (Constrained Leading Edge Fit)
Related parameters		CLEF Range (2.4.5.4.)

If the vessel bottom is being reported as the level instead of the actual material level (at low level conditions) we recommend setting **Position Detect** to Hybrid and using it in combination with **CLEF Range (2.4.5.4.)**.

2.4.5.3. Echo Threshold

Sets the minimum echo confidence that the echo must meet in order to prevent a Loss of Echo condition and the expiration of the LOE timer. When **Confidence (2.4.7.1.)** exceeds **Echo Threshold (2.4.5.3.)**, the echo is accepted as a valid echo and is evaluated.

Values	Range: 0 to 99
	Default: 5
Related Parameters	LOE Timer (2.3.3.)

Use this feature when an incorrect material level is reported.

2.4.5.4. CLEF Range

Notes:

- CLEF Range is referenced from Far Range.
- The value for CLEF Range must include the difference between Far Range and Low Calibration Point, plus any level above the Low Calibration Point to be managed by the CLEF algorithm.

The CLEF algorithm is used mainly to allow correct level reporting for low dK materials which may otherwise cause an incorrect reading in an empty or almost empty vessel.

It is used from Far Range up to the level defined by CLEF Range (see illustration below). Above that point the Center algorithm is used. For more detail see CLEF Range (2.4.5.4.) on page 118.

Values	Range: 0 to 45 m (40 m device) 0 to 105 m (100 m device)
	Default: 0.0 m
Related parameters	Position Detect (2.4.5.2.) Far Range (2.4.2.)

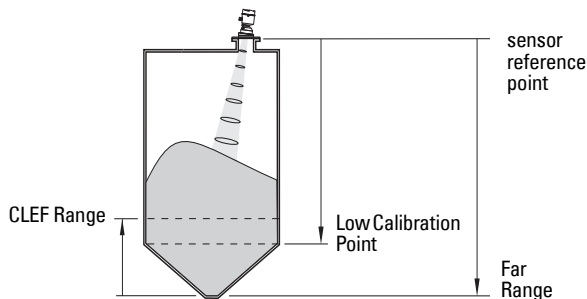

2.4.5.5. Echo Marker

The point on the primary echo on which the measured value is based.

Values	Range: 5 to 95%
	Default: 70%

Use this feature if the reported material level fluctuates slightly, due to a variable rise in the leading edge of the true echo on the Echo Profile.

Enter the value (in percent of echo height) to ensure the Echo Lock Window intersects the Echo Profile at the sharpest rising portion of the Echo Profile representing the true echo. This value is preset to 70%.

2.4.6. Sampling

Provides a method of checking the reliability of a new echo before accepting it as the valid reading, based on numbers of samples above or below the currently selected echo.

2.4.6.1. Echo Lock

Selects the measurement verification process.

Options	<input type="checkbox"/>	Lock Off (no verification)
	<input type="checkbox"/>	Maximum Verification (not recommended for radar)
	<input type="checkbox"/>	* Material Agitator
	<input type="checkbox"/>	Total Lock (not recommended for radar)
Related parameters	Fill Rate/Min (2.3.6.2.) Empty rate/Min (2.3.6.3.) Sampling up (2.4.6.2.) Sampling down (2.4.6.3.)	

For radar applications, Material Agitator is the most often used setting, to avoid agitator blade detection.

2.4.6.2. Sampling up

Specifies the number of consecutive echoes that must appear above the echo currently selected, before the measurement is accepted as valid.

Values	Range: 1 to 50
	Default: 5

2.4.6.3. Sampling down

Specifies the number of consecutive echoes that must appear below the echo currently selected, before the measurement is accepted as valid.

Values	Range: 1 to 50
	Default: 2

2.4.6.4. Echo Lock Window

A “distance window” centered on the echo¹⁾ is used to derive the reading. When a new measurement is in the window, the window is re-centered and the reading is calculated.

Values	Range: 0 to 105 m
	Default: 0 m

When the value is 0, the window is automatically calculated after each measurement.

- For slower Measurement Response values, the window is narrow.
- For faster Measurement Response values, the window becomes progressively wider.

Note: The Echo Lock window is stored as a standard sample, but displayed in sensor units. Any value entered for the Echo Lock window will be rounded to the nearest sample.

2.4.7. Echo Quality

2.4.7.1. Confidence

Indicates echo reliability: higher values represent better echo quality. The display shows the echo confidence of the last measurement. **Echo Threshold (2.4.5.3.)** defines the minimum criterion for echo confidence.

Values (view only)	0 to 99	
	----	Shot not used
Related Parameters	Echo Threshold (2.4.5.3.)	

Open the menu **Device – Echo Profile Utilities** and click on the tab **Echo Profile**.

2.4.7.2. Echo Strength

Displays the absolute strength (in dB above 1 μ V rms) of the echo selected as the measurement echo.

Values (view only)	–20 to 99
---------------------------	------------------

Open the menu **Device – Echo Profile Utilities** and click on the tab **Echo Profile**.

¹⁾ See *Echo Lock (2.4.6.1.)* on page 118 for more detail.

2.4.8. TVT setup

2.4.8.1. Auto False Echo Suppression

Note: We recommend setting Auto False Echo Suppression either via SIMATIC PDM or via local operation using the Auto False Echo Suppression wizard.

Used together with **Auto False Echo Suppression Range (2.4.8.2.)** to screen out false echoes in a vessel with known obstructions. A 'learned TVT' (time varying threshold) replaces the default TVT over a specified range.

- See *Auto False Echo Suppression (2.4.8.1.)* on page 118 for a more detailed explanation.
- To set via SIMATIC PDM see *Auto False Echo Suppression* on page 48.
- To set via local operation see *AFES (Auto False Echo Suppression) Wizard 1.2.* on page 63.

2.4.8.2. Auto False Echo Suppression Range

Defines the endpoint of the Learned TVT distance. Units are defined in Unit (2.3.1.). Used in combination with Auto False Echo Suppression (see above).

Values	Range: 0.00 to 105.00 m
	Default: 1.00 m

2.4.8.3. Hover Level

Defines how high the TVT (Time Varying Threshold) is placed above the noise floor of the echo profile, as a percentage of the difference between the peak of the largest echo in the profile and the noise floor. (See **Before Auto False Echo Suppression** on page 49 for an illustration.)

Values	Range: 0 to 100%
	Default: 40%

When the device is located in the center of the vessel, the TVT hover level may be lowered to increase the confidence level of the largest echo.

2.4.8.4. Shaper Mode

Enables/disables **TVT shaper (2.4.9.)**.

Options	*	OFF
		ON

2.4.9. TVT shaper

Notes:

- **Shaper Mode (2.4.8.4.)** must be turned **ON** in order for TVT shaper breakpoints to be transferred.
- We recommend using SIMATIC PDM to access this feature.

Adjusts the TVT (Time Varying Threshold) at a specified range (breakpoint on the TVT). This allows you to reshape the TVT curve to avoid unwanted echoes. There are 120 breakpoints.

Values	Range: -50 dB to +50 dB Default: 0
---------------	---------------------------------------

To use TVT shaper via SIMATIC PDM:

Open the menu **Device – Echo Profile Utilities** and click on the tab **TVT Shaper** (see *TVT Shaper on page 47* for more details).

To use TVT shaper via the local display interface (LDI):

- a) Go to **Shaper Mode (2.4.8.4.)** and select option **ON**.
- b) In TVT shaper, go to **Breakpoint 1-9 (2.4.9.1.)**.
- c) Open Breakpoint 1 and enter the TVT Offset value (between -50 and 50).
- d) Go to the next Breakpoint and repeat step (c) till all desired breakpoint values have been entered.

2.4.9.1. Breakpoint 1-9

2.4.9.2. Breakpoint 10-18

2.4.9.3. Breakpoint 19-27

2.4.9.4. Breakpoint 28-36

2.4.9.5. Breakpoint 37-45

2.4.9.6. Breakpoint 46-54

2.4.9.7. Breakpoint 55-63

2.4.9.8. Breakpoint 64-72

2.4.9.9. Breakpoint 73-81

2.4.9.10. Breakpoint 82-90

2.4.9.11. Breakpoint 91-99

2.4.9.12. Breakpoint 100-108

2.4.9.13. Breakpoint 109-117

2.4.9.14. Breakpoint 118-120

2.5. AIFB1

Note: Default settings in the parameter tables are indicated with an asterisk (*) unless explicitly stated.

2.5.1. Static Revision No.

The revision level of the static data associated with Analog Input Function Block 1. The Static Revision No. is updated whenever a configuration parameter is changed.

2.5.2. Mode

Note: Ensure that Mode is returned to AUTO when simulation or maintenance are completed.

Used to request an operating mode from the Analog Input Function Block. Allows you to put SITRANS LR560 into Manual mode (used in conjunction with Simulation) or Out-of-Service mode for maintenance purposes.

Setting	Description	Output value
AUTO	automatic	the automatically-recorded measured value
MAN	manual	a manually-set fixed simulation value
O/S	function block disabled	the preset safety value

We recommend using this parameter only with SIMATIC PDM in order to benefit from all the features available. For a detailed explanation see *AIFB (simulation, mode and status)* on page 127.

To use Mode via PDM see *Simulate Output* on page 53.

2.5.3. Channel

Used to select the Transducer Block output.

Options	Reference Point
Level/Volume (PV - Primary Value ^{a)}). Note: Volume is a standard option, but not supported by LR560 PA.	Low Calibration Point
Level (SV1 - Secondary Value 1 ^{a)})	Low Calibration Point
* Distance (SV2 - Secondary Value 2 ^{a)})	sensor reference point

^{a)} See *Transducer Block* on page 125 for an illustration.

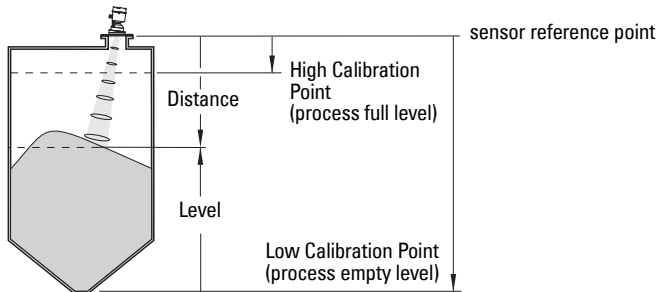

2.5.4. Label

User defined label.

2.5.5. Input Scaling

2.5.5.1. Upper Value

Defines the operational upper range value of the input value (Process Value Scale) in PV (volume/level) Units. Process Value Scale normalizes the input value to a customer-defined range.

Values	Range: -999999 to 999999
	Default: 100%

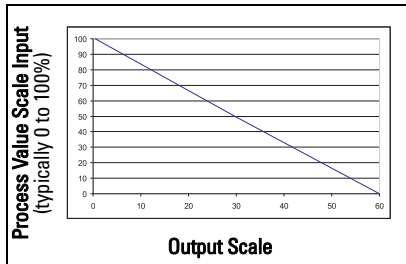

Provides output values (Out) to AIFB1 or AIFB2

2.5.5.2. Lower Value

Defines the operational lower range value of the input value (Process Value Scale) in PV (volume/level) Units. Process Value Scale normalizes the input value to a customer-defined range.

Values	Range: -999999 to 999999
	Default: 0%

2.5.6. Output Scaling

Scales the Process Variable. The function block parameter OUT SCALE contains the values of the lower limit and upper limit effective range in AIFB1 units.

2.5.6.1. Upper Value

Defines the operational upper range value of the output value in AIFB1 units.

Values	Range: -999999 to 999999
	Default: 100%

2.5.6.2. Lower Value

Defines the operational lower range value of the output value in AIFB1 units.

Values	Range: -999999 to 999999
	Default: 0%

2.5.7. Alarms and Warnings

2.5.7.1. High Limit Alarm

The setting for the upper alarm limit in AIFB1 units.

Values	Range: -999999 to 999999
	Default: 999

2.5.7.2. High Limit Warning

The setting for the upper warning limit in AIFB1 units

Values	Range: -999999 to 999999
	Default: 999

2.5.7.3. Low Limit Warning

The setting for the lower warning limit in AIFB1 units.

Values	Range: -999999 to 999999
	Default: -999

2.5.7.4. Low Limit Alarm

The setting for the lower alarm limit in AIFB1 units.

Values	Range: -999999 to 999999
	Default: -999

2.5.7.5. Limit Hysteresis

Hysteresis is used to adjust the sensitivity of the trigger for alarm messages. It is used to compensate when a process variable fluctuates around the same value as a limit. A high level alarm occurs when a value exceeds an upper limit. The alarm's status remains true until the value drops below the limit minus the alarm hysteresis. The directions are reversed for low limit detection.

Values	Range: 0 to 999999.00
	Default: 0.20

Enter a value for the hysteresis here, to be used for all warnings and alarms. The units are the same as the Output scale, i.e. AIFB1 units.

2.5.8. Display

2.5.8.1. Filter Time Constant

The time constant for the damping filter. The damping filter smooths out the response to a sudden change in level. This is an exponential filter and the engineering unit is always in seconds (see **Damping on page 121** for more detail).

Values	Range 0 to 1500 s
	Default: 10 s

2.5.8.2. Unit

Note: Additional units are available in SIMATIC PDM.

Engineering unit to be displayed with the output value

Options^{a)}		m, cm, mm, ft, in, %
	*	m

a) In PDM, 3 additional units are available: Not Used, Unknown, and Special (as permitted by PROFIBUS). In PDM the out unit text is displayed in the drop-down menu. On the display, the option is 'Follow out unit text'.

2.5.8.3. Out Unit Text

If the desired unit is not listed in **Unit (2.5.8.2.)** you can define it in **Out Unit Text**

2.5.8.4. Decimal Point

The number of digits to display after the decimal point. (The LCD is limited to displaying two decimal places in Measurement mode. In SIMATIC PDM up to seven decimal places may be used to display measured values.)

Options	Range: 0, 1, 2, 3, 4, 5, 6, 7
	Default: 2

2.5.9. Fail-safe Mode

2.5.9.1. Mode

Fail-safe Mode occurs if the status of the input value is bad, or if the device has been put into Fail-safe mode using Simulation. **Mode** defines the material level to be reported when the LOE (Loss of Echo) timer expires.

Options		SUB VALUE	Substitute value. Value (2.5.9.2.) used as output value.
	*	LAST VALUE	Last value. (Store last valid output value).
		USE BAD VALUE	Use bad value. (Calculated output value is incorrect).

2.5.9.2. Value

Note: Fail-safe Mode (2.5.9.) must be set to **Substitute Value** before **Value (2.5.9.2.)** can be defined.

*User-defined default for the Output Value, if sensor or sensor electronic fault is detected. Units are defined in **Unit (2.5.8.2.)**.*

Values	Range: -999999 to 999999
	Default: 0

2.6. AIFB2

See **AIFB1 (2.5.)**: the parameters for AIFB2 are identical.

2.7. Measured Values

Read only. Allows you to view measured values for diagnostic purposes

In SIMATIC PDM, open the menu **View – Process Variables**.

2.7.1. Main Output

The value for Level/Volume. (PV– Primary Value).

2.7.2. Output, no linearization

The value for Level (SV1 – Secondary Value 1).

2.7.3. Output, no level offset

The value for Distance (SV2 – Secondary Value 2).

2.8. Filtering

2.8.1. Narrow Echo Filter

Filters out echoes of a specific width.

Values	Range: 0 to 255. Default: 0.
	0 = OFF
	greater = wider

To remove a false echo from the Echo Profile, take its width in mm and multiply it by 0.013. Enter the result.

For example, to filter out a spike with 500 mm width, enter 6 or 7 (the closest integer product of 500 x 0.013).

When a value is keyed in, the nearest acceptable value is entered.

2.8.2. Reform Echo

Smooths jagged peaks in the echo profile. Reforms fragmented echoes into one echo.

Values	Range: 0 to 255 samples.
	Default: 0 (reset to 10 after a Quick Start has been completed)
	0 = OFF
	greater = wider
	Recommended: 5 to 20 samples. Wider is not recommended.

2.8.3. Average amount

The fraction of the old shot data that is kept for averaging purposes. A higher value will give a smoother profile at the expense of a slower echo profile response.

Values	0.0 to 1.0
	Default: 0.75

3. Diagnostics

3.1. Echo Profile

To request a profile via SIMATIC PDM:

Open the menu **Device – Echo Profile Utilities**. (See *Echo profile* on page 46 for more detail.)

To request a profile via the handheld programmer:

Note: Selected icon is highlighted.

Navigate to **Echo Profile (3.1)** and press **RIGHT arrow**. (See *Requesting an Echo Profile* on page 37 for more details.)

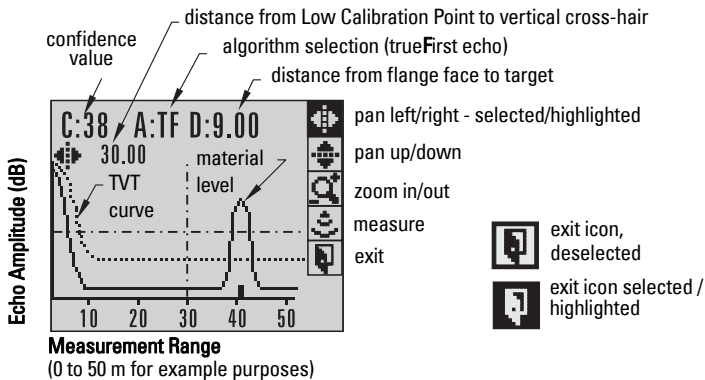

3.2. Fault Reset

Clears the following faults:

Fault Code	Description
S3	Device Lifetime Reminder 1 (Maintenance Required)
S4	Device Lifetime Reminder 2 (Maintenance Demanded)
S6	Sensor Lifetime Reminder 1 (Maintenance Required)
S7	Sensor Lifetime Reminder 2 (Maintenance Demanded)
S8	Device Service Reminder 1 (Maintenance Required)
S9	Device Service Reminder 2 (Maintenance Demanded)
S12	Internal Temperature High
S17	Calibration Schedule Reminder 1 (Maintenance Required)
S18	Calibration Schedule Reminder 2 (Maintenance Demanded)

To clear a fault using the handheld programmer:

- Enter the fault code number then press **RIGHT arrow**.

To clear a fault via SIMATIC PDM:

- Open the menu **Device – Acknowledge Faults**.
- Select the fault to be cleared from the pull-down menu in Extended Diagnostics.
- Click on **Transfer** to clear the fault.

3.3. Trend

Displays the trend of the Process Variables: sensor value, and outputs from AIFB1/ AIFB2. Samples are saved every minute up to 3200 samples.

To view via SIMATIC PDM:

Open the menu **View – Process Variables** and click on the tab **Trend View**.

3.4. Electronics Temperature

3.4.1. Minimum Value

The minimum recorded internal electronics temperature of the SITRANS LR560.

3.4.2. Maximum Value

The maximum recorded internal electronics temperature of the SITRANS LR560.

3.4.3. Internal Temperature

The current internal electronics temperature of the device.

3.5. Condensed Status

*When **Enable (3.5.1)** is enabled, you can select the level of severity of errors, and tailor a device response appropriate for your particular process.*

- In **Event Index (3.6.1)** you can select a particular event or error by means of its index number.
- In **Event Status (3.6.2)** you can assign a status to the selected event.
- In **Event Diagnosis (3.6.3)** you can assign a diagnosis to the selected event.

3.5.1. Enable

Note: When cyclic communication is in progress, Condensed Status Mode cannot be changed.

Options		NO (disabled)
	*	YES (enabled)

Select **Yes** or **No** to enable/disable Condensed Mode.

3.5.2. Features supported

Read only. Features supported are:

- Condensed Diagnostics
- Extended Diagnostics
- Application Relationships

3.5.3. Features enabled

Read only. Lists those features that have been enabled.

3.6. Allocation

3.6.1. Event Index

The numeric component of the Event Code for a Condensed Status event. Use the index number to identify a particular event in the list below.

Event Index	Event Code	Event Description ^{a)}
0	S0	Loss of Echo
2	S2	No Tech Power
10	S10	Level Transducer Block (LTB) Scale
11	S11	Internal Temperature Sensor
12	S12	Internal Temperature High
14	S14	AIFB1 PV Range
15	S15	AIFB2 PV Range
25	S25	Internal error
28	S28	Memory RAM
29	S29	Memory EEPROM
30	S30	Memory EEPROM Flags
31	S31	Memory Flash
33	S33	Internal Temperature Calibration
34	S34	Velocity Calibration
35	S35	Receiver Init Calibration
36	S36	Receiver Calibration
37	S37	Technology Module Calibration
38	S38	Technology Module Ramp

a) See *General Fault Codes* on page 108 for the meaning of each event.

For example:

Event Code for Loss of Echo = S0
Event Index = 0

To select a particular event via the handheld programmer:

- Go to **Enable (3.5.1.)** and select **Yes** to enable Condensed Mode.
- Go to **Event Index (3.6.1.)** and enter the event index number corresponding to the event.

To select a particular event via SIMATIC PDM:

- Go to **Maintenance & Diagnostics > Condensed Status > Enable** and select **Yes** to enable Condensed Mode.
- Go to **Maintenance & Diagnostics > Allocation Level**.
- For each event, you can select either the Status or the Diagnosis line, then choose a Status or Diagnosis option from the associated pull-down menu.

3.6.2. Event Status

*Event Status allows you to assign one of the status options listed below, to any of the events listed in **Event Index (3.6.1.)**. This allows you to tailor a device response appropriate for your particular process. (Event Status affects Condensed Status¹⁾).*

Event Status Options	
	Good
	Good: maintenance required
	Good: maintenance demanded
	Uncertain: maintenance demanded
*	Bad: maintenance alarm
	Uncertain: process related, no maintenance
	Bad: process related, no maintenance
	Bad: function check/local override
	Good: function check

To assign a status to a particular event via the handheld programmer:

- Go to **Enable (3.5.1.)** and select **Yes** to enable Condensed Mode.
- Go to **Event Index (3.6.1.)** and enter the event index number corresponding to a particular event.
- Go to **Event Status (3.6.2.)** and choose a Status option from the table above.

To assign a status to a particular event via SIMATIC PDM:

- Go to **Level Meter > Maintenance & Diagnostics > Condensed Status > Enable** and select **Yes** to enable Condensed Status Mode.
- Go to **Level Meter > Maintenance & Diagnostics > Allocation Level**.
- Select the Status line for the selected Event, then choose a Status option from the associated pull-down menu.

3.6.3. Event Diagnosis

*Allows you to assign one of the diagnostic options listed below to any of the events listed in **Event Index (3.6.1.)**. This allows you to tailor a device response appropriate for your particular process.(Event Diagnosis affects Condensed Acyclic Diagnostics and Cyclic Extended Diagnostics²⁾).*

Event Diagnosis Options	
	Status OK
	Maintenance Required
	Maintenance Demanded
*	Maintenance alarm
	Invalid process conditions
	Function check or simulation

¹⁾ See *Condensed Status* on page 132 for more detail.

²⁾ See *Condensed Mode Diagnosis* on page 136 for more detail.

To assign a diagnosis to a particular event via the handheld programmer:

- a) Go to **Enable (3.5.1.)** and select **Yes** to enable Condensed Mode.
- b) Go to **Event Index (3.6.1.)** and enter the event index number corresponding to a particular event.
- c) Go to **Event Diagnosis (3.6.3.)** and choose a Diagnosis option from the table above.

To assign a status to a particular event via SIMATIC PDM:

- a) Go to **Level Meter > Maintenance & Diagnostics > Condensed Status > Enable**, and select **Yes** to enable Condensed Status Mode.
- b) Go to **Level Meter > Maintenance & Diagnostics > Allocation Level**.
- c) Select the Diagnosis line for the selected Event, then choose a Diagnosis option from the associated pull-down menu.

3.7. Peak Values

To view via SIMATIC PDM:

Open the menu **View – Device Diagnostics**, select **Device Status**, and click on the tab **Device Status**. For more details see *Device Diagnostics on page 57*.

3.7.1. Min. Measured Value

*The minimum recorded Sensor value, reported in units defined in **Unit (2.3.1.)**.*

3.7.2. Max. Measured Value

*The maximum recorded Sensor value, reported in units defined in **Unit (2.3.1.)**.*

3.7.3. Minimum Output Value - AIFB1

The minimum recorded Output Value from the Analog Input Function Block 1.

3.7.4. Maximum Output Value - AIFB1

The maximum recorded Output Value from the Analog Input Function Block 1.

3.7.5. Minimum Output Value - AIFB2

The minimum recorded Output Value from the Analog Input Function Block 2.

3.7.6. Maximum Output Value - AIFB2

The maximum recorded Output Value from the Analog Input Function Block 2.

4. Service

Note: Default settings in the parameter tables are indicated with an asterisk (*) unless explicitly stated.

4.1. Demo Mode

Reduces the time between measurements and the accuracy for demonstration purposes.

4.2. Master Reset

Notes:

- Following a reset, some degree of reprogramming may be required, depending on the option chosen below.
- While performing any reset, a loss of communications can be expected.

Reset Options	Result
Factory Defaults	Resets all user parameters to the manufacturer's default settings, with certain exceptions. The list of exceptions includes, but is not limited to: <ul style="list-style-type: none">• Message• Description• Installation Data• Device Address• Write Protection• Auto False Echo Suppression Range• Learned TVT• Language
Standard Defaults	Resets all parameters, excluding device addresses and Language, to the PROFIBUS standard default settings. NOTE: After initiating a reset to Standard Defaults via the local user interface, allow 1-2 minutes before initiating a new command locally.
Informational	Resets parameters such as Tag.
Functional	Resets parameters that control device behavior and functionality (such as calibration points)
Warm Start	Has the same effect as recycling power to the device
Reset Address to 126	<ul style="list-style-type: none">• Resets the PROFIBUS device address to 126• If the address lock was on, will disable the lock.

To access via SIMATIC PDM:

Open the menu **Device – Master Reset**. For more detail see *Master Reset on page 55*.

To perform a reset via the handheld programmer:

- a) Press **RIGHT Arrow** to open Edit Mode then scroll down to the desired Reset option and press **RIGHT Arrow** to select it.
- b) Press **LEFT Arrow** to exit.

4.3. Powered Hours

Read only. Displays the number of hours the unit has been powered up since manufacture.

To view via SIMATIC PDM, open the menu **Device – Wear**.

4.4. Power-on Resets

Read only. The number of power cycles that have occurred since manufacture.

To view via SIMATIC PDM, open the menu **Device – Wear**.

4.5. LCD Backlight

Time the backlight remains on.

Options	Range: 0 (backlight off) to 128 seconds (backlight always on). Default: 128 seconds
----------------	--

4.6. LCD Contrast

The factory setting is for optimum visibility at room temperature and in average light conditions. Extremes of temperature will lessen the contrast.

Values	Range: 0 to 20 Default: 8	Contrast setting will depend on ambient temperature.
---------------	--	--

Adjust the value to improve visibility in different temperatures and light conditions. Change the value in small steps to ensure you can continue to read the display.

To access LCD Contrast via SIMATIC PDM:

Navigate to **Level Meter > Setup > Local Display**.

4.7. Remaining Device Lifetime

Notes:

- Default settings in the parameter tables are indicated with an asterisk (*) unless explicitly stated.
- Four sets of parameters allow you to monitor the Device/Sensor Lifetimes and set up Service/Calibration schedules, based on operating hours instead of a calendar-based schedule. See also **Remaining Sensor Lifetime (4.8.)**, **Service Schedule (4.9.)**, and **Calibration Schedule (4.10.)**.
- Performing a reset to **Factory Defaults** will reset all the Maintenance Schedule parameters to their factory defaults.
- The device operates in years. To view Remaining Device Lifetime parameters in hours or days (via SIMATIC PDM only) see **Lifetime Expected (4.71.)**.

The device tracks itself based on operating hours and monitors its predicted lifetime. You can modify the expected device lifetime, set up schedules for maintenance reminders, and acknowledge them.

The maintenance warnings and alarms are communicated via the Status byte. This information can be integrated into any Asset Management system. For optimal use, we recommend that you use SIMATIC PCS7 Asset Management Software in conjunction with SIMATIC PDM.

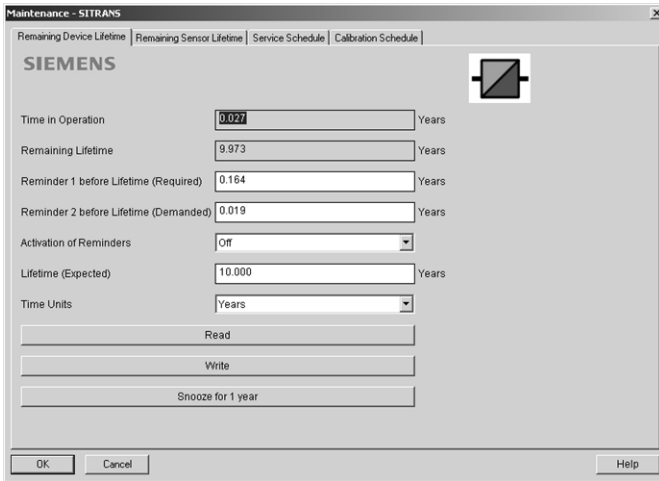

To access these parameters via SIMATIC PDM:

- Open the menu **Device – Maintenance** and select the **Remaining Device Lifetime** tab.
- After modifying values/units as required, click on **Write** to accept the change, and **Read** to view the effect of the change.
- Click on **Snooze** to add a year to the Total Expected Device Life.

Time Units

Options^{a)}	Hours; days; years
	Default: years

a) Selectable only via SIMATIC PDM.

4.7.1. Lifetime Expected

Note: The device always operates in years. Changing the units affects only the parameter view of the Remaining Device Lifetime parameters in SIMATIC PDM.

Allows you to override the factory default.

Values	Units ^{a)} : hours, days, years
	Range: 0 to 20 years
	Default: 10.00 years

a) Units are selectable only via SIMATIC PDM.

4.7.2. Time in Operation

Read only. The amount of time the device has been operating in years.

4.7.3. Remaining Lifetime

Read only. Lifetime Expected (4.7.1.) less Time in Operation (4.7.2.)

4.7.4. Reminder Activation

Note: To modify this parameter via SIMATIC PDM it must be accessed via the pull-down menu **Device – Maintenance**.

Allows you to enable a maintenance reminder.

Values		REMInder 1 (Maintenance REQuired)
		REMInder 2 (Maintenance DEManded)
		REMInder 1 AND 2 (Maintenance Required and Maintenance Demanded)
	*	OFF

- First set the values in **Reminder 1 (Required) (4.7.5.)**/**Reminder 2 (Demanded) (4.7.6.)**.
- Select the desired **Reminder Activation** option.

4.7.5. Reminder 1 (Required)

If Remaining Lifetime (4.7.3.) is equal to or less than this value, the device generates a Maintenance Required reminder.

Values	Range: 0 to 20 years
	Default: 0.164 years

- Modify values as required.
- Set **Reminder Activation (4.7.4.)** to the desired option.

4.7.6. Reminder 2 (Demanded)

If Remaining Lifetime (4.7.3.) is equal to or less than this value, the device generates a Maintenance Demanded reminder.

Values	Range: 0 to 20 years
	Default: 0.019 years

- Modify limit values as required.
- Set **Reminder Activation (4.7.4.)** to the desired option.

4.7.7. Maintenance Status

Indicates which level of maintenance reminder is active.

In SIMATIC PDM, open the menu **View – Device Diagnostics**, select **Device Status**, click on the **Maintenance** tab, and check the **Device Lifetime Status** window.

4.7.8. Acknowledge Status

Indicates which level of maintenance reminder has been acknowledged.

In SIMATIC PDM, open the menu **View – Device Diagnostics**, select **Device Status**, click on the **Maintenance** tab, and check the **Device Lifetime Status** window.



4.7.9. Acknowledge

Acknowledges the current maintenance reminder.

To acknowledge a reminder via SIMATIC PDM:

- Open the menu **View – Device Diagnostics**, select **Device Status**, and click on the **Maintenance** tab.
- In the **Device Lifetime** section, click on **Acknowledge Warnings**.

To acknowledge a reminder via the handheld programmer:

- Press **RIGHT arrow**  twice to open parameter view and activate **Edit Mode**.
- Press **RIGHT arrow**  to acknowledge the reminder.

4.8. Remaining Sensor Lifetime

Notes:

- Default settings in the parameter tables are indicated with an asterisk (*) unless explicitly stated.
- Four sets of parameters allow you to monitor the Device/Sensor Lifetimes and set up Service/Calibration schedules, based on operating hours instead of a calendar-based schedule. See also **Remaining Device Lifetime (4.7.)**, **Service Schedule (4.9.)**, and **Calibration Schedule (4.10.)**.
- Performing a reset to **Factory Defaults** will reset all the Maintenance Schedule parameters to their factory defaults.
- The device operates in years. To view Remaining Sensor Lifetime parameters in hours or days (via SIMATIC PDM only) see **Lifetime Expected (4.8.1.)**.

The device monitors the predicted lifetime of the sensor (the components exposed to the vessel environment). You can modify the expected sensor lifetime, set up schedules for maintenance reminders, and acknowledge them.

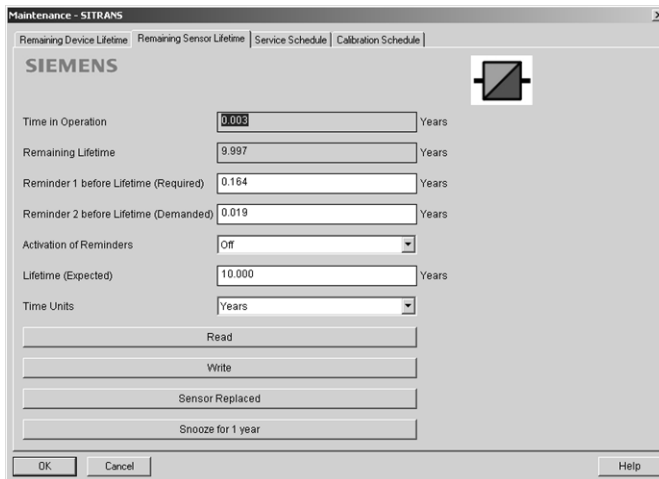

Maintenance - SITRANS

Remaining Device Lifetime | **Remaining Sensor Lifetime** | Service Schedule | Calibration Schedule

SIEMENS

Time in Operation: 0.003 Years

Remaining Lifetime: 9.997 Years

Reminder 1 before Lifetime (Required): 0.164 Years

Reminder 2 before Lifetime (Demanded): 0.019 Years

Activation of Reminders: Off

Lifetime (Expected): 10.000 Years

Time Units: Years

Read

Write

Sensor Replaced

Snooze for 1 year

OK Cancel Help

See *To access these parameters via SIMATIC PDM: on page 92*

To access these parameters via SIMATIC PDM:

- Open the menu **Device – Maintenance** and select the **Remaining Sensor Lifetime** tab.
- After modifying values/units as required, click on **Write** to accept the change, and **Read** to view the effect of the change.
- Click on **Snooze** to add a year to the Total Expected Sensor Life.
- Click on **Sensor Replaced** to restart the timer and clear any fault messages.

Time Units

Options^{a)}	Hours; days; years
	Default: years

a) Selectable only via SIMATIC PDM.

4.8.1. Lifetime Expected

Note: The device always operates in years. Changing the units affects only the parameter view of Remaining Sensor Life parameters in SIMATIC PDM.

Allows you to override the factory default.

Values	Units ^{a)} : hours, days, years
	Range: 0 to 20 years
	Default: 10.00 years

a) Units are selectable only via SIMATIC PDM.

4.8.2. Time in Operation

The amount of time the sensor has been operating. Can be reset to zero after performing a service or replacing the sensor.

To reset to zero:

- In SIMATIC PDM, open the menu **Device – Maintenance**, click on the **Remaining Sensor Lifetime** tab, and click on **Sensor Replaced** to restart the timer and clear any fault messages.
- Via the handheld programmer, manually reset **Time in Operation (4.8.2.)** to zero.

4.8.3. Remaining Lifetime

*Read only. **Lifetime Expected (4.8.1.)** less **Time in Operation (4.8.2.)**.*

4.8.4. Reminder Activation

Note: To modify this parameter via SIMATIC PDM it must be accessed via the pull-down menu **Device – Maintenance**.

Allows you to enable a maintenance reminder.

Options	REMInder 1 (Maintenance REQuired)
	REMInder 2 (Maintenance DEManded)
	REMInder 1 AND 2 (Maintenance Required and Maintenance Demanded)
	* OFF

- First set the values in **Reminder 1 (Required) (4.8.5.)**/**Reminder 2 (Demanded) (4.8.6.)**.
- Select the desired **Reminder Activation** option.

4.8.5. Reminder 1 (Required)

*If **Remaining Lifetime (4.8.3.)** is equal to or less than this value, the device generates a **Maintenance Required** reminder.*

Values	Range: 0 to 20 years
	Default: 0.164 years

- Modify values as required.
- Set **Reminder Activation (4.8.4.)** to the desired option.

4.8.6. Reminder 2 (Demanded)

*If **Remaining Lifetime (4.8.3.)** is equal to or less than this value, the device generates a **Maintenance Demanded** reminder.*

Values	Range: 0 to 20 years
	Default: 0.019 years

- Modify values as required
- Set **Reminder Activation (4.8.4.)** to the desired option.

4.8.7. Maintenance Status

Indicates which level of maintenance reminder is active.

In SIMATIC PDM, open the menu **View – Device Diagnostics**, select **Device Status**, click on the **Maintenance** tab, and check the **Sensor Lifetime Status** window.

4.8.8. Acknowledge Status

Indicates which level of maintenance reminder has been acknowledged.

In SIMATIC PDM, open the menu **View – Device Diagnostics**, select **Device Status**, click on the **Maintenance** tab, and check the **Sensor Lifetime Status** window.



4.8.9. Acknowledge

Acknowledges the current maintenance reminder.

To acknowledge a reminder via SIMATIC PDM:

- a) Open the menu **View – Device Diagnostics**, select **Device Status**, and click on the **Maintenance** tab.
- b) In the **Sensor Lifetime** section click on **Acknowledge Warnings**.

To acknowledge a reminder via the handheld programmer:

- a) Press **RIGHT arrow**  twice to open parameter view and activate **Edit Mode**.
- b) Press **RIGHT arrow**  to acknowledge the reminder

4.9. Service Schedule

Notes:

- Four sets of parameters allow you to monitor the Device/Sensor Lifetimes and set up Service/Calibration schedules, based on operating hours instead of a calendar-based schedule. See also **Remaining Device Lifetime (4.7)**, **Remaining Sensor Lifetime (4.8)**, and **Calibration Schedule (4.10)**.
- Performing a reset to **Factory Defaults** will reset all the Maintenance Schedule parameters to their factory defaults.
- The device operates in years. To view Service Interval parameters in hours or days (via SIMATIC PDM only) see Service Interval (4.9.1).

The device tracks service intervals based on operating hours and monitors the predicted lifetime to the next service. You can modify the Total Service Interval, set schedules for Maintenance Alerts, and acknowledge them.

The maintenance warnings and alarms are communicated via the Status byte. This information can be integrated into any Asset Management system. For optimal use, we recommend that you use SIMATIC PCS7 Asset Management Software in conjunction with SIMATIC PDM.

To access these parameters via SIMATIC PDM:

- Open the menu **Device – Maintenance** and select the **Service Schedule** tab.
- After modifying values/units as required, click on **Write** to accept the change, and **Read** to view the effect of the change.
- Click on **Service Performed** to restart the timer and clear any fault messages.

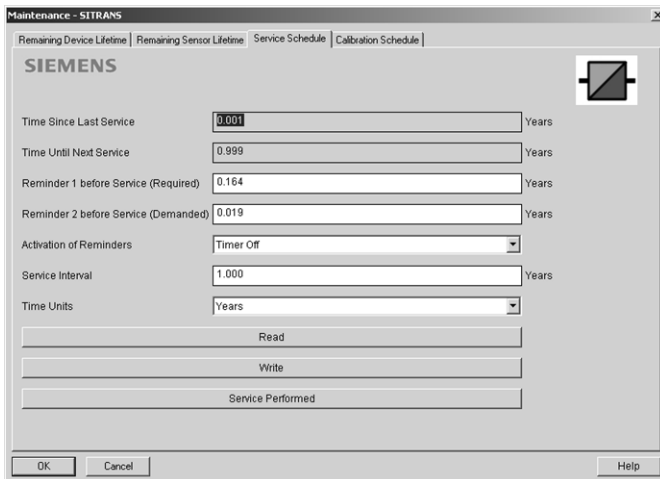

Time Units

Options^{a)}	Hours; days; years
	Default: years

a) Selectable only via SIMATIC PDM.

4.9.1. Service Interval

Note: The device always operates in years. Changing the units affects only the parameter view of the Service Interval parameters in SIMATIC PDM.

User-configurable recommended time between product inspections.

Values	Units ^{a)} : hours, days, years
	Range: 0 to 20 years
	Default: 1.0 year

a) Units are selectable only via SIMATIC PDM.

4.9.2. Time since Last Service

Time elapsed since last service. Can be reset to zero after performing a service.

To reset to zero:

- In SIMATIC PDM, open the menu **Device – Maintenance**, click on the **Service Schedule** tab, and click on **Service Performed** to restart the timer and clear any fault messages.
- Via the handheld programmer, manually reset **Time since Last Service (4.9.2.)** to zero.

4.9.3. Time until Next Service

*Read only. **Service Interval (4.9.1.)** less **Time since Last Service (4.9.2.)**.*

4.9.4. Reminder Activation

Note: To modify this parameter via SIMATIC PDM it must be accessed via the pull-down menu **Device – Maintenance**.

Allows you to enable a maintenance reminder.

Values	*	Timer OFF
		ON NO LIMITS
		ON REMinder 1 (Maintenance Required) checked
		ON REMinders 1 - 2 checked
		ON REMinder 2 (Maintenance Demanded) checked

- First set the values in **Reminder 1 (Required) (4.9.5./Reminder 2 (Demanded) (4.9.6.)**.
- Select the desired **Reminder Activation** option.

4.9.5. Reminder 1 (Required)

*If **Time until Next Service (4.9.3.)** is equal to or less than this value, the device generates a **Maintenance Required** reminder.*

Values	Range: 0 to 20 years
	Default: 0.164 years

- Modify values as required.
- Set **Reminder Activation (4.9.4.)** to the desired option.

4.9.6. Reminder 2 (Demanded)

*If **Time until Next Service (4.9.3.)** is equal to or less than this value, the device generates a **Maintenance Demanded** reminder.*

Values	Range: 0 to 20 years
	Default: 0.019 years

- Modify values as required.
- Set **Reminder Activation (4.9.4.)** to the desired option.

4.9.7. Maintenance Status

Indicates which level of maintenance reminder is active.

Open the menu **View – Device Diagnostics**, select **Device Status**, click on the **Maintenance** tab and check the **Service Schedule Status** window.

4.9.8. Acknowledge Status

Indicates which level of maintenance reminder has been acknowledged.

Open the menu **View – Device Diagnostics**, select **Device Status**, click on the **Maintenance** tab and check the **Service Schedule Status** window.



4.9.9. Acknowledge

Acknowledges the current maintenance reminder.

To acknowledge a reminder via SIMATIC PDM:

- a) Open the menu **View – Device Diagnostics**, select **Device Status**, and click on the **Maintenance** tab.
- b) In the **Service Schedule Status** section click on **Acknowledge Warnings**.

To acknowledge a reminder via the handheld programmer:

- a) Press **RIGHT arrow**  twice to open parameter view and activate **Edit Mode**.
- b) Press **RIGHT arrow**  to acknowledge the reminder.

4.10. Calibration Schedule

Notes:

- Default settings in the parameter tables are indicated with an asterisk (*) unless explicitly stated.
- Four sets of parameters allow you to monitor the Device/Sensor Lifetimes and set up Service/Calibration schedules, based on operating hours instead of a calendar-based schedule. See also **Remaining Device Lifetime (4.7.)**, **Remaining Sensor Lifetime (4.8.)**, and **Service Schedule (4.9.)**.
- Performing a reset to **Factory Defaults** will reset all the Maintenance Schedule parameters to their factory defaults.
- The device operates in years. To view Calibration Interval parameters in hours or days (via SIMATIC PDM only) see **Calibration Interval (4.10.1.)**.

The device tracks calibration intervals based on operating hours and monitors the predicted lifetime to the next calibration. You can modify the Calibration Interval, set schedules for maintenance reminders, and acknowledge them.

To access these parameters via SIMATIC PDM:

- Open the menu **Device – Maintenance** and select the **Calibration Schedule** tab.
- After modifying values/units as required, click on **Write** to accept the change, and **Read** to view the effect of the change.
- Click on **Calibration Performed** to restart the timer and clear any fault messages.

(continued on next page)

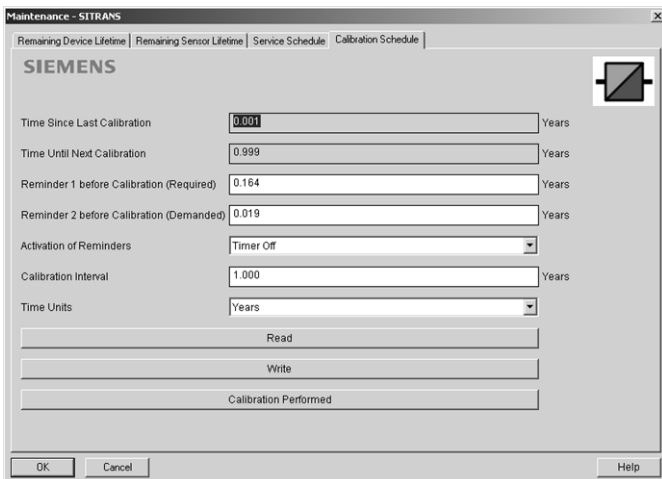

Time Units

Options ^{a)}	Hours; days; years
	Default: years

a) Selectable only via SIMATIC PDM.

4.10.1. Calibration Interval

Note: The device always operates in years. Changing the units affects only the parameter view of the Calibration Interval parameters in SIMATIC PDM.

User-configurable recommended time between product calibrations.

Values	Units ^{a)} : hours, days, years
	Range: 0 to 20 years
	Default: 1.0 year

a) Units are selectable only via SIMATIC PDM.

4.10.2. Time since Last Calibration

Time elapsed since last calibration. Can be reset to zero after performing a calibration.

To reset to zero:

- In SIMATIC PDM, open the menu **Device – Maintenance**, click on the **Calibration Schedule** tab, and click on **Calibration Performed** to restart the timer and clear any fault messages.
- Via the handheld programmer, manually reset **Time since Last Calibration (4.10.2.)** to zero.

4.10.3. Time until Next Calibration

Read only. Calibration Interval (4.10.1.) less Time since Last Calibration (4.10.2.)

4.10.4. Reminder Activation

Note: To modify this parameter via SIMATIC PDM it must be accessed via the pull-down menu **Device – Maintenance**.

Allows you to enable a maintenance reminder.

Values	*	Timer OFF
		ON NO LIMITS
		ON REMinder 1 (Maintenance Required) checked
		ON REMinders 1 - 2 checked
		ON REMinder 2 (Maintenance Demanded) checked

- First set the values in **Reminder 1 (Required) (4.10.5./Reminder 2 (Demanded) (4.10.6.)**.
- Select the desired **Reminder Activation** option.

4.10.5. Reminder 1 (Required)

*If **Time until Next Calibration (4.10.3.)** is equal to or less than this value, the device generates a **Maintenance Required** reminder.*

Values	Range: 0 to 20 years
	Default: 0.164 years

- Modify values as required.
- Set **Reminder Activation (4.10.4.)** to the desired option.

4.10.6. Reminder 2 (Demanded)

*If **Time until Next Calibration (4.10.3.)** is equal to or less than this value, the device generates a **Maintenance Demanded** reminder.*

Values	Range: 0 to 20 years
	Default: 0.019 years

- Modify values as required.
- Set **Reminder Activation (4.10.4.)** to the desired option.

4.10.7. Maintenance Status

Indicates which level of maintenance reminder is active.

In SIMATIC PDM, open the menu **View – Device Diagnostics**, select **Device Status**, click on the **Maintenance** tab, and check the **Calibration Schedule Status** window.

4.10.8. Acknowledge Status

Indicates which level of maintenance reminder has been acknowledged.

In SIMATIC PDM, open the menu **View – Device Diagnostics**, select **Device Status**, click on the **Maintenance** tab, and check the **Calibration Schedule Status** window.



4.10.9. Acknowledge

Acknowledges the current maintenance reminder.

To acknowledge a reminder via SIMATIC PDM:

- a) Open the menu **View – Device Diagnostics**, select **Device Status**, and click on the **Maintenance** tab.
- b) In the **Calibration Schedule Status** section click on **Acknowledge Warnings**.

To acknowledge a reminder via the handheld programmer:

- a) Press **RIGHT arrow**  twice to open parameter view and activate **Edit Mode**.
- b) Press **RIGHT arrow**  to acknowledge the reminder.

5. Communication

Note: Default settings in the parameter tables are indicated with an asterisk (*) unless explicitly stated.

5.1. Device Address

Note: The address can be changed and locked from a remote master. See *PROFIBUS address on page 130* for details on disabling the address lock and **Master Reset (4.2.)** on page 87 to reset Device Address to 126.

Sets the unique address of the device on the network (also called PROFIBUS address).

Values	0 - 126. Default: 126
---------------	-----------------------

To reset Device Address via SIMATIC PDM:

See *Set Address on page 40*.

To change Device Address via the handheld programmer:

See *Device Address on page 37* for details.

5.2. PROFIBUS Ident Number

Identifies the device on the network. The Ident Number must match that in the GSD file (the GSD file provides information on the device to the master).

Options		STD PROFILE	Standard Profile (uses generic GSD for 2 AIFB [ident # = 0x9701])
	*	MANUFACTURER	Manufacturer-specific (uses Siemens EDD and GSD file, which identifies the LR560 [PROFIBUS PA]) [ident # = 0x816B]
		STD – AIFB 1 ONL.	Standard Profile AIFB 1 only (uses generic GSD for 1 AIFB) [ident # = 0x9700]

6. Security

Note: Default settings in the parameter tables are indicated with an asterisk (*) unless explicitly stated.

6.1. Remote Access

6.1.1. Remote Lockout

Note: If access control is changed to limit remote access, it can be reset only via the handheld programmer.

Enables or disables programming via the network and PDM.

Options	*	OFF (Remote operation enabled)
		ON (Remote operation disabled)

6.2. Local Access

6.2.1. Write Protection

Prevents any changes to parameters via PDM or the hand-held programmer.

Hand-held programmer Values	Range: 0 to 9999	
	2457 (unlock value)	Off (enables programming)
	any other value	On (disables programming)

7. Language

Selects the language to be used on the LCD.

Options	*	ENGLISH
		DEUTSCH
		FRANÇAIS
		ESPAÑOL
		CHINESE

To access Language via SIMATIC PDM:

Navigate to **Level Meter > Setup > Local Display.**

Notes

Appendix A: Alphabetical Parameter List

Parameter Name (Parameter Number)	Page Number
AIFB1 (2.5.)	77
AIFB2 (2.6.)	81
Alarms and Warnings (2.5.7.)	79
Algorithm (2.4.5.1.)	71
Allocation (3.6.)	84
Auto False Echo Suppression (2.4.8.1.)	75
Auto False Echo Suppression Range (2.4.8.2.)	75
Average amount (2.8.3.)	82
Calibration (2.3.5.)	67
Calibration Schedule (4.10.)	97
Channel (2.5.3.)	77
CLEF Range (2.4.5.4.)	72
Condensed Status (3.5.)	83
Confidence (2.4.7.1.)	74
Decimal Point (2.5.8.4.)	80
Demo Mode (4.1.)	86
Descriptor (2.1.2.)	65
Device Address (5.1.)	100
Display (2.5.8.)	80
Echo Lock (2.4.6.1.)	73
Echo Profile (3.1.)	82
Echo Quality (2.4.7.)	74
Echo select (2.4.5.)	71
Echo Strength (2.4.7.2.)	74
Echo Threshold (2.4.5.3.)	72
Electronics Temperature (3.4.)	83
Empty rate/Min (2.3.6.3.)	69
Enable (3.5.1.)	83
Event Index (3.6.1.)	84
Event Status (3.6.2.)	85
Event Diagnosis (3.6.3.)	85
Far Range (2.4.2.)	70
Fault Reset (3.2.)	82
Features enabled (3.5.3.)	83
Features supported (3.5.2.)	83
Fill Rate/Min (2.3.6.2.)	69
Filter Time Constant (2.5.8.1.)	80

Parameter Name (Parameter Number)	Page Number
Firmware Revision (2.2.2.)	65
Hardware Revision (2.2.1.)	65
High Calibration Pt. (2.3.5.2.)	67
High Limit Warning (2.5.7.2.)	79
High Limit Alarm (2.5.7.1.)	79
High Level Point (2.3.5.5.)	68
Hover Level (2.4.8.3.)	75
Identification (2.1.)	65
Input Scaling (2.5.5.)	78
Internal Temperature (3.4.3.)	83
Installation Date (2.1.4.)	65
Label (2.5.4.)	78
Language (7.)	101
LCD Backlight (4.5.)	88
LCD Contrast (4.6.)	88
Level Offset (2.3.5.6.)	68
Level Unit (2.3.2.)	66
Limit Hysteresis (2.5.7.5.)	79
Loader Revision (2.2.3.)	65
Local Access (6.2.)	101
LOE Timer (2.3.3.)	66
Low Calibration Pt. (2.3.5.1.)	67
Low Limit Warning (2.5.7.3.)	79
Low Limit Alarm (2.5.7.4.)	79
Low Level Point (2.3.5.4.)	68
Main Output (2.7.1.)	81
Manufacturing Date (2.2.5.)	66
Master Reset (4.2.)	87
Max. Measured Value (3.7.2.)	86
Maximum Output Value - AIFB1 (3.7.4.)	86
Maximum Output Value - AIFB2 (3.7.6.)	86
Maximum Sensor Value (2.4.4.)	70
Maximum Value (3.4.2.)	83
Measured Values (2.7.)	81
Menu timeout (2.2.4.)	66
Message (2.1.3.)	65
Min. Measured Value (3.7.1.)	86
Minimum Output Value - AIFB1 (3.7.3.)	86
Minimum Output Value - AIFB2 (3.7.5.)	86
Minimum Sensor Value (2.4.3.)	70
Minimum Value (3.4.1.)	83

Parameter Name (Parameter Number)	Page Number
Mode (2.5.2.)	77
Narrow Echo Filter (2.8.1.)	81
Near Range (2.4.1.)	69
Output, no level offset (2.7.3.)	81
Output, no linearization (2.7.2.)	81
Output Scaling (2.5.6.)	78
Out Unit Text (2.5.8.3.)	80
Peak Values (3.7.)	86
Position Detect (2.4.5.2.)	71
Powered Hours (4.3.)	87
Power-on Resets (4.4.)	88
PROFIBUS Ident Number (5.2.)	101
Quick Start (1.)	62
Rate (2.3.6.)	68
Reform Echo (2.8.2.)	81
Remaining Device Lifetime (4.7.)	88
Remaining Sensor Lifetime (4.8.)	91
Remote Access (6.1.)	101
Remote Lockout (6.1.1.)	101
Response Rate (2.3.6.1.)	68
Sampling (2.4.6.)	73
Sampling down (2.4.6.3.)	73
Sampling up (2.4.6.2.)	73
Sensor (2.3.)	66
Sensor Offset (2.3.5.3.)	68
Service Schedule (4.9.)	94
Shaper Mode (2.4.8.4.)	75
Signal Processing (2.4.)	69
Static Revision No. (2.5.1.)	77
Tag (2.1.1.)	65
Temperature Unit (2.3.4.)	67
Trend (3.3.)	83
TVT setup (2.4.8.)	75
TVT shaper (2.4.9.)	76
Unit (2.3.1.)	66
Value (2.5.9.2.)	81
Write Protection (6.2.1.)	101

Appendix B: Troubleshooting













Communication Troubleshooting





1. Check the following:
 - There is power at the instrument.
 - The LCD shows the relevant data.
 - The device can be programmed using the hand-held programmer.
 - If any fault codes are being displayed see *Acyclic Extended Diagnostics (General Fault Codes)* on page 138 for a detailed list.
2. Verify that the wiring connections are correct.
3. Check the PROFIBUS address and make sure all devices are at unique PROFIBUS addresses.
4. See the table below for specific symptoms (continued on next page).

Symptom	Corrective action
The device cannot be programmed via the hand-held programmer.	<ul style="list-style-type: none">• Make sure Write Protection (6.2.1.) on page 101 is set to the unlock value.
You try to set a SITRANS LR560 parameter via remote communications but the parameter remains unchanged.	<ul style="list-style-type: none">• Ensure Remote Lockout (6.1.1.) on page 101 is disabled.• Ensure Write Protection (6.2.1.) on page 101 is set to the unlock value.• See <i>To reset the PROFIBUS address to 126:</i> on page 55 to disable an address lock.
The PLC value equals the display value but does not correspond to actual material level.	<ul style="list-style-type: none">• Ensure Scaling in AIFB1 is correctly entered.• Ensure High Calibration Point is correctly entered.• View the echo profile to see if the wrong echo is being selected. If so, see <i>Operation Troubleshooting</i> on page 112 for possible causes and corrective action.
The PLC value is not equal to the displayed value (regardless of actual material level).	<ul style="list-style-type: none">• Confirm you are looking at the right spot in the PLC.• Ensure scaling has not been programmed into the PLC: all scaling should be performed by the LR560.• Check the network to ensure the PCL is communicating with the LR560.

If you continue to experience problems, go to our website at: www.siemens.com/LR560, and check the FAQs for SITRANS LR560, or contact your Siemens Milltronics representative.

Device Status Icons

Icon	Priority Level	Meaning
	1	<ul style="list-style-type: none"> • Maintenance alarm • Measurement values are not valid
	2	<ul style="list-style-type: none"> • Maintenance warning: maintenance demanded immediately • Measured signal still valid
	3	<ul style="list-style-type: none"> • Maintenance required • Measured signal still valid
	1	<ul style="list-style-type: none"> • Process value has reached an alarm limit
	2	<ul style="list-style-type: none"> • Process value has reached a warning limit
	3	<ul style="list-style-type: none"> • Process value has reached a tolerance limit
	1	<ul style="list-style-type: none"> • Configuration error • Device will not work because one or more parameters/components is incorrectly configured
	2	<ul style="list-style-type: none"> • Configuration warning • Device can work but one or more parameters/components is incorrectly configured
	3	<ul style="list-style-type: none"> • Configuration changed • Device parameterization not consistent with parameterization in project. Look for info text.
	1	<ul style="list-style-type: none"> • Manual operation (local override) • Communication is good; device is in manual mode.
	2	<ul style="list-style-type: none"> • Simulation or substitute value • Communication is good; device is in simulation mode or works with substitute values.
	3	<ul style="list-style-type: none"> • Out of operation • Communication is good; device is out of action.



Icon	Priority Level	Meaning (cont'd)
		<ul style="list-style-type: none"> Data exchanged
		<ul style="list-style-type: none"> No data exchange
		<ul style="list-style-type: none"> Write access enabled
		<ul style="list-style-type: none"> Write access disabled

General Fault Codes









Notes:

- The status icon shown associated with each fault is the default icon in Condensed Mode.
- If more than one fault is present, the device status indicator and text for each fault alternate at 2 second intervals.
- Some faults cause the device to go to Fail-safe mode. These are indicated with an asterisk (*).









General Fault Codes

Code / Icon	Meaning	Corrective Action
S:0 	* The device was unable to get a measurement within the Fail-safe LOE Timer period. Possible causes: faulty installation, antenna material buildup, foaming/other adverse process conditions, invalid calibration range.	<ul style="list-style-type: none"> Ensure installation details are correct. Ensure no material buildup. Clean if necessary. Adjust process conditions to minimize foam or other adverse conditions. Correct range calibration. If fault persists, contact your local Siemens representative.
S:2 	* Unable to collect profile because of a power condition that is outside the operating range of the device.	Repair required. Contact your local Siemens representative.









General Fault Codes (cont'd)

Code / Icon	Meaning	Corrective Action
S: 3 	Device is nearing its lifetime limit according to the value set in Reminder 1 (Required) (4.7.5.) .	Replacement is recommended.
S: 4 	Device is nearing its lifetime limit according to the value set in Reminder 2 (Demanded) (4.7.6.) .	Replacement is recommended.
S: 6 	Sensor is nearing its lifetime limit according to the value set in Reminder 1 (Required) (4.8.5.) .	Replacement is recommended.
S: 7 	Sensor is nearing its lifetime limit according to the value set in Reminder 2 (Demanded) (4.8.6.) .	Replacement is recommended.
S: 8 	Service interval as defined in Reminder 1 (Required) (4.9.5.) has expired.	Perform service.
S: 9 	Service interval as defined in Reminder 2 (Demanded) (4.9.6.) has expired.	Perform service.
S:10 	Input parameters Low Calibration Pt. (2.3.5.1.) and High Calibration Pt. (2.3.5.2.) are the same.	<ul style="list-style-type: none"> • Check calibration settings of device. • Ensure settings for High Calibration Point and Low Calibration Point are different.
S: 11 	Internal temperature sensor failure.	Repair required: contact your local Siemens representative.



General Fault Codes (cont'd)

Code / Icon	Meaning	Corrective Action
S: 12 	Internal temperature of device has exceeded specifications: it is operating outside its temperature range.	<ul style="list-style-type: none"> • Relocate device and/or lower process temperature enough to cool device. • Inspect for heat-related damage and contact your local Siemens representative if repair is required. • Fault code will persist until a manual reset is performed using PDM or the LCD interface.
S:14 	Input Scaling (2.5.5.) Upper and lower values for AIFB1 are the same.	<ul style="list-style-type: none"> • Check configuration for AIFB1. • Ensure that Upper Value and Lower Value (Input Scaling) are not the same.
S:15 	Input Scaling (2.5.5.) Upper and lower values for AIFB2 are the same.	<ul style="list-style-type: none"> • Check configuration for AIFB2. • Ensure that Upper Value and Lower Value (Input Scaling) are not the same.
S: 17 	Calibration interval as defined in Reminder 1 (Required) (4.10.5.) has expired.	Perform calibration.
S: 18 	Calibration interval as defined in Reminder 2 (Demanded) (4.10.6.) has expired.	Perform calibration.
S:25 	Internal error.	Reset power. If fault persists, contact your local Siemens representative.
S: 27 	Internal device failure caused by an External RAM memory error.	Repair required: contact your local Siemens representative.
S: 28 	* Internal device failure caused by a RAM memory error.	Repair required: contact your local Siemens representative.

General Fault Codes (cont'd)



Code / Icon	Meaning	Corrective Action
S: 29 	* EEPROM damaged.	Repair required: contact your local Siemens representative.
S: 30 	EEPROM corrupt.	Reset power. If fault persists, contact your local Siemens representative.
S: 31 	* Flash error.	Repair required: contact your local Siemens representative.
S: 32 	IDENT number conflict.	Ensure value of the Ident number selector is correct for the network configuration. If it is correct, the device needs to be re-parameterized by the PLC.
S: 33 	* Factory calibration for the internal temperature sensor has been lost.	Repair required: contact your local Siemens representative.
S: 34 	* Factory calibration for the device has been lost.	Repair required: contact your local Siemens representative.
S:39 	Transducer temperature sensor failure.	Repair required: contact your local Siemens representative.
S:40 	Transducer temperature too high.	Relocate device and/or lower process temperature enough to cool device. Inspect for heat-related damage and contact your local Siemens representative if repair is required.

General Fault Codes (cont'd)

Code / Icon	Meaning	Corrective Action
S: 41 	Transducer temperature too low.	Relocate device and/or raise process temperature enough to warm device. Inspect for temperature-related damage and contact your local Siemens representative if repair is required.
S:64 to S:83 	Device error. NOTE: Fault text and icons appear only on LCD.	Repair required. Contact your local Siemens representative.
S:94 to S:108 	Device error. NOTE: Fault text and icons appear only on LCD.	Repair required. Contact your local Siemens representative.

Operation Troubleshooting

Operating symptoms, probable causes, and resolutions (continued on next page).

Operation Troubleshooting		
Symptom	Cause	Action
Display shows  S: 0 LOE	level or target is out of range	<ul style="list-style-type: none"> • check specifications • check Low Calibration Pt. (2.3.5.1) • increase Confidence (2.4.7.1)
Display shows  S: 0 LOE	material build-up on antenna	<ul style="list-style-type: none"> • Use the air purge feature to clean the antenna • re-locate SITRANS LR560
Display shows  S: 0 LOE	location or aiming: <ul style="list-style-type: none"> • poor installation • flange not level • Auto False Echo Suppression may be incorrectly applied 	<ul style="list-style-type: none"> • check to ensure nozzle is vertical • ensure end of antenna protrudes from end of nozzle. • review <i>Auto False Echo Suppression (2.4.8.1)</i> on page 118 • ensure Auto Suppression Range is set correctly

Operation Troubleshooting (cont'd)

Symptom	Cause	Action
Display shows  S: 0 LOE	antenna malfunction: <ul style="list-style-type: none"> • temperature too high • physical damage 	<ul style="list-style-type: none"> • check temperature in Maximum Value (3.4.2) • relocate
Reading does not change, but the level does	SITRANS LR560 processing wrong echo, i.e. vessel wall, or structural member	<ul style="list-style-type: none"> • re-locate SITRANS LR560 • check nozzle for internal burrs or welds • rotate instrument 90° • use Auto False Echo Suppression (2.4.8.1) if necessary: see <i>Auto False Echo Suppression (2.4.8.1)</i> on page 118
Measurement is consistently off by a constant amount	<ul style="list-style-type: none"> • setting for Low Calibration Pt. not correct • setting for Sensor Offset not correct 	<ul style="list-style-type: none"> • check distance from sensor reference point to Low Calibration Pt. (2.3.5.1) • check Sensor Offset (2.3.5.3)
Screen blank	power error	<ul style="list-style-type: none"> • check nameplate rating against voltage supply • check power wiring or source
Reading erratic	echo confidence weak	<ul style="list-style-type: none"> • refer to Confidence (2.4.7.1) • use Auto False Echo Suppression (2.4.8.1) and Auto False Echo Suppression Range (2.4.8.2)
	material filling	<ul style="list-style-type: none"> • re-locate SITRANS LR560
Reading response slow	Fill Rate/Min (2.3.6.2) setting is incorrect	<ul style="list-style-type: none"> • increase measurement response if possible
Reads correctly but occasionally reads high when vessel is not full	<ul style="list-style-type: none"> • detecting close range echo • build up near top of vessel or nozzle • nozzle problem 	<ul style="list-style-type: none"> • Use the air purge feature to clean the antenna • use Auto False Echo Suppression (2.4.8.1) and Auto False Echo Suppression Range (2.4.8.2)
Level reading lower than material level	<ul style="list-style-type: none"> • material is within Near Range zone • multiple echoes processed 	<ul style="list-style-type: none"> • decrease Near Range (2.4.1): minimum value depends on antenna type • raise SITRANS LR560 • ensure Algorithm (2.4.5.1) is set to tF (trueFirst echo)

Appendix C: Maintenance

SITRANS LR560 requires no maintenance or cleaning under normal operating conditions.

Under severe operating conditions, the antenna may require periodic cleaning. If cleaning becomes necessary:

- Note the antenna material and the process medium, and select a cleaning solution that will not react adversely with either.
- Remove the instrument from service and wipe the antenna clean using a cloth and suitable cleaning solution.

Unit Repair and Excluded Liability

All changes and repairs must be done by qualified personnel, and applicable safety regulations must be followed. Please note the following:

- The user is responsible for all changes and repairs made to the device.
- All new components must be provided by Siemens Milltronics Process Instruments Inc.
- Restrict repair to faulty components only.
- Do not re-use faulty components.
- Contact your local Siemens representative for a list of spare part.

Appendix D: Technical Reference

Note: Where a number follows the parameter name (for example, **Algorithm (2.4.5.1)**) this is the parameter access number via the local control buttons or the handheld programmer. See *Parameter Reference* on page 62 for a complete list of parameters.

Principles of Operation

SITRANS LR560 is a 2-wire 78 GHz FMCW (Frequency Modulated Continuous Wave) radar level transmitter for continuous monitoring of solids in vessels¹⁾. Radar level measurement uses the time of flight principle to determine distance to a material surface.

FMCW radar transmits a continuous wave. The frequency of the wave is constantly increasing: this is known as the sweep. By the time the first part of the wave has been reflected off the target and returned to the device, the part of the wave that is just being emitted is at a higher frequency. The difference in frequency between the transmitted and received signals is proportional to time of flight.

Electromagnetic wave propagation is virtually unaffected by temperature or pressure changes, or by changes in the vapor levels inside a vessel. Electromagnetic waves are not attenuated by dust.

SITRANS LR560 consists of an enclosed electronic circuit coupled to an antenna and process connection. The electronic circuit generates a radar signal (78 GHz) that is directed to the lens antenna.

The signal is emitted from the lens antenna, and the reflected echoes are digitally converted to an echo profile. The profile is analyzed to determine the distance from the sensor reference point²⁾ to the material surface. This value (sensor value) is used as a basis for calculating the display of material level.

Process Variables

The Process Variables are sensor value and measured value. Sensor value is the distance from the sensor reference point (flange face) to the material surface. The measured value can be either Level (distance from low calibration point to material surface), Distance (distance from sensor reference point to the material surface), or Space (distance from high calibration point to the material surface).

Echo Processing

Process Intelligence

The signal processing technology embedded in Siemens radar level devices is known as **Process Intelligence**.

Process intelligence provides high measurement reliability regardless of the dynamically changing conditions within the vessel being monitored. The embedded Process Intelligence dynamically adjusts to the constantly changing material surfaces within these vessels.

¹⁾ The microwave output level is significantly less than that emitted from cellular phones.

²⁾ See *Dimensions* on page 12.

Process Intelligence is able to differentiate between the true microwave reflections from the surface of the material and unwanted reflections being returned from obstructions such as seam welds or supports within a vessel. The result is repeatable, fast and reliable measurement. This technology was developed as result of field data gained over some twenty years from more than 1,000,000 installations in many industries around the world.

Higher order mathematical techniques and algorithms are used to provide intelligent processing of microwave reflection profiles. This “knowledge based” technique produces superior performance and reliability.

Echo Selection

Time Varying Threshold (TVT)

A Time Varying Threshold (TVT) hovers above the echo profile to screen out unwanted reflections (false echoes).

In most cases the material echo is the only one which rises above the default TVT.

In a vessel with obstructions, a false echo may occur. See *Auto False Echo Suppression (2.4.8.1.)* on page 118 for more details.

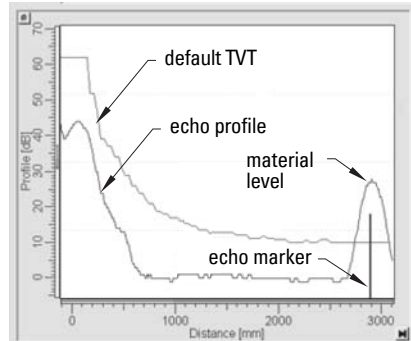

The device characterizes all echoes that rise above the TVT as potential good echoes. Each peak is assigned a rating based on its strength, area, height above the TVT, and reliability, amongst other characteristics.

Algorithm (2.4.5.1.)

The true echo is selected based on the setting for the Echo selection algorithm. For a list of options see **Algorithm (2.4.5.1.)** on page 71.

Position Detect (2.4.5.2.)

The echo position detection algorithm determines which point on the echo will be used to calculate the precise time of flight, and calculates the range using the calibrated propagation velocity. The following options are available:

- **Rising**
- **Center**
- **Hybrid**
- **CLEF** (Constrained Leading Edge Fit)

Rising

Uses rising edge of the echo.

Center

Uses center of the echo.

Hybrid

Uses the Center algorithm for the top part of the vessel, and the CLEF algorithm for the part nearest the vessel bottom, according to the setting for **CLEF range**.

CLEF (Constrained Leading Edge Fit)

- Uses the leading edge of the echo.
- Is used mainly to process the echo from materials with a low dK value.

In an almost empty flat-bottomed vessel, a low dK material may reflect an echo weaker than the echo from the vessel bottom. The echo profile shows these echoes merging. The device may then report a material level equal to or lower than empty

The CLEF algorithm enables the device to report the level correctly.

Example: CLEF off: Position set to Hybrid

Vessel height: 1.5 m; CLEF range set to 0 (Center algorithm gives the same result.)

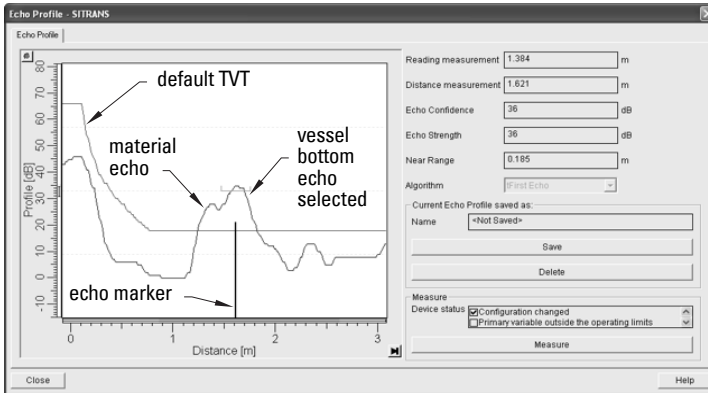

Example: CLEF enabled

Vessel height: 1.5 m; CLEF range set to 0.5 m

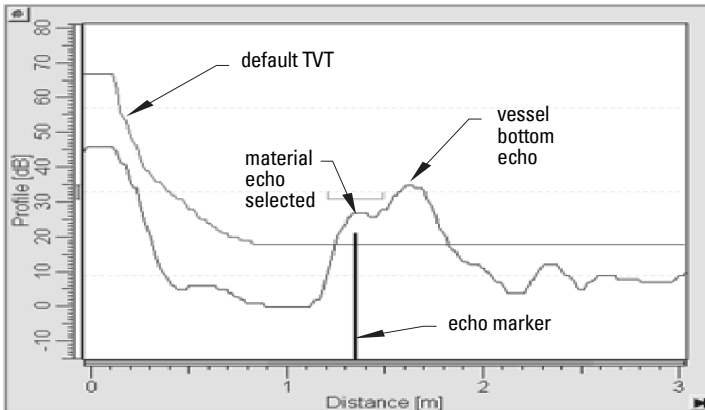

CLEF Range (2.4.5.4.)

Determines the level below which the CLEF algorithm will be used. Above this level the Center algorithm is used when Hybrid is selected in **Position Detect (2.4.5.2.)**.

CLEF Range is referenced from Far Range.

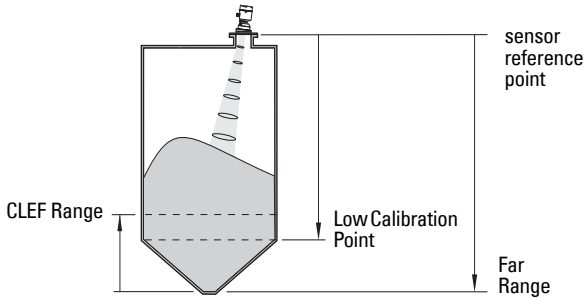

Echo Threshold (2.4.5.3.)

Confidence (2.4.7.1.) describes the quality of an echo. Higher values represent higher quality. **Echo Threshold** defines the minimum confidence value required for an echo to be accepted as valid and evaluated.

Echo Lock (2.4.6.1.)

If the echo selected by **Algorithm** is within the Echo Lock window, the window is centered about the echo, which is used to derive the measurement. In radar applications, two measurement verification options are used:

Lock Off

SITRANS LR560 responds immediately to a new selected echo (within the restrictions set by the Maximum Fill / Empty Rate), but measurement reliability is affected.

Material Agitator

A new measurement outside the Echo Lock Window must meet the sampling criteria before the window will move to include it.

The other available options, **Maximum Verification** and **Total Lock** are not recommended for radar.

Auto False Echo Suppression (2.4.8.1.)

Notes:

- For detailed instructions on using this feature via PDM see *Auto False Echo Suppression* on page 48.
- For detailed instructions on using this feature via the handheld programmer see **Auto False Echo Suppression (2.4.8.1.)** on page 75.

Auto False Echo Suppression is designed to learn a specific environment (for example, a particular vessel with known obstructions), and in conjunction with Auto False Echo Suppression Range to remove false echoes appearing in front of the material echo.

The material level should be below all known obstructions at the moment when Auto False Echo Suppression learns the echo profile. Ideally the vessel should be empty or almost empty, and if an agitator is present, it should be running.

The device learns the echo profile over the whole measurement range and the TVT is shaped around all echoes present at that moment.

Auto False Echo Suppression Range (2.4.8.2.)

Auto False Echo Suppression Range specifies the range within which the learned TVT is applied. Default TVT is applied over the remainder of the range.

The learned TVT screens out the false echoes caused by obstructions. The default TVT allows the material echo to rise above it.

Auto False Echo Suppression Range must be set to a distance shorter than the distance to the material level when the environment was learned, to avoid the material echo being screened out.

Example before Auto False Echo Suppression

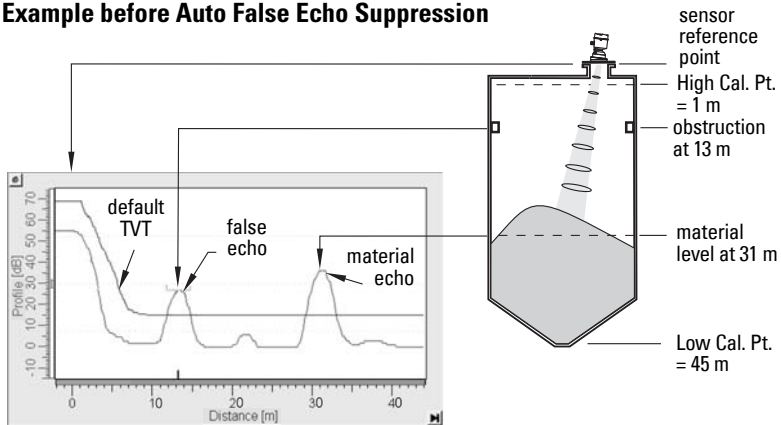

Example after Auto False Echo Suppression

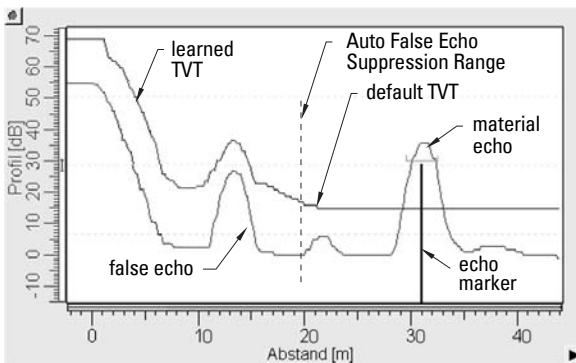

Auto False Echo Suppression Range set to 20 m

Measurement Range

Near Range (2.4.1.)

Near Range programs SITRANS LR560 to ignore the zone in front of the antenna. The default blanking distance is 27.8 cm (0.91 ft) from the sensor reference point.

Near Range allows you to increase the blanking value from its factory default. But Auto False Echo Suppression (2.4.8.1.) is generally recommended in preference to extending the blanking distance from factory values.

Far Range (2.4.2.)

Far Range allows the echo processing to see and process signals that are lower than the Low Calibration setting.

Potential uses are:

- In applications where the base of the vessel is conical or parabolic. A reliable echo may be available below the vessel empty distance, due to an indirect reflection path. Increasing Far Range to 30% or 40% can provide stable empty vessel readings.
- Where Low Calibration setting is above vessel empty level, but the vessel is emptied occasionally. In this case the echo will be tracked below the Low Calibration setting and the device will maintain a zero level reading.

Measurement Response

Note: Units are defined in **Unit (2.3.1.)** and are in meters by default.

Response Rate (2.3.6.1.) limits the maximum rate at which the display and output respond to changes in the measurement. There are three preset options: slow, medium, and fast.

Once the real process fill/empty rate (m/min by default) is established, a response rate can be selected that is slightly higher than the application rate. Response Rate automatically adjusts the filters that affect the output response rate

	Response Rate (2.3.6.1.)	Fill Rate/Min (2.3.6.2.)/Empty rate/Min (2.3.6.3.)	Filter Time Constant (2.5.8.1.)
	Slow	0.1 m/min (0.32 ft/min)	10 s
*	Medium	1.0 m/min (3.28 ft/min)	10 s
	Fast	10.0 m/min (32.8 ft/min)	0 s

Damping

Filter Time Constant (2.5.8.1.) smooths out the response to a sudden change in level. This is an exponential filter and the engineering unit is always in seconds.

In 5 time constants the output rises exponentially: from 63.2% of the change in the first time constant, to almost 100% of the change by the end of the 5th time constant.

Damping example

time constant = 2 seconds

input (level) change = 2 m

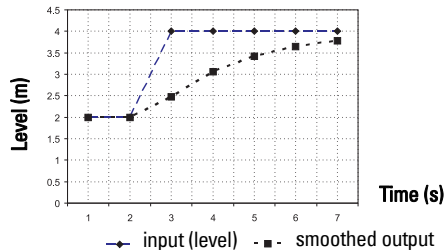

Loss of Echo (LOE)

A loss of echo (LOE) occurs when the calculated measurement is judged to be unreliable because the echo confidence value has dropped below the echo confidence threshold.

Confidence (2.4.7.1.) describes the quality of an echo. Higher values represent higher quality.

Echo Threshold (2.4.5.3.) defines the minimum confidence value required for an echo to be accepted as valid and evaluated.

If the LOE condition persists beyond the time limit set in **LOE Timer (2.3.3.)** the LCD displays the Service Required icon, and the text region displays the fault code **S: 0** and the text **LOE**.

If two faults are present at the same time, the fault code, error text, and error icon for each fault are displayed alternately. For example, Loss of Echo and faulty power supply:



Upon receiving a reliable echo, the loss of echo condition is aborted, the Service Required icon and error message are cleared, and the reading returns to the current level.

LOE Timer

LOE Timer (2.3.3.) determines the length of time a Loss of Echo (LOE) condition will persist before a Fail-safe state is activated. The default is 100 seconds. Fail-safe Mode determines the level to be reported when the Fail-safe timer expires.

Fail-safe Behavior

The purpose of the Fail-safe setting is to put the process into a safe mode of operation in the event of a fault or failure. The value to be reported in the event of a fault is selected so that a loss of power or loss of signal triggers the same response as an unsafe level.

Fail-safe mode may be triggered by a loss of echo, a bad configuration, or certain device faults. You can select one of three possible values to be reported when a Fail-safe mode is activated.

Mode (2.5.9.1.)

Mode determines the material level to be reported when **LOE Timer (2.3.3.)** expires.

Mode (2.5.9.1.)		
SUB VALUE		Use substitute value. Value (2.5.9.2.) used as output value.
LAST VALUE	*	Last value (Store last valid output value).
USE BAD VALUE		Use bad value (Calculated output value is incorrect).

Value (2.5.9.2.)

Value defines the material level to be reported if the option **Use substitute value** is selected in **Mode (2.5.9.1.)**.

The two Analog Input Function blocks are set separately.

To set a user-defined value

- Navigate to the Level Meter > Setup > desired Analog Input (1 or 2).
- Set **Mode (2.5.9.1.)** to **Use substitute value**.
- Go to **Value (2.5.9.2.)** and enter the desired value.

Temperature derating curve



WARNINGS:

- Never attempt to loosen, remove or disassemble process connection or instrument housing while vessel contents are under pressure.
- This product is not intended for use as a safety device per Directive 97/23/EC.
- The user is responsible for the selection of bolting and gasket materials which will fall within the limits of the flange and its intended use and which are suitable for the service conditions.
- Improper installation may result in loss of process pressure and/or release of process fluids and/or gases.

ambient temperature
-40 °C to 80 °C
(-40 °F to 176 °F)

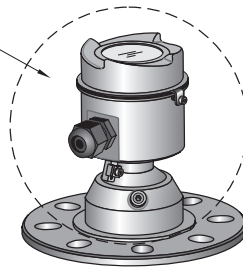

process temperature:
-40 to +100 °C (-40 to +212 °F) or
-40 to +200 °C (-40 to +392 °F) depending on the version

Temperature De-Rating

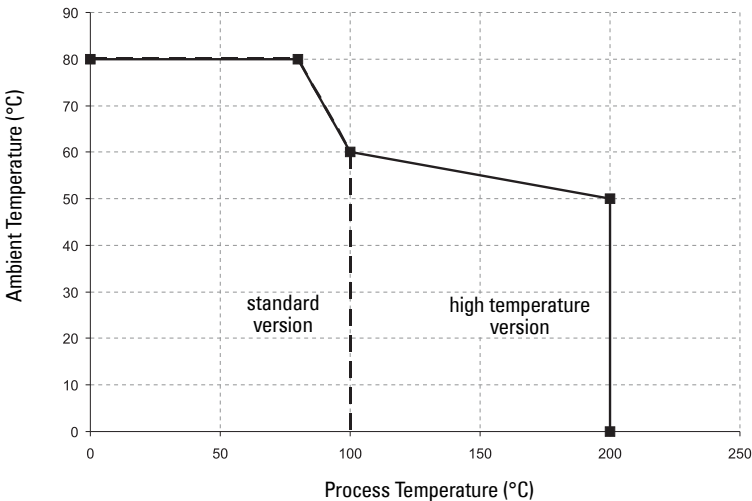

Appendix E: PROFIBUS PA Profile Structure

PROFIBUS Level Device Design

The device follows the profile block model and is implemented as a Profile 3.01, Class B, PA device. Standard profile parameters are used to program the level transducer block.

Block Model

The Block Model represents how measured values are recorded and processed. All data is viewed from the perspective of the DCS or PLC, so information from the sensor is an input.

The functions of the device are divided into blocks with different areas of responsibility. The blocks are configured by parameters.

The device is implemented with one Physical Block, one Transducer Block (TB), and two Analog Input Function Blocks (AIFB1 and AIFB2).

Physical Block

The Physical Block handles functionality and descriptions relating to the device as a whole: for example, LCD Contrast (functionality) and Firmware Revision and Tag (descriptions).

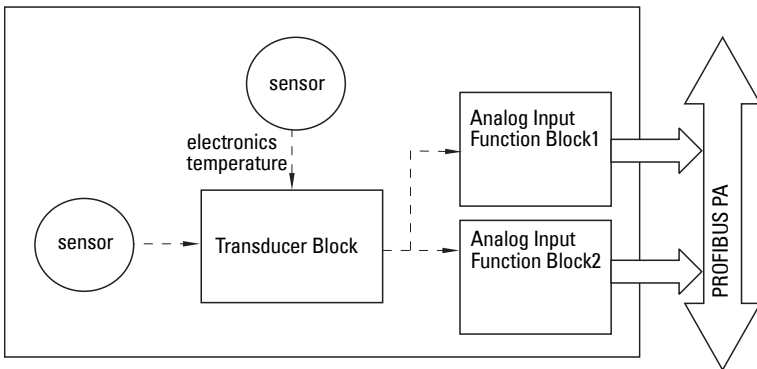

Transducer Block (TB)

The Transducer Block carries out adjustments to the sensor, such as level calibration (and volume calibration, if supported). It supplies the measured value¹⁾ utilized by either or both of the AIFBs.

Analog Input Function Blocks AIFB1 and AIFB2

The two AIFBs are identical and completely independent of each other. They utilize the measured value¹⁾ output from the Transducer Block and apply any required quality checks, scaling, and Fail-safe operation selections.

The output from the Analog Input Function Block supplies the measured value with associated status information to the PROFIBUS PA network via cyclic data transfer.

¹⁾ Primary Value (PV), Secondary Value 1 (SV1), or Secondary Value 2 (SV2)

- 2) Level Calibration is a linear transfer function that converts a sensor value to a level value.¹⁾²⁾

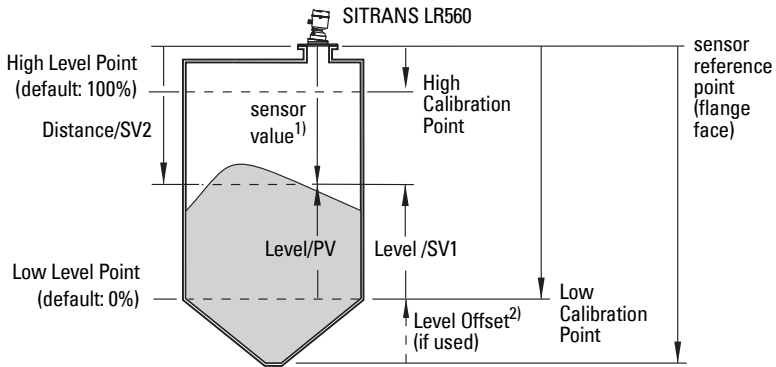
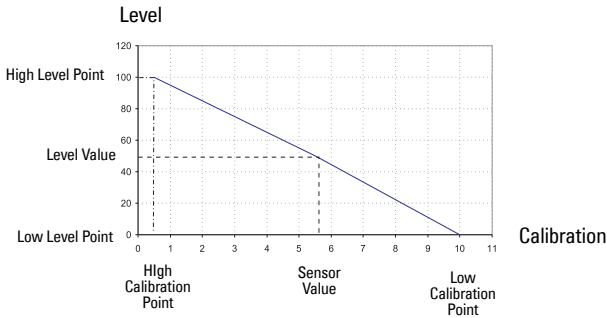

- 3) The Transducer Block provides three possible outputs
- Primary Value (PV): Level (level units)³⁾
 - Secondary Value 1 (SV1): Level (level units)
 - Secondary Value 2 (SV2): Distance (sensor units)

1) **Sensor Offset (2.3.5.3)** is a constant offset (negative or positive) that can be added to sensor value to compensate if the sensor has been changed.

2) Level Offset (default 0) can compensate for specific vessel configurations.

3) LR560 PA does not support Volume.

Electronics temperature

The Transducer Block monitors the internal temperature of the device electronics. A change in temperature can provide advance warning of a possible device failure, and allow for preventive maintenance.

If a temperature limit is exceeded, the output value is unchanged but the output status changes. (The permitted limits correspond to those of the permitted ambient temperature.)

Peak indicators¹⁾ allow you to check the maximum and minimum temperatures that have occurred.

AIFB (simulation, mode and status)

The input to the AIFB is a value with a status. The figure below shows how Measured values are processed within an Analog Input Function Block to produce the device output (communicated via cyclic transfer to PROFIBUS PA and displayed on the LCD).

How an Analog Input Function Block works

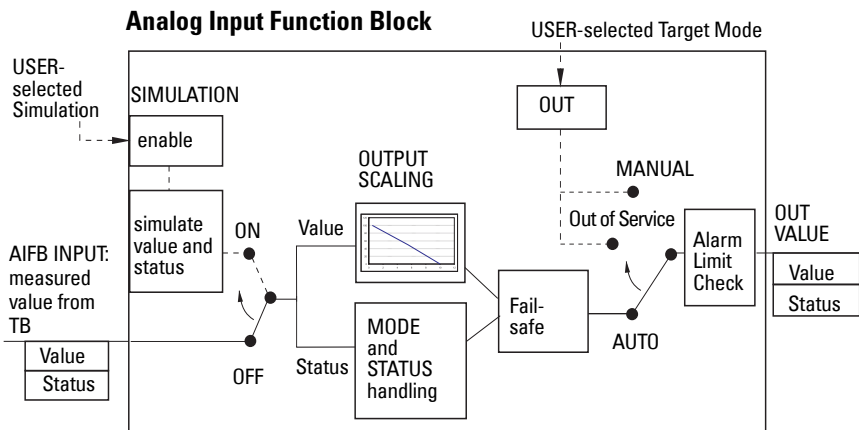

The AIFB provides a linear conversion to any desired units.

- 1) The value input to the AIFB is the measured value output from the Transducer Block, in sensor units.
- 2) You can select any standard engineering units, or define a special unit, for the AIFB output. Then scaling is applied.

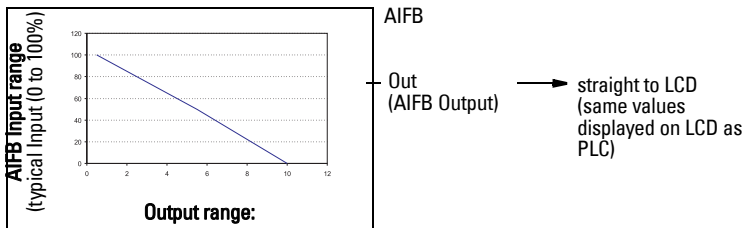

(continued on next page)

- 1) Open the menu **View – Device Diagnostics**, select **Device Status**, and click on the tab **Device Status** to see peak temperature values.

- 3) Damping may be applied based on a user-selected time constant (see *Damping* on page 121 for details).
- 4) The status of the input value received from the Transducer Block is checked. If the status is Bad, a Fail-safe condition occurs. The setting for Fail-safe Mode determines the Fail-safe value to be output.
- 5) **Mode (2.5.2.)** allows the entire AI block to be overridden by a Manual Output value. See *Simulate Output* on page 53 for details.
- 6) The value is checked against the user-defined warning and alarm limits. The upper and lower limits are defined in units corresponding to the Output range, and a limit hysteresis can be used to adjust the sensitivity. See **Alarms and Warnings (2.5.7.)** on page 79 for the specific parameters.
- 7) The output value (OUT) is communicated via cyclic data transfer.

Appendix F: Communications via PROFIBUS PA

SITRANS LR560 (PROFIBUS PA) is a Profile Version 3.01, Class B, PA device. It supports Class 1 Master for cyclic and acyclic data exchange, and Class 2 for acyclic services. The full range of SITRANS LR560 functions is available only over a PROFIBUS PA network.

PROFIBUS PA is an open industrial protocol. Full details about PROFIBUS PA can be obtained from PROFIBUS International at www.profibus.com.

Device Configuration tool

To use PROFIBUS PA, you will need a PC configuration tool: we recommend SIMATIC PDM. Please consult the operating instructions or online help for details on using SIMATIC PDM. (You can find more information at www.fielddevices.com: go to **Products and Solutions > Products and Systems > Communications and Software > Process Device Manager**.)

SIMATIC PDM

SIMATIC PDM is a software package used to commission and maintain SITRANS LR560 and other process devices. For more detail see *Functions in SIMATIC PDM* on page 39.

Electronic Device Description

In order to use **Process Device Manager (PDM)** with PROFIBUS PA, you will need the Electronic Device Description for SITRANS LR560. For details see *Electronic Device Description (EDD)* on page 39.

Network Configuration

To configure a PROFIBUS PA Class 1 Master (for example, a PLC), you will need a **GSD** file.

The GSD file

The GSD file **SIEM816B.gsd** is available from the SITRANS LR560 product page on our web site at www.siemens.com/LR560. Go to **Support > Software Downloads**.

Bus Termination

Note: PROFIBUS PA **MUST** be terminated at both extreme ends of the cable for it to work properly. Please refer to the PROFIBUS PA User and Installation Guidelines (order number 2.092), available from www.profibus.com.

Power Demands

To determine how many devices can be connected to a bus line, calculate the combined maximum current consumption of all the connected devices: 13.5 mA for SITRANS LR560. Allow a current reserve for safety.

PROFIBUS address

A unique PROFIBUS address identifies each device on the network. To set the PROFIBUS address see **Device Address (5.1.)** on page 100.

Notes:

- It is possible to change the device address via a Class 1 master (for example, a PLC) and lock the device address to prevent further changes.
- If this Address Lock is on, the PA address cannot be changed. This lock can be disabled only by performing an Address Reset.

Resetting the PROFIBUS address to 126

- Via SIMATIC PDM:
 - a) Open the menu **Device – Master Reset** and click on **Reset Address to 126**.
 - b) Click on **OK**: the address will be reset to 126, and if the address lock was on, it will be disabled.
- Via the handheld programmer:
 - a) Navigate to **Service (4.) > Master Reset (4.2.)**. (You can enter the numeric value instead of navigating via the Arrow keys.)
 - b) Press **RIGHT Arrow** to open Edit Mode then scroll down to **DEV ADDRESS** and press **RIGHT Arrow** to select it. The address will be reset to 126, and if the address lock was on, it will be disabled.
 - c) Press **LEFT Arrow** to exit.

Operating as a Profile Device

Every manufactured PROFIBUS product has a unique PROFIBUS identification number which identifies it to the system. PROFIBUS Profile Standard version 3.01 also defines a Profile Model which can identify a product as a generic profile device on the network.

SITRANS LR560 can be identified in one of three ways:

	Device Identification	Profile Model
	STD PROFILE	Standard Profile (uses generic GSD for 2 AIFB [ident # = 0x9701])
*	MANUFACTURER	Manufacturer-specific (uses Siemens EDD and GSD file, which identifies the LR560 [PROFIBUS PA]) [ident # = 0x816B]
	STD – AIFB 1 ONLY	Standard Profile AIFB 1 only (uses generic GSD for 1 AIFB) [ident # = 0x9700]

Defining the device as Profile-specific as opposed to Manufacturer-specific makes it possible to exchange the device for any other device of the same profile type without changing the GSD file.

To set up SITRANS LR560 as a profile device see **PROFIBUS Ident Number (5.2.)** on page 101.

Configuring a device

See *Configuring a new device* on page 40.

Configuring PROFIBUS PA with an S7-300/ 400 PLC

- 1) If SITRANS LR560 is not listed in the STEP 7 device catalog, you can download the GSD file from the Siemens Web site and import it into Step 7. Go to www.siemens.com/LR560 and click **Downloads**.
- 2) Add the SITRANS LR560 "rack": click and drag the SITRANS LR560 folder from the hardware catalog.
- 3) Fill the rack with desired modules, by dragging and dropping them from the hardware catalog.
- 4) After configuring PROFIBUS PA in steps 2 and 3, download it to the PLC.
- 5) Add code to the PLC program to read data consistently using the SFC14.

Cyclic versus Acyclic Data

When you request data from a device via PROFIBUS PA, you have two choices. Cyclic data is provided at every bus scan; acyclic data is requested and provided as needed.

Input information is always requested at every bus scan and is set up as cyclic data. Configuration information is only needed periodically and is set up as acyclic data.

Cyclic Data

When you configure SITRANS LR560 on the PROFIBUS PA bus, there are two slots available for modules.

Note: Each of the slots has to have a module defined in it.

Slot 0 always transmits **AIFB1** information¹⁾; slot 1 defaults to Free Place, but can be changed to **AIFB2** information. If you do not wish to have data transmitted, then you must use a **Free Place** module in that slot.

Each of the two Analog Input Function Blocks can be set up to return **Level**, or **Distance**. Within the function blocks, the values are scaled according to the user requirements (please see *AIFB (simulation, mode and status)* on page 127 for details).

(continued on next page)

¹⁾ For more information, please see *AIFB (simulation, mode and status)* on page 127.

AIFB1 and **AIFB2** return 5 bytes of data each:

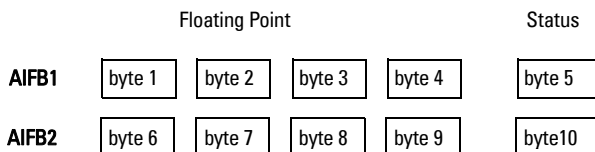

The first 4 bytes are the floating point representation (IEEE) of the variable. The variables are the outputs of the function block. The 5th byte is the status word and the list of possible values is given in the chart below.

The 5 bytes must be read consistently, in a contiguous chunk: they cannot be read byte by byte, and cannot suffer an interrupt. If you are using an S7-300 / 400, you will need to use SFC14 DPRD_DAT: Read Consistent Data of a Standard PD Slave.

Status Byte

In PROFIBUS PA there are two possible types of status byte:

- **condensed status:** one of two status bytes defined in Profile Standard V3.01
- **status byte:** the status byte originally defined in Profile Standard V3.0

You can choose which type of status byte will be returned, by enabling or disabling **Condensed Status (3.5)**

Condensed Status

These codes are available when Condensed Status is enabled. See **Condensed Status (3.5)** on page 83 for more details.

Condensed Status (GOOD)		
Hex value	Status – GOOD	Description
0x80	GOOD – ok	No error or special condition is associated with this value.
0x84	GOOD – update event	Set if the value is good and the block has an active Update event. (This status remains active for 20 seconds.)
0x86	GOOD – active advisory alarm	Set if the value is good and the block has an active Alarm.
0x80 ...0x8E	GOOD – limit check/ update event	See <i>Status Codes for Good Quality</i> on page 134.
0xA0 ...0xA3	GOOD – initiate fail safe	This fault is not generated by the product, but can be simulated.

Condensed Status (GOOD) (cont'd)

Hex value	Status – GOOD	Description
0xA4 ...0xA7	GOOD – maintenance required	Value is valid. Maintenance is recommended within a medium-term period.
0xA8 ...0xAB	GOOD – maintenance demanded	Value is valid. Maintenance is demanded within a short-term period.
0xBC ...0xBF	GOOD – function check	Device performs internal function check without influencing the process. Value is valid.

Condensed Status (UNCERTAIN)

Hex value	Status – UNCERTAIN	Description
0x45	UNCERTAIN – substitute set	Output of Failsafe logic only.
0x4F	UNCERTAIN – initial value	Default value as long as no measured value is available or until a diagnosis is made that affects the value and the status accorded to it.
0x68 ...0x6B	UNCERTAIN – maintenance demanded	Usability of the process value depends on the application. Value is potentially invalid. Cause can be determined by reading the extended diagnostics ^{a)} . Maintenance is demanded within a short-term period.
0x73	UNCERTAIN – simulated value, start	<p>Indicates the start of a simulation. Simulation of a measured value or Input FB mode changes from AUTO to MAN.</p> <ul style="list-style-type: none"> • This status remains active for at least 10 seconds: <ul style="list-style-type: none"> – after enabling simulation – after setting the FB to MAN mode – after a restart (e.g. power down cycle) if the simulation is enabled or the FB is in MAN mode – after passivation is cleared if simulation is enabled or the FB is in MAN mode • In MAN mode the status remains until a subsequent write command overwrites the OUT value after the 10 seconds have expired. • In simulation mode the written status is buffered and appears in the value flow after 10 seconds. However the new written SIMULATE parameter with its status can be read before the 10 seconds have expired.

Condensed Status (UNCERTAIN) (cont'd)

Hex value	Status – UNCERTAIN	Description
0x74 ...0x77	UNCERTAIN – simulated value, end	<p>Indicates the end of a simulation.</p> <p>Simulation of a measured value is disabled or Input FB mode changes from MAN to AUTO.</p> <p>This Status remains active for 10 seconds after simulation ends.</p> <p>While this status is active there is no reliable process value. Measured values and their status are updated afterwards.</p>

a) See *Acyclic Extended Diagnostics (General Fault Codes)* on page 138.

Condensed Status (BAD)

Hex value	Status BAD	Description
0x00	BAD – non specific	Proxy determines that a device does not communicate.
0x23	BAD – passivated (diagnostics alerts disabled)	Configured failsafe value is used, accompanied by this status.
0x24 ...0x27	BAD – maintenance alarm, more diagnosis available	No measurement available because of a failure.
0x25	BAD – process related, no maintenance	No measurement available because of invalid process conditions.
0x3C ...0x3F	BAD – function check / local override, value not usable	Occurs during cleaning or calibration process.

Status Byte

When Condensed Status is disabled, Status Byte will be returned, and the following codes will be used.

Status Codes for Good Quality

Values in hex notation	Description
0x80	Data is GOOD.
0x84	A parameter in the function block has been changed: status active for 10 s
0x89	Active low warning.
0x8A	Active high warning.
0x8D	Active low alarm.
0x8E	Active high alarm.

Status Codes for Uncertain Quality

Values in hex notation	Description
0x4B	Value is a substituted value (normally used in Failsafe).
0x4C/0x4F	Initial value.
0x47	Last usable value.

Status Codes for Bad Quality

Values in hex notation	Description
0x10	The LOE timer has expired: this could be caused by LOE or by a sensor malfunction: value is BAD.
0x01	There is an error in the configuration of the function blocks in PROFIBUS PA ^{a)} .
0X1F	The function block, or the transducer block, has been placed out of service.

- a) This could happen when a firmware download has been done, but a system reset has not been done. This could also happen if the function blocks are not configured properly using the handheld programmer, PDM or acyclic services.

Diagnostics

All diagnostic information shown below is viewable via PDM.

Diagnosis reply (available cyclically)

During DPV0 data exchange, the PROFIBUS PA slave will notify the Master when a serious error occurs. The Master will then send a Diagnosis request. The reply to this request is normally logged in the PLC and is referred to as the "Hex values."

The reply may contain two parts. The first part is 6 bytes long and is defined by the PROFIBUS standard. If there is a second part, it is called the 'extended cyclic diagnosis' and it is 8 bytes long. The last 4 bytes of the extended diagnostic message give the error diagnosis (see *Extended Mode Diagnosis* on page 137 and *Condensed Mode Diagnosis* on page 136).

The same information is also available acyclically via the Diagnosis Object.

Cyclic Diagnosis (6 bytes)

Extended Cyclic Diagnosis (8 bytes)



Condensed Mode
Diagnosis

Extended Mode
Diagnosis

Diagnosis Object (available cyclically or acyclically)

This consists of four bytes.

In PROFIBUS PA there are two options for the Diagnosis Object:

- Condensed Mode Diagnosis (see page 136)
- Extended Mode Diagnosis (see page 137)

You can choose which of these will be returned, by enabling or disabling Condensed Status. See **Enable (3.5.1.)** on page 83.

Condensed Mode Diagnosis

Condensed Mode Diagnosis				
Hex values	Byte	Bit	Description	Indication class ^{a)}
0x01000000	0	0	Electronics failure	R
0x02000000		1	Mechanical failure	R
0x04000000		2	Motor Temperature too high	R
0x08000000		3	Electronics temperature too high	R
0x10000000		4	Memory error	R
0x20000000	0 (cont'd)	5	Measurement failure	R
0x40000000		6	Device not initialized (no calibration)	R
0x80000000		7	Self calibration failed	R
0x00080000	2	3	New startup carried out (Warm Start)	A
0x00100000		4	Restart carried out (Cold Start)	A
0x00200000		5	Maintenance required	R
0x00400000		6	Reserved for use within the PNO	
0x00800000		7	Set to 1 (one), if the Ident_Number of the running cyclic data transfer and the value of Physical Block IDENT__NUMBER_SELECTOR parameter are different.	R
0x00010000	3	0	Failure of the device or armature	R
0x00020000		1	Maintenance demanded	R
0x00040000		2	Device is in function check mode, or simulation, or under local control e.g. maintenance	R
0x00080000		3	The process conditions do not allow the return of valid values. (Set if a value has the quality Uncertain - Process related, no maintenance or Bad - Process related, no maintenance.)	R
		4 to 7	Reserved for use within the PNO	
	4	0 to 6	Reserved for use within the PNO	
0x80000000		7	0: There is no more information available 1: More diagnosis information is available in DIAGNOSIS_EXTENSION	

a) **R** indicates the message remains active as long as the reason for the message exists.

A indicates the message will automatically reset after 10 seconds

Extended Mode Diagnosis

When Condensed Status is disabled **Extended Mode Diagnosis** will be returned, and the following codes will be used.

Extended Mode Diagnosis				
Hex values	Byte	Bit	Description	Indication class ^{a)}
0x01000000	0	0	Electronics failure	R
0x02000000		1	Mechanical failure	R
0x04000000		2	Motor Temperature too high	R
0x08000000		3	Electronics temperature too high	R
0x10000000		4	Memory error	R
0x20000000		5	Measurement failure	R
0x40000000		6	Device not initialized (no calibration)	R
0x80000000		7	Self calibration failed	R
0x00010000	1	0	Zero point error (limit position)	R
0x00020000		1	Power supply failure (electrical, pneumatic)	R
0x00040000		2	Configuration invalid	R
0x00080000		3	New startup carried out (Warm Start)	A
0x00100000		4	Restart carried out (Cold Start)	A
0x00200000		5	Maintenance required	R
0x00400000		6	Characterization invalid	R
0x00800000		7	Set to 1 (one), if the Ident_Number of the running cyclic data transfer and the value of Physical Block IDENT_NUMBER_SELECTOR parameter are different.	R
	2	0 to 7	Reserved for use within the PNO	
	3	0 to 6	Reserved for use within the PNO	
0x00000080		7	More diagnosis information is available	

- a) **R** indicates the message remains active as long as the reason for the message exists.
A indicates the message will automatically reset after 10 seconds

Values of the DIAGNOSIS bit: **0** = not set; **1** = set

Acyclic Extended Diagnostics (General Fault Codes)

In addition to the extended diagnostics available by cyclic data exchange (shown above), further extended diagnostics are available via acyclic communications. This consists of six bytes. See *Diagnosis reply (available cyclically)* on page 135 for information on the location of the **Extended Diagnostics**

Note: Certain fault codes (identified by an asterisk [*] in the table below) will persist until a manual reset has been performed (see **Fault Reset (3.2.)** on page 82).

Acyclic Extended Diagnostics /General Fault Codes					
LCD display	Meaning	Corrective Action	Byte	Bit	
S:0	The device was unable to get a measurement within the Fail-safe LOE Timer period. Possible causes: faulty installation, antenna material buildup, foaming/other adverse process conditions, invalid calibration range.	<ul style="list-style-type: none"> • Ensure installation details are correct. • Ensure no antenna material buildup. Clean if necessary. • Adjust process conditions to minimize foam or other adverse conditions. • Correct range calibration. • If fault persists, contact your local Siemens representative. 	0	0	
S:2	Unable to collect profile because of a power condition that is outside the operating range of the device.	Repair required. Contact your local Siemens representative.		2	
S:3	Device is nearing its lifetime limit according to the value set in Maintenance Required Limit.	Replacement is recommended.		3	
S:4	Device is nearing its lifetime limit according to the value set in Maintenance Demanded Limit.	Replacement is recommended.		4	
S:6	Sensor is nearing its lifetime limit according to the value set in Maintenance Required Limit.	Replacement is recommended.		6	
S:7	Sensor is nearing its lifetime limit according to the value set in Maintenance Demanded Limit.	Replacement is recommended.		7	

Acyclic Extended Diagnostics /General Fault Codes (cont'd)					
LCD display	Meaning (cont'd)	Corrective Action	Byte (cont'd)	Bit	
S:8	Service interval as defined in Maintenance Required Limit has expired.	Perform service.	1	0	
S:9	Service interval as defined in Maintenance Demanded Limit has expired.	Perform service.		1	
S:10	Input parameters High Calibration Point and Low Calibration Point are the same.	<ul style="list-style-type: none"> • Check calibration settings of device. • Ensure settings for High Calibration Point and Low Calibration Point are different. 		3	
S:11	Internal temperature sensor failure.	Repair required. Contact your local Siemens representative.		4	
S:12	* Internal temperature of the device has exceeded specifications: it is operating outside its temperature range.	<ul style="list-style-type: none"> • Relocate device and/or lower process temperature enough to cool device. • Inspect for heat-related damage and contact your local Siemens representative if repair is required. • Fault code will persist until a manual reset is performed using PDM or the LCD interface. 		5	
S:14	Upper and lower input values (Process Value Scale) for AIFB1 are the same.	<ul style="list-style-type: none"> • Check configuration for AIFB1. • Ensure that Upper Value and Lower Value (Process Value Scale) are not the same. 		6	
S:15	Upper and lower input values (Process Value Scale) for AIFB2 are the same.	<ul style="list-style-type: none"> • Check configuration for AIFB2. • Ensure that Upper Value and Lower Value (Process Value Scale) are not the same. 		7	
S: 17	Calibration interval as defined in Maintenance Required Limit has expired.	Perform calibration.		2	1
S: 18	Calibration interval as defined in Maintenance Demanded Limit has expired.	Perform calibration.	2		

Acyclic Extended Diagnostics /General Fault Codes (cont'd)				
LCD display	Meaning (cont'd)	Corrective Action	Byte (cont'd)	Bit
S:25	Internal error.	Reset power. If fault persists, contact your local Siemens representative.	3	1
S: 27	Internal device failure caused by an External RAM memory error.	Repair required: contact your local Siemens representative.		3
S:28	Internal device failure caused by a RAM memory error.	Repair required: contact your local Siemens representative.		4
S:29	EEPROM damaged.	Repair required: contact your local Siemens representative.		5
S: 30	EEPROM corrupt.	Reset power. If fault persists, contact your local Siemens representative.		6
S:31	Flash error.	Repair required: contact your local Siemens representative.		7
S: 32	IDENT number conflict.	Ensure value of the Ident number selector is correct for the network configuration. If it is correct, the device needs to be re-parameterized by the PLC.	4	0
S:33	Factory calibration for the internal temperature sensor has been lost.	Repair required: contact your local Siemens representative.		1
S:34	Factory calibration for the device has been lost.	Repair required: contact your local Siemens representative.		2
S:39	Transducer temperature sensor failure.	Repair required: contact your local Siemens representative.		7
S:40	Transducer temperature too high.	Relocate device and/or lower process temperature enough to cool device. Inspect for heat-related damage and contact your local Siemens representative if repair is required.	5	0

Acyclic Extended Diagnostics /General Fault Codes (cont'd)					
LCD display	Meaning (cont'd)	Corrective Action	Byte (cont'd)	Bit	
S: 41	Transducer temperature too low.	Relocate device and/or raise process temperature enough to warm device. Inspect for temperature-related damage and contact your local Siemens representative if repair is required.	5 (cont'd)	1	

Acyclic Data

SITRANS LR560 supports up to four simultaneous connections by a Class 2 Master (C2 connection). It supports one connection by a Class 1 Master (C1 connection).

In order for a Class 1 Master to read parameters from an instrument, it needs to know the slot and absolute index of the parameter. You can download an application guide 'Reading acyclic data from a Siemens level measuring instrument' from our website at: www.siemens.com/LR560 under **Support**.

To find the slot and index numbers via SIMATIC PDM, go to **Help > Communications**, and select the appropriate block from the list. For each parameter, the slot and the relative index is listed. For example.

AIFB 1		
Index	Parameter	Datatype
1	Static Revision No.	UNSIGNED_INTEGER (2)

Each block has a slot number and an Index Offset value.

Block Name	Slot	Index Offset
Physical block	0	16
Transducer block	0	77
AIFB 1	1	16
AIFB 2	2	16

To get the absolute index for any parameter, add the Index Offset for the appropriate block to the relative index for that parameter. The parameter takes the slot number of the block in which it is located.

For example:

- Parameter **Static Revision Number** has relative index = 1 and is located on AIFB1.
- It has Absolute Index = 17 (relative index 1 + index offset 16).
- It is located at Slot 1 (the slot number for AIFB 1).

Appendix G: Firmware Revision History

Firmware Rev.	EDD Rev.	Date (DD/MM/YYYY)	Changes
1.00.00	1.00.00	26 May 2010	<ul style="list-style-type: none">Initial release.

Appendix G: Firmware rev.

Glossary

- accuracy:** degree of conformity of a measure to a standard or true value.
- agitator:** mechanical apparatus for mixing or aerating. A device for creating turbulence.
- algorithm:** a prescribed set of well-defined rules or processes for the solution of a problem in a finite number of steps.
- ambient temperature:** the temperature of the surrounding air that comes in contact with the enclosure of the device.
- antenna:** an aerial which sends out and receives a signal in a specific direction. There are four basic types of antenna in radar level measurement, horn, parabolic, rod, and waveguide.
- attenuation:** a term used to denote a decrease in signal magnitude in transmission from one point to another. Attenuation may be expressed as a scalar ratio of the input magnitude to the output magnitude, or in decibels.
- Auto False-Echo Suppression:** a technique used to adjust the level of a TVT curve to avoid the reading of false echoes. (See TVT.)
- Auto False-Echo Suppression Distance:** defines the endpoint of the custom TVT distance. (See TVT.) This is used in conjunction with Auto False Echo Suppression.
- beam angle:** the angle diametrically subtended by the one-half power limits (-3 dB) of the microwave beam.
- beam spreading:** the divergence of a beam as it travels through a medium.
- blanking:** a blind zone extending away from the reference point plus any additional shield length. The instrument is programmed to ignore this zone.
- capacitance:** the property of a system of conductors and dielectrics that permits the storage of electricity when potential differences exist between the conductors. Its value is expressed as the ratio of a quantity of electricity to a potential difference, and the unit is a Farad.
- confidence:** see **Echo Confidence**
- damping:** term applied to the performance of an instrument to denote the manner in which the measurement settles to its steady indication after a change in level.
- dB (decibel):** a unit used to measure the amplitude of signals.
- derating:** to decrease a rating suitable for normal conditions according to guidelines specified for different conditions.
- dielectric:** a nonconductor of direct electric current.¹⁾

¹⁾ Many conductive liquids/electrolytes exhibit dielectric properties; the relative dielectric constant of water is 80.

dielectric constant (DK): the ability of a dielectric to store electrical potential energy under the influence of an electric field. Also known as Relative Permittivity. An increase in the dielectric constant is directly proportional to an increase in signal amplitude. The value is usually given relative to a vacuum /dry air: the dielectric constant of air is 1¹.

echo: a signal reflected with sufficient magnitude and delay to be perceived as a signal distinct from the one directly transmitted. Echoes are frequently measured in decibels relative to the directly transmitted signal.

Echo Confidence: describes the quality of an echo. Higher values represent higher quality. Echo threshold defines the minimum value required for an echo to be accepted as valid and evaluated.

Echo Lock Window: a window centered on an echo in order to locate and display the echo's position and true reading. Echoes outside the window are not immediately processed.

Echo Marker: a marker that points to the processed echo.

Echo Processing: the process by which the radar unit determines echoes.

Echo Strength: describes the strength of the selected echo in dB above 1 μ V rms.

Echo Profile: a graphical display of a processed echo.

false echo: any echo which is not the echo from the desired target. Generally, false echoes are created by vessel obstructions.

frequency: the number of periods occurring per unit time. Frequency may be stated in cycles per second.

hertz (Hz): unit of frequency, one cycle per second. 1 Gigahertz (GHz) is equal to 10⁹ Hz.

inductance: the property of an electric circuit by virtue of which a varying current induces an electromotive force in that circuit or in a neighboring circuit. The unit is a Henry.

lens antenna: an antenna consisting of a radiator and microwave lens to enhance the antenna gain.

microwaves: the term for the electromagnetic frequencies occupying the portion of the radio frequency spectrum from 1 GHz to 300 GHz.

multiple echoes: secondary echoes that appear as double, triple, or quadruple echoes in the distance from the target echo.

Near Blanking: see Blanking

nozzle: a length of pipe mounted onto a vessel, that supports the flange.

parameters: in programming, variables that are given constant values for specific purposes or processes.

polarization: the property of a radiated electromagnetic wave describing the time-varying direction and amplitude of the electric field vector.

polarization error: the error arising from the transmission or reception of an electromagnetic wave having a polarization other than that intended for the system.

- PROFIBUS PA:** one of the PROFIBUS family of protocols, specifically tailored for the needs of process industries (PA = Process Automation).
- pulse radar:** a radar type that directly measures distance using short microwave pulses. Distance is determined by the return transit time.
- radar:** radar is an acronym for **RA**dio **D**etection **A**nd **R**anging. A device that radiates electromagnetic waves and utilizes the reflection of such waves from distant objects to determine their existence or position.
- range:** distance between a transmitter and a target.
- range extension:** the distance below the zero percent or empty point in a vessel.
- relative permittivity:** see dielectric constant.
- repeatability:** the closeness of agreement among repeated measurements of the same variable under the same conditions.
- shot:** one transmit pulse or measurement.
- speed of light:** the speed of electromagnetic waves (including microwave and light in free space. Light speed is a constant 299,792,458 meters per second.
- stillpipe:** a pipe that is mounted inside a vessel, parallel to the vessel wall and open to the vessel at the bottom.
- stilling-well:** see **stillpipe**.
- two wire radar:** a low-energy radar. Can be loop powered, analog, intrinsically safe, or a digital (BUS) transmitter.
- TVT (time varying threshold):** a time-varying curve that determines the threshold level above which echoes are determined to be valid.
- waveguide antenna:** a hollow, metallic tube that transmits a microwave signal to the product target.

Notes

Index

Note: Parameter names are capitalized.

Symbols

26

A

abbreviations

list 4

access control

local access 101

remote access 101

Acknowledge Faults

via PDM 51

activating SITRANS LR560 28

acyclic diagnostics

fault codes 136

Auto False Echo Suppression

explanation 118

TVT shaper adjustment 47

via PDM 48

B

blanking (see Near Range) 120

bus address (device address)

resetting to 126 130

bus termination 129

C

Calibration Interval 97

cleaning

instructions 114

CLEF Range

setup 72

configuration

network 129

new device via PDM 40

PLC with PROFIBUS PA 24

cyclic data 131

versus acyclic 131

D

damping

explanation 121

Filter Time Constant setup 80

data logging

time-based echo profile storage 46

DD

see electronic device description 129

Device Address 100

device description

see Electronic Device Description 129

device label

Non-incendive (FM/CSA) 26

Non-sparking/Energy Limited (ATEX/
IECEX/C-TICK) 25

Device Status

view via PDM 57

device status

icons 107

diagnosis reply 135

Diagnostics

maintenance settings 82

via PDM 56

E

Echo Processing 115

Process Intelligence 115

Echo Profile

view via LDI 37

echo profile

data logging 46

echo selection

Algorithm 116

Time Varying Threshold (TVT) 116

Echo Setup

quick access via PDM 50

EDD

updating 39

EDD (electronic device description) 129

edit mode

handheld programmer 32

Electronic Device Description (EDD)

required for PROFIBUS PA 129

updating 39

Empty rate

setup 69

enable/disable remote operation 101

F

Factory Defaults

reset via PDM 55

factory defaults 87

Fail-safe

Behavior explanation 122

Mode explanation 122

Value explanation 122

Fail-safe Mode FB1

setup 80

Far Range

explanation 120

fault codes

acyclic diagnostics 136

acyclic extended diagnostics 138

general fault codes 108
Fill Rate
 setup 69
Filter Time Constant
 explanation 121
Function Blocks
 view process variables via PDM 57
function keys
 edit mode 33
 measurement mode 30
 navigation mode 32

G

GSD file 129

H

handheld programmer
 edit mode 32
 measurement mode 30
 navigation 32
 programming 31
hazardous area installations
 wiring requirements 25
hysteresis
 setup 79

I

icons
 device status 107
identifications and abbreviations
 list 4
installation
 hazardous area requirements 25
 requirements 17
 warnings and notes 17

L

Language 101
LCD display
 echo profile viewing 37
LDI (local display interface) 28
Limit Hysteresis
 setup 79
local display interface (LDI) 28
LOE Timer
 explanation 121
 setup 66
Loss of Echo (LOE)
 explanation 121

M

maintenance 114
 calibration schedules 50
 cleaning 114
 repairs 114

replacing antenna 114
service schedules 50
maintenance settings
 see Diagnostics 82
Master Reset 87
 factory defaults 87
 reset PROFIBUS address (to 126) 87
 standard defaults 87

mounting

handheld programmer access 18
housing construction 18
nozzle design 17, 18
nozzle location 17, 18
sunshield recommended 18

N

Near Range
 explanation 120

O

operating principles 115
Output Limits
 setup 79
Output Scale
 setup 78

P

parameters
 reset via PDM 44
password protection
 via PDM 59
PDM
 see SIMATIC PDM 39
peak values
 electronics temperature 58
 sensor peak values
 FB1 and FB2 58
power consumption 129
power source
 requirements 23
Process Intelligence 115
Process Variables
 view via PDM 56
PROFIBUS address 130
 reset to 126 87
 reset to 126 via PDM 55
PROFIBUS Ident Number 101
programmer
 handheld 30
programming
 enter program mode 31
programming LR250
 via handheld programmer 31

Q

- Quick Start wizard
 - via LDI push buttons 34
 - via PDM 40

R

- reading erratic 113
- reading incorrect 113
- reading response slow 113
- Remote Lockout 101
- repair

- cautions 114
- excluded liability 114

resets

- Master Reset 87

Response Rate

- explanation 120
- setup 68

S

safety notes 1

security

- password protection via PDM 59

Service Interval 94

settings

- adjust parameters locally via LDI 31
- adjust parameters via LDI 32
- adjust parameters via PDM 44

SIMATIC PDM

- overview 39, 129

Simulate Analog Input

- via PDM 52

Simulate Input

- via PDM 54

Simulate Output

- via PDM 53

Simulation

- via PDM 51

SITRANS LR250

- operating principles 115
- overview 6

startup

- transition screen 28

status byte

- status codes 132

status codes 132

Support

- contact information 3

T

Technical Support 3

temperature de-Rating

- curves 123

trend view

- via PDM 57

troubleshooting

- operation 112

TVT (time varying threshold)

- explanation 116

TVT Shaper

- manual adjustment via PDM 47

W

Wear

- powered hours, poweron resets 51

wiring

- hazardous areas 25

Write Locking

- via PDM 54

Write Protection 101

Notes

LCD menu structure

LCD menu structure

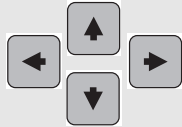

Notes:

- Navigation mode **ARROW** keys navigate the menu in the direction of the arrow.
- See *Parameter Reference* on page 62 for detailed information and instructions.
- LCD and PDM menu structures are similar but not identical. Where they vary, the navigation path to the parameter location in PDM is given in *Parameter Reference*.

LEVEL METER

1. QUICK START

- 1.1 QUICK START WIZ.
- 1.2 AFES WIZARD
- 1.3 CPY PAR TO DISPL..
- 1.4 CPY PAR FROM DIS
- 1.5 CPY FW TO DISPL.
- 1.6 CPY FW FROM DIS

2. SETUP

- 2.1 IDENTIFICATION
 - 2.1.1 TAG
 - 2.1.2 DESCRIPTOR
 - 2.1.3 MESSAGE
 - 2.1.4 INSTAL.DATE
- 2.2 DEVICE
 - 2.2.1 HARDWARE REV
 - 2.2.2 FIRMWARE REV
 - 2.2.3 LOADER REV
 - 2.2.4 MENU TIMEOUT
 - 2.2.5 MANUF. DATE
- 2.3 SENSOR
 - 2.3.1 UNIT
 - 2.3.2 LEVEL UNIT
 - 2.3.3 LOE TIMER
 - 2.3.4 TEMP. UNIT
 - 2.3.5 CALIBRATION
 - 2.3.5.1 LOW CALIB. PT.
 - 2.3.5.2 HIGH CALIB. PT.
 - 2.3.5.3 SENSOR OFFSET
 - 2.3.5.4 LOW LEVEL POINT
 - 2.3.5.5 HIGH LEVEL POINT
 - 2.3.5.6 LEVEL OFFSET
 - 2.3.6 RATE
 - 2.3.6.1 RESPONSE RATE
 - 2.3.6.2 FILL RATE /MIN
 - 2.3.6.3 EMPTY RATE /MIN
- 2.4 SIGNAL PROC.
 - 2.4.1 NEAR RANGE
 - 2.4.2 FAR RANGE
 - 2.4.3 MIN. SENSOR VAL.
 - 2.4.4 MAX. SENSOR VAL.
 - 2.4.5 ECHO SELECT
 - 2.4.5.1 ALGORITHM
 - 2.4.5.2 POS. DETECT
 - 2.4.5.3 ECHO THRESHOLD
 - 2.4.5.4 CLEF RANGE

2. SETUP (cont'd)

- 2.4.5.5 ECHO MARKER
- 2.4.6 SAMPLING
 - 2.4.6.1 ECHO LOCK
 - 2.4.6.2 UP SAMP.
 - 2.4.6.3 DOWN SAMP.
 - 2.4.6.4 ECHO LOCK WINDOW
- 2.4.7 ECHO QUALITY
 - 2.4.7.1 CONFIDENCE
 - 2.4.7.2 ECHO STRENGTH
- 2.4.8 TVT SETUP
 - 2.4.8.1 AUTO ECHO SUPP
 - 2.4.8.2 AUTO SUPP. RANGE
 - 2.4.8.3 HOVER LEVEL
 - 2.4.8.4 SHAPER MODE
- 2.4.9 TVT SHAPER
 - 2.4.9.1 BRKPT. 1-9
 - 2.4.9.2 BRKPT. 10-18
 - 2.4.9.3 BRKPT. 19-27
 - 2.4.9.4 BRKPT. 28-36
 - 2.4.9.5 BRKPT. 37-45
 - 2.4.9.6 BRKPT. 46-54
 - 2.4.9.7 BRKPT. 55-63
 - 2.4.9.8 BRKPT. 64-72
 - 2.4.9.9 BRKPT. 73-81
 - 2.4.9.10 BRKPT. 82-90
 - 2.4.9.11 BRKPT. 91-99
 - 2.4.9.12 BRKPT. 100-108
 - 2.4.9.13 BRKPT. 109-117
 - 2.4.9.14 BRKPT. 118-120
- 2.5 AIFB 1
 - 2.5.1 STATIC REV. NO.
 - 2.5.2 MODE
 - 2.5.3 CHANNEL
 - 2.5.4 LABEL
 - 2.5.5 INPUT SCALING
 - 2.5.5.1 UPPER VALUE
 - 2.5.5.2 LOWER VALUE
 - 2.5.6 OUTPUT SCALING
 - 2.5.6.1 UPPER VALUE
 - 2.5.6.2 LOWER VALUE
 - 2.5.7 ALARMS & WARN..
 - 2.5.7.1 HI LIMIT ALARM
 - 2.5.7.2 HI LIMIT WARN
 - 2.5.7.3 LO LIMIT WARN
 - 2.5.7.4 LO LIMIT ALARM
 - 2.5.7.5 LIMIT HYSTERESI..
 - 2.5.8 DISPLAY
 - 2.5.8.1 FILTER TIME CONS..
 - 2.5.8.2 UNIT
 - 2.5.8.3 OUT UNIT TEXT
 - 2.5.8.4 DECIMAL POINT
 - 2.5.9 FAIL-SAFE MODE
 - 2.5.9.1 MODE
 - 2.5.9.2 VALUE
- 2.6 AIFB2
 - 2.6.1 STATIC REV. NO.
 - 2.6.2 MODE
 - 2.6.3 CHANNEL
 - 2.6.4 LABEL

2. SETUP (cont'd)

- 2.6.5 INPUT SCALING
 - 2.6.5.1 UPPER VALUE
 - 2.6.5.1 LOWER VALUE
- 2.6.6 OUTPUT SCALING
 - 2.6.6.1 UPPER VALUE
 - 2.6.6.2 LOWER VALUE
- 2.6.7 ALARMS & WARN..
 - 2.6.7.1 HI LIMIT ALARM
 - 2.6.7.2 HI LIMIT WARN
 - 2.6.7.3 LO LIMIT WARN
 - 2.6.7.4 LO LIMIT ALARM
 - 2.6.7.5 LIMIT HYSTERESIS
- 2.6.8 DISPLAY
 - 2.6.8.1 FILTER TIME CONS..
 - 2.6.8.2 UNIT
 - 2.6.8.3 OUT UNIT TEXT
 - 2.6.8.4 DECIMAL POINT
- 2.6.9 FAIL-SAFE MODE
 - 2.6.9.1 MODE
 - 2.6.9.2 VALUE
- 2.7 MEAS. VALUES
 - 2.7.1 MAIN OUTPUT
 - 2.7.2 O/P NO LINEAR.
 - 2.7.3 O/P NO OFFSETS
- 2.8 FILTERING
 - 2.8.1 NARROW ECHO FILTER.
 - 2.8.2 REFORM ECHO
 - 2.8.3 AVG AMOUNT

3. DIAGNOSTICS

- 3.1 ECHO PROFILE
- 3.2 FAULT RESET
- 3.3 TREND.
- 3.4 ELECT. TEMP.
 - 3.4.1 MIN. VALUE
 - 3.4.2 MAX. VALUE
 - 3.4.3 INTERN. TEMP.
- 3.5 COND. STAT.
 - 3.5.1 ENABLE
 - 3.5.2 FEAT. SUPPORTED
 - 3.5.3 FEAT. ENABLED
- 3.6 ALLOCATION
 - 3.6.1 EVENT INDEX
 - 3.6.2 EVENT STAT.
 - 3.6.3 EVENT DIAG.
- 3.7 PEAK VALUES
 - 3.7.1 MIN. MEAS. VALUE
 - 3.7.2 MAX. MEAS. VALUE
 - 3.7.3 MIN. OUTPUT FB1
 - 3.7.4 MAX. OUTPUT FB1
 - 3.7.5 MIN OUTPUT FB2
 - 3.7.6 MAX. OUTPUT FB2

4. SERVICE

- 4.1 DEMO MODE
- 4.2 MASTER RESET
- 4.3 POWERED HOURS
- 4.4 POWERON RESETS
- 4.5 LCD BACKLIGHT

4. SERVICE (continued)

- 4.6 LCD CONTRAST
- 4.7 REMAIN. DEV. LIFE
 - 4.7.1 LIFETIME EXPECT..
 - 4.7.2 TIME IN OPER.
 - 4.7.3 REMAIN. LIFETIM..
 - 4.7.4 REMINDER ACTIV..
 - 4.7.5 REMIND. 1 (REQ)
 - 4.7.6 REMIND. 2 (DEM)
 - 4.7.7 MAINT STAT
 - 4.7.8 ACK STATUS
 - 4.7.9 ACK
- 4.8 REMAIN. SENS. LIFE
 - 4.8.1 LIFETIME EXPECT..
 - 4.8.2 TIME IN OPER.
 - 4.8.3 REMAIN. LIFETIM..
 - 4.8.4 REMINDER ACTIV..
 - 4.8.5 REMIND. 1 (REQ)
 - 4.8.6 REMIND. 2 (DEM)
 - 4.8.7 MAINT STAT
 - 4.8.8 ACK STATUS
 - 4.8.9 ACK
- 4.9 SERVICE SCHED.
 - 4.9.1 SERV. INTERVAL
 - 4.9.2 TIME LAST SERV.
 - 4.9.3 TIME NEXT SERV..
 - 4.9.4 REMINDER ACTIV..
 - 4.9.5 REMIND. 1 (REQ)
 - 4.9.6 REMIND. 2 (DEM)
 - 4.9.7 MAINT STAT
 - 4.9.8 ACK STATUS
 - 4.9.9 ACK
- 4.10 CALIB. SCHED.
 - 4.10.1 CALIB. INTERVAL.
 - 4.10.2 TIME LAST CALIB.
 - 4.10.3 TIME NEXT CALIB..
 - 4.10.4 REMINDER ACTIV..
 - 4.10.5 REMIND. 1 (REQ)
 - 4.10.6 REMIND. 2 (DEM)
 - 4.10.7 MAINT STAT
 - 4.10.8 ACK STATUS
 - 4.10.9 ACK

5. COMMUNICATION

- 5.1 DEVICE ADDRESS
- 5.2 PROFIBUS IDENT

6. SECURITY

- 6.1 REMOTE ACCESS
 - 6.1.1 REMOTE LOCKOUT
- 6.2 LOCAL ACCESS
 - 6.2.1 WRITE PROTECTION

7. LANGUAGE

For more information

www.siemens.com/level

www.siemens.com/continuous-weighing

Siemens Milltronics Process Instruments Inc.
Industry Automation (IA)
1954 Technology Drive
P.O. Box 4225
Peterborough, ON
Canada K9J 7B1

email: techpubs.smpi@siemens.com

www.siemens.com/processautomation

Subject to change without prior notice
7ML19985LT01 Rev. 1.0-02

© Siemens Milltronics Process Instruments Inc. 2010



Printed in Canada