

Global EMC Labs

EMC/EMI Test Report

As per

**IEC/EN 61326-1:2005 &
IEC/EN 61326-2-5:2006**

Emission & Immunity for
Electrical Equipment for Measurement, Control and
Laboratory Use– EMC Requirements

Part 1: Industrial Locations

on

Product: SITRANS LR560 Profibus PA

Model: 7ML5440-xxx00-xBxx



Min Xie
Project Engineer
Global EMC Inc.
180 Brodie Drive, Unit 2
Richmond Hill, ON, L4B 3K8 Canada
Ph: (905) 883-8189

Testing produced for



See appendix A for full client & EUT details.





Client	Siemens Canada – Siemens Milltronics Process Instruments	
Product	SITRANS LR560 Profibus PA	
Model	7ML5440-xxx00-xBxx	
Standard(s)	IEC / EN 61326-1:2005 & IEC / EN 61326-2-5:2006	

Table of Contents

Table of Contents	2
Report Scope	3
Guidance - Selection of Test Levels	4
Summary	6
Test Results Summary	7
Justifications or Deviations	8
Applicable Standards, Specifications and Methods	9
Document Revision Status	10
Definitions and Acronyms	11
Testing Facility	12
Calibrations and Accreditations	12
Testing Environmental Conditions	13
Detailed Test Result Section	14
Power Line Conducted Emissions	15
Radiated Emissions	21
Electro-Static Discharge	26
Radiated Field Immunity	31
Electrical Fast Transients / Bursts	37
Surge	40
Conducted RF Immunity	43
Power Frequency Magnetic Field	46
Appendix A – Client Provided Details	48
Appendix B – EUT & Test Setup Photos	55

Client	Siemens Canada – Siemens Milltronics Process Instruments	
Product	SITRANS LR560 Profibus PA	
Model	7ML5440-xxx00-xBxx	
Standard(s)	IEC / EN 61326-1:2005 & IEC / EN 61326-2-5:2006	

Report Scope

This report addresses the EMC verification testing and test results of the Siemens Canada – Siemens Milltronics Process Instruments, SITRANS LR560 Profibus PA, herein referred to as EUT (Equipment under test). The EUT was tested for emissions and immunity compliance against customer specific requirements based on the following standards:

IEC / EN 61326-1:2005

IEC / EN 61326-2-5:2006

FCC Part 15 Subpart B:2010

Test procedures, results, justifications, and engineering considerations, if any, follow later in this report.

Client	Siemens Canada – Siemens Milltronics Process Instruments	
Product	SITRANS LR560 Profibus PA	
Model	7ML5440-xxx00-xBxx	
Standard(s)	IEC / EN 61326-1:2005 & IEC / EN 61326-2-5:2006	

Guidance - Selection of Test Levels

Immunity testing – was performed as per the table listed below from customer provided documentation, which meets or exceeds the requirements of

Table 2 of IEC 61326-1/EN 61326-1, Industrial Immunity Requirements

Port	Phenomenon	Basic Standard	Test Value	Performance Criteria Observed / Required
Enclosure	Electrostatic discharge (ESD)	IEC 61000-4-2	4 kV contact/ (tested @ 2, 4, 6kV) 8 kV air (tested @ 2, 4, 8kV)	A
	EM Field	IEC 61000-4-3	10 V/m 80 MHz – 1 GHz, 3 V/m 1.4 GHz – 2 GHz 1 V/m 2.0 GHz – 2.7 GHz (All Frequencies Tested @ 10 V/m)	A
	Power Freq Magnetic Field	IEC 61000-4-8	30 A/m (Tested @ 100 A/m)	A
Terminal Block & Display Contacts Traces^f	Electrostatic discharge (ESD)	IEC 61000-4-2	4 kV contact/ (tested @ 2, 4, 6kV) 8 kV air (tested @ 2, 4, 8kV)	C
I/O signal/ control (Including lines)	Burst	IEC 61000-4-4	1 kV ^d (5/50 ns, 5 kHz)	A

Client	Siemens Canada – Siemens Milltronics Process Instruments	
Product	SITRANS LR560 Profibus PA	
Model	7ML5440-xxx00-xBxx	
Standard(s)	IEC / EN 61326-1:2005 & IEC / EN 61326-2-5:2006	

connected to functional earth port)	Surge	IEC 61000-4-5	1 kV ^{b,c}	A
	Conducted RF	IEC 61000-4-6	3V ^d (10 kHz – 80 MHz) (Test @ 10 Vrms 10 kHz – 80 MHz)	A

Note:

- a. Line to line
- b. Line to earth (ground)
- c. Only in case of long distance lines
- d. Only in case of lines > 3m
- e. 25/30 cycles means 25 cycles for 50 Hz test and 30 cycles for 60 Hz.
- f. Internal ESD tests requested by the client.

Emissions requirements

Emissions	Conducted emissions	CISPR 11 & FCC 15 Subpart B	150 kHz – 30 MHz	Class B
	Radiated emissions	CISPR 11 & FCC 15 Subpart B	30 MHz – 1 GHz	Class B

Client	Siemens Canada – Siemens Milltronics Process Instruments	
Product	SITRANS LR560 Profibus PA	
Model	7ML5440-xxx00-xBxx	
Standard(s)	IEC / EN 61326-1:2005 & IEC / EN 61326-2-5:2006	

Summary

The results contained in this report relate only to the item(s) tested. This report does not imply product endorsement by any government, or Global EMC.

Equipment under test	SITRANS LR560 Profibus PA
EUT Passed all tests performed.	See Table Below
Tests conducted by	Min Xie

For testing dates see ‘Testing Environmental Conditions’.

Client	Siemens Canada – Siemens Milltronics Process Instruments	
Product	SITRANS LR560 Profibus PA	
Model	7ML5440-xxx00-xBxx	
Standard(s)	IEC / EN 61326-1:2005 & IEC / EN 61326-2-5:2006	

Test Results Summary

For test details refer to “Selection of Test Levels” section above.

Standard/Method	Description	Class/Limit	Result
IEC 61326-1 / IEC 61000-4-2	Electrostatic Discharge	Refer to table above	Pass
IEC 61326-1 / IEC 61000-4-3	Radiated Susceptibility	Refer to table above	Pass
IEC 61326-1 / IEC 61000-4-4	Electrical Fast Transients	Refer to table above	Pass
IEC 61326-1 / IEC 61000-4-5	Surge	Refer to table above	Pass
IEC 61326-1 / IEC 61000-4-6	Conducted Susceptibility	Refer to table above	Pass
IEC 61326-1 / IEC 61000-4-8	Power Frequency Magnetic Field Susceptibility	Refer to table above	Pass
CISPR 11 – 2003 + A1 2004	Conducted emissions	Refer to table above	Class B
CISPR 11 – 2003 + A1 2004	Radiated emissions	Refer to table above	Class B
Overall Result			Pass¹

¹If the product as tested complies with the specification or requirement, the EUT is deemed to comply and is issued a ‘PASS’ grade. If not ‘FAIL’ grade will be issued.

Client	Siemens Canada – Siemens Milltronics Process Instruments	
Product	SITRANS LR560 Profibus PA	
Model	7ML5440-xxx00-xBxx	
Standard(s)	IEC / EN 61326-1:2005 & IEC / EN 61326-2-5:2006	

Justifications or Deviations

The following justifications for tests not performed or deviations from the above listed specifications apply:

None

A later revision of the standard may have been substituted in place of the previous dated referenced revision. The year of the specification used are listed under applicable standards. Using the later revision accomplishes the goal of ensuring compliance to the intent of the previous specification, while allowing the laboratory to incorporate the extensions and clarifications made available by a later revision.

The EUT uses radar pulses at 78-79 GHz to measure liquids, solids, and slurries levels which are cover under a separate report by the manufacturer. The scope of this report does not cover any intentional radiator frequency or components, and was tested for unintentional emissions as if the highest clock was less than 108 MHz, at the request of the client.

The immunity performance summaries were compiled and supplied by the client.

Client	Siemens Canada – Siemens Milltronics Process Instruments	
Product	SITRANS LR560 Profibus PA	
Model	7ML5440-xxx00-xBxx	
Standard(s)	IEC / EN 61326-1:2005 & IEC / EN 61326-2-5:2006	

Applicable Standards, Specifications and Methods

- ANSI C63.4:2003 - Methods of Measurement of Radio-Noise Emissions from Low-Voltage Electrical and Electronic Equipment in the Range of 9 kHz to 40 GHz
- CISPR 11:2003 + A1:2004 - Industrial, scientific and Medical (ISM) radio frequency equipment Electromagnetic disturbance characteristics. Limits and methods of measurement
- IEC 61326-2-5:2006 - Electrical equipment for measurement, control and laboratory use – EMC requirements: Part 2 Particular requirements – Test configurations, operational conditions and performance criteria for field devices with interfaces according to IEC 61784-1, CP 3/2
- IEC 61326-1:2005 - Electrical equipment for measurement, control and laboratory use – EMC requirements: Part 1
- IEC 61000-4-2:2001 - Testing and measurement techniques – Electrostatic discharge immunity test
- IEC 61000-4-3:2002 - Testing and measurement techniques – Radiated, radio-frequency, electromagnetic field immunity test
- IEC 61000-4-4:2004 - Testing and measurement techniques – Electrical fast transient/burst immunity test
- IEC 61000-4-5:2004 - Testing and measurement techniques - Surge immunity test
- IEC 61000-4-6:2003 - Testing and measurement techniques – Immunity to conducted disturbances, induced by radio-frequency fields
- IEC 61000-4-8:2001 - Testing and measurement techniques – Power frequency magnetic field immunity test
- ISO 17025:2005 - General Requirements for the competence of testing and calibration laboratories

Client	Siemens Canada – Siemens Milltronics Process Instruments	
Product	SITRANS LR560 Profibus PA	
Model	7ML5440-xxx00-xBxx	
Standard(s)	IEC / EN 61326-1:2005 & IEC / EN 61326-2-5:2006	

Document Revision Status

Revision 1 November 22, 2010
Initial Release

Revision 2 November 26, 2010

- Corrected SITRAN to SITRANS
- Remove N/A sections from Immunity, Emission, Conducted and Radiated immunity tables
- Change PWR cable to I/O cables
- Reference FCC 15 Subpart B in Report Scope and Emission requirement table.
- Replace Radiated Emission photo.

Revision 2 replaces Revision 1 in its entirety.

Revision 3 December 01, 2010

- Added “- EMC Requirements – Part 1: Industrial Locations” and model number to title page;
- Added model number to header.
- Corrected model number in Appendix A.

Revision 3 replaces Revision 2 in its entirety.

Client	Siemens Canada – Siemens Milltronics Process Instruments	
Product	SITRANS LR560 Profibus PA	
Model	7ML5440-xxx00-xBxx	
Standard(s)	IEC / EN 61326-1:2005 & IEC / EN 61326-2-5:2006	

Definitions and Acronyms

The following definitions and acronyms are applicable in this report.
See also ANSI C63.14.

AE – Auxiliary Equipment.

Class A device – A device that is marketed for use in a commercial, industrial or business environment. A ‘Class A’ device should not be marketed for use by the general public . A ‘Class A’ device should contain the following warning in it’s user manual: “**Warning:** This is a Class A product. In a domestic environment this product may cause radio interference, in which case the user may be required to take adequate measures.”

Class B device – A device that is marketed for use in a residential environment and may also be used in a commercial, business or industrial environments. A ‘Class B’ device may also be defined as a device to which a broadcast radio or television receivers would be expected within a distance of 10 m of the device concerned.

EMC – Electro-Magnetic Compatibility

EMI – Electro-Magnetic Immunity

EUT – Equipment Under Test

LISN – Line impedance stabilization network

RF – Radio Frequency

NCR – No Calibration Required

Test Plan – See ‘Appendix B – Client Provided Details’. This is required prior to testing.

Client	Siemens Canada – Siemens Milltronics Process Instruments	
Product	SITRANS LR560 Profibus PA	
Model	7ML5440-xxx00-xBxx	
Standard(s)	IEC / EN 61326-1:2005 & IEC / EN 61326-2-5:2006	

Testing Facility

Testing for EMC on the EUT was carried out at Global EMC labs in Toronto, Ontario, Canada. The testing lab consists of a 3m semi-anechoic chamber calibrated to be able to allow measurements on an EUT with a maximum width or length of up to 2m and height up to 3m. The chamber is equipped with a turn table that is capable of testing devices up to 3300lb in weight. This facility is capable of testing products that are rated for 120 Vac and 240Vac single phase, or 208 Vac 3 phase input. DC capability is also available. The chamber is equipped with an antenna mast that controls polarization and height from the control room adjoining the shielded chamber. Radiated emissions measurements are performed using a Bilog, and Horn antenna where applicable. Conducted emissions, unless otherwise stated, are performed using a LISN.

For ESD testing, the HCP is 1.6m x 0.8m and the VCP is 0.5m x 0.5m. The reference ground plane, when applicable, was 1.6m x 1.6m.

Calibrations and Accreditations

The 3m semi-anechoic chamber is registered with Federal Communications Commission (FCC) and Industry Canada (IC). This chamber was calibrated for Normalized Site Attenuation (NSA) using test procedures outlined in ANSI C63.4 “Methods of Measurement of Radio-Noise Emissions from Low-Voltage Electrical and Electronic Equipment in the Range of 9 kHz to 40 GHz”. The chamber is lined with ferrite tiles and absorption cones to minimize any undesired reflections. The NSA data is kept on file at Global EMC. For radiated susceptibility testing, a 16 point field calibration has been performed on the chamber. The field uniformity data is kept on file at Global EMC. Global EMC Inc is accredited to ISO 17025 by A2LA with Testing Certificate #2555.01. The laboratories current scope of accreditation listing can be found as listed on the A2LA website. All measuring equipment is calibrated on an annual or bi-annual basis as listed for each respective test.

Client	Siemens Canada – Siemens Milltronics Process Instruments	
Product	SITRANS LR560 Profibus PA	
Model	7ML5440-xxx00-xBxx	
Standard(s)	IEC / EN 61326-1:2005 & IEC / EN 61326-2-5:2006	

Testing Environmental Conditions

Following environmental conditions were recorded in the facility during time of testing –

Date	Test	Init.	Temperature (°C)	Humidity (%)	Pressure (kPa)
Nov-4 to 12, 2010	Conducted Emission	MX	20 - 25	35 - 42%	100 - 102.0
Nov-4 to 12, 2010	Radiated Emission	MX	20 - 25	35 - 42%	100 - 102.0
Nov-4 to 12, 2010	ESD	MX	20 - 25	35 %	100 - 102.0
Nov-4 to 12, 2010	Radiated Immunity	MX	20 - 25	35 - 42%	100 - 102.0
Nov-4 to 12, 2010	EFT	MX	20 - 25	35 - 42%	100 - 102.0
Nov-4 to 12, 2010	Surge	MX	20 - 25	35 - 42%	100 - 102.0
Nov-4 to 12, 2010	Conducted Immunity	MX	20 - 25	35 - 42%	100 - 102.0

Client	Siemens Canada – Siemens Milltronics Process Instruments	
Product	SITRANS LR560 Profibus PA	
Model	7ML5440-xxx00-xBxx	
Standard(s)	IEC / EN 61326-1:2005 & IEC / EN 61326-2-5:2006	

Detailed Test Result Section

Client	Siemens Canada – Siemens Milltronics Process Instruments	
Product	SITRANS LR560 Profibus PA	
Model	7ML5440-xxx00-xBxx	
Standard(s)	IEC / EN 61326-1:2005 & IEC / EN 61326-2-5:2006	

Power Line Conducted Emissions

Purpose

The purpose of this test is to ensure that the RF energy unintentionally emitted from the EUT's power line does not exceed the limits listed below as defined in the applicable test standard, as measured from a LISN. This helps protect lower frequency radio services such as AM radio, shortwave radio, amateur radio operators, maritime radio, CB radio, and so on, from unwanted interference.

Limits & Method

The limits are as defined in CISPR 11 and FCC Part 15, Section 15.107 and the methods are given in CISPR 11 and ANSI C63.4:2003.

Average Limits		QuasiPeak Limits	
150 kHz – 500 kHz	56 to 46 dBuV	150 kHz – 500 kHz	66 to 56 dBuV
500 kHz – 5 MHz	46 dBuV	500 kHz – 5 MHz	56 dBuV
5 MHz – 30 MHz	50 dBuV	500 kHz – 30 MHz	60 dBuV

The limit decreases linearly with the logarithm of the frequency in the range 0.15 MHz to 0.50 MHz.

Note: If the Peak or Quasi Peak detector measurements do not exceed the Average limits, then the EUT is deemed to have passed the requirements.

Both limits are applicable, and each is specified as being measured with a 9 kHz measurement bandwidth.

Client	Siemens Canada – Siemens Milltronics Process Instruments	
Product	SITRANS LR560 Profibus PA	
Model	7ML5440-xxx00-xBxx	
Standard(s)	IEC / EN 61326-1:2005 & IEC / EN 61326-2-5:2006	

Typical Setup Diagram

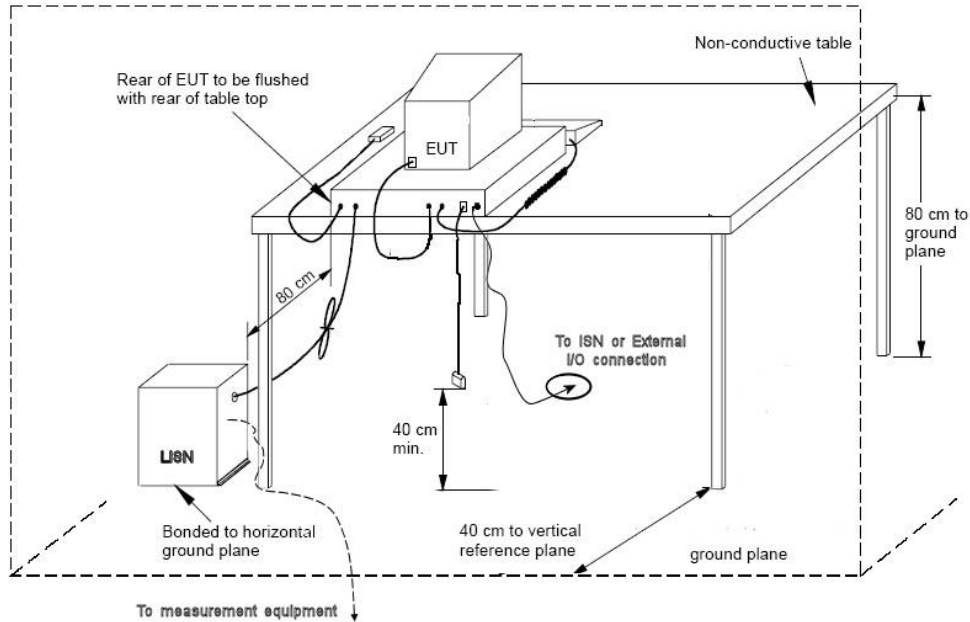

Measurement Uncertainty

The expanded measurement uncertainty is calculated in accordance with CISPR 16-4-2 and is ± 3.6 dB with a 'k=2' coverage factor and a 95% confidence level.

Preliminary Graphs

Note the graphs shown below are for graphical illustration only. For final measurements with the appropriate detector where applicable, please refer to the table. The graph shown below is a peak measurement graph, measured with a resolution bandwidth greater than or equal to the final required detector. These graphs are performed as a worst case measurement to enable the detection of frequencies of concern and for considerable time savings.

Client	Siemens Canada – Siemens Milltronics Process Instruments	
Product	SITRANS LR560 Profibus PA	
Model	7ML5440-xxx00-xBxx	
Standard(s)	IEC / EN 61326-1:2005 & IEC / EN 61326-2-5:2006	

Positive (Red) 24Vdc

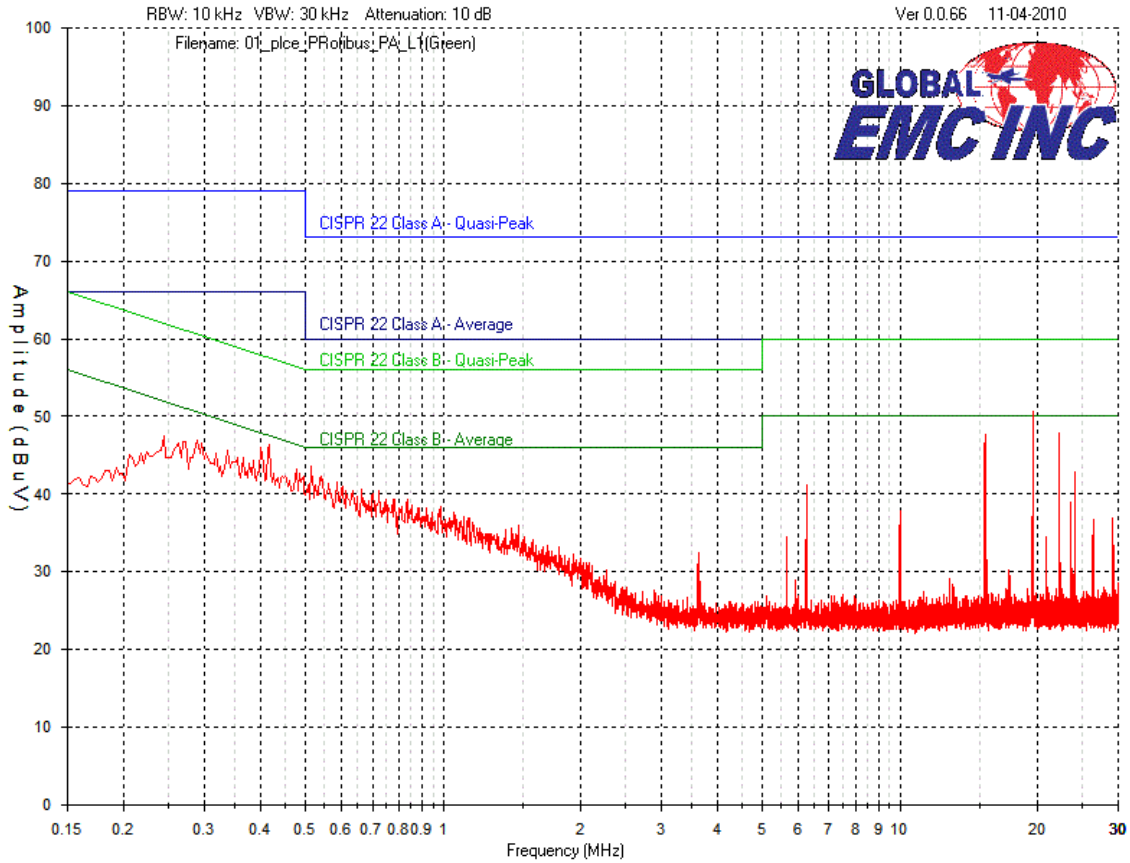

Client	Siemens Canada – Siemens Milltronics Process Instruments	
Product	SITRANS LR560 Profibus PA	
Model	7ML5440-xxx00-xBxx	
Standard(s)	IEC / EN 61326-1:2005 & IEC / EN 61326-2-5:2006	

Negative (White) 24Vdc

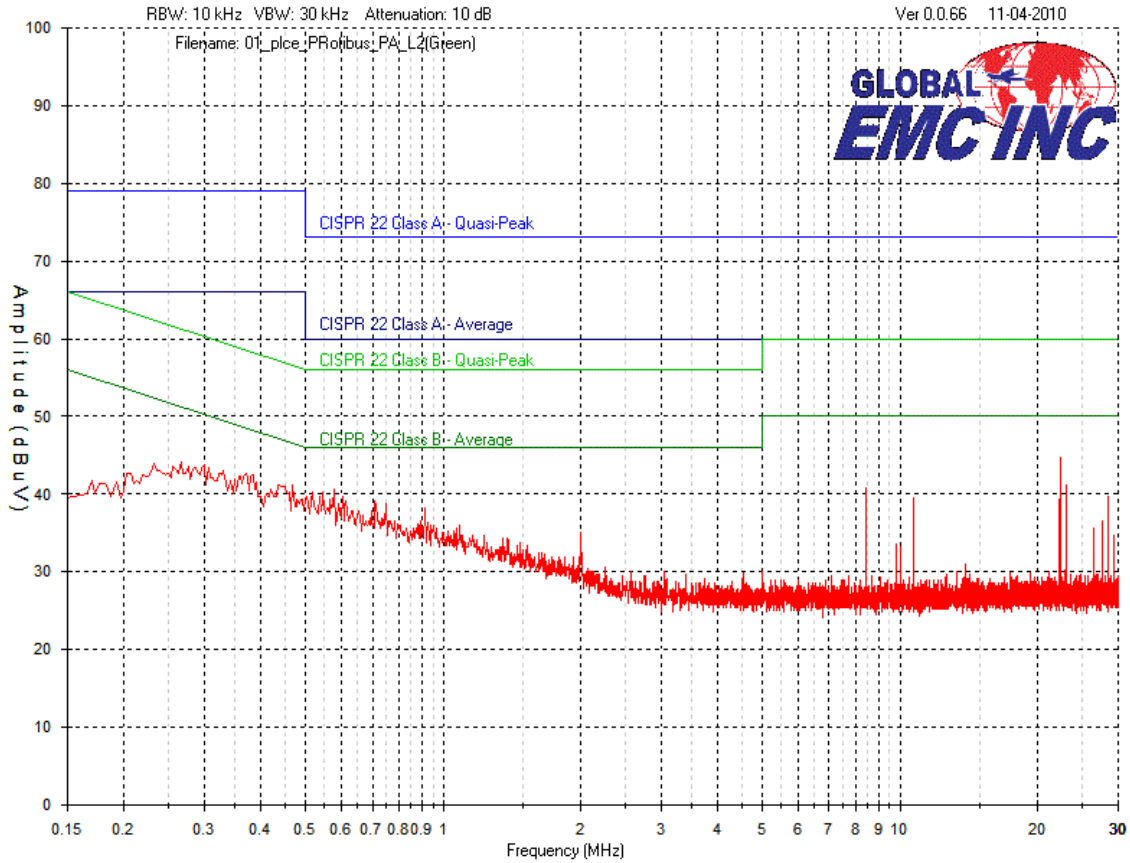

Client	Siemens Canada – Siemens Milltronics Process Instruments	
Product	SITRANS LR560 Profibus PA	
Model	7ML5440-xxx00-xBxx	
Standard(s)	IEC / EN 61326-1:2005 & IEC / EN 61326-2-5:2006	

Final Measurements

Product Category	Class B							
Product	SITRANS LR560 Profibus PA							
Supply	24 Vdc							
Positive (Red) – Peak Emission with respect to Quasi-Peak Limit								
Frequency (MHz)	Raw (dBuV)	Atten Factor (dB)	Cable Loss (dB)	LISN Factor (dB)	Level (dBuV)	Limit (dB)	Margin (dB)	Pass/Fail
19.5359	39.8	10	0.4	0.5	50.7	60	9.3	Pass
22.3229	36.9	10	0.4	0.5	47.8	60	12.2	Pass
15.3537	37	10	0.3	0.4	47.7	60	12.3	Pass
0.24409	36.6	10	0.1	0.8	47.5	62	14.5	Pass
22.3326	32.6	10	0.4	0.5	43.5	60	16.5	Pass
24.1106	31.9	10	0.4	0.5	42.8	60	17.2	Pass
Positive (Red) - Average								
19.5359	14.11	10	0.4	0.5	25.01	50	24.99	Pass
22.3229	17.43	10	0.4	0.5	28.33	50	21.67	Pass
15.3537	13.06	10	0.3	0.4	23.76	50	26.24	Pass
0.24409	25.25	10	0.1	0.8	36.15	52	15.85	Pass
Positive (Red) Peak Emission with respect to Average Limit								
22.3326	32.6	10	0.4	0.5	43.5	50	6.5	Pass
24.1106	31.9	10	0.4	0.5	42.8	50	7.2	Pass
Negative (White) - Peak Emission with respect to Quasi-Peak Limit								
22.4438	33.8	10	0.4	0.5	44.7	60	15.3	Pass
0.2666	33.4	10	0.1	0.7	44.2	61.2	17	Pass
23.1264	30.3	10	0.4	0.5	41.2	60	18.8	Pass
8.41486	30.3	10	0.2	0.2	40.7	60	19.3	Pass
28.5709	28.8	10	0.5	0.5	39.8	60	20.2	Pass
10.7225	29.1	10	0.2	0.2	39.5	60	20.5	Pass
Negative (White) - Average								
22.44857	22.31	10	0.4	0.5	33.21	50	16.79	Pass
0.27018	25.53	10	0.1	0.7	36.33	51.1	14.77	Pass

Client	Siemens Canada – Siemens Milltronics Process Instruments	
Product	SITRANS LR560 Profibus PA	
Model	7ML5440-xxx00-xBxx	
Standard(s)	IEC / EN 61326-1:2005 & IEC / EN 61326-2-5:2006	

23.12631	10.01	10	0.4	0.5	20.91	50	29.09	Pass
Negative (White) Peak Emission with respect to Average Limit								
8.41486	30.3	10	0.2	0.2	40.7	50	9.3	Pass
28.5709	28.8	10	0.5	0.5	39.8	50	10.2	Pass
10.7225	29.1	10	0.2	0.2	39.5	50	10.5	Pass

Note 1: No peak emission is above Quasi-Peak Limit; thus, the EUT meet conducted emission Quasi-Peak requirements base on peak measurement.

Note 2: See ‘Appendix B – EUT & Test Setup Photographs’ for photos showing the test set-up for the highest line conducted emission

Test Equipment List

Equipment	Model No.	Manufacturer	Last calibration date	Next calibration due date	Asset #
IFR Spectrum Analyzer	AN940	IFR	12/29/2009	12/29/2011	GEMC 6350
LISN	FCC-LISN-50/250-16-2-01	FCC	2009-02-11	2011-02-11	GEMC 65
RF Cable 7m	LMR-400-7M-50OHM-MN-MN	LexTec	NCR	NCR	GEMC 28
RF Cable 1m	LMR-400-1M-50OHM-MN-MN	LexTec	NCR	NCR	GEMC 29
Attenuator 10 dB	FP-50-10	Trilithic	NCR	NCR	GEMC 42

This report module is based on GEMC template “CISPR11 – Power Line Conducted Emissions Class B_Rev1”

Client	Siemens Canada – Siemens Milltronics Process Instruments	
Product	SITRANS LR560 Profibus PA	
Model	7ML5440-xxx00-xBxx	
Standard(s)	IEC / EN 61326-1:2005 & IEC / EN 61326-2-5:2006	

Radiated Emissions

Purpose

The purpose of this test is to ensure that the RF energy unintentionally emitted from the EUT does not exceed the limits listed below as defined in the applicable test standard, as measured from a receiving antenna. This helps protect broadcast radio services such as television, FM radio, pagers, cellular telephones, emergency services, and so on, from unwanted interference.

Limit(s) and Method

The limits are as defined in CISPR 11 and FCC Section 15.109(g) and the methods are given in CISPR 11 and ANSI C63.4:2003:

30 MHz – 230 MHz , 30 dBuV/m at 10m, extrapolated to 40.5 dBuV/m at 3m
 230 MHz – 1000 MHz, 37 dBuV/m at 10m, extrapolated to 47.5 dBuV/m at 3m

This limit is specified as being measured with a 120 kHz measurement bandwidth and a using a Quasi Peak detector.

Typical Radiated Emissions Setup

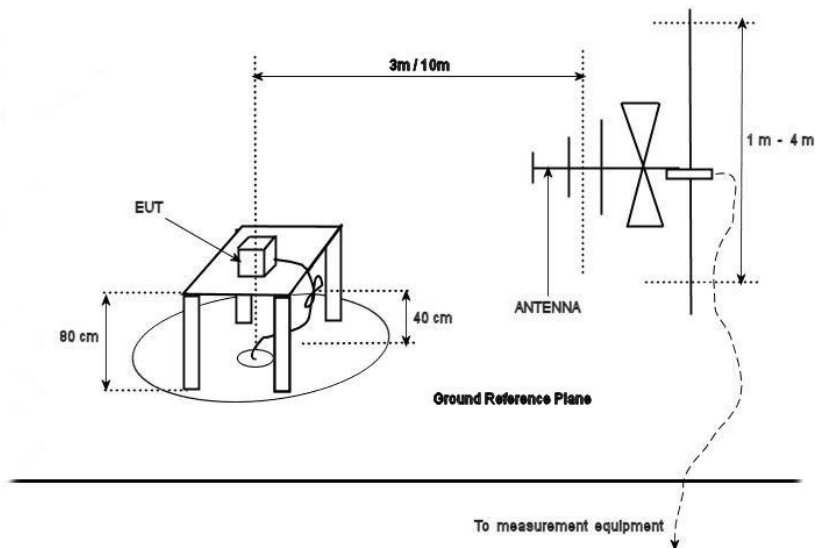

Note: In accordance with CISPR 11 section 5.2.2, testing was performed at a 3 meter test distance. Group 2 Class A equipment must be performed at 10 m or 30 m. An extrapolation factor of 10.5 dB was applied based on guidance provided in CISPR 11 section 7.2.3.

Client	Siemens Canada – Siemens Milltronics Process Instruments	
Product	SITRANS LR560 Profibus PA	
Model	7ML5440-xxx00-xBxx	
Standard(s)	IEC / EN 61326-1:2005 & IEC / EN 61326-2-5:2006	

Measurement Uncertainty

The expanded measurement uncertainty is calculated in accordance with CISPR 16-4-2 and is +/-4.4 dB with a ‘k=2’ coverage factor and a 95% confidence level.

Preliminary Graphs

Note the graphs shown below are for graphical illustration only. For final measurements with the appropriate detector, please refer to the final measurement table where applicable. The graph shown below is a maximized peak measurement graph, measured over a full 0-360 rotation. This peaking process is done as a worst case measurement. This process enables the detection of frequencies of concern for final measurement, and provides considerable time savings.

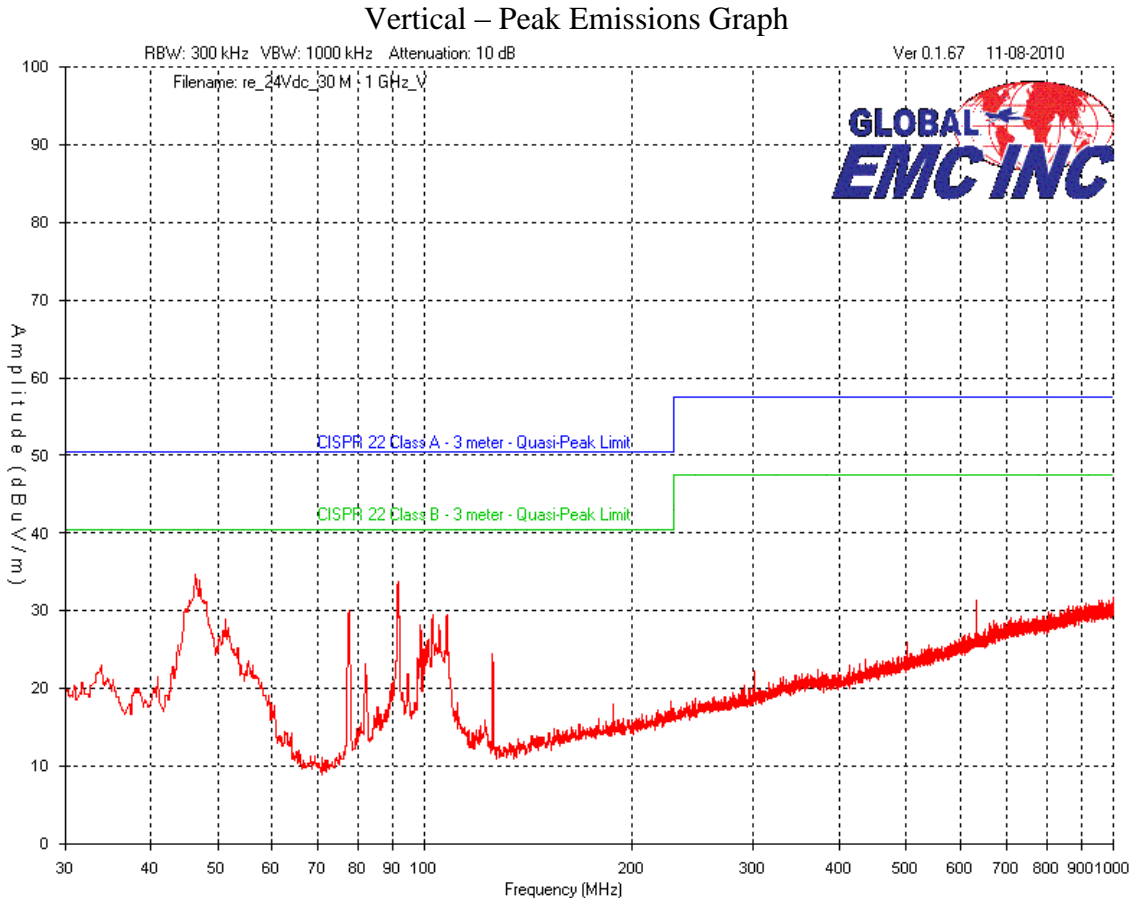

Client	Siemens Canada – Siemens Milltronics Process Instruments	
Product	SITRANS LR560 Profibus PA	
Model	7ML5440-xxx00-xBxx	
Standard(s)	IEC / EN 61326-1:2005 & IEC / EN 61326-2-5:2006	

Horizontal – Peak Emissions Graph

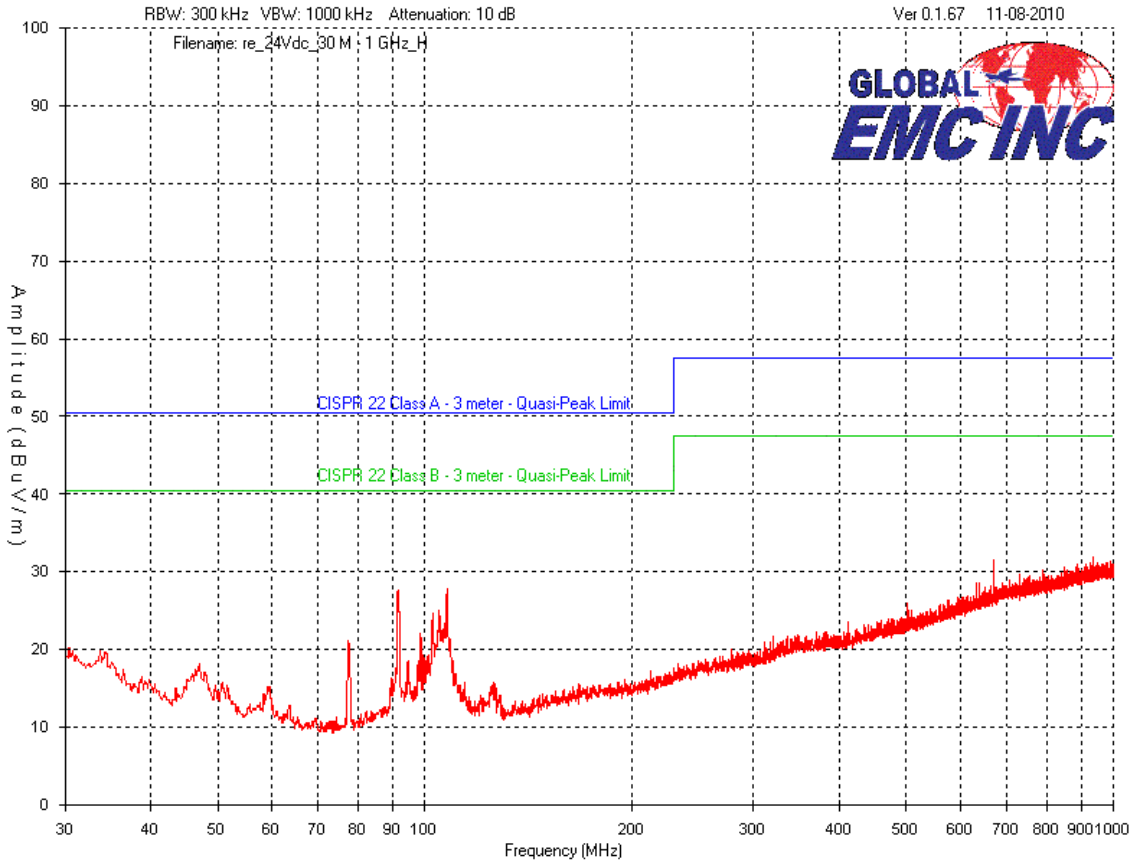

Client	Siemens Canada – Siemens Milltronics Process Instruments	
Product	SITRANS LR560 Profibus PA	
Model	7ML5440-xxx00-xBxx	
Standard(s)	IEC / EN 61326-1:2005 & IEC / EN 61326-2-5:2006	

Final Measurements

Product Category		Class B						
Product Name		SITRANS LR560 Profibus PA						
Supply		24 Vdc						
Quasi-Peak Emissions Table - Vertical								
Frequency (MHz)	Raw (dBuV)	Antenna Factor (dB/m)	Cable RE Factor (dB)	Pre-Amp (dB)	Level (dBuV/m)	Limit (dB)	Margin (dB)	Pass/Fail
47.9	45.8	9	0.3	-32	23.1	40.5	17.4	Pass
91.498	58.5	8.7	0.5	-32	35.7	40.5	4.8	Pass
Peak Emission with respect to Quasi-Peak Limit - Vertical								
77.53	55.5	6.1	0.4	-32	30	40.5	10.5	Pass
102.556	51.9	9.2	0.5	-32	29.6	40.5	10.9	Pass
107.6	52.3	8.6	0.5	-32	29.4	40.5	11.1	Pass
98.385	50.3	9.4	0.5	-32	28.2	40.5	12.3	Pass
Quasi Peak Emissions Table - Horizontal								
107.697	42.5	8.6	0.5	-32	19.6	40.5	20.9	Pass
91.401	50.6	8.7	0.5	-32	27.8	40.5	12.7	Pass
Peak Emission with respect to Quasi-Peak Limit – Horizontal								
932.585	38	22.6	1.4	-30.1	31.9	47.5	15.6	Pass
98.482	44.1	9.4	0.5	-32	22	40.5	18.5	Pass
77.433	46.6	6.1	0.4	-32	21.1	40.5	19.4	Pass
30.388	35.9	16.1	0.3	-32	20.3	40.5	20.2	Pass

Note: See ‘Appendix B – EUT & Test Setup Photographs’ for photos showing the test set-up for the highest line conducted emission

Client	Siemens Canada – Siemens Milltronics Process Instruments	
Product	SITRANS LR560 Profibus PA	
Model	7ML5440-xxx00-xBxx	
Standard(s)	IEC / EN 61326-1:2005 & IEC / EN 61326-2-5:2006	

Test Equipment List

Equipment	Model No.	Manufacturer	Last calibration date	Next calibration due date	Asset #
IFR Spectrum Analyzer	AN940	IFR	12/29/2009	12/29/2011	GEMC 6350
BiLog Antenna	3142-C	ETS	2009-02-12	2011-02-12	GEMC 8
Attenuator 3 dB	FP-50-3	Trilithic	NCR	NCR	GEMC 40
Chase Preamp 9kHz - 2 GHz	CPA9231A	Chase	8/25/2010	8/25/2012	GEMC 6403
RF Cable 7m	LMR-400-7M-50OHM-MN-MN	LexTec	NCR	NCR	GEMC 28
RF Cable 1m	LMR-400-1M-50OHM-MN-MN	LexTec	NCR	NCR	GEMC 29
RF Cable 0.5M	LMR-400-0.5M-50OHM-MN-MN	LexTec	NCR	NCR	GEMC 31

This report module is based on GEMC template "CISPR11 – Radiated Emissions Class B_Rev1"

Client	Siemens Canada – Siemens Milltronics Process Instruments	
Product	SITRANS LR560 Profibus PA	
Model	7ML5440-xxx00-xBxx	
Standard(s)	IEC / EN 61326-1:2005 & IEC / EN 61326-2-5:2006	

Electro-Static Discharge

Purpose

The purpose of this immunity test is to apply a static electricity discharge from the operator to the EUT, or create a nearby discharge field. An example of can be seen in low humidity when a person touches an object and creates is a small spark. This spark may be potentially harmful to the operation of the EUT. Most real life discharges are ‘air’ as shown in the previous example. The ‘contact’ method, with related reduced voltages, has been shown to be roughly equivalent ‘air’ in it is severity. ‘Contact’ is the preferred method due to its reproducibility. Contact method will be performed unless the discharge point is significantly insulated and the insulation can not be easily broken through. This test ensures a minimum level of immunity which is likely to occur. This test does not guarantee that the EUT will not experience a higher level which may cause it to fail.

Application Level Requirement

This test is performed in accordance with the methodology defined in IEC 61000-4-2. 25 hits in negative and positive polarity will be performed at each defined discharge point on the EUT. These are called direct discharges, irrespective of contact or air being applied. Also, Horizontal Coupling Plane (HCP) and the Vertical Coupling Plane(VCP) discharges will be performed. These are called indirect discharges. For a picture representation of the EUT discharge points, see Appendix B - EUT and Test Setup Photos. For a text description of the EUT discharge points, see Appendix A - Client Provided Details. For a EUT criteria description, see Appendix A - Client Provided Details.

A level of $\pm 2, 4, 6$ kV contact, or $\pm 2, 4, 8$ kV air where applicable, was applied to each defined discharge point. Each level was ramped up by applying the lower levels first. Criteria level ‘B’ as defined in “Appendix A - Client Provided Details” was applied to this test, however all anomalies are noted.

Client	Siemens Canada – Siemens Milltronics Process Instruments	
Product	SITRANS LR560 Profibus PA	
Model	7ML5440-xxx00-xBxx	
Standard(s)	IEC / EN 61326-1:2005 & IEC / EN 61326-2-5:2006	

Typical ESD Setup

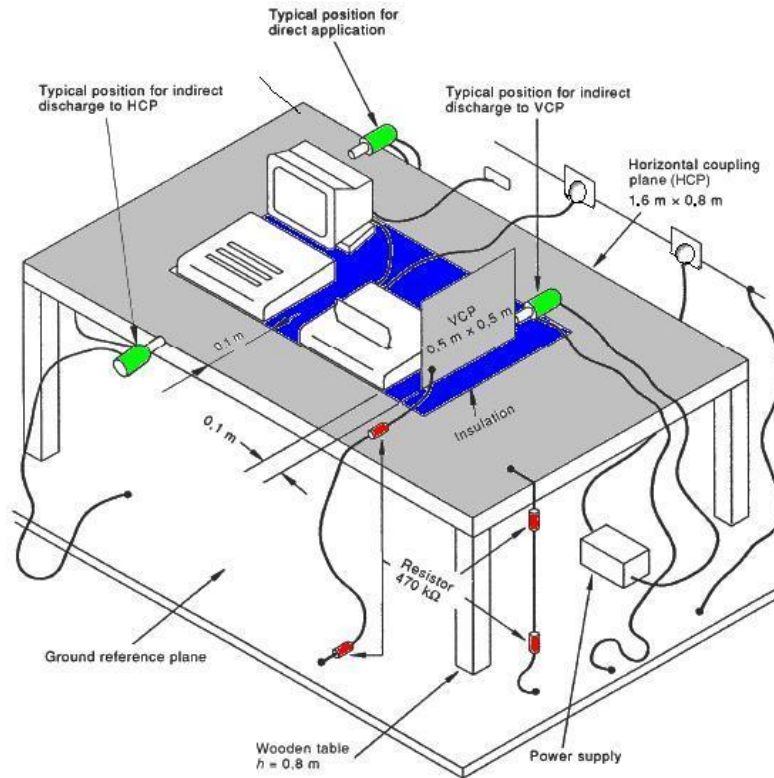

Application Level Accuracy

Contact discharge: +/- 15% as measured at tip.

Test Results

The EUT passed the requirements. For discharge to exterior points, the EUT meet criteria A; and for discharge to interior points, the EUT meet criteria C. The performance criteria are defined in Appendix A “Client Provided Details.”

During the application of ESD to the Display contact PCB traces, the EUT resets at +/- 4 and 6 kV. The EUT recovers without operator intervention.

No other anomalies are observed.

Note: The maximum measured distance variation allow is ± 25 mm and the status must be good with two (2) retries for the EUT to meet Criteria A.

Client	Siemens Canada – Siemens Milltronics Process Instruments	
Product	SITRANS LR560 Profibus PA	
Model	7ML5440-xxx00-xBxx	
Standard(s)	IEC / EN 61326-1:2005 & IEC / EN 61326-2-5:2006	

Exterior			
Location	Test Voltage	Discharge Type	Pass / Fail
1. Body of EUT – Lid: Top, Left, Right	+/- 2, 4, 6 kV	Contact	Pass
2. Lid Screw	+/- 2, 4, 6 kV	Contact	Pass
3. Grounding Lug	+/- 2, 4, 6 kV	Contact	Pass
4. Lower Body of EUT: Top, Left, Right	+/- 2, 4, 6 kV	Contact	Pass
5. Purge Adaptor	+/- 2, 4, 6 kV	Contact	Pass
6. Upper Body of EUT: Top, Left, Right	+/- 2, 4, 6 kV	Contact	Pass
7. Flange: Top, Left, Right	+/- 2, 4, 6 kV	Contact	Pass
8. VCP & HCP	+/- 2, 4, 6 kV	Contact	Pass
9. Lid window	+/- 2, 4, 8 kV	Air	Pass (No Discharge)
10. Conduit Adaptor	+/- 2, 4, 8 kV	Air	Pass (No Discharge)
11. I/O Cable	+/- 2, 4, 8 kV	Air	Pass
12. Ground Cable	+/- 2, 4, 8 kV	Air	Pass

Interior			
Location	Test Voltage	Discharge Type	Pass / Fail
1. LCD Display	+/- 2, 4, 8 kV	Air	Pass (No Discharge)
2. Buttons x4	+/- 2, 4, 8 kV	Air	Pass (No Discharge)
3. Terminal Block	+/- 2, 4, 6 kV	Contact	Pass

Client	Siemens Canada – Siemens Milltronics Process Instruments	
Product	SITRANS LR560 Profibus PA	
Model	7ML5440-xxx00-xBxx	
Standard(s)	IEC / EN 61326-1:2005 & IEC / EN 61326-2-5:2006	

4. Ground Screw	+/- 2, 4, 6 kV	Contact	Pass
5. Display Contact Traces	+/- 2, 4, 6 kV	Contact	Pass

The following tables summarize the test results recorded:

Exterior

ESD	2, 4kV Contact		
	Digital distances (mm)		
	Initial	Variation	Results
Average	975.4		
Minimum	974.6	973.4	-2.0
Maximum	976.3	981.2	5.8
Criteria			A
Status			128.0000

ESD	6kV Contact		
	Digital distances (mm)		
	Initial	Variation	Results
Average	979.5		
Minimum	977.9	975.0	-4.5
Maximum	979.8	983.1	3.6
Criteria			A
Status			128.0000

ESD	2, 4, 8kV Air		
	Digital distances (mm)		
	Initial	Variation	Results
Average	993.6		
Minimum	991.2	988.0	-5.6
Maximum	996.0	996.0	2.4
Criteria			A
Status			128.0000

Interior

ESD	2, 4, 6kV Contact TB & GndLug		
	Digital distances (mm)		
	Initial	Variation	Results
Average	980.7		
Minimum	980.3	976.5	-4.2
Maximum	981.3	981.6	0.9
Criteria			A
Status			128.0000

ESD	2, 4, 6kV Contact on LCD Traces		
	Digital distances (mm)		
	Initial	Variation	Results
Average	979.9		
Minimum	978.5	0.0	-979.9
Maximum	980.9	987.4	7.5
Criteria			C
Status			114.5232

Client	Siemens Canada – Siemens Milltronics Process Instruments	
Product	SITRANS LR560 Profibus PA	
Model	7ML5440-xxx00-xBxx	
Standard(s)	IEC / EN 61326-1:2005 & IEC / EN 61326-2-5:2006	

ESD	2, 4, 8kV Air Inside		
	Digital distances (mm)		
	Initial	Variation	Results
Average	979.3		
Minimum	976.9	976.9	-2.4
Maximum	980.4	980.9	1.6
Criteria			A
Status			128.0000

Test Equipment List

Equipment	Model No.	Manufacturer	Last calibration date	Next calibration due date	Asset #
Minizap ESD Simulator	Minizap	Thermo Electron Corp	Feb. 11, 2009	Feb. 11, 2011	GEMC 1
ESD HCP	80CMX160CM	Global EMC	NCR	NCR	GEMC 50
ESD VCP	50CMX50CM1	Global EMC	NCR	NCR	GEMC 51
ESD 470K A	2X470KOHM100CM	Global EMC	NCR	NCR	GEMC 52
ESD 470K B	2X470KOHM100CM	Global EMC	NCR	NCR	GEMC 53

This report module is based on GEMC report template 'IEC61000-4-2_ESD_Rev1'

Client	Siemens Canada – Siemens Milltronics Process Instruments	
Product	SITRANS LR560 Profibus PA	
Model	7ML5440-xxx00-xBxx	
Standard(s)	IEC / EN 61326-1:2005 & IEC / EN 61326-2-5:2006	

Radiated Field Immunity

Purpose

The EUT will likely be exposed to intentional sources of RF energy during the EUTs application. Sources of such radiations can be cellular phones, FM radio, television, remote car alarms, garage door openers, and other broadcast transmissions. These sources of radiations are licensed or certified for broadcast; hence the EUT should be immune to their RF energy. This test gives the test levels that the EUT should be immune to in order to assure the EUTs operation in expected field strengths. This test does not guarantee that the EUT will not experience a higher level field during its' operation, which may cause the EUT to fail.

Application Level Requirement

This test is performed in accordance with the methodology defined in IEC 61000-4-3. The immunity tests were performed over the frequency range of 80 MHz to 1 GHz and 1.4 GHz to 2.7 GHz ranges. Frequency steps used were calculated at 1% step size of the previous frequency, rounded down to the nearest kHz, as the frequency range is ramped up. The level applied to the EUT was calibrated at 10 V/m. A modulation of 80% AM 1 kHz sine wave was applied during the application of the RF energy at each frequency. Both horizontal and vertical polarization was applied. 6 sides of the EUT were subjected to RF field. The dwell time used was 2.0 seconds. Forward power was monitored, and kept on file at Global EMC Inc. An isotropic field probe was placed in near proximity of the EUT to verify the application of the field. Criteria level 'A' as defined in "Appendix A – Client Provided Details" was applied to this test.

Input Voltage and Frequency	24Vdc
Frequency range and signal strength	80 MHz – 1 GHz – 10 V/m (80% AM) 1.4 GHz – 2.0 GHz – 10 V/m (80% AM) 2.0 GHz – 2.7 GHz - 1 V/m (80% AM) (tested at 10 V/m)
Sweep step	1% of fundamental.
Dwell time	2 s
EUT type	Table top

Client	Siemens Canada – Siemens Milltronics Process Instruments	
Product	SITRANS LR560 Profibus PA	
Model	7ML5440-xxx00-xBxx	
Standard(s)	IEC / EN 61326-1:2005 & IEC / EN 61326-2-5:2006	

Typical Test Setup

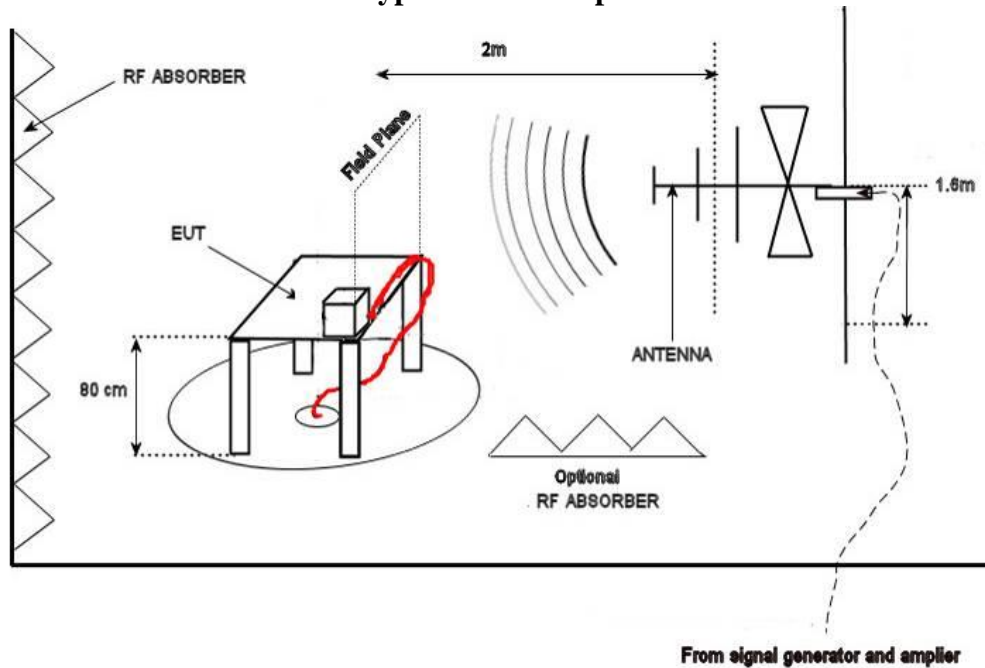

Application Level Accuracy

As per IEC61000-4-3, the RF field is specified as 0 to +6 dB for at least 12 of the 16 calibration points. For a 10 V/m field, this allows for the EUT to be subjected to a field of 10 V/m to 20 V/m with at least 75% coverage at this level.

Test Results

The EUT passed the requirements. The EUT met Criteria A as defined in “Appendix A – Client Provided Details”. No anomalies were observed. The EUT performs within manufacturer specified tolerances.

Note: The maximum measured distance variation allow is ± 25 mm and the status must be good with two (2) retries for the EUT to meet Criteria A.

Client	Siemens Canada – Siemens Milltronics Process Instruments	
Product	SITRANS LR560 Profibus PA	
Model	7ML5440-xxx00-xBxx	
Standard(s)	IEC / EN 61326-1:2005 & IEC / EN 61326-2-5:2006	

The following tables summarize the test results recorded:

Radiated Immunity 80 MHz – 1 GHz

Side	BH		
	Digital distances (mm)		
	Initial	Variation	Results
Average	978.8		
Minimum	978.3	978.3	-0.5
Maximum	979.5	981.1	2.3
Criteria			A
Status			128.0000

Side	BV		
	Digital distances (mm)		
	Initial	Variation	Results
Average	979.2		
Minimum	977.8	977.4	-1.8
Maximum	980.3	981.2	2.0
Criteria			A
Status			128.0000

Side	BtH		
	Digital distances (mm)		
	Initial	Variation	Results
Average	987.3		
Minimum	984.1	984.1	-3.2
Maximum	988.3	988.3	1.0
Criteria			A
Status			128.0000

Side	BtV		
	Digital distances (mm)		
	Initial	Variation	Results
Average	988.0		
Minimum	987.6	982.5	-5.5
Maximum	988.5	988.5	0.5
Criteria			A
Status			128.0000

Side	FH		
	Digital distances (mm)		
	Initial	Variation	Results
Average	941.6		
Minimum	940.2	938.4	-3.2
Maximum	942.8	944.1	2.5
Criteria			A
Status			128.0000

Side	FV		
	Digital distances (mm)		
	Initial	Variation	Results
Average	941.4		
Minimum	940.6	937.8	-3.5
Maximum	942.2	943.4	2.0
Criteria			A
Status			128.0000

Client	Siemens Canada – Siemens Milltronics Process Instruments	
Product	SITRANS LR560 Profibus PA	
Model	7ML5440-xxx00-xBxx	
Standard(s)	IEC / EN 61326-1:2005 & IEC / EN 61326-2-5:2006	

Side	LH		
	Digital distances (mm)		
	Initial	Variation	Results
Average	992.9		
Minimum	992.3	990.6	-2.3
Maximum	993.4	993.7	0.8
Criteria			A
Status			128.0000

Side	LV		
	Digital distances (mm)		
	Initial	Variation	Results
Average	992.2		
Minimum	990.7	990.7	-1.5
Maximum	993.3	993.3	1.1
Criteria			A
Status			128.0000

Side	RH		
	Digital distances (mm)		
	Initial	Variation	Results
Average	924.6		
Minimum	923.5	920.2	-4.4
Maximum	926.1	927.3	2.7
Criteria			A
Status			128.0000

Side	RV		
	Digital distances (mm)		
	Initial	Variation	Results
Average	926.1		
Minimum	924.8	920.4	-5.7
Maximum	927.4	927.4	1.4
Criteria			A
Status			128.0000

Side	TH		
	Digital distances (mm)		
	Initial	Variation	Results
Average	1050.2		
Minimum	1047.2	1033.6	-16.7
Maximum	1053.0	1053.3	3.1
Criteria			A
Status			128.0000

Side	TV		
	Digital distances (mm)		
	Initial	Variation	Results
Average	1050.9		
Minimum	1049.2	1031.0	-19.9
Maximum	1051.8	1054.2	3.3
Criteria			A
Status			128.0000

Radiated Immunity 1.4 GHz – 2.7 GHz

Side	BH		
	Digital distances (mm)		
	Initial	Variation	Results
Average	990.6		
Minimum	990.0	990.0	-0.5
Maximum	992.0	992.0	1.4
Criteria			A
Status			128.0000

Side	BV		
	Digital distances (mm)		
	Initial	Variation	Results
Average	990.7		
Minimum	990.4	990.2	-0.5
Maximum	990.9	990.9	0.2
Criteria			A
Status			128.0000

Client	Siemens Canada – Siemens Milltronics Process Instruments	
Product	SITRANS LR560 Profibus PA	
Model	7ML5440-xxx00-xBxx	
Standard(s)	IEC / EN 61326-1:2005 & IEC / EN 61326-2-5:2006	

Side	BtH		
	Digital distances (mm)		
	Initial	Variation	Results
Average	1004.7		
Minimum	1004.0	1003.5	-1.2
Maximum	1005.5	1005.5	0.8
Criteria			A
Status			128.0000

Side	BtV		
	Digital distances (mm)		
	Initial	Variation	Results
Average	1005.6		
Minimum	1003.8	1003.8	-1.8
Maximum	1010.1	1010.8	5.2
Criteria			A
Status			128.0000

Side	FH		
	Digital distances (mm)		
	Initial	Variation	Results
Average	970.2		
Minimum	969.9	969.6	-0.6
Maximum	970.8	971.2	0.9
Criteria			A
Status			128.0000

Side	FV		
	Digital distances (mm)		
	Initial	Variation	Results
Average	970.4		
Minimum	970.1	969.7	-0.7
Maximum	970.7	971.2	0.7
Criteria			A
Status			128.0000

Side	LH		
	Digital distances (mm)		
	Initial	Variation	Results
Average	965.2		
Minimum	964.4	963.9	-1.3
Maximum	965.7	965.7	0.5
Criteria			A
Status			128.0000

Side	LV		
	Digital distances (mm)		
	Initial	Variation	Results
Average	964.0		
Minimum	963.3	963.3	-0.7
Maximum	964.7	965.7	1.7
Criteria			A
Status			128.0000

Side	RH		
	Digital distances (mm)		
	Initial	Variation	Results
Average	965.6		
Minimum	964.9	964.9	-0.8
Maximum	966.2	967.0	1.4
Criteria			A
Status			128.0000

Side	RV		
	Digital distances (mm)		
	Initial	Variation	Results
Average	965.2		
Minimum	964.0	960.4	-4.7
Maximum	966.6	972.4	7.2
Criteria			A
Status			128.0000

Client	Siemens Canada – Siemens Milltronics Process Instruments	
Product	SITRANS LR560 Profibus PA	
Model	7ML5440-xxx00-xBxx	
Standard(s)	IEC / EN 61326-1:2005 & IEC / EN 61326-2-5:2006	

Side	TH		
	Digital distances (mm)		
	Initial	Variation	Results
Average	974.8		
Minimum	974.5	974.5	-0.3
Maximum	977.2	977.2	2.4
Criteria			A
Status			128.0000

Side	TV		
	Digital distances (mm)		
	Initial	Variation	Results
Average	989.5		
Minimum	988.6	988.6	-0.9
Maximum	990.8	1000.6	11.1
Criteria			A
Status			128.0000

Test Equipment List

Equipment	Model No.	Manufacturer	Last calibration date	Next calibration due date	Asset #
Signal Generator	SMT 03	Rhode and Schwarz	July 1, 2009	July 1, 2011	GEMC 2
BiLog Antenna	3142-C	ETS	Feb. 12, 2009	Feb. 12, 2011	GEMC 8
Horn Antenna 1 – 4.2GHz	AT 4510	AR	NCR	NCR	GEMC 26
Power Amplifier	150W1000	AR	NCR	NCR	GEMC 23
Power Amplifier	10S1G4A	AR	NCR	NCR	GEMC 24
Field probe	FL 7006	AR	Aug 19, 2010	Aug 19, 2012	GEMC 25
Field Mon.	FM7004	AR	Aug 19, 2010	Aug 19, 2012	GEMC 13
Power Head	PH 2000	AR	Feb. 11, 2009	Feb. 11, 2011	GEMC 15
Power meter	PM 2002	AR	Feb. 9, 2009	Feb. 9, 2011	GEMC 16

This report is based upon GEMC report template 'IEC61000-4-3_RadiatedImmunity_Rev1'

Client	Siemens Canada – Siemens Milltronics Process Instruments	
Product	SITRANS LR560 Profibus PA	
Model	7ML5440-xxx00-xBxx	
Standard(s)	IEC / EN 61326-1:2005 & IEC / EN 61326-2-5:2006	

Electrical Fast Transients / Bursts

Purpose

Electronic fast transients / bursts are simulated in this test on the supply and I/O lines of the EUT. In a typical application environment, fast voltage disturbances may be injected into these ports of the EUT. These signals usually arise from nearby switching circuitry such as a light switch, relay bounces, electric motor noise, or other such electrical phenomenon. The EUT should be immune to such disturbances. This test does not guarantee that the EUT will not experience a higher level field during its' operation, which may cause the EUT to fail.

Application Level Requirement

This test is performed in accordance with the methodology defined in IEC 61000-4-4. The voltage waveform applied has the following characteristics:

- Pulse rise time 5 ns \pm 30%
- Pulse duration (to 50% value) 50ns \pm 30%
- Pulse repetition frequency 5kHz (75 pulses per burst train)
- Burst duration should be 15 ms \pm 20%
- Burst period should be 300 ms \pm 20%

Bursts are applied for 1 minute each at positive and negative for DC power and/or I/O lines and Ground Line.

A test level of 500 V and 1 kV was applied to I/O and/or DC power lines, and ground line via a capacitive coupling clamp. Lower levels were evaluated by ramping up to the required level. Criteria level 'A' as defined in "Appendix A – Client Provided Details" was applied to this test.

Test Voltage	Repetition rate	Coupling Lines	Result
+/- 1 kV, +/- 0.5 kV	5 kHz	I/O and/or DC Lines	Pass
+/- 1 kV, +/- 0.5 kV	5 kHz	Ground Line	Pass

Client	Siemens Canada – Siemens Milltronics Process Instruments	
Product	SITRANS LR560 Profibus PA	
Model	7ML5440-xxx00-xBxx	
Standard(s)	IEC / EN 61326-1:2005 & IEC / EN 61326-2-5:2006	

Typical Test Setup

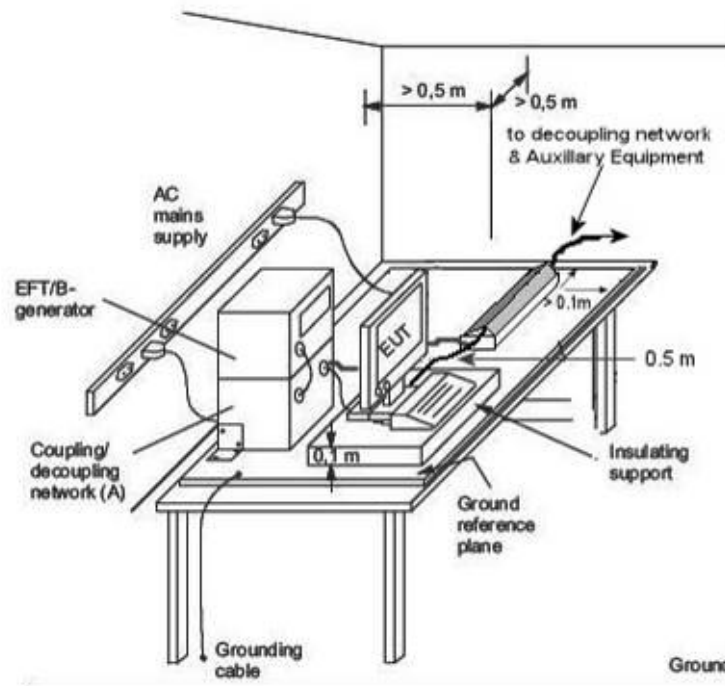

Application Level Accuracy

As per IEC61000-4-4, the level is specified as being within +/- %20. For an application level of 1kV, this allows for the EUT to be subjected to 980 V to 1.2 kV.

Test Results

The EUT passed the requirements. The EUT met Criteria A as defined in “Appendix A – Client Provided Details”. No anomalies were observed. The EUT performs within manufacturer specified tolerances.

Note: The maximum measured distance variation allow is ± 25 mm and the status must be good with two (2) retries for the EUT to meet Criteria A.

Client	Siemens Canada – Siemens Milltronics Process Instruments	
Product	SITRANS LR560 Profibus PA	
Model	7ML5440-xxx00-xBxx	
Standard(s)	IEC / EN 61326-1:2005 & IEC / EN 61326-2-5:2006	

The following tables summarize the test results recorded:

Cable	I/O		
	Digital distances (mm)		
	Initial	Variation	Results
Average	1023.0		
Minimum	1021.6	1019.2	-3.8
Maximum	1025.6	1025.6	2.6
Criteria			A
Status			128.0000

Cable	Gnd		
	Digital distances (mm)		
	Initial	Variation	Results
Average	1010.8		
Minimum	1009.9	1009.4	-1.4
Maximum	1011.8	1012.0	1.2
Criteria			A
Status			128.0000

Equipments Used

Following equipments were used for EFT immunity testing of the device.

Equipment	Model No.	Manufacturer	Last calibration date	Next calibration due date	Asset #
Immunity generator	EMC Pro Plus	Keytek Thermo Corp	Feb. 13, 2009	Feb. 13, 2011	GEMC 4
CCL Clamp	EMC Pro Plus	Keytek Thermo Corp	NCR	NCR	GEMC 5

This report module is based on GEMC report template 'IEC61000-4-4_EFTB_Rev1'

Client	Siemens Canada – Siemens Milltronics Process Instruments	
Product	SITRANS LR560 Profibus PA	
Model	7ML5440-xxx00-xBxx	
Standard(s)	IEC / EN 61326-1:2005 & IEC / EN 61326-2-5:2006	

Surge

Purpose

Surge occurs when a high energy disturbance takes place on the power, or less frequently I/O lines. These disturbances can cause significant temporary increases in current and/or voltage. These disturbances can arise during a nearby storm due to lightning, circuit trips, short-circuits on the same power line the equipment is connected to. The sudden rise in voltage over a very short period of time could cause damage to the components of the EUT. Surges are simulated during this test to test the EUTs immunity to surges. This test differs from EFT / B in that this waveform has more sufficient time to allow for damage to the EUT. This test does not guarantee that the EUT will not experience a higher level field during its' operation, which may cause the EUT to fail. This test does not ensure operation of the EUT in the presence of direct lightning effects.

Application Level Requirement

This test was performed in accordance with the methodology defined in IEC61000-4-5. Surges are simulated using a waveform generator. The characteristics of the waveform generated are as follows –

- Rise time of 1.2 μ S and wave duration of 50 μ S (to 50%) into an open circuit
- Rise time of 8 μ S and wave duration of 20 μ S (to 50%) into a short circuit
- Dwell time between each surge was 60s.
- 5 surges in positive and 5 surges in negative are performed
- For AC systems; 0 °, 90 °, and 270 ° phases of waveform are tested
- For AC systems; Line – PE is performed at 2 times the Line – Line voltage

A test level of ± 0.5 kV and ± 1.0 kV was applied directly to the shield of the shielded cable. Lower levels were evaluated by ramping up to the required level. Criteria level 'A' as defined in "Appendix A – Client Provided Details" was applied to this test.

Client	Siemens Canada – Siemens Milltronics Process Instruments	
Product	SITRANS LR560 Profibus PA	
Model	7ML5440-xxx00-xBxx	
Standard(s)	IEC / EN 61326-1:2005 & IEC / EN 61326-2-5:2006	

Typical Test Setup

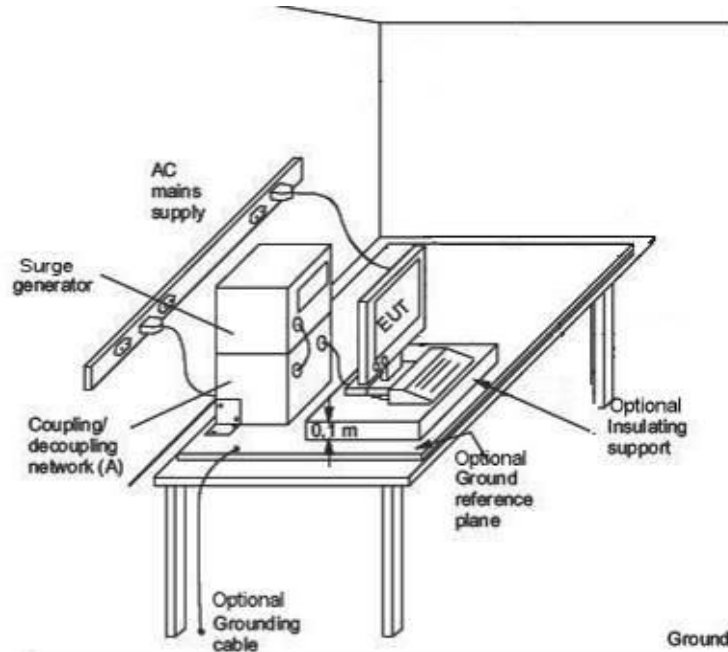

Application Level Accuracy

As per IEC61000-4-5 the level is specified as being within +/- 10% for open circuit voltage calibration or +/- 10% short circuit current calibration. The EUTs input impedance or whether Line – PE or Line – Line is being performed, combined with the calibrated generators output impedance will effect the timing and voltage/current of the waveform applied to the EUT.

Test Results

The EUT passed the requirements. The EUT meet Criteria A as defined in “Appendix A – Client Provided Details.” No anomalies were observed. The EUT operated within manufacturer tolerances.

Test Voltage	Phase angles	Number of surges	Coupling lines	Pass / Fail
+/- 1 kV	Random	5	Shield – PE	Pass
+/- 1 kV	Random	5	Shield – PE	Pass
+/- 0.5 kV	Random	5	Shield – PE	Pass

Client	Siemens Canada – Siemens Milltronics Process Instruments	
Product	SITRANS LR560 Profibus PA	
Model	7ML5440-xxx00-xBxx	
Standard(s)	IEC / EN 61326-1:2005 & IEC / EN 61326-2-5:2006	

+/- 0.5 kV	Random	5	Shield – PE	Pass
------------	--------	---	-------------	------

Note: The maximum measured distance variation allow is ± 25 mm and the status must be good with two (2) retries for the EUT to meet Criteria A.

The following table summarizes the test results recorded:

Cable	I/O		
	Digital distances (mm)		
	Initial	Variation	Results
Average	981.5		
Minimum	980.7	975.5	-6.1
Maximum	983.4	984.8	3.2
Criteria			A
Status			128.0000

Test Equipment List

Equipment	Model No.	Manufacturer	Last calibration date	Next calibration due date	Asset #
Immunity generator	EMC Pro Plus	Keytek Thermo Corp	Feb. 13, 2009	Feb. 13, 2011	GEMC 4

This report module is based on GEMC report template 'IEC61000-4-5_Surge_Rev1'

Client	Siemens Canada – Siemens Milltronics Process Instruments	
Product	SITRANS LR560 Profibus PA	
Model	7ML5440-xxx00-xBxx	
Standard(s)	IEC / EN 61326-1:2005 & IEC / EN 61326-2-5:2006	

Conducted RF Immunity

Purpose

The EUT will likely be exposed to low frequency intentional sources of RF energy during the EUTs application. Sources of such radiations can be AM radio, shortwave radio, CB transmissions, and other low frequency broadcast transmissions. These sources of radiations are licensed or certified for broadcast; hence the EUT should be immune to their RF energy. Due to the properties of radio, the power or I/O lines on the EUT would likely be the passive receiving antenna that induces the disturbance to the EUT. Since this is the main method of coupling at this frequency range, the direct application of the RF energy to the line being tested is used. At this frequency range and level, this method is easier to produce and reproduce in a laboratory environment than subjecting the EUT to an equivalent RF field.

Application Level Requirement

This test is performed in accordance with the methodology defined in IEC 61000-4-6. I/O cables and DC power lines were performed using a bulk current injection probe. The immunity test is performed over the frequency range of 10 kHz to 80 MHz. Frequency steps used were calculated at 1% step size of the previous frequency, rounded down to the nearest kHz, as the frequency range is ramped up. Known clock frequencies, local oscillators, etc, shall be analyzed separately, these are defined in “Appendix A – Client Provided Details”. The level applied to the EUT was calibrated at 10 Vrms. A modulation of 80% AM 1kHz sine wave was applied during the application of the RF energy at each frequency. The dwell time used was 3.0 seconds. A current probe was placed between the coupling device and the EUT to verify the application of the RF energy. Criteria level ‘A’ as defined in “Appendix A – Client Provided Details” was applied to this test.

Client	Siemens Canada – Siemens Milltronics Process Instruments	
Product	SITRANS LR560 Profibus PA	
Model	7ML5440-xxx00-xBxx	
Standard(s)	IEC / EN 61326-1:2005 & IEC / EN 61326-2-5:2006	

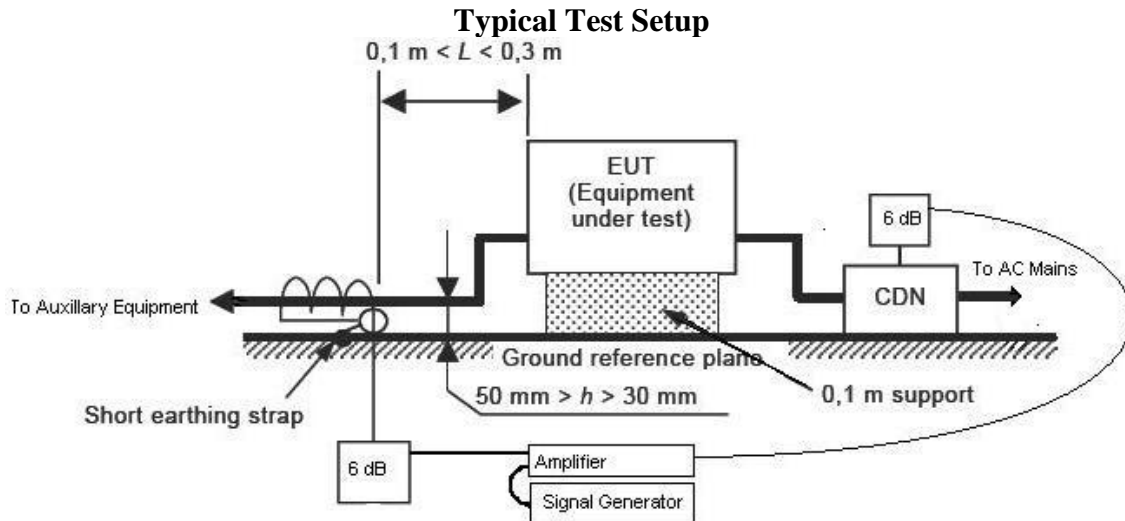

Application Level Accuracy

As per IEC 61000-4-6, the CDN must meet a common mode impedance $|Z_{CE}| = 150 \Omega \pm 20 \Omega$ for 150 kHz to 26 MHz and $|Z_{CE}| = 150 \Omega + 60 \Omega$ or $150 \Omega - 45 \Omega$ for 26 MHz \rightarrow 80 MHz. During tests using the bulk current injection probe, the impedance of each cable will affect the current injected, so current was monitored. The calibration performed according to IEC 61000-4-6 allows for +/- 2dB.

Test Results

The EUT passed the requirements. The EUT met Criteria A as defined in “Appendix A – Client Provided Details”. No anomalies were observed. The EUT operated within manufacturer tolerances.

Input Voltage and Frequency	24 Vdc
Frequency range and signal strength	10 kHz – 80 MHz – 10 Vrms (80% AM)
Sweep step	1% of fundamental.
Dwell time	3 s
EUT type	Table top

Note: The maximum measured distance variation allow is ± 25 mm and the status must be good with two (2) retries for the EUT to meet Criteria A.

Client	Siemens Canada – Siemens Milltronics Process Instruments	
Product	SITRANS LR560 Profibus PA	
Model	7ML5440-xxx00-xBxx	
Standard(s)	IEC / EN 61326-1:2005 & IEC / EN 61326-2-5:2006	

The following tables summarize the test results recorded:

Cable	I/O w/ GND 10 – 150 kHz		
	Digital distances (mm)		
	Initial	Variation	Results
Average	894.6		
Minimum	890.7	887.2	-7.4
Maximum	902.8	902.8	8.2
Criteria			A
Status			128.0000

Cable	I/O w/ GND 0.15 – 80 MHz		
	Digital distances (mm)		
	Initial	Variation	Results
Average	918.7		
Minimum	917.3	897.8	-20.8
Maximum	919.3	924.0	5.3
Criteria			A
Status			128.0000

Cable	I/O w/o GND 10 – 150 kHz		
	Digital distances (mm)		
	Initial	Variation	Results
Average	922.6		
Minimum	920.3	914.5	-8.1
Maximum	924.7	927.5	4.9
Criteria			A
Status			128.0000

Cable	I/O w/o GND 0.15 – 80 MHz		
	Digital distances (mm)		
	Initial	Variation	Results
Average	914.5		
Minimum	914.0	912.7	-1.9
Maximum	915.6	922.6	8.0
Criteria			A
Status			128.0000

Test Equipment List

Equipment	Model No.	Manufacturer	Last calibration date	Next calibration due date	Asset #
CDN	CDN-M3	Vican	Feb. 11, 2009	Feb. 11, 2011	GEMC 11
Power Amplifier	75A250A	AR	NCR	NCR	GEMC 14
RF Current probe	F-33-2	FCC	Feb. 11, 2009	Feb. 11, 2011	GEMC 19
Bulk Current Injection Probe	F-120-9A	FCC	Feb. 11, 2009	Feb. 11, 2011	GEMC 20
Signal Generator	SMT 03	Rhode and Schwarz	July 1, 2009	July 1, 2011	GEMC 2
Power Attenuator 6 dB	100-A-FFN-06	Bird	NCR	NCR	GEMC 48

This report module is based on GEMC report template 'IEC61000-4-6_ConductedImmunity_Rev1'

Client	Siemens Canada – Siemens Milltronics Process Instruments	
Product	SITRANS LR560 Profibus PA	
Model	7ML5440-xxx00-xBxx	
Standard(s)	IEC / EN 61326-1:2005 & IEC / EN 61326-2-5:2006	

Power Frequency Magnetic Field

Purpose

A magnetic field with a frequency of the power line is generated around the EUT. In practice, the EUT will be subjected to power frequency magnetic fields from nearby power lines, transformers, or devices such as televisions or monitors. Since the EUT is usually used in conjunction with other electrical equipment, it is subjected to the Steady State Magnetic Fields – these are magnetic fields that the device is exposed to under constant operating conditions. These fields have a lower field strength compared to typical Transient Magnetic fields.

Application Level Requirement

This test is performed in accordance with the methodology defined in IEC 61000-4-8. 3 orthogonal axes of the EUT are subjected to the field within the magnetic loop. Transient magnetic field level, if applicable, was tested for 1 minute. Steady state magnetic field level was tested for 3 minutes, or longer. The frequency applied was 50 and 60 Hz. A level of 100 A/m was applied to the EUT in each axis. Criteria level ‘A’ as defined in “Appendix A – Client Provided Details” was applied to this test.

Typical Setup Diagram

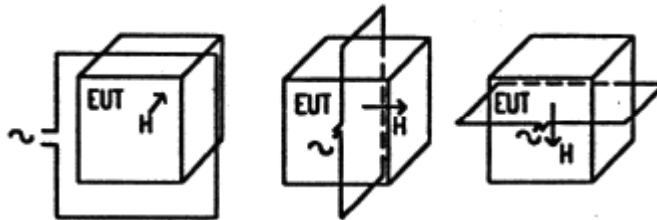

Application Level Accuracy

As per IEC61000-4-8, the field over the area the EUT occupies within the loop must be calibrated to be within +/- 3 dB. For field strength of 3 A/m, this means the empty calibrated field strength will be between 2.1 A/m and 4.2 A/m over the area the EUT occupies.

Test Results

The EUT passed the requirements. The EUT met Criteria A as defined in “Appendix A – Client Provided Details”. No anomalies were observed. The EUT operated within manufacturer specified tolerance.

Client	Siemens Canada – Siemens Milltronics Process Instruments	
Product	SITRANS LR560 Profibus PA	
Model	7ML5440-xxx00-xBxx	
Standard(s)	IEC / EN 61326-1:2005 & IEC / EN 61326-2-5:2006	

Note: The maximum measured distance variation allow is ± 25 mm and the status must be good with two (2) retries for the EUT to meet Criteria A.

The following tables summarize the test results recorded:

Side	F-B		
	Digital distances (mm)		
	Initial	Variation	Results
Average	917.9		
Minimum	917.6	915.1	-2.9
Maximum	920.4	920.4	2.5
Criteria			A
Status			128.0000

Side	L-R		
	Digital distances (mm)		
	Initial	Variation	Results
Average	921.4		
Minimum	920.8	918.8	-2.7
Maximum	921.9	922.6	1.2
Criteria			A
Status			128.0000

Side	T-B		
	Digital distances (mm)		
	Initial	Variation	Results
Average	929.4		
Minimum	927.7	927.7	-1.7
Maximum	933.4	940.7	11.3
Criteria			A
Status			128.0000

Test Equipment Used

Equipment	Model No.	Manufacturer	Last calibration date	Next calibration due date	Asset #
100 Turn Magnetic Loop	1mx1m	Global EMC	NCR	NCR	GEMC 136
Variac	PWRSTA 3PN126	Powerstat	NCR	NCR	GEMC 6032
milligauss meter	4180	F W Bell	NCR	NCR	GEMC 74

This report module is based on GEMC report template 'IEC61000-4-8_MagneticImmunity_Rev1'

Client	Siemens Canada – Siemens Milltronics Process Instruments	
Product	SITRANS LR560 Profibus PA	
Model	7ML5440-xxx00-xBxx	
Standard(s)	IEC / EN 61326-1:2005 & IEC / EN 61326-2-5:2006	

Appendix A – Client Provided Details

Client	Siemens Canada – Siemens Milltronics Process Instruments	
Product	SITRANS LR560 Profibus PA	
Model	7ML5440-xxx00-xBxx	
Standard(s)	IEC / EN 61326-1:2005 & IEC / EN 61326-2-5:2006	

General Information

Client Details	
Organization / Address	Siemens Canada – Siemens Milltronics Process Instruments 1954 Technology Drive Peterborough, ON K9J 6X7
Contact	Lee Rogers
Phone	1-705-740-7103
Email	lee.rogers@siemens.com
EUT (Equipment Under Test) Details	
EUT Name (for report title)	SITRANS LR560 Profibus PA
EUT Model / SN (if known)	Model: 7ML5440-xxx00-xBxx SN: B3P-181
EUT revision	Click here... N/A
Software version	1.00.00-32
Equipment category	Equipment intended for use in Industrial locations
EUT is powered using	24VDC current loop/2-wire shielded Profibus PA communication
Input voltage range(s) (V)	14-32 VDC
Frequency range(s) (Hz)	N/A
Rated input current (A)	22.6mA max
Nominal power consumption (W)	0.48W
Number of power supplies in EUT	1
Transmits RF energy? (describe)	Yes 78-79GHz
Basic EUT functionality description	SITRANS LR560 Profibus PA (EUT) is radar level measurement device. The product is used in industrial locations for level monitoring of liquids, solids and slurries in a “continuous monitored operation”. The EUT powered up by 24VDC current loop/2-wire Profibus PA Communication. It operated by transmitting

Client	Siemens Canada – Siemens Milltronics Process Instruments	
Product	SITRANS LR560 Profibus PA	
Model	7ML5440-xxx00-xBxx	
Standard(s)	IEC / EN 61326-1:2005 & IEC / EN 61326-2-5:2006	

	Interrupted Frequency Modulated Carrier Wave (FMCW) radar pulses at 78-79GHz from it's antenna and the same antenna will receive the reflection signals from the surface of the material. A receiver registers the reflection signals and links it with the simultaneously transmitted signals, the different between the received and transmitted frequency is then analyzed and calculated to determine the distance of material. This distance is used as a basic for display of material level; an external Profibus PA Communication of a PC may also be used to communicate this information.
High level block diagram of EUT (attachment)	See the below block diagram
Modes of operation	Measurement Mode: Device displays distance on display
Step by step instructions for setup and operation	Perform a master reset, then run the quickstart setup as follow: <ul style="list-style-type: none"> - Units=mm - Lo calibration point = 2000mm - Speed of Response = Fast - Operation: Distance
Customer to setup EUT on site?	Yes
EUT response time (ms)	1sec
EUT setup time (min)	15 minutes
Frequency of all clocks present in EUT	Oscillators' Frequencies: 2MHz, 100MHz, 125-145MHz, 25-29MHz, 1.5GHz, 1.625-1.645GHz and 13.0-13.1GHz CPU's Frequencies: 32.768KHz and 10MHz
I/O cable description Specify length and type	24VDC current loop/2-wire shielded Profibus PA communication
Available connectors on EUT	Terminal Block

Client	Siemens Canada – Siemens Milltronics Process Instruments	
Product	SITRANS LR560 Profibus PA	
Model	7ML5440-xxx00-xBxx	
Standard(s)	IEC / EN 61326-1:2005 & IEC / EN 61326-2-5:2006	

Peripherals required to exercise EUT Ex. Signal generator	<ol style="list-style-type: none"> 1. 6ES7 307-1EA00-0AA0 Siemens Power Supply, SN: Q6S1360706 2. 6ES7 315-2AG10-0AB0 Siemens PLC, SN: S1M22721 3. 6ES7 157-0AD81-0XA0 Siemens DP/PA Signal Coupler, SN: S1L01203 4. C794549-A1890-A10 Siemens Adaptor for CP5511/CP5512, SN: R1110032 5. C794549-A1890-A1 Siemens Profibus DP Card, SN: RO 100846 6. ThinkPad 2654-C3U IBM PC, SN: 78-FF158
Dimensions of product	L 100mm W 200mm H 190mm
Method of monitoring EUT and description of failure for immunity.	<p>During testing, the EUT was mounted with its antenna facing to a stationary target (the target distance is approximately 1m from the flange of the antenna), and the measured distance was continuously monitored.</p> <p>A PC with Profibus DP will log the measured distance and control status of the EUT via the PLC System to determine pass/fail criteria during testing. For immunity criteria A, a maximum variation allow for measured distance is $\pm 25\text{mm}$ and the automation control status must be good (Status byte = 128 – 255) with the retries limit = 2.</p>

Client	Siemens Canada – Siemens Milltronics Process Instruments	
Product	SITRANS LR560 Profibus PA	
Model	7ML5440-xxx00-xBxx	
Standard(s)	IEC / EN 61326-1:2005 & IEC / EN 61326-2-5:2006	

EUT Functional Description

EUT Configuration

Please see Appendix B for a picture of the unit running in normal conditions.

The following drawings show details of the EUT test setup for:

Radiated and Conducted Emission measurements and ESD, Radiated, EFT, Surge, Conducted and Magnetic Field Immunity.

Client	Siemens Canada – Siemens Milltronics Process Instruments	
Product	SITRANS LR560 Profibus PA	
Model	7ML5440-xxx00-xBxx	
Standard(s)	IEC / EN 61326-1:2005 & IEC / EN 61326-2-5:2006	

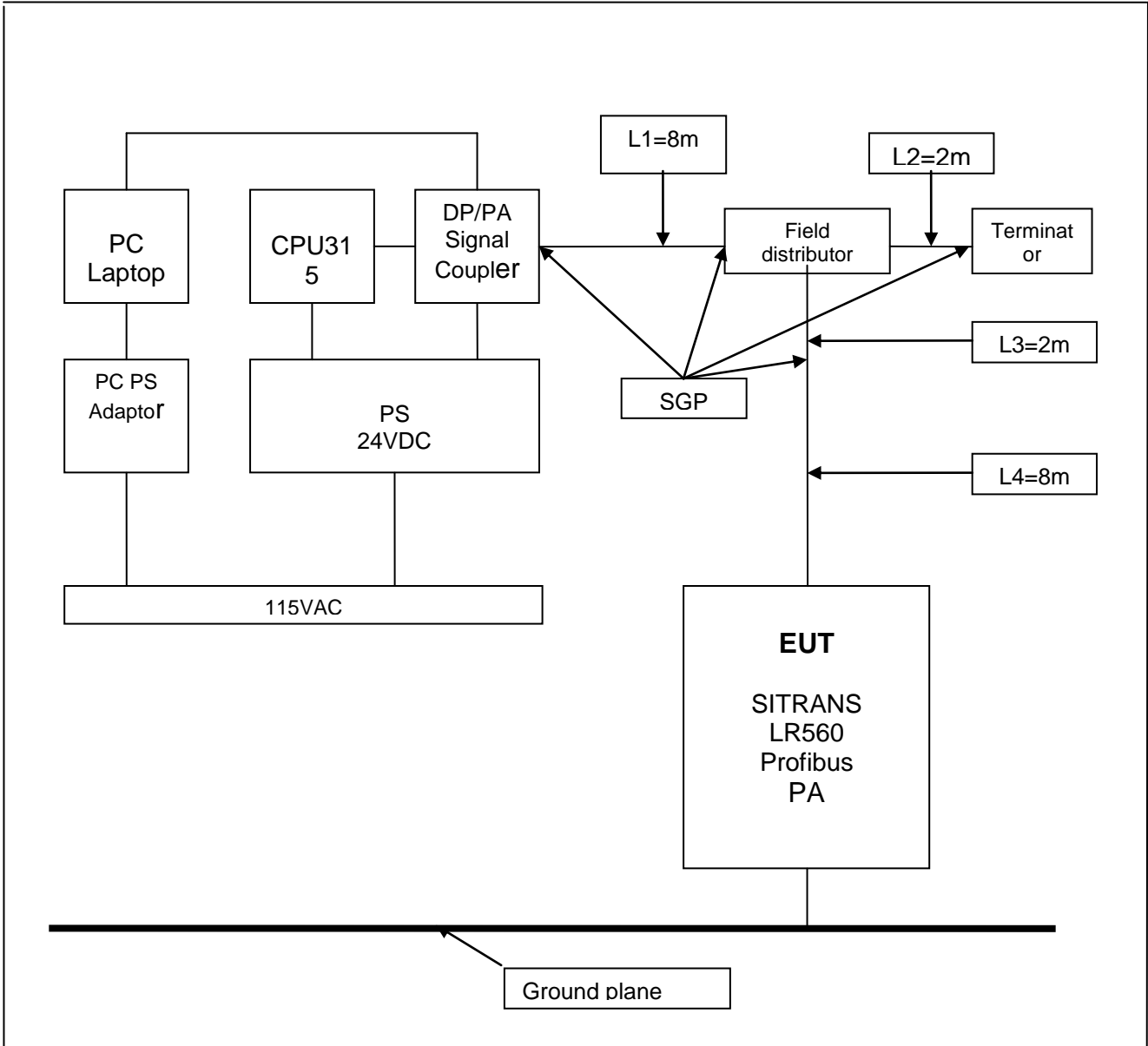

1. SGP: Shield Ground Point.
2. L1 – L4: Shielded Profibus Cable.

Operational Setup

These devices are required to be attached to the EUT for its normal operation.

Client	Siemens Canada – Siemens Milltronics Process Instruments	
Product	SITRANS LR560 Profibus PA	
Model	7ML5440-xxx00-xBxx	
Standard(s)	IEC / EN 61326-1:2005 & IEC / EN 61326-2-5:2006	

- See table above.

Modifications for Compliance

The following modifications were made during testing for the sample to achieve compliance with the testing requirements:

- None - the production sample provided met the requirements without need for modification

Criteria Description

Performance criterion A: During testing, normal performance as specified by the manufacturer.

Performance criterion B: During testing, temporary degradation, or loss of function or performance which is self-recovering.

Performance criterion C: During testing, temporary degradation, or loss of function or performance which requires operator intervention or system reset occurs

Client	Siemens Canada – Siemens Milltronics Process Instruments	
Product	SITRANS LR560 Profibus PA	
Model	7ML5440-xxx00-xBxx	
Standard(s)	IEC / EN 61326-1:2005 & IEC / EN 61326-2-5:2006	

Appendix B – EUT & Test Setup Photos

Client	Siemens Canada – Siemens Milltronics Process Instruments	
Product	SITRANS LR560 Profibus PA	
Model	7ML5440-xxx00-xBxx	
Standard(s)	IEC / EN 61326-1:2005 & IEC / EN 61326-2-5:2006	



Conducted Emission Setup – Photo 1

Client	Siemens Canada – Siemens Milltronics Process Instruments	
Product	SITRANS LR560 Profibus PA	
Model	7ML5440-xxx00-xBxx	
Standard(s)	IEC / EN 61326-1:2005 & IEC / EN 61326-2-5:2006	

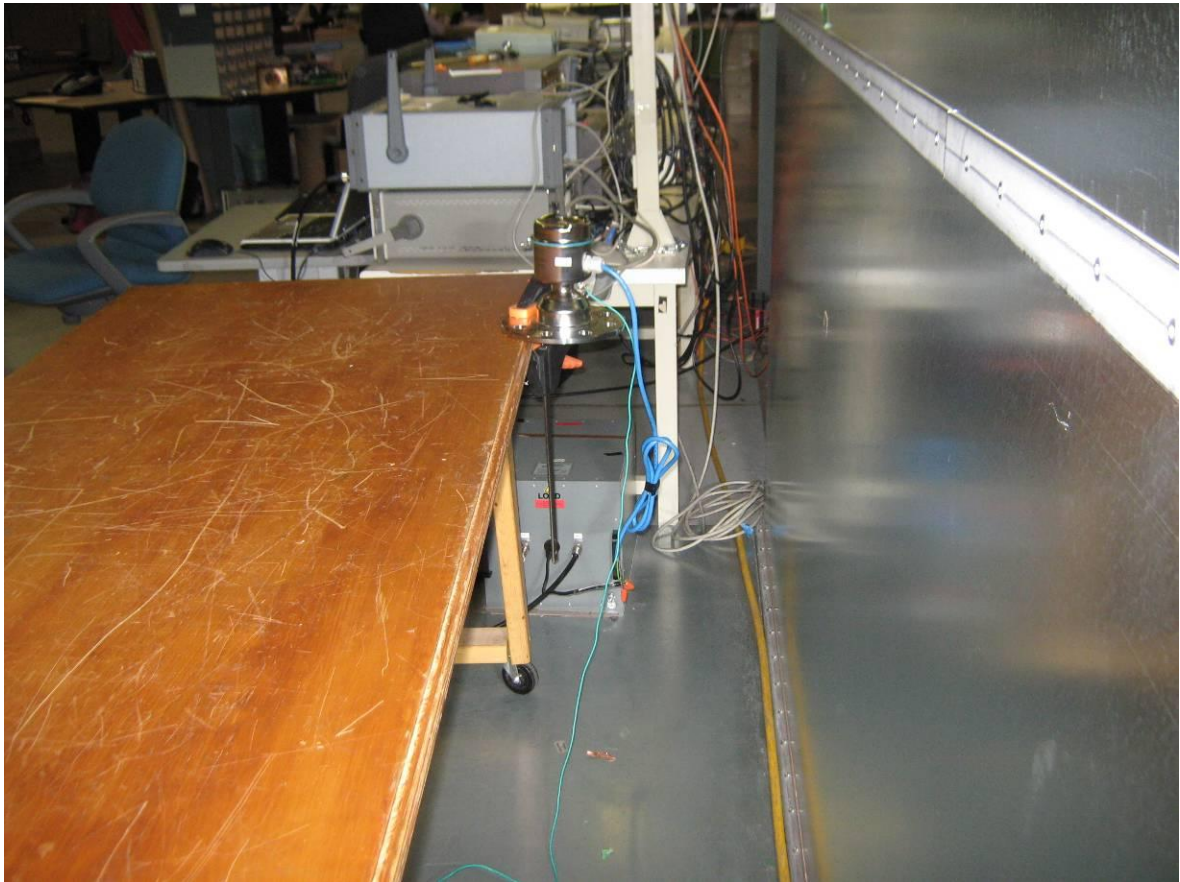

Conducted Emission Setup – Photo 2

Client	Siemens Canada – Siemens Milltronics Process Instruments	
Product	SITRANS LR560 Profibus PA	
Model	7ML5440-xxx00-xBxx	
Standard(s)	IEC / EN 61326-1:2005 & IEC / EN 61326-2-5:2006	

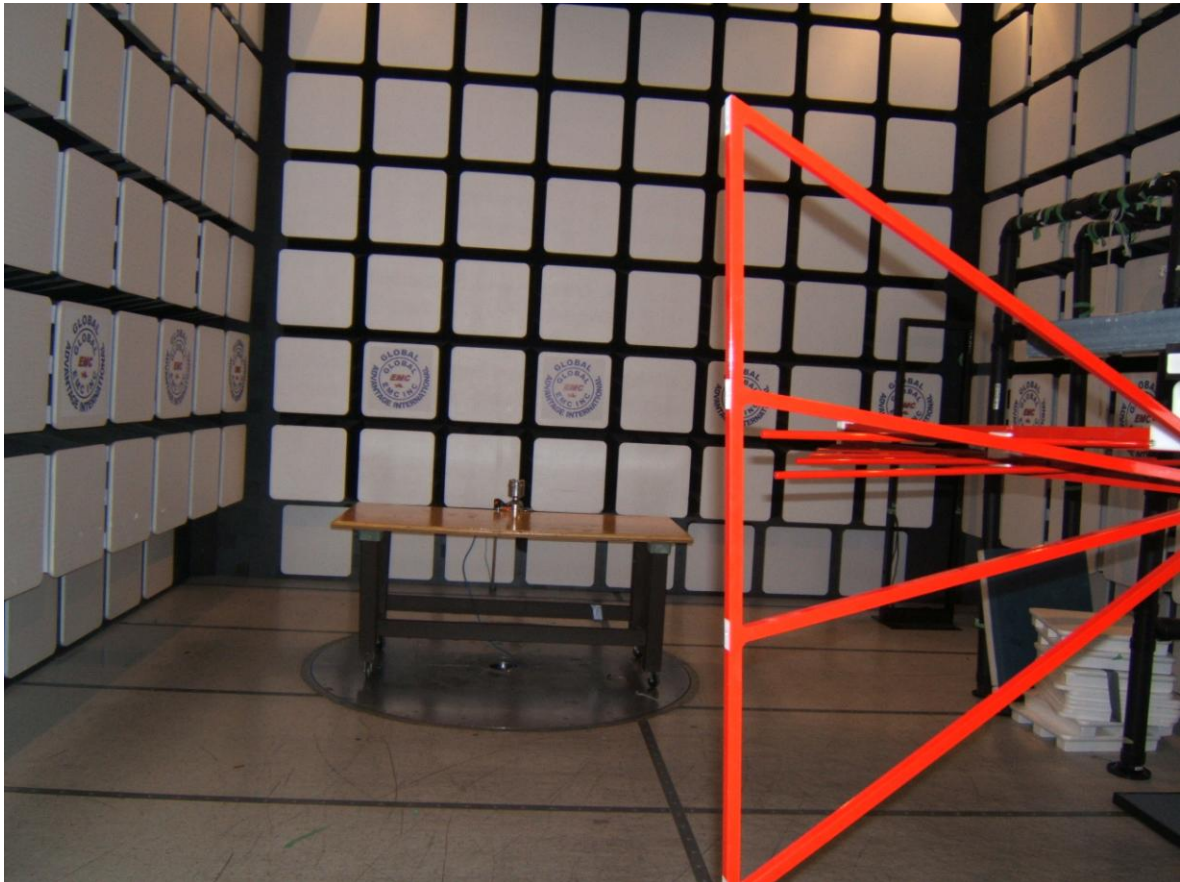

Radiated Emission Setup – Photo

Client	Siemens Canada – Siemens Milltronics Process Instruments	
Product	SITRANS LR560 Profibus PA	
Model	7ML5440-xxx00-xBxx	
Standard(s)	IEC / EN 61326-1:2005 & IEC / EN 61326-2-5:2006	

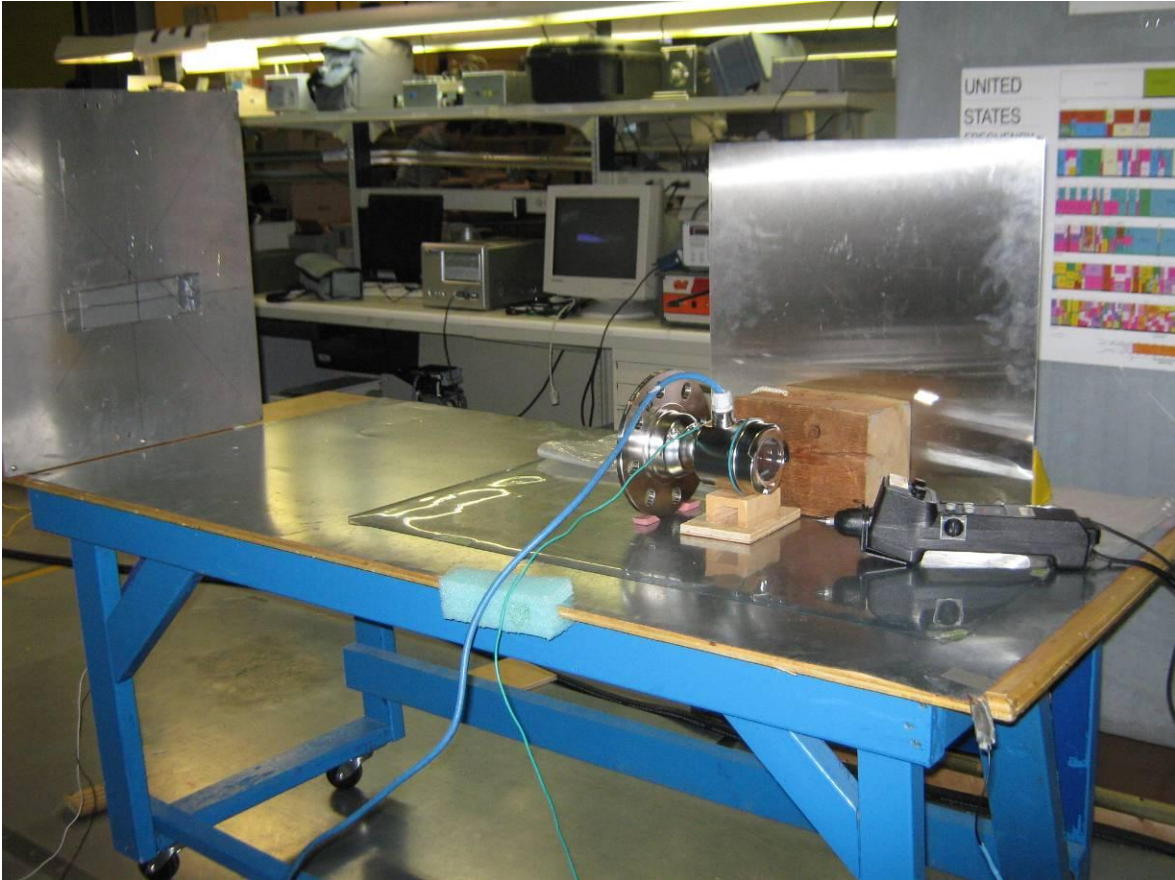

ESD Setup – Photo

Client	Siemens Canada – Siemens Milltronics Process Instruments	
Product	SITRANS LR560 Profibus PA	
Model	7ML5440-xxx00-xBxx	
Standard(s)	IEC / EN 61326-1:2005 & IEC / EN 61326-2-5:2006	



Radiated Immunity Setup – Photo 1

Client	Siemens Canada – Siemens Milltronics Process Instruments	
Product	SITRANS LR560 Profibus PA	
Model	7ML5440-xxx00-xBxx	
Standard(s)	IEC / EN 61326-1:2005 & IEC / EN 61326-2-5:2006	

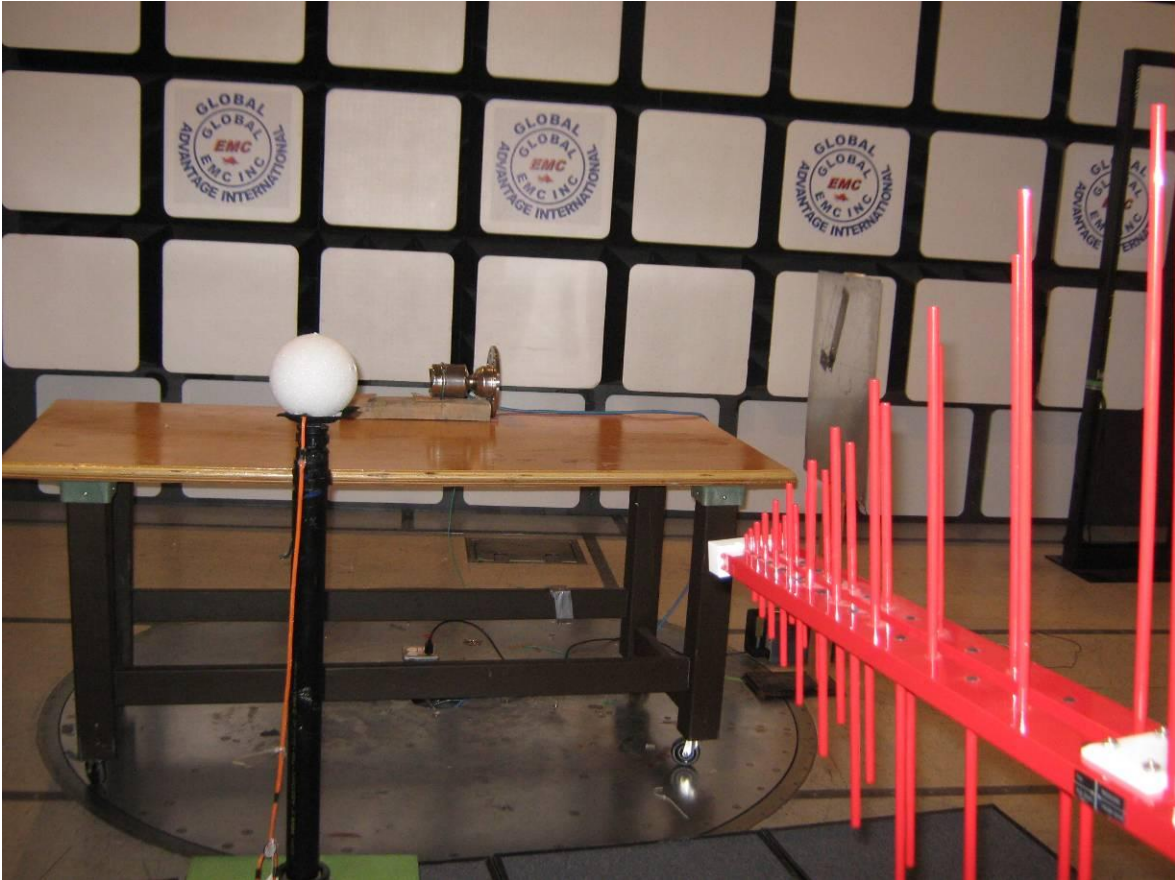

Radiated Immunity Setup – Photo 2

Client	Siemens Canada – Siemens Milltronics Process Instruments	
Product	SITRANS LR560 Profibus PA	
Model	7ML5440-xxx00-xBxx	
Standard(s)	IEC / EN 61326-1:2005 & IEC / EN 61326-2-5:2006	



Radiated Immunity Setup – Photo 3

Client	Siemens Canada – Siemens Milltronics Process Instruments	
Product	SITRANS LR560 Profibus PA	
Model	7ML5440-xxx00-xBxx	
Standard(s)	IEC / EN 61326-1:2005 & IEC / EN 61326-2-5:2006	



Electronic Fast Transient / Burst – Photo 1

Client	Siemens Canada – Siemens Milltronics Process Instruments	
Product	SITRANS LR560 Profibus PA	
Model	7ML5440-xxx00-xBxx	
Standard(s)	IEC / EN 61326-1:2005 & IEC / EN 61326-2-5:2006	



Electronic Fast Transient / Burst – Photo 2

Client	Siemens Canada – Siemens Milltronics Process Instruments	
Product	SITRANS LR560 Profibus PA	
Model	7ML5440-xxx00-xBxx	
Standard(s)	IEC / EN 61326-1:2005 & IEC / EN 61326-2-5:2006	



Surge Setup – Photo

Client	Siemens Canada – Siemens Milltronics Process Instruments	
Product	SITRANS LR560 Profibus PA	
Model	7ML5440-xxx00-xBxx	
Standard(s)	IEC / EN 61326-1:2005 & IEC / EN 61326-2-5:2006	

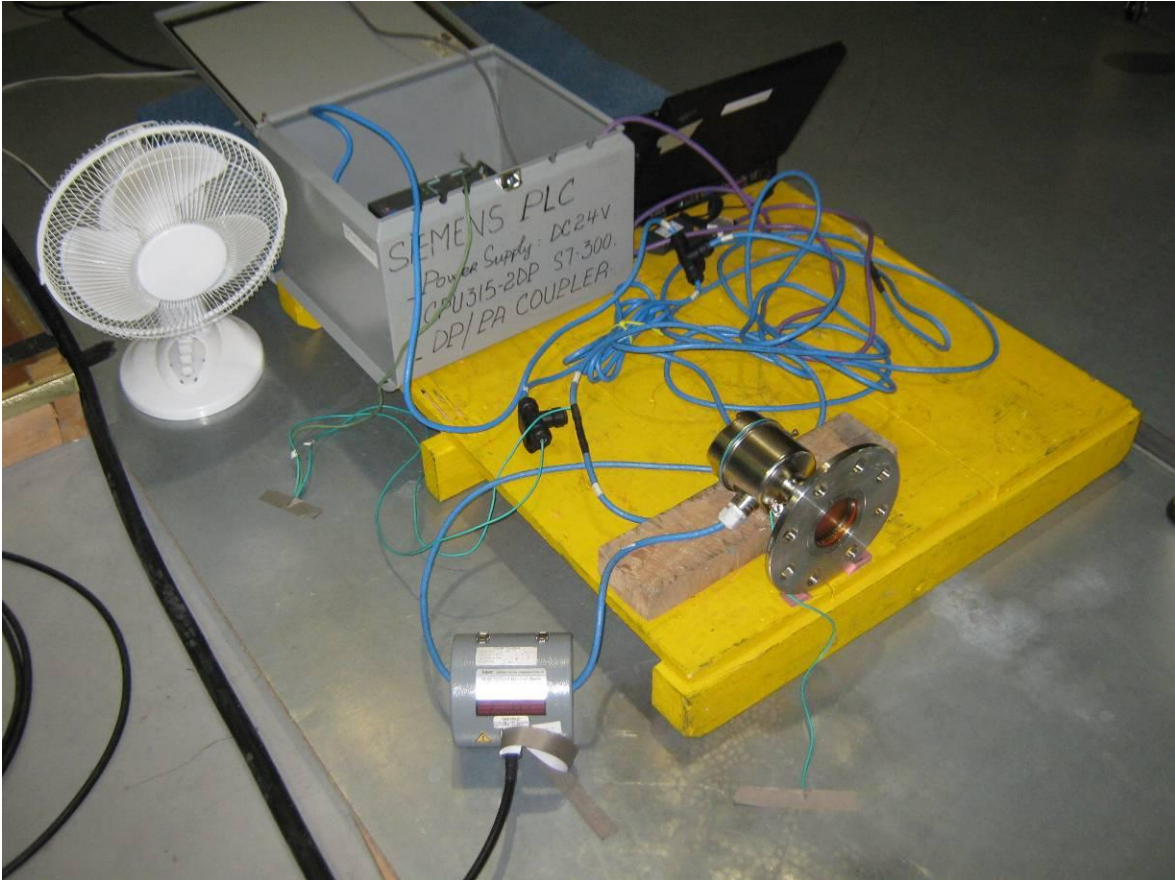

Conducted Immunity Setup – Photo

Client	Siemens Canada – Siemens Milltronics Process Instruments	
Product	SITRANS LR560 Profibus PA	
Model	7ML5440-xxx00-xBxx	
Standard(s)	IEC / EN 61326-1:2005 & IEC / EN 61326-2-5:2006	



Power Frequency Magnetic Immunity Setup - Photo