

The background image is a composite of a city skyline at night, a train on an elevated track, and digital data overlays. The city skyline features numerous skyscrapers with lights. The train is a modern, multi-carriage model moving along a curved track. Digital overlays include glowing blue lines, a grid of binary code (0s and 1s), and a semi-transparent data dashboard in the upper right corner with various charts and graphs.

SIEMENS

Ingenuity for life

Test Report

Test of 4 antennas for Level Probing Radar

Mihai-Gabriel Serban, PD PA PI R&D PBH HW

Gerhard Metz, Dominik Müller MO TI SPA RFS

Agreement

4 Antennas to be characterized:

1. Aluminum horn antenna – without process connection
It is a conical horn antenna with 3in aperture and it is the base configuration for all other antenna configurations. It will be used with LR250 and LR260.
2. Aluminum horn antenna flanged version – flanged horn
Configuration obtained by attaching at the aperture of the base horn a polypropylene lens and a dielectric flange. It will be used with LR250 and LR260
3. Aluminum horn antenna threaded version – aimer flanged horn
Configuration obtained by attaching at the aperture of the base horn an adapter ring that can be threaded in easy aimer flanges of different sizes. It will be used with LR260.
4. Aluminum horn antenna threaded version with lens.
Configuration obtained by attaching at the aperture of the base horn a polypropylene lens and an adapter ring that can be threaded in flanges of different sizes. It may be used with LR250 and LR260.

Measurements:

- * Antenna beam pattern: normalized radiation pattern for E-and H-planes at 25 GHz:
 - Azimuth cut at angle: 0° , 45° , and 90°
 - Elevation range: -180° to $+180^\circ$ in 1° steps
- * Measurement of -3dB beam width at E-and H-planes at 25 GHz

Deliverables:

Test report (powerpoint slides) that include:

- measurement results as graphs
- statement that the antenna meets/does not meet requirements FCC 15.256 (j), (i) and ETSI EN 302 729 V2.1.1 (2016-12) 4.6
- diagram and photos of measurement setup
- list of instruments, chamber certification data and measurement error evaluation
- measurement data as .mat-files for each antenna

Date of measurements

2018-01-17 – 2018-01-21

Location

Siemens Mobility GmbH, Otto-Hahn-Ring 6, Munich

Building/Room

31.250



antennas under test



A transition is attached to each antenna.

Relevant Standards



FCC 15.256 → (j) and (i)

(j) *Antenna side lobe gain.* LPR devices operating under the provisions of this section must limit the side lobe antenna gain relative to the main beam gain for off-axis angles from the main beam of greater than 60 degrees to the levels provided in Table 2.

(i) *Antenna beamwidth.* (A) LPR devices operating under the provisions of this section within the 5.925–7.250 GHz and 24.05–29.00 GHz bands must use an antenna with a –3 dB beamwidth no greater than 12 degrees.

TABLE 2—ANTENNA SIDE LOBE GAIN LIMITS

Frequency range (GHz)	Antenna side lobe gain limit relative to main beam gain (dB)
5.925–7.250	– 22
24.05–29.00	– 27
75–85	– 38

ETSI EN 302 729 V2.1.1 (2016-12) → 4.6

Table 11: Maximum antenna beamwidth and side lobe suppression [i.8]

Assigned frequency band	Maximum antenna beamwidth, in degree (°)	Antenna side lobe suppression relative to the main beam gain in elevation angles above 60 degrees (dB)
6 GHz to 8,5 GHz	12	-22
24,05 GHz to 26,5 GHz	12	-27
57 GHz to 64 GHz	8	-39
75 GHz to 85 GHz	8	-38

NOTE: The side lobe suppression limits are equal to what is specified by FCC [i.14]. Those values are assumed to be equivalent to a maximum antenna gain of -10 dBi above 60 degrees according to ECC/DEC/(11)02 [i.20].

Configuration, Phase Center, vertical Rotation axis

The configurations to be tested are:

- 1) Aluminum horn antenna- without process connection
- 2) Aluminum horn antenna flanged – flanged horn
- 3) Aluminum horn antenna threaded – aimer flanged horn
- 4) Aluminum horn antenna threaded version with lens – aimer flanged horn with lens



phase center (for all configurations)

DUT at Azimuth $\theta = 0^\circ$ and Elevation $\varphi = 0^\circ$

DUT #1

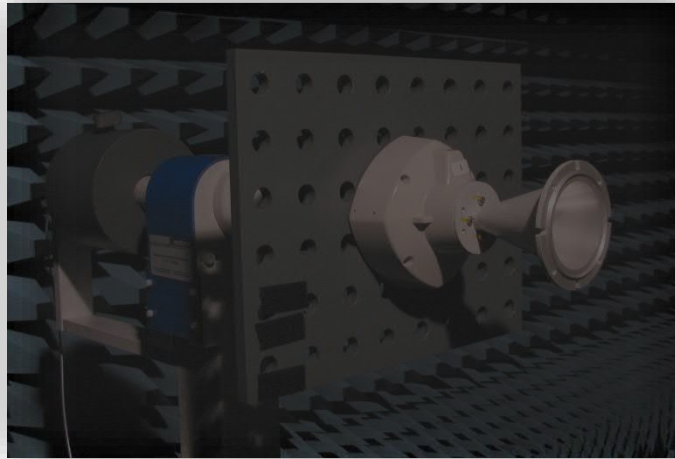

DUT #2

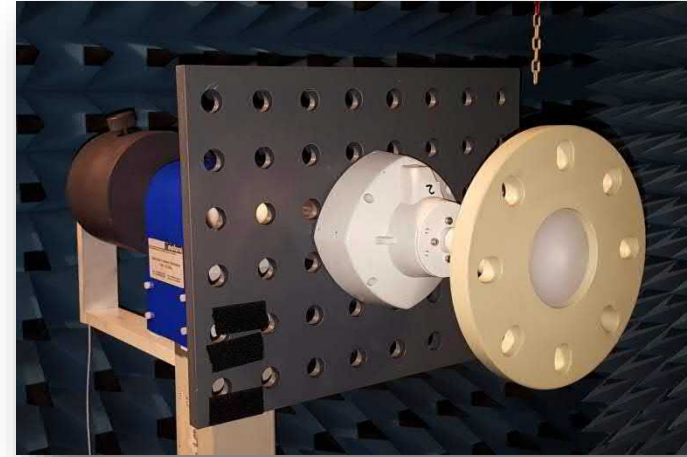

DUT #3

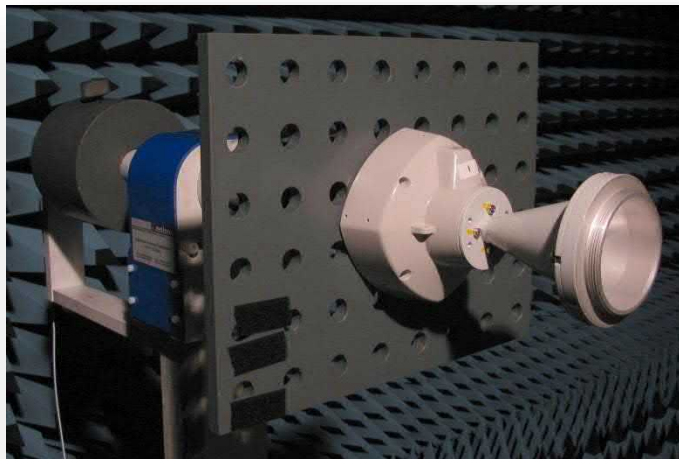

DUT #4

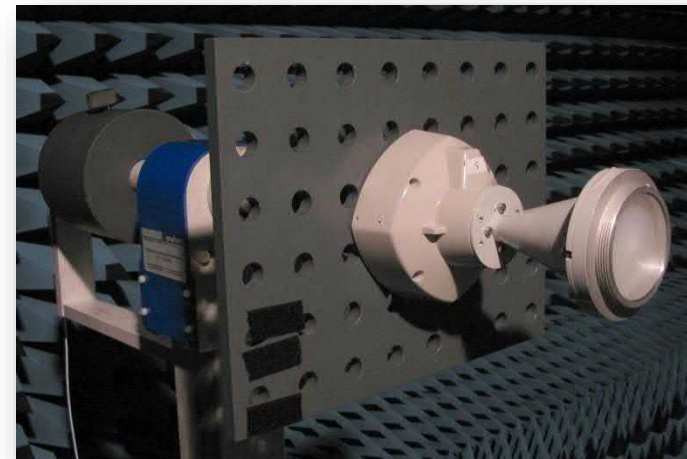

Measurement Setup

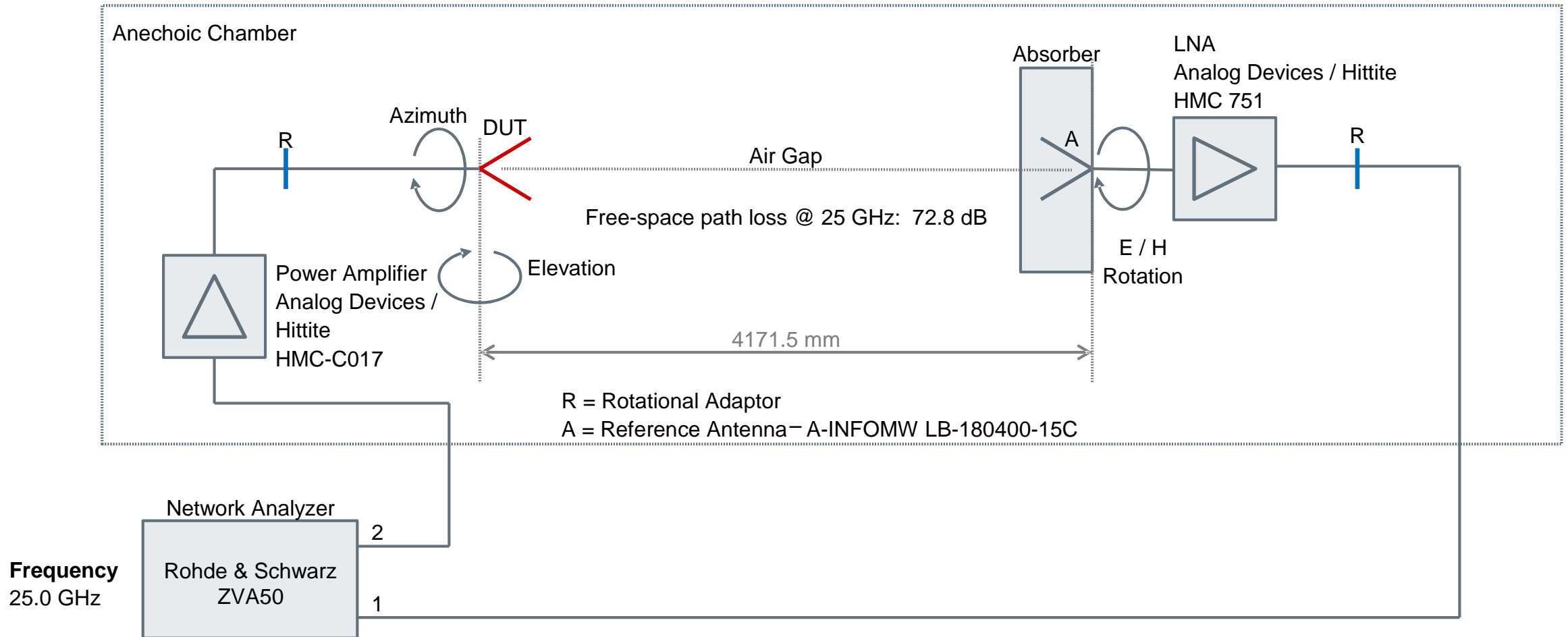

Anechoic Chamber

SIEMENS
Ingenuity for life

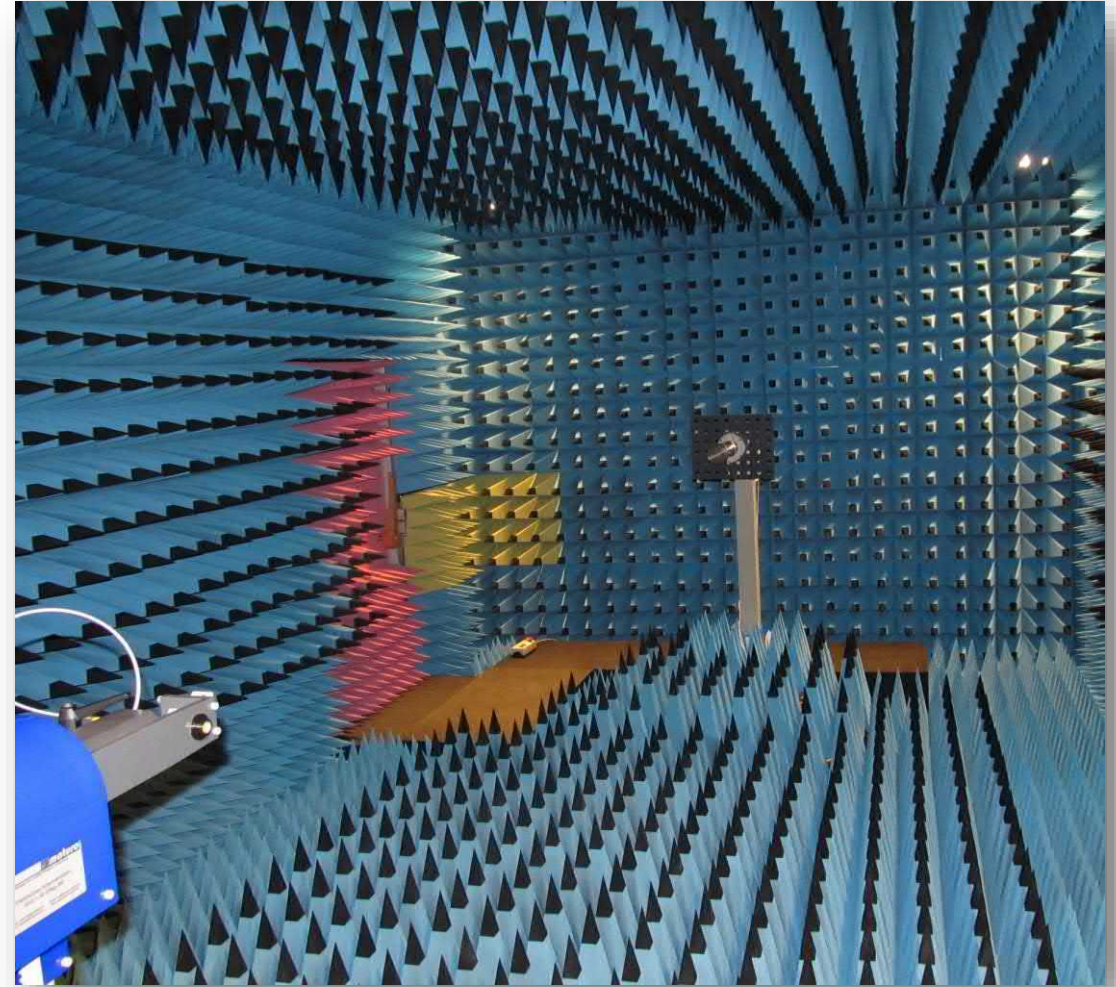
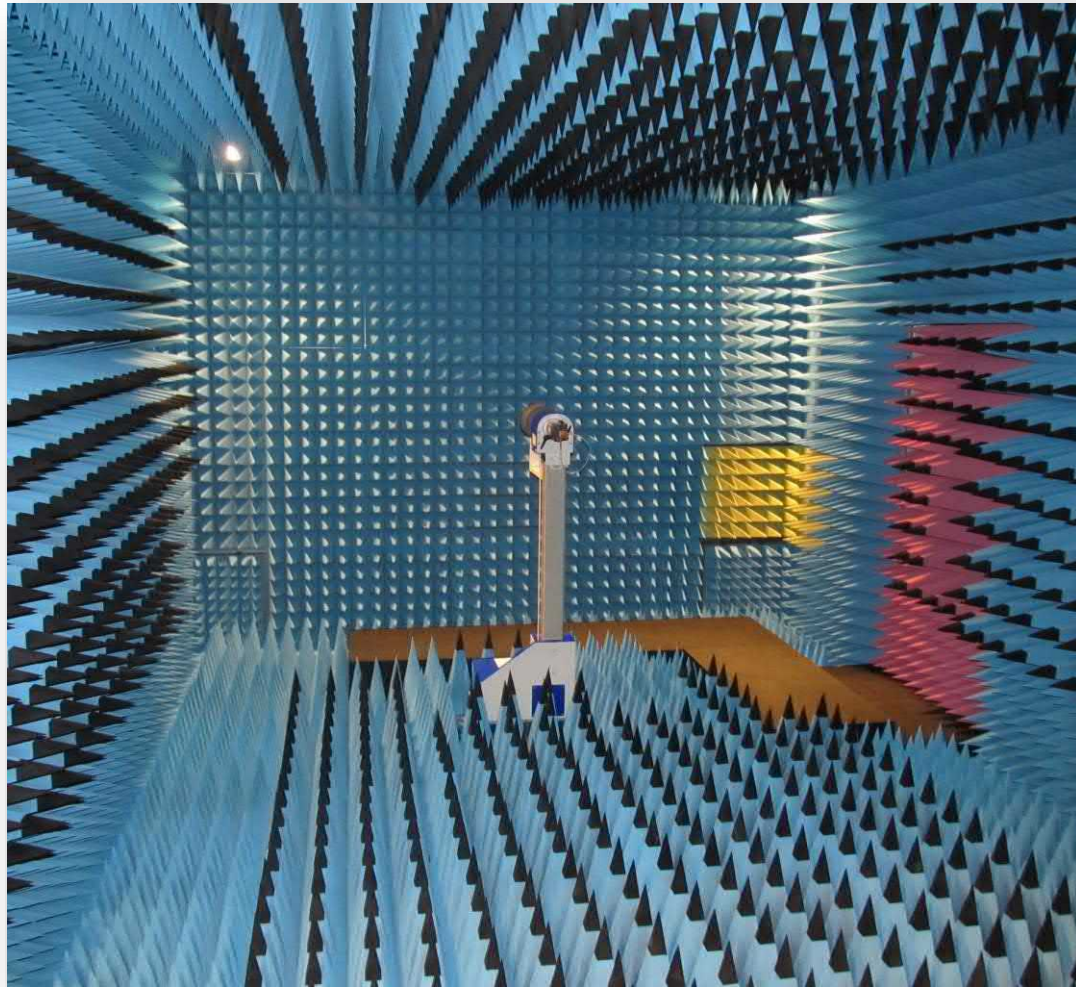

Antenna Alignment

TX Front-end with DUT

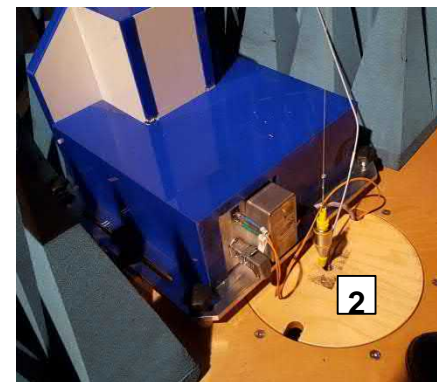
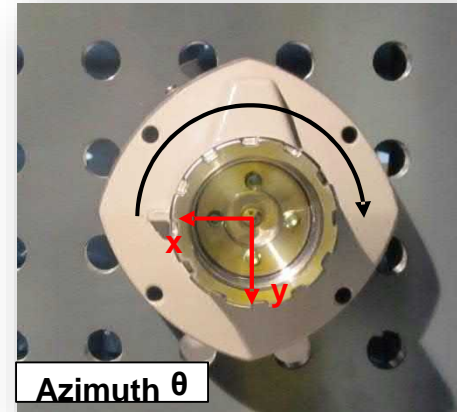
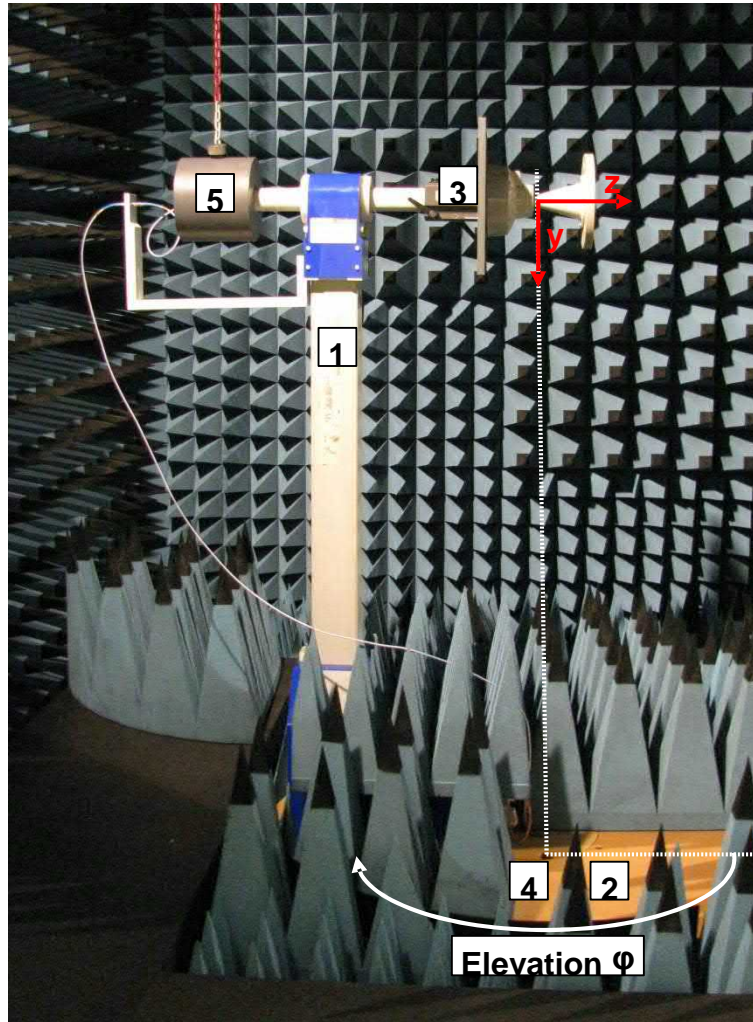

RX Front-end

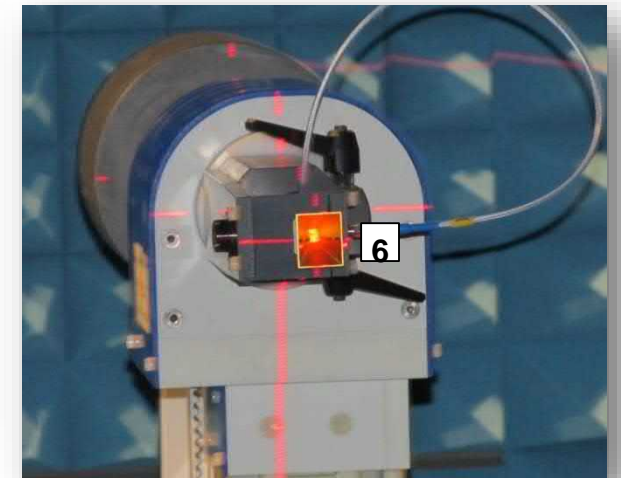

- 1) 360 deg positioner
- 2) 360 deg turn table
- 3) Mounting unit for DUT/laser
- 4) Center of elevation turn table
- 5) Counter weight
- 6) Cross laser for horizontal alignment
- 7) Plumb for phase center alignment

DUT and Reference Antenna

TX Front-end with DUT

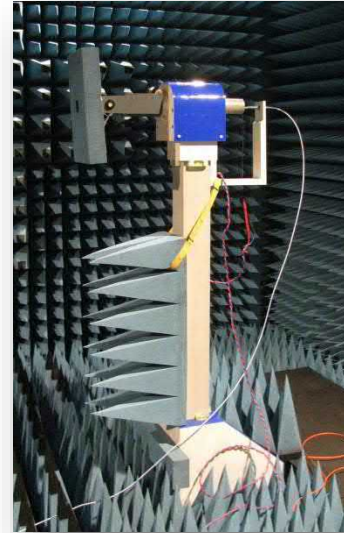
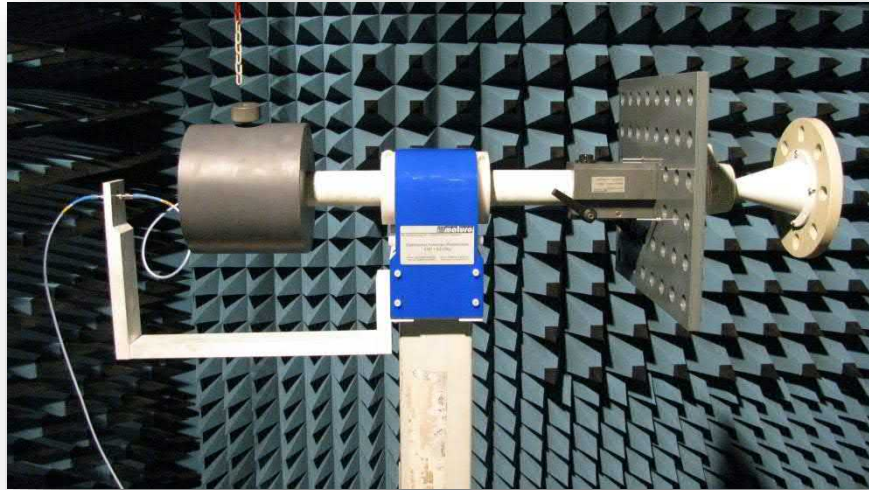

LNA

RX Front-end

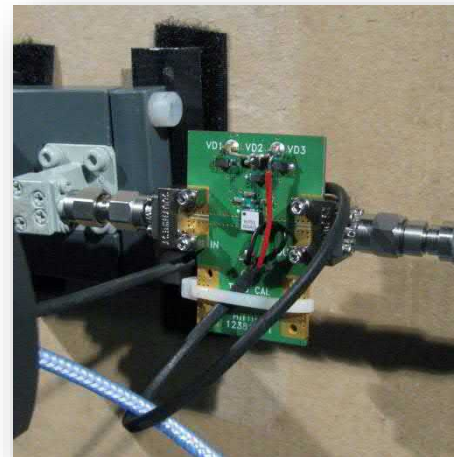
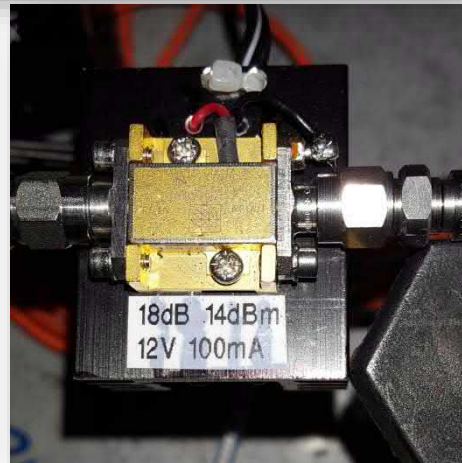

H-Plane

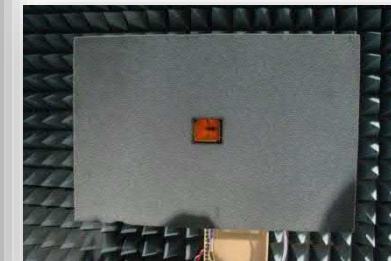

E-Plane

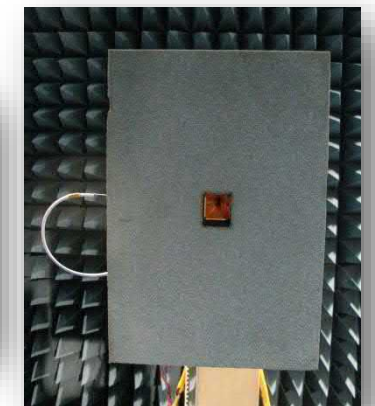

Measurement: Config #1 – H-Plane

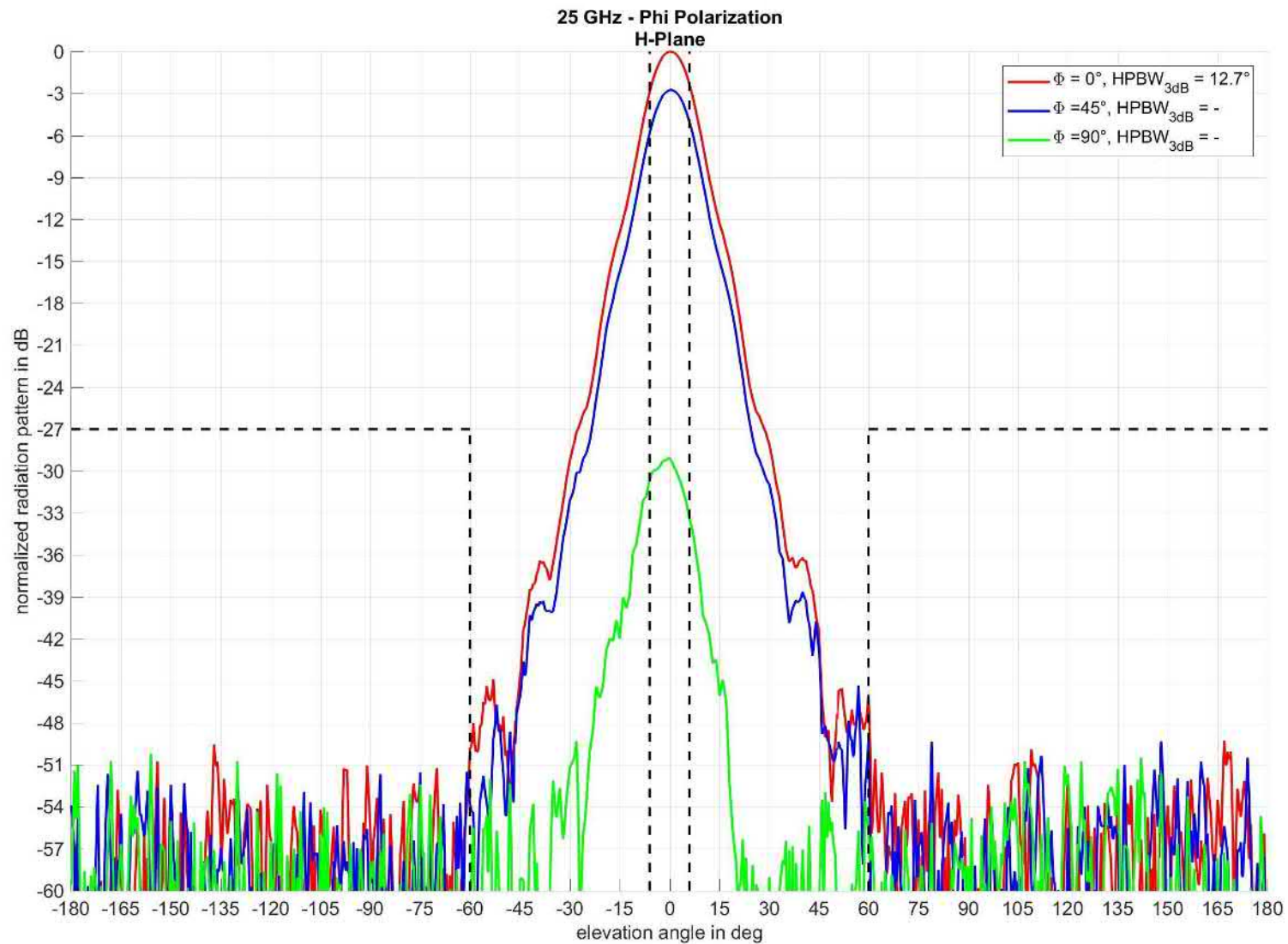

Measurement: Config #1 – H-Plane zoom

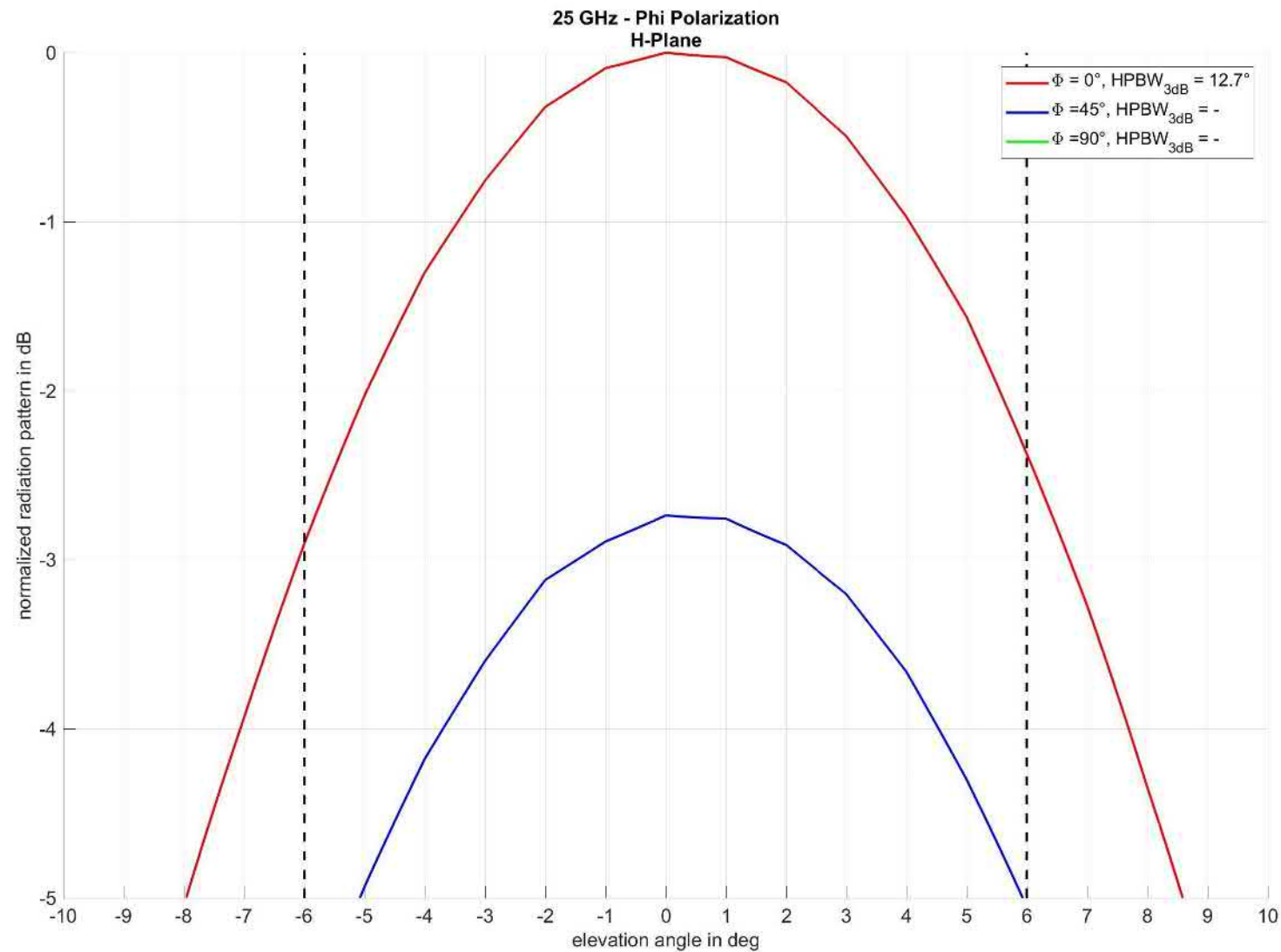

Measurement: Config #1 – E-Plane

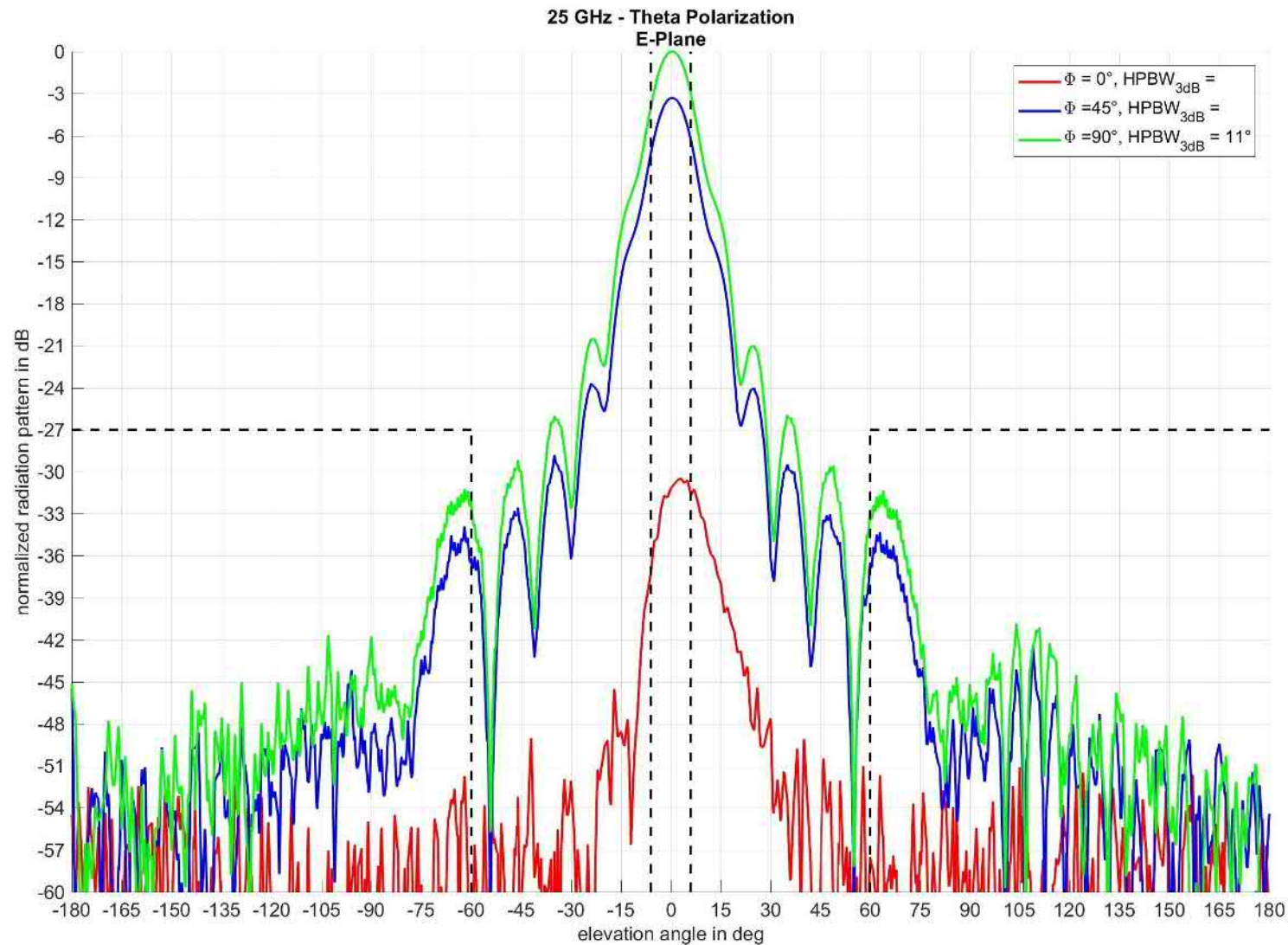

Measurement: Config #1 – E-Plane zoom

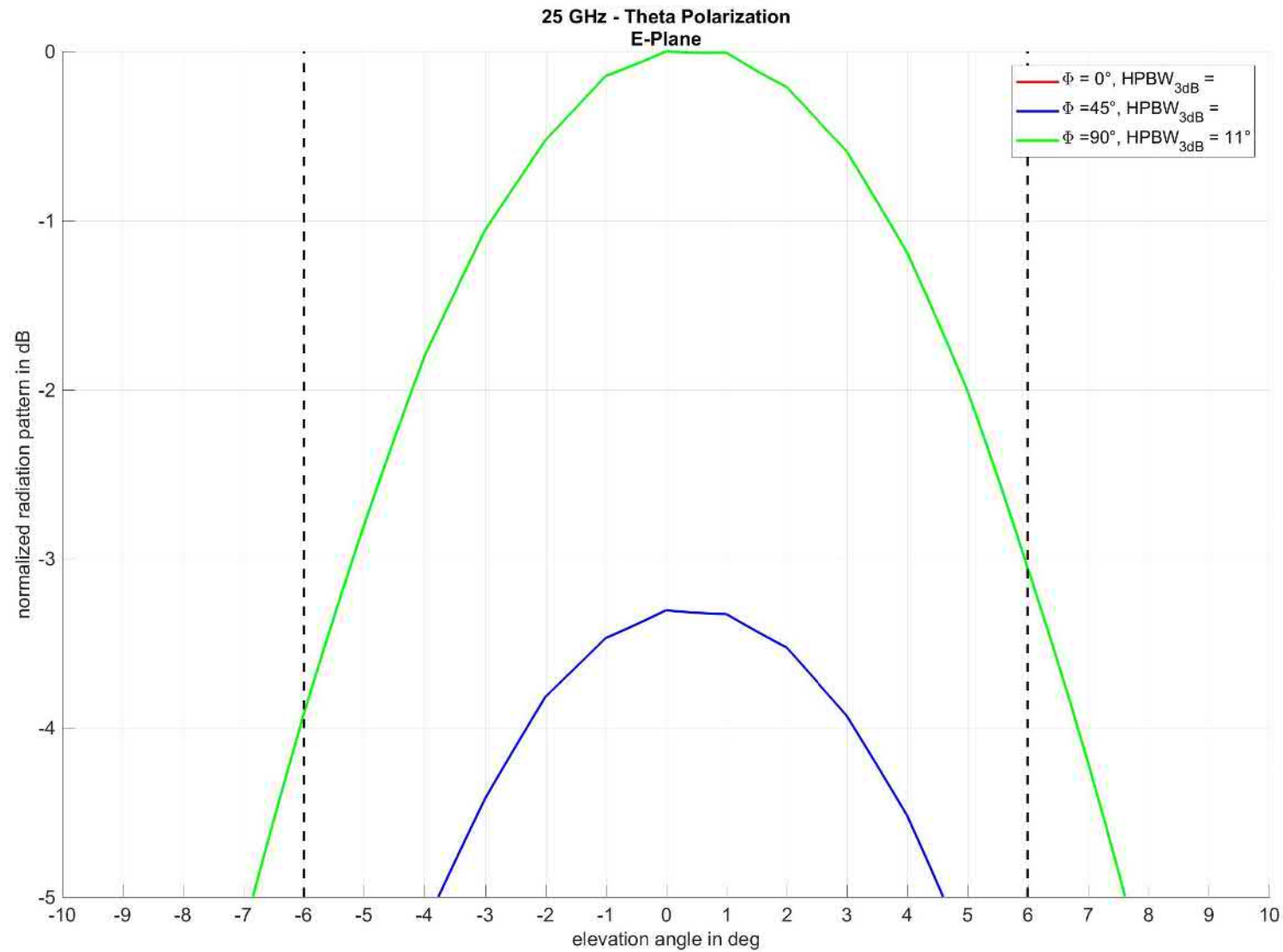

Measurement: Config #2- H-Plane

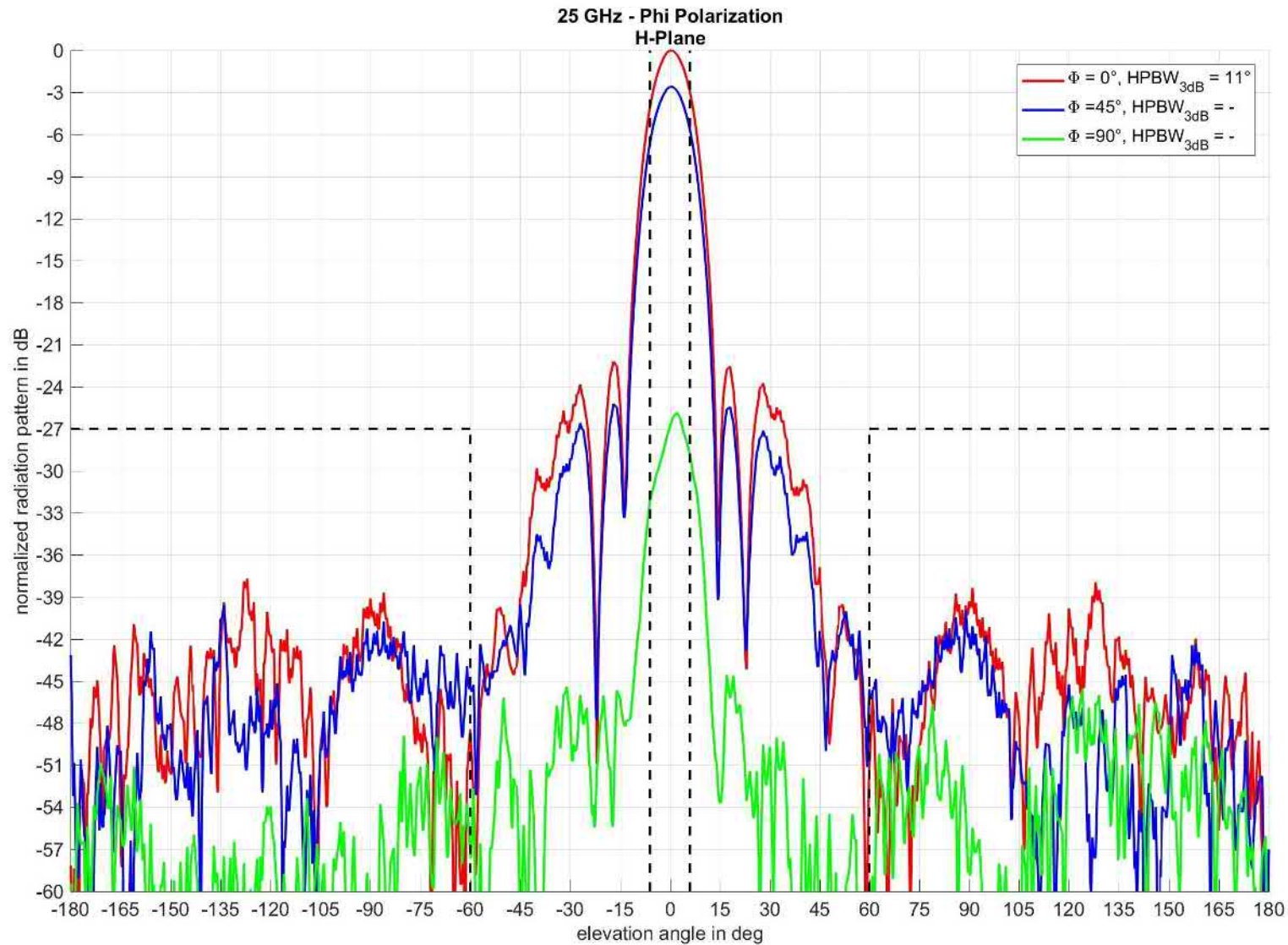

Measurement: Config #2- H-Plane zoom

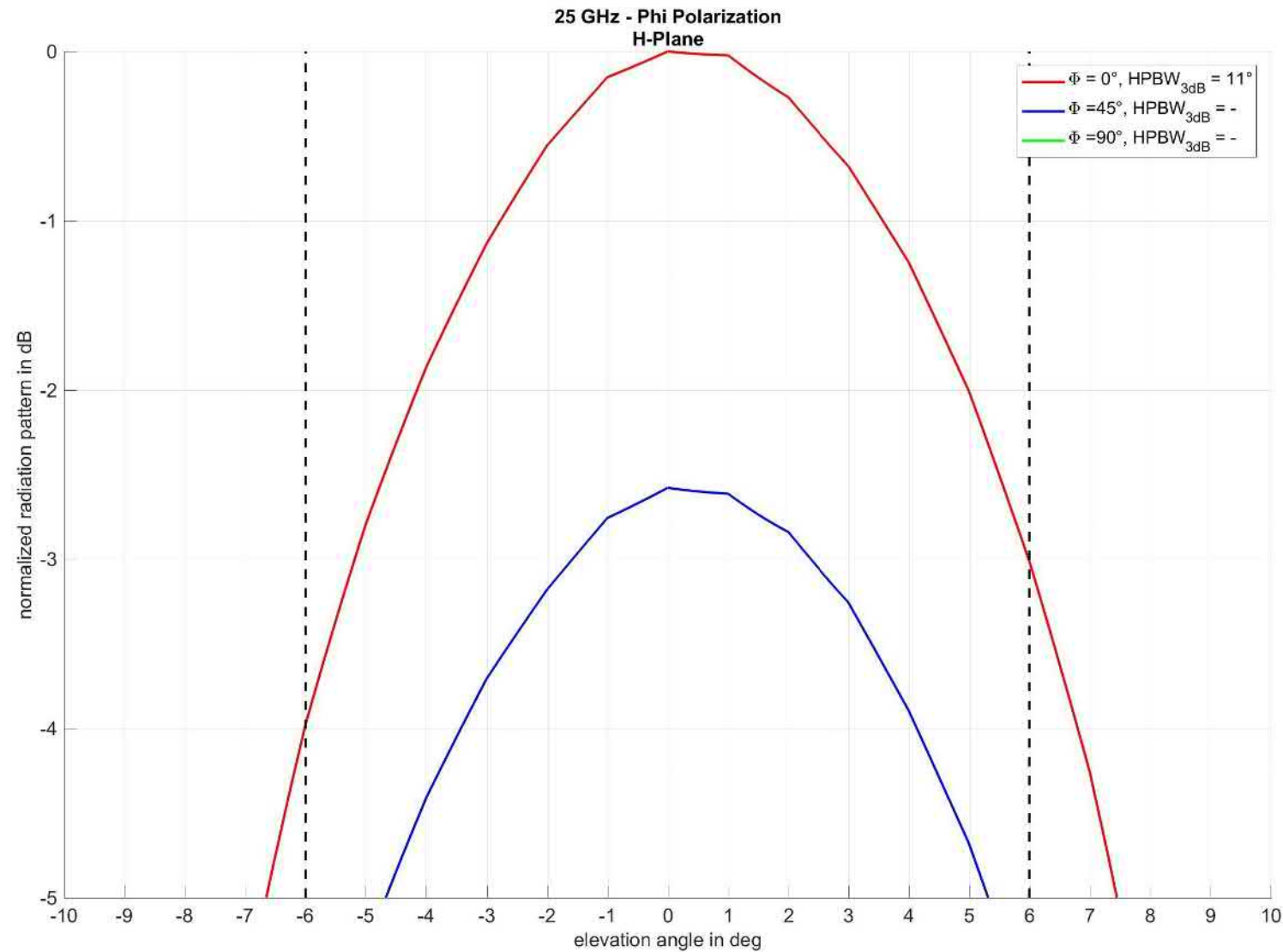

Measurement: Config #2– E-Plane

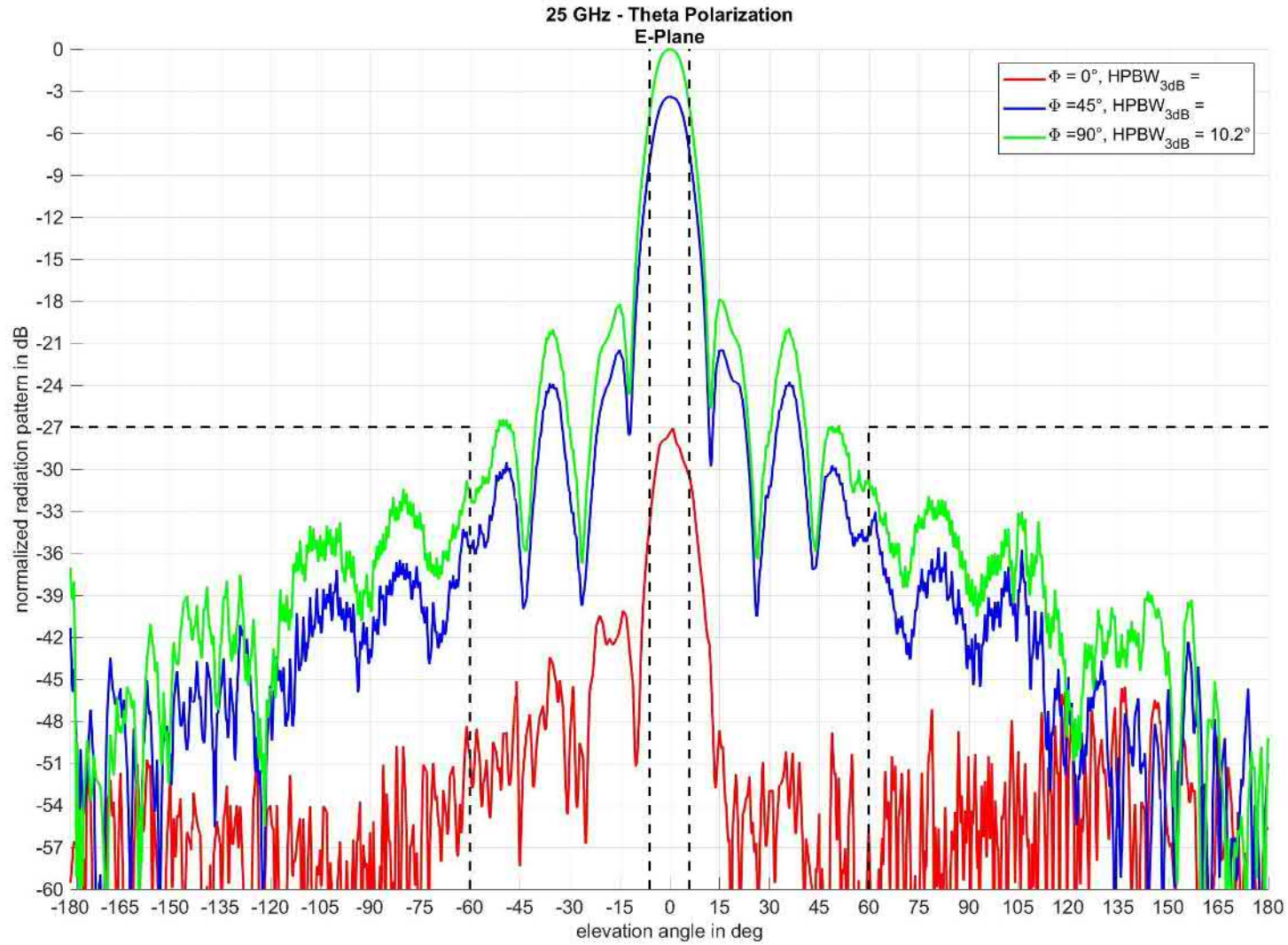

Measurement: Config #2– E-Plane zoom

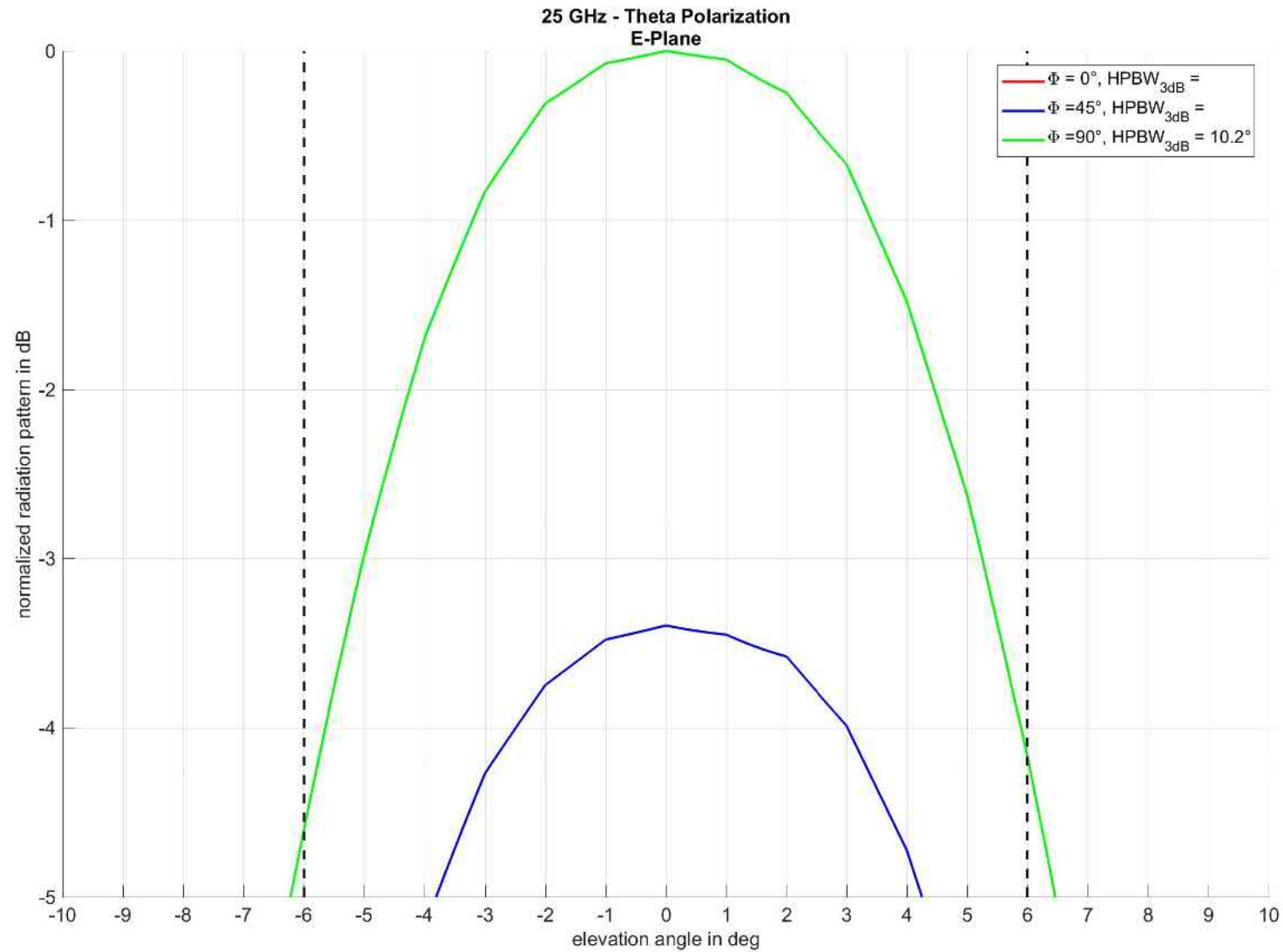

Measurement: Config #3– H-Plane

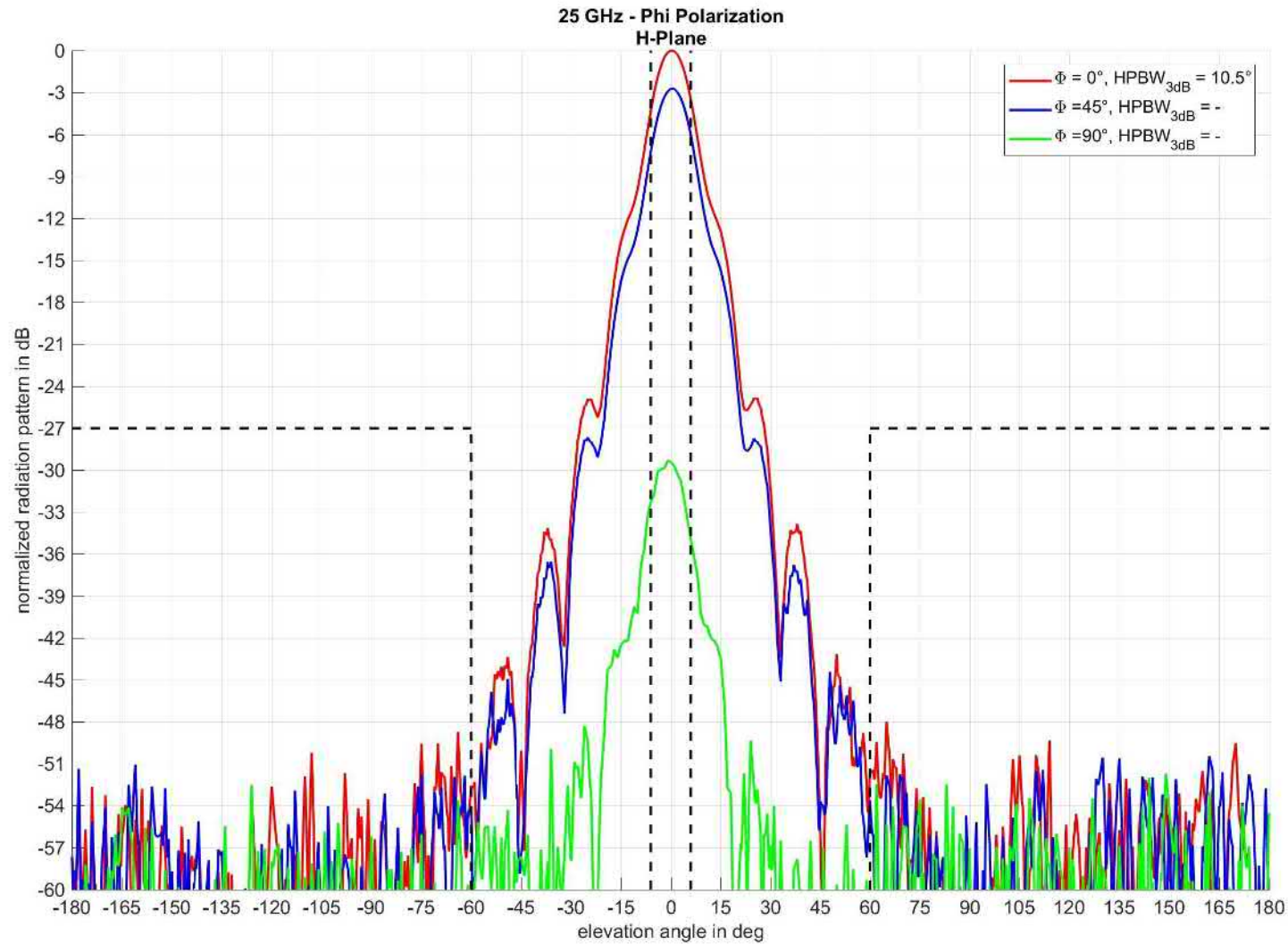

Measurement: Config #3– H-Plane zoom

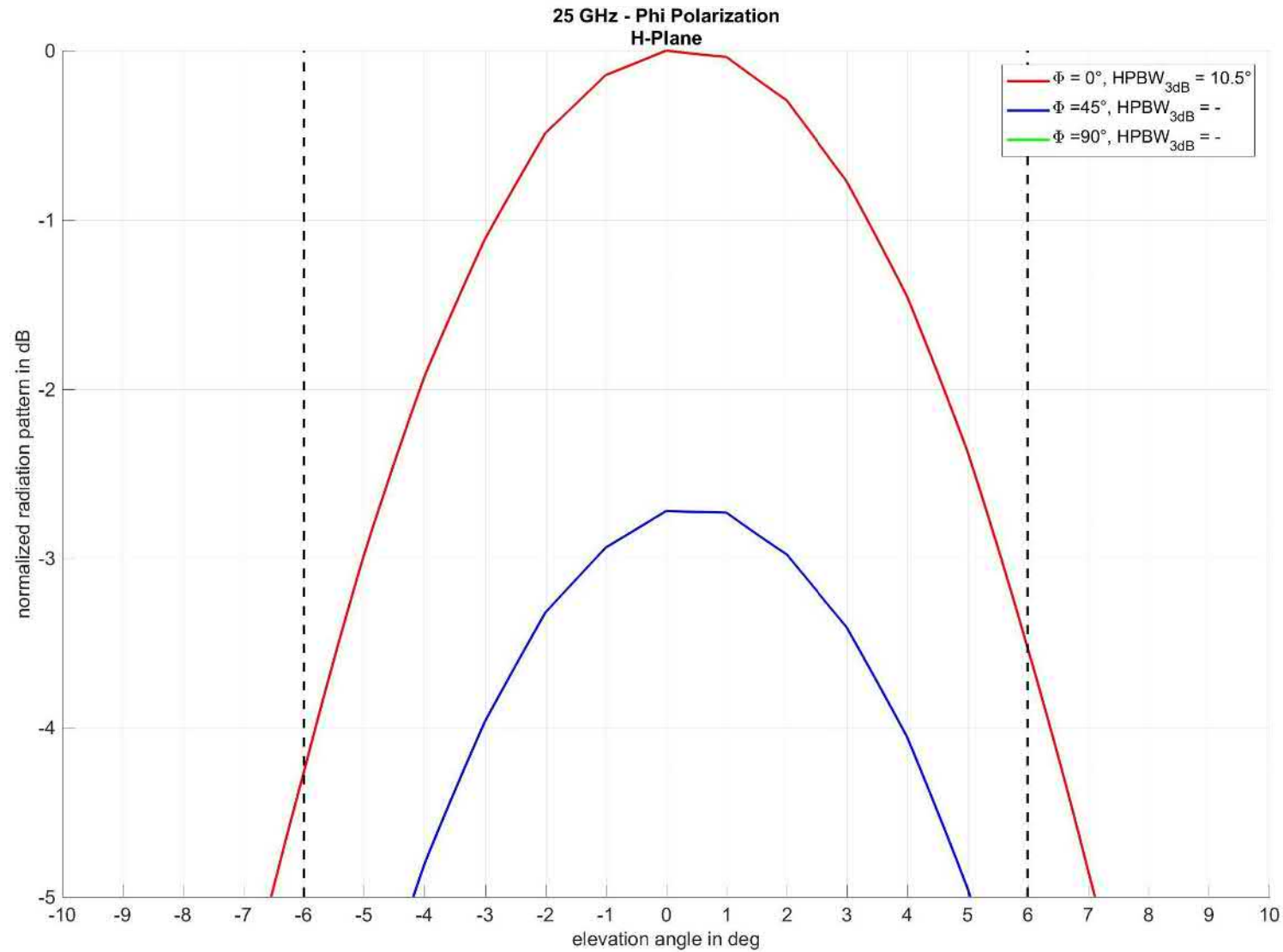

Measurement: Config #3– E-Plane

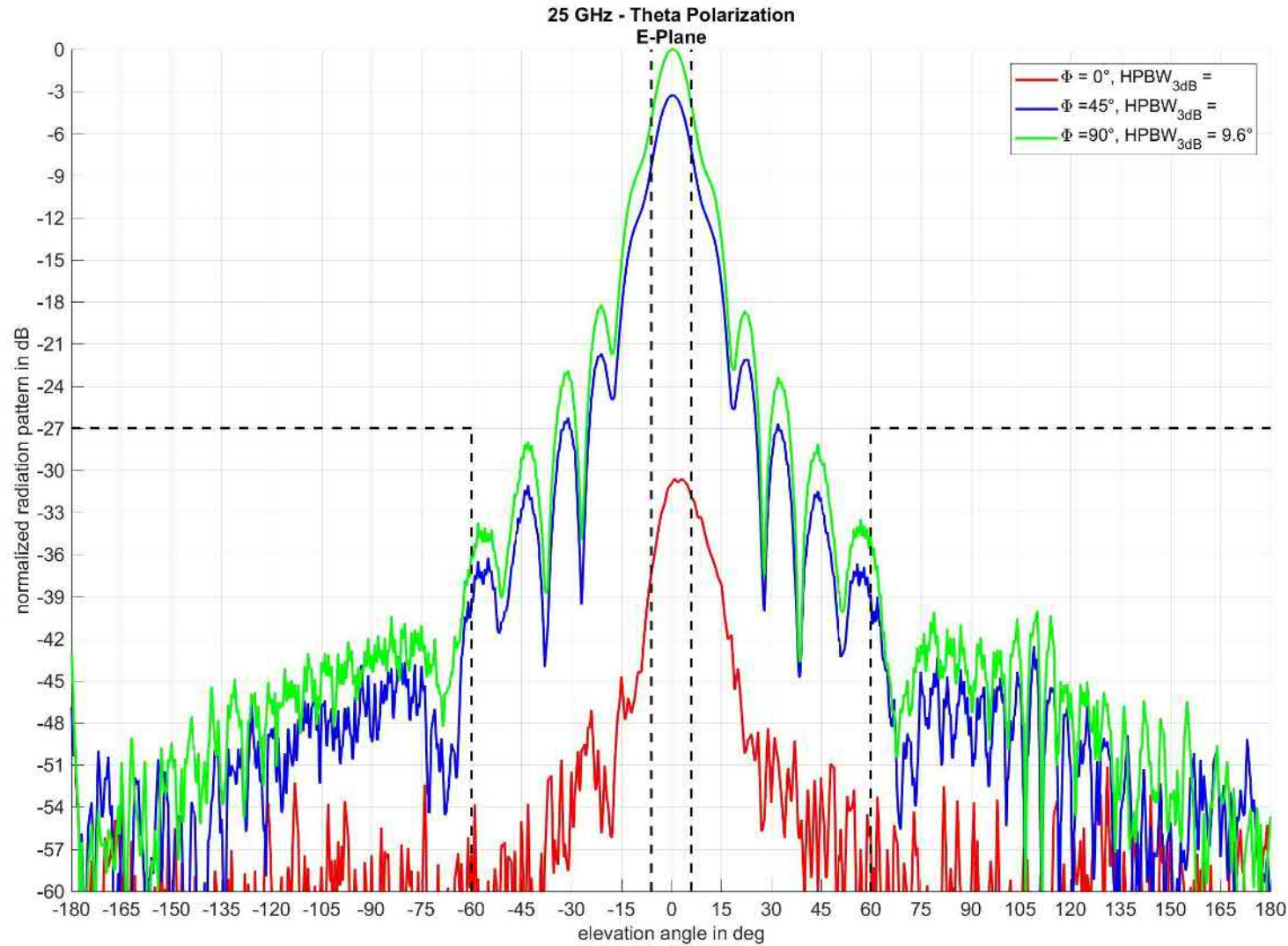

Measurement: Config #3– E-Plane zoom

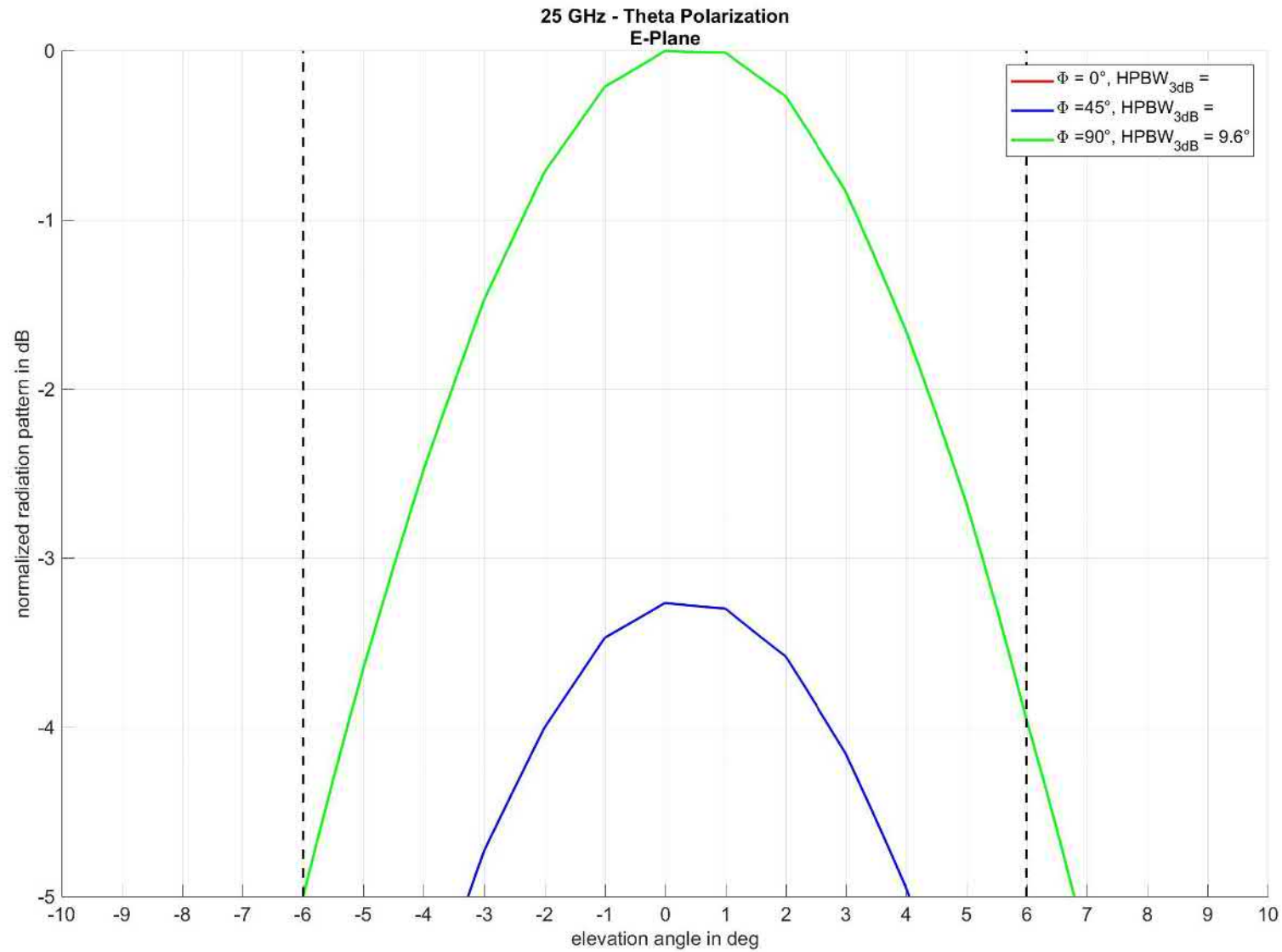

Measurement: Config #4– H-Plane

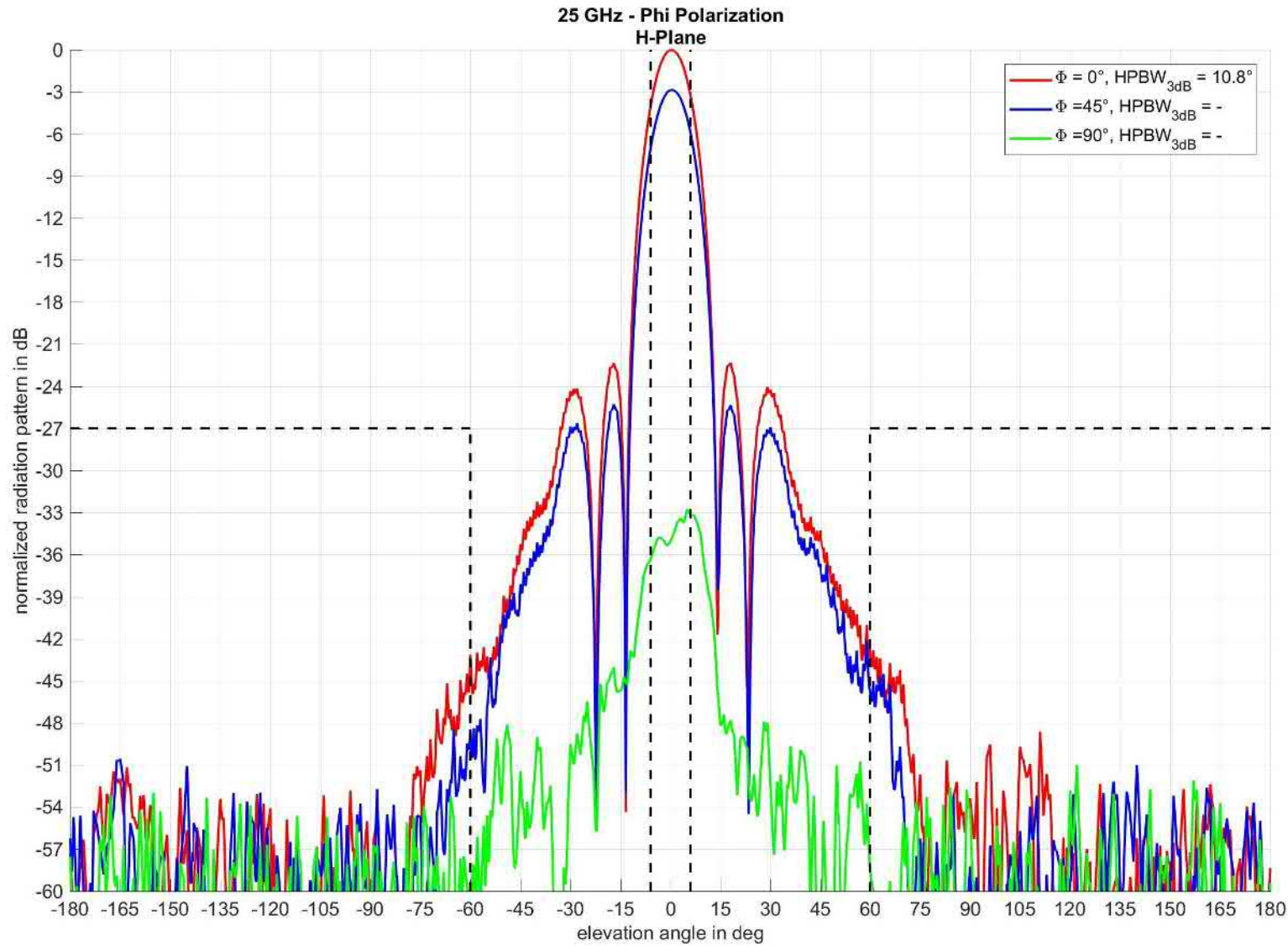

Measurement: Config #4– H-Plane zoom

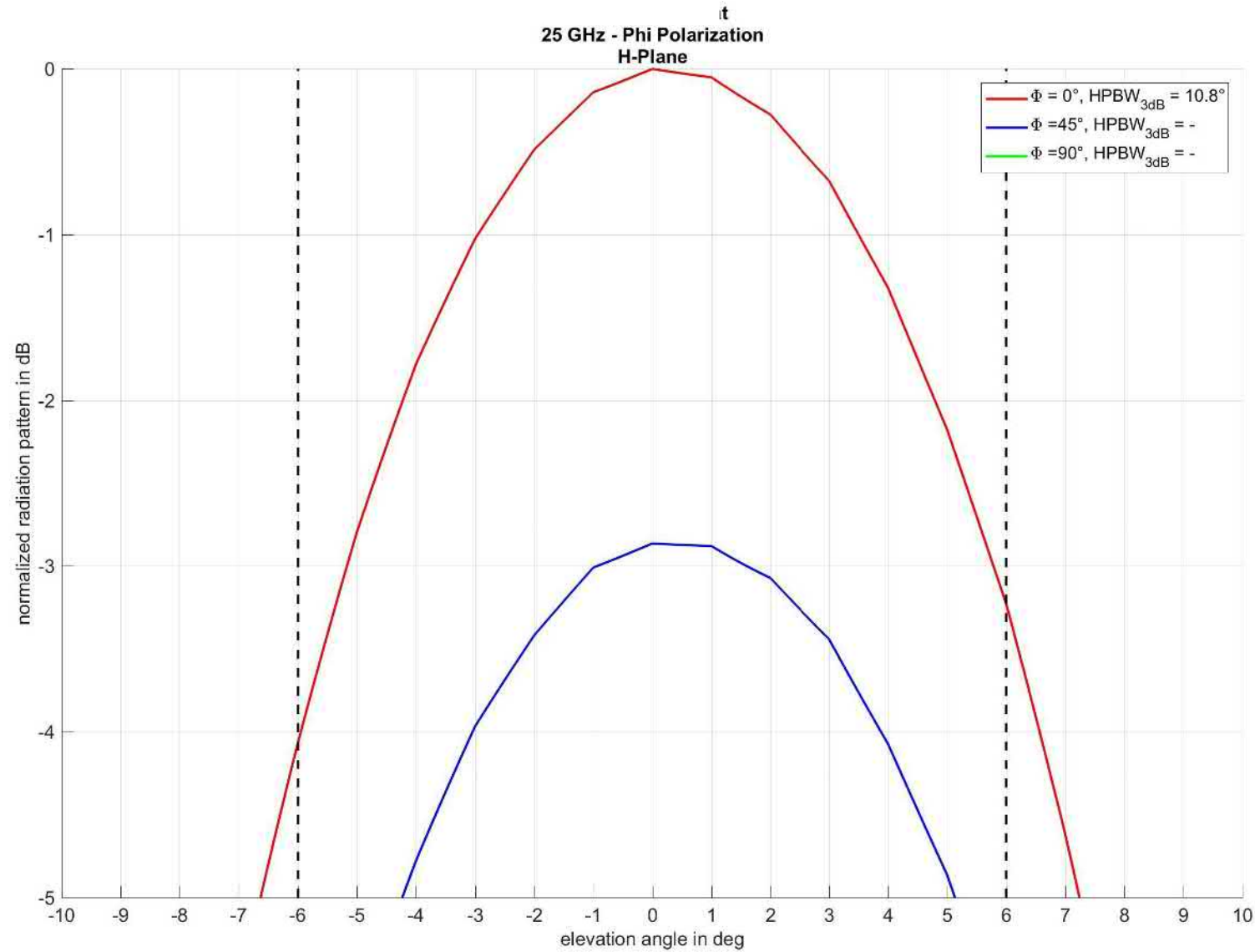

Measurement: Config #4– E-Plane

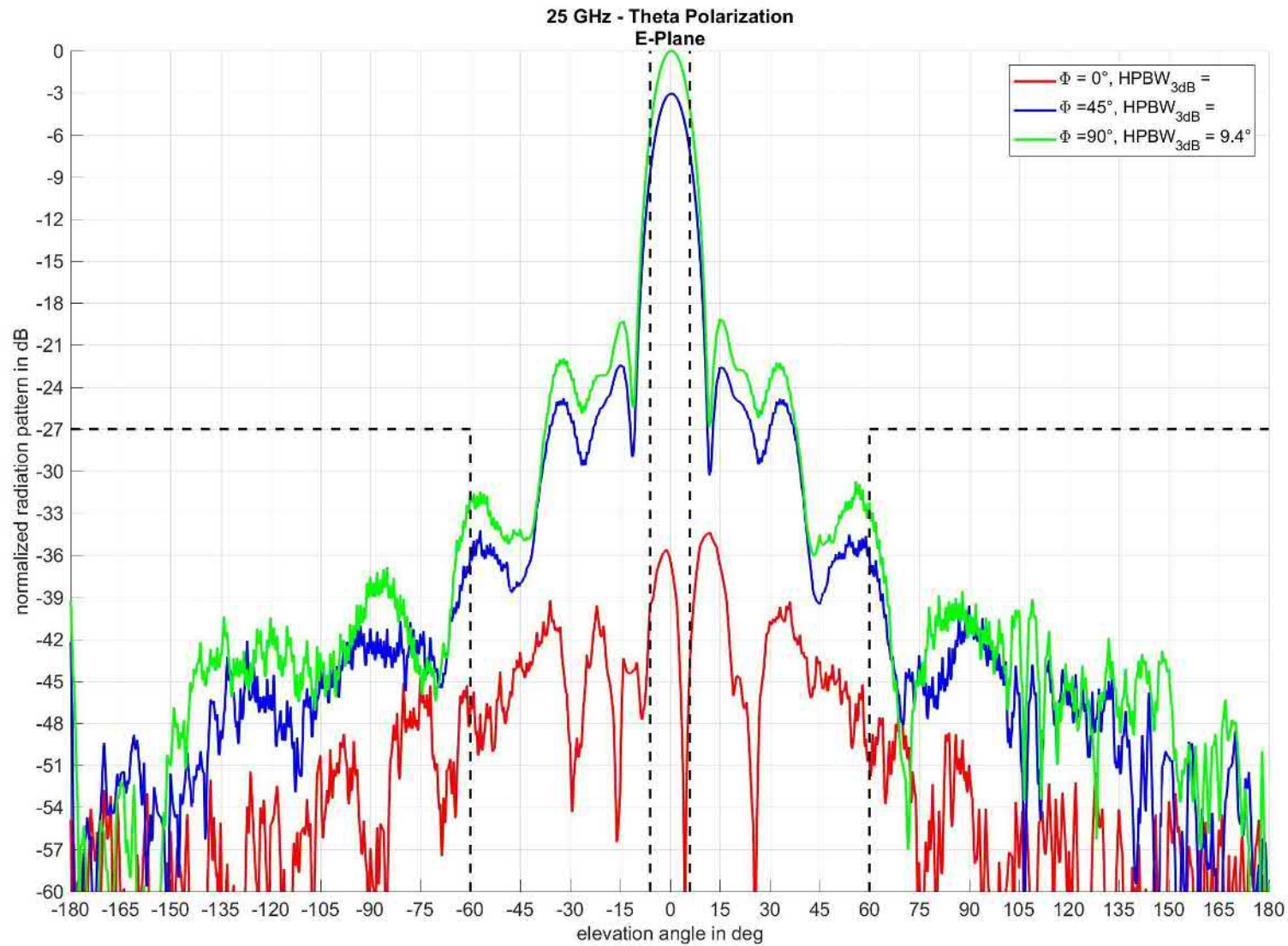

Measurement: Config #4– E-Plane zoom

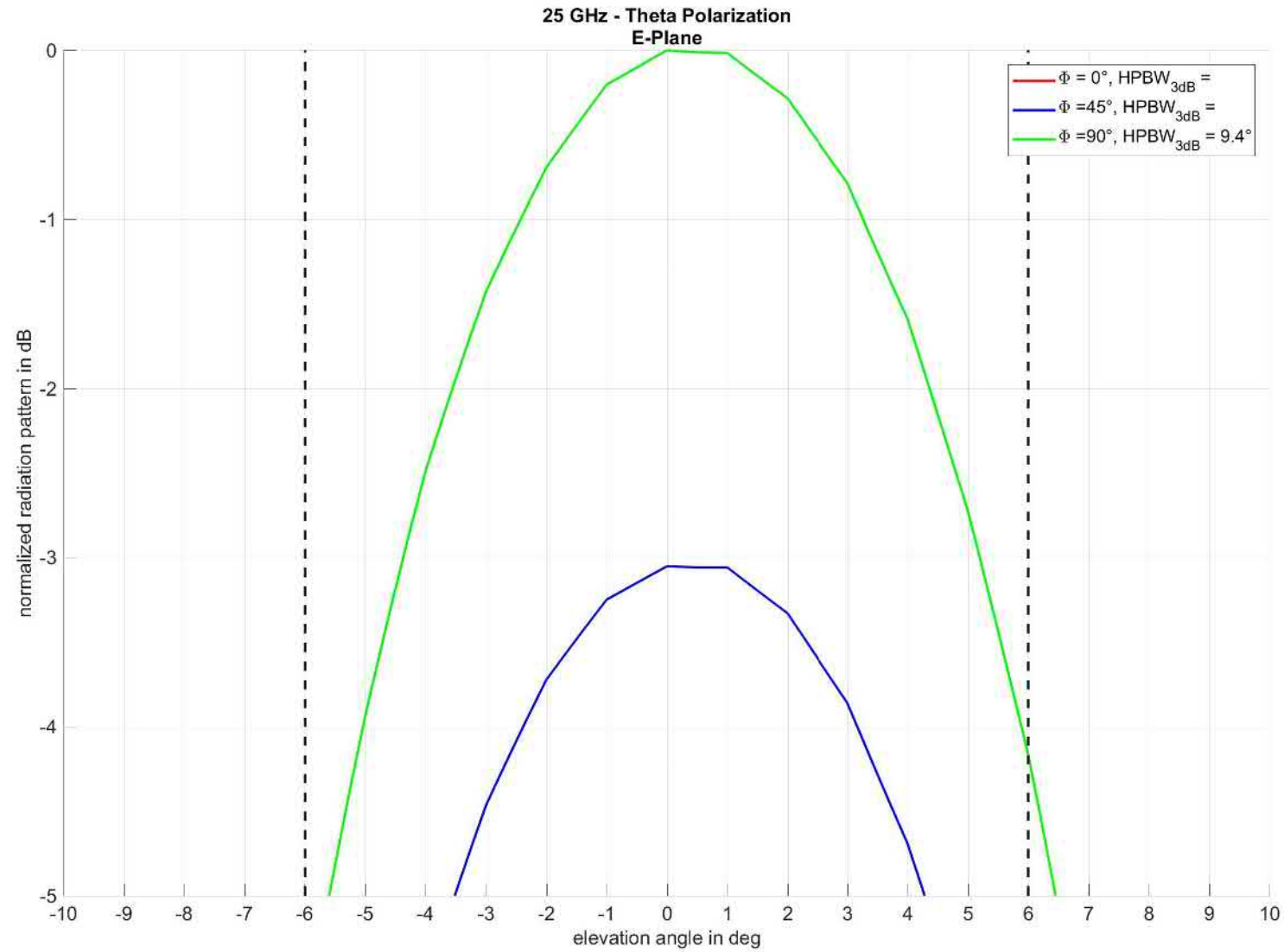

Summary



Antenna Type	HPBW _{3dB} (degrees)		Antenna side lobe gain at (>±60°) relative to main beam gain (dB)	
	H-plane	E-plane	H-plane	E-plane
Config#1	12.7	11.0	49	31
Config#2	11.0	10.2	37	31
Config#3	10.5	9.6	49	36
Config#4	10.8	9.4	43	31

Note 1: Error in HPBW_{3dB} measurement is +/-2.4 degrees

Note 2: Error in amplitude measurement is +/-2.3 dB

(see “Measurement Error Evaluation” Section)

(see “Measurement Error Evaluation” Section)

Measurement Error Evaluation I

The calculation follows the steps recommended in ref(3), section 4.2.2. From the factors considered in 4.2.2 only the factors affecting beamwidth measurement were accounted. The main contributor to the error is the chamber and because the antenna is moving during the measurement it was considered as recommended in all references.

Source of uncertainty	Value	Standard uncertainty (linear units)	Comments
EUT Measurement			
Positioning of the phase centre within the EUT over the axis of rotation of the turntable	±1 mm	0.23	1/4171.5*100 u _{j21} -value from ref(3) Annex A.3
Site Factors			
Reflectivity of absorbing material: EUT to the test antenna	0.74 dB	8.51	Measurement done in anechoic chamber with attenuation >30dB u _{j01} -value from ref(3) Annex A.1
Mutual coupling: EUT to its images in the absorbing material	0.50 dB	5.75	u _{j04} -value from ref(3) Annex A.2
Mutual coupling: Receiving antenna to its images in the absorbing material	0.50 dB	5.75	u _{j07} -value from ref(3) Annex A.2
Cable factor: cable repositioning, rotary joints	0.50 dB	5.75	u _{j19} -value from ref(3) Annex A.5
Receiving device			
Receiving device: VNA S21 measurement accuracy	0.20 dB	2.3	R&S ZVA50 data sheet – see ref(4)
Receiving device: VNA linearity	0.10 dB	1.15	R&S ZVA50 data sheet – see ref(4)

Measurement Error Evaluation II

Source of uncertainty	Value	Standard uncertainty (linear units)	Comments
Combined contribution to uncertainty for amplitude measurements	1.16 dB	13.35	Sum of above contributions calculated in accordance with ref(2)clause 5.2
Expanded uncertainty for amplitude measurements (k=1.96, for 95% confidence)	2.3 dB		
Conversion of uncertainty in amplitude measurement to uncertainty in beamwidthangle measurement	1.16 dB *0.96 degrees	1.1 degrees	Conversion from level uncertainty to beamwidthuncertainty procedure: Main lobe approximated with second order polynomial $Y = Ax^2 + Bx + C$ (Y in dB, x in degrees) Fitting directivity diagram we obtain A ~ -0.08 (for antennas with HPBW _{3dB} ~12degrees) B ~ 0 C ~ 0 Slope at Y = -3dB or x~6degrees is calculated to 0.96dB/degree
Turntable positioning accuracy	0.5 degree	0.5 degrees	
Combined contribution to uncertainty in beamwidth angle measurement		1.2 degrees	Sum of above contributions calculated in accordance with ref(2)clause 5.2
Expanded uncertainty (k=1.96, for 95% confidence)		2.4 degrees	Calculated in accordance with ref(2),clause 5.3

Note: dB to linear conversions $_{lin} = 11.5 * s_{log}$ (in accordance with ref(2), annex C2)

- [1] ETSI TR 100 028 (V1.4.1) (parts 1 and 2): "Electromagnetic compatibility and Radio spectrum Matters (ERM); Uncertainties in the measurement of mobile radio equipment characteristics".
- [2] ETSI TR 102 273-1-1 (V1.2.1): "ElectroMagneticCompatibility and Radio Spectrum Matters (ERM); Improvement on Radiated Methods of Measurement (using test site) and evaluationof the corresponding measurement uncertainties; Part 1: Uncertainties in the measurement of mobile radio equipment characteristics; Sub-part 1: Introduction".
- [3] ETSI TR 102 273-1-2 (V1.2.1): "ElectroMagneticCompatibility and Radio Spectrum Matters (ERM); Improvement on Radiated Methods of Measurement (using test site) and evaluationof the corresponding measurement uncertainties; Part 1: Uncertainties in the measurement of mobile radio equipment characteristics; Sub-part 2: Examples and annexes"
- [4] R&S@ZVA Vector Network Analyser Specifications -Version 11.00, March 2014; http://cdn.rohde-schwarz.com/dl_downloads/dl_common_library/dl_brochures_and_datasheets/pdf_1/ZVA_dat-sw_en_5213-5680-22_v1100.pdf

Chamber Certification Data I

Measurement of shielding attenuation according to EN 50147-1	Results
	The shielding attenuation measurement at the specified measurement points (see figure 5.1 -5.2) showed that the enclosure keeps the specified attenuation values.

3.3 Requirements

The enclosure was measured at the following frequencies:

field	frequency	expected attenuation	antenna distance
magnetic	10 kHz	≥ 80 dB	70 cm
	100 kHz	≥ 100 dB	
	1 MHz	≥ 100 dB	
electric	100 MHz	≥ 110 dB	210 cm
plane wave	2 GHz	≥ 110 dB	70 cm
	10 GHz	≥ 100 dB	
	18 GHz	≥ 100 dB	
	40 GHz	≥ 100 dB	

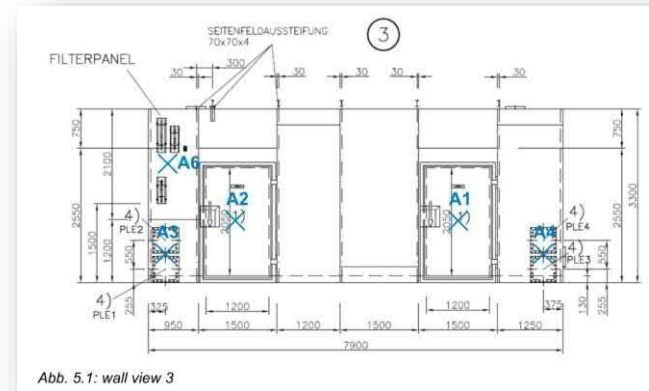
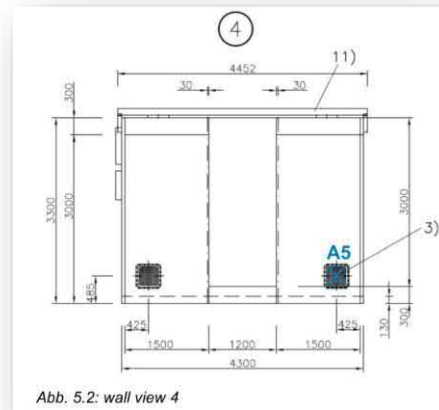

Chamber Certification Data II

Reflectivity Performance (Quiet Zone)

When measured in accordance with the method "Free-Space VSWR Field Probe Procedure for Antenna Range Evaluation", the performance in the spherical Quiet zone (center is positioned in the middle of the chamber height and width) is specified to be as follows :

Transmission Length (TL) = 3.5 m

Frequency	QZ diameter	Antenna Gain		Guaranteed Quiet Zone Reflectivity
		Transmit Antenna	Receive Antenna	
800 MHz	0.8 m	8dBi	8dBi	-23 dB
3 GHz	0.6 m	18dBi	18dBi	-41 dB
10 GHz	0.6 m	22dBi	22dBi	-47 dB

Results

At **0.80 GHz**, the worst-case signal level was measured to be **-36 dB** while the specified (expected) reflectivity at the same frequency had been set to be better than -25 dB.

At **3.00 GHz**, the worst-case signal level was measured to be **-52.3 dB** while the specified (expected) reflectivity at the same frequency had been set to be better than -41 dB.

At **10.0 GHz**, the worst-case signal level was measured to be **-50 dB** while the specified (expected) reflectivity at the same frequency had been set to be better than -47 dB.

The measurement results show that the installed chamber possesses better reflectivity levels than the expected ones in the design phase. Hence, the results for the antenna patterns measured in this chamber will have lower uncertainty levels than the ones expected.

List of Instruments



Instrument	Model	Manufacturer	CalibrationExpiry Date
Network Analyzer	ZVA50	Rohde&Schwarz	2018-11-23
Calibration Unit	ZV-Z55	Rohde&Schwarz	2018-10-23
PowerSupply	HMP2030	Hameg	-
Motor ControllerUnit	NCD	Maturo GmbH	-
Power Amplifier	HMC-C017	Analog Devices – Hittite	-
LNA	HMC 751	Analog Devices – Hittite	-
Coaxial Cable	Sucoflex101	Huber + Suhner	-
Connectors	PC 2.4 mm SMA	Huber + Suhner	-
Adaptors	PC 2.4 mm -SMA	Huber + Suhner	-
Reference antenna	LB-180400-15C	A-INFOMW	-
Rotary joint	BN 835077	Spinner	-

Reference Horn Antenna

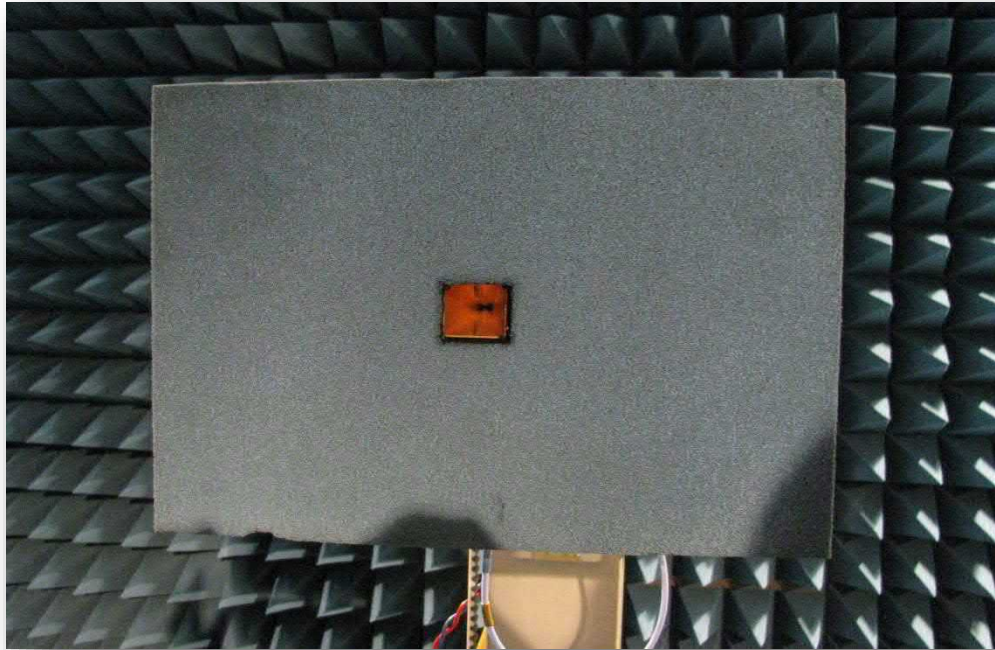

A-INFOMW LB-180400-15C
18 – 40 GHz Broadband Horn Antenna

Frequency Range(GHz)	18 - 40
Gain(dB)	15 Typ.
Polarization	Linear
VSWR	1.5:1 Typ.
	2:1 Max.
Connector	2.92mm (K)- Female
Power Handling(W)	20 Max. CW
Size(mm)	32x27x71
Net Weight(Kg)	0.08 Around

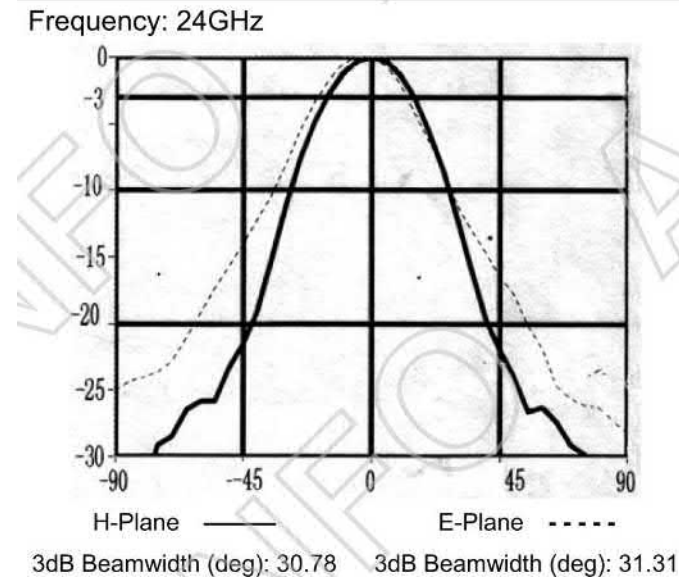

Power Amplifier and LNA

Analog Devices / Hittite
HMC-C017

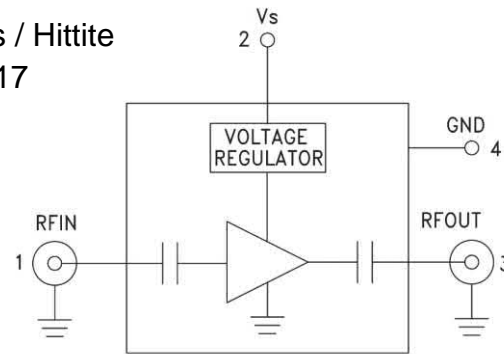

Parameter	Min.	Typ.	Max.	Units
Frequency Range	22 – 27			GHz
Gain	14.5	17.5		dB
Gain @ 25 GHz, +25 °C		17.5		dB
NoiseFigure		3.0	4.0	dB
Saturated Output Power			18.5	dBm
Regulated Supply Vs	8		16	V
Supply Current			96	mA

Analog Devices / Hittite
HMC 751 LC4

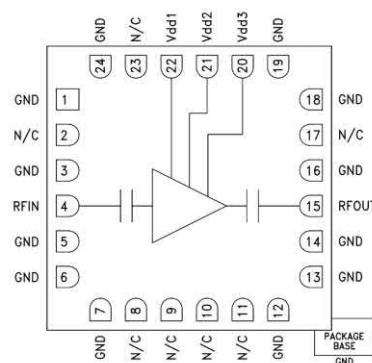
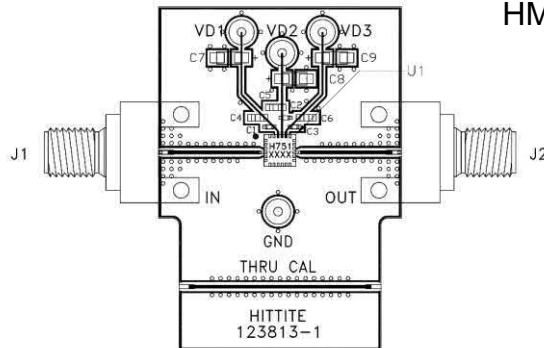

Parameter	Min.	Typ.	Max.	Units
Frequency Range	20 – 27			GHz
Gain	23	25		dB
Gain @ 25 GHz, +25 °C		25.5		dB
NoiseFigure		2.0	2.6	dB
Saturated Output Power			15	dBm
Regulated Supply Vdd		4		V
Supply Current	50	73	90	mA