

Specific Absorption Rate (SAR) Test Report
for
SOLOMON Technology Corp.
on the
802.11b USB Wireless LAN+GPRS modem

FCC ID : NIT-SCWI275U
Report No. : F412810-01
Brand Name : SOLOMON
Model Name : SCWi275u
Date of Testing : Mar.15~16, 2004
Date of Report : Mar.30,2004
Date of Review : Mar.30,2004

- The test results refer exclusively to the presented test model / sample only.
- Without written approval of SPORTON International Inc., the test report shall not be reproduced except in full.

SPORTON International Inc.

6F, No.106, Sec. 1, Hsin Tai Wu Rd., Hsi Chih, Taipei Hsien, Taiwan, R.O.C.

Table of Contents

1. Statement of Compliance	1
2. Administration Data.....	2
2.1 Testing Laboratory	2
2.2 Detail of Applicant.....	2
2.3 Application Detail.....	2
3. Scope	3
3.1 Description of Testing System	3
3.1.1 Description of Device under Test.....	3
3.1.2 Description of Testing Hosts.....	6
3.2 Applied Standards:.....	7
3.3 Device Category and SAR Limits.....	7
3.4 Test Conditions	8
3.4.1 Ambient Condition:.....	8
3.4.2 Test Configuration:	8
4. Specific Absorption Rate (SAR).....	9
4.1 Introduction.....	9
4.2 SAR Definition	9
5. SAR Measurement Setup	10
5.1 DASY4 E-Field Probe System.....	11
5.1.1.ET3DV6 E-Field Probe Specification.....	12
5.1.2 ET3DV6 E-Field Probe Calibration.....	12
5.2 DATA Acquisition Electronics (DAE)	13
5.3 Robot	14
5.4 Measurement Server	14
5.5 SAM Twin Phantom.....	14
5.6 Data Storage and Evaluation.....	16
5.6.1 Data Storage.....	16
5.6.2 Data Evaluation	16
5.7 Test Equipment List	19
6. Tissue Simulating Liquids.....	20
7. Uncertainty Assessment	22
8. SAR Measurement Evaluation	24
8.1 Purpose of System Performance check	24
8.2 System Setup.....	24
9. Description for DUT Testing Position.....	26
10. Measurement Procedures.....	32
10.1 Spatial Peak SAR Evaluation.....	32
10.2 Scan Procedures.....	33
10.3 SAR Averaged Methods.....	33
11. SAR Test Results.....	34
11.1 NB BTM Touch	34
11.2 NB BTM With 1.5 CM Gap.....	35
11.3 NB BTM Touch With Cable	36
12. References.....	37
Appendix A - System Performance Check Data	
Appendix B - SAR Measurement Data	
Appendix C - Calibration Data	

1. Statement of Compliance

The Specific Absorption Rate (SAR) maximum result found during testing for the **SOLOMON Technology Corp. 802.11b USB Wireless LAN+GPRS modem SCWi275u** are **0.179 W/Kg for the GSM 850 body SAR and 1.04 W/Kg for the PCS 1900 body SAR** with expanded uncertainty 20.3%. It is in compliance with Specific Absorption Rate (SAR) for general population/uncontrolled exposure limits specified in FCC 47 CFR part 2 (2.1093) and ANSI/IEEE C95.1-1999 and had been tested in accordance with the measurement methods and procedures specified in OET Bulletin 65 Supplement C (Edition 01-01).

Tested by Phillip Lin

Reviewed by Daniel Lee



Phillip Lin
Project Leader



Dr. C.H. Daniel Lee
SAR Lab. Manager

2. Administration Data

2.1 Testing Laboratory

Company Name : Sporton International Inc.
Department : Antenna Design/SAR
Address : No.52, Hwa-Ya 1st RD., Hwa Ya Technology Park, Kwei-Shan Hsiang, TaoYuan Hsien, Taiwan, R.O.C.
Telephone Number : 886-3-327-3456
Fax Number : 886-3-327-0973

2.2 Detail of Applicant

Company Name : SOLOMON Technology Corp.
Address : No. 42, Sing Zhong Rd., Neihu Dist., Taipei Taiwan R.O.C.
Telephone Number : 886-2-8791-8989
Fax Number : 886-2-2792-3420
Contact Person : frederick_hsiao@solomon.com.tw

2.3 Application Detail

Date of reception of application: Jan.29, 2004
Start of test : Mar.15, 2004
End of test : Mar.16, 2004

3. Scope

3.1 Description of Testing System

3.1.1 Description of Device under Test

DUT Type :	802.11b USB Wireless LAN+GPRS modem
Trade Name :	SOLOMON
Model Name :	SCWi275u
FCC ID	NIT-SCWI275U
IMEI Code	N/A
Tx & Rx Frequency :	GPRS: 1850-1910MHz (Tx) / 1930-1990MHz (Rx) WLAN: 2412-2462 MHz (Tx & Rx)
Antenna Type :	GPRS: Fixed External; WLAN: Fixed Internal
Antenna Gain :	GPRS: 1 dBi; WLAN: 1.5 dBi
Maximum Power Rating:	29 dBm/ GSM850, 30 dBm/ PCS, 11.5 dBm/ WLAN
Type of Modulation :	GPRS: GMSK; WLAN: BPSK, QPSK, CCK
DUT Stage	Identical prototype
Application Type :	Certification

Mark: There is a switch on EUT for selecting GPRS or WLAN function. GPRS and WLAN function will not work simultaneously.



Fig. 3.1. Top View of DUT

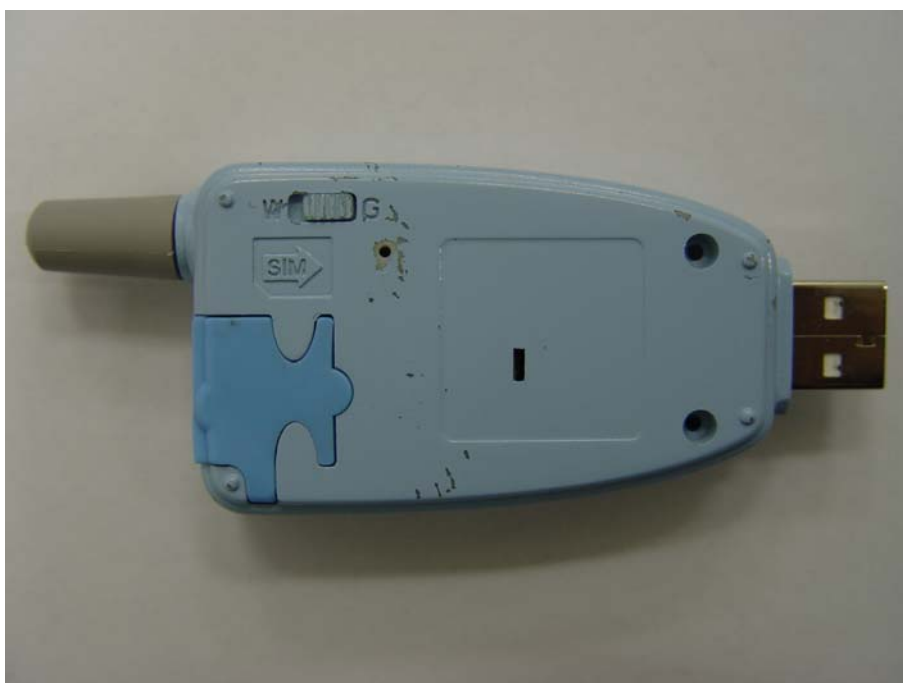

Fig. 3.2 Bottom View of DUT

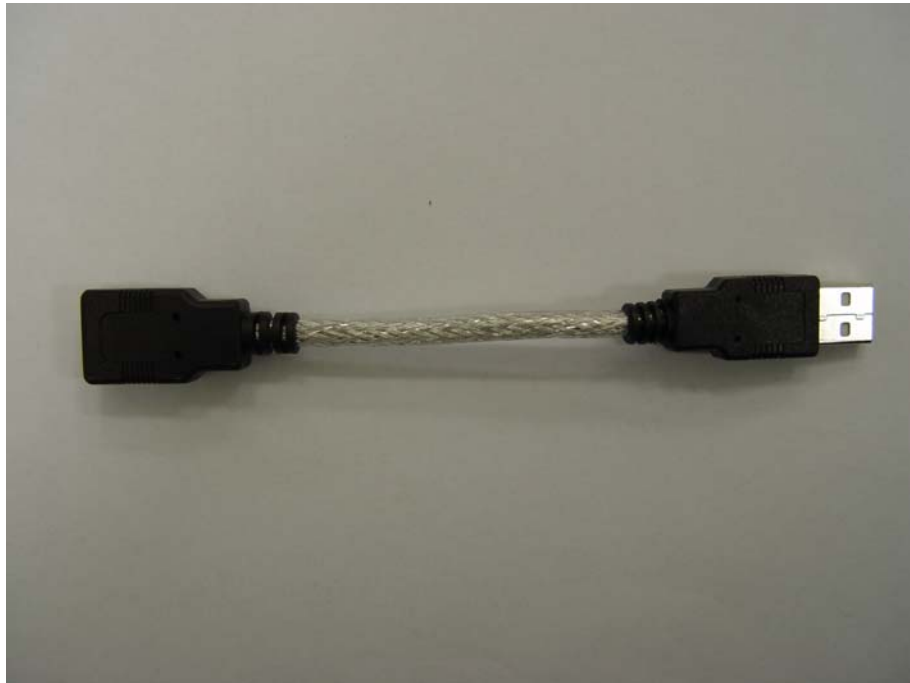

Fig. 3.3. Extension Cable

3.1.2 Description of Testing Hosts

- A. DELL Notebook:
FCC ID: E2K24CLNS
Model No.: PP05L

- B. Compaq Notebook:
FCC ID: NA
Model No.: Presario 1500

- C. I-Buddie Notebook:
FCC ID: NA
Model No.: A907

3.2 Applied Standards:

The Specific Absorption Rate (SAR) testing specification, method and procedure for this W11 GPRS with WLAN PC Card 56W11 is in accordance with the following standards:

47 CFR Part 2 (2.1093),
IEEE C95.1-1999,
IEEE C95.3-1991,
IEEE P1528 -200X, and
OET Bulletin 65 Supplement C (Edition 01-01)

3.3 Device Category and SAR Limits

This device belongs to portable device category because its radiating structure is allowed to be used within 20 centimeters of the body of the user.

Limit for General Population/Uncontrolled exposure should be applied for this device, it is 1.6 W/kg as averaged over any 1 gram of tissue.

3.4 Test Conditions

3.4.1 Ambient Condition:

Ambient Temperature (°C)	21 ~ 23°C
Tissue simulating liquid temperature (°C)	21.5°C
Humidity (%)	40~60%

3.4.2 Test Configuration:

The device was controlled by using a base station emulator CMU 200. Communication between the device and the emulator was established by air link. The distance between the DUT and the antenna of the simulator is larger than 50 cm and the output power radiated from the simulator antenna is at least 30 dB smaller than the output power of DUT.

Measurements were performed on the lowest, middle , and highest channel of each band for each testing position of different hosts. However, if the SAR is 3dB below the SAR limit (1.6 W/kg), only middle channel was tested in this position.

The DUT was set from the base station emulator (GSM and PCS) to radiate maximum output power for each band during the SAR testing. The crest factor wes set as 8 for GSM 850 and PCS 1900 because it is GPRS Class 8.

4. Specific Absorption Rate (SAR)

4.1 Introduction

SAR is related to the rate at which energy is absorbed per unit mass in an object exposed to a radio field. The SAR distribution in a biological body is complicated and is usually carried out by experimental techniques or numerical modeling. The FCC recommends limits for two tiers of groups, occupational/controlled and general population/uncontrolled, based on a person’s awareness and ability to exercise control over his or her exposure. In general, occupational/controlled exposure limits are higher than the limits for general population/uncontrolled.

4.2 SAR Definition

The SAR definition is the time derivative (rate) of the incremental energy (dW) absorbed by (dissipated in) an incremental mass (dm) contained in a volume element (dv) of a given density (ρ). The equation description is as below:

$$\mathbf{SAR} = \frac{d}{dt} \left(\frac{dW}{dm} \right) = \frac{d}{dt} \left(\frac{dW}{\rho dv} \right)$$

SAR is expressed in units of Watts per kilogram (W/kg)

SAR measurement can be either related to the temperature elevation in tissue by

$$\mathbf{SAR} = C \frac{\delta T}{\delta t}$$

, where C is the specific head capacity, δ T is the temperature rise and δ t the exposure duration,

or related to the electrical field in the tissue by

$$\mathbf{SAR} = \frac{\sigma |E|^2}{\rho}$$

, where σ is the conductivity of the tissue, ρ is the mass density of the tissue and E is the rms electrical field strength.

However for evaluating SAR of low power transmitter, electrical field measurement is typically applied.

5. SAR Measurement Setup

Remote Control Box

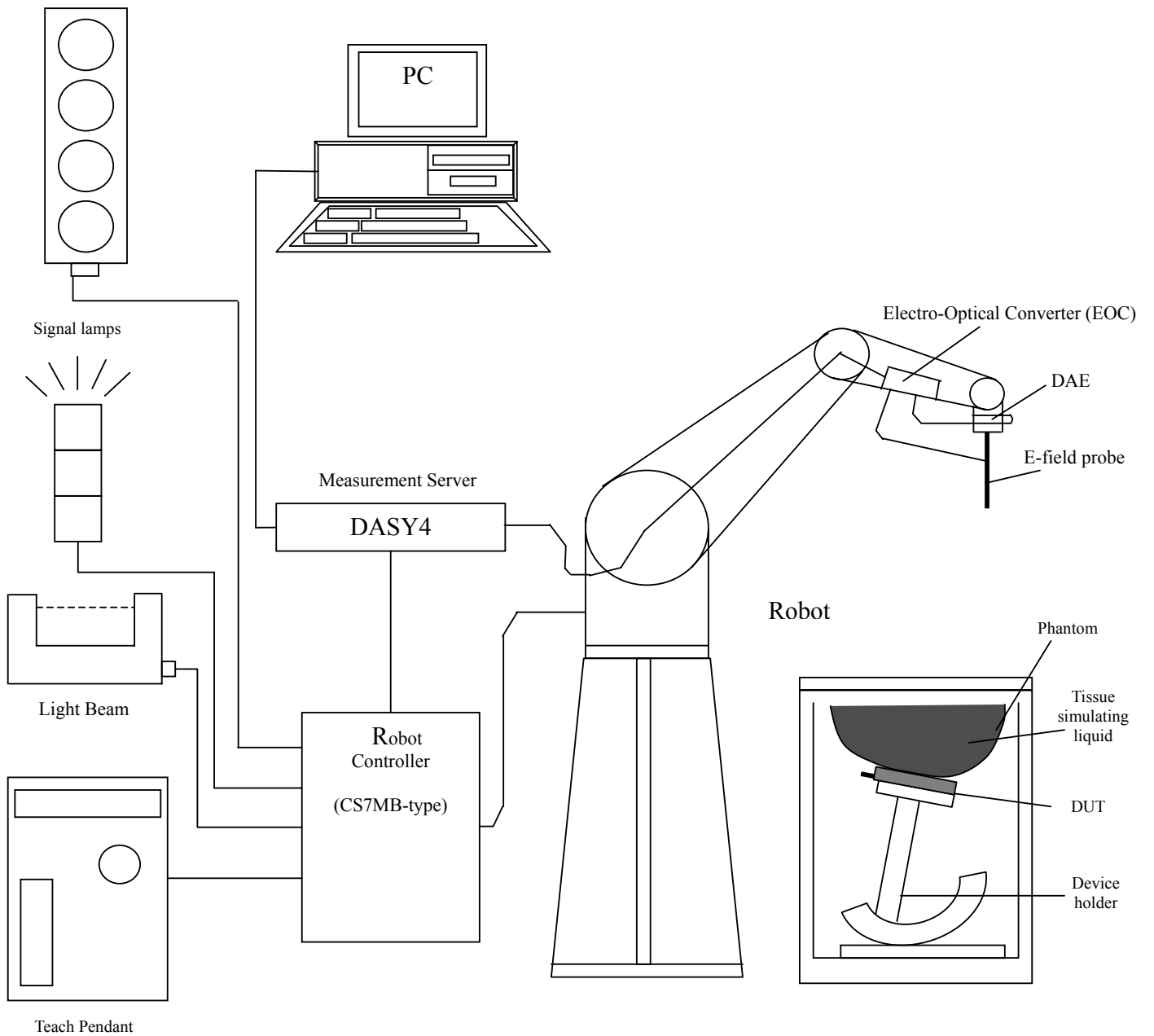

Fig. 5.1 DASY4 system

The DASY4 system for performance compliance tests is illustrated above graphically. This system consists of the following items:

- A standard high precision 6-axis robot with controller, a teach pendant and software
- A data acquisition electronic (DAE) attached to the robot arm extension
- A dosimetric probe equipped with an optical surface detector system
- The electro-optical converter (ECO) performs the conversion between optical and electrical signals
- A measurement server performs the time critical tasks such as signal filtering, control of the robot operation and fast movement interrupts.
- A probe alignment unit which improves the accuracy of the probe positioning
- A computer operating Windows XP
- DASY4 software
- Remove control with teach pendant and additional circuitry for robot safety such as warning lamps, etc.
- The SAM twin phantom
- A device holder
- Tissue simulating liquid
- Dipole for evaluating the proper functioning of the system

Some of the components are described in details in the following sub-sections.

5.1 DASY4 E-Field Probe System

The SAR measurement is conducted with the dosimetric probe ET3DV6 (manufactured by SPEAG). The probe is specially designed and calibrated for use in liquid with high permittivity. The dosimetric probe has special calibration in liquid at different frequency. This probe has a built in optical surface detection system to prevent from collision with phantom.

Calibration: Required once a year.

5.1.1.ET3DV6 E-Field Probe Specification

Construction	Symmetrical design with triangular core Built-in optical fiber for surface detection system Built-in shielding against static charges PEEK enclosure material (resistant to organic solvents)
Calibration	Simulating tissue at frequencies of 900MHz, 1.8GHz and 2.45GHz for brain and muscle (accuracy ±8%)
Frequency	10 MHz to > 3 GHz
Directivity	± 0.2 dB in brain tissue (rotation around probe axis) ± 0.4 dB in brain tissue (rotation perpendicular to probe axis)
Dynamic Range	5 μ W/g to > 100mW/g; Linearity: ±0.2dB
Surface Detection	± 0.2 mm repeatability in air and clear liquids on reflecting surface
Dimensions	Overall length: 330mm Tip length: 16mm Body diameter: 12mm Tip diameter: 6.8mm Distance from probe tip to dipole centers: 2.7mm
Application	General dosimetry up to 3GHz Compliance tests for mobile phones and Wireless LAN Fast automatic scanning in arbitrary phantoms



Fig. 5.2 Probe setup on robot

5.1.2 ET3DV6 E-Field Probe Calibration

Each probe needs to be calibrated according to a dosimetric assessment procedure with accuracy better than ± 10%. The spherical isotropy shall be evaluated and within ± 0.25dB. The sensitivity parameters (NormX, NormY, and NormZ), the diode compression parameter (DCP) and the conversion factor (ConvF) of the probe are tested. The calibration data are as below:

Sensitivity		X axis : 1.68 μ V	Y axis: 1.62 μ V	Z axis : 1.71 μ V
Diode compression point		X axis : 95 mV	Y axis : 95 mV	Z axis : 95 mV
Conversion factor (Body)	Frequency (MHz)	X axis	Y axis	Z axis
	800~1000	6.5	6.5	6.5
	1710~1990	5.0	5.0	5.0
	2400~2500	4.5	4.5	4.5
Boundary effect (Body)	Frequency (MHz)	Alpha	Depth	
	800~1000	0.31	2.92	
	1710~1990	0.51	2.78	
	2400~2500	1.01	1.74	

NOTE:

1. The probe parameters have been calibrated by the SPEAG.
2. For the detailed calibration data is shown in Appendix C.

5.2 DATA Acquisition Electronics (DAE)

The data acquisition electronics (DAE4) consists of a highly sensitive electrometer-grade preamplifier with auto-zeroing, a channel and gain-switching multiplexer, a fast 16 bit AD-converter and a command decoder and control logic unit. Transmission to the measurement server is accomplished through an optical downlink for data and status information as well as an optical uplink for commands and the clock.

The mechanical probe mounting device includes two different sensor systems for frontal and sideways probe contacts. They are used for mechanical surface detection and probe collision detection.

The input impedance of the DAE4 is 200M Ohm; the inputs are symmetrical and floating. Common mode rejection is above 80dB.

Calibration: Required once a year. Calibration data is attached in Appendix C.

5.3 Robot

The DASY4 system uses the high precision robots RX90BL type out of the newer series from Stäubli SA (France). For the 6-axis controller DASYS system, the CS7MB robot controller version from Stäubli is used. The RX robot series have many features that are important for our application:

- High precision (repeatability 0.02 mm)
- High reliability (industrial design)
- Jerk-free straight movements
- Low ELF interference (the closed metallic construction shields against motor control fields)
- 6-axis controller

5.4 Measurement Server

The DASY4 measurement server is based on a PC/104 CPU board with
166 MHz CPU
32 MB chipset and
64 MB RAM.

Communication with
the DAE4 electronic box
the 16-bit AD-converter system for optical detection and digital I/O interface.

The measurement server performs all the real-time data evaluation for field measurements and surface detection, controls robot movements and handles safety operations.

Calibration: No calibration required.

5.5 SAM Twin Phantom

The SAM twin phantom is a fiberglass shell phantom with 2mm shell thickness (except the ear region where shell thickness increases to 6mm). It has three measurement areas:

- Left head
- Right head
- Flat phantom

The bottom plate contains three pair of bolts for locking the device holder. The device holder positions are adjusted to the standard measurement positions in the three sections.

A white cover is provided to tap the phantom during off-periods to prevent water evaporation and changes in the liquid parameters.

On the phantom top, three reference markers are provided to identify the phantom position with respect to the robot.

The phantom can be used with the following tissue simulating liquids:

- *Water-sugar based liquid
- *Glycol based liquids



Fig. 5.3 Top view of twin phantom



Fig. 5.4 Bottom view of twin phantom

5.6 Data Storage and Evaluation

5.6.1 Data Storage

The DASY4 software stores the assessed data from the data acquisition electronics as raw data (in microvolt readings from the probe sensors), together with all the necessary software parameters for the data evaluation (probe calibration data, liquid parameters and device frequency and modulation data) in measurement files with the extension .DA4. The postprocessing software evaluates the desired unit and format for output each time the data is visualized or exported. This allows verification of the complete software setup even after the measurement and allows correction of erroneous parameter settings. For example, if a measurement has been performed with an incorrect crest factor parameter in the device setup, the parameter can be corrected afterwards and the data can be reevaluated.

The measured data can be visualized or exported in different units or formats, depending on the selected probe type (e.g., [V/m], [A/m], [mW/g]). Some of these units are not available in certain situations or give meaningless results, e.g., a SAR-output in a loseless media, will always be zero. Raw data can also be exported to perform the evaluation with other software packages.

5.6.2 Data Evaluation

The DASY4 postprocessing software (SEMCAD) automatically executes the following procedures to calculate the field units from the microvolt readings at the probe connector. The parameters used in the evaluation are stored in the configuration modules of the software :

Probe parameters :	- Sensitivity	$Norm_i, a_{i0}, a_{i1}, a_{i2}$
	- Conversion factor	$ConvF_i$
	- Diode compression point	dcp_i
Device parameters :	- Frequency	f
	- Crest factor	cf
Media parameters :	- Conductivity	σ
	- Density	ρ

These parameters must be set correctly in the software. They can be found in the component documents or they can be imported into the software from the configuration files issued for the DASY components. In the direct measuring mode of the multimeter option, the parameters of the actual system setup are used. In the scan visualization and export modes, the parameters stored in the corresponding document files are used. The first step of the evaluation is a linearization of the filtered input signal to account for the compression characteristics of the detector diode. The compensation depends on the input signal, the diode type and the DC-transmission factor from the diode to the evaluation electronics. If the exciting field is pulsed, the crest factor of the signal must be known to correctly compensate for peak power. The formula for each channel

can be given as :

$$V_i = U_i + U_i^2 \cdot \frac{cf}{dcp_i}$$

with V_i = compensated signal of channel i ($i = x, y, z$)
 U_i = input signal of channel i ($i = x, y, z$)
 cf = crest factor of exciting field (DASY parameter)
 dcp_i = diode compression point (DASY parameter)

From the compensated input signals, the primary field data for each channel can be evaluated :

E-field probes : $E_i = \sqrt{\frac{V_i}{Norm_i ConvF}}$

H-field probes : $H_i = \sqrt{V_i \frac{a_{i0} + a_{i1}f + a_{i2}f^2}{f}}$

with V_i = compensated signal of channel i ($i = x, y, z$)
 $Norm_i$ = sensor sensitivity of channel i ($i = x, y, z$)
 $\mu V/(V/m)^2$ for E-field Probes
 $ConvF$ = sensitivity enhancement in solution
 a_{ij} = sensor sensitivity factors for H-field probes
 f = carrier frequency [GHz]
 E_i = electric field strength of channel i in V/m
 H_i = magnetic field strength of channel i in A/m

The RSS value of the field components gives the total field strength (Hermitian magnitude) :

$$E_{tot} = \sqrt{E_x^2 + E_y^2 + E_z^2}$$

The primary field data are used to calculate the derived field units.

$$SAR = E_{tot}^2 \cdot \frac{\sigma}{\rho \cdot 1000}$$

with SAR = local specific absorption rate in mW/g
 E_{tot} = total field strength in V/m
 σ = conductivity in [mho/m] or [Siemens/m]
 ρ = equivalent tissue density in g/cm³

* Note that the density is set to 1, to account for actual head tissue density rather than the density of the tissue simulating liquid.

The power flow density is calculated assuming the excitation field to be a free space field.

$$P_{pwe} = \frac{E_{tot}^2}{3770} \quad \text{or} \quad P_{pwe} = H_{tot}^2 \cdot 37.7$$

with P_{pwe} = equivalent power density of a plane wave in mW/cm²
 E_{tot} = total electric field strength in V/m
 H_{tot} = total magnetic field strength in A/m

5.7 Test Equipment List

Manufacture	Name of Equipment	Type/Model	Serial Number	Calibration	
				Last Cal.	Due Date
SPEAG	Dosimetric E-Filed Probe	ET3DV6	1788	Aug. 29, 2003	Aug. 29, 2004
SPEAG	900MHz System Validation Kit	D900V2	172	Jan. 13, 2004	Jan. 13, 2006
SPEAG	1800MHz System Validation Kit	D1800V2	265	May 14, 2003	May 14, 2005
SPEAG	835MHz System Validation Kit	D835V2	499	Feb. 12, 2004	Feb. 12, 2006
SPEAG	1900MHz System Validation Kit	D1900V2	5d041	Feb. 17, 2004	Feb. 17, 2006
SPEAG	2450MHz System Validation Kit	D2450V2	736	Aug. 26, 2003	Aug. 26, 2004
SPEAG	Data Acquisition Electronics	DAE3	577	Nov. 21, 2003	Nov. 21, 2004
SPEAG	Device Holder	N/A	N/A	NCR	NCR
SPEAG	Phantom	QD 000 P40 C	TP-1150	NCR	NCR
SPEAG	Robot	Staubli RX90BL	F03/5W15A1/A/01	NCR	NCR
SPEAG	Software	DASY4 V4.1 Build 47	N/A	NCR	NCR
SPEAG	Software	SEMCAD V1.6 Build 116	N/A	NCR	NCR
SPEAG	Measurement Server	SE UMS 001 BA	1021	NCR	NCR
Agilent	S-Parameter Network Analyzer (PNA)	E8358A	US40260131	Oct. 17, 2003	Oct. 17, 2004
Agilent	Dielectric Probe Kit	85070D	US01440205	NCR	NCR
R&S	Power Meter	NRVS	100444	May 28, 2003	May 28, 2004
R&S	Power Sensor	NRV-Z32	100057	May 28, 2003	May 28, 2004
R&S	Signal Generator	SMR40	100116	Nov. 06, 2003	Nov. 06, 2004
Agilent	Dual Directional Coupler	778D	50422	NCR	NCR
Agilent	Power Amplifier	8449B	3008A01917	Sep. 16, 2003	Sep. 16, 2004
R & S	Radio Communication Tester	CMU200	103937	Oct. 20, 2003	Oct. 20, 2004

Table 5.1 Test Equipment List

6. Tissue Simulating Liquids

For the measurement of the field distribution inside the SAM phantom with DASY4, the phantom must be filled with around 25 liters of homogeneous body tissue simulating liquid. The liquid height from the bottom of the phantom body is 15.2 centimeters, which are shown in Fig. 6.1, and Fig. 6.2 for GSM and PCS.

The following ingredients for tissue simulating liquid are used:

- **Water:** deionized water (pure H₂O), resistivity $\geq 16M\Omega$ - as basis for the liquid
- **Sugar:** refined sugar in crystals, as available in food shops – to reduce relative permittivity
- **Salt:** pure NaCl – to increase conductivity
- **Cellulose:** Hydroxyethyl-cellulose, medium viscosity (75-125 mPa.s, 2% in water, 20°C), CAS#54290-to increase viscosity and to keep sugar in solution.
- **Preservative:** Preventol D-7 Bayer AG, D-51368 Leverkusen, CAS#55965-84-9- to prevent the spread of bacteria and molds.
- **DGMBE:** Deithlenglycol-monobuthyl ether (DGMBE), Fluka Chemie GmbH, CAS#112-34-5 – to reduce relative permittivity.

Table 6.1 gives the recipes for one liter of muscle tissue simulating liquid for frequency bands 850 MHz, and 1900 MHz.

Ingredient	MSL-900	MSL-1800	MSL-2450
Water	631.68 g	716.56 g	698.3 g
Salt	11.72 g	4.0 g	0 g
Preventol D-7	1.2 g	0 g	0 g
Sugar	600.0 g	0 g	0 g
DGMBE	0 g	300.67 g	301.7 g
Total amount	1 liter	1 liter	1 liter (1.0 kg)
Dielectric Parameters target at 22°	f = 835 MHz $\epsilon_r = 55.2 \pm 5\%$, $\sigma = 0.97 \pm 5\%$ S/m	f = 1900 MHz $\epsilon_r = 53.3 \pm 5\%$, $\sigma = 1.52 \pm 5\%$ S/m	f = 2450MHz $\epsilon_r = 52.5 \pm 5\%$, $\sigma = 2.00 \pm 5\%$ S/m

Table 6.1

The dielectric parameters of the liquids were verified prior to the SAR evaluation using an Agilent 85070D Dielectric Probe Kit and an Agilent E8358A Network Analyzer.

Table 6.2 shows the measuring results for muscle simulating liquid in these 2 bands at the temperature = 21.5°C.

Bands	Frequency(MHz)	Permittivity (ϵ_r)	Conductivity (σ)
GSM band (824~849 MHz)	824	57.26	0.9967
	836	57.12	1.0000
	849	56.95	1.0010
PCS band (1850~1910 MHz)	1850	52.15	1.5100
	1880	52.51	1.5820
	1910	52.10	1.5200

Table 6.2

The measuring data are consistent with $\epsilon_r = 55.2 \pm 5\%$ and $\sigma = 0.97 \pm 5\%$ for GSM 850 band, $\epsilon_r = 53.3 \pm 5\%$ and $\sigma = 1.52 \pm 5\%$ for PCS band



Fig. 6.1



Fig. 6.2

7. Uncertainty Assessment

The component of uncertainty may generally be categorized according to the methods used to evaluate them. The evaluation of uncertainty by the statistical analysis of a series of observations is termed a Type A evaluation of uncertainty. The evaluation of uncertainty by means other than the statistical analysis of a series of observation is termed a Type B evaluation of uncertainty. Each component of uncertainty, however evaluated, is represented by an estimated standard deviation, termed standard uncertainty, which is determined by the positive square root of the estimated variance.

A Type A evaluation of standard uncertainty may be based on any valid statistical method for treating data. This includes calculating the standard deviation of the mean of a series of independent observations; using the method of least squares to fit a curve to the data in order to estimate the parameter of the curve and their standard deviations; or carrying out an analysis of variance in order to identify and quantify random effects in certain kinds of measurement.

A type B evaluation of standard uncertainty is typically based on scientific judgment using all of the relevant information available. These may include previous measurement data, experience and knowledge of the behavior and properties of relevant materials and instruments, manufacture’s specification, data provided in calibration reports and uncertainties assigned to reference data taken from handbooks. Broadly speaking, the uncertainty is either obtained from an outdoor source or obtained from an assumed distribution, such as the normal distribution, rectangular or triangular distributions indicated in Table 7.1

Uncertainty Distributions	Normal	Rectangular	Triangular	U-shape
Multiplying factor ^(a)	1/k ^(b)	1/√3	1/√6	1/√2

(a) standard uncertainty is determined as the product of the multiplying factor and the estimated range of variations in the measured quantity

(b) *k* is the coverage factor

Table 7.1

The combined standard uncertainty of the measurement result represents the estimated standard deviation of the result. It is obtained by combining the individual standard uncertainties of both Type A and Type B evaluation using the usual “root-sum-squares” (RSS) methods of combining standard deviations by taking the positive square root of the estimated variances.

Expanded uncertainty is a measure of uncertainty that defines an interval about the measurement result within which the measured value is confidently believed to lie. It is obtained by multiplying the combined standard uncertainty by a coverage factor. Typically, the coverage factor ranges from 2 to 3. Using a coverage factor allows the true value of a measured quantity to be specified with a defined probability within the specified uncertainty range. For purpose of this document, a coverage factor two is used, which corresponds to confidence interval of about 95 %. The DASY4 uncertainty Budget is showed in Table 7.2.

Error Description	Uncertainty Value \pm %	Probability Distribution	Divisor	C_i 1_g	Standard Unc. (1-g)	v_i or V_{eff}
Measurement System						
Probe Calibration	± 4.8	Normal	1	1	± 4.8	∞
Axial Isotropy	± 4.7	Rectangular	$\sqrt{3}$	$(1-C_p)^{1/2}$	± 1.9	∞
Hemispherical Isotropy	± 9.6	Rectangular	$\sqrt{3}$	$(C_p)^{1/2}$	± 3.9	∞
Boundary Effect	± 1.0	Rectangular	$\sqrt{3}$	1	± 0.6	∞
Linearity	± 4.7	Rectangular	$\sqrt{3}$	1	± 2.7	∞
System Detection Limit	± 1.0	Rectangular	$\sqrt{3}$	1	± 0.6	∞
Readout Electronics	± 1.0	Rectangular	1	1	± 1.0	∞
Response Time	± 0.8	Normal	$\sqrt{3}$	1	± 0.5	∞
Integration time	± 2.6	Rectangular	$\sqrt{3}$	1	± 1.5	∞
RF Ambient Conditions	± 3.0	Rectangular	$\sqrt{3}$	1	± 1.7	∞
Probe Positioner Mech. Tolerance	± 0.4	Rectangular	$\sqrt{3}$	1	± 0.2	∞
Probe Positioning with respect to Phantom Shell	± 2.9	Rectangular	$\sqrt{3}$	1	± 1.7	∞
Extrapolation and Interpolation Algorithms for Max. SAR Evaluation	± 1.0	Rectangular	$\sqrt{3}$	1	± 0.6	∞
Test sample Related						
Test sample Positioning	± 2.9	Normal	1	1	± 2.9	145
Device Holder Uncertainty	± 3.6	Normal	1	1	± 3.6	5
Output Power Variation-SAR drift measurement	± 2.5	Rectangular	$\sqrt{3}$	1	± 1.4	∞
Phantom and Tissue parameters						
Phantom uncertainty(Including shape and thickness tolerances)	± 4.0	Rectangular	$\sqrt{3}$	1	± 2.3	∞
Liquid Conductivity Target tolerance	± 5.0	Rectangular	$\sqrt{3}$	0.64	± 1.8	∞
Liquid Conductivity measurement uncertainty	± 2.5	Normal	1	0.64	± 1.6	∞
Liquid Permittivity Target tolerance	± 5.0	Rectangular	$\sqrt{3}$	0.6	± 1.7	∞
Liquid Permittivity measurement uncertainty	± 2.0	Normal	1	0.6	± 1.2	∞
Combined standard uncertainty					± 10.3	330
Coverage Factor for 95 %		K=2				
Expanded uncertainty (Coverage factor = 2)					± 20.6	

Table 7.2. Uncertainty Budget of DASY

8. SAR Measurement Evaluation

Each DASY system is equipped with one or more system validation kits. These units, together with the predefined measurement procedures within the DASY software, enable the user to conduct the system performance check and system validation. System validation kit includes a dipole, tripod holder to fix it underneath the flat phantom and a corresponding distance holder.

8.1 Purpose of System Performance check

The system performance check verifies that the system operates within its specifications. System and operator errors can be detected and corrected. It is recommended that the system performance check be performed prior to any usage of the system in order to guarantee reproducible results. The system performance check uses normal SAR measurements in a simplified setup with a well characterized source. This setup was selected to give a high sensitivity to all parameters that might fail or vary over time. The system check does not intend to replace the calibration of the components, but indicates situations where the system uncertainty is exceeded due to drift or failure.

8.2 System Setup

In the simplified setup for system evaluation, the DUT is replaced by a calibrated dipole and the power source is replaced by a continuous wave which comes from a signal generator with a fixed output power 100 mW (20 dBm) at frequency 835 MHz or 1900 MHz. The calibrated dipole must be placed beneath the flat phantom section of the SAM twin phantom with the correct distance holder. The distance holder should touch the phantom surface with a light pressure at the reference marking and be oriented parallel to the long side of the phantom. The equipment setup is shown below:

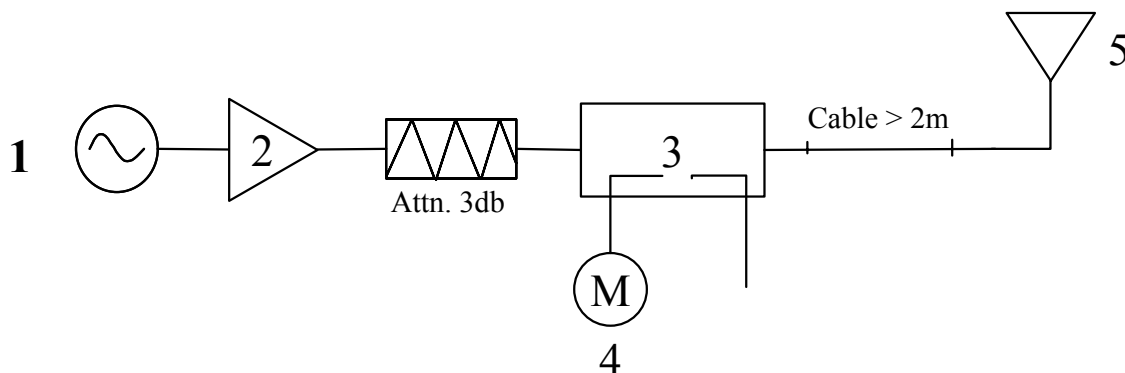

Fig. 8.1

1. Signal Generator
2. Amplifier
3. Directional Coupler
4. Power Meter
5. 835 MHz or 1900 MHz

The output power on dipole port must be calibrated to 100 mW (20 dBm) before dipole is connected.

8.3 Validation Results

Comparing to the original SAR value provided by Speag, the validation data should within its specification of 10 %. Table 8.1 shows the target SAR and measured SAR of 835/1900 MHz after normalized to 1W input power.

		Target (W/kg)	Measurement data (W/kg)	Variation
GSM band (835 MHz)	SAR (1g)	10.3	9.87	4.20 %
	SAR (10g)	6.76	6.44	4.70 %
PCS band (1900 MHz)	SAR (1g)	42.0	39.8	5.20 %
	SAR (10g)	20.0	19.3	3.50 %

Table 8.1

The tables above indicate the system performance check can meet the variation criterion.

9. Description for DUT Testing Position

This DUT was tested in 3 different positions on 3 different hosts. The 3 hosts are DELL NB, i-Buddie NB, and Compaq NB. The first testing position is “NB Bottom Touch” shown in Fig. 9.1, Fig. 9.2 and Fig. 9.3. In this position, the bottom of notebook (laptop) is touched with the phantom.



Fig. 9.1 DELL



Fig. 9.2 i-Buddie



Fig. 9.3 COMPAQ

The second position is “NB Bottom with 1.5 cm Gap” shown in Fig. 9.4, Fig. 9.5 and Fig. 9.6. In this position, the bottom face of the NB has 1.5 cm gap with the flat phantom.

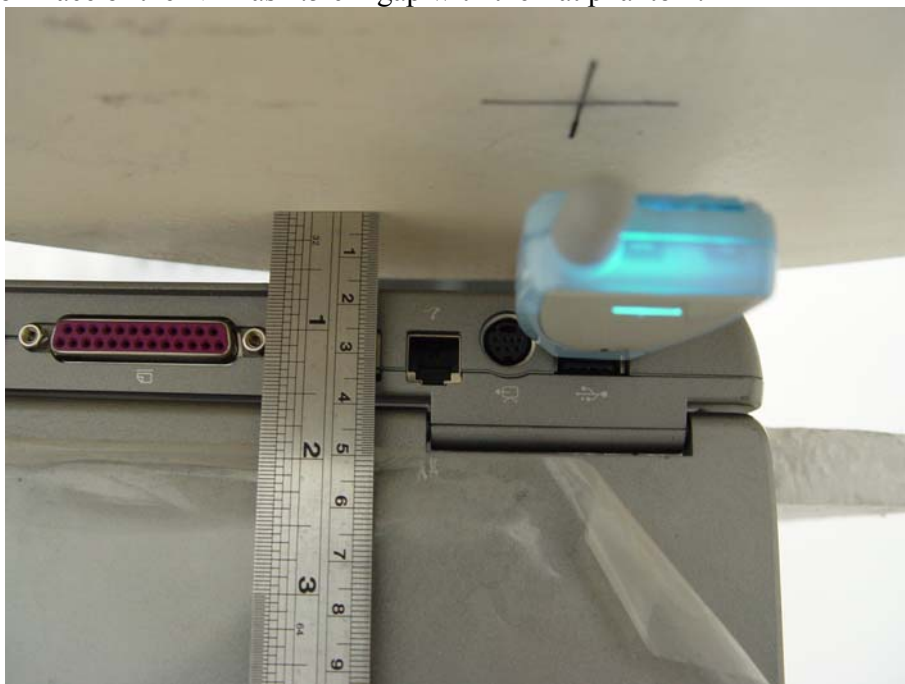

Fig. 9.4 DELL

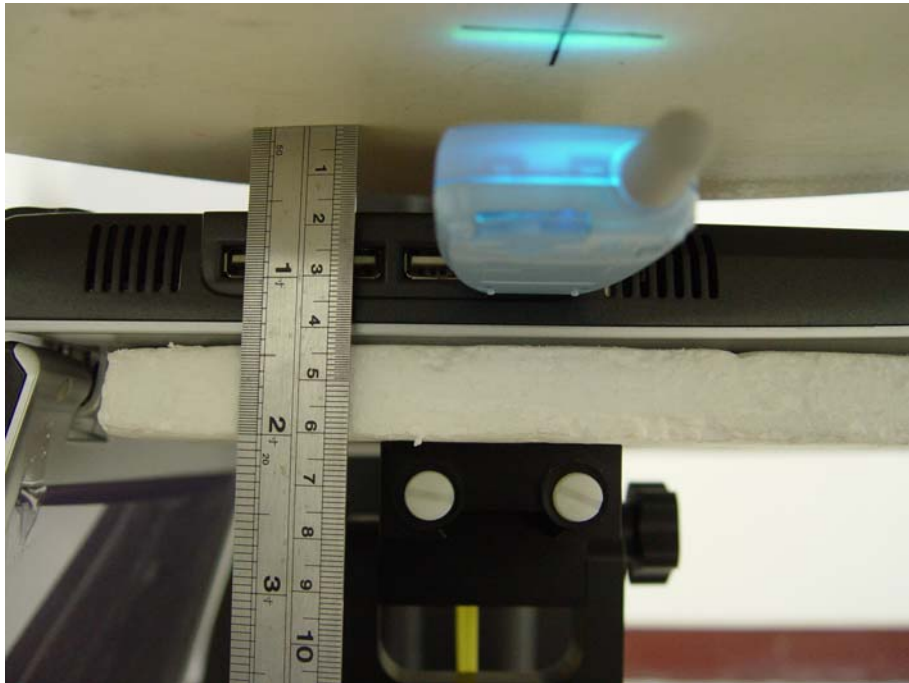

Fig. 9.5 i-Buddie

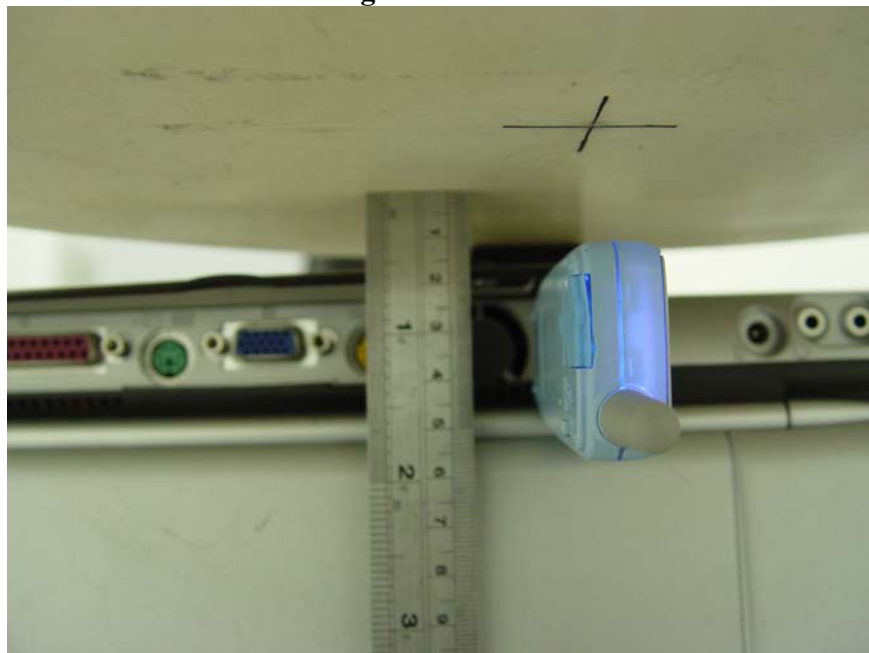

Fig. 9.6 COMPAQ

The third position is “NB Bottom Touch with Cable” shown in Fig. 9.7, Fig.9.8 and Fig.9.9. In this position, the bottom face of the NB is touched with the flat and the USB extension cable was used to connect the DUT and the NB. The cable is right angle up.



Fig. 9.7 DELL



Fig. 9.8 i-Buddie



Fig. 9.9 COMPAQ

10. Measurement Procedures

The measurement procedures are as follows:

- Plugging DUT into the notebook
- Linking DUT with base station simulator CMU200 in lowest channel for GSM or PCS band and setting RF utility for WLAN
- Setting PCL=5 for GSM and PCL=0 for PCS on CMU200 to allow DUT to radiate maximum output power
- Measuring output power through RF cable and power meter
- Placing the DUT in the positions described in the last section
- Setting scan area, grid size and other setting on the DASY4 software
- Taking data based on the testing algorithm in Fig. 3.3

According to the IEEE P1528 draft standard, the recommended procedure for assessing the peak spatial-average SAR value consists of the following steps:

- Power reference measurement
- Area scan
- Zoom scan
- Power reference measurement

10.1 Spatial Peak SAR Evaluation

The procedure for spatial peak SAR evaluation has been implemented according to the IEEE1528-200X standard. It can be conducted for 1g and 10g, as well as for user-specific masses. The DASY4 software includes all numerical procedures necessary to evaluate the spatial peak SAR value.

Base on the Draft: SCC-34, SC-2, WG-2-Computational Dosimetry, IEEE P1529/D0.0 (Draft Recommended Practice for Determining the Spatial-Peak Specific Absorption Rate (SAR) Associated with the Use of Wireless Handset-Computational techniques), a new algorithm has been implemented. The spatial-peak SAR can be computed over any required mass.

The base for the evaluation is a "cube" measurement. The measured volume must include the 1g and 10g cubes with the highest averaged SAR values. For that purpose , the center of the measured volume is aligned to the interpolated peak SAR value of a previously performed area scan.

The entire evaluation of the spatial peak values is performed within the postprocessing engine (SEMCAD). The system always gives the maximum values for the 1g and 10g cubes. The algorithm to find the cube with highest averaged SAR is divided into the following stages:

- extraction of the measured data (grid and values) from the Zoom Scan
- calculation of the SAR value at every measurement point based on all stored data (A/D values and measurement parameters)
- generation of a high-resolution mesh within the measured volume

- interpolation of all measured values from the measurement grid to the high-resolution grid
- extrapolation of the entire 3-D field distribution to the phantom surface over the distance from sensor to surface
- calculation of the averaged SAR within masses of 1g and 10g

10.2 Scan Procedures

First **Area Scan** is used to locate the approximate location(s) of the local peak SAR value(s). The measurement grid within an **Area Scan** is defined by the grid extent, grid step size and grid offset. Next, in order to determine the EM field distribution in a three-dimensional spatial extension, **Zoom Scan** is required. The **Zoom Scan** measures 5x5x7 points with step size 8, 8 and 5 mm. The **Zoom Scan** is performed around the highest E-field value to determine the averaged SAR-distribution over 1 g.

10.3 SAR Averaged Methods

In DASY4, the interpolation and extrapolation are both based on the modified Quadratic Shepard's method. The interpolation scheme combines a least-square fitted function method and a weighted average method which are the two basic types of computational interpolation and approximation. Extrapolation routines are used to obtain SAR values between the lowest measurement points and the inner phantom surface. The extrapolation distance is determined by the surface detection distance and the probe sensor offset. The uncertainty increases with the extrapolation distance. To keep the uncertainty within 1% for the 1 g and 10 g cubes, the extrapolation distance should not be larger than 5 mm.

11.SAR Test Results

11.1 NB BTM Touch

Hosts	Bands	Chan.	Freq (MHz)	Modulation Type	Conducte d Power (dBm)	Power Drift (dB)	Measured 1g SAR (W/kg)	Limit (W/kg)	Results
DELL	GSM	128	824.2 (Low)	GMSK	27.2	0.07	0.1480	1.6	Pass
		189	836.4 (Mid)	GMSK	27.3	-0.10	0.1790	1.6	Pass
		251	848.8 (High)	GMSK	27.5	0.06	0.1470	1.6	Pass
	PCS	512	1850.2 (Low)	GMSK	28.1	-0.10	1.0400	1.6	Pass
		661	1880.0 (Mid)	GMSK	27.9	-0.06	0.5770	1.6	Pass
		810	1909.8 (High)	GMSK	28.3	-0.10	0.8020	1.6	Pass
i-Buddie	GSM	128	824.2 (Low)	GMSK	27.2	-	-	-	-
		189	836.4 (Mid)	GMSK	27.3	0.200	0.1040	1.6	Pass
		251	848.8 (High)	GMSK	27.5	-	-	-	-
	PCS	512	1850.2 (Low)	GMSK	28.1	0.020	0.5060	1.6	Pass
		661	1880.0 (Mid)	GMSK	27.9	-0.008	0.6520	1.6	Pass
		810	1909.8 (High)	GMSK	28.3	-0.030	1.0	1.6	Pass
COMPAQ	GSM	128	824.2 (Low)	GMSK	27.2	-	-	-	-
		189	836.4 (Mid)	GMSK	27.3	-0.010	0.0789	1.6	Pass
		251	848.8 (High)	GMSK	27.5	-	-	-	-
	PCS	512	1850.2 (Low)	GMSK	28.1	-	-	-	-
		661	1880.0 (Mid)	GMSK	27.9	-0.010	0.5350	1.6	Pass
		810	1909.8 (High)	GMSK	28.3	-	-	-	-

11.2 NB BTM With 1.5 CM Gap

Hosts	Bands	Chan.	Freq (MHz)	Modulation Type	Conducted Power (dBm)	Power Drift (dB)	Measured 1g SAR (W/kg)	Limit (W/kg)	Results
DELL	GSM	128	824.2 (Low)	GMSK	27.2	-	-	-	-
		189	836.4 (Mid)	GMSK	27.3	0.20	0.0593	1.6	Pass
		251	848.8 (High)	GMSK	27.5	-	-	-	-
	PCS	512	1850.2 (Low)	GMSK	28.1	-	-	-	-
		661	1880.0 (Mid)	GMSK	27.9	-0.10	0.2000	1.6	Pass
		810	1909.8 (High)	GMSK	28.3	-	-	-	-
i-Buddie	GSM	128	824.2 (Low)	GMSK	27.2	-	-	-	-
		189	836.4 (Mid)	GMSK	27.3	-	-	-	-
		251	848.8 (High)	GMSK	27.5	-	-	-	-
	PCS	512	1850.2 (Low)	GMSK	28.1	-	-	-	-
		661	1880.0 (Mid)	GMSK	27.9	0.04	0.1860	1.6	Pass
		810	1909.8 (High)	GMSK	28.3	-	-	-	-
COMPAQ	GSM	128	824.2 (Low)	GMSK	27.2	-	-	-	-
		189	836.4 (Mid)	GMSK	27.3	-	-	-	-
		251	848.8 (High)	GMSK	27.5	-	-	-	-
	PCS	512	1850.2 (Low)	GMSK	28.1	-	-	-	-
		661	1880.0 (Mid)	GMSK	27.9	-0.03	0.1390	1.6	Pass
		810	1909.8 (High)	GMSK	28.3	-	-	-	-

11.3 NB BTM Touch With Cable

Hosts	Bands	Chan.	Freq (MHz)	Modulation Type	Conducte d Power (dBm)	Power Drift (dB)	Measured 1g SAR (W/kg)	Limit (W/kg)	Results
DELL	GSM	128	824.2 (Low)	GMSK	27.2	-	-	-	-
		189	836.4 (Mid)	GMSK	27.3	-0.01	0.0480	1.6	Pass
		251	848.8 (High)	GMSK	27.5	-	-	-	-
	PCS	512	1850.2 (Low)	GMSK	28.1	-	-	-	-
		661	1880.0 (Mid)	GMSK	27.9	-0.05	0.0640	1.6	Pass
		810	1909.8 (High)	GMSK	28.3	-	-	-	-
i-Buddie	GSM	128	824.2 (Low)	GMSK	27.2	-	-	-	-
		189	836.4 (Mid)	GMSK	27.3	-	-	-	-
		251	848.8 (High)	GMSK	27.5	-	-	-	-
	PCS	512	1850.2 (Low)	GMSK	28.1	-	-	-	-
		661	1880.0 (Mid)	GMSK	27.9	-0.20	0.0219	1.6	Pass
		810	1909.8 (High)	GMSK	28.3	-	-	-	-
COMPAQ	GSM	128	824.2 (Low)	GMSK	27.2	-	-	-	-
		189	836.4 (Mid)	GMSK	27.3	-	-	-	-
		251	848.8 (High)	GMSK	27.5	-	-	-	-
	PCS	512	1850.2 (Low)	GMSK	28.1	-	-	-	-
		661	1880.0 (Mid)	GMSK	27.9	-0.30	0.0478	1.6	Pass
		810	1909.8 (High)	GMSK	28.3	-	-	-	-

12. References

- [1] FCC 47 CFR Part 2 “Frequency Allocations and Radio Treaty Matters; General Rules and Regulations”
- [2] IEEE Std. 1528-200X, Draft CD 1.1 “ Recommended Practice for Determining the Spatial-Peak Specific Absorption Rate (SAR) in the Human Body Due to Wireless Communications Devices: Experimental Techniques”, December 2002
- [3] Supplement C (Edition 01-10) to OET Bulletin 65 (Edition 97-01), “Additional Information for Evaluating Compliance of Mobile and Portable Devices with FCC Limits for Human Exposure to RF Emissions”, June 2001
- [4] IEEE Std. C95.3, “IEEE Recommended Practice for the Measurement of Potentially Hazardous Electromagnetic Fields-RF and Microwave”, 1991
- [5] IEEE Std. C95.1, “IEEE Standard for Safety Levels with Respect to Human Exposure to Radio Frequency Electromagnetic Fields, 3 kHz to 300 GHz”, 1999
- [6] Robert J. Renka, “Multivariate Interpolation Of Large Sets Of Scattered Data”, University of North Texas ACM Transactions on Mathematical Software, vol. 14, no. 2, June 1988, pp. 139-148
- [7] DAYS4 System Handbook

Appendix A - System Performance Check Data

Date/Time: 03/15/04 11:10:34

Test Laboratory: SPORTON

850MHz Diploe System Calibration

DUT: Dipole 835 MHz; Type: D835V2; Serial: D835V2 - SN:499
Program Name: System Performance Check

Communication System: CW; Frequency: 835 MHz;Duty Cycle: 1:1
 Medium: MSL850 ($\sigma = 0.998$ mho/m, $\epsilon_r = 57.1301$, $\rho = 1000$ kg/m³)
 Phantom section: Flat Section; Ambient Temp=21~23C; Liquid Temp=21.5C; Liquid height=15.2cm

DASY4 Configuration:
 - Probe: ET3DV6 - SN1788; ConvF(6.5, 6.5, 6.5); Calibrated: 8/29/2003
 - Sensor-Surface: 4mm (Mechanical And Optical Surface Detection)
 - Electronics: DAE3 Sn577; Calibrated: 11/21/2003
 - Phantom: SAM 12; Type: QD 000 P40 C; Serial: TP-1150
 - Measurement SW: DASY4, V4.1 Build 47; Postprocessing SW: SEMCAD, V1.6 Build 116

Pin = 100mW; d = 15mm/Area Scan (81x141x1): Measurement grid: dx=15mm, dy=15mm
 Reference Value = 33.9 V/m
 Power Drift = -0.03 dB
 Maximum value of SAR = 1.06 mW/g

Pin = 100mW; d = 15mm/Zoom Scan (7x7x7)/Cube 0: Measurement grid: dx=5mm, dy=5mm, dz=5mm
 Peak SAR (extrapolated) = 1.4 W/kg
 SAR(1 g) = 0.987 mW/g; SAR(10 g) = 0.644 mW/g
 Reference Value = 33.9 V/m
 Power Drift = -0.03 dB
 Maximum value of SAR = 1.06 mW/g

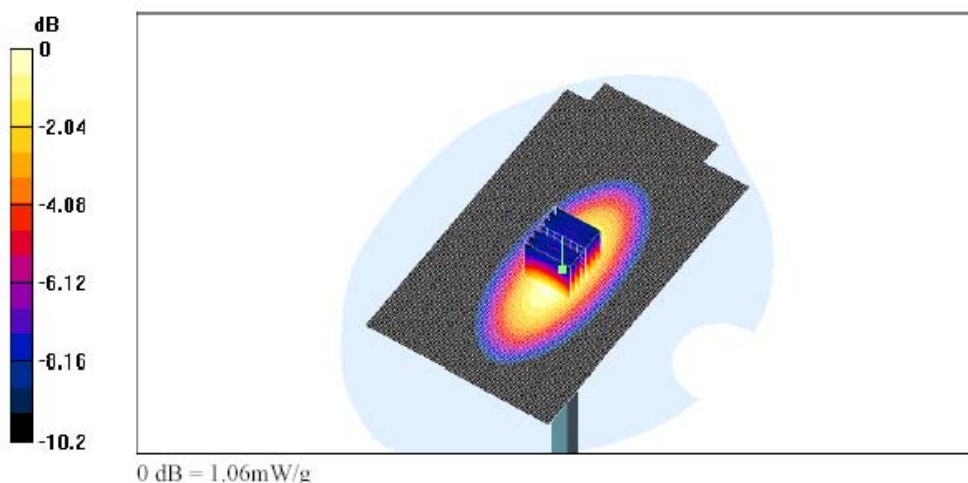

Date/Time: 03/16/04 11:19:34

Test Laboratory: SPORTON

1900MHz Dipole System Calibration

DUT: Dipole 1900 MHz; Type: D1900V2; Serial: D1900V2 - SN:5d041
Program Name: System Performance Check

Communication System: CW; Frequency: 1900 MHz; Duty Cycle: 1:1
Medium: MSL1900 ($\sigma = 1.5638 \text{ mho/m}$, $\epsilon_r = 52.1856$, $\rho = 1000 \text{ kg/m}^3$)
Phantom section: Flat Section; Ambient Temp=21~23C; Liquid Temp=21.5C; Liquid height=15.2cm

DASY4 Configuration:
- Probe: ET3DV6 - SN1788; ConvF(5, 5, 5); Calibrated: 8/29/2003
- Sensor-Surface: 4mm (Mechanical And Optical Surface Detection)
- Electronics: DAE3 Sn577; Calibrated: 11/21/2003
- Phantom: SAM 12; Type: QD 000 P40 C; Serial: TP-1150
- Measurement SW: DASY4, V4.1 Build 47; Postprocessing SW: SEMCAD, V1.6 Build 116

Pin = 100mW; d = 10mm/Area Scan (51x51x1): Measurement grid: dx=15mm, dy=15mm
Reference Value = 58.2 V/m
Power Drift = -0.02 dB
Maximum value of SAR = 4.51 mW/g

Pin = 100mW; d = 10mm/Zoom Scan (7x7x7)/Cube 0: Measurement grid: dx=5mm, dy=5mm, dz=5mm
Peak SAR (extrapolated) = 6.22 W/kg
SAR(1 g) = 3.98 mW/g; SAR(10 g) = 1.93 mW/g
Reference Value = 58.2 V/m
Power Drift = -0.02 dB
Maximum value of SAR = 4.35 mW/g

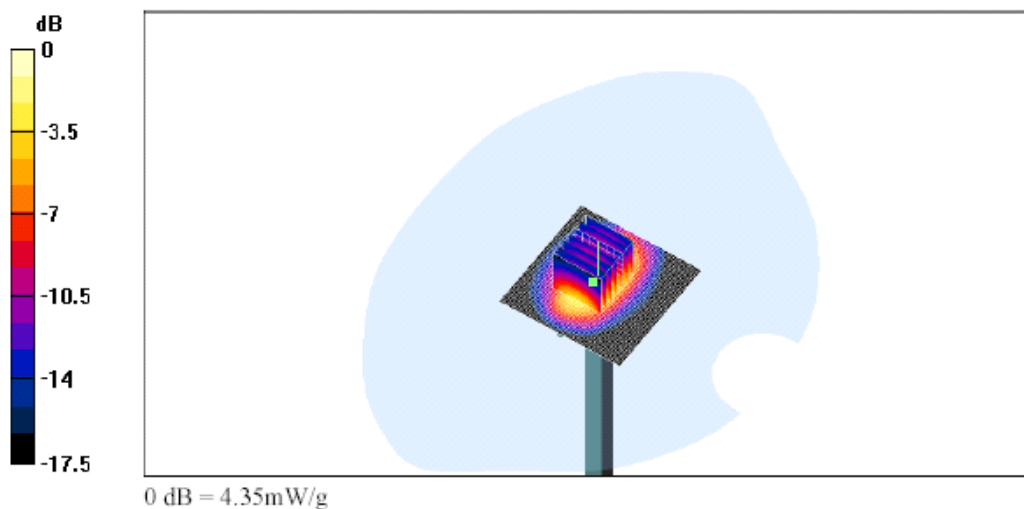

Appendix B - SAR Measurement

Date/Time: 03/15/04 17:20:46

Test Laboratory: SPORTON

DELL NB BTM Touch CH 189

DUT: soloman
Program Name: NB BTM Touch

Communication System: GSM 850; Frequency: 836.4 MHz; Duty Cycle: 1:8.3
Medium: MSL850 ($\sigma = 1.00018$ mho/m, $\epsilon_r = 57.1183$, $\rho = 1000$ kg/m³)
Phantom section: Flat Section; Ambient Temp=21~23C; Liquid Temp=21.5C; Liquid height=15.2cm

DASY4 Configuration:
- Probe: ET3DV6 - SN1788; ConvF(6.5, 6.5, 6.5); Calibrated: 8/29/2003
- Sensor-Surface: 4mm (Mechanical Surface Detection)
- Electronics: DAE3 Sn577; Calibrated: 11/21/2003
- Phantom: SAM 12; Type: QD 000 P40 C; Serial: TP-1150
- Measurement SW: DASY4, V4.1 Build 47; Postprocessing SW: SEMCAD, V1.6 Build 116

CH 189 836.4MHz/Area Scan (81x81x1): Measurement grid: dx=10mm, dy=10mm
Reference Value = 12.7 V/m
Power Drift = -0.1 dB
Maximum value of SAR = 0.166 mW/g

CH 189 836.4MHz/Zoom Scan (5x5x7)/Cube 0: Measurement grid: dx=8mm, dy=8mm, dz=5mm
Peak SAR (extrapolated) = 0.259 W/kg
SAR(1 g) = 0.179 mW/g; SAR(10 g) = 0.114 mW/g
Reference Value = 12.7 V/m
Power Drift = -0.1 dB
Maximum value of SAR = 0.191 mW/g

CH 189 836.4MHz/Zoom Scan (5x5x7)/Cube 1: Measurement grid: dx=8mm, dy=8mm, dz=5mm
Peak SAR (extrapolated) = 0.243 W/kg
SAR(1 g) = 0.146 mW/g; SAR(10 g) = 0.0898 mW/g
Reference Value = 12.7 V/m
Power Drift = -0.1 dB
Maximum value of SAR = 0.155 mW/g

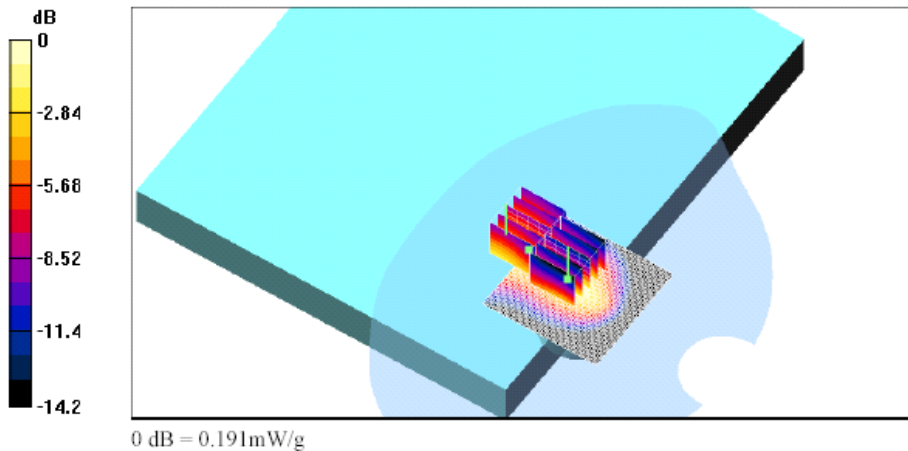

Date/Time: 03/15/04 20:56:48

Test Laboratory: SPORTON

i-Buddie NB BTM Touch CH 189

DUT: soloman

Program Name: NB BTM Touch

Communication System: GSM 850; Frequency: 836.4 MHz; Duty Cycle: 1:8.3

Medium: MSL850 ($\sigma = 1.00018$ mho/m, $\epsilon_r = 57.1183$, $\rho = 1000$ kg/m³)

Phantom section: Flat Section; Ambient Temp=21~23C; Liquid Temp=21.5C; Liquid height=15.2cm

DASY4 Configuration:

- Probe: ET3DV6 - SN1788; ConvF(6.5, 6.5, 6.5); Calibrated: 8/29/2003
- Sensor-Surface: 4mm (Mechanical Surface Detection)
- Electronics: DAE3 Sn577; Calibrated: 11/21/2003
- Phantom: SAM 12; Type: QD 000 P40 C; Serial: TP-1150
- Measurement SW: DASY4, V4.1 Build 47; Postprocessing SW: SEMCAD, V1.6 Build 116

CH 189 836.4MHz/Area Scan (81x81x1): Measurement grid: dx=10mm, dy=10mm

Reference Value = 6.13 V/m

Power Drift = 0.2 dB

Maximum value of SAR = 0.106 mW/g

CH 189 836.4MHz/Zoom Scan (5x5x7)/Cube 0: Measurement grid: dx=8mm, dy=8mm, dz=5mm

Peak SAR (extrapolated) = 0.15 W/kg

SAR(1 g) = 0.104 mW/g; SAR(10 g) = 0.0679 mW/g

Reference Value = 6.13 V/m

Power Drift = 0.2 dB

Maximum value of SAR = 0.113 mW/g

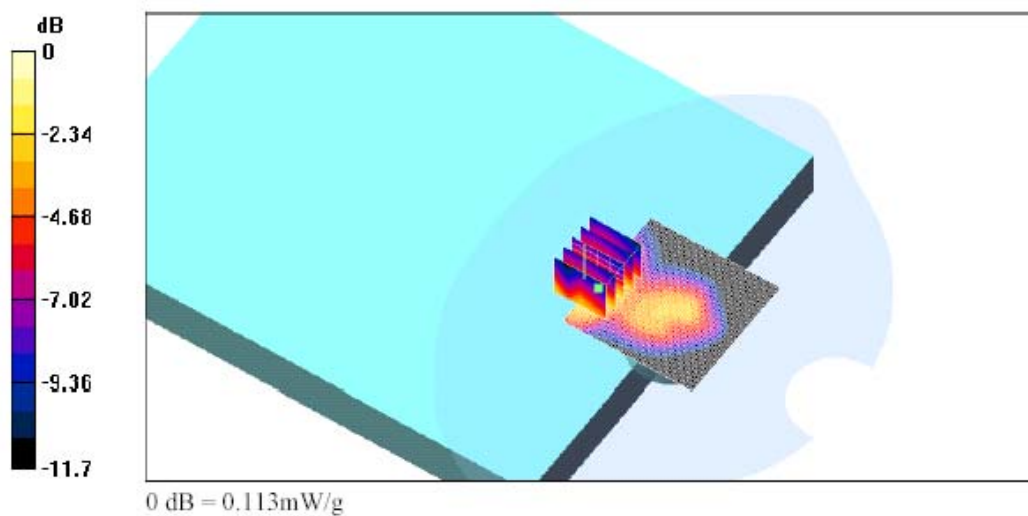

Date/Time: 03/15/04 20:26:08

Test Laboratory: SPORTON

COMPAQ NB BTM Touch

DUT: soloman

Program Name: NB BTM Touch

Communication System: GSM 850; Frequency: 836.4 MHz;Duty Cycle: 1:8.3

Medium: MSL850 ($\sigma = 1.00018$ mho/m, $\epsilon_r = 57.1183$, $\rho = 1000$ kg/m³)

Phantom section: Flat Section;Ambient Temp=21~23C; Liquid Temp=21.5C; Liquid height=15.2cm

DASY4 Configuration:

- Probe: ET3DV6 - SN1788; ConvF(6.5, 6.5, 6.5); Calibrated: 8/29/2003
- Sensor-Surface: 4mm (Mechanical Surface Detection)
- Electronics: DAE3 Sn577; Calibrated: 11/21/2003
- Phantom: SAM 12; Type: QD 000 P40 C; Serial: TP-1150
- Measurement SW: DASY4, V4.1 Build 47; Postprocessing SW: SEMCAD, V1.6 Build 116

CH 189 836.4MHz/Area Scan (81x81x1): Measurement grid: dx=10mm, dy=10mm

Reference Value = 6.88 V/m

Power Drift = -0.01 dB

Maximum value of SAR = 0.0841 mW/g

CH 189 836.4MHz/Zoom Scan (5x5x7)/Cube 0: Measurement grid: dx=8mm, dy=8mm, dz=5mm

Peak SAR (extrapolated) = 0.136 W/kg

SAR(1 g) = 0.0789 mW/g; SAR(10 g) = 0.0517 mW/g

Reference Value = 6.88 V/m

Power Drift = -0.01 dB

Maximum value of SAR = 0.0843 mW/g

CH 189 836.4MHz/Zoom Scan (5x5x7)/Cube 1: Measurement grid: dx=8mm, dy=8mm, dz=5mm

Peak SAR (extrapolated) = 0.166 W/kg

SAR(1 g) = 0.0729 mW/g; SAR(10 g) = 0.0401 mW/g

Reference Value = 6.88 V/m

Power Drift = -0.01 dB

Maximum value of SAR = 0.079 mW/g

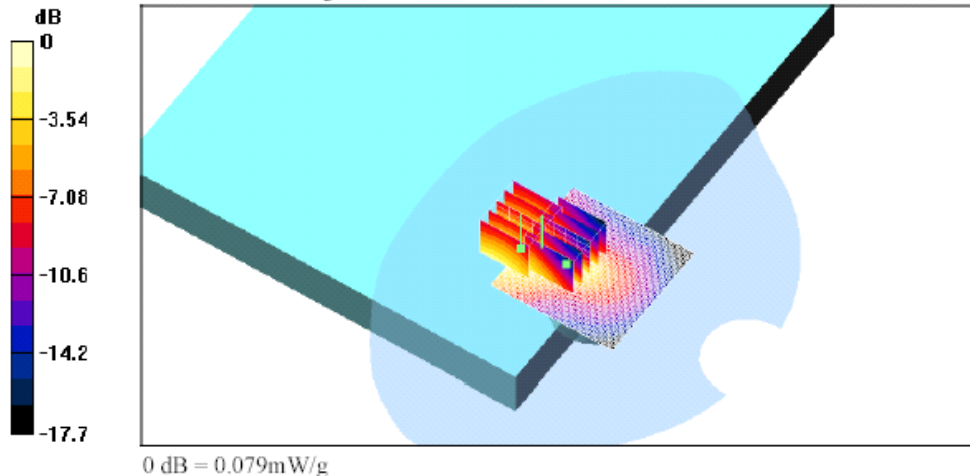

Date/Time: 03/16/04 15:13:14

Test Laboratory: SPORTON

DELL NB BTM Touch CH 512

DUT: soloman

Program Name: NB BTM Touch

Communication System: DCS 1900; Frequency: 1850.2 MHz; Duty Cycle: 1:8.3

Medium: MSL1900 ($\sigma = 1.51025$ mho/m, $\epsilon_r = 52.1541$, $\rho = 1000$ kg/m³)

Phantom section: Flat Section; Ambient Temp=21~23C; Liquid Temp=21.5C; Liquid height=15.2cm

DASY4 Configuration:

- Probe: ET3DV6 - SN1788; ConvF(5, 5, 5); Calibrated: 8/29/2003
- Sensor-Surface: 4mm (Mechanical And Optical Surface Detection)
- Electronics: DAE3 Sn577; Calibrated: 11/21/2003
- Phantom: SAM 12; Type: QD 000 P40 C; Serial: TP-1150
- Measurement SW: DASY4, V4.1 Build 47; Postprocessing SW: SEMCAD, V1.6 Build 116

CH 512 1850.2MHz-LOW/Area Scan (81x81x1): Measurement grid: dx=10mm, dy=10mm

Reference Value = 17.3 V/m

Power Drift = -0.1 dB

Maximum value of SAR = 1.12 mW/g

CH 512 1850.2MHz-LOW/Zoom Scan (5x5x7)/Cube 0: Measurement grid: dx=8mm, dy=8mm, dz=5mm

Peak SAR (extrapolated) = 1.86 W/kg

SAR(1 g) = 1.04 mW/g; SAR(10 g) = 0.572 mW/g

Reference Value = 17.3 V/m

Power Drift = -0.1 dB

Maximum value of SAR = 1.13 mW/g

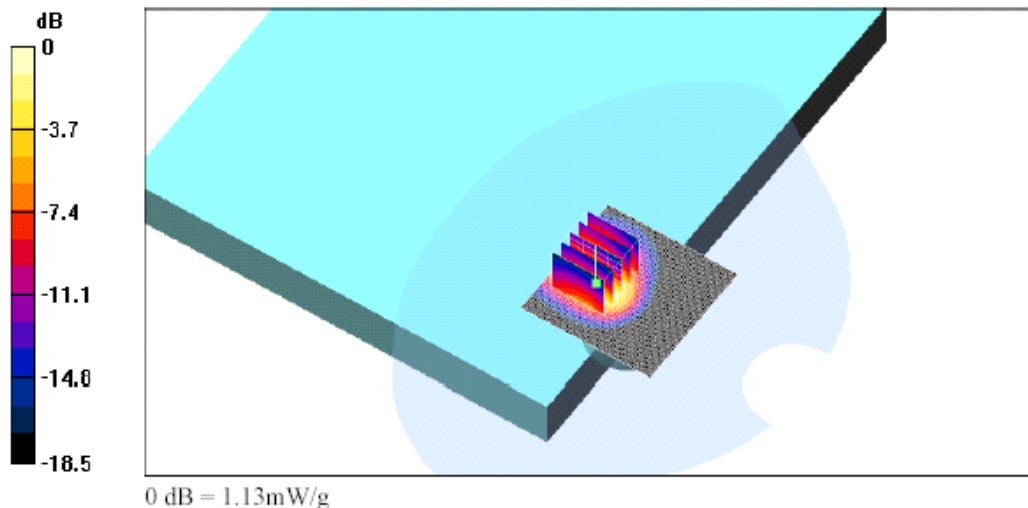

Date/Time: 03/16/04 17:30:02

Test Laboratory: SPORTON

i-Buddie NB BTM Touch CH 810

DUT: soloman

Program Name: NB BTM Touch

Communication System: DCS 1900; Frequency: 1909.8 MHz; Duty Cycle: 1:8.3

Medium: MSL1900 ($\sigma = 1.51891$ mho/m, $\epsilon_r = 52.0985$, $\rho = 1000$ kg/m³)

Phantom section: Flat Section; Ambient Temp=21~23C; Liquid Temp=21.5C; Liquid height=15.2cm

DASY4 Configuration:

- Probe: ET3DV6 - SN1788; ConvF(5, 5, 5); Calibrated: 8/29/2003
- Sensor-Surface: 4mm (Mechanical And Optical Surface Detection)
- Electronics: DAE3 Sn577; Calibrated: 11/21/2003
- Phantom: SAM 12; Type: QD 000 P40 C; Serial: TP-1150
- Measurement SW: DASY4, V4.1 Build 47; Postprocessing SW: SEMCAD, V1.6 Build 116

CH 810 1909.8MHz-High/Area Scan (81x81x1): Measurement grid: dx=10mm, dy=10mm

Reference Value = 19.8 V/m

Power Drift = -0.03 dB

Maximum value of SAR = 1.12 mW/g

CH 810 1909.8MHz-High/Zoom Scan (5x5x7)/Cube 0: Measurement grid: dx=8mm, dy=8mm, dz=5mm

Peak SAR (extrapolated) = 1.83 W/kg

SAR(1 g) = 1 mW/g; SAR(10 g) = 0.507 mW/g

Reference Value = 19.8 V/m

Power Drift = -0.03 dB

Maximum value of SAR = 1.11 mW/g

CH 810 1909.8MHz-High/Zoom Scan (5x5x7)/Cube 1: Measurement grid: dx=8mm, dy=8mm, dz=5mm

Peak SAR (extrapolated) = 1.72 W/kg

SAR(1 g) = 0.8 mW/g; SAR(10 g) = 0.413 mW/g

Reference Value = 19.8 V/m

Power Drift = -0.03 dB

Maximum value of SAR = 1.06 mW/g

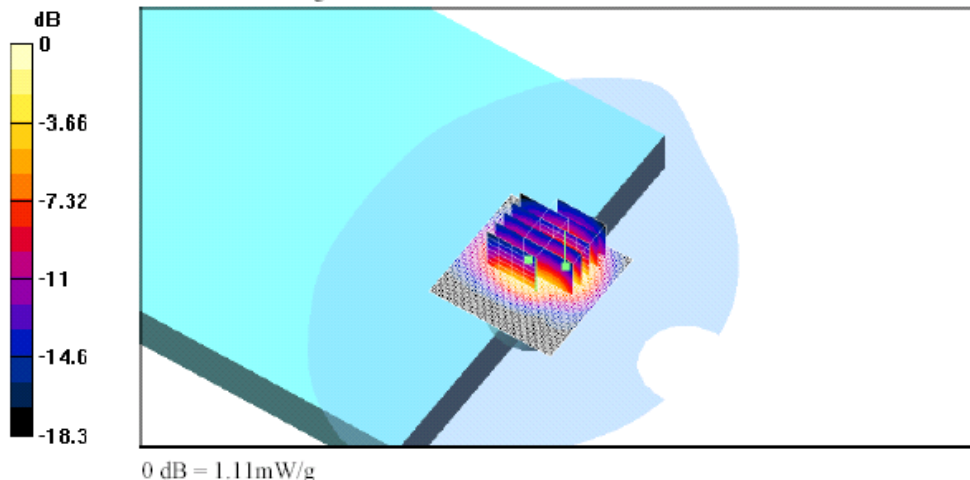

Date/Time: 03/16/04 20:17:30

Test Laboratory: SPORTON

COMPAQ NB BTM Touch CH 661

DUT: soloman

Program Name: NB BTM Touch

Communication System: DCS 1900; Frequency: 1880 MHz; Duty Cycle: 1:8.3

Medium: MSL1900 ($\sigma = 1.58222$ mho/m, $\epsilon_r = 52.5119$, $\rho = 1000$ kg/m³)

Phantom section: Flat Section; Ambient Temp=21~23C; Liquid Temp=21.5C; Liquid height=15.2cm

DASY4 Configuration:

- Probe: ET3DV6 - SN1788; ConvF(5, 5, 5); Calibrated: 8/29/2003
- Sensor-Surface: 4mm (Mechanical And Optical Surface Detection)
- Electronics: DAE3 Sn577; Calibrated: 11/21/2003
- Phantom: SAM 12; Type: QD 000 P40 C; Serial: TP-1150
- Measurement SW: DASY4, V4.1 Build 47; Postprocessing SW: SEMCAD, V1.6 Build 116

CH 661 1880.0MHz-Middle/Area Scan (81x81x1): Measurement grid: dx=10mm, dy=10mm

Reference Value = 17.9 V/m

Power Drift = -0.01 dB

Maximum value of SAR = 0.621 mW/g

CH 661 1880.0MHz-Middle/Zoom Scan (5x5x7)/Cube 0: Measurement grid: dx=8mm, dy=8mm, dz=5mm

Peak SAR (extrapolated) = 0.937 W/kg

SAR(1 g) = 0.535 mW/g; SAR(10 g) = 0.277 mW/g

Reference Value = 17.9 V/m

Power Drift = -0.01 dB

Maximum value of SAR = 0.597 mW/g

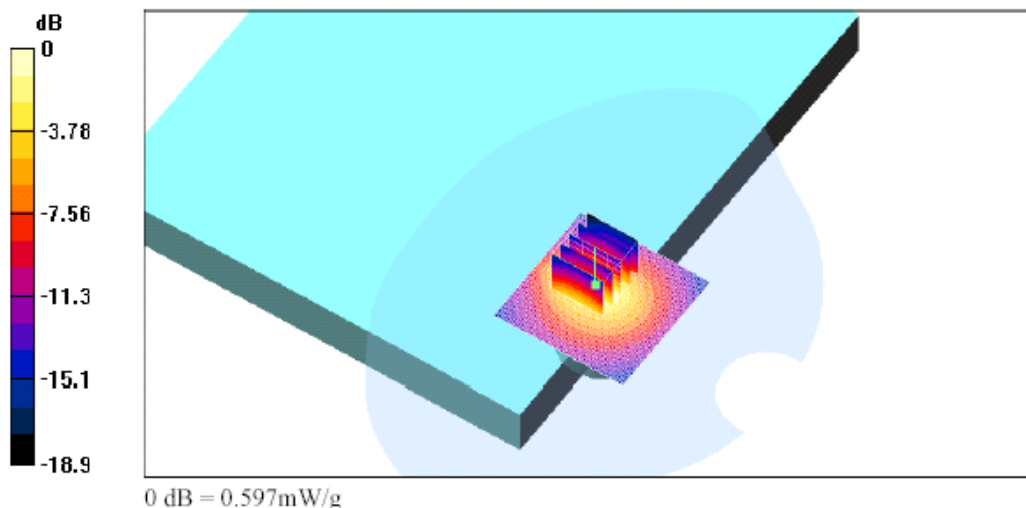

Date/Time: 03/16/04 15:13:14

Test Laboratory: SPORTON

DELL NB BTM Touch CH 512

DUT: soloman

Program Name: NB BTM Touch

Communication System: DCS 1900; Frequency: 1850.2 MHz; Duty Cycle: 1:8.3

Medium: MSL1900 ($\sigma = 1.51025$ mho/m, $\epsilon_r = 52.1541$, $\rho = 1000$ kg/m³)

Phantom section: Flat Section; Ambient Temp=21~23C; Liquid Temp=21.5C; Liquid height=15.2cm

DASY4 Configuration:

- Probe: ET3DV6 - SN1788; ConvF(5, 5, 5); Calibrated: 8/29/2003

- Sensor-Surface: 4mm (Mechanical And Optical Surface Detection)

- Electronics: DAE3 Sn577; Calibrated: 11/21/2003

- Phantom: SAM 12; Type: QD 000 P40 C; Serial: TP-1150

- Measurement SW: DASY4, V4.1 Build 47; Postprocessing SW: SEMCAD, V1.6 Build 116

CH 512 1850.2MHz-LOW/Area Scan (81x81x1): Measurement grid: dx=10mm, dy=10mm

Reference Value = 17.3 V/m

Power Drift = -0.1 dB

Maximum value of SAR = 1.12 mW/g

CH 512 1850.2MHz-LOW/Zoom Scan (5x5x7)/Cube 0: Measurement grid: dx=8mm, dy=8mm, dz=5mm

Peak SAR (extrapolated) = 1.86 W/kg

SAR(1 g) = 1.04 mW/g; SAR(10 g) = 0.572 mW/g

Reference Value = 17.3 V/m

Power Drift = -0.1 dB

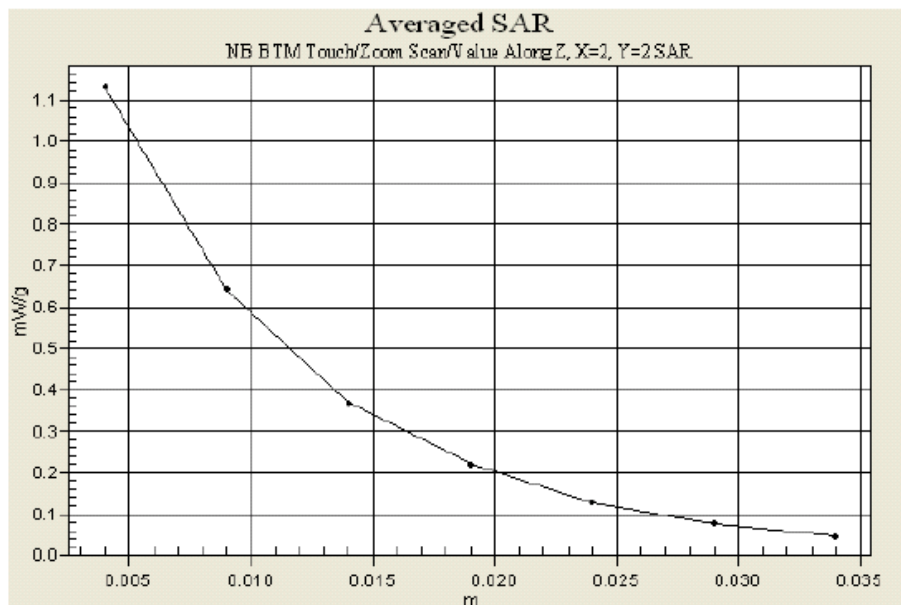

Maximum value of SAR = 1.13 mW/g



Appendix C – Calibration Data

Calibration Laboratory of
Schmid & Partner
Engineering AG
Zeughausstrasse 43, 8004 Zurich, Switzerland

Client **Sproton Int. (Auden)**

CALIBRATION CERTIFICATE			
Object(s)	D835V2 - SN:499		
Calibration procedure(s)	QA CAL-05 v2 Calibration procedure for dipole validation kits		
Calibration date:	February 12, 2004		
Condition of the calibrated item	In Tolerance (according to the specific calibration document)		
This calibration statement documents traceability of M&TE used in the calibration procedures and conformity of the procedures with the ISO/IEC 17025 international standard.			
All calibrations have been conducted in the closed laboratory facility: environment temperature 22 +/- 2 degrees Celsius and humidity < 75%.			
Calibration Equipment used (M&TE critical for calibration)			
Model Type	ID #	Cal Date (Calibrated by, Certificate No.)	Scheduled Calibration
Power meter EPM E442	GB37480704	6-Nov-03 (METAS, No. 252-0254)	Nov-04
Power sensor HP 8481A	US37292783	6-Nov-03 (METAS, No. 252-0254)	Nov-04
Power sensor HP 8481A	MY41092317	18-Oct-02 (Agilent, No. 20021018)	Oct-04
RF generator R&S 3ML-03	100698	27-Mar-2002 (R&S, No. 20-92309)	In house check: Mar-05
Network Analyzer HP 8753E	US37390585	18-Oct-01 (SPEAG, in house check Nov-03)	In house check: Oct 05
Calibrated by:	Name Judith Mueller	Function Technician	Signature 
Approved by:	Name Katja Pokovic	Function Laboratory Director	Signature 
Date issued: February 18, 2004			
This calibration certificate is issued as an intermediate solution until the accreditation process (based on ISO/IEC 17025 International Standard) for Calibration Laboratory of Schmid & Partner Engineering AG is completed.			

Schmid & Partner Engineering AG

s p e a g

Zeughausstrasse 43, 8004 Zurich, Switzerland
Phone +41 1 245 9700, Fax +41 1 245 9779
info@speag.com, <http://www.speag.com>

DASY

Dipole Validation Kit

Type: D835V2

Serial: 499

Manufactured: July 10, 2003
Calibrated: February 12, 2004