



RADIO TEST REPORT

Test Report No. : 13720933H

Applicant : TOYOTA MOTOR CORPORATION
Type of EUT : Smart LF Oscillator
Model Number of EUT : TS-GTY
FCC ID : NI4TS-GTY
Test regulation : FCC Part 15 Subpart C: 2021
Test Result : Complied (Refer to SECTION 3)

1. This test report shall not be reproduced in full or partial, without the written approval of UL Japan, Inc.
2. The results in this report apply only to the sample tested.
3. This sample tested is in compliance with the limits of the above regulation.
4. The test results in this test report are traceable to the national or international standards.
5. This test report must not be used by the customer to claim product certification, approval, or endorsement by the A2LA accreditation body.
6. This test report covers Radio technical requirements. It does not cover administrative issues such as Manual or non-Radio test related Requirements. (if applicable)
7. The all test items in this test report are conducted by UL Japan, Inc. Ise EMC Lab.
8. The opinions and the interpretations to the result of the description in this report are outside scopes where UL Japan has been accredited.
9. The information provided from the customer for this report is identified in Section 1.

Date of test: March 24, 2021

Representative test engineer: 
Akihiko Maeda
Engineer
Consumer Technology Division

Approved by: 
Motoya Imura
Leader
Consumer Technology Division



CERTIFICATE 5107.02

- The testing in which "Non-accreditation" is displayed is outside the accreditation scopes in UL Japan.
 There is no testing item of "Non-accreditation".

UL Japan, Inc.
Ise EMC Lab.

4383-326 Asama-cho, Ise-shi, Mie-ken 516-0021 JAPAN
Telephone : +81 596 24 8999
Facsimile : +81 596 24 8124

REVISION HISTORY

Original Test Report No.: 13720933H

Revision	Test report No.	Date	Page revised	Contents
- (Original)	13720933H	April 19, 2021	-	-

UL Japan, Inc.

Ise EMC Lab.

4383-326 Asama-cho, Ise-shi, Mie-ken 516-0021 JAPAN

Telephone : +81 596 24 8999

Facsimile : +81 596 24 8124

Reference: Abbreviations (Including words undescribed in this report)

A2LA	The American Association for Laboratory Accreditation	MCS	Modulation and Coding Scheme
AC	Alternating Current	MRA	Mutual Recognition Arrangement
AFH	Adaptive Frequency Hopping	N/A	Not Applicable
AM	Amplitude Modulation	NIST	National Institute of Standards and Technology
Amp, AMP	Amplifier	NS	No signal detect.
ANSI	American National Standards Institute	NSA	Normalized Site Attenuation
Ant, ANT	Antenna	NVLAP	National Voluntary Laboratory Accreditation Program
AP	Access Point	OBW	Occupied Band Width
ASK	Amplitude Shift Keying	OFDM	Orthogonal Frequency Division Multiplexing
Atten., ATT	Attenuator	P/M	Power meter
AV	Average	PCB	Printed Circuit Board
BPSK	Binary Phase-Shift Keying	PER	Packet Error Rate
BR	Bluetooth Basic Rate	PHY	Physical Layer
BT	Bluetooth	PK	Peak
BT LE	Bluetooth Low Energy	PN	Pseudo random Noise
BW	BandWidth	PRBS	Pseudo-Random Bit Sequence
Cal Int	Calibration Interval	PSD	Power Spectral Density
CCK	Complementary Code Keying	QAM	Quadrature Amplitude Modulation
Ch., CH	Channel	QP	Quasi-Peak
CISPR	Comite International Special des Perturbations Radioelectriques	QPSK	Quadri-Phase Shift Keying
CW	Continuous Wave	RBW	Resolution Band Width
DBPSK	Differential BPSK	RDS	Radio Data System
DC	Direct Current	RE	Radio Equipment
D-factor	Distance factor	RF	Radio Frequency
DFS	Dynamic Frequency Selection	RMS	Root Mean Square
DQPSK	Differential QPSK	RSS	Radio Standards Specifications
DSSS	Direct Sequence Spread Spectrum	Rx	Receiving
EDR	Enhanced Data Rate	SA, S/A	Spectrum Analyzer
EIRP, e.i.r.p.	Equivalent Isotropically Radiated Power	SG	Signal Generator
EMC	ElectroMagnetic Compatibility	SVSWR	Site-Voltage Standing Wave Ratio
EMI	ElectroMagnetic Interference	TR	Test Receiver
EN	European Norm	Tx	Transmitting
ERP, e.r.p.	Effective Radiated Power	VBW	Video BandWidth
EU	European Union	Vert.	Vertical
EUT	Equipment Under Test	WLAN	Wireless LAN
Fac.	Factor		
FCC	Federal Communications Commission		
FHSS	Frequency Hopping Spread Spectrum		
FM	Frequency Modulation		
Freq.	Frequency		
FSK	Frequency Shift Keying		
GFSK	Gaussian Frequency-Shift Keying		
GNSS	Global Navigation Satellite System		
GPS	Global Positioning System		
Hori.	Horizontal		
ICES	Interference-Causing Equipment Standard		
IEC	International Electrotechnical Commission		
IEEE	Institute of Electrical and Electronics Engineers		
IF	Intermediate Frequency		
ILAC	International Laboratory Accreditation Conference		
ISED	Innovation, Science and Economic Development Canada		
ISO	International Organization for Standardization		
JAB	Japan Accreditation Board		
LAN	Local Area Network		
LIMS	Laboratory Information Management System		

UL Japan, Inc.

Ise EMC Lab.

4383-326 Asama-cho, Ise-shi, Mie-ken 516-0021 JAPAN

Telephone : +81 596 24 8999

Facsimile : +81 596 24 8124

CONTENTS	PAGE
SECTION 1: Customer information	5
SECTION 2: Equipment under test (EUT)	5
SECTION 3: Test specification, procedures & results	6
SECTION 4: Operation of EUT during testing	9
SECTION 5: Radiated emission (Fundamental and Spurious Emission)	11
SECTION 6: -26 dB Bandwidth	14
SECTION 7: 99 % Occupied Bandwidth	14
APPENDIX 1: Test data	15
Radiated Emission (Fundamental and Spurious Emission)	15
-26 dB Bandwidth and 99 % Occupied Bandwidth	20
APPENDIX 2: Test instruments	21
APPENDIX 3: Photographs of test setup	22
Radiated Emission.....	22
Worst Case Position	23

SECTION 1: Customer information

Company Name : TOYOTA MOTOR CORPORATION
Address : 1, Toyota-Cho, Toyota, Aichi, 471-8572 Japan
Telephone Number : +81-565-94-0902
Facsimile Number : +81-565-94-1161
Contact Person : Shinji Suganuma

The information provided from the customer is as follows;

- Applicant, Type of EUT, Model Number of EUT, FCC ID on the cover and other relevant pages
 - Operating/Test Mode(s) (Mode(s)) on all the relevant pages
 - SECTION 1: Customer information
 - SECTION 2: Equipment under test (EUT)
 - SECTION 4: Operation of EUT during testing
- * The laboratory is exempted from liability of any test results affected from the above information in SECTION 2 and 4.

SECTION 2: Equipment under test (EUT)

2.1 Identification of EUT

Type : Smart LF Oscillator
Model Number : TS-GTY
Serial Number : Refer to SECTION 4.2
Rating : DC 12.0 V
Receipt Date : March 5, 2021
Condition : Production prototype
(Not for Sale: This sample is equivalent to mass-produced items.)
Modification : No Modification by the test lab

2.2 Product Description

Smart LF Oscillator, model: TS-GTY is a transmitter that is installed in a motor vehicle and is used as part of Smart System.

Radio Specification

Radio Type : Transmitter
Frequency of Operation : 134.2 kHz
Modulation : ASK
Antenna type : Coil Antenna

Smart LF Oscillator (model: TS-GTY) consists of the following parts:

- Computer Assy, Smart Key (ECU)
- D seat Antenna (Door antenna)
- P seat Antenna (Door antenna)
- Extra1 Antenna (Room antenna)
- Extra2 Antenna (Room antenna)
- Extra3 Antenna (Room antenna) or Trunk Antenna (Trunk antenna) or Back Door Antenna (Room antenna)
- Back Door Antenna (Room antenna)

UL Japan, Inc.

Ise EMC Lab.

4383-326 Asama-cho, Ise-shi, Mie-ken 516-0021 JAPAN

Telephone : +81 596 24 8999

Facsimile : +81 596 24 8124

SECTION 3: Test specification, procedures & results

3.1 Test Specification

Test Specification : FCC Part 15 Subpart C
FCC Part 15 final revised on January 12, 2021 and effective February 11, 2021

Title : FCC 47CFR Part15 Radio Frequency Device Subpart C Intentional Radiators
Section 15.207 Conducted limits
Section 15.209 Radiated emission limits; general requirements.

3.2 Procedures and results

Item	Test Procedure	Specification	Remarks	Deviation	Worst margin	Results
Conducted Emission	<FCC> ANSI C63.10:2013 6 Standard test methods <ISED> RSS-Gen 8.8	<FCC> Section 15.207 <ISED> RSS-Gen 8.8	-	N/A	N/A	N/A *1)
Electric Field Strength of Fundamental Emission	<FCC> ANSI C63.10:2013 6 Standard test methods <ISED> RSS-Gen 6.5, 6.12	<FCC> Section 15.209 <ISED> RSS-210 7.2 RSS-Gen 8.9	Radiated	N/A	2.1 dB 134.2 kHz, 0 deg. Peak with Duty factor <Mode 1>	Complied# a)
Electric Field Strength of Spurious Emission	<FCC> ANSI C63.10:2013 6 Standard test methods <ISED> RSS-Gen 6.5, 6.6, 6.13	<FCC> Section 15.209 <ISED> RSS-210 7.3 RSS-Gen 8.9	Radiated	N/A	12.3 dB 68.711 MHz, Vertical, QP <Mode 1>	Complied a)
-26 dB Bandwidth	<FCC> ANSI C63.10:2013 6 Standard test methods <ISED> -	<FCC> Reference data <ISED> -	Radiated	N/A	N/A	Complied b)

Note: UL Japan, Inc.'s EMI Work Procedures No. 13-EM-W0420 and 13-EM-W0422.

*1) The test is not applicable since the EUT is not the device that is designed to be connected to the public utility (AC) power line.

a) Refer to APPENDIX 1 (data of Radiated emission)

b) Refer to APPENDIX 1 (data of -26 dB Bandwidth and 99 % Occupied Bandwidth)

Symbols:

Complied The data of this test item has enough margin, more than the measurement uncertainty.

Complied# The data of this test item meets the limits unless the measurement uncertainty is taken into consideration.

FCC 15.31 (e)

This EUT provides stable voltage constantly to RF Module regardless of input voltage.

Instead of a new battery, DC power supply was used for the test.

That does not affect the test result, therefore the EUT complies with the requirement.

FCC Part 15.203 Antenna requirement

It is impossible for end users to replace the antenna, because the antenna is mounted inside of the vehicle. Therefore, the equipment complies with the antenna requirement of Section 15.203.

UL Japan, Inc.

Ise EMC Lab.

4383-326 Asama-cho, Ise-shi, Mie-ken 516-0021 JAPAN

Telephone : +81 596 24 8999

Facsimile : +81 596 24 8124

3.3 Addition to standard

Item	Test Procedure	Specification	Remarks	Deviation	Worst margin	Results
99 % Occupied Band Width	RSS-Gen 6.7	-	Radiated	N/A	N/A	-

Note: UL Japan, Inc.'s EMI Work Procedures No. 13-EM-W0420 and 13-EM-W0422.

Other than above, no addition, exclusion nor deviation has been made from the standard.

3.4 Uncertainty

There is no applicable rule of uncertainty in this applied standard. Therefore, the following results are derived depending on whether or not laboratory uncertainty is applied.

The following uncertainties have been calculated to provide a confidence level of 95% using a coverage factor k=2.

Radiated emission

Measurement distance	Frequency range	Uncertainty (+/-)
3 m	9 kHz to 30 MHz	3.3 dB
10 m		3.2 dB
3 m	30 MHz to 200 MHz	(Horizontal)
		(Vertical)
	200 MHz to 1000 MHz	(Horizontal)
		(Vertical)
10 m	30 MHz to 200 MHz	(Horizontal)
		(Vertical)
	200 MHz to 1000 MHz	(Horizontal)
		(Vertical)

Antenna Terminal test

Test Item	Uncertainty (+/-)
-26 dB Bandwidth / 99 % Occupied Bandwidth	0.96 %

3.5 Test Location

UL Japan, Inc. Ise EMC Lab.

*A2LA Certificate Number: 5107.02 / FCC Test Firm Registration Number: 199967

ISED Lab Company Number: 2973C / CAB identifier: JP0002

4383-326 Asama-cho, Ise-shi, Mie-ken 516-0021 JAPAN

Telephone: +81 596 24 8999, Facsimile: +81 596 24 8124

Test site	Width x Depth x Height (m)	Size of reference ground plane (m) / horizontal conducting plane	Other rooms	Maximum measurement distance
No.1 semi-anechoic chamber	19.2 x 11.2 x 7.7	7.0 x 6.0	No.1 Power source room	10 m
No.2 semi-anechoic chamber	7.5 x 5.8 x 5.2	4.0 x 4.0	-	3 m
No.3 semi-anechoic chamber	12.0 x 8.5 x 5.9	6.8 x 5.75	No.3 Preparation room	3 m
No.3 shielded room	4.0 x 6.0 x 2.7	N/A	-	-
No.4 semi-anechoic chamber	12.0 x 8.5 x 5.9	6.8 x 5.75	No.4 Preparation room	3 m
No.4 shielded room	4.0 x 6.0 x 2.7	N/A	-	-
No.5 semi-anechoic chamber	6.0 x 6.0 x 3.9	6.0 x 6.0	-	-
No.5 measurement room	6.4 x 6.4 x 3.0	6.4 x 6.4	-	-
No.6 shielded room	4.0 x 4.5 x 2.7	4.0 x 4.5	-	-
No.6 measurement room	4.75 x 5.4 x 3.0	4.75 x 4.15	-	-
No.7 shielded room	4.7 x 7.5 x 2.7	4.7 x 7.5	-	-
No.8 measurement room	3.1 x 5.0 x 2.7	3.1 x 5.0	-	-
No.9 measurement room	8.8 x 4.6 x 2.8	2.4 x 2.4	-	-
No.11 measurement room	6.2 x 4.7 x 3.0	4.8 x 4.6	-	-

* Size of vertical conducting plane (for Conducted Emission test) : 2.0 x 2.0 m for No.1, No.2, No.3, and No.4 semi-anechoic chambers and No.3 and No.4 shielded rooms.

3.6 Test data, Test instruments, and Test set up

Refer to APPENDIX.

SECTION 4: Operation of EUT during testing

4.1 Operating Modes

Test mode	Remarks	
1) Tx 134.2 kHz Extra1 Antenna (Room Antenna)	CLG1 port	*1)
2) Tx 134.2 kHz D seat Antenna (Door Antenna)	CLG5 port	*2)
3) Tx 134.2 kHz Extra3 Antenna (Room Antenna)	CLG7 port	*3)
4) Tx 134.2 kHz Trunk Antenna	CLG7 port	-
5) Tx 134.2 kHz Extra1 Antenna (Room Antenna) (Min Power)	CLG1 port	*1), *4)
6) Tx 134.2 kHz D seat Antenna (Door Antenna) (Min Power)	CLG5 port	*2), *5)
7) Tx 134.2 kHz Extra3 Antenna (Room Antenna) (Min Power)	CLG7 port	*3), *6)
8) Tx 134.2 kHz Trunk Antenna (Min Power)	CLG7 port	*7)
<p>* EUT was set by the software as follows; Software: TS-GTY version 1.00 (Date: March 24, 2021, Storage location: EUT memory)</p> <p>*This setting of software is the worst case. Any conditions under the normal use do not exceed the condition of setting. In addition, end users cannot change the settings of the output power of the product.</p>		

Justification : The system was configured in typical fashion (as a user would normally use it) for testing.

- *1) Ports CLG1, CLG2, CLG7, and CLG8 were compared by pre-check, and the test was performed only with CLG1 port, the worst case.
In addition, the antennas (Extra1 to 3, Back Door Antenna) connected to each of the above ports were compared, and the test was performed by connecting Extra1 antenna of the worst case as a representative.
- *2) Ports CLG5 and CLG6 were compared by pre-check, and the test was performed only with CLG5 port, the worst case.
- *3) Either Extra3 Antenna, Trunk Antenna, or Back Door Antenna is connected to the CLG7 port, but Extra3 Antenna and Back Door Antenna are only different in the mounting position on the car.
Therefore, the test was performed by connecting the Extra 3 Antenna as a representative.
- *4) Career level and worst spurious emission (for Mode 1)
- *5) Career level and worst spurious emission (for Mode 2)
- *6) Career level and worst spurious emission (for Mode 3)
- *7) Career level and worst spurious emission (for Mode 4)

4.2 Configuration and peripherals

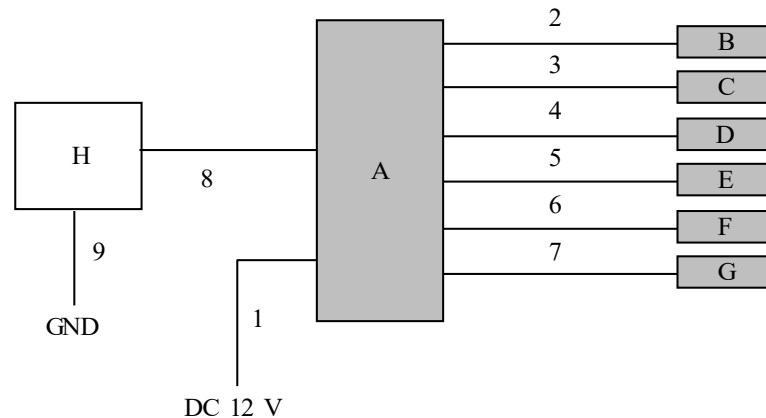

* Cabling and setup(s) were taken into consideration and test data was taken under worse case conditions.

Description of EUT and Support equipment

No.	Item	Model number	Serial number	Manufacturer	Remarks
A	Computer Assy, Smart Key (ECU)	TS-GTY (12AB0)	210208 3	-	EUT
B	Antenna	8RA	LF2003	-	EUT
C	Antenna	8RA	LF2001	-	EUT
D	Antenna	2DN0	DR2001	-	EUT
E	Antenna	2DN0	DR2002	-	EUT
F	Antenna	12TA0	BD2001	-	EUT *1)
		8RA	LF2004	-	EUT *2)
G	Antenna	8RA	LF2002	-	EUT
H	Jig Switch	-	-	-	-

*1) Used for Mode 4 and 8

*2) Used for other Mode except for Mode 4 and 8

List of cables used

No.	Name	Length (m)	Shield		Remark
			Cable	Connector	
1	DC Cable	2.0	Unshielded	Unshielded	-
2	Antenna Cable (CLG1)	1.5	Unshielded	Unshielded	-
3	Antenna Cable (CLG2)	1.5	Unshielded	Unshielded	-
4	Antenna Cable (CLG5)	1.5	Unshielded	Unshielded	-
5	Antenna Cable (CLG6)	1.5	Unshielded	Unshielded	-
6	Antenna Cable (CLG7)	1.5	Unshielded	Unshielded	-
7	Antenna Cable (CLG8)	1.5	Unshielded	Unshielded	-
8	Signal Cable	1.5	Unshielded	Unshielded	-
9	GND Cable	2.0	Unshielded	Unshielded	-

UL Japan, Inc.

Ise EMC Lab.

4383-326 Asama-cho, Ise-shi, Mie-ken 516-0021 JAPAN

Telephone : +81 596 24 8999

Facsimile : +81 596 24 8124

SECTION 5: Radiated emission (Fundamental and Spurious Emission)

Test Procedure

EUT was placed on a urethane platform of nominal size, 1.0 m by 1.5 m, raised 0.8 m above the conducting ground plane. The Radiated Electric Field Strength has been measured in a Semi Anechoic Chamber with a ground plane.

Frequency : From 9 kHz to 30 MHz

The EUT was rotated a full revolution in order to obtain the maximum value of the electric field intensity.

The measurements were performed for vertical polarization (antenna angle: 0 deg., 45 deg., 90 deg., and 135 deg.) and horizontal polarization.

*Refer to Figure 1 about Direction of the Loop Antenna.

Frequency: From 30 MHz to 1 GHz

The measuring antenna height varied between 1 and 4 m and EUT was rotated a full revolution in order to obtain the maximum value of the electric field intensity.

The measurements were performed for both vertical and horizontal antenna polarization.

The test was made with the detector (RBW / VBW) in the following table.

When using Spectrum analyzer, the test was made with adjusting span to zero by using peak hold.

Test Antennas are used as below;

Frequency	Below 30 MHz	30 MHz to 200 MHz	200 MHz to 1 GHz
Antenna Type	Loop	Biconical	Logperiodic

Frequency	From 9 kHz to 90 kHz and From 110 kHz to 150 kHz	From 90 kHz to 110 kHz	From 150 kHz to 490 kHz	From 490 kHz to 30 MHz	From 30 MHz to 1 GHz
Instrument used	Test Receiver				
Detector	PK / AV	QP	PK / AV	QP	QP
IF Bandwidth	200 Hz	200 Hz	9 kHz	9 kHz	120 kHz
Test Distance	3 m *1)	3 m *1)	3 m *1)	3 m *2)	3 m

*1) Distance Factor: $40 \times \log(3 \text{ m} / 300 \text{ m}) = -80 \text{ dB}$

*2) Distance Factor: $40 \times \log(3 \text{ m} / 30 \text{ m}) = -40 \text{ dB}$

Although these tests were performed other than open field test site, adequate comparison measurements were confirmed against 30 m open field test site. Therefore sufficient tests were made to demonstrate that the alternative site produces results that correlate with the ones of tests made in an open field based on KDB 414788.

These tests were performed in semi anechoic chamber. Therefore the measured level of emissions may be higher than if measurements were made without a ground plane.

However test results were confirmed to pass against standard limit.

The limits in CFR 47, Part 15, Subpart C, paragraph 15.209(a), are identical to those in RSS-Gen section 8.9, Table 6, since the measurements are performed in terms of magnetic field strength and converted to electric field strength levels (as reported in the table) using the free space impedance of 377 Ohms. For example, the measurement at frequency 9 kHz resulted in a level of 45.5 dBuV/m, which is equivalent to $45.5 - 51.5 = -6.0 \text{ dBuA/m}$, which has the same margin, 3 dB, to the corresponding RSS-Gen Table 6 limit as it has to 15.209(a) limit.

UL Japan, Inc.

Ise EMC Lab.

4383-326 Asama-cho, Ise-shi, Mie-ken 516-0021 JAPAN

Telephone : +81 596 24 8999

Facsimile : +81 596 24 8124

[Test Setup]
Below 1 GHz

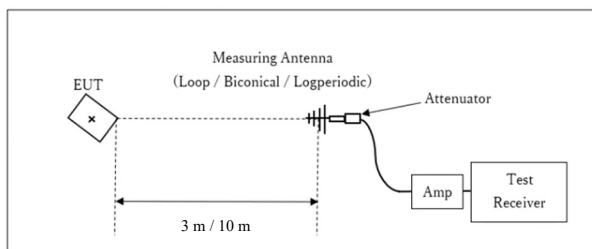

Test Distance: 3 m / 10 m

- The carrier level and noise levels were confirmed at each position of X, Y and Z axes of EUT to see the position of maximum noise, and the test was made at the position that has the maximum noise.

The test results and limit are rounded off to one decimal place, so some differences might be observed.

Measurement range : 9 kHz - 1 GHz
Test data : APPENDIX 1
Test result : Pass

Date: March 24, 2021

Test engineer: Akihiko Maeda

Figure 1: Direction of the Loop Antenna

Side View (Vertical)

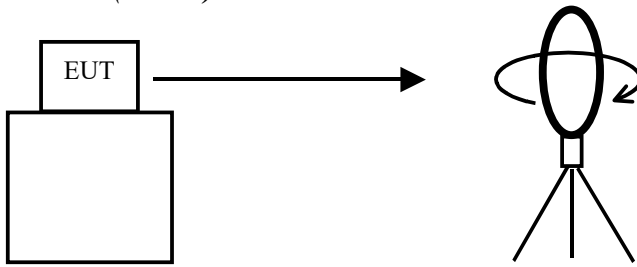

Top View (Horizontal)

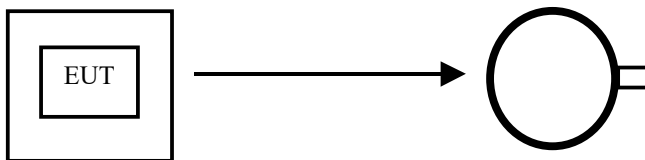

Antenna was not rotated.

Top View (Vertical)

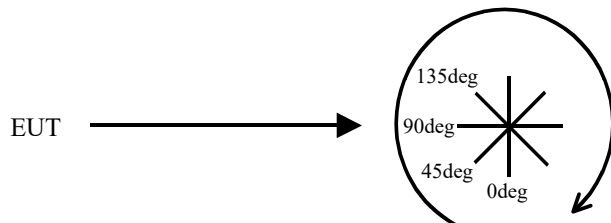

Front side: 0 deg.
Forward direction: clockwise

SECTION 6: -26 dB Bandwidth

Test Procedure

The test was measured with a spectrum analyzer using a test fixture.

Test	Span	RBW	VBW	Sweep	Detector	Trace	Instrument used
-26 dB Bandwidth	50 kHz	390 Hz	1.2 kHz	Auto	Peak	Max Hold	Spectrum Analyzer

Test data : APPENDIX 1

Test result : Pass

SECTION 7: 99 % Occupied Bandwidth

Test Procedure

The test was measured with a spectrum analyzer using a test fixture.

Test	Span	RBW	VBW	Sweep	Detector	Trace	Instrument used
99 % Occupied Bandwidth	Enough width to display emission skirts	1 to 5 % of OBW	Three times of RBW	Auto	Peak *1)	Max Hold *1)	Spectrum Analyzer

*1) The measurement was performed with Peak detector, Max Hold since the duty cycle was not 100 %.
Peak hold was applied as Worst-case measurement.

Test data : APPENDIX 1

Test result : Pass

APPENDIX 1: Test data

Radiated Emission (Fundamental and Spurious Emission)

Report No. 13720933H
Test place Ise EMC Lab.
Semi Anechoic Chamber No.4
Date March 24, 2021
Temperature / Humidity 18 deg. C / 40 % RH
Engineer Akihiko Maeda
Mode Mode 1

PK or QP

Ant Deg [deg] or Polarity [Hori/Vert]	Frequency [MHz]	Detector	Reading [dBuV]	Ant Factor [dB/m]	Loss [dB]	Gain [dB]	Duty Factor [dB]	Result [dBuV/m]	Limit [dBuV/m]	Margin [dB]	Remark
0deg	0.13420	PK	77.8	18.9	-73.8	0.0	-	22.9	45.0	22.1	Fundamental
0deg	0.13420	PK	53.9	18.9	-73.8	0.0	-	-1.0	45.0	46.0	Fundamental (Mode 5)
0deg	0.26840	PK	45.1	18.9	-64.1	31.5	-	-31.7	39.0	70.7	
0deg	0.40260	PK	35.7	18.8	-64.1	31.6	-	-41.1	35.5	76.6	
0deg	0.53680	QP	22.7	18.8	-24.1	31.6	-	-14.2	33.0	47.2	
0deg	0.67100	QP	23.5	18.8	-24.1	31.6	-	-13.4	31.1	44.4	
0deg	0.80520	QP	23.6	18.8	-24.1	31.6	-	-13.3	29.5	42.7	
0deg	0.93940	QP	21.5	18.8	-24.1	31.6	-	-15.4	28.1	43.5	
0deg	1.07360	QP	22.7	18.8	-24.0	31.6	-	-14.1	26.9	41.1	
0deg	1.20780	QP	21.3	18.8	-24.0	31.6	-	-15.5	25.9	41.4	
0deg	1.34200	QP	21.2	18.8	-24.0	31.6	-	-15.6	25.0	40.6	
0deg	1.34200	QP	21.2	18.8	-24.0	31.6	-	-15.6	25.0	40.6	(Mode 5)
Hori.	32.844	QP	21.4	17.3	7.2	31.5	-	14.4	40.0	25.6	
Hori.	55.024	QP	30.4	9.3	7.5	31.5	-	15.7	40.0	24.3	
Hori.	62.003	QP	35.5	7.3	7.6	31.5	-	18.8	40.0	21.2	
Hori.	68.711	QP	35.0	6.3	7.7	31.5	-	17.5	40.0	22.5	
Hori.	68.711	QP	25.4	6.3	7.7	31.5	-	7.9	40.0	32.1	(Mode 5)
Hori.	103.204	QP	22.6	10.6	8.0	31.5	-	9.7	43.5	33.8	
Hori.	120.249	QP	25.2	12.7	8.2	31.4	-	14.7	43.5	28.9	
Vert.	32.844	QP	31.0	17.3	7.2	31.5	-	24.0	40.0	16.0	
Vert.	55.024	QP	40.8	9.3	7.5	31.5	-	26.1	40.0	13.9	
Vert.	62.003	QP	41.3	7.3	7.6	31.5	-	24.6	40.0	15.4	
Vert.	68.711	QP	45.2	6.3	7.7	31.5	-	27.7	40.0	12.3	
Vert.	68.711	QP	32.8	6.3	7.7	31.5	-	15.3	40.0	24.7	(Mode 5)
Vert.	103.204	QP	25.6	10.6	8.0	31.5	-	12.7	43.5	30.8	
Vert.	120.249	QP	28.2	12.7	8.2	31.4	-	17.7	43.5	25.9	

Result = Reading + Ant Factor + Loss (Cable + Attenuator + Filter + D.Factor) - Gain(Amplifier)

PK with Duty factor

Ant Deg [deg] or Polarity [Hori/Vert]	Frequency [MHz]	Detector	Reading [dBuV]	Ant Factor [dB/m]	Loss [dB]	Gain [dB]	Duty Factor [dB]	Result [dBuV/m]	Limit [dBuV/m]	Margin [dB]	Remark
0deg	0.13420	PK	77.8	18.9	-73.8	0.0	0.0	22.9	25.0	2.1	Fundamental
0deg	0.13420	PK	53.9	18.9	-73.8	0.0	0.0	-1.0	25.0	26.0	Fundamental (Mode 5)
0deg	0.26840	PK	45.1	18.9	-64.1	31.5	0.0	-31.7	19.0	50.7	
0deg	0.40260	PK	35.7	18.8	-64.1	31.6	0.0	-41.1	15.5	56.6	

Result = Reading + Ant Factor + Loss (Cable + Attenuator + Filter + D.Factor) - Gain(Amplifier) + Duty factor *

* Since the peak emission result satisfied the average limit, duty factor was omitted.

Result of the fundamental emission at 3m without Distance factor

Ant Deg [deg] or Polarity [Hori/Vert]	Frequency [MHz]	Detector	Reading [dBuV]	Ant Factor [dB/m]	Loss [dB]	Gain [dB]	Duty Factor [dB]	Result [dBuV/m]	Limit [dBuV/m]	Margin [dB]	Remark
0deg	0.13420	PK	77.8	18.9	6.2	0.0	-	102.9	-	-	Fundamental
0deg	0.13420	PK	53.9	18.9	6.2	0.0	-	79.0	-	-	Fundamental (Mode 5)

Result = Reading + Ant Factor + Loss (Cable + Attenuator) - Gain(Amplifier)

As for Gain 0.0 dB shown in the above table, pre-amplifier was not used.
Other frequency noises omitted in this report were not seen or had enough margin (more than 20 dB).

*The test result is rounded off to one or two decimal places, so some differences might be observed.
*For Mode 5 (ECU: Min Power), only the carrier level and worst spurious emission of Mode 1 (ECU: Max Power) were confirmed.

Radiated Emission (Fundamental and Spurious Emission)

Report No. 13720933H
Test place Ise EMC Lab.
Semi Anechoic Chamber No.4
Date March 24, 2021
Temperature / Humidity 18 deg. C / 40 % RH
Engineer Akihiko Maeda
Mode Mode 2

PK or QP

Ant Deg [deg] or Polarity [Hori/Vert]	Frequency [MHz]	Detector	Reading [dBuV]	Ant Factor [dB/m]	Loss [dB]	Gain [dB]	Duty Factor [dB]	Result [dBuV/m]	Limit [dBuV/m]	Margin [dB]	Remark
0deg	0.13420	PK	67.7	18.9	-73.8	0.0	-	12.8	45.0	32.2	Fundamental
0deg	0.13420	PK	50.8	18.9	-73.8	0.0	-	-4.1	45.0	49.1	Fundamental (Mode 6)
0deg	0.26840	PK	43.4	18.9	-64.1	31.5	-	-33.4	39.0	72.4	
0deg	0.40260	PK	37.8	18.8	-64.1	31.6	-	-39.0	35.5	74.5	
0deg	0.53680	QP	25.2	18.8	-24.1	31.6	-	-11.7	33.0	44.7	
0deg	0.67100	QP	24.8	18.8	-24.1	31.6	-	-12.1	31.1	43.1	
0deg	0.80520	QP	22.1	18.8	-24.1	31.6	-	-14.8	29.5	44.2	
0deg	0.93940	QP	23.1	18.8	-24.1	31.6	-	-13.8	28.1	41.9	
0deg	1.07360	QP	22.5	18.8	-24.0	31.6	-	-14.3	26.9	41.3	
0deg	1.20780	QP	21.3	18.8	-24.0	31.6	-	-15.5	25.9	41.4	
0deg	1.34200	QP	21.7	18.8	-24.0	31.6	-	-15.1	25.0	40.1	
0deg	1.34200	QP	21.5	18.8	-24.0	31.6	-	-15.3	25.0	40.3	(Mode 6)
Hori.	32.846	QP	21.8	17.3	7.2	31.5	-	14.8	40.0	25.2	
Hori.	55.017	QP	21.9	9.3	7.5	31.5	-	7.2	40.0	32.8	
Hori.	62.803	QP	30.0	7.1	7.6	31.5	-	13.2	40.0	26.8	
Hori.	62.803	QP	20.9	7.1	7.6	31.5	-	4.1	40.0	35.9	(Mode 6)
Hori.	67.692	QP	32.3	6.4	7.6	31.5	-	14.9	40.0	25.1	
Hori.	103.071	QP	24.8	10.6	8.0	31.5	-	11.9	43.5	31.6	
Hori.	120.249	QP	24.9	12.7	8.2	31.4	-	14.4	43.5	29.2	
Vert.	32.846	QP	31.5	17.3	7.2	31.5	-	24.5	40.0	15.5	
Vert.	55.017	QP	30.7	9.3	7.5	31.5	-	16.0	40.0	24.0	
Vert.	62.803	QP	43.4	7.1	7.6	31.5	-	26.6	40.0	13.4	
Vert.	62.803	QP	27.9	7.1	7.6	31.5	-	11.1	40.0	28.9	(Mode 6)
Vert.	67.692	QP	42.2	6.4	7.6	31.5	-	24.8	40.0	15.2	
Vert.	103.071	QP	28.9	10.6	8.0	31.5	-	16.0	43.5	27.5	
Vert.	120.249	QP	26.0	12.7	8.2	31.4	-	15.5	43.5	28.1	

Result = Reading + Ant Factor + Loss (Cable + Attenuator + Filter + D.Factor) - Gain(Amplifier)

PK with Duty factor

Ant Deg [deg] or Polarity [Hori/Vert]	Frequency [MHz]	Detector	Reading [dBuV]	Ant Factor [dB/m]	Loss [dB]	Gain [dB]	Duty Factor [dB]	Result [dBuV/m]	Limit [dBuV/m]	Margin [dB]	Remark
0deg	0.13420	PK	67.7	18.9	-73.8	0.0	0.0	12.8	25.0	12.2	Fundamental
0deg	0.13420	PK	50.8	18.9	-73.8	0.0	0.0	-4.1	25.0	29.1	Fundamental (Mode 6)
0deg	0.26840	PK	43.4	18.9	-64.1	31.5	0.0	-33.4	19.0	52.4	
0deg	0.40260	PK	37.8	18.8	-64.1	31.6	0.0	-39.0	15.5	54.5	

Result = Reading + Ant Factor + Loss (Cable + Attenuator + Filter + D.Factor) - Gain(Amplifier) + Duty factor *

* Since the peak emission result satisfied the average limit, duty factor was omitted.

Result of the fundamental emission at 3m without Distance factor

Ant Deg [deg] or Polarity [Hori/Vert]	Frequency [MHz]	Detector	Reading [dBuV]	Ant Factor [dB/m]	Loss [dB]	Gain [dB]	Duty Factor [dB]	Result [dBuV/m]	Limit [dBuV/m]	Margin [dB]	Remark
0deg	0.13420	PK	67.7	18.9	6.2	0.0	-	92.8	-	-	Fundamental
0deg	0.13420	PK	50.8	18.9	6.2	0.0	-	75.9	-	-	Fundamental (Mode 6)

Result = Reading + Ant Factor + Loss (Cable + Attenuator) - Gain(Amplifier)

As for Gain 0.0 dB shown in the above table, pre-amplifier was not used.
Other frequency noises omitted in this report were not seen or had enough margin (more than 20 dB).

*The test result is rounded off to one or two decimal places, so some differences might be observed.
*For Mode 6 (ECU: Min Power), only the carrier level and worst spurious emission of Mode 2 (ECU: Max Power) were confirmed.

Radiated Emission (Fundamental and Spurious Emission)

Report No. 13720933H
Test place Ise EMC Lab.
Semi Anechoic Chamber No.4
Date March 24, 2021
Temperature / Humidity 18 deg. C / 40 % RH
Engineer Akihiko Maeda
Mode Mode 3

PK or QP

Ant Deg [deg] or Polarity [Hori/Vert]	Frequency [MHz]	Detector	Reading [dBuV]	Ant Factor [dB/m]	Loss [dB]	Gain [dB]	Duty Factor [dB]	Result [dBuV/m]	Limit [dBuV/m]	Margin [dB]	Remark
0deg	0.13420	PK	71.7	18.9	-73.8	0.0	-	16.8	45.0	28.2	Fundamental
0deg	0.13420	PK	53.5	18.9	-73.8	0.0	-	-1.4	45.0	46.4	Fundamental (Mode 7)
0deg	0.26840	PK	40.1	18.9	-64.1	31.5	-	-36.7	39.0	75.7	
0deg	0.40260	PK	35.8	18.8	-64.1	31.6	-	-41.0	35.5	76.5	
0deg	0.53680	QP	23.8	18.8	-24.1	31.6	-	-13.1	33.0	46.1	
0deg	0.67100	QP	21.7	18.8	-24.1	31.6	-	-15.2	31.1	46.2	
0deg	0.80520	QP	22.1	18.8	-24.1	31.6	-	-14.8	29.5	44.2	
0deg	0.93940	QP	21.4	18.8	-24.1	31.6	-	-15.5	28.1	43.6	
0deg	1.07360	QP	20.9	18.8	-24.0	31.6	-	-15.9	26.9	42.9	
0deg	1.20780	QP	20.9	18.8	-24.0	31.6	-	-15.9	25.9	41.8	
0deg	1.34200	QP	20.5	18.8	-24.0	31.6	-	-16.3	25.0	41.3	
0deg	1.34200	QP	20.5	18.8	-24.0	31.6	-	-16.3	25.0	41.3	(Mode 7)
Hori.	32.831	QP	22.0	17.3	7.2	31.5	-	15.0	40.0	25.0	
Hori.	51.535	QP	23.8	10.5	7.4	31.5	-	10.3	40.0	29.7	
Hori.	62.678	QP	30.3	7.1	7.6	31.5	-	13.5	40.0	26.5	
Hori.	62.678	QP	20.9	7.1	7.6	31.5	-	4.1	40.0	35.9	(Mode 7)
Hori.	67.658	QP	31.5	6.4	7.6	31.5	-	14.1	40.0	25.9	
Hori.	103.070	QP	23.7	10.6	8.0	31.5	-	10.8	43.5	32.7	
Hori.	120.250	QP	23.2	12.7	8.2	31.4	-	12.7	43.5	30.9	
Vert.	32.831	QP	32.1	17.3	7.2	31.5	-	25.1	40.0	14.9	
Vert.	51.535	QP	34.0	10.5	7.4	31.5	-	20.5	40.0	19.5	
Vert.	62.678	QP	43.0	7.1	7.6	31.5	-	26.2	40.0	13.8	
Vert.	62.678	QP	27.4	7.1	7.6	31.5	-	10.6	40.0	29.4	(Mode 7)
Vert.	67.658	QP	42.1	6.4	7.6	31.5	-	24.7	40.0	15.3	
Vert.	103.070	QP	29.2	10.6	8.0	31.5	-	16.3	43.5	27.2	
Vert.	120.250	QP	22.4	12.7	8.2	31.4	-	11.9	43.5	31.7	

Result = Reading + Ant Factor + Loss (Cable + Attenuator + Filter + D.Factor) - Gain(Amplifier)

PK with Duty factor

Ant Deg [deg] or Polarity [Hori/Vert]	Frequency [MHz]	Detector	Reading [dBuV]	Ant Factor [dB/m]	Loss [dB]	Gain [dB]	Duty Factor [dB]	Result [dBuV/m]	Limit [dBuV/m]	Margin [dB]	Remark
0deg	0.13420	PK	71.7	18.9	-73.8	0.0	0.0	16.8	25.0	8.2	Fundamental
0deg	0.13420	PK	53.5	18.9	-73.8	0.0	0.0	-1.4	25.0	26.4	Fundamental (Mode 7)
0deg	0.26840	PK	40.1	18.9	-64.1	31.5	0.0	-36.7	19.0	55.7	
0deg	0.40260	PK	35.8	18.8	-64.1	31.6	0.0	-41.0	15.5	56.5	

Result = Reading + Ant Factor + Loss (Cable + Attenuator + Filter + D.Factor) - Gain(Amplifier) + Duty factor *

* Since the peak emission result satisfied the average limit, duty factor was omitted.

Result of the fundamental emission at 3m without Distance factor

Ant Deg [deg] or Polarity [Hori/Vert]	Frequency [MHz]	Detector	Reading [dBuV]	Ant Factor [dB/m]	Loss [dB]	Gain [dB]	Duty Factor [dB]	Result [dBuV/m]	Limit [dBuV/m]	Margin [dB]	Remark
0deg	0.13420	PK	71.7	18.9	6.2	0.0	-	96.8	-	-	Fundamental
0deg	0.13420	PK	53.5	18.9	6.2	0.0	-	78.6	-	-	Fundamental (Mode 7)

Result = Reading + Ant Factor + Loss (Cable + Attenuator) - Gain(Amplifier)

As for Gain 0.0 dB shown in the above table, pre-amplifier was not used.
Other frequency noises omitted in this report were not seen or had enough margin (more than 20 dB).

*The test result is rounded off to one or two decimal places, so some differences might be observed.
*For Mode 7 (ECU: Min Power), only the carrier level and worst spurious emission of Mode 3 (ECU: Max Power) were confirmed.

Radiated Emission (Fundamental and Spurious Emission)

Report No. 13720933H
Test place Ise EMC Lab.
Semi Anechoic Chamber No.4
Date March 24, 2021
Temperature / Humidity 18 deg. C / 40 % RH
Engineer Akihiko Maeda
Mode Mode 4

PK or QP

Ant Deg [deg] or Polarity [Hori/Vert]	Frequency [MHz]	Detector	Reading [dBuV]	Ant Factor [dB/m]	Loss [dB]	Gain [dB]	Duty Factor [dB]	Result [dBuV/m]	Limit [dBuV/m]	Margin [dB]	Remark
0deg	0.13420	PK	69.0	18.9	-73.8	0.0	-	14.1	45.0	30.9	Fundamental
0deg	0.13420	PK	50.9	18.9	-73.8	0.0	-	-4.0	45.0	49.0	Fundamental (Mode 8)
0deg	0.26840	PK	40.5	18.9	-64.1	31.5	-	-36.3	39.0	75.3	
0deg	0.40260	PK	37.5	18.8	-64.1	31.6	-	-39.3	35.5	74.8	
0deg	0.53680	QP	24.3	18.8	-24.1	31.6	-	-12.6	33.0	45.6	
0deg	0.67100	QP	21.5	18.8	-24.1	31.6	-	-15.4	31.1	46.4	
0deg	0.80520	QP	22.1	18.8	-24.1	31.6	-	-14.8	29.5	44.2	
0deg	0.93940	QP	21.0	18.8	-24.1	31.6	-	-15.9	28.1	44.0	
0deg	1.07360	QP	20.9	18.8	-24.0	31.6	-	-15.9	26.9	42.9	
0deg	1.20780	QP	20.8	18.8	-24.0	31.6	-	-16.0	25.9	41.9	
0deg	1.34200	QP	20.6	18.8	-24.0	31.6	-	-16.2	25.0	41.2	
0deg	1.34200	QP	20.5	18.8	-33.7	0.0	-	5.6	25.0	19.4	(Mode 8)
Hori.	32.846	QP	22.0	17.3	7.2	31.5	-	15.0	40.0	25.0	
Hori.	51.535	QP	23.9	10.5	7.4	31.5	-	10.4	40.0	29.6	
Hori.	62.504	QP	29.3	7.2	7.6	31.5	-	12.6	40.0	27.5	
Hori.	62.504	QP	20.8	7.2	7.6	31.5	-	4.1	40.0	36.0	(Mode 8)
Hori.	68.061	QP	32.0	6.4	7.7	31.5	-	14.6	40.0	25.5	
Hori.	103.651	QP	21.3	10.7	8.0	31.5	-	8.5	43.5	35.0	
Hori.	120.249	QP	23.3	12.7	8.2	31.4	-	12.8	43.5	30.8	
Vert.	32.846	QP	32.3	17.3	7.2	31.5	-	25.3	40.0	14.7	
Vert.	51.535	QP	33.9	10.5	7.4	31.5	-	20.4	40.0	19.6	
Vert.	62.504	QP	42.2	7.2	7.6	31.5	-	25.5	40.0	14.6	
Vert.	62.504	QP	25.4	7.2	7.6	31.5	-	8.7	40.0	31.4	(Mode 8)
Vert.	68.061	QP	41.9	6.4	7.7	31.5	-	24.5	40.0	15.6	
Vert.	103.651	QP	29.1	10.7	8.0	31.5	-	16.3	43.5	27.2	
Vert.	120.249	QP	22.3	12.7	8.2	31.4	-	11.8	43.5	31.8	

Result = Reading + Ant Factor + Loss (Cable + Attenuator + Filter + D.Factor) - Gain(Amplifier)

PK with Duty factor

Ant Deg [deg] or Polarity [Hori/Vert]	Frequency [MHz]	Detector	Reading [dBuV]	Ant Factor [dB/m]	Loss [dB]	Gain [dB]	Duty Factor [dB]	Result [dBuV/m]	Limit [dBuV/m]	Margin [dB]	Remark
0deg	0.13420	PK	69.0	18.9	-73.8	0.0	0.0	14.1	25.0	10.9	Fundamental
0deg	0.13420	PK	50.9	18.9	-73.8	0.0	0.0	-4.0	25.0	29.0	Fundamental (Mode 8)
0deg	0.26840	PK	40.5	18.9	-64.1	31.5	0.0	-36.3	19.0	55.3	
0deg	0.40260	PK	37.5	18.8	-64.1	31.6	0.0	-39.3	15.5	54.8	

Result = Reading + Ant Factor + Loss (Cable + Attenuator + Filter + D.Factor) - Gain(Amplifier) + Duty factor *

* Since the peak emission result satisfied the average limit, duty factor was omitted.

Result of the fundamental emission at 3m without Distance factor

Ant Deg [deg] or Polarity [Hori/Vert]	Frequency [MHz]	Detector	Reading [dBuV]	Ant Factor [dB/m]	Loss [dB]	Gain [dB]	Duty Factor [dB]	Result [dBuV/m]	Limit [dBuV/m]	Margin [dB]	Remark
0deg	0.13420	PK	69.0	18.9	6.2	0.0	-	94.1	-	-	Fundamental
0deg	0.13420	PK	50.9	18.9	6.2	0.0	-	76.0	-	-	Fundamental (Mode 8)

Result = Reading + Ant Factor + Loss (Cable + Attenuator) - Gain(Amplifier)

As for Gain 0.0 dB shown in the above table, pre-amplifier was not used.
Other frequency noises omitted in this report were not seen or had enough margin (more than 20 dB).

*The test result is rounded off to one or two decimal places, so some differences might be observed.
*For Mode 8 (ECU: Min Power), only the carrier level and worst spurious emission of Mode 4 (ECU: Max Power) were confirmed.

Radiated Emission Plot data, Worst case

Report No. 13720933H
Test place Ise EMC Lab.
Semi Anechoic Chamber No.4
Date March 24, 2021
Temperature / Humidity 18 deg. C / 40 % RH
Engineer Akihiko Maeda
Mode Mode 1

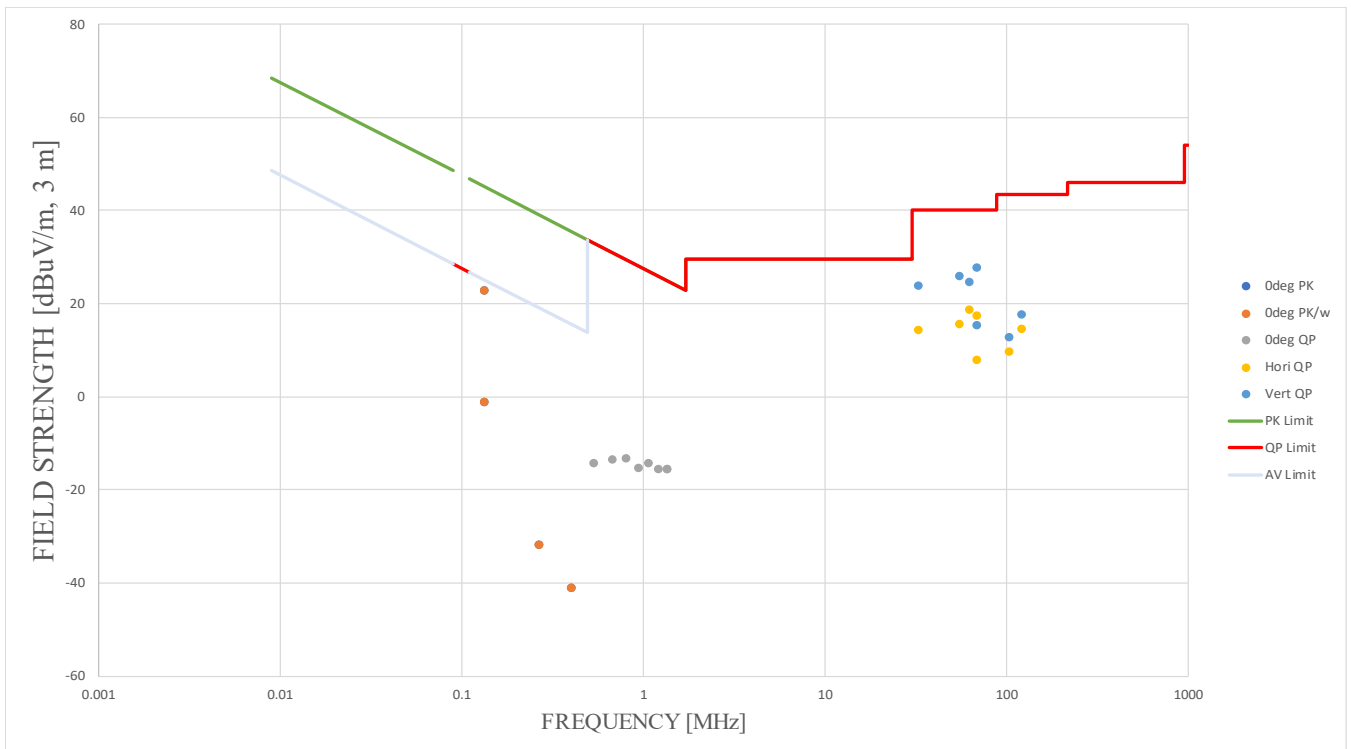

*These plots data contains sufficient number to show the trend of characteristic features for EUT.

-26 dB Bandwidth and 99 % Occupied Bandwidth

Report No. 13720933H
Test place Ise EMC Lab.
Semi Anechoic Chamber No.4
Date March 24, 2021
Temperature / Humidity 18 deg. C / 40 % RH
Engineer Akihiko Maeda
Mode Mode 1, 2, 3, 4

Mode	-26 dB Bandwidth [kHz]	99 % Occupied Bandwidth [kHz]
Mode 1	7.921	10.0970
Mode 2	16.287	18.2624
Mode 3	11.188	12.3190
Mode 4	13.768	12.9970

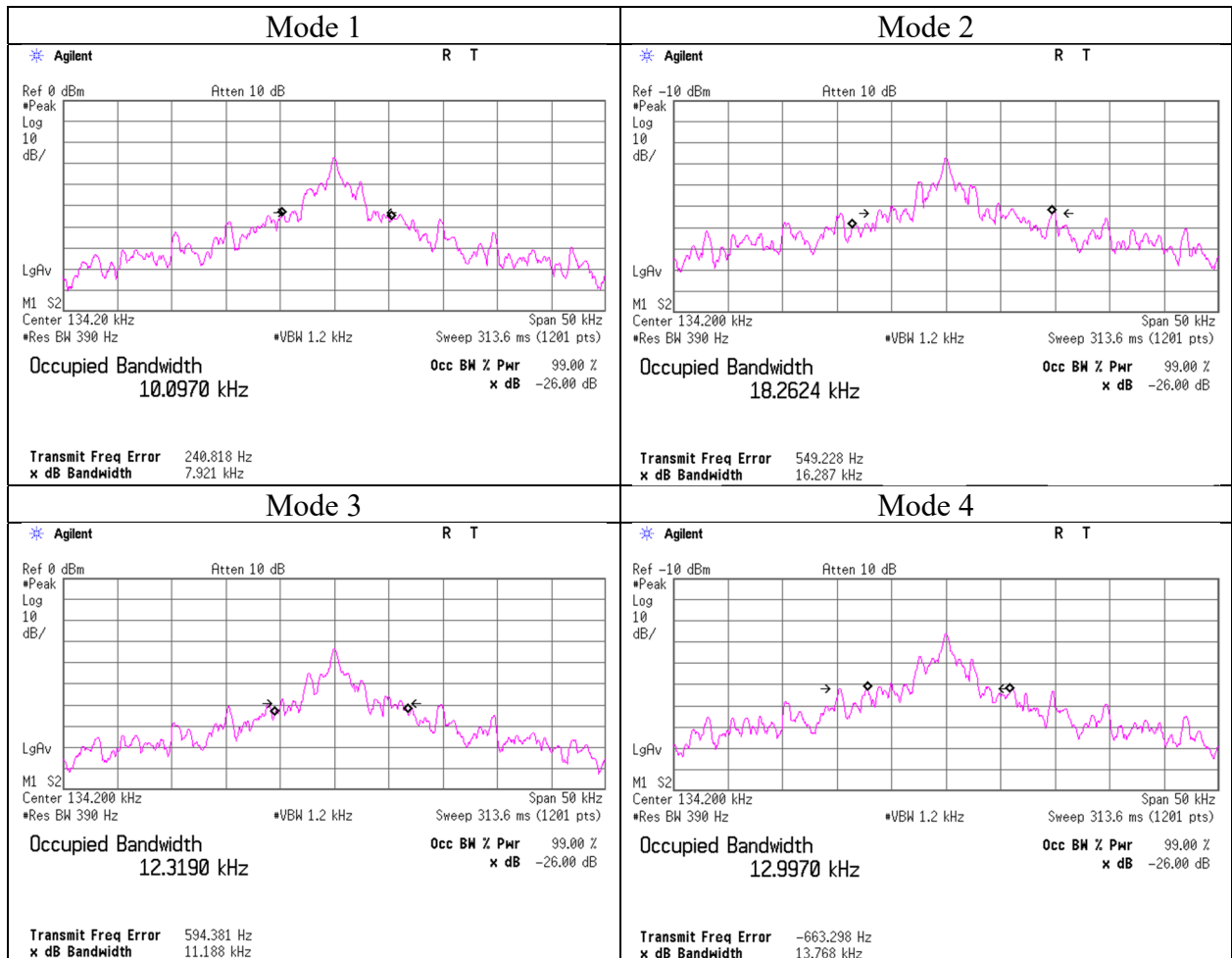

APPENDIX 2: Test instruments

Test equipment

Test Item	Local ID	LIMS ID	Description	Manufacturer	Model	Serial	Last Calibration Date	Cal Int
RE	MAEC-04	142011	Semi Anechoic Chamber(NSA)	TDK	Semi Anechoic Chamber 3m	DA-10005	05/25/2020	24
RE	MOS-15	141562	Thermo-Hygrometer	CUSTOM	CTH-180	1501	01/15/2021	12
RE	MMM-10	141545	DIGITAL HiTESTER	HIOKI	3805	51201148	01/07/2021	12
RE	MJM-29	142230	Measure	KOMELON	KMC-36	-	-	-
RE	COTS-MEMI-02	178648	EMI measurement program	TSJ (Techno Science Japan)	TEPTO-DV	-	-	-
RE	MLPA-02	142152	Loop Antenna	Rohde & Schwarz	HFH2-Z2	836553/009	12/04/2020	12
RE	MPA-14	141583	Pre Amplifier	SONOMA INSTRUMENT	11/5/1900	260833	02/03/2021	12
RE	MCC-219	159670	Coaxial Cable	UL Japan Inc.	-	-	11/17/2020	12
RE	MCC-113	141217	Coaxial cable	Fujikura/Suhner/TSJ	5D-2W/SFM141/421-010/sucoform141-PE/RFM-E121(SW)	-/04178	06/18/2020	12
RE	MAT-34	141331	Attenuator(6dB)	TME	UFA-01	-	02/02/2021	12
RE	MTR-10	141951	EMI Test Receiver	Rohde & Schwarz	ESR26	101408	03/09/2021	12
RE	MHF-24	141295	High Pass Filter 0.15-30MHz	Rohde & Schwarz	EZ-25/3	100041	02/05/2021	12
RE	MBA-05	141425	Biconical Antenna	Schwarzbeck	BBA9106	1302	08/31/2020	12
RE	MLA-23	141267	Logperiodic Antenna (200-1000MHz)	Schwarzbeck	VUSLP9111B	911B-192	09/02/2020	12
RE	MCC-50	141397	Coaxial Cable	UL Japan	-	-	11/06/2020	12

*Hyphens for Last Calibration Date and Cal Int (month) are instruments that Calibration is not required (e.g. software), or instruments checked in advance before use.

The expiration date of the calibration is the end of the expired month.

As for some calibrations performed after the tested dates, those test equipment have been controlled by means of an unbroken chains of calibrations.

All equipment is calibrated with valid calibrations. Each measurement data is traceable to the national or international standards.

Test item:

RE: Radiated Emission

UL Japan, Inc.

Ise EMC Lab.

4383-326 Asama-cho, Ise-shi, Mie-ken 516-0021 JAPAN

Telephone : +81 596 24 8999

Facsimile : +81 596 24 8124