

# FCC TEST REPORT

**REPORT NO.:** RF950317L11A

**MODEL NO.:** NOC-3220 PLUS (refer to item 3.1 for more details)

**RECEIVED:** Oct. 31, 2006

**TESTED:** Oct. 31 ~ Nov. 04, 2006

**ISSUED:** Jan. 18, 2007

**APPLICANT:** SENAO INTERNATIONAL CO., LTD.

**ADDRESS:** No.500, Fusing 3rd Rd., Hwa-Ya Technical Park, Kuei-Shan Hsiang, Taoyuan County 333, Taiwan, R.O.C

**ISSUED BY:** Advance Data Technology Corporation

**LAB ADDRESS:** 47 14<sup>th</sup> Lin, Chiapau Tsun, Linko, Taipei, Taiwan, R.O.C.

**TEST LOCATION:** No. 19, Hwa Ya 2<sup>nd</sup> Rd., Kueishan, Taoyuan, Taiwan, R.O.C.

This test report consists of 41 pages in total. It may be duplicated completely for legal use with the approval of the applicant. It should not be reproduced except in full, without the written approval of our laboratory. The client should not use it to claim product endorsement by CNLA, A2LA or any government agencies. The test results in the report only apply to the tested sample.





## Table of Contents

1	CERTIFICATION.....	3
2	SUMMARY OF TEST RESULTS .....	4
2.1	MEASUREMENT UNCERTAINTY.....	4
3	GENERAL INFORMATION.....	5
3.1	GENERAL DESCRIPTION OF EUT .....	5
3.2	DESCRIPTION OF TEST MODES .....	7
3.2.1	CONFIGURATION OF SYSTEM UNDER TEST.....	7
3.2.2	TEST MODE APPLICABILITY AND TESTED CHANNEL DETAIL.....	8
3.3	GENERAL DESCRIPTION OF APPLIED STANDARDS .....	10
3.4	DESCRIPTION OF SUPPORT UNITS .....	10
4	TEST TYPES AND RESULTS .....	11
4.1	CONDUCTED EMISSION MEASUREMENT.....	11
4.1.1	LIMITS OF CONDUCTED EMISSION MEASUREMENT .....	11
4.1.2	TEST INSTRUMENTS.....	11
4.1.3	TEST PROCEDURES .....	12
4.1.4	DEVIATION FROM TEST STANDARD.....	12
4.1.5	TEST SETUP.....	13
4.1.6	EUT OPERATING CONDITIONS .....	13
4.1.7	TEST RESULTS .....	14
4.2	RADIATED EMISSION MEASUREMENT .....	20
4.2.1	LIMITS OF RADIATED EMISSION MEASUREMENT .....	20
4.2.2	TEST INSTRUMENTS.....	21
4.2.3	TEST PROCEDURES .....	22
4.2.4	DEVIATION FROM TEST STANDARD.....	22
4.2.5	TEST SETUP.....	23
4.2.6	EUT OPERATING CONDITIONS .....	23
4.2.7	TEST RESULTS .....	24
4.3	BAND EDGES MEASUREMENT.....	31
4.3.1	LIMITS OF BAND EDGES MEASUREMENT .....	31
4.3.2	TEST INSTRUMENTS.....	31
4.3.3	TEST PROCEDURE.....	31
4.3.4	DEVIATION FROM TEST STANDARD.....	31
4.3.5	EUT OPERATING CONDITION.....	31
4.3.6	TEST RESULTS .....	32
5	INFORMATION ON THE TESTING LABORATORIES .....	40
	APPENDIX-A.....	A-1



## 1 CERTIFICATION

**PRODUCT :** Outdoor 802.11 b/g AP/CB  
**MODEL NO.:** NOC-3220 PLUS (refer to item 3.1 for more details)  
**BRAND:** SENA0 (refer to item 3.1 for more details)  
**APPLICANT :** SENA0 INTERNATIONAL CO., LTD.  
**TESTED:** Oct. 31 ~ Nov. 04, 2006  
**TEST SAMPLE:** ENGINEERING SAMPLE  
**STANDARDS :** **FCC Part 15, Subpart C (Section 15.247),**  
ANSI C63.4-2003

The above equipment have been tested by **Advance Data Technology Corporation**, and found compliance with the requirement of the above standards. The test record, data evaluation & Equipment Under Test (EUT) configurations represented herein are true and accurate accounts of the measurements of the sample's EMC characteristics under the conditions specified in this report.

**PREPARED BY :** Wendy Liao , **DATE:** Jan. 18, 2007  
Wendy Liao

**TECHNICAL**  
**ACCEPTANCE :** Long Chen , **DATE:** Jan. 18, 2007  
Responsible for RF  
Long Chen

**APPROVED BY :** Gary Chang , **DATE:** Jan. 18, 2007  
Gary Chang / Supervisor

## 2 SUMMARY OF TEST RESULTS

The EUT has been tested according to the following specifications:

APPLIED STANDARD: FCC Part 15, Subpart C			
Standard Section	Test Type and Limit	Result	REMARK
15.207	AC Power Conducted Emission	PASS	Meet the requirement of limit. Minimum passing margin is -10.56dB at 0.170MHz.
15.247(d)	Transmitter Radiated Emissions Limit: Table 15.209	PASS	Meet the requirement of limit. Minimum passing margin is -1.01dB at 77.22MHz
15.247(d)	Band Edge Measurement Limit: 20 dB less than the peak value of fundamental frequency	PASS	Meet the requirement of limit.

### 2.1 MEASUREMENT UNCERTAINTY

Where relevant, the following measurement uncertainty levels have been estimated for tests performed on the EUT as specified in CISPR 16-4:

Measurement	Frequency	Uncertainty
Conducted emissions	9kHz~30MHz	2.44 dB
Radiated emissions	30MHz ~ 200MHz	3.71 dB
	200MHz ~1000MHz	3.73 dB
	1GHz ~ 18GHz	2.26 dB
	18GHz ~ 40GHz	1.94 dB

This uncertainty represents an expanded uncertainty expressed at approximately the 95% confidence level using a coverage factor of k=2.

### 3 GENERAL INFORMATION

#### 3.1 GENERAL DESCRIPTION OF EUT

<b>PRODUCT</b>	Outdoor 802.11 b/g AP/CB
<b>MODEL NO.</b>	NOC-3220 PLUS (Refer to Note 1 for more details)
<b>FCC ID</b>	NI3-OC32106001
<b>POWER SUPPLY</b>	48Vdc from POE
<b>MODULATION TYPE</b>	CCK, DQPSK, DBPSK for DSSS 64QAM, 16QAM, QPSK, BPSK for OFDM
<b>MODULATION TECHNOLOGY</b>	DSSS, OFDM
<b>TRANSFER RATE</b>	802.11b: 11/5.5/2/1Mbps 802.11g: 54/48/36/24/18/12/9/6Mbps
<b>FREQUENCY RANGE</b>	2412MHz ~ 2462MHz
<b>NUMBER OF CHANNEL</b>	11
<b>MAXIMUM OUTPUT POWER</b>	40.087mW
<b>ANTENNA TYPE</b>	Patch antenna with 9dBi gain
<b>I/O PORTS</b>	RJ45
<b>DATA CABLE</b>	1m non-shielded RJ45 cable without core (connect to PC) 1m non-shielded RJ45 cable with one core (connect to EUT)
<b>ASSOCIATED DEVICES</b>	POE

**NOTE:**

1. The following model names were provided to this EUT.

Brand	Model	Remark
SENAO	NOC-3220 PLUS	Marketing requirement
EnGenius	ECO-3220 PLUS	
SENAO	SOC-3220 PLUS	

2. This report is issued as a supplementary report of RF950317L11. This report shall be combined together with its original report.
3. RF output power is the same as the original test report.



4. This report is prepared for FCC Class II permissive change. Difference compared with original report is listed as below, therefore Conducted and Radiated Emission Measurements had been re-tested.

ITEM	ORIGINAL DESCRIPTION	ITEM	CLASS II CHANE DESCRIPTION																				
1	Patch antenna with UFL connector Dipole antenna with R-SMA connector	1	Adding Patch antenna with UFL connector																				
2	<b>Adapter:</b> <table border="1"> <tr><td>Brand</td><td>MEAN WELL</td></tr> <tr><td>Model</td><td>ES18U48-P1J</td></tr> <tr><td>Input Power</td><td>100-240Vac, 50-60Hz, 0.5A</td></tr> <tr><td>Output Power</td><td>48Vdc, 0.375A, 18W</td></tr> <tr><td>Power Cord</td><td>DC 1.8m non-shielded cable with one core</td></tr> </table>	Brand	MEAN WELL	Model	ES18U48-P1J	Input Power	100-240Vac, 50-60Hz, 0.5A	Output Power	48Vdc, 0.375A, 18W	Power Cord	DC 1.8m non-shielded cable with one core	2	<b>Adapter:</b> <table border="1"> <tr><td>Brand</td><td>MEAN WELL</td></tr> <tr><td>Model</td><td>ES25U48-480</td></tr> <tr><td>Input Power</td><td>100-240Vac, 50-60Hz, 0.7A</td></tr> <tr><td>Output Power</td><td>48Vdc, 0.52A, 25W</td></tr> <tr><td>Power Cord</td><td>DC 1.8m non-shielded cable with one core</td></tr> </table>	Brand	MEAN WELL	Model	ES25U48-480	Input Power	100-240Vac, 50-60Hz, 0.7A	Output Power	48Vdc, 0.52A, 25W	Power Cord	DC 1.8m non-shielded cable with one core
Brand	MEAN WELL																						
Model	ES18U48-P1J																						
Input Power	100-240Vac, 50-60Hz, 0.5A																						
Output Power	48Vdc, 0.375A, 18W																						
Power Cord	DC 1.8m non-shielded cable with one core																						
Brand	MEAN WELL																						
Model	ES25U48-480																						
Input Power	100-240Vac, 50-60Hz, 0.7A																						
Output Power	48Vdc, 0.52A, 25W																						
Power Cord	DC 1.8m non-shielded cable with one core																						

5. The EUT is powered by the following POE:

**POE: (Power supply form Adapter)**

Brand	SENAO
Model No	NPE-4818
Output Power	48Vdc, 375mA

**Adapter:**

Brand	MEAN WELL
Model	ES25U48-480
Input Power	100-240Vac, 50-60Hz, 0.7A
Output Power	48Vdc, 0.52A, 25W
Power Cord	DC 1.8m non-shielded cable with one core

6. The EUT, operates in the 2.4GHz frequency range, lets you connect IEEE 802.11g or IEEE 802.11b devices to the network. With its high-speed data transmissions of up to 54Mbps.

7. The above EUT information was declared by manufacturer and for more detailed features description, please refer to the manufacturer's specifications or User's Manual.

### 3.2 DESCRIPTION OF TEST MODES

Eleven channels are provided to this EUT for normal mode.

Channel	Frequency	Channel	Frequency
1	2412 MHz	7	2442 MHz
2	2417 MHz	8	2447 MHz
3	2422 MHz	9	2452 MHz
4	2427 MHz	10	2457 MHz
5	2432 MHz	11	2462 MHz
6	2437 MHz		

#### 3.2.1 CONFIGURATION OF SYSTEM UNDER TEST

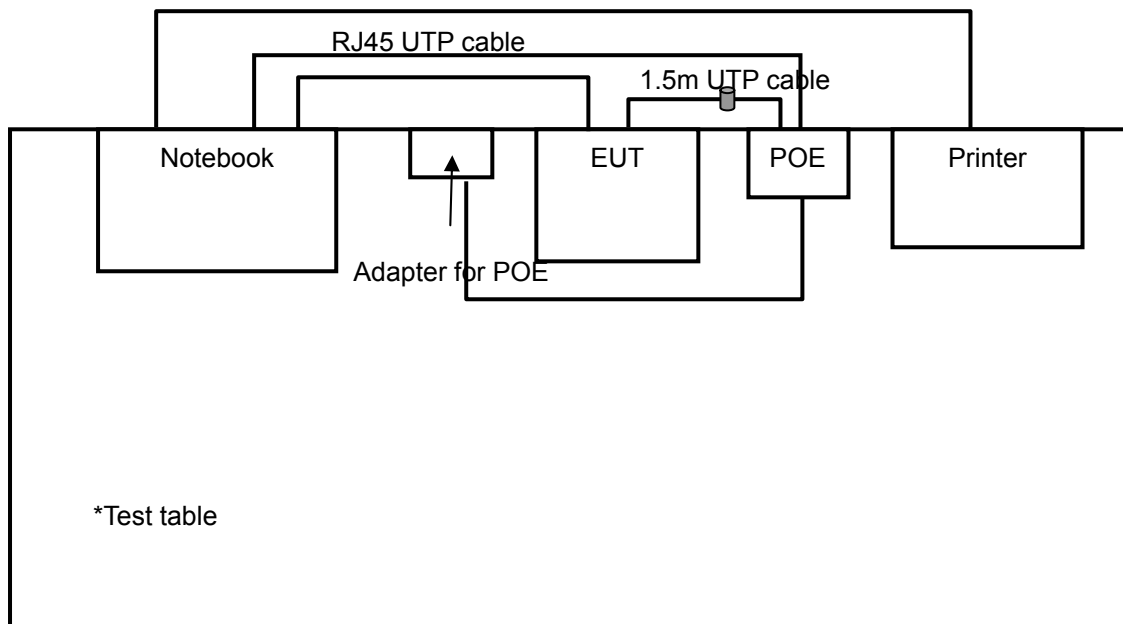

### 3.2.2 TEST MODE APPLICABILITY AND TESTED CHANNEL DETAIL

EUT configure mode	Applicable to				Description
	PLC	RE<1G	RE≥1G	APCM	
-	√	√	√	√	-

Where **PLC**: Power Line Conducted Emission

**RE<1G**: Radiated Emission below 1GHz

**RE≥1G**: Radiated Emission above 1GHz

**APCM**: Antenna Port Conducted Measurement

#### **Power Line Conducted Emission Test:**

- Pre-Scan has been conducted to determine the worst-case mode from all possible combinations between available modulations, data rates and antenna ports (if EUT with antenna diversity architecture).
- Following channel(s) was (were) selected for the final test as listed below.

Mode	Available Channel	Tested Channel	Modulation Technology	Modulation Type	Data Rate (Mbps)
802.11g	1 to 11	1, 6, 11	OFDM	BPSK	6

#### **Radiated Emission Test (Below 1 GHz):**

- Pre-Scan has been conducted to determine the worst-case mode from all possible combinations between available modulations, data rates and antenna ports (if EUT with antenna diversity architecture).
- Following channel(s) was (were) selected for the final test as listed below.

Mode	Available Channel	Tested Channel	Modulation Technology	Modulation Type	Data Rate (Mbps)
802.11g	1 to 11	11	OFDM	BPSK	6

#### **Radiated Emission Test (Above 1 GHz):**

- Pre-Scan has been conducted to determine the worst-case mode from all possible combinations between available modulations, data rates and antenna ports (if EUT with antenna diversity architecture).
- Following channel(s) was (were) selected for the final test as listed below.

Mode	Available Channel	Tested Channel	Modulation Technology	Modulation Type	Data Rate (Mbps)
802.11b	1 to 11	1, 6, 11	DSSS	DBPSK	1
802.11g	1 to 11	1, 6, 11	OFDM	BPSK	6





**Bandedge Measurement:**

- Pre-Scan has been conducted to determine the worst-case mode from all possible combinations between available modulations, data rates and antenna ports (if EUT with antenna diversity architecture).
- Following channel(s) was (were) selected for the final test as listed below.

Mode	Available Channel	Tested Channel	Modulation Technology	Modulation Type	Data Rate (Mbps)
802.11b	1 to 11	1, 11	DSSS	DBPSK	1
802.11g	1 to 11	1, 11	OFDM	BPSK	6



### 3.3 GENERAL DESCRIPTION OF APPLIED STANDARDS

The EUT is a RF product. According to the specifications of the manufacturer, it must comply with the requirements of the following standards:

**FCC Part 15, Subpart C. (15.247)**  
**ANSI C63.4-2003**

All test items have been performed and recorded as per the above standards.

**NOTE:** The EUT is also considered as a kind of computer peripheral, because the connection to computer is necessary for typical use. It has been verified to comply with the requirements of FCC Part 15, Subpart B, Class B (DoC). The test report has been issued separately.

### 3.4 DESCRIPTION OF SUPPORT UNITS

The EUT has been tested as an independent unit together with other necessary accessories or support units. The following support units or accessories were used to form a representative test configuration during the tests.

NO.	PRODUCT	BRAND	MODEL NO.	SERIAL NO.	FCC ID
1	NOTEBOOK COMPUTER	DELL	PP05L	12130898320	E2K24CLNS
2	PRINTER	EPSON	LQ-300+	DCGY047265	FCC DoC Approved

NO.	SIGNAL CABLE DESCRIPTION OF THE ABOVE SUPPORT UNITS
1	NA
2	1.2m shielded cable

**NOTE:** All power cords of the above support units are non shielded (1.8m).

## 4 TEST TYPES AND RESULTS

### 4.1 CONDUCTED EMISSION MEASUREMENT

#### 4.1.1 LIMITS OF CONDUCTED EMISSION MEASUREMENT

FREQUENCY OF EMISSION (MHz)	CONDUCTED LIMIT (dB $\mu$ V)	
	Quasi-peak	Average
0.15-0.5	66 to 56	56 to 46
0.5-5	56	46
5-30	60	50

- NOTE:**
1. The lower limit shall apply at the transition frequencies.
  2. The limit decreases in line with the logarithm of the frequency in the range of 0.15 to 0.50 MHz.
  3. All emanations from a class A/B digital device or system, including any network of conductors and apparatus connected thereto, shall not exceed the level of field strengths specified above.

#### 4.1.2 TEST INSTRUMENTS

DESCRIPTION & MANUFACTURER	MODEL NO.	SERIAL NO.	CALIBRATED UNTIL
Test Receiver ROHDE & SCHWARZ	ESCS30	100288	Sep. 25, 2007
RF signal cable Woken	5D-FB	Cable-HYCO3-01	Jan. 06, 2008
LISN ROHDE & SCHWARZ	ESH2-Z5	100100	Jan. 08, 2008
LISN ROHDE & SCHWARZ	ESH3-Z5	100311	Jan. 22, 2007
Software ADT	ADT_Cond_V3	NA	NA

- NOTE:**
1. The calibration interval of the above test instruments is 12 months and the calibrations are traceable to NML/ROC and NIST/USA.
  2. The test was performed in HwaYa Shielded Room 2.
  3. The VCCI Site Registration No. is C-2047.

#### 4.1.3 TEST PROCEDURES

- a. The EUT was placed 0.4 meters from the conducting wall of the shielded room with EUT being connected to the power mains through a line impedance stabilization network (LISN). Other support units were connected to the power mains through another LISN. The two LISNs provide 50 ohm/ 50uH of coupling impedance for the measuring instrument.
- b. Both lines of the power mains connected to the EUT were checked for maximum conducted interference.
- c. The frequency range from 150kHz to 30MHz was searched. Emission levels under Limit - 20dB was not recorded.

#### 4.1.4 DEVIATION FROM TEST STANDARD

No deviation

#### 4.1.5 TEST SETUP

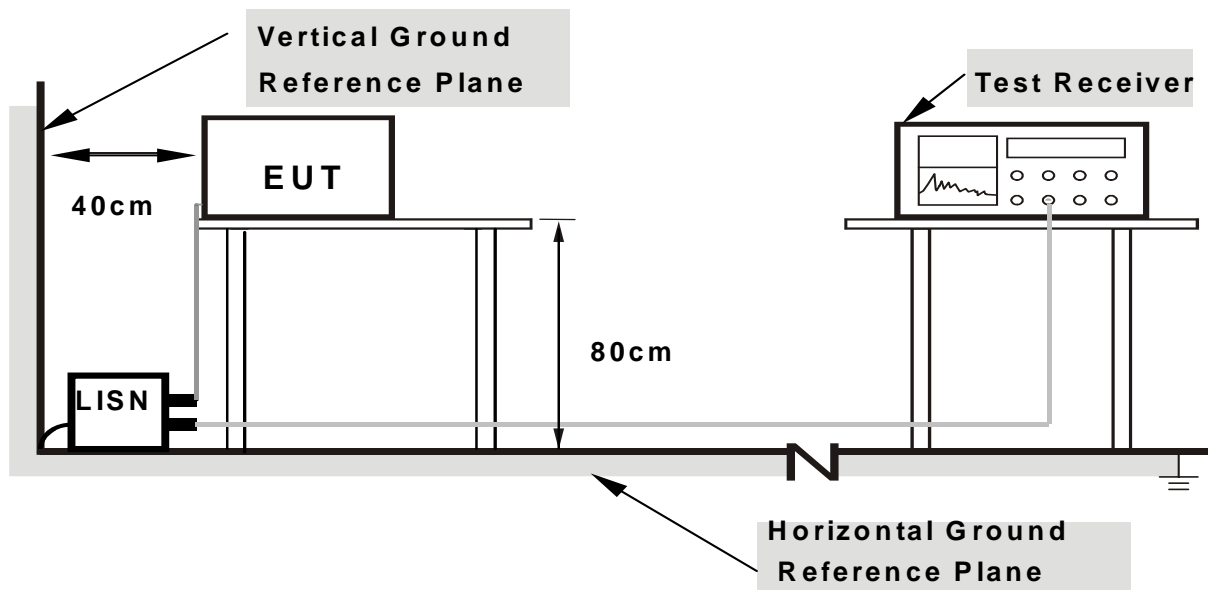

- Note:**
- 1.Support units were connected to second LISN.
  - 2.Both of LISNs (AMN) are 80 cm from EUT and at least 80 from other units and other metal planes

For the actual test configuration, please refer to the attached file (Test Setup Photo).

#### 4.1.6 EUT OPERATING CONDITIONS

- a. Connected the EUT to the notebook via the RJ45 cable and placed on a testing table.
- b. The notebook system ran a test program (provided by manufacturer) to enable EUT under transmission condition continuously at specific channel frequency.
- c. The necessary accessories enable the system in full functions.

#### 4.1.7 TEST RESULTS

##### CONDUCTED WORST-CASE DATA

EUT TEST CONDITION		MEASUREMENT DETAIL	
CHANNEL	Channel 1	PHASE	Line 1
MODULATION TYPE	BPSK	6dB BANDWIDTH	9 kHz
TRANSFER RATE	6Mbps	INPUT POWER (SYSTEM)	120Vac, 60 Hz
ENVIRONMENTAL CONDITIONS	20deg. C, 60%RH, 991hPa	TESTED BY	Match Tsui

No	Freq. [MHz]	Corr. Factor [dB]	Reading Value [dB (uV)]		Emission Level [dB (uV)]		Limit [dB (uV)]		Margin (dB)	
			Q.P.	AV.	Q.P.	AV.	Q.P.	AV.	Q.P.	AV.
1	0.170	0.10	54.32	-	54.42	-	64.98	54.98	-10.56	-
2	0.213	0.10	49.34	-	49.44	-	63.11	53.11	-13.67	-
3	0.341	0.10	45.86	-	45.96	-	59.17	49.17	-13.21	-
4	0.638	0.10	36.94	-	37.04	-	56.00	46.00	-18.96	-
5	3.797	0.35	33.19	-	33.54	-	56.00	46.00	-22.46	-
6	14.324	0.59	29.38	-	29.97	-	60.00	50.00	-30.03	-

- REMARKS:**
1. Q.P. and AV. are abbreviations of quasi-peak and average individually.
  2. "-": The Quasi-peak reading value also meets average limit and measurement with the average detector is unnecessary.
  3. The emission levels of other frequencies were very low against the limit.
  4. Margin value = Emission level - Limit value
  5. Correction factor = Insertion loss + Cable loss
  6. Emission Level = Correction Factor + Reading Value.

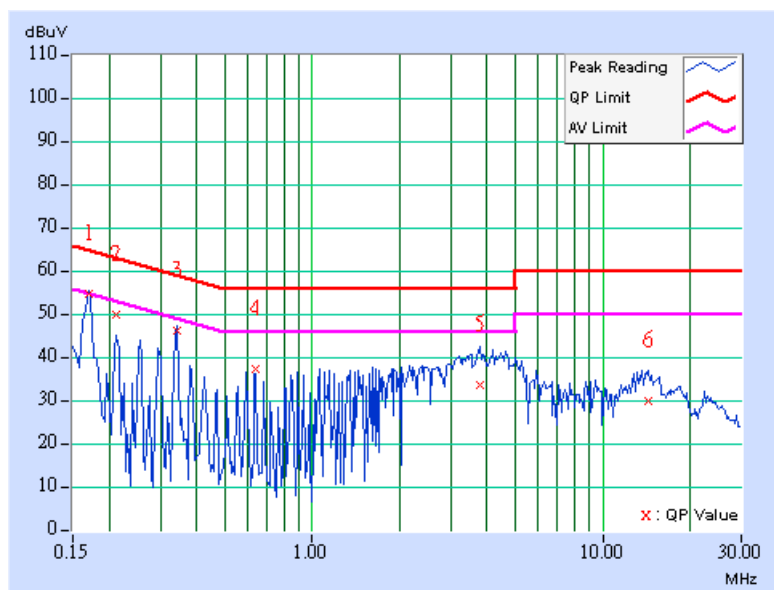

EUT TEST CONDITION		MEASUREMENT DETAIL	
CHANNEL	Channel 1	PHASE	Line 2
MODULATION TYPE	BPSK	6dB BANDWIDTH	9 kHz
TRANSFER RATE	6Mbps	INPUT POWER (SYSTEM)	120Vac, 60 Hz
ENVIRONMENTAL CONDITIONS	20deg. C, 60%RH, 991hPa	TESTED BY	Match Tsui

No	Freq. [MHz]	Corr. Factor [dB]	Reading Value [dB (uV)]		Emission Level [dB (uV)]		Limit [dB (uV)]		Margin (dB)	
			Q.P.	AV.	Q.P.	AV.	Q.P.	AV.	Q.P.	AV.
			1	0.170	0.10	52.10	-	52.20	-	64.98
2	0.213	0.10	46.59	-	46.69	-	63.11	53.11	-16.42	-
3	0.341	0.10	44.36	-	44.46	-	59.17	49.17	-14.71	-
4	0.892	0.18	36.23	-	36.41	-	56.00	46.00	-19.59	-
5	3.746	0.35	40.52	-	40.87	-	56.00	46.00	-15.13	-
6	14.430	0.61	33.50	-	34.11	-	60.00	50.00	-25.89	-

- REMARKS:**
1. Q.P. and AV. are abbreviations of quasi-peak and average individually.
  2. "-": The Quasi-peak reading value also meets average limit and measurement with the average detector is unnecessary.
  3. The emission levels of other frequencies were very low against the limit.
  4. Margin value = Emission level - Limit value
  5. Correction factor = Insertion loss + Cable loss
  6. Emission Level = Correction Factor + Reading Value.

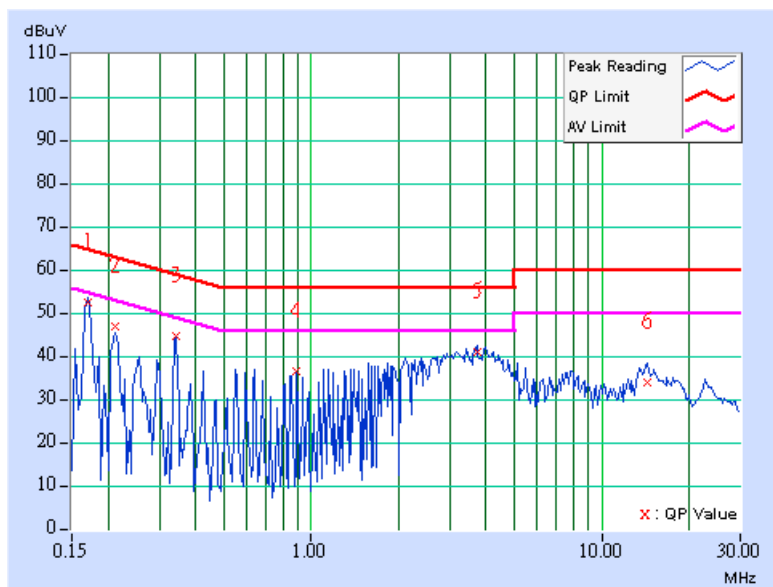

EUT TEST CONDITION		MEASUREMENT DETAIL	
CHANNEL	Channel 6	PHASE	Line 1
MODULATION TYPE	BPSK	6dB BANDWIDTH	9 kHz
TRANSFER RATE	6Mbps	INPUT POWER (SYSTEM)	120Vac, 60 Hz
ENVIRONMENTAL CONDITIONS	20deg. C, 60%RH, 991hPa	TESTED BY	Match Tsui

No	Freq. [MHz]	Corr. Factor [dB]	Reading Value [dB (uV)]		Emission Level [dB (uV)]		Limit [dB (uV)]		Margin (dB)	
			Q.P.	AV.	Q.P.	AV.	Q.P.	AV.	Q.P.	AV.
			1	0.173	0.10	50.89	-	50.99	-	64.79
2	0.213	0.10	48.04	-	48.14	-	63.11	53.11	-14.97	-
3	0.341	0.10	45.80	-	45.90	-	59.17	49.17	-13.27	-
4	0.638	0.10	37.02	-	37.12	-	56.00	46.00	-18.88	-
5	4.258	0.37	39.19	-	39.56	-	56.00	46.00	-16.44	-
6	14.309	0.59	34.34	-	34.93	-	60.00	50.00	-25.07	-

- REMARKS:**
1. Q.P. and AV. are abbreviations of quasi-peak and average individually.
  2. "-": The Quasi-peak reading value also meets average limit and measurement with the average detector is unnecessary.
  3. The emission levels of other frequencies were very low against the limit.
  4. Margin value = Emission level - Limit value
  5. Correction factor = Insertion loss + Cable loss
  6. Emission Level = Correction Factor + Reading Value.

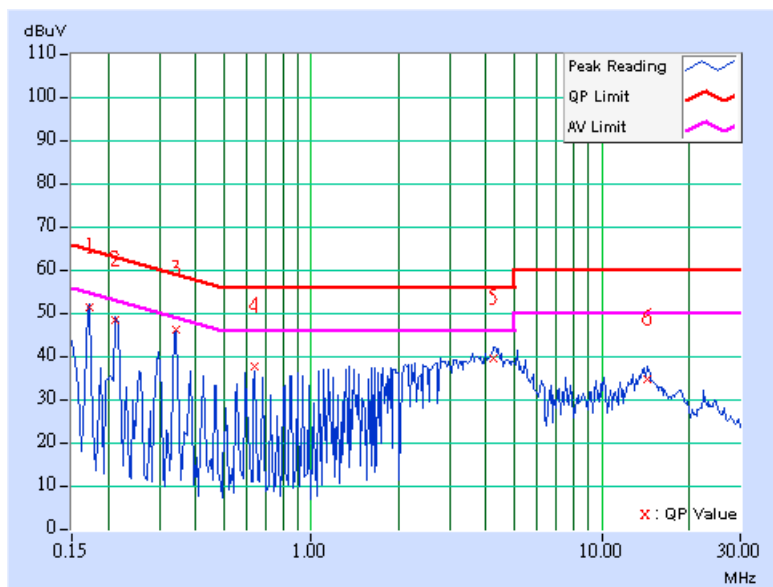



EUT TEST CONDITION		MEASUREMENT DETAIL	
CHANNEL	Channel 6	PHASE	Line 2
MODULATION TYPE	BPSK	6dB BANDWIDTH	9 kHz
TRANSFER RATE	6Mbps	INPUT POWER (SYSTEM)	120Vac, 60 Hz
ENVIRONMENTAL CONDITIONS	20deg. C, 60%RH, 991hPa	TESTED BY	Match Tsui

No	Freq. [MHz]	Corr. Factor [dB]	Reading Value [dB (uV)]		Emission Level [dB (uV)]		Limit [dB (uV)]		Margin (dB)	
			Q.P.	AV.	Q.P.	AV.	Q.P.	AV.	Q.P.	AV.
1	0.170	0.10	51.60	-	51.70	-	64.98	54.98	-13.28	-
2	0.213	0.10	46.21	-	46.31	-	63.11	53.11	-16.80	-
3	0.341	0.10	44.44	-	44.54	-	59.17	49.17	-14.63	-
4	0.852	0.18	35.88	-	36.06	-	56.00	46.00	-19.94	-
5	4.094	0.37	39.68	-	40.05	-	56.00	46.00	-15.95	-
6	14.648	0.62	33.02	-	33.64	-	60.00	50.00	-26.36	-

- REMARKS:**
1. Q.P. and AV. are abbreviations of quasi-peak and average individually.
  2. "-": The Quasi-peak reading value also meets average limit and measurement with the average detector is unnecessary.
  3. The emission levels of other frequencies were very low against the limit.
  4. Margin value = Emission level - Limit value
  5. Correction factor = Insertion loss + Cable loss
  6. Emission Level = Correction Factor + Reading Value.

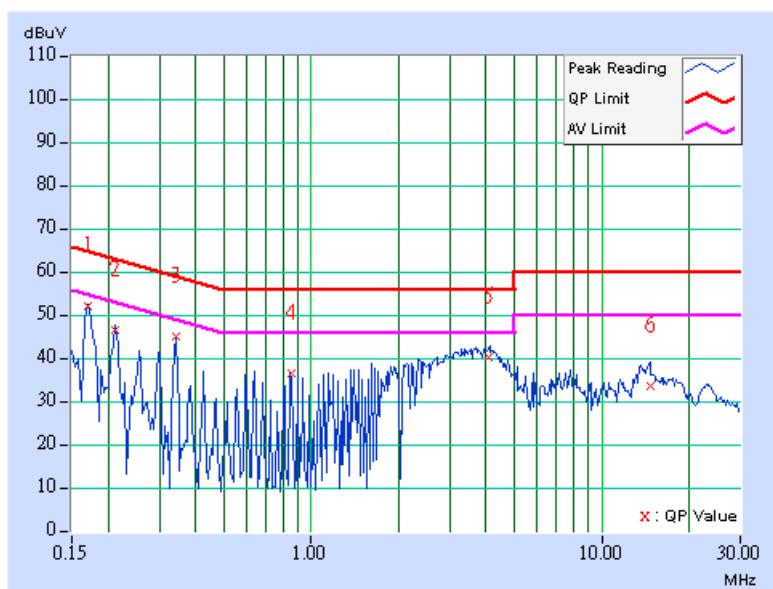

EUT TEST CONDITION		MEASUREMENT DETAIL	
CHANNEL	Channel 11	PHASE	Line 1
MODULATION TYPE	BPSK	6dB BANDWIDTH	9 kHz
TRANSFER RATE	6Mbps	INPUT POWER (SYSTEM)	120Vac, 60 Hz
ENVIRONMENTAL CONDITIONS	20deg. C, 60%RH, 991hPa	TESTED BY	Match Tsui

No	Freq. [MHz]	Corr. Factor [dB]	Reading Value [dB (uV)]		Emission Level [dB (uV)]		Limit [dB (uV)]		Margin (dB)	
			Q.P.	AV.	Q.P.	AV.	Q.P.	AV.	Q.P.	AV.
			1	0.170	0.10	52.24	-	52.34	-	64.98
2	0.216	0.10	45.72	-	45.82	-	62.96	52.96	-17.14	-
3	0.341	0.10	46.77	-	46.87	-	59.17	49.17	-12.30	-
4	0.638	0.10	36.94	-	37.04	-	56.00	46.00	-18.96	-
5	3.924	0.36	38.04	-	38.40	-	56.00	46.00	-17.60	-
6	13.508	0.55	34.57	-	35.12	-	60.00	50.00	-24.88	-

- REMARKS:**
1. Q.P. and AV. are abbreviations of quasi-peak and average individually.
  2. "-": The Quasi-peak reading value also meets average limit and measurement with the average detector is unnecessary.
  3. The emission levels of other frequencies were very low against the limit.
  4. Margin value = Emission level - Limit value
  5. Correction factor = Insertion loss + Cable loss
  6. Emission Level = Correction Factor + Reading Value.

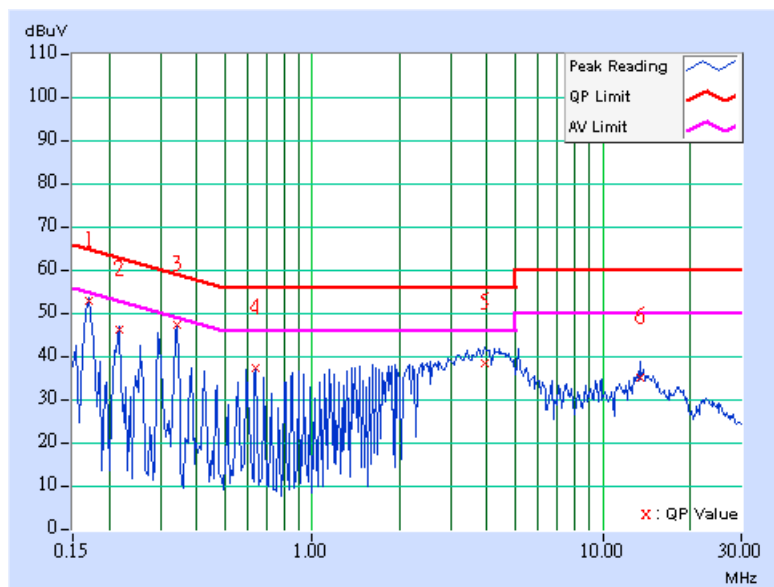

EUT TEST CONDITION		MEASUREMENT DETAIL	
CHANNEL	Channel 11	PHASE	Line 2
MODULATION TYPE	BPSK	6dB BANDWIDTH	9 kHz
TRANSFER RATE	6Mbps	INPUT POWER (SYSTEM)	120Vac, 60 Hz
ENVIRONMENTAL CONDITIONS	20deg. C, 60%RH, 991hPa	TESTED BY	Match Tsui

No	Freq. [MHz]	Corr. Factor [dB]	Reading Value [dB (uV)]		Emission Level [dB (uV)]		Limit [dB (uV)]		Margin (dB)	
			Q.P.	AV.	Q.P.	AV.	Q.P.	AV.	Q.P.	AV.
			1	0.170	0.10	51.25	-	51.35	-	64.98
2	0.213	0.10	45.95	-	46.05	-	63.11	53.11	-17.06	-
3	0.341	0.10	44.50	-	44.60	-	59.17	49.17	-14.57	-
4	0.638	0.14	36.78	-	36.92	-	56.00	46.00	-19.08	-
5	3.878	0.36	38.16	-	38.52	-	56.00	46.00	-17.48	-
6	13.852	0.59	34.59	-	35.18	-	60.00	50.00	-24.82	-

- REMARKS:**
1. Q.P. and AV. are abbreviations of quasi-peak and average individually.
  2. "-": The Quasi-peak reading value also meets average limit and measurement with the average detector is unnecessary.
  3. The emission levels of other frequencies were very low against the limit.
  4. Margin value = Emission level - Limit value
  5. Correction factor = Insertion loss + Cable loss
  6. Emission Level = Correction Factor + Reading Value.

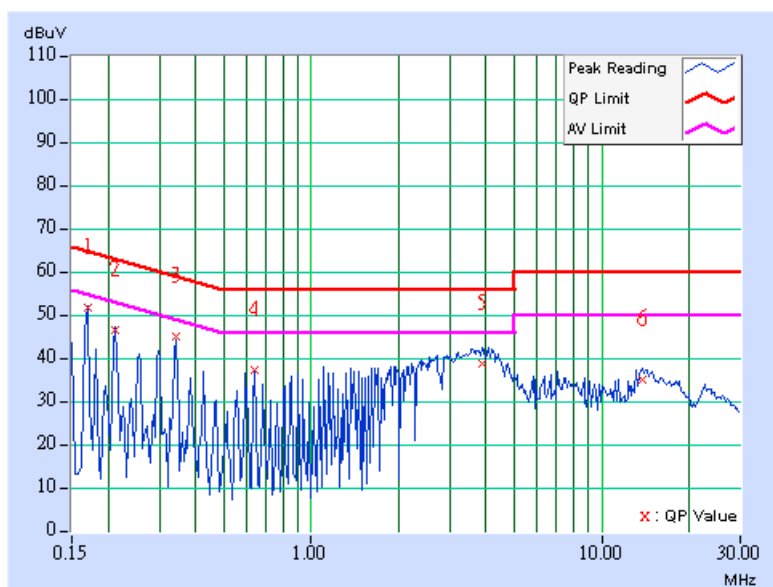

## 4.2 RADIATED EMISSION MEASUREMENT

### 4.2.1 LIMITS OF RADIATED EMISSION MEASUREMENT

Emissions radiated outside of the specified bands, shall be according to the general radiated limits in 15.209 as following:

Frequencies (MHz)	Field strength (microvolts/meter)	Measurement distance (meters)
0.009-0.490	2400/F(kHz)	300
0.490-1.705	24000/F(kHz)	30
1.705-30.0	30	30
30-88	100	3
88-216	150	3
216-960	200	3
Above 960	500	3

**NOTE:**

1. The lower limit shall apply at the transition frequencies.
2. Emission level (dBuV/m) = 20 log Emission level (uV/m).
3. As shown in 15.35(b), for frequencies above 1000MHz, the field strength limits are based on average detector, however, the peak field strength of any emission shall not exceed the maximum permitted average limits, specified above by more than 20dB under any condition of modulation.



#### 4.2.2 TEST INSTRUMENTS

DESCRIPTION & MANUFACTURER	MODEL NO.	SERIAL NO.	CALIBRATED UNTIL
Test Receiver ROHDE & SCHWARZ	ESI7	100033	May 22, 2007
Spectrum Analyzer ROHDE & SCHWARZ	FSP40	100025	Oct. 05, 2007
BILOG Antenna SCHWARZBECK	VULB9168	9168-160	May 31, 2007
HORN Antenna SCHWARZBECK	9120D	9120D-209	Jan. 27, 2007
HORN Antenna SCHWARZBECK	BBHA 9170	BBHA9170243	Dec. 28, 2007
Preamplifier Agilent	8447D	2944A10633	Oct. 26, 2007
Preamplifier Agilent	8449B	3008A01964	Oct. 26, 2007
RF signal cable HUBER+SUHNNER	SUCOFLEX 104	238137/4	Feb. 14, 2007
RF signal cable HUBER+SUHNNER	SUCOFLEX 104	233233/4	Nov. 14, 2007
Software ADT.	ADT_Radiated_V7.6	NA	NA
Antenna Tower inn-co GmbH	MA 4000	013303	NA
Antenna Tower Controller inn-co GmbH	CO2000	017303	NA
Turn Table ADT.	TT100.	TT93021703	NA
Turn Table Controller ADT.	SC100.	SC93021703	NA

- NOTE:**
1. The calibration interval of the above test instruments is 12 months and the calibrations are traceable to NML/ROC and NIST/USA.
  2. The test was performed in HwaYa Chamber 3.
  3. The horn antenna and HP preamplifier (model: 8449B) are used only for the measurement of emission frequency above 1GHz if tested.
  4. The VCCI Site Registration No. is R-237.
  5. The IC Site Registration No. is IC4924-3.

#### 4.2.3 TEST PROCEDURES

- a. The EUT was placed on the top of a rotating table 0.8 meters above the ground at a 3 meters semi-anechoic chamber. The table was rotated 360 degrees to determine the position of the highest radiation.
- b. The EUT was set 3 meters away from the interference-receiving antenna, which was mounted on the top of a variable-height antenna tower.
- c. The antenna is a broadband antenna, and its height is varied from one meter to four meters above the ground to determine the maximum value of the field strength. Both horizontal and vertical polarizations of the antenna are set to make the measurement.
- d. For each suspected emission, the EUT was arranged to its worst case and then the antenna was tuned to heights from 1 meter to 4 meters and the rotatable table was turned from 0 degrees to 360 degrees to find the maximum reading.
- e. The test-receiver system was set to Peak Detect Function and Specified Bandwidth with Maximum Hold Mode.
- f. If the emission level of the EUT in peak mode was lower than the limit specified, then testing could be stopped and the peak values of the EUT would be reported. Otherwise the emissions would be re-tested one by one using peak, quasi-peak or average method as specified and then reported in a data sheet.

**NOTE:**

1. The resolution bandwidth and video bandwidth of test receiver/spectrum analyzer is 120kHz for Peak detection (PK) and Quasi-peak detection (QP) at frequency below 1GHz.
2. The resolution bandwidth of test receiver/spectrum analyzer is 1 MHz and video bandwidth is 3MHz for Peak detection at frequency above 1GHz.
3. The resolution bandwidth of test receiver/spectrum analyzer is 1MHz and the video bandwidth is 10Hz for Average detection (AV) at frequency above 1GHz.

#### 4.2.4 DEVIATION FROM TEST STANDARD

No deviation

#### 4.2.5 TEST SETUP

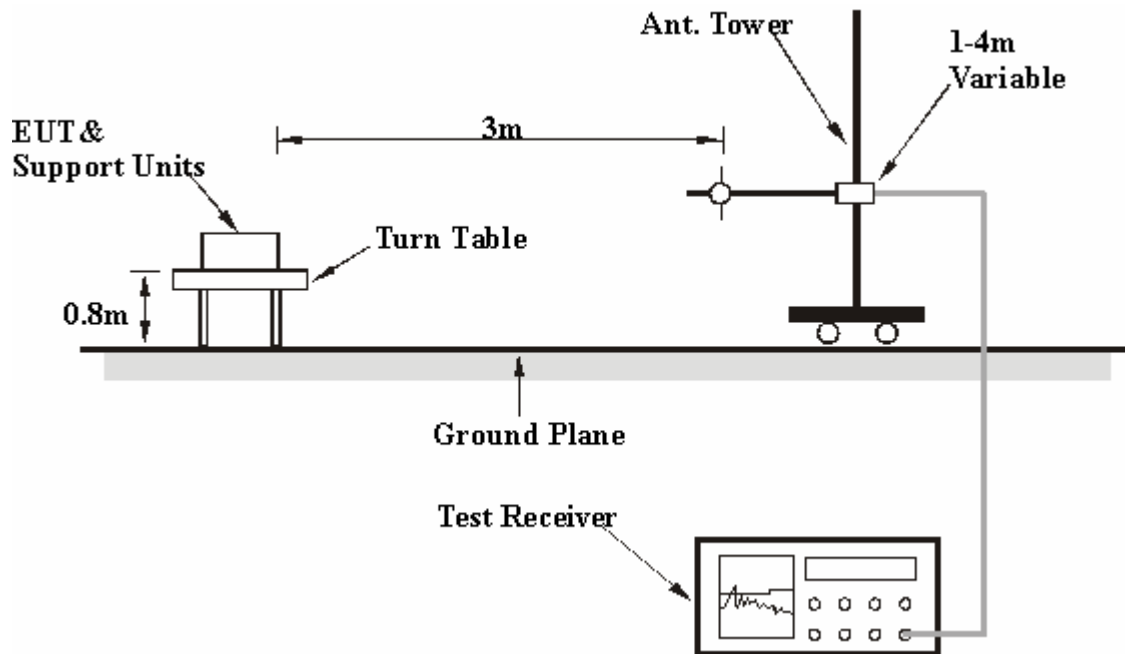

For the actual test configuration, please refer to the attached file (Test Setup Photo).

#### 4.2.6 EUT OPERATING CONDITIONS

Same as 4.1.6

## 4.2.7 TEST RESULTS

### RADIATED WORST-CASE DATA: BELOW 1GHz

EUT TEST CONDITION		MEASUREMENT DETAIL	
CHANNEL	Channel 11	FREQUENCY RANGE	Below 1000MHz
MODULATION TYPE	BPSK	DETECTOR FUNCTION	Quasi-Peak
TRANSFER RATE	6Mbps	INPUT POWER (SYSTEM)	120Vac, 60 Hz
ENVIRONMENTAL CONDITIONS	25deg. C, 68%RH, 991hPa	TESTED BY	Morgan Chen

ANTENNA POLARITY & TEST DISTANCE: HORIZONTAL AT 3 M								
No.	Freq. (MHz)	Emission Level (dBuV/m)	Limit (dBuV/m)	Margin (dB)	Antenna Height (m)	Table Angle (Degree)	Raw Value (dBuV)	Correction Factor (dB/m)
1	78.60	35.62 QP	40.00	-4.38	1.25 H	271	24.77	10.85
2	119.42	42.18 QP	43.50	-1.32	1.00 H	238	29.61	12.57
3	129.14	37.52 QP	43.50	-5.98	1.25 H	265	24.38	13.15
4	249.66	44.86 QP	46.00	-1.14	1.00 H	244	31.39	13.47
5	323.53	40.66 QP	46.00	-5.34	1.50 H	28	24.89	15.77
6	539.30	44.49 QP	46.00	-1.51	1.00 H	241	23.61	20.88

ANTENNA POLARITY & TEST DISTANCE: VERTICAL AT 3 M								
No.	Freq. (MHz)	Emission Level (dBuV/m)	Limit (dBuV/m)	Margin (dB)	Antenna Height (m)	Table Angle (Degree)	Raw Value (dBuV)	Correction Factor (dB/m)
1	47.49	38.52 QP	40.00	-1.48	1.00 V	193	23.99	14.53
2	<b>77.22</b>	<b>38.99 QP</b>	<b>40.00</b>	<b>-1.01</b>	<b>1.24 V</b>	<b>78</b>	<b>27.84</b>	<b>11.15</b>
3	101.92	38.84 QP	43.50	-4.66	1.00 V	40	28.41	10.43
4	175.79	36.47 QP	43.50	-7.03	1.00 V	301	23.15	13.32
5	249.66	41.49 QP	46.00	-4.51	1.00 V	76	28.02	13.47
6	539.30	43.01 QP	46.00	-2.99	1.25 V	235	22.13	20.88
7	648.16	37.64 QP	46.00	-8.36	1.25 V	13	14.28	23.36

- REMARKS:**
1. Emission level(dBuV/m)=Raw Value(dBuV) + Correction Factor(dB/m)
  2. Correction Factor(dB/m) = Antenna Factor (dB/m) + Cable Factor (dB)
  3. The other emission levels were very low against the limit.
  4. Margin value = Emission level – Limit value.



### 802.11b DSSS modulation

EUT TEST CONDITION		MEASUREMENT DETAIL	
CHANNEL	Channel 1	FREQUENCY RANGE	1 ~ 25GHz
MODULATION TYPE	DBPSK	DETECTOR FUNCTION	Peak(PK) Average (AV)
TRANSFER RATE	1Mbps	ENVIRONMENTAL CONDITIONS	25deg. C, 68%RH, 991hPa
INPUT POWER (SYSTEM)	120Vac, 60 Hz	TESTED BY	Morgan Chen

ANTENNA POLARITY & TEST DISTANCE: HORIZONTAL AT 3 M								
No.	Freq. (MHz)	Emission Level (dBuV/m)	Limit (dBuV/m)	Margin (dB)	Antenna Height (m)	Table Angle (Degree)	Raw Value (dBuV)	Correction Factor (dB/m)
1	2390.00	55.35 PK	74.00	-18.65	1.05 H	341	23.82	31.53
1	2390.00	43.32 AV	54.00	-10.68	1.05 H	341	11.79	31.53
2	*2412.00	101.61 PK			1.03 H	335	69.98	31.63
2	*2412.00	99.30 AV			1.03 H	335	67.67	31.63
3	2490.00	56.32 PK	74.00	-17.68	1.05 H	312	24.35	31.97
3	2490.00	44.15 AV	54.00	-9.85	1.05 H	312	12.18	31.97
4	4824.00	47.76 PK	74.00	-26.24	1.09 H	318	9.56	38.20
4	4824.00	39.75 AV	54.00	-14.25	1.09 H	318	1.55	38.20

ANTENNA POLARITY & TEST DISTANCE: VERTICAL AT 3 M								
No.	Freq. (MHz)	Emission Level (dBuV/m)	Limit (dBuV/m)	Margin (dB)	Antenna Height (m)	Table Angle (Degree)	Raw Value (dBuV)	Correction Factor (dB/m)
1	2390.00	65.82 PK	74.00	-8.18	1.13 V	342	34.29	31.53
1	2390.00	51.76 AV	54.00	-2.24	1.13 V	342	20.23	31.53
2	*2412.00	109.89 PK			1.11 V	342	78.26	31.63
2	*2412.00	105.72 AV			1.11 V	342	74.09	31.63
3	2490.00	63.68 PK	74.00	-10.32	1.12 V	346	31.71	31.97
3	2490.00	52.78 AV	54.00	-1.22	1.12 V	346	20.81	31.97
4	4824.00	48.73 PK	74.00	-25.27	1.08 V	319	10.53	38.20
4	4824.00	40.72 AV	54.00	-13.28	1.08 V	319	2.52	38.20

- REMARKS:**
1. Emission level(dBuV/m)=Raw Value(dBuV) + Correction Factor(dB/m)
  2. Correction Factor(dB/m) = Antenna Factor (dB/m) + Cable Factor (dB)
  3. The other emission levels were very low against the limit.
  4. Margin value = Emission level – Limit value.
  5. “ \* “ : Fundamental frequency.

EUT TEST CONDITION		MEASUREMENT DETAIL	
CHANNEL	Channel 6	FREQUENCY RANGE	1 ~ 25GHz
MODULATION TYPE	DBPSK	DETECTOR FUNCTION	Peak(PK) Average (AV)
TRANSFER RATE	1Mbps	ENVIRONMENTAL CONDITIONS	25deg. C, 68%RH, 991hPa
INPUT POWER (SYSTEM)	120Vac, 60 Hz	TESTED BY	Morgan Chen

ANTENNA POLARITY & TEST DISTANCE: HORIZONTAL AT 3 M								
No.	Freq. (MHz)	Emission Level (dBuV/m)	Limit (dBuV/m)	Margin (dB)	Antenna Height (m)	Table Angle (Degree)	Raw Value (dBuV)	Correction Factor (dB/m)
1	2294.00	57.23 PK	74.00	-16.77	1.06 H	306	26.16	31.07
1	2294.00	45.11 AV	54.00	-8.89	1.06 H	306	14.04	31.07
2	*2437.00	104.11 PK			1.05 H	318	72.37	31.74
2	*2437.00	101.85 AV			1.05 H	318	70.11	31.74
3	4874.00	50.11 PK	74.00	-23.89	1.08 H	5	11.85	38.26
3	4874.00	41.93 AV	54.00	-12.07	1.08 H	5	3.67	38.26

ANTENNA POLARITY & TEST DISTANCE: VERTICAL AT 3 M								
No.	Freq. (MHz)	Emission Level (dBuV/m)	Limit (dBuV/m)	Margin (dB)	Antenna Height (m)	Table Angle (Degree)	Raw Value (dBuV)	Correction Factor (dB/m)
1	2295.00	65.10 PK	74.00	-8.90	1.08 V	9	34.02	31.08
1	2295.00	52.65 AV	54.00	-1.35	1.08 V	9	21.57	31.08
2	*2437.00	113.89 PK			1.15 V	349	82.15	31.74
2	*2437.00	110.26 AV			1.15 V	349	78.52	31.74
3	4874.00	53.11 PK	74.00	-20.89	1.00 V	359	14.85	38.26
3	4874.00	47.45 AV	54.00	-6.55	1.00 V	359	9.19	38.26

- REMARKS:**
1. Emission level(dBuV/m)=Raw Value(dBuV) + Correction Factor(dB/m)
  2. Correction Factor(dB/m) = Antenna Factor (dB/m) + Cable Factor (dB)
  3. The other emission levels were very low against the limit.
  4. Margin value = Emission level – Limit value.
  5. “ \* “ : Fundamental frequency.

EUT TEST CONDITION		MEASUREMENT DETAIL	
CHANNEL	Channel 11	FREQUENCY RANGE	1 ~ 25GHz
MODULATION TYPE	DBPSK	DETECTOR FUNCTION	Peak(PK) Average (AV)
TRANSFER RATE	1Mbps	ENVIRONMENTAL CONDITIONS	25deg. C, 68%RH, 991hPa
INPUT POWER (SYSTEM)	120Vac, 60 Hz	TESTED BY	Morgan Chen

ANTENNA POLARITY & TEST DISTANCE: HORIZONTAL AT 3 M								
No.	Freq. (MHz)	Emission Level (dBuV/m)	Limit (dBuV/m)	Margin (dB)	Antenna Height (m)	Table Angle (Degree)	Raw Value (dBuV)	Correction Factor (dB/m)
1	*2462.00	99.05 PK			1.03 H	320	67.20	31.85
1	*2462.00	96.76 AV			1.03 H	320	64.91	31.85
2	2483.50	49.77 PK	74.00	-24.23	1.05 H	311	17.83	31.94
2	2483.50	37.44 AV	54.00	-16.56	1.05 H	311	5.50	31.94
3	4924.00	47.22 PK	74.00	-26.78	1.03 H	308	8.90	38.32
3	4924.00	39.17 AV	54.00	-14.83	1.03 H	308	0.85	38.32

ANTENNA POLARITY & TEST DISTANCE: VERTICAL AT 3 M								
No.	Freq. (MHz)	Emission Level (dBuV/m)	Limit (dBuV/m)	Margin (dB)	Antenna Height (m)	Table Angle (Degree)	Raw Value (dBuV)	Correction Factor (dB/m)
1	*2462.00	106.71 PK			1.12 V	347	74.86	31.85
1	*2462.00	102.83 AV			1.12 V	347	70.98	31.85
2	2483.50	68.52 PK	74.00	-5.48	1.08 V	338	36.58	31.94
2	2483.50	52.43 AV	54.00	-1.57	1.08 V	338	20.49	31.94
3	2679.00	59.38 PK	74.00	-14.62	1.01 V	18	26.99	32.39
3	2679.00	50.74 AV	54.00	-3.26	1.01 V	18	18.35	32.39
4	4924.00	47.84 PK	74.00	-26.16	1.03 V	320	9.52	38.32
4	4924.00	39.87 AV	54.00	-14.13	1.03 V	320	1.55	38.32

- REMARKS:**
1. Emission level(dBuV/m)=Raw Value(dBuV) + Correction Factor(dB/m)
  2. Correction Factor(dB/m) = Antenna Factor (dB/m) + Cable Factor (dB)
  3. The other emission levels were very low against the limit.
  4. Margin value = Emission level – Limit value.
  5. “ \* “ : Fundamental frequency.

### 802.11g OFDM MODULATION

EUT TEST CONDITION		MEASUREMENT DETAIL	
CHANNEL	Channel 1	FREQUENCY RANGE	1 ~ 25GHz
MODULATION TYPE	BPSK	DETECTOR FUNCTION	Peak(PK) Average (AV)
TRANSFER RATE	6Mbps	ENVIRONMENTAL CONDITIONS	25deg. C, 68%RH, 991hPa
INPUT POWER (SYSTEM)	120Vac, 60 Hz	TESTED BY	Morgan Chen

#### ANTENNA POLARITY & TEST DISTANCE: HORIZONTAL AT 3 M

No.	Freq. (MHz)	Emission Level (dBuV/m)	Limit (dBuV/m)	Margin (dB)	Antenna Height (m)	Table Angle (Degree)	Raw Value (dBuV)	Correction Factor (dB/m)
1	2390.00	52.03 PK	74.00	-21.97	1.09 H	345	20.50	31.53
1	2390.00	41.89 AV	54.00	-12.11	1.09 H	345	10.36	31.53
2	*2412.00	103.12 PK			1.17 H	322	71.49	31.63
2	*2412.00	93.08 AV			1.17 H	322	61.45	31.63
3	4824.00	47.25 PK	74.00	-26.75	1.05 H	16	9.05	38.20
3	4824.00	35.21 AV	54.00	-18.79	1.05 H	16	-2.99	38.20

#### ANTENNA POLARITY & TEST DISTANCE: VERTICAL AT 3 M

No.	Freq. (MHz)	Emission Level (dBuV/m)	Limit (dBuV/m)	Margin (dB)	Antenna Height (m)	Table Angle (Degree)	Raw Value (dBuV)	Correction Factor (dB/m)
1	2390.00	65.82 PK	74.00	-8.18	1.25 V	26	34.29	31.53
1	2390.00	52.38 AV	54.00	-1.62	1.25 V	26	20.85	31.53
2	*2412.00	106.88 PK			1.13 V	324	75.25	31.63
2	*2412.00	96.55 AV			1.13 V	324	64.92	31.63
3	4824.00	45.98 PK	74.00	-28.02	1.08 V	16	7.78	38.20
3	4824.00	33.81 AV	54.00	-20.19	1.08 V	16	-4.39	38.20

- REMARKS:**
1. Emission level(dBuV/m)=Raw Value(dBuV) + Correction Factor(dB/m)
  2. Correction Factor(dB/m) = Antenna Factor (dB/m) + Cable Factor (dB)
  3. The other emission levels were very low against the limit.
  4. Margin value = Emission level – Limit value.
  5. “ \* “ : Fundamental frequency.

EUT TEST CONDITION		MEASUREMENT DETAIL	
CHANNEL	Channel 6	FREQUENCY RANGE	1 ~ 25GHz
MODULATION TYPE	BPSK	DETECTOR FUNCTION	Peak(PK) Average (AV)
TRANSFER RATE	6Mbps	ENVIRONMENTAL CONDITIONS	25deg. C, 68%RH, 991hPa
INPUT POWER (SYSTEM)	120Vac, 60 Hz	TEST BY	Morgan Chen

ANTENNA POLARITY & TEST DISTANCE: HORIZONTAL AT 3 M								
No.	Freq. (MHz)	Emission Level (dBuV/m)	Limit (dBuV/m)	Margin (dB)	Antenna Height (m)	Table Angle (Degree)	Raw Value (dBuV)	Correction Factor (dB/m)
1	*2437.00	103.51 PK			1.28 H	309	71.77	31.74
1	*2437.00	93.45 AV			1.28 H	309	61.71	31.74
2	2483.50	52.33 PK	74.00	-21.67	1.15 H	353	20.39	31.94
2	2483.50	42.45 AV	54.00	-11.55	1.15 H	353	10.51	31.94
3	4874.00	47.19 PK	74.00	-26.81	1.07 H	26	8.93	38.26
3	4874.00	35.09 AV	54.00	-18.91	1.07 H	26	-3.17	38.26

ANTENNA POLARITY & TEST DISTANCE: VERTICAL AT 3 M								
No.	Freq. (MHz)	Emission Level (dBuV/m)	Limit (dBuV/m)	Margin (dB)	Antenna Height (m)	Table Angle (Degree)	Raw Value (dBuV)	Correction Factor (dB/m)
1	*2437.00	113.42 PK			1.18 V	3	81.68	31.74
1	*2437.00	103.21 AV			1.18 V	3	71.47	31.74
2	2483.50	52.39 PK	74.00	-21.61	1.13 V	32	20.45	31.94
2	2483.50	51.55 AV	54.00	-2.45	1.13 V	32	19.61	31.94
3	2655.00	26.53 PK	74.00	-47.47	1.11 V	25	-5.82	32.35
3	2655.00	17.36 AV	54.00	-36.64	1.11 V	25	-14.98	32.35
4	4874.00	47.85 PK	74.00	-26.15	1.08 V	22	9.59	38.26
4	4874.00	35.68 AV	54.00	-18.32	1.08 V	22	-2.58	38.26

- REMARKS:**
1. Emission level(dBuV/m)=Raw Value(dBuV) + Correction Factor(dB/m)
  2. Correction Factor(dB/m) = Antenna Factor (dB/m) + Cable Factor (dB)
  3. The other emission levels were very low against the limit.
  4. Margin value = Emission level – Limit value.
  5. “ \* “ : Fundamental frequency.

EUT TEST CONDITION		MEASUREMENT DETAIL	
CHANNEL	Channel 11	FREQUENCY RANGE	1 ~ 25GHz
MODULATION TYPE	BPSK	DETECTOR FUNCTION	Peak(PK) Average (AV)
TRANSFER RATE	6Mbps	ENVIRONMENTAL CONDITIONS	25deg. C, 68%RH, 991hPa
INPUT POWER (SYSTEM)	120Vac, 60 Hz	TEST BY	Morgan Chen

ANTENNA POLARITY & TEST DISTANCE: HORIZONTAL AT 3 M								
No.	Freq. (MHz)	Emission Level (dBuV/m)	Limit (dBuV/m)	Margin (dB)	Antenna Height (m)	Table Angle (Degree)	Raw Value (dBuV)	Correction Factor (dB/m)
1	*2462.00	103.32 PK			1.18 H	325	71.47	31.85
1	*2462.00	93.45 AV			1.18 H	325	61.60	31.85
2	2483.50	63.03 PK	74.00	-10.97	1.19 H	345	31.09	31.94
2	2483.50	50.22 AV	54.00	-3.78	1.19 H	345	18.28	31.94
3	4924.00	45.35 PK	74.00	-28.65	1.08 H	308	7.03	38.32
3	4924.00	33.28 AV	54.00	-20.72	1.08 H	308	-5.04	38.32

ANTENNA POLARITY & TEST DISTANCE: VERTICAL AT 3 M								
No.	Freq. (MHz)	Emission Level (dBuV/m)	Limit (dBuV/m)	Margin (dB)	Antenna Height (m)	Table Angle (Degree)	Raw Value (dBuV)	Correction Factor (dB/m)
1	*2462.00	107.39 PK			1.18 V	306	75.54	31.85
1	*2462.00	97.15 AV			1.18 V	306	65.30	31.85
2	2483.50	66.12 PK	74.00	-7.88	1.35 V	3	34.18	31.94
2	2483.50	52.65 AV	54.00	-1.35	1.35 V	3	20.71	31.94
3	4924.00	45.98 PK	74.00	-28.02	1.15 V	35	7.66	38.32
3	4924.00	33.61 AV	54.00	-20.39	1.15 V	35	-4.71	38.32

- REMARKS:**
1. Emission level(dBuV/m)=Raw Value(dBuV) + Correction Factor(dB/m)
  2. Correction Factor(dB/m) = Antenna Factor (dB/m) + Cable Factor (dB)
  3. The other emission levels were very low against the limit.
  4. Margin value = Emission level – Limit value.
  5. “ \* “ : Fundamental frequency.



### 4.3 BAND EDGES MEASUREMENT

#### 4.3.1 LIMITS OF BAND EDGES MEASUREMENT

Below  $-20\text{dB}$  of the highest emission level of operating band (in 100kHz Resolution Bandwidth).

#### 4.3.2 TEST INSTRUMENTS

DESCRIPTION & MANUFACTURER	MODEL NO.	SERIAL NO.	CALIBRATED UNTIL
R&S SPECTRUM ANALYZER	FSP40	100040	Jun. 07, 2007

**NOTE:** The calibration interval of the above test instruments is 12 months and the calibrations are traceable to NML/ROC and NIST/USA.

#### 4.3.3 TEST PROCEDURE

The transmitter output was connected to the spectrum analyzer via a low loss cable. Set both RBW and VBW of spectrum analyzer to 100kHz with suitable frequency span including 100MHz bandwidth from band edge. The band edges was measured and recorded. The spectrum plots (Peak RBW=VBW=100kHz; Average RBW=1MHz, VBW=10Hz) are attached on the following pages.

#### 4.3.4 DEVIATION FROM TEST STANDARD

No deviation

#### 4.3.5 EUT OPERATING CONDITION

Same as Item 4.3.6

#### 4.3.6 TEST RESULTS

The spectrum plots are attached on the following 12 images. D1 line indicates the highest level, and D2 line indicates the 20dB offset below D1. It shows compliance with the requirement in part 15.247(d).

#### 802.11b DSSS MODULATION

**NOTE 1:** The band edge emission plot of DSSS technique on the next second page shows 45.06dBc between carrier maximum power and local maximum emission in restrict band (2.36816GHz). The emission of carrier strength list in the test result of channel 1 at the item 4.2.7 is 109.89dBuV/m (Peak), so the maximum field strength in restrict band is  $109.89 - 45.06 = 64.83$ dBuV/m which is under 74dBuV/m limit.

The band edge emission plot of DSSS technique on the next second page shows 54.02dBc between carrier maximum power and local maximum emission in restrict band (2.39000GHz). The emission of carrier strength list in the test result of channel 1 at the item 4.2.7 is 105.72dBuV/m (Average), so the maximum field strength in restrict band is  $105.72 - 54.02 = 51.70$ dBuV/m which is under 54dBuV/m limit.

**NOTE 2:** The band edge emission plot of DSSS technique on the next third page shows 43.22dBc between carrier maximum power and local maximum emission in restrict band (2.48406GHz). The emission of carrier strength list in the test result of channel 11 at the item 4.2.7 is 106.71dBuV/m (Peak), so the maximum field strength in restrict band is  $106.71 - 43.22 = 63.49$ dBuV/m which is under 74dBuV/m limit.

The band edge emission plot of DSSS technique on the next fourth page shows 49.77dBc between carrier maximum power and local maximum emission in restrict band (2.48350GHz). The emission of carrier strength list in the test result of channel 11 at the item 4.2.7 is 102.83dBuV/m (Average), so the maximum field strength in restrict band is  $102.83 - 49.77 = 53.06$ dBuV/m which is under 54dBuV/m limit.



### 802.11b DSSS MODULATION

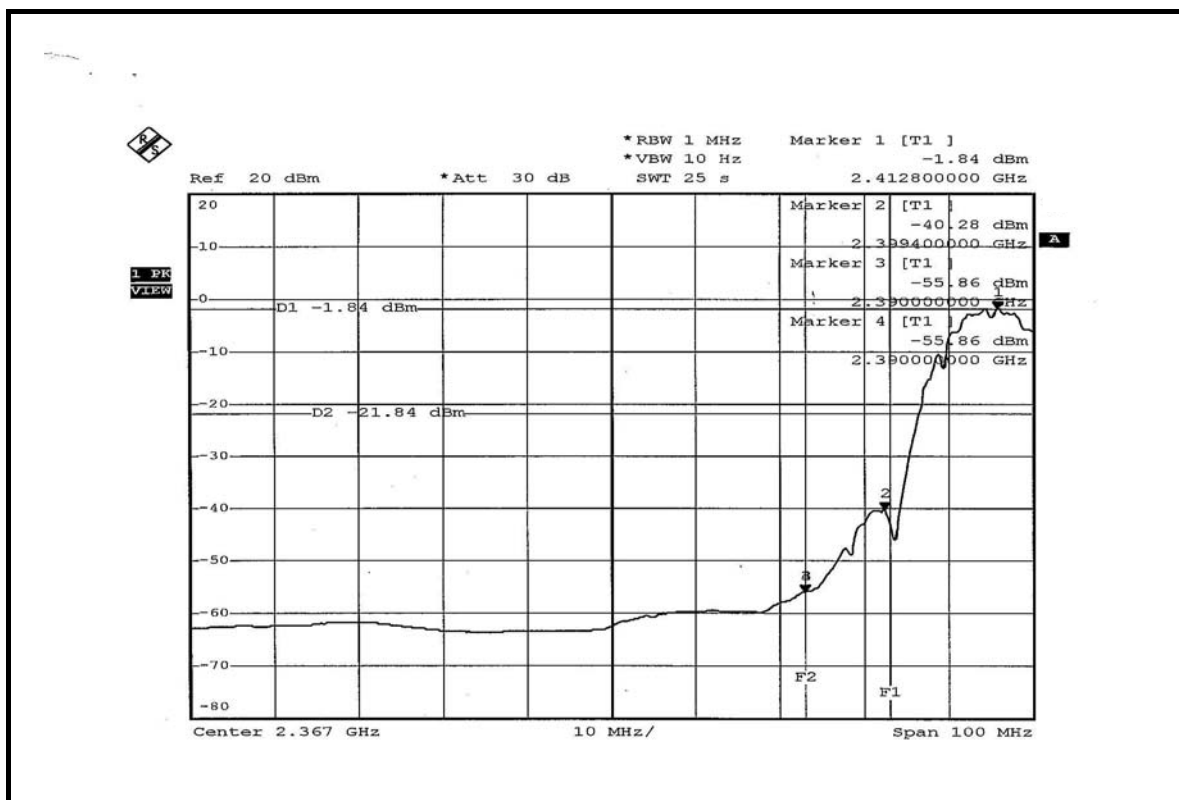
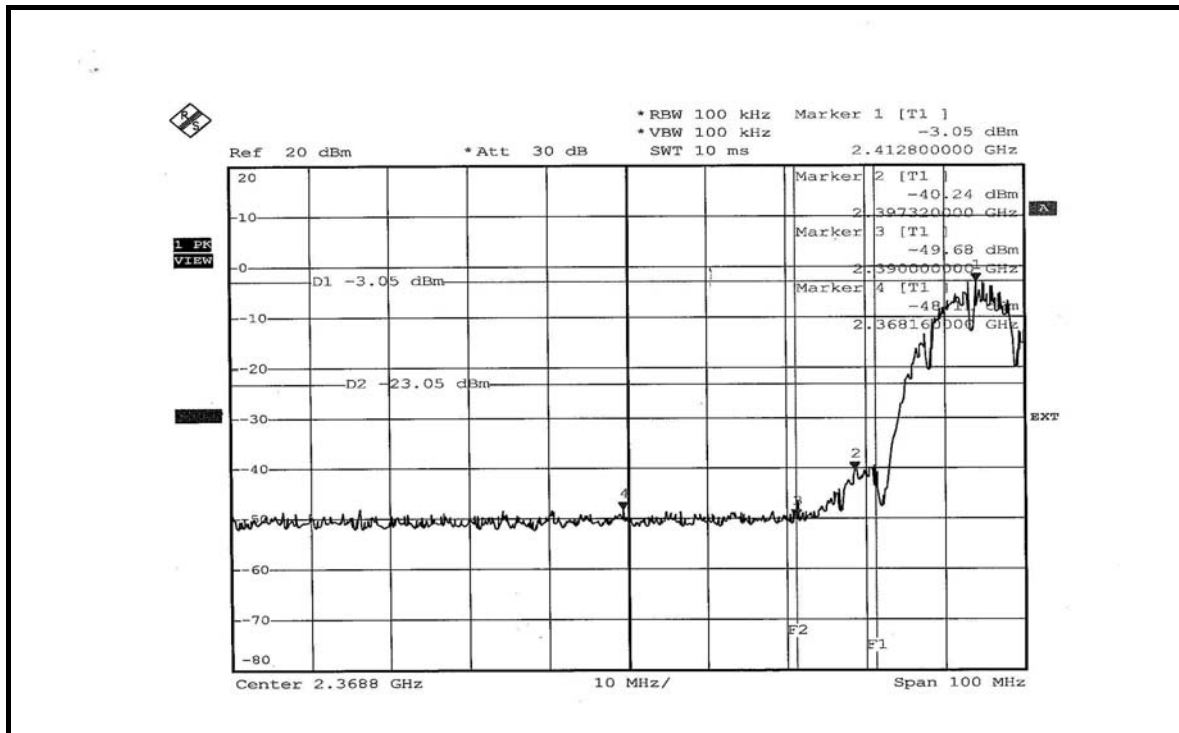

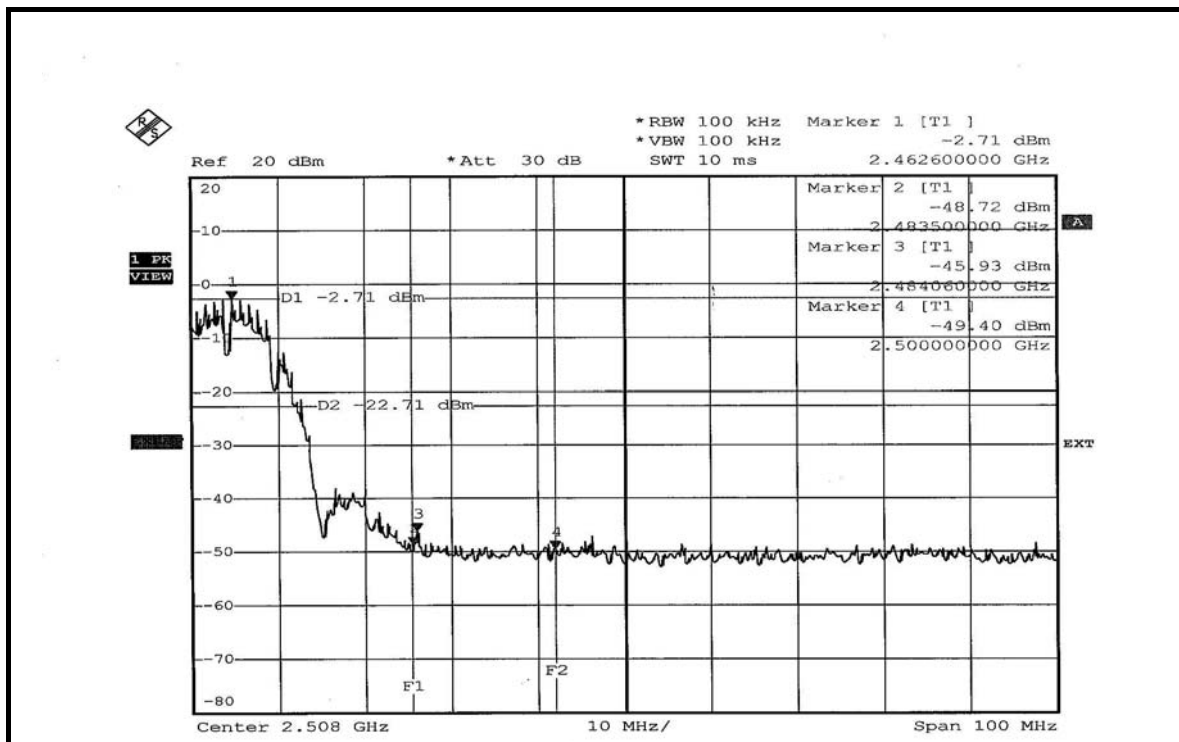
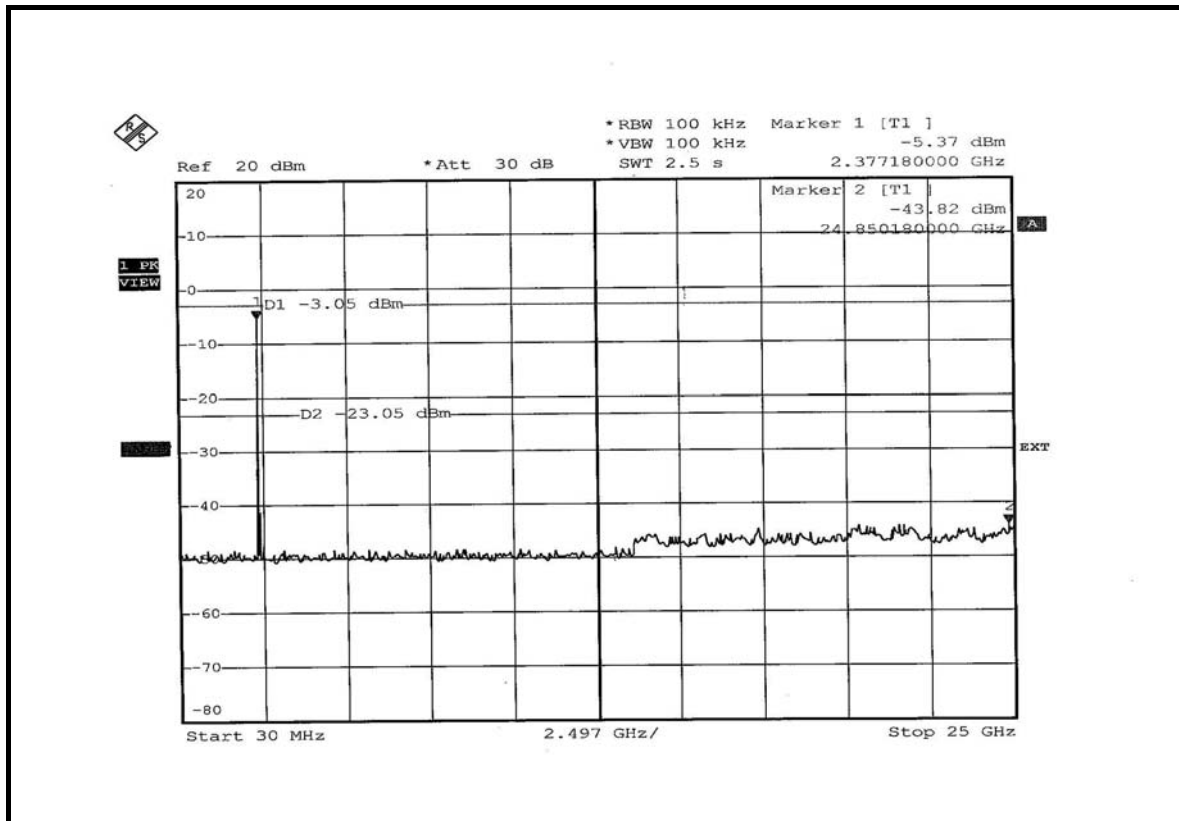

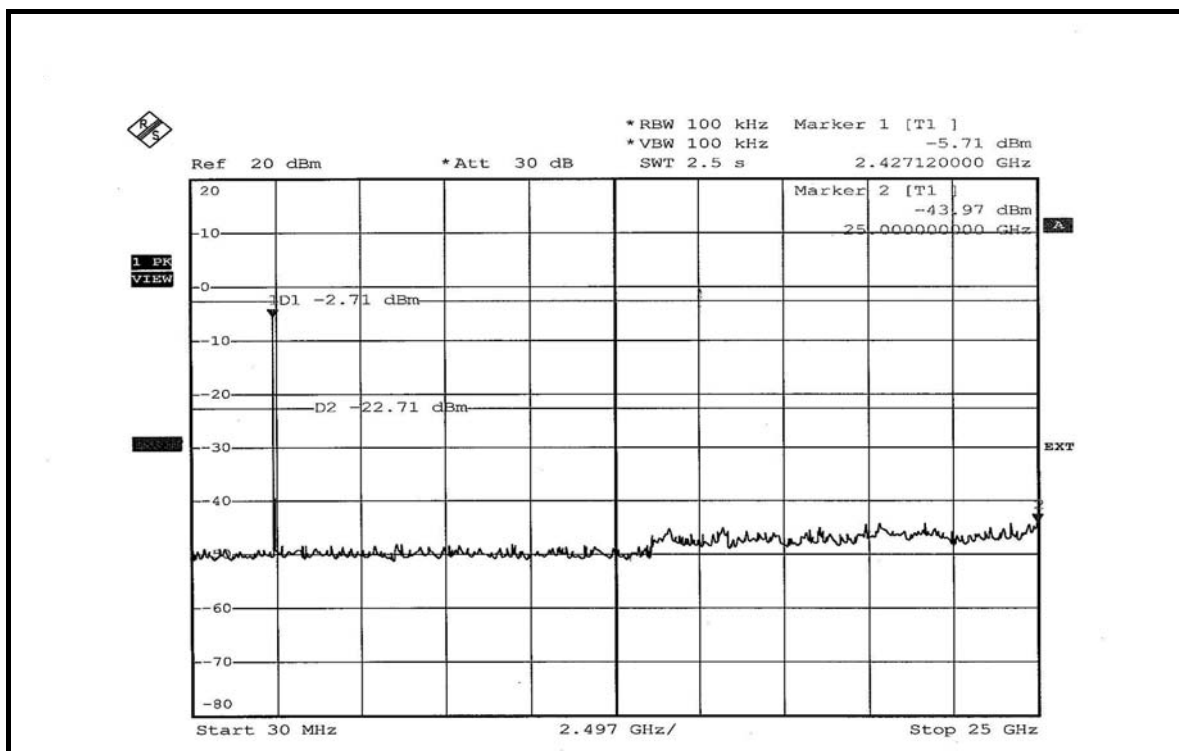
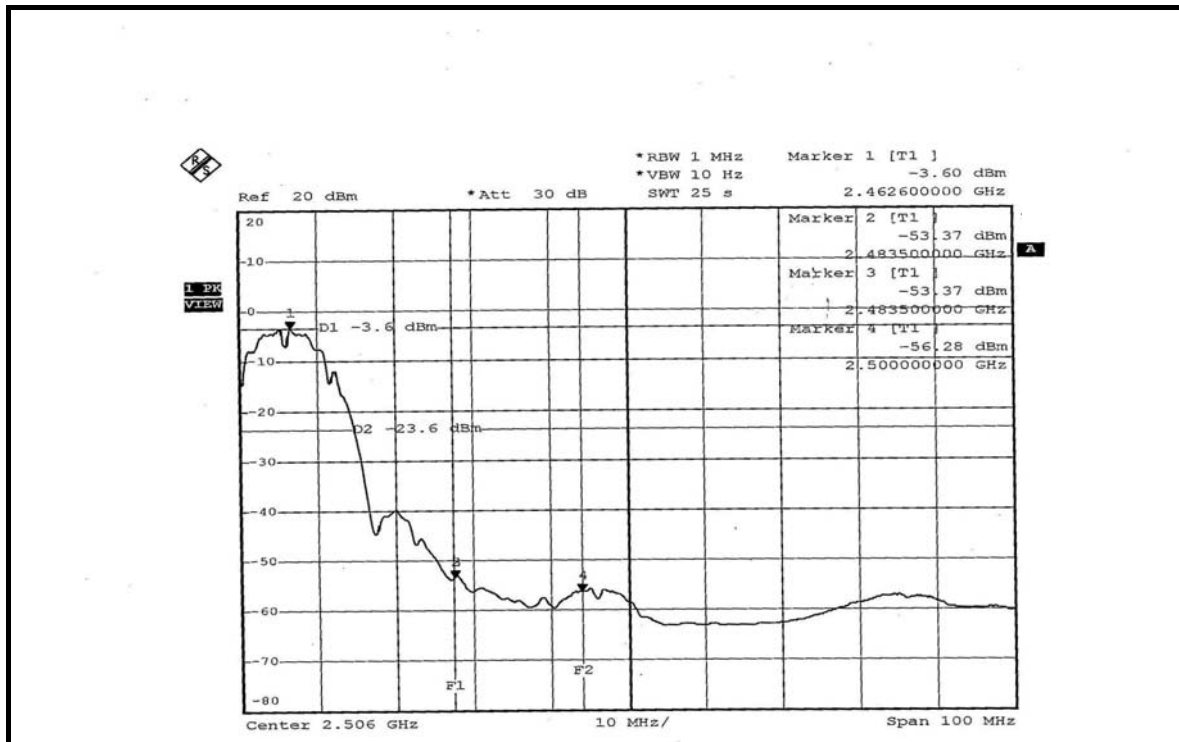

## 802.11g OFDM MODULATION

**NOTE 1:** The band edge emission plot of OFDM technique on the next second page shows 39.15dBc between carrier maximum power and local maximum emission in restrict band (2.36820GHz). The emission of carrier strength list in the test result of channel 1 at the item 4.2.7 is 106.88dBuV/m (Peak), so the maximum field strength in restrict band is  $106.88 - 39.15 = 67.73$ dBuV/m which is under 74dBuV/m limit.

The band edge emission plot of OFDM technique on the next second page shows 46.00dBc between carrier maximum power and local maximum emission in restrict band (2.39000GHz). The emission of carrier strength list in the test result of channel 1 at the item 4.2.7 is 96.55dBuV/m (Average), so the maximum field strength in restrict band is  $96.55 - 46.00 = 50.55$ dBuV/m which is under 54dBuV/m limit.

**NOTE 2:** The band edge emission plot of OFDM technique on the next third second page shows 39.44dBc between carrier maximum power and local maximum emission in restrict band (2.48996GHz). The emission of carrier strength list in the test result of channel 11 at the item 4.2.7 is 107.39dBuV/m (Peak), so the maximum field strength in restrict band is  $107.39 - 39.44 = 67.95$ dBuV/m which is under 74dBuV/m limit.

The band edge emission plot of OFDM technique on the next fourth page shows 43.35dBc between carrier maximum power and local maximum emission in restrict band (2.48350GHz). The emission of carrier strength list in the test result of channel 11 at the item 4.2.7 is 97.15dBuV/m (Average), so the maximum field strength in restrict band is  $97.15 - 43.35 = 53.80$ dBuV/m which is under 54dBuV/m limit.

### 802.11g OFDM MODULATION

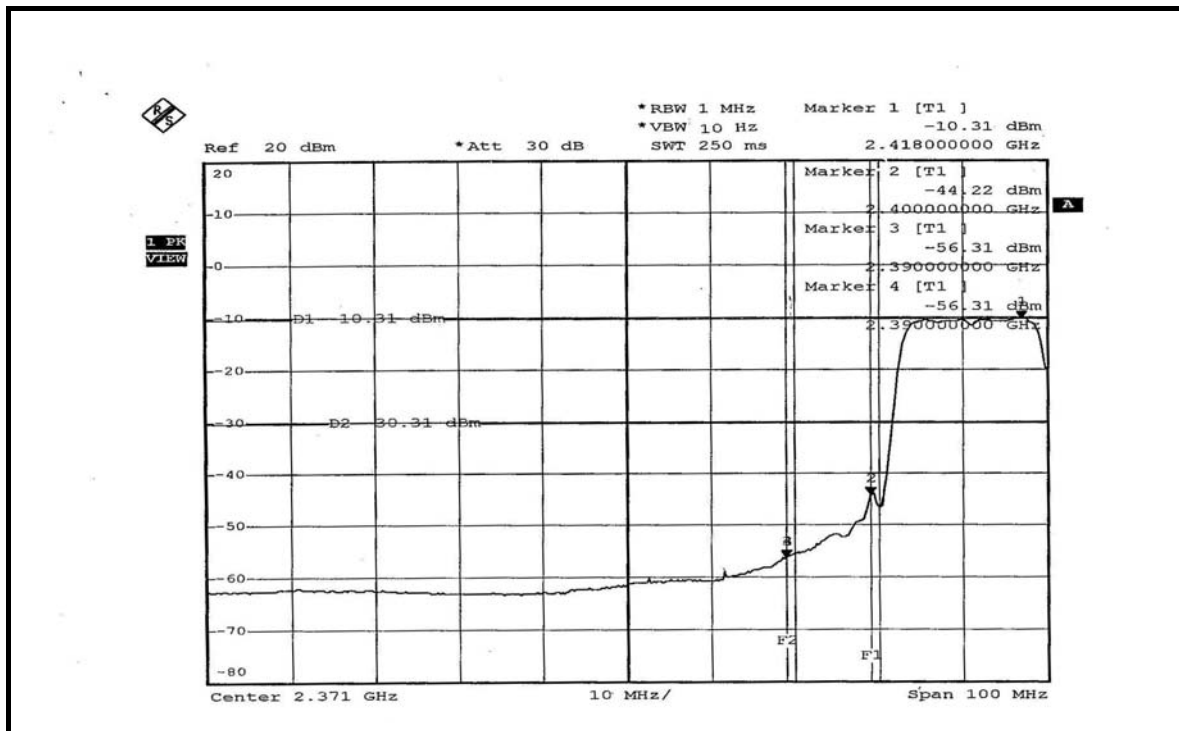
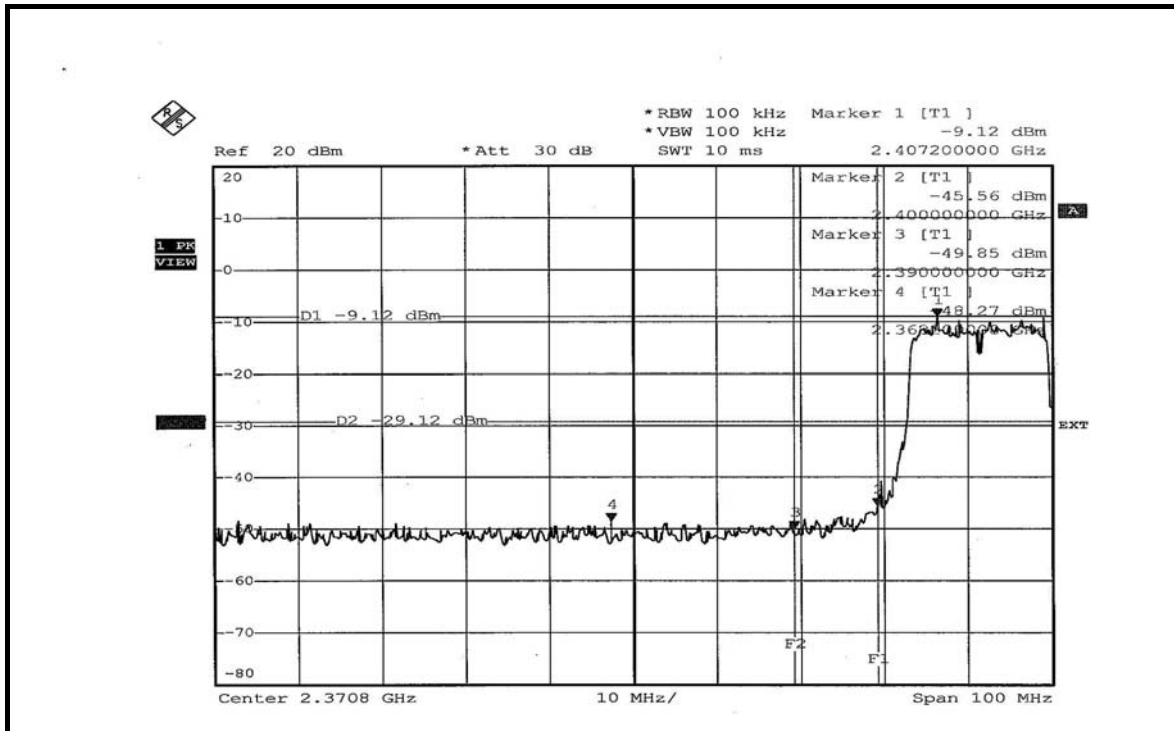

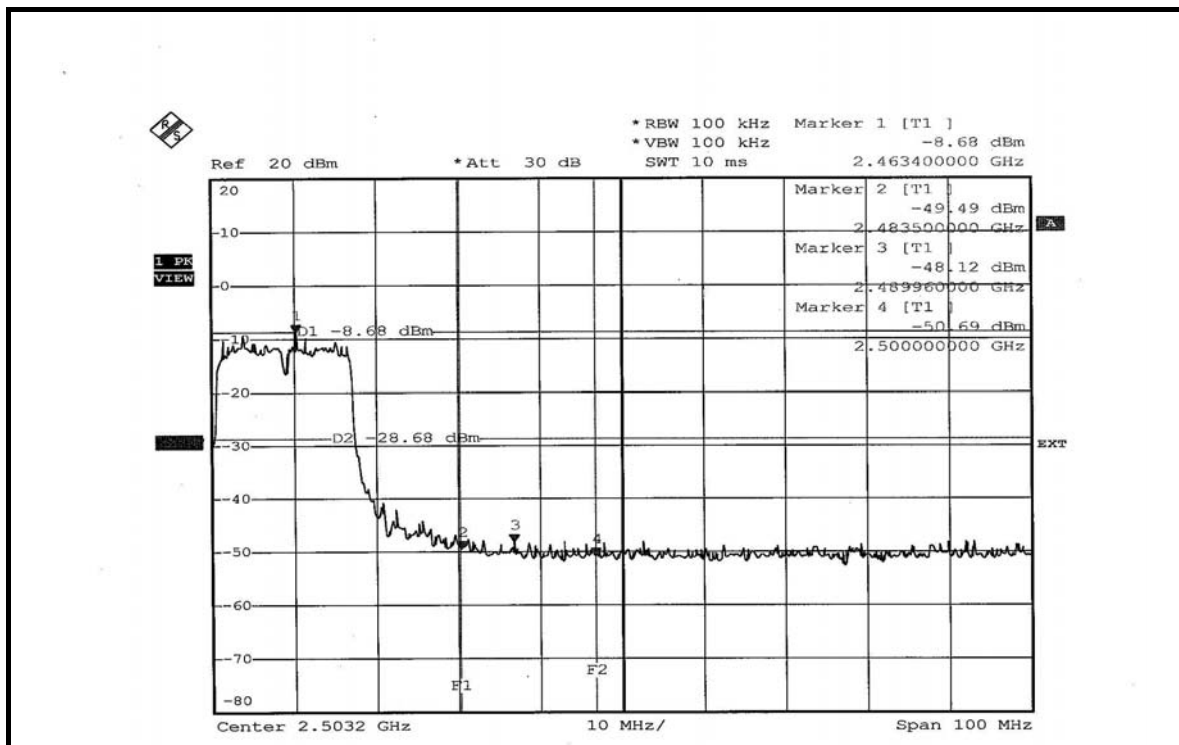
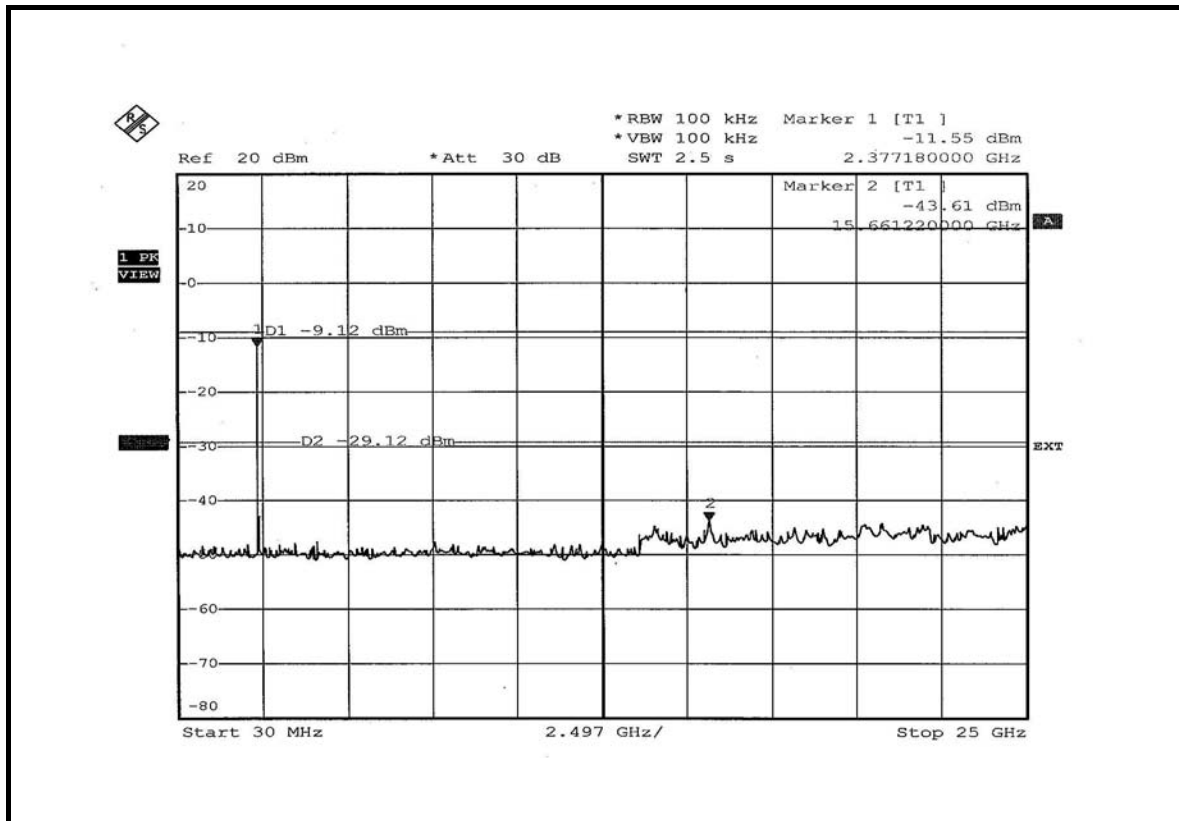

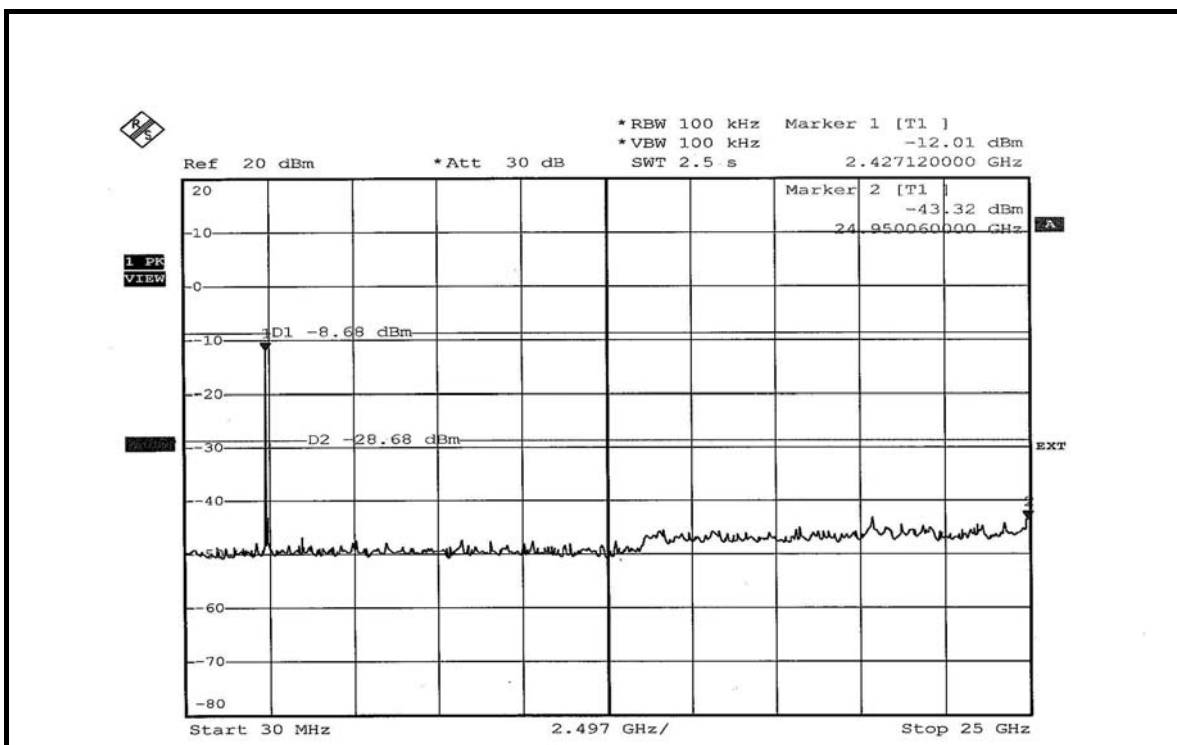
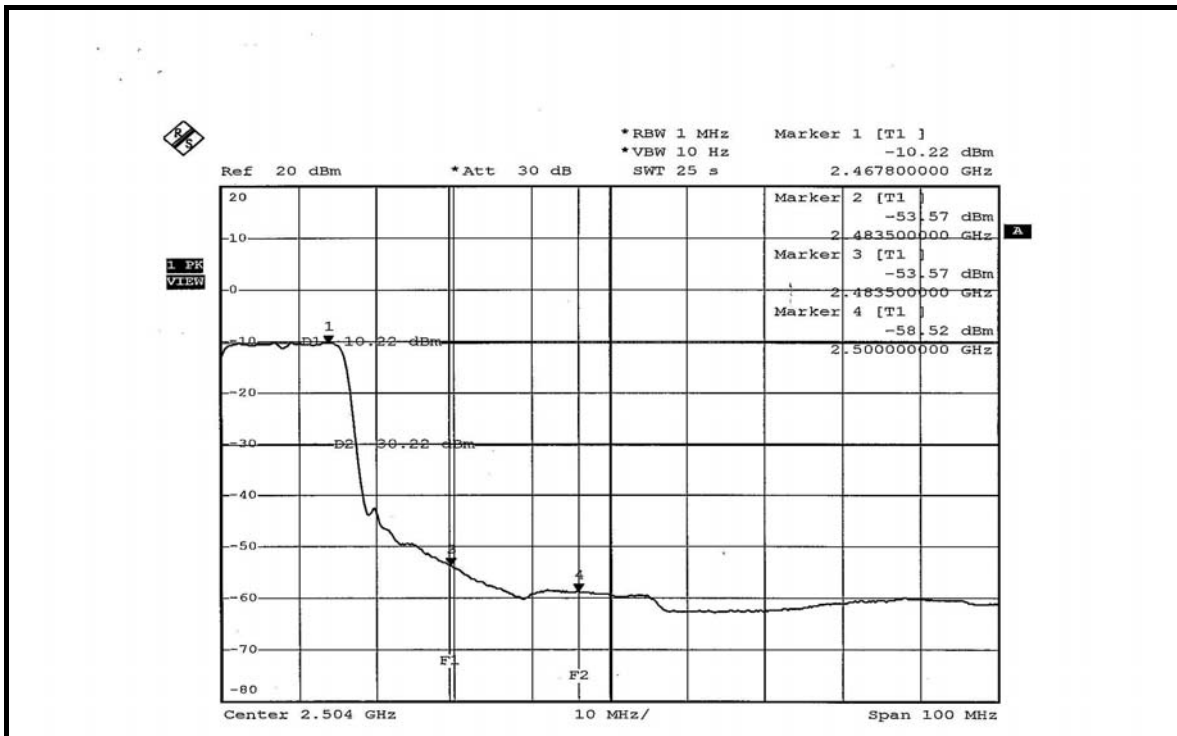



## 5 INFORMATION ON THE TESTING LABORATORIES

We, ADT Corp., were founded in 1988 to provide our best service in EMC, Radio, Telecom and Safety consultation. Our laboratories are accredited and approved by the following approval agencies according to ISO/IEC 17025:

<b>USA</b>	FCC, UL, A2LA
<b>Germany</b>	TUV Rheinland
<b>Japan</b>	VCCI
<b>Norway</b>	NEMKO
<b>Canada</b>	INDUSTRY CANADA , CSA
<b>R.O.C.</b>	CNLA, BSMI, NCC
<b>Netherlands</b>	Telefication
<b>Singapore</b>	PSB , GOST-ASIA(MOU)
<b>Russia</b>	CERTIS(MOU)

Copies of accreditation certificates of our laboratories obtained from approval agencies can be downloaded from our web site: [www.adt.com.tw/index.5/phtml](http://www.adt.com.tw/index.5/phtml). If you have any comments, please feel free to contact us at the following:

### **Linko EMC/RF Lab**

Tel: 886-2-26052180

Fax: 886-2-26051924

### **Hsin Chu EMC/RF Lab**

Tel: 886-3-5935343

Fax: 886-3-5935342

### **Hwa Ya EMC/RF/Safety/Telecom Lab**

Tel: 886-3-3183232

Fax: 886-3-3185050

**Web Site:** [www.adt.com.tw](http://www.adt.com.tw)

The address and road map of all our labs can be found in our web site also.





## **APPENDIX-A**

### **MODIFICATIONS RECORDERS FOR ENGINEERING CHANGES TO THE EUT BY THE LAB**

No any modifications are made to the EUT by the lab during the test.