



Produkte
Products

Prüfbericht - Nr.: 10041843 001 <i>Test Report No.:</i>			Seite 1 von 41 Page 1 of 41		
Auftraggeber: <i>Client:</i>			Powertech Industrial Co., Ltd. 10F, No. 407, Chung Shan Rd., Sec 2 Chung Ho City, Taipei Hsien, 235, Taiwan		
Gegenstand der Prüfung: <i>Test item:</i>			APPS Power Control Timer Strip		
Bezeichnung: <i>Identification:</i>		R9P627	Serien-Nr.: <i>Serial No.:</i>		N/A
Wareneingangs-Nr.: <i>Receipt No.:</i>		800023343	Eingangsdatum: <i>Date of receipt:</i>		03/15/2013
Zustand des Prüfgegenstandes bei Anlieferung: <i>Condition of test item at delivery:</i>			The sample is ok for testing and not damaged		
Prüfort: <i>Testing location:</i>			TÜV Rheinland Taiwan Ltd. 11F., No.758, Sec. 4, Bade Rd., Songshan Dist., Taipei City 105 Taiwan FCC Registration No.: 365730		
Prüfgrundlage: <i>Test specification:</i>			FCC CFR47 Part 15: Subpart C Section 15.247		
Prüfergebnis: <i>Test Result:</i>			Der Prüfgegenstand entspricht oben genannter Prüfgrundlage(n). <i>The test item passed the test specification(s).</i>		
Prüflaboratorium: <i>Testing Laboratory:</i>			TÜV Rheinland Taiwan Ltd. 11F., No.758, Sec. 4, Bade Rd., Songshan Dist., Taipei City 105, Taiwan, R.O.C.		
geprüft/ tested by:			kontrolliert/ reviewed by:		
					
2013-05-23 Arvin Ho/Department Manager			2013-05-23 Rene Charton/Senior Project Manager		
Datum <i>Date</i>	Name/Stellung <i>Name/Position</i>	Unterschrift <i>Signature</i>	Datum <i>Date</i>	Name/Stellung <i>Name/Position</i>	Unterschrift <i>Signature</i>
Sonstiges/ Other Aspects:					
Abkürzungen: P(ass) = entspricht Prüfgrundlage F(ail) = entspricht nicht Prüfgrundlage N/A = nicht anwendbar N/T = nicht getestet			Abbreviations: P(ass) = passed F(ail) = failed N/A = not applicable N/T = not tested		
Dieser Prüfbericht bezieht sich nur auf das o.g. Prüfmuster und darf ohne Genehmigung der Prüfstelle nicht auszugsweise vervielfältigt werden. Dieser Bericht berechtigt nicht zur Verwendung eines Prüfzeichens. <i>This test report relates to the a. m. test item. Without permission of the test center this test report is not permitted to be duplicated in extracts. This test report does not entitle to carry any safety mark on this or similar products.</i>					

TEST SUMMARY

5.1.1 ANTENNA REQUIREMENT*RESULT: Passed***5.1.2 PEAK OUTPUT POWER***RESULT: Passed***5.1.3 20DB BANDWIDTH***RESULT: Passed***5.1.4 99% BANDWIDTH***RESULT: Passed***5.1.5 CONDUCTED SPURIOUS EMISSIONS AND FREQUENCY BAND EDGE MEASURED IN 100KHZ BANDWIDTH***RESULT: Passed***5.1.6 SPURIOUS EMISSION***RESULT: Passed***5.1.7 FREQUENCY SEPARATION***RESULT: Passed***5.1.8 NUMBER OF HOPPING FREQUENCY***RESULT: Passed***5.1.9 TIME OF OCCUPANCY***RESULT: Passed***5.2.1 MAINS CONDUCTED EMISSIONS***RESULT: Passed***6.1.1 ELECTROMAGNETIC FIELDS***RESULT: Passed*

Contents

1.	GENERAL REMARKS	4
1.1	COMPLEMENTARY MATERIALS	4
2.	TEST SITES	5
2.1	TEST FACILITIES	5
2.2	LIST OF TEST AND MEASUREMENT INSTRUMENTS.....	5
2.3	TRACEABILITY	6
2.4	CALIBRATION	6
2.5	MEASUREMENT UNCERTAINTY.....	6
3.	GENERAL PRODUCT INFORMATION	7
3.1	PRODUCT FUNCTION AND INTENDED USE.....	7
3.2	RATINGS AND SYSTEM DETAILS	7
3.3	INDEPENDENT OPERATION MODES	8
3.4	NOISE GENERATING AND NOISE SUPPRESSING PARTS	9
3.5	SUBMITTED DOCUMENTS	9
4.	TEST SET-UP AND OPERATION MODES	10
4.1	PRINCIPLE OF CONFIGURATION SELECTION.....	10
4.2	TEST OPERATION AND TEST SOFTWARE	10
4.3	SPECIAL ACCESSORIES AND AUXILIARY EQUIPMENT	10
4.4	COUNTERMEASURES TO ACHIEVE EMC COMPLIANCE.....	11
4.5	TEST SETUP DIAGRAM	11
5.	TEST RESULTS	13
5.1	TRANSMITTER REQUIREMENT & TEST SUITES	13
5.1.1	<i>Antenna Requirement</i>	<i>13</i>
5.1.2	<i>Peak Output Power</i>	<i>14</i>
5.1.3	<i>20dB Bandwidth</i>	<i>18</i>
5.1.4	<i>Conducted spurious emissions and Frequency Band Edge measured in 100kHz Bandwidth..</i>	<i>22</i>
5.1.5	<i>Spurious Emission</i>	<i>28</i>
5.1.6	<i>Frequency Separation.....</i>	<i>29</i>
5.1.7	<i>Number of hopping frequency.....</i>	<i>31</i>
5.1.8	<i>Time of Occupancy</i>	<i>33</i>
5.2	MAINS EMISSIONS.....	36
5.2.1	<i>Mains Conducted Emissions.....</i>	<i>36</i>
6.	SAFETY HUMAN EXPOSURE	37
6.1	RADIO FREQUENCY EXPOSURE COMPLIANCE.....	37
6.1.1	<i>Electromagnetic Fields.....</i>	<i>37</i>
7.	PHOTOGRAPHS OF THE TEST SET-UP	38
8.	LIST OF TABLES	41
9.	LIST OF PHOTOGRAPHS	41

1. General Remarks

1.1 Complementary Materials

All attachments are integral parts of this test report. This applies especially to the following appendix:

Appendix P: Photo Documentation

(File Name: 10041843APPENDIX P)

Appendix D: Test Result of Radiated Emissions

(File Name: 10041843APPENDIX D)

Test Specifications

The following standards were applied (in bold: product standards, otherwise: basic standards).

Table 1: Applied Standard and Test Levels

Radio
FCC CFR47 Part 15: Subpart C Section 15.247
ANSI C63.4:2009, Public Notice DA 00-705

2. Test Sites

2.1 Test Facilities

TUV Rheinland Taiwan Ltd.

11F. No.758, Sec. 4, Bade Rd., Songshan Dist.
 Taipei City 105
 Taiwan (R.O.C.)
 FCC Registration No.: 365730

2.2 List of Test and Measurement Instruments

Table 2: List of Test and Measurement Equipment

	Manufacturer	Type	S/N	Calibrated until
EMI Test Receiver	R&S	ESCI 7	1166.5950K07-100797-Pt	20-Dec-13
Bilog Antenna	TESEQ	CBL6111D	29802	29-Jun-13
Pre-Amplifier	HP	8447F	2805A03335	14-Sep-13
Spectrum Analyzer	R&S	FSV 40	100921	13-Dec-13
Horn Antenna (1GHz~18GHz)	COM-POWER	AHA118	701251	28-Sep-13
Horn Antenna (18GHz~40GHz)	COM-POWER	AH840	101031	2-Nov-13
Preamplifier (30MHz -1GHz)	HP	8447F	2805A03335	14-Sep-13
Preamplifier (18 GHz -40 GHz)	COMPOWER	PAM-840	461257	17-Sep-13
Power meter	R&S	NRVD	100439	17-Apr-14
Power sensor	R&S	NRV-Z1	100013	17-Apr-14

2.3 Traceability

All measurement equipment calibrations are traceable to NML(Taiwan)/NIST(USA) or where calibration is performed outside Taiwan, to equivalent nationally recognized standards organizations.

2.4 Calibration

Equipment requiring calibration is calibrated periodically by the manufacturer or according to manufacturer's specifications. Additionally all equipment is verified for proper performance on a regular basis using in house standards or comparisons.

2.5 Measurement Uncertainty

The estimated combined standard uncertainty for radiated emissions and conducted emissions measurements are ± 3 dB.

Table 3: Emission Measurement Uncertainty

Parameter	Uncertainty
Radio Frequency	$\pm 1 \times 10^{-7}$
RF power, conducted	± 1 dB
Adjacent channel power	± 3 dB
Radiated emission of transmitter, valid up to 26 GHz	± 6 dB
Radiated emission of receiver, valid up to 26 GHz	± 6 dB
Temperature	± 2 °C
Humidity	± 10 %

3. General Product Information

3.1 Product Function and Intended Use

The Wireless power strip is an extension cord with a multi-socket outlet which can control and monitor power flow. It contains a Bluetooth 3.0 compatible module enabling the user to communicate data through a Wireless interface.
For details refer to the User Guide, Data Sheet and Circuit Diagram.

3.2 Ratings and System Details

Table 4: Technical Specification of EUT

Technical Specification	Value
Kind of Equipment	Wireless power strip
Brand Name	Powertech Industrial Co., Ltd.
FCC ID	NHS-R9P627
Type Designation	R9P627
Operating Frequency	2402 MHz ~ 2480 MHz
Channel Spacing	1 MHz
Channel number	79
Operation Voltage	115 (Mains) V
Modulation	GFSK, $\pi/4$ QPSK, 8 DPSK
Antenna gain	1.0 dBi

Table 5: Frequency hopping information

Technical Specification	Description
Hopping Range	<p>Hereby we declare that the maximum frequency of this device is: 2402-2480MHz. This is according the Bluetooth Core Specification V2.1+EDR for devices which will be operated in the USA. This was checked during the Bluetooth Qualification tests (Test Case: TRM/CA/04).</p>
Hopping Sequence	<p>Example of a 79 hopping sequence in data mode:</p> <p>33,04,21,44,23,42,53,46,55,48,40,59,72,29,76,31,08,73,07,75,09,45,60,39,58,13,47,11,77,52,35,50,65,54,67,56,69,62,71,64, 7,25,27,66,57,70,74,61,78,63,10,41,05,43,15,44,64,68,02,70,06,01,51,03,55,05,03,66,53,49,36,47,</p>
Receiver input bandwidth	<p>The input bandwidth of the receiver is 1MHz. In every connection one Bluetooth device is the master and the other one is the slave. The master determines the hopping sequence. The slave follows this sequence. Both devices shift between RX and TX time slot according to the clock of the master.</p> <p>Additionally the type of connection is set up at the beginning of the connection. The master adapts its hopping frequency and its TX/RX timing according to the packet type of the connection. Also the slave of the connection will use these settings.</p> <p>Repeating of a packer has no influence on the hopping sequence. The hopping sequence generated by the master of the connection will be followed in any case.</p> <p>That means a repeated packet will not be send on the same frequency, it is send on the next frequency of the hopping sequence.</p>

3.3 Independent Operation Modes

The basic operation modes are:

- A. Transmitting
 - 1. Low channel
 - 2. Middle channel
 - 3. High channel
- B. Receiving
- C. Standby
- D. Off

3.4 Noise Generating and Noise Suppressing Parts

Refer to the Circuit Diagram.

3.5 Submitted Documents

- Bill of Material
- PCB Layout
- Photo Document
- Technical Description
- Circuit Diagram
- Instruction Manual
- Rating Label

4. Test Set-up and Operation Modes

4.1 Principle of Configuration Selection

The equipment under test (EUT) was configured to measure its maximum power level. The test modes were adapted accordingly in reference to the instructions for use.

4.2 Test Operation and Test Software

Test operation refers to test setup in chapter 4. All testing were performed according to the procedures in ANSI C63.10: 2009 and DA 00-705 of March 30, 2000.

The samples were used as follows:

Conducted: 800028548

Radiation: 800023343

Full test was applied on all test modes, but only worst case was shown.

4.3 Special Accessories and Auxiliary Equipment

The product has been tested together with the following additional accessories:

Kind of Equipment	Manufacturer	Model Name	S/N
Laptop	MSI	MSI4532 (CX420MX)	CX420 MX-233TWK 1008000096

4.4 Countermeasures to achieve EMC Compliance

The test sample which has been tested contained the noise suppression parts as described in the Constructional Data Form or the Technical Construction File. No additional measures were employed to achieve compliance.

4.5 Test Setup Diagram

Diagram of Measurement Configuration for Radiation Test

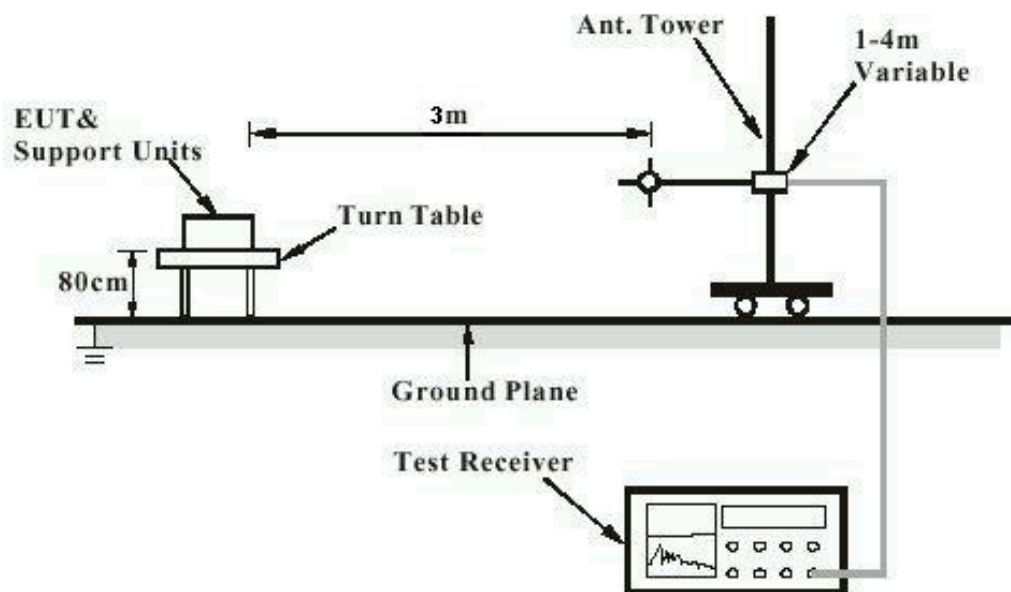

Diagram of Measurement Equipment Configuration for Mains Conduction Measurement

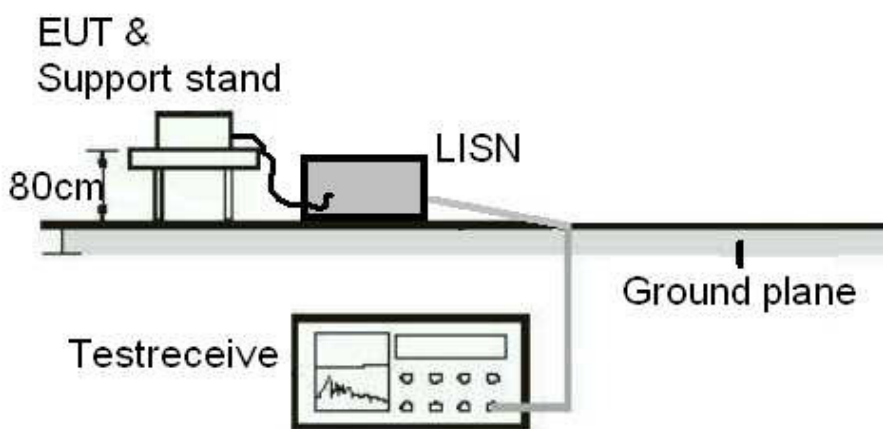
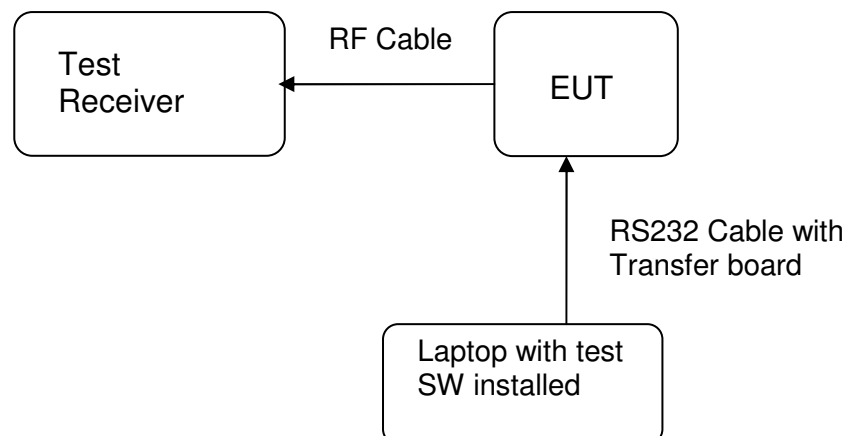

Diagram of Measurement Equipment Configuration for Conducted Transmitter Measurement



5. Test Results

5.1 Transmitter Requirement & Test Suites

5.1.1 Antenna Requirement

RESULT: **Passed**

Test standard : FCC Part 15.247(b)(4), Part 15.203 and
RSS-Gen 7.1.4
Limit : the use of antennas with directional gains that do
not exceed 6 dBi

According to the manufacturer declaration, the EUT has an internal antenna with an directional gain of 1.0 dBi dBi, and the antenna is a printed PCB trace with no possibility of replacement. Therefore, the EUT is considered to comply the provision.

Refer to EUT photo for details.

5.1.2 Peak Output Power

RESULT:
Passed

Test standard : FCC Part 15.247(b)(1), RSS-210 A8.4(2)
 Basic standard : DA 00-705 of March 30, 2000
 Kind of test site : Shielded room

Test setup

Test Channel : Low/ Middle/ High
 Operation Mode : A

Ambient temperature : 22-26 °C
 Relative humidity : 50-65 %
 Atmospheric pressure : 100-103 kPa

Table 6: Test result of Peak Output Power, GFSK modulation

Channel	Channel Frequency	Peak Output Power		Limit
	(MHz)	(dBm)	(W)	(W)
Low Channel	2402	-1.26	0.00075	0.125
Middle Channel	2441	-1.31	0.00074	0.125
High Channel	2480	-1.75	0.00067	0.125

Table 7: Test result of Peak Output Power, 8DPSK modulation

Channel	Channel Frequency	Peak Output Power		Limit
	(MHz)	(dBm)	(W)	(W)
Low Channel	2402	-1.16	0.00077	0.125
Middle Channel	2441	-1.38	0.00073	0.125
High Channel	2480	-1.58	0.00070	0.125

Pmax: 0.7656 mW

Test Plot of Peak Output Power, GFSK modulation

Low Channel

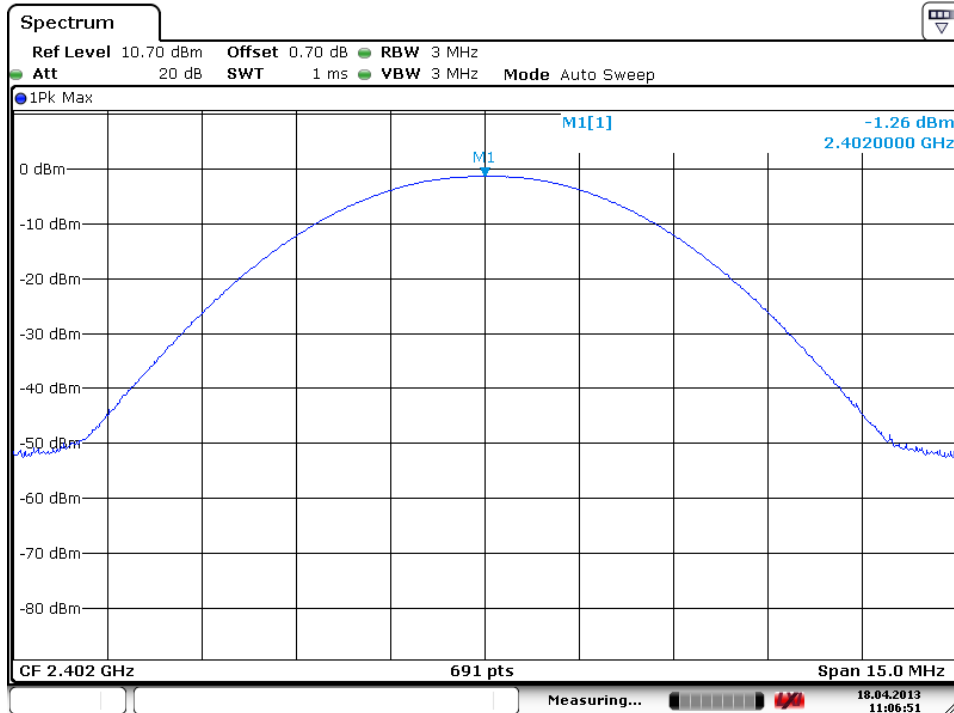

Date: 18.APR.2013 11:06:51

Middle Channel

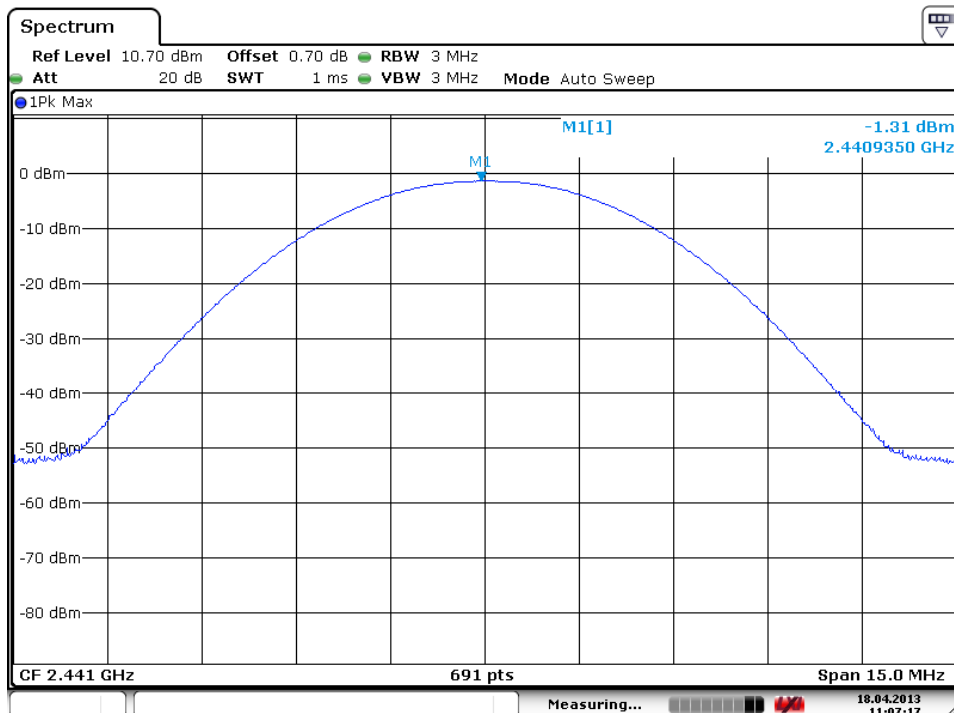

Date: 18.APR.2013 11:07:17

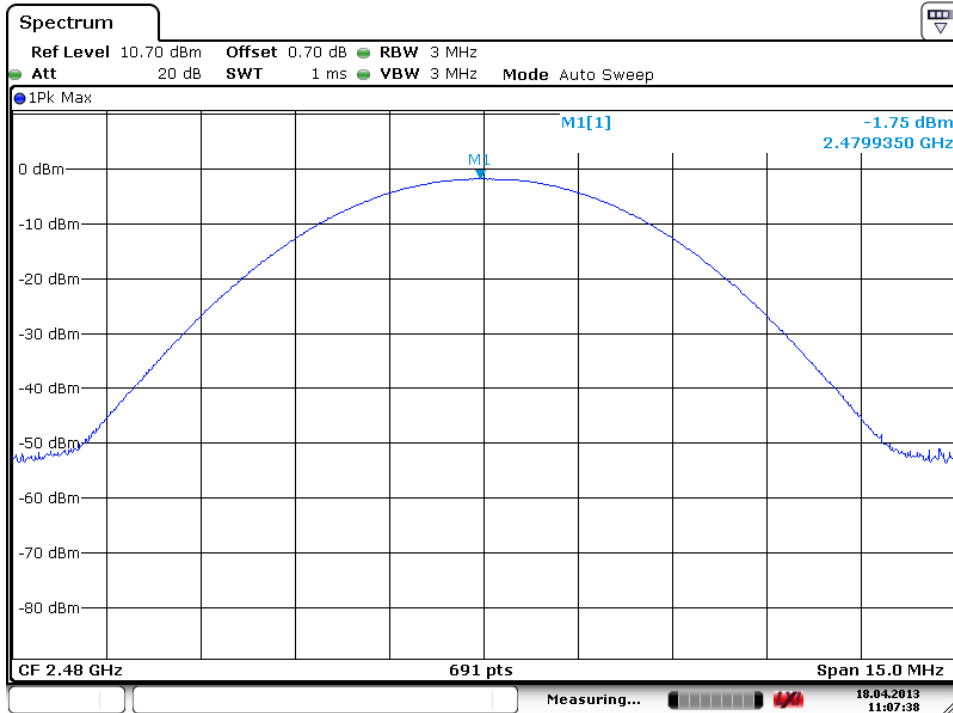
High Channel

Date: 18.APR.2013 11:07:38

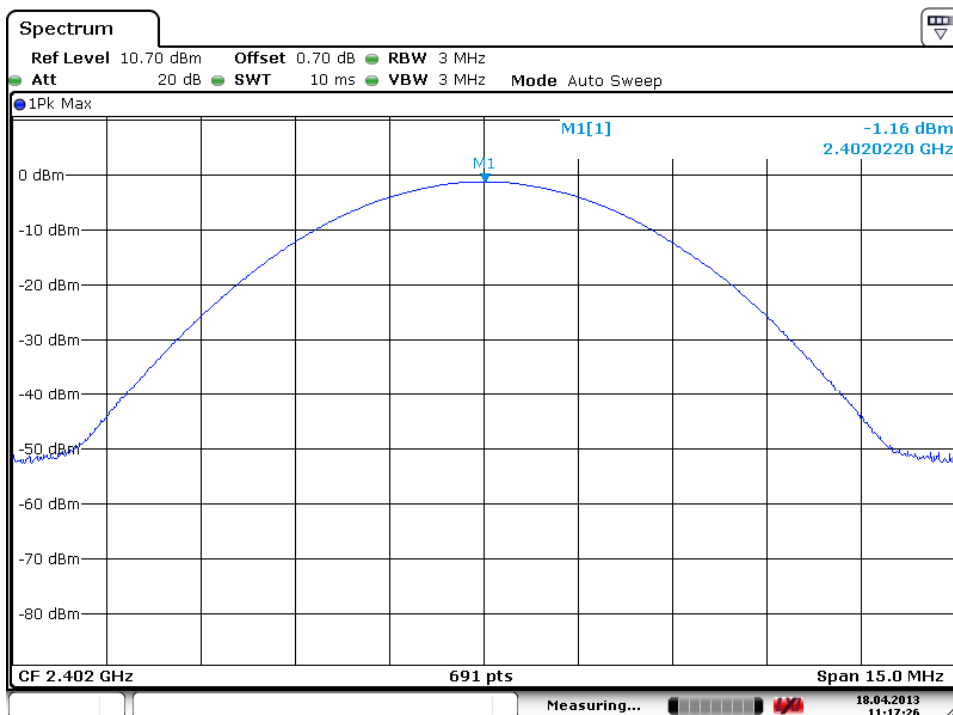
Test Plot of Peak Output Power, 8DPSK modulation
Low Channel

Date: 18.APR.2013 11:17:26

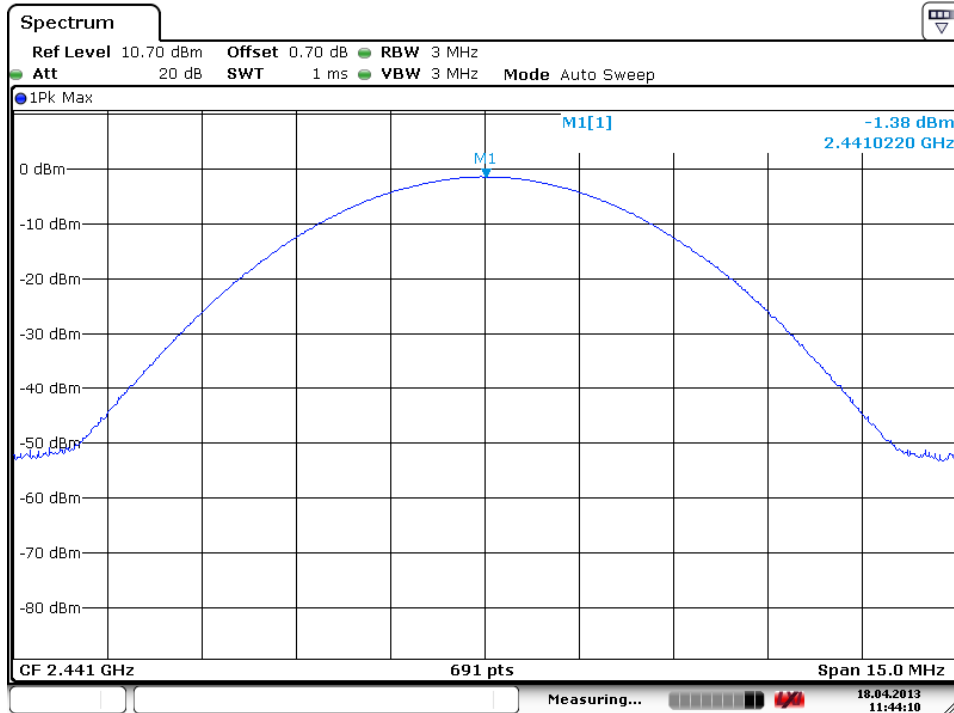
Middle Channel

Date: 18.APR.2013 11:44:10

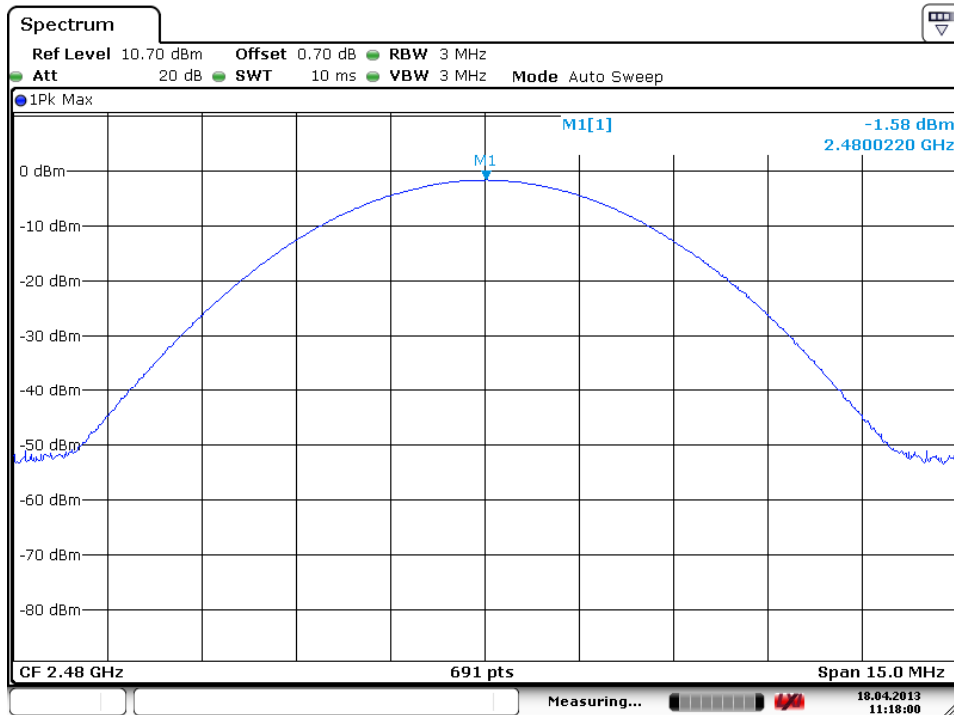
High Channel

Date: 18.APR.2013 11:18:00

5.1.3 20dB Bandwidth

RESULT:
Passed

Test standard : FCC Part 15.247(a)(1), RSS-210 A8.1(a)
 Basic standard : DA 00-705 of March 30, 2000
 Kind of test site : Shielded room

Test setup

Test Channel : Low/ Middle/ High
 Operation Mode : A

 Ambient temperature : 22-26 °C
 Relative humidity : 50-65 %
 Atmospheric pressure : 100-103 kPa

Table 8: Test result of 20dB Bandwidth, GFSK modulation

Channel	Channel Frequency (MHz)	20dB Bandwidth (kHz)	Limit (MHz)	Result
Low Channel	2402	937.8	/	Pass
Mid Channel	2441	934.9	/	Pass
High Channel	2480	940.7	/	Pass

Table 9: Test result of 20dB Bandwidth, 8DPSK modulation

Channel	Channel Frequency (MHz)	20dB Bandwidth (kHz)	Limit (MHz)	Result
Low Channel	2402	1250.4	/	Pass
Mid Channel	2441	1250.4	/	Pass
High Channel	2480	1247.5	/	Pass

Test Plot of 20dB Bandwidth, GFSK modulation

Low Channel

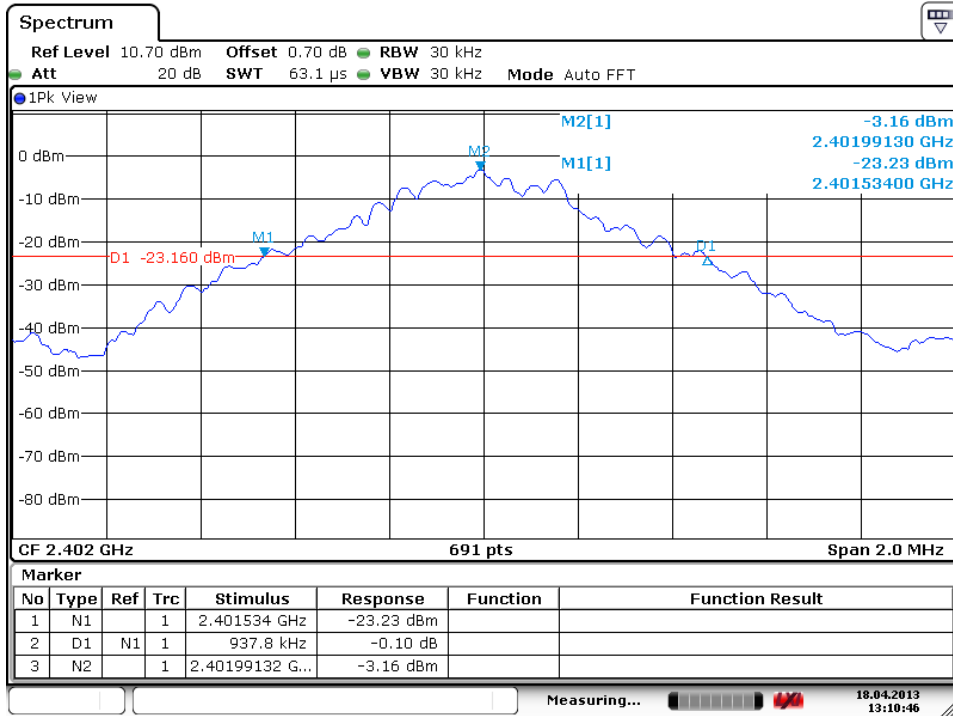

Date: 18.APR.2013 13:10:46

Middle Channel

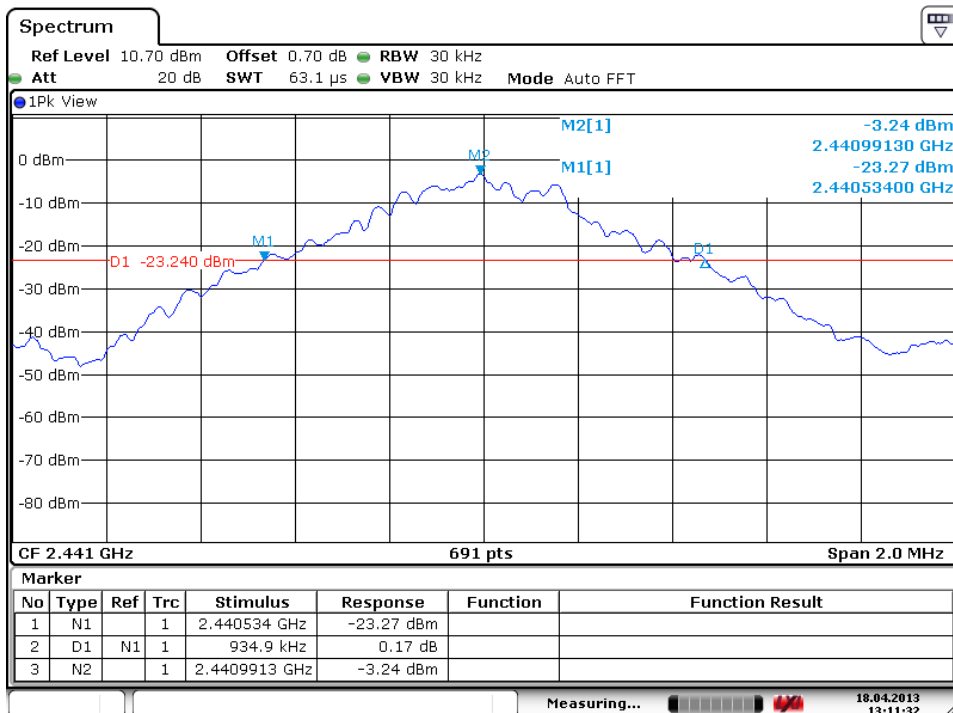

Date: 18.APR.2013 13:11:32

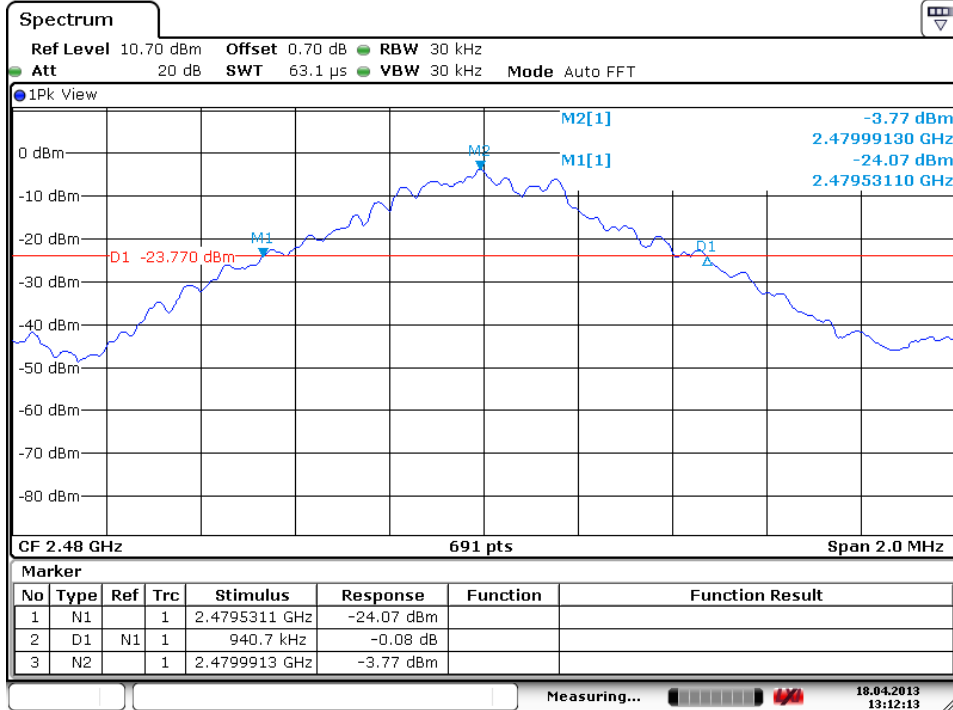
High Channel

Date: 18.APR.2013 13:12:13

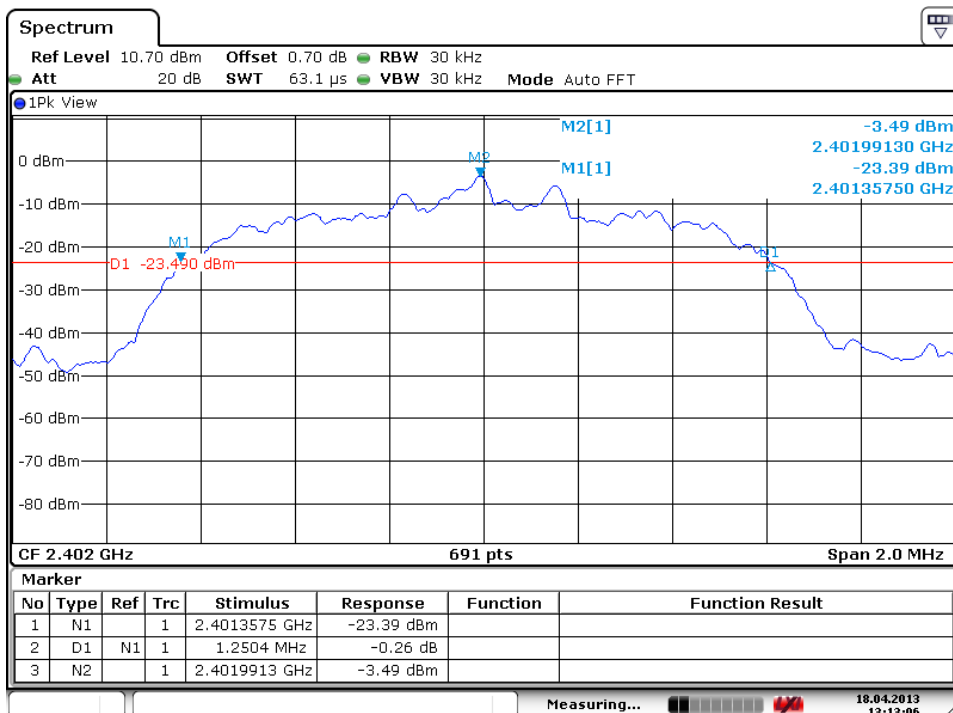
Test Plot of 20dB Bandwidth, 8DPSK modulation
Low Channel

Date: 18.APR.2013 13:13:06

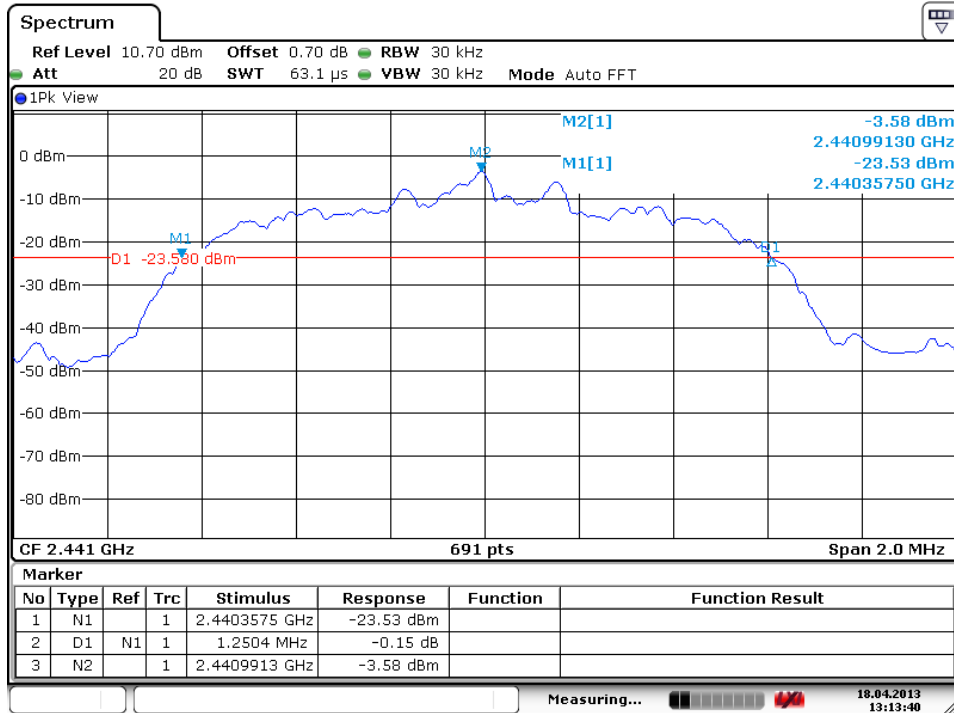
Middle Channel

Date: 18.APR.2013 13:13:40

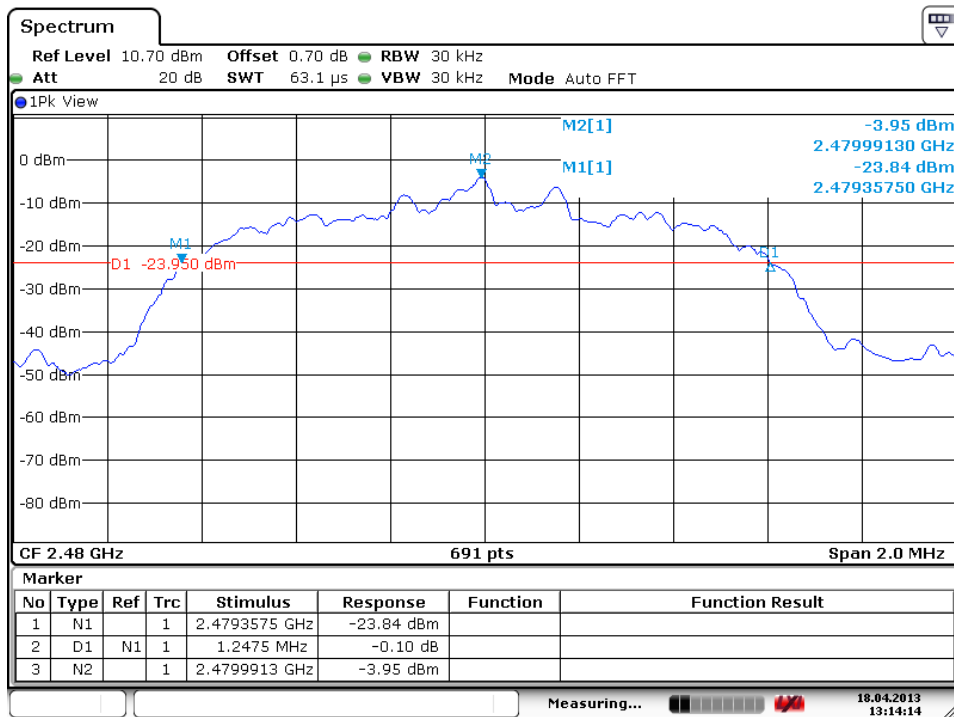
High Channel

Date: 18.APR.2013 13:14:14

5.1.4 Conducted spurious emissions and Frequency Band Edge measured in 100kHz Bandwidth

RESULT:**Passed**

Test standard	:	FCC part 15.247(d), RSS-210 A8.5
Basic standard	:	DA 00-705 of March 30, 2000
Limit	:	20dB (below that in the 100kHz bandwidth within the band that contains the highest level of the desired power)
Kind of test site	:	Shielded room

Test setup

Test Channel	:	Low/ Middle/ High
Operation Mode	:	A
Ambient temperature	:	22-26 °C
Relative humidity	:	50-65 %
Atmospheric pressure	:	100-103 kPa

All emissions are more than 20dB below fundamental, details refer to following test plot, and compliance is achieved as well.

Due to the small size of the product and that there are no inductive components of significant size, 9kHz to 30MHz frequency range is not tested based on technical judgment.

Test Plot of 100kHz Conducted Emissions, GFSK modulation

Low Channel

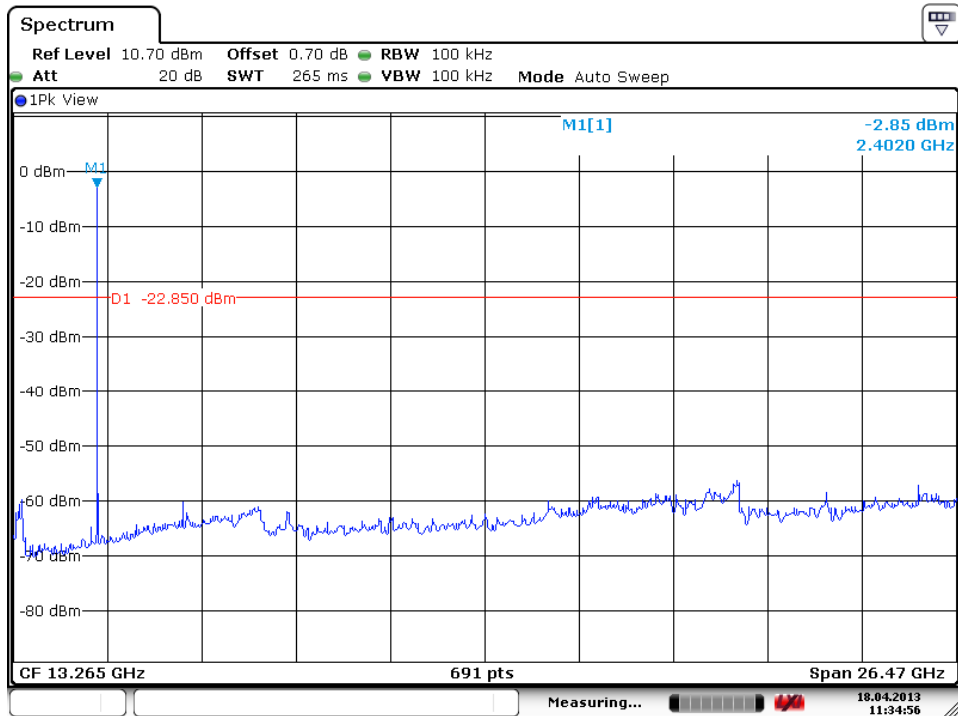

Date: 18.APR.2013 11:34:56

Middle Channel

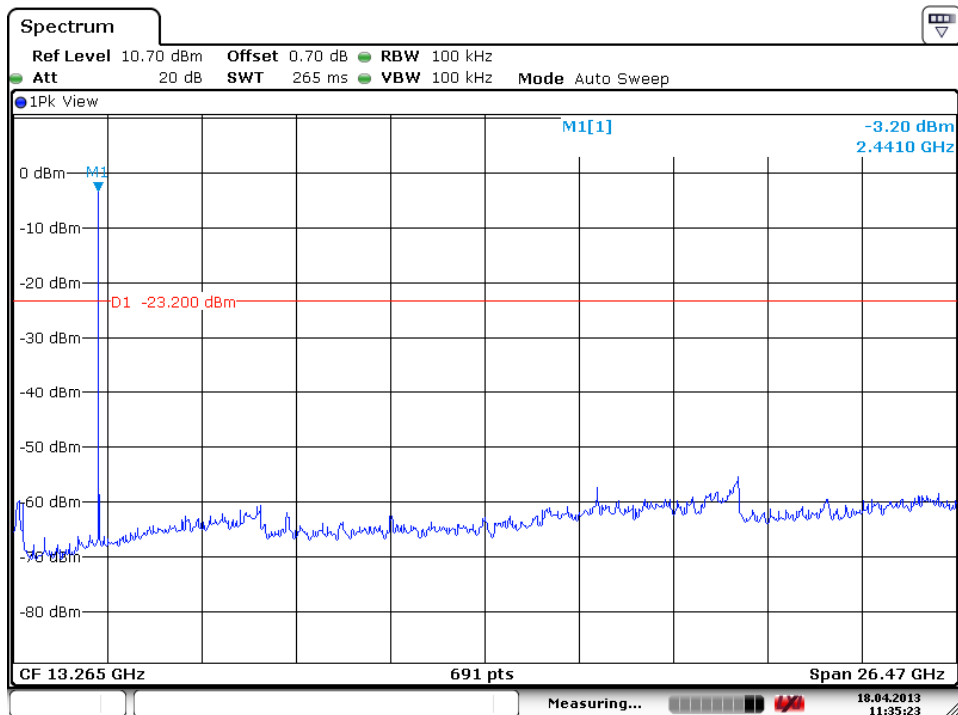

Date: 18.APR.2013 11:35:23

High Channel

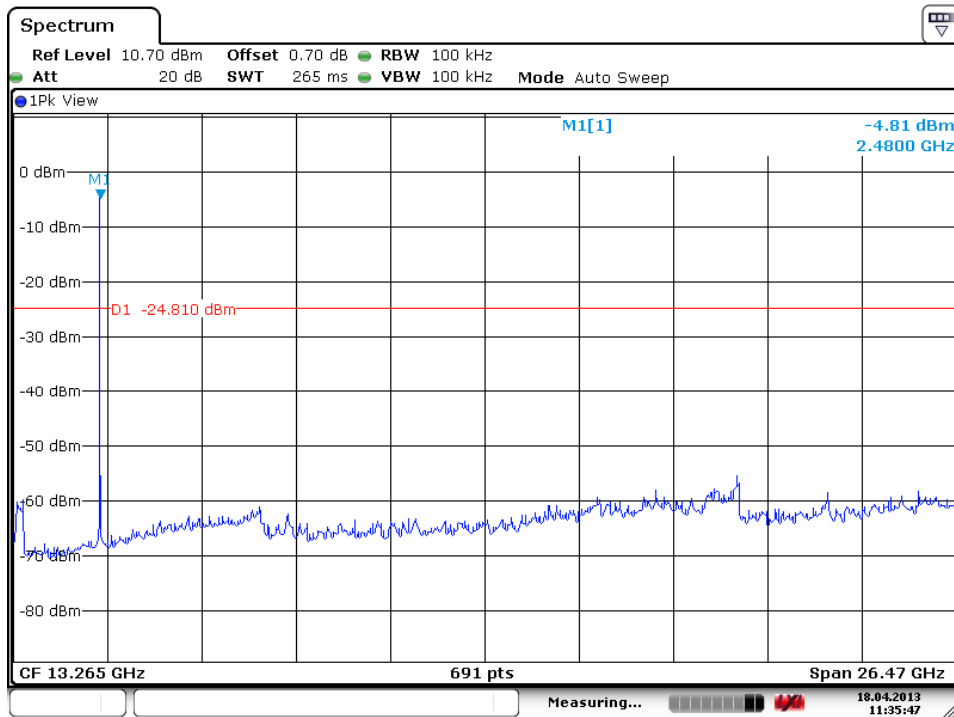

Date: 18.APR.2013 11:35:47

Test Plot of 100kHz Conducted Emissions, 8DPSK modulation

Low Channel

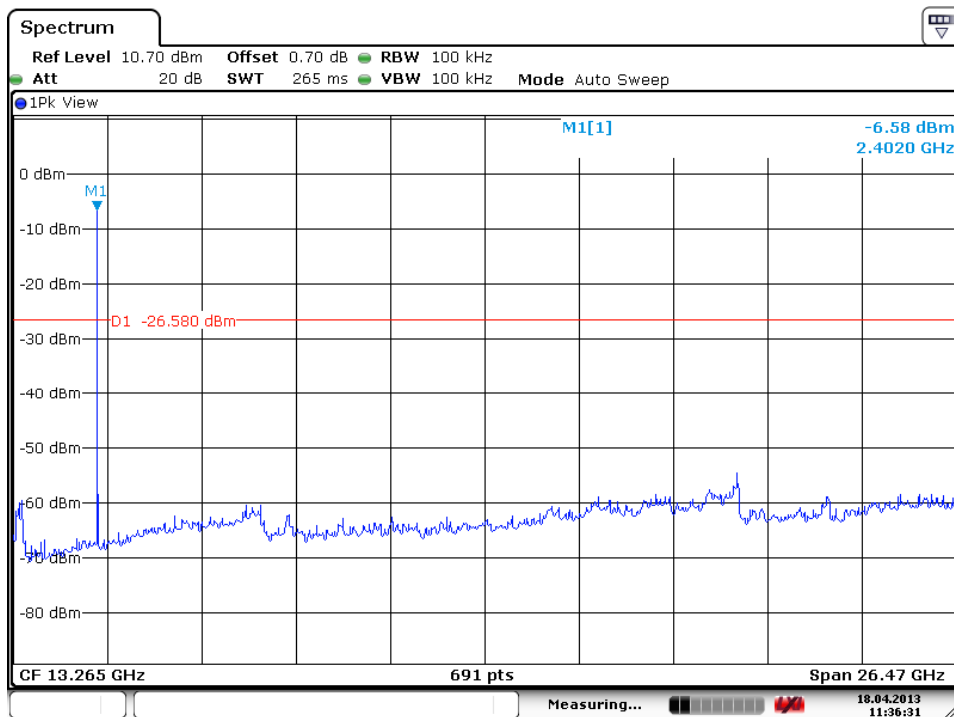

Date: 18.APR.2013 11:36:31

Middle Channel

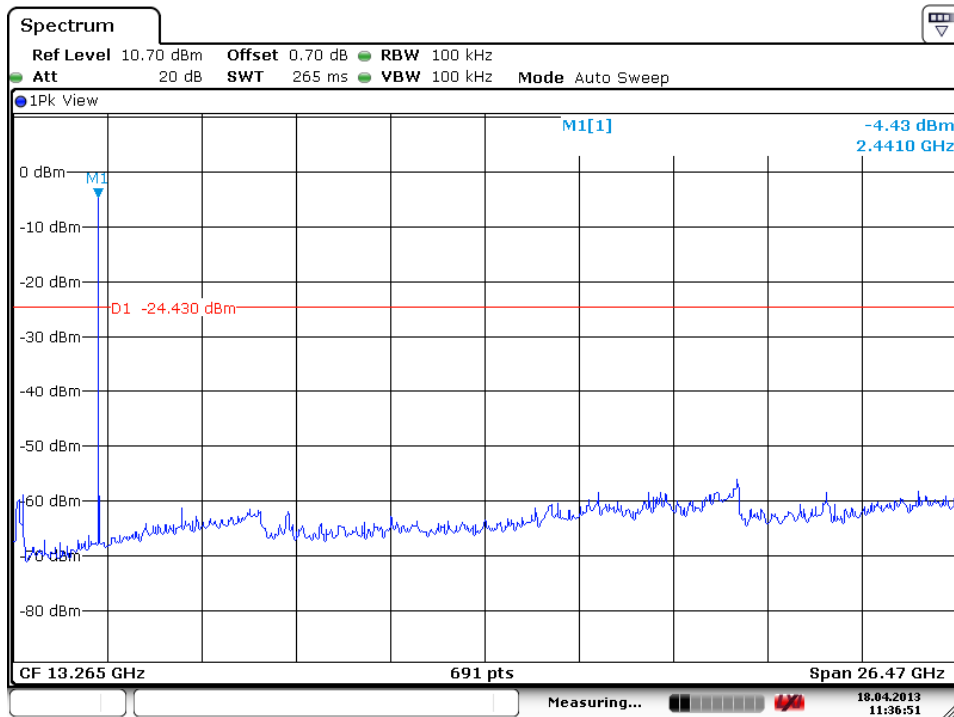

Date: 18.APR.2013 11:36:51

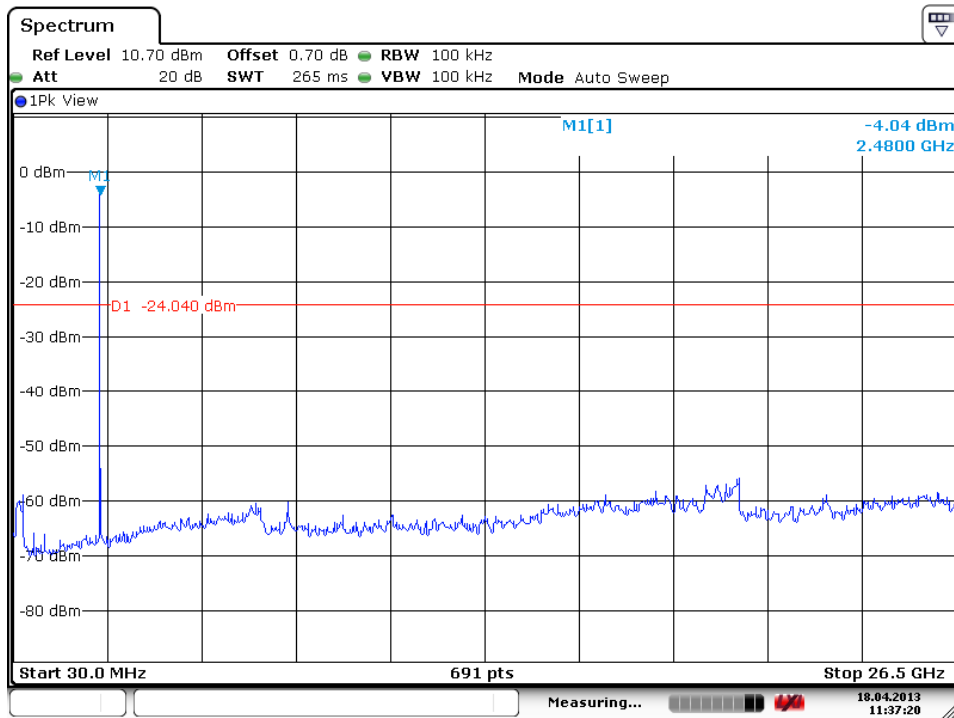
High Channel

Date: 18.APR.2013 11:37:20

Test Plot of 100kHz Bandwidth of Frequency Band Edge, GFSK modulation

Low Channel

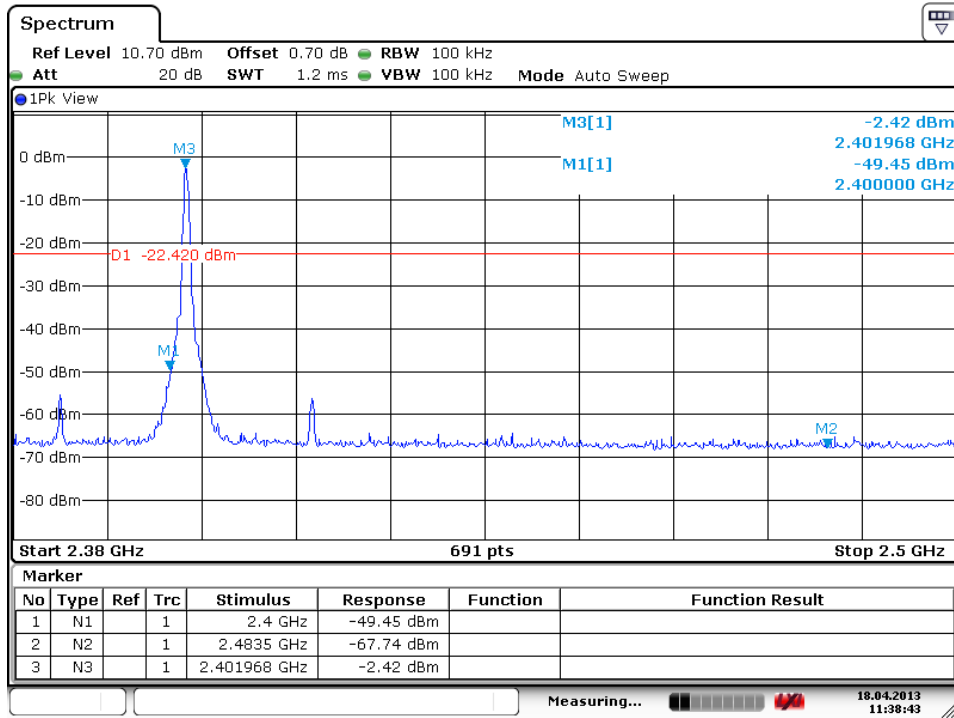

Date: 18.APR.2013 11:38:43

High Channel

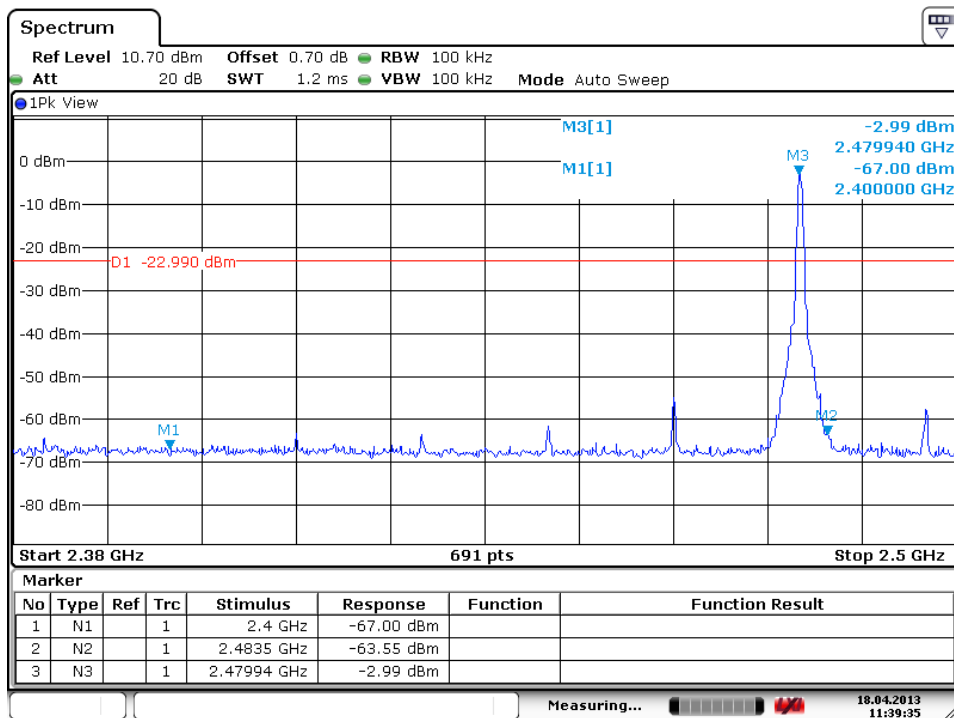

Date: 18.APR.2013 11:39:35

Test Plot of 100kHz Bandwidth of Frequency Band Edge, 8DPSK modulation

Low Channel

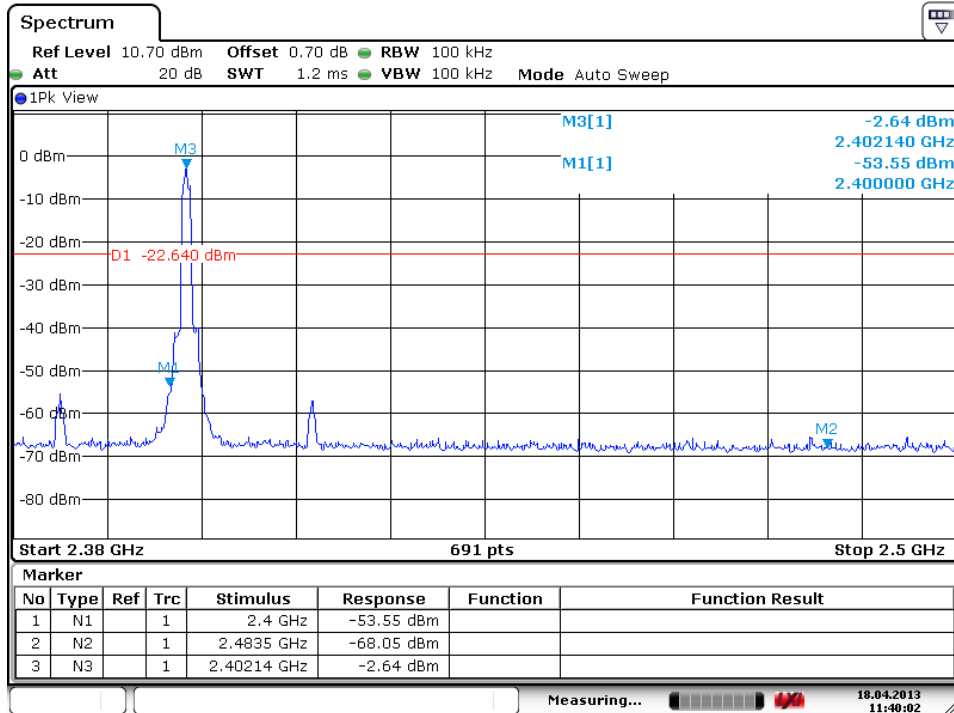

Date: 18.APR.2013 11:40:02

High Channel

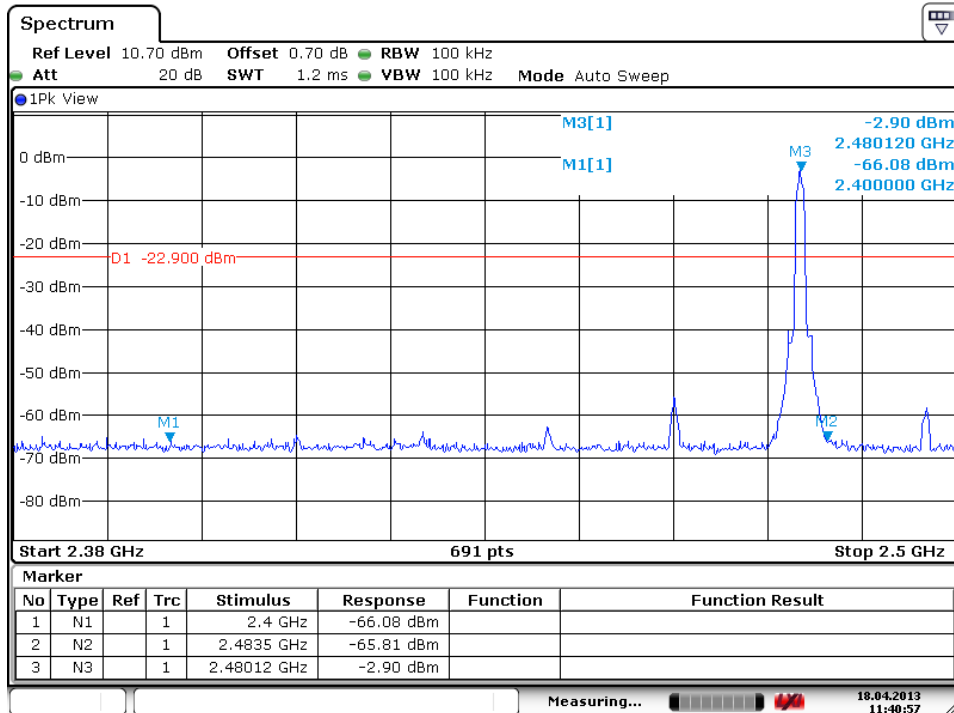

Date: 18.APR.2013 11:40:57

5.1.5 Spurious Emission

RESULT:**Passed**

Test standard	:	FCC part 15.247(d), FCC 15.205, FCC 15.209, RSS-210 2.2, RSS-210 A8.5 and RSS-Gen 7.2.1
Basic standard	:	ANSI C63.10: 2009
Limits	:	Radiated emissions which fall in the restricted bands, as defined in FCC 15.205(a) and RSS-210 2.7 (Table 1), must comply with the radiated emission limits specified in FCC 15.209(a) and RSS-210 2.7 (Table 2 and 3). Emission radiated outside the specified frequency bands must comply with the radiated emission limits specified in FCC 15.209(a) and FCC 15.249(a), RSS-210 2.7 (Table 2 and 3) and RSS-210 A2.9(a).
Kind of test site	:	3m Semi-Anechoic Chamber

Test setup

Test Channel	:	Low/ Middle/ High
Operation Mode	:	A
Ambient temperature	:	22-26 °C
Relative humidity	:	50-65 %
Atmospheric pressure	:	100-103 kPa

Remark: Testing was carried out within frequency range 30MHz to the tenth harmonic. For details refer to Appendix 2. The Radiated Emissions testing was performed in the X, Y and Z axis orientation. The X Axis orientation is the worst-case and recorded in this test report. Due to the small size of the product and that there are no inductive components of significant size, 9kHz to 30MHz frequency range is not tested based on technical judgment.

5.1.6 Frequency Separation

RESULT:
Passed

Test standard : FCC part 15.247(a)(1), RSS-210 A8.1(b)
 Basic standard : DA 00-705 of March 30, 2000
 Limit : $\geq 25\text{kHz}$ or $2/3$ of 20dB bandwidth, whichever is greater

Test setup

Test Channel : Low/ Middle/ High
 Operation Mode : A
 Ambient temperature : 24°C
 Relative humidity : 53%

Table 10: Test result of Frequency Separation

Channel	Channel Frequency (MHz)	Measured Channel Separation (MHz)	Limit (kHz)	Result
Record Channel	2441	1	$\geq 25\text{kHz}$ or $2/3$ of 20dB bandwidth	Pass
Record Channel adj 1	2440			
Record Channel adj 2	2442			

Test Plot of Frequency Separation

GFSK

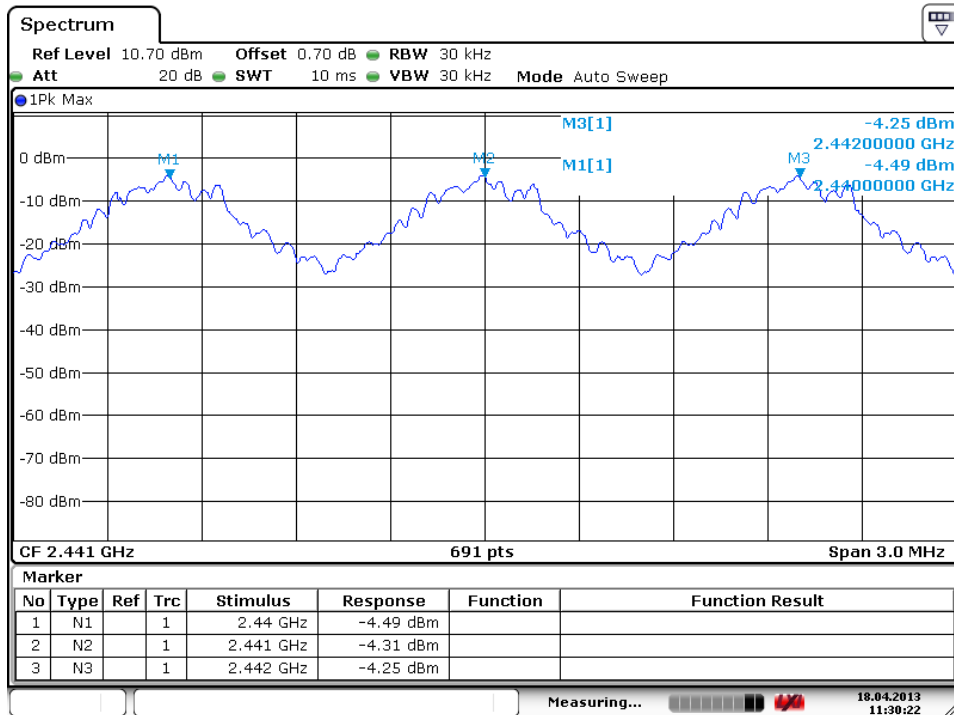

Date: 18.APR.2013 11:30:22

5.1.7 Number of hopping frequency

RESULT:**Passed**

Test standard : FCC part 15.247(a)(1)(iii), RSS-210 A8.1(d)
Basic standard : DA 00-705 of March 30, 2000
Limits : ≥ 15 non-overlapping channels
Kind of test site : Shield room

Test setup

Test Channel : Low/ Middle/ High
Operation Mode : A

Ambient temperature : 22-26 °C
Relative humidity : 50-65 %
Atmospheric pressure : 100-103 kPa

Table 11: Test result of Number of hopping frequency

Frequency Range	Measured Quantity of Hopping Channel	Limit	Result
<u>2400</u> to <u>2483.5</u> MHz	79	≥ 15	Pass

5.1.8 Time of Occupancy

RESULT:
Passed

Test standard : FCC part 15.247(a)(1)(iii) , RSS-210 A8.1(d)
 Basic standard : DA 00-705 of March 30, 2000
 Limits : 0.4s
 Kind of test site : Shield room

Test setup

Test Channel : Low/ Middle/ High
 Operation Mode : A

 Ambient temperature : 22-26 °C
 Relative humidity : 50-65 %
 Atmospheric pressure : 100-103 kPa

Table 12: Test result of Time of Occupancy

Data Mode	Captured Burst (s)	Dwell time (s)	On+Off time (s)	Limit (s)	Result
DH5	0.0029	0.3136	0.003756	0.4	Pass
3DH5	0.0029	0.3139	0.003768	0.4	Pass

Note:

$$\text{Dwell time} = \text{Pulse width} \times (\text{Hopping rate} / \text{Number of channels}) \times \text{Period}$$

$$\text{Period} = 0.4 \text{ (seconds/ channel)} \times 79 \text{ (channel)} = 31.6 \text{ seconds.}$$

Test Plot of Time of Occupancy, GFSK modulation

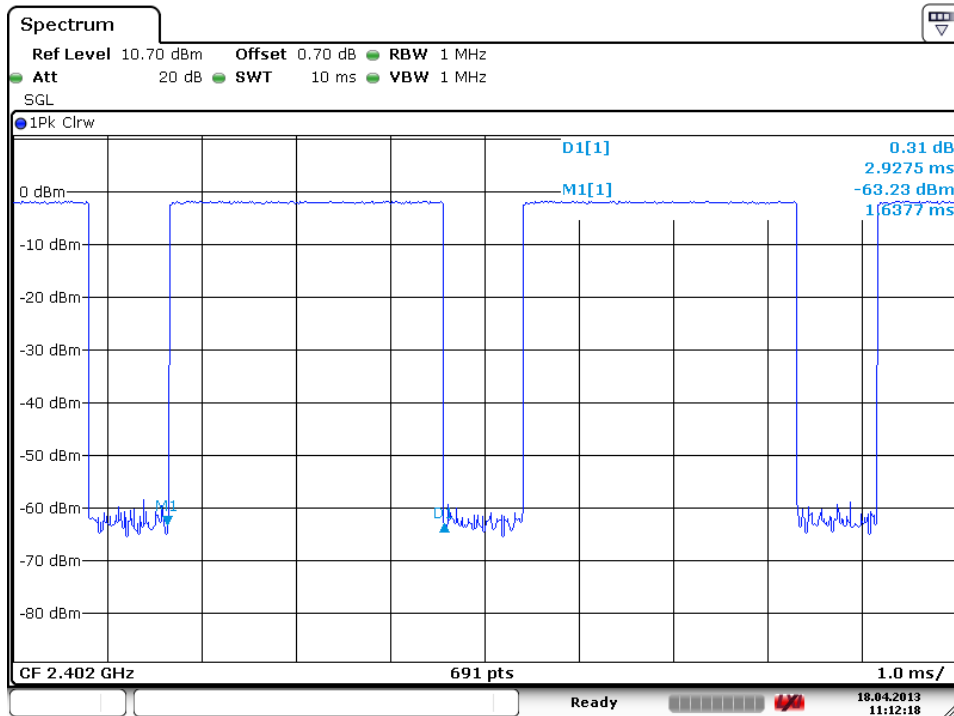

Date: 18.APR.2013 11:12:18

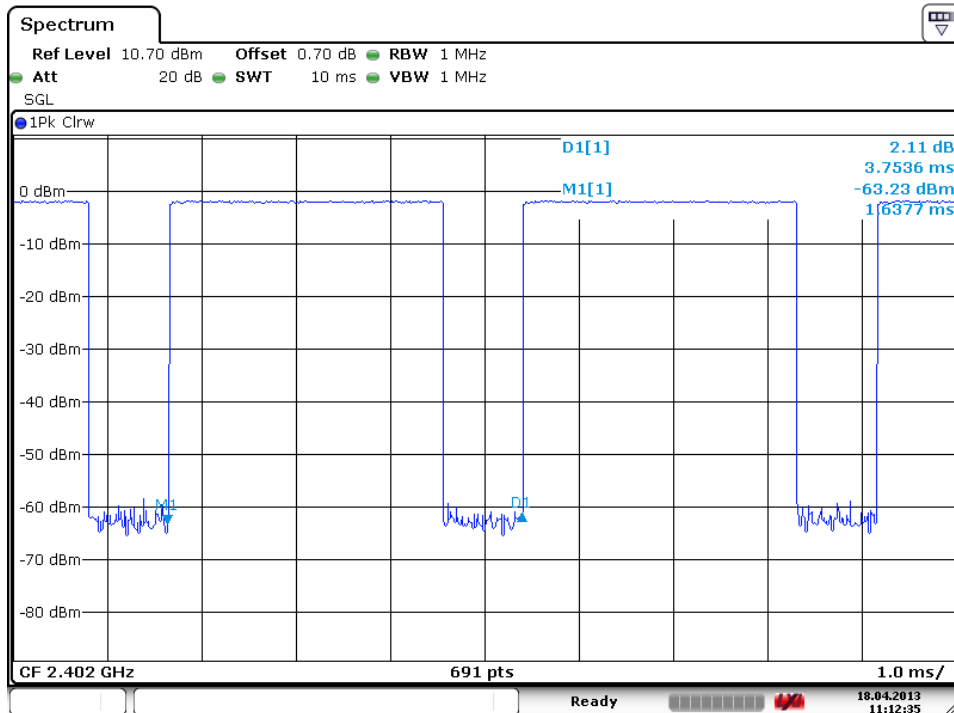

Date: 18.APR.2013 11:12:35

Test Plot of Time of Occupancy, 8DPSK modulation

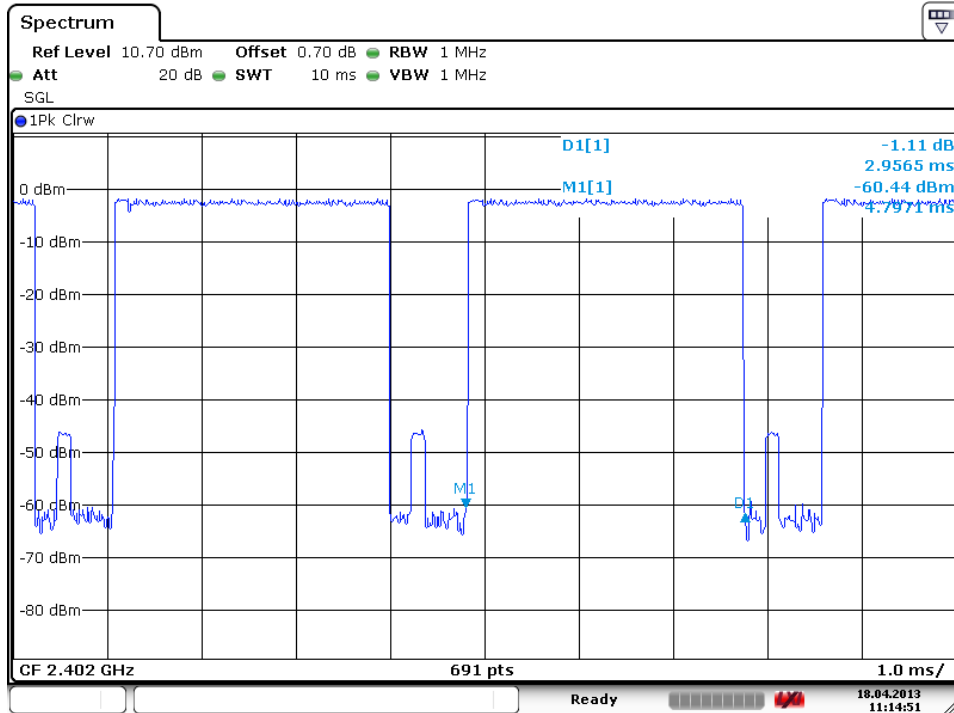

Date: 18.APR.2013 11:14:51

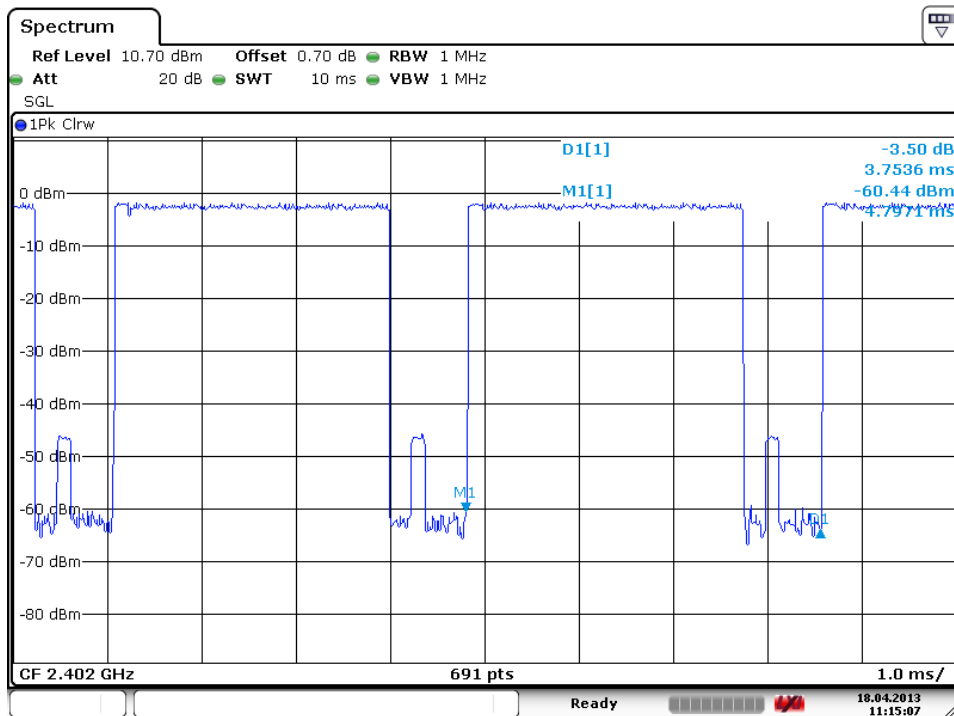

Date: 18.APR.2013 11:15:07

5.2 Mains Emissions

5.2.1 Mains Conducted Emissions

RESULT:**Passed**

Test standard : FCC Part 15.207
FCC Part 15.107
LP0002: 2.3

Limits : Mains Conducted emissions as defined in
above standards

Kind of test site : Shielded Room

Test setup

Test Channel : Middle
Operation mode : A

Remark: For details refer to Appendix D.

6. Safety Human exposure

6.1 Radio Frequency Exposure Compliance

6.1.1 Electromagnetic Fields

RESULT:**Passed**

Test standard : FCC KDB Publication 447498

Since maximum peak output power of the transmitter is <1mW, hence the EUT is excluded from SAR evaluation according to FCC KDB publication 447498 D01: Mobile Portable RF Exposure.

7. Photographs of the Test Set-Up

Photograph 1: Set-up for Spurious Emissions (Front View)

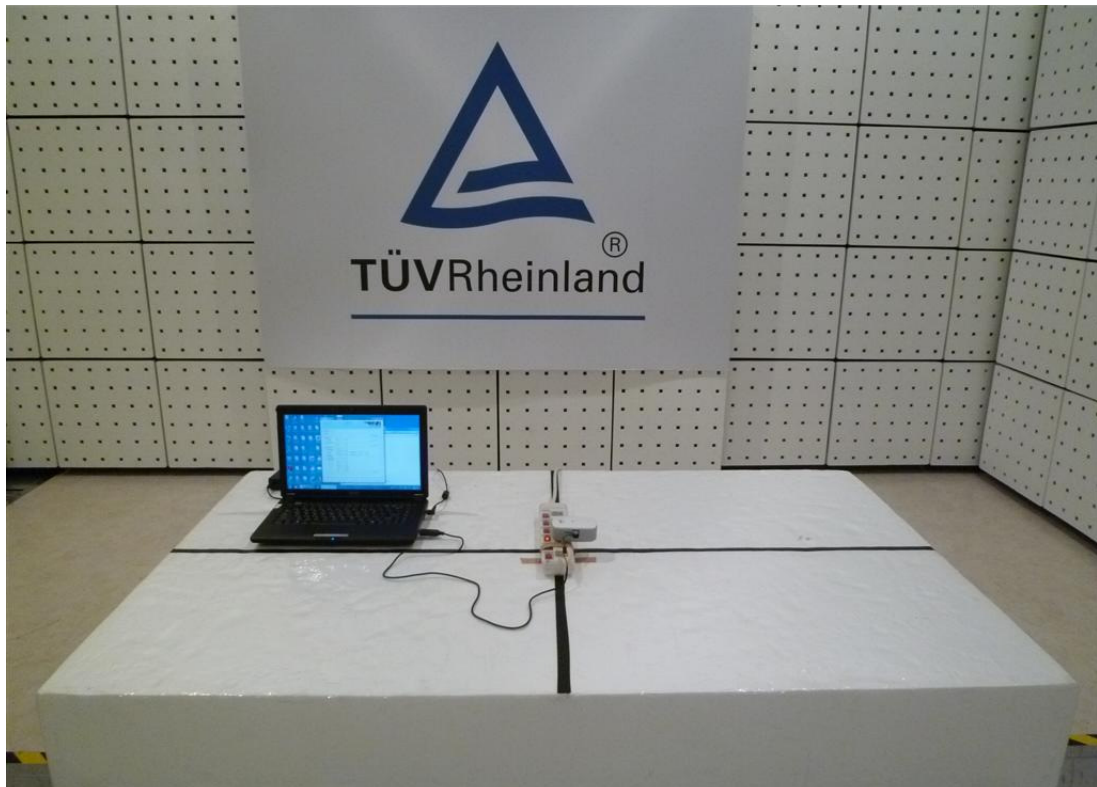

Photograph 2: Set-up for Spurious Emissions (Back View 1)



Photograph 3: Set-up for Spurious Emissions (Back View 2)



Photograph 4: Set-up for Conducted testing

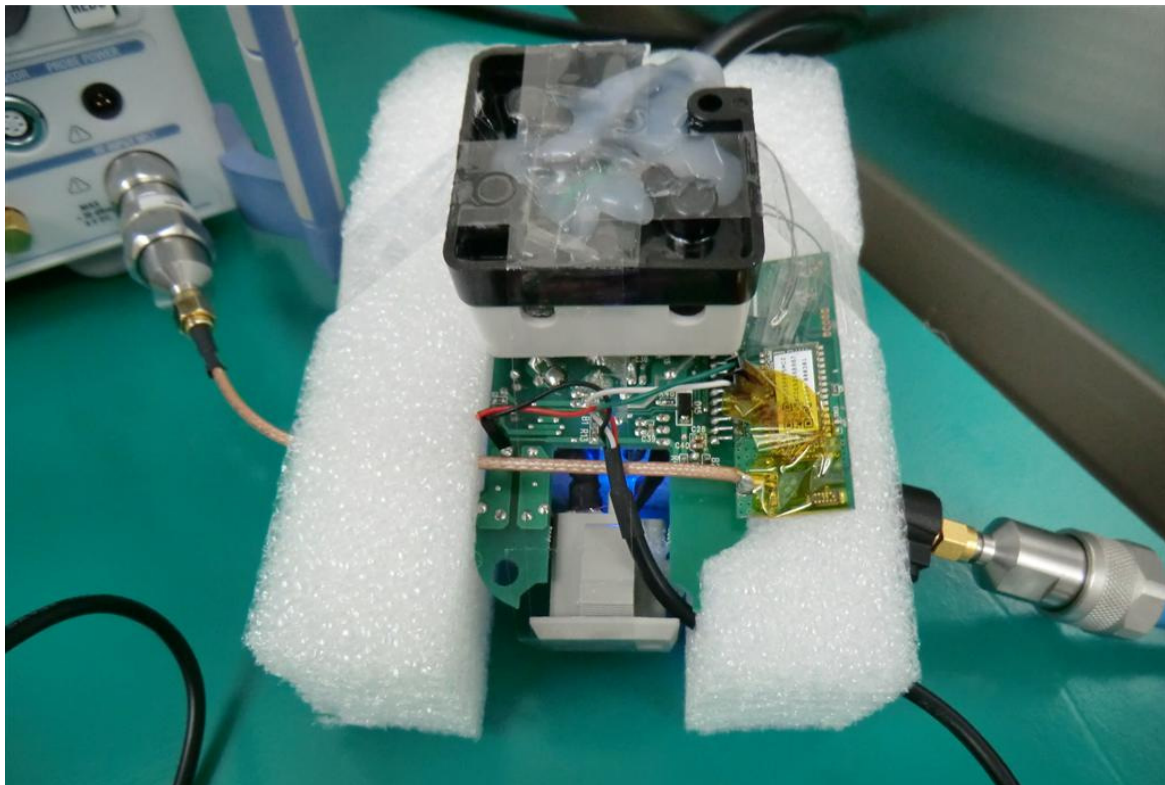

Photograph 5: Set-up for for Mains Conducted testing Back



Photograph 6: Set-up for for Mains Conducted testing Front

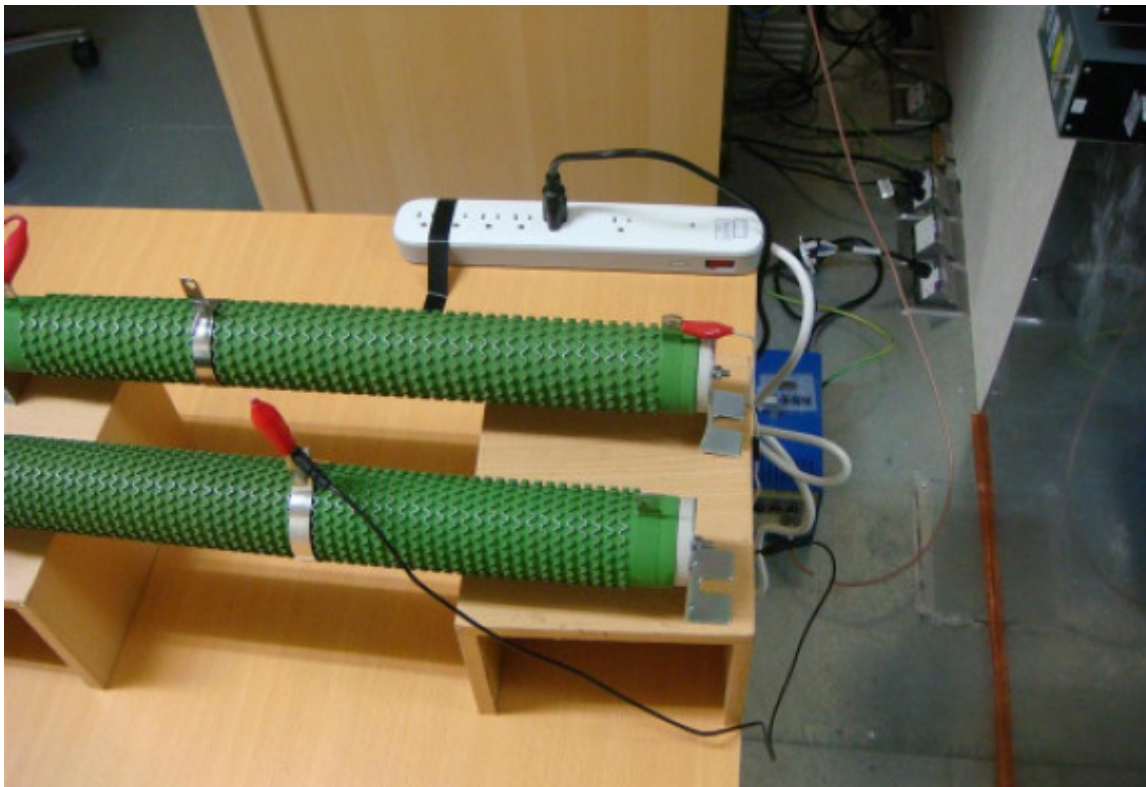

8. List of Tables

Table 1: Applied Standard and Test Levels	4
Table 2: List of Test and Measurement Equipment	5
Table 3: Emission Measurement Uncertainty.....	6
Table 4: Technical Specification of EUT	7
Table 5: Frequency hopping information.....	8
Table 6: Test result of Peak Output Power, GFSK modulation.....	14
Table 7: Test result of Peak Output Power, 8DPSK modulation.....	14
Table 8: Test result of 20dB Bandwidth, GFSK modulation.....	18
Table 9: Test result of 20dB Bandwidth, 8DPSK modulation.....	18
Table 10: Test result of Frequency Separation	29
Table 11: Test result of Number of hopping frequency	31
Table 12: Test result of Time of Occupancy.....	33

9. List of Photographs

Photograph 1: Set-up for Spurious Emissions (Front View).....	38
Photograph 2: Set-up for Spurious Emissions (Back View 1)	38
Photograph 3: Set-up for Spurious Emissions (Back View 2)	39
Photograph 4: Set-up for Conducted testing	39
Photograph 5: Set-up for for Mains Conducted testing Back.....	40
Photograph 6: Set-up for for Mains Conducted testing Front.....	40