



A D T

FCC TEST REPORT

REPORT NO.: RF991011C06 R1

MODEL NO.: WLN-2220
(Refer to item 3.1 for more details)

FCC ID: NHPWLN2220

RECEIVED: Oct. 07, 2010

TESTED: Oct. 07 ~ Oct. 22, 2010 (for shielded case)
Dec. 02 ~ Dec. 10, 2010 (for non-shielded case)

ISSUED: Dec. 20, 2010

APPLICANT: CAMEO COMMUNICATIONS, INC.

ADDRESS: 5F, No. 42, Sec. 6, Mincyuan E. Rd., Neihu District,
Taipei City 114, Taiwan

ISSUED BY: Bureau Veritas Consumer Products Services (H.K.)
Ltd., Taoyuan Branch

LAB ADDRESS: No. 47, 14th Ling, Chia Pau Tsuen, Lin Kou Hsiang,
Taipei Hsien 244, Taiwan, R.O.C.

TEST LOCATION: No. 19, Hwa Ya 2nd Rd, Wen Hwa Tsuen, Kwei
Shan Hsiang, Taoyuan Hsien 333, Taiwan, R.O.C.

This test report consists of 130 pages in total. It may be duplicated completely for legal use with the approval of the applicant. It should not be reproduced except in full, without the written approval of our laboratory. The client should not use it to claim product certification, approval, or endorsement by TAF or any government agency. The test results in the report only apply to the tested sample.





A D T

TABLE OF CONTENTS

RELEASE CONTROL RECORD.....	4
1. CERTIFICATION.....	5
2. SUMMARY OF TEST RESULTS.....	6
2.1 MEASUREMENT UNCERTAINTY.....	6
3. GENERAL INFORMATION.....	7
3.1 GENERAL DESCRIPTION OF EUT.....	7
3.2 DESCRIPTION OF TEST MODES.....	9
3.2.1 CONFIGURATION OF SYSTEM UNDER TEST.....	9
3.2.2 TEST MODE APPLICABILITY AND TESTED CHANNEL DETAIL.....	10
3.3 GENERAL DESCRIPTION OF APPLIED STANDARDS.....	13
3.4 DESCRIPTION OF SUPPORT UNITS.....	13
4. TEST TYPES AND RESULTS.....	14
4.1 RADIATED EMISSION MEASUREMENT.....	14
4.1.1 LIMITS OF RADIATED EMISSION MEASUREMENT.....	14
4.1.2 TEST INSTRUMENTS.....	15
4.1.3 TEST PROCEDURES.....	16
4.1.4 DEVIATION FROM TEST STANDARD.....	16
4.1.5 TEST SETUP.....	17
4.1.6 EUT OPERATING CONDITIONS.....	17
4.1.7 TEST RESULTS.....	18
4.2 CONDUCTED EMISSION MEASUREMENT.....	60
4.2.1 LIMITS OF CONDUCTED EMISSION MEASUREMENT.....	60
4.2.2 TEST INSTRUMENTS.....	60
4.2.3 TEST PROCEDURES.....	61
4.2.4 DEVIATION FROM TEST STANDARD.....	61
4.2.5 TEST SETUP.....	62
4.2.6 EUT OPERATING CONDITIONS.....	62
4.2.7 TEST RESULTS.....	63
4.3 6dB BANDWIDTH MEASUREMENT.....	75
4.3.1 LIMITS OF 6dB BANDWIDTH MEASUREMENT.....	75
4.3.2 TEST INSTRUMENTS.....	75
4.3.3 TEST PROCEDURE.....	75
4.3.4 DEVIATION FROM TEST STANDARD.....	75
4.3.5 TEST SETUP.....	76
4.3.6 EUT OPERATING CONDITIONS.....	76
4.3.7 TEST RESULTS.....	77
4.4 MAXIMUM OUTPUT POWER.....	83
4.4.1 LIMITS OF MAXIMUM OUTPUT POWER MEASUREMENT.....	83
4.4.2 INSTRUMENTS.....	83
4.4.3 TEST PROCEDURES.....	83
4.4.4 DEVIATION FROM TEST STANDARD.....	84
4.4.5 TEST SETUP.....	84
4.4.6 EUT OPERATING CONDITIONS.....	84
4.4.7 TEST RESULTS.....	85
4.5 POWER SPECTRAL DENSITY MEASUREMENT.....	86
4.5.1 LIMITS OF POWER SPECTRAL DENSITY MEASUREMENT.....	86
4.5.2 TEST INSTRUMENTS.....	86
4.5.3 TEST PROCEDURE.....	86



A D T

4.5.4	DEVIATION FROM TEST STANDARD.....	87
4.5.5	TEST SETUP.....	87
4.5.6	EUT OPERATING CONDITION.....	87
4.5.7	TEST RESULTS.....	88
4.6	BAND EDGES MEASUREMENT.....	94
4.6.1	LIMITS OF BAND EDGES MEASUREMENT.....	94
4.6.2	TEST INSTRUMENTS.....	94
4.6.3	TEST PROCEDURE.....	95
4.6.4	DEVIATION FROM TEST STANDARD.....	95
4.6.5	EUT OPERATING CONDITION.....	95
4.6.6	TEST RESULTS.....	95
5.	PHOTOGRAPHS OF THE TEST CONFIGURATION.....	128
6.	INFORMATION ON THE TESTING LABORATORIES.....	129
7.	APPENDIX A - MODIFICATIONS RECORDERS FOR ENGINEERING CHANGES TO THE EUT BY THE LAB.....	130



A D T

RELEASE CONTROL RECORD

ISSUE NO.	REASON FOR CHANGE	DATE ISSUED
Original release	NA	Oct. 25, 2010
RF991011C06 R1	Add non-shielded case mode.	Dec. 20, 2010



A D T

1. CERTIFICATION

PRODUCT: IEEE802.11n Wireless LAN Router

MODEL: WLN-2220 (Refer to item 3.1 for more details)

BRAND: CAMEO (Refer to item 3.1 for more details)

APPLICANT: CAMEO COMMUNICATIONS, INC.

TEST SAMPLE: ENGINEERING SAMPLE

TESTED: Oct. 07 ~ Oct. 22, 2010 (for shielded case)

Dec. 02 ~ Dec. 10, 2010 (for non-shielded case)

STANDARDS: FCC Part 15, Subpart C (Section 15.247)

ANSI C63.4-2003

ANSI C63.10-2009

The above equipment (Model: WLN-2220) has been tested by **Bureau Veritas Consumer Products Services (H.K.) Ltd., Taoyuan Branch**, and found compliance with the requirement of the above standards. The test record, data evaluation & Equipment Under Test (EUT) configurations represented herein are true and accurate accounts of the measurements of the sample's EMC characteristics under the conditions specified in this report.

PREPARED BY : Andrea Hsia , DATE: Dec. 20, 2010
Andrea Hsia / Specialist

APPROVED BY : Gary Chang , DATE: Dec. 20, 2010
Gary Chang / Assistant Manager



2. SUMMARY OF TEST RESULTS

The EUT has been tested according to the following specifications:

APPLIED STANDARD: FCC PART 15, SUBPART C (SECTION 15.247)			
STANDARD SECTION	TEST TYPE AND LIMIT	RESULT	REMARK
15.207	AC Power Conducted Emission	PASS	Meet the requirement of limit. Minimum passing margin is -14.48dB at 10.926MHz.
15.247(a)(2)	Spectrum Bandwidth of a Direct Sequence Spread Spectrum System Limit: min. 500kHz	PASS	Meet the requirement of limit.
15.247(b)	Maximum Output Power Limit: max. 30dBm	PASS	Meet the requirement of limit.
15.247(d)	Radiated Emissions Limit: Table 15.209	PASS	Meet the requirement of limit. Minimum passing margin is -1.0dB at 2390.00 & 2483.5MHz.
15.247(e)	Power Spectral Density Limit: max. 8dBm	PASS	Meet the requirement of limit.
15.247(d)	Band Edge Measurement Limit: 20dB less than the peak value of fundamental frequency	PASS	Meet the requirement of limit.
15.203	Antenna Requirement	PASS	No antenna connector is used.

2.1 MEASUREMENT UNCERTAINTY

Where relevant, the following measurement uncertainty levels have been estimated for tests performed on the EUT as specified in CISPR 16-4-2:

MEASUREMENT	FREQUENCY	UNCERTAINTY
Conducted emissions	9kHz~30MHz	2.44 dB
Radiated emissions	30MHz ~ 200MHz	2.93 dB
	200MHz ~1000MHz	2.95 dB
	1GHz ~ 18GHz	2.26 dB
	18GHz ~ 40GHz	1.94 dB

This uncertainty represents an expanded uncertainty expressed at approximately the 95% confidence level using a coverage factor of $k = 2$.



3. GENERAL INFORMATION

3.1 GENERAL DESCRIPTION OF EUT

EUT	IEEE802.11n Wireless LAN Router
MODEL NO.	WLN-2220 (Refer to NOTE for more details)
FCC ID	NHPWLN2220
POWER SUPPLY	5Vdc
MODULATION TYPE	CCK, DQPSK, DBPSK for DSSS 64QAM, 16QAM, QPSK, BPSK for OFDM
MODULATION TECHNOLOGY	DSSS, OFDM
TRANSFER RATE	802.11b: 11.0/ 5.5/ 2.0/ 1.0Mbps 802.11g: 54.0/ 48.0/ 36.0/ 24.0/ 18.0/ 12.0/ 9.0/ 6.0Mbps 802.11n: up to 300.0Mbps
OPERATING FREQUENCY	2412 ~ 2462MHz
NUMBER OF CHANNEL	11 for 802.11b, 802.11g, 802.11n (20MHz) 7 for 802.11n (40MHz)
OUTPUT POWER	598.1mW
ANTENNA TYPE	Dipole antenna with 2dBi gain
ANTENNA CONNECTOR	NA
DATA CABLE	NA
I/O PORTS	RJ45
ACCESSORY DEVICES	Adapter

NOTE:

1. The EUT has two types on market, one has RF shielding case and the other has not. Except RF shielding case, all other parts are identical.
2. The following brand and model names are electrically identical, different brand and model names are for marketing purpose.

BRAND	MODEL
CAMEO	WLN-2220
TRENDnet	TEW-652BRP

3. The EUT incorporates a MIMO function. Physically, the EUT provides two completed transmitters and two receivers.

MODULATION MODE	TX FUNCTION
802.11b	1TX
802.11g	1TX
802.11n (20MHz)	1TX/ 2TX
802.11n (40MHz)	1TX/ 2TX



A D T

4. The EUT were powered by the following adapters:

ADAPTER 1	
BRAND:	JENTEC TECHNOLOGY CO., LTD.
MODEL:	CF0605-B IW
INPUT:	100-240Vac, 0.18A, 50-60Hz
OUTPUT:	5Vdc, 1.2A
POWER LINE:	1.5 m non-shielded cable without core

ADAPTER 2	
BRAND:	AMIGO
MODEL:	AMS47-0501000FU
INPUT:	100-240Vac, 50/60Hz, 0.2A
OUTPUT:	5Vdc, 1.0A
POWER LINE:	1.5 m non-shielded cable without core

ADAPTER 3	
BRAND:	AMIGO
MODEL:	AMS1-0501200FU
INPUT:	100-240Vac, 50/60Hz, 0.2A
OUTPUT:	5Vdc, 1.2A
POWER LINE:	1.5 m non-shielded cable without core

5. The above EUT information was declared by manufacturer and for more detailed features description, please refer to the manufacturer's specifications or user's manual.

3.2 DESCRIPTION OF TEST MODES

11 channels are provided for 802.11b, 802.11g and 802.11n (20MHz):

CHANNEL	FREQUENCY	CHANNEL	FREQUENCY
1	2412MHz	7	2442MHz
2	2417MHz	8	2447MHz
3	2422MHz	9	2452MHz
4	2427MHz	10	2457MHz
5	2432MHz	11	2462MHz
6	2437MHz		

7 channels are provided for 802.11n (40MHz):

CHANNEL	FREQUENCY	CHANNEL	FREQUENCY
1	2422MHz	5	2442MHz
2	2427MHz	6	2447MHz
3	2432MHz	7	2452MHz
4	2437MHz		

3.2.1 CONFIGURATION OF SYSTEM UNDER TEST

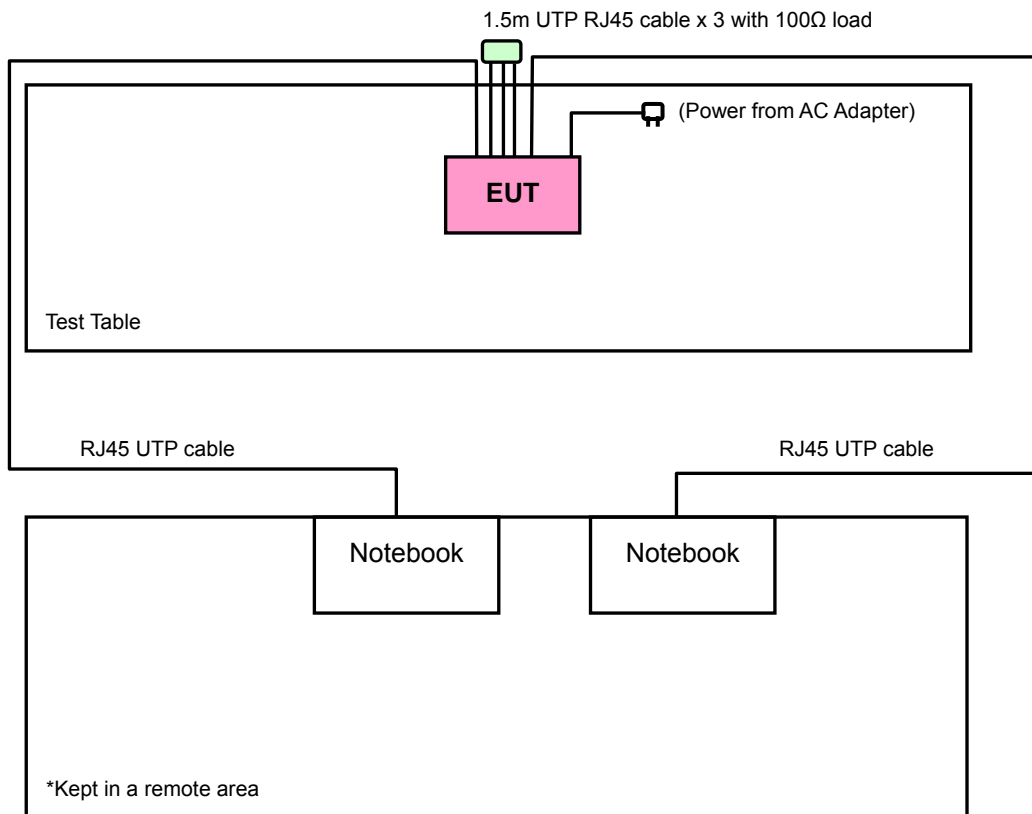



A D T

3.2.2 TEST MODE APPLICABILITY AND TESTED CHANNEL DETAIL

EUT CONFIGURE MODE	APPLICABLE TO				DESCRIPTION
	RE≥1G	RE<1G	PLC	APCM	
Sample 1: EUT with shielding case					
A1	√	√	√	√	Power from Adapter 1
B1	-	√	√	-	Power from Adapter 2
C1	-	√	√	-	Power from Adapter 3
Sample 2: EUT without shielding case					
A2	√	√	√	-	Power from Adapter 1
B2	-	√	√	-	Power from Adapter 2
C2	-	√	√	-	Power from Adapter 3

Where **RE≥1G**: Radiated Emission above 1GHz **RE<1G**: Radiated Emission below 1GHz
PLC: Power Line Conducted Emission **APCM**: Antenna Port Conducted Measurement

NOTE: "-" means no effect.

RADIATED EMISSION TEST (ABOVE 1 GHz):

- Pre-Scan has been conducted to determine the worst-case mode from all possible combinations between available modulations, data rates and antenna ports (if EUT with antenna diversity architecture).
- Following channel(s) was (were) selected for the final test as listed below.

EUT CONFIGURE MODE	MODE	AVAILABLE CHANNEL	TESTED CHANNEL	MODULATION TECHNOLOGY	MODULATION TYPE	DATA RATE (Mbps)	TX FUNCTION
A1 & A2	802.11b	1 to 11	1, 6, 11	DSSS	DBPSK	1.0	1TX
A1 & A2	802.11g	1 to 11	1, 6, 11	OFDM	BPSK	6.0	1TX
A1 & A2	802.11n (20MHz)	1 to 11	1, 6, 11	OFDM	BPSK	7.2	1TX
A1 & A2	802.11n (20MHz)	1 to 11	1, 6, 11	OFDM	BPSK	14.4	2TX
A1 & A2	802.11n (40MHz)	1 to 7	1, 4, 7	OFDM	BPSK	15.0	1TX
A1 & A2	802.11n (40MHz)	1 to 7	1, 4, 7	OFDM	BPSK	30.0	2TX

RADIATED EMISSION TEST (BELOW 1GHz):

- Pre-Scan has been conducted to determine the worst-case mode from all possible combinations between available modulations, data rates, XYZ axis and antenna ports (if EUT with antenna diversity architecture).
- Following channel(s) was (were) selected for the final test as listed below.

EUT CONFIGURE MODE	MODE	AVAILABLE CHANNEL	TESTED CHANNEL	MODULATION TECHNOLOGY	MODULATION TYPE	DATA RATE (Mbps)	TX FUNCTION
A1, B1, C1, A2, B2 & C2	802.11n (20MHz)	1 to 11	6	OFDM	BPSK	14.4	2TX

**POWER LINE CONDUCTED EMISSION TEST:**

- Pre-Scan has been conducted to determine the worst-case mode from all possible combinations between available modulations, data rates and antenna ports (if EUT with antenna diversity architecture).
- Following channel(s) was (were) selected for the final test as listed below.

EUT CONFIGURE MODE	MODE	AVAILABLE CHANNEL	TESTED CHANNEL	MODULATION TECHNOLOGY	MODULATION TYPE	DATA RATE (Mbps)	TX FUNCTION
A1, B1, C1, A2, B2 & C2	802.11n (20MHz)	1 to 11	6	OFDM	BPSK	14.4	2TX

BANDEDGE MEASUREMENT:

- Pre-Scan has been conducted to determine the worst-case mode from all possible combinations between available modulations, data rates and antenna ports (if EUT with antenna diversity architecture).
- Following channel(s) was (were) selected for the final test as listed below.

EUT CONFIGURE MODE	MODE	AVAILABLE CHANNEL	TESTED CHANNEL	MODULATION TECHNOLOGY	MODULATION TYPE	DATA RATE (Mbps)	TX FUNCTION
A1 & A2	802.11b	1 to 11	1, 11	DSSS	DBPSK	1.0	1TX
A1 & A2	802.11g	1 to 11	1, 11	OFDM	BPSK	6.0	1TX
A1 & A2	802.11n (20MHz)	1 to 11	1, 11	OFDM	BPSK	7.2	1TX
A1 & A2	802.11n (20MHz)	1 to 11	1, 11	OFDM	BPSK	14.4	2TX
A1 & A2	802.11n (40MHz)	1 to 7	1, 7	OFDM	BPSK	15.0	1TX
A1 & A2	802.11n (40MHz)	1 to 7	1, 7	OFDM	BPSK	30.0	2TX

ANTENNA PORT CONDUCTED MEASUREMENT:

- This item includes all test value of each mode, but only includes spectrum plot of worst value of each mode.
- Pre-Scan has been conducted to determine the worst-case mode from all possible combinations between available modulations, data rates and antenna ports (if EUT with antenna diversity architecture).
- Following channel(s) was (were) selected for the final test as listed below.

EUT CONFIGURE MODE	MODE	AVAILABLE CHANNEL	TESTED CHANNEL	MODULATION TECHNOLOGY	MODULATION TYPE	DATA RATE (Mbps)	TX FUNCTION
A1	802.11b	1 to 11	1, 6, 11	DSSS	DBPSK	1.0	1TX
A1	802.11g	1 to 11	1, 6, 11	OFDM	BPSK	6.0	1TX
A1	802.11n (20MHz)	1 to 11	1, 6, 11	OFDM	BPSK	7.2	1TX
A1	802.11n (20MHz)	1 to 11	1, 6, 11	OFDM	BPSK	14.4	2TX
A1	802.11n (40MHz)	1 to 7	1, 4, 7	OFDM	BPSK	15.0	1TX
A1	802.11n (40MHz)	1 to 7	1, 4, 7	OFDM	BPSK	30.0	2TX



A D T

TEST CONDITION:

APPLICABLE TO	ENVIRONMENTAL CONDITIONS	INPUT POWER	TESTED BY
RE \geq 1G	25deg. C, 65%RH, 1008 hPa	120Vac, 60Hz	Antony Lee Match Tsui
RE $<$ 1G	25deg. C, 65%RH, 1008 hPa	120Vac, 60Hz	Antony Lee Match Tsui
PLC	25deg. C, 65%RH, 1008 hPa	120Vac, 60Hz	Brad Wu
APCM	25deg. C, 65%RH, 1008 hPa	120Vac, 60Hz	Antony Lee



A D T

3.3 GENERAL DESCRIPTION OF APPLIED STANDARDS

The EUT is a RF Product. According to the specifications of the manufacturer, it must comply with the requirements of the following standards:

FCC Part 15, Subpart C (15.247)

ANSI C63.4-2003

ANSI C63.10-2009

All test items have been performed and recorded as per the above standards.

NOTE: The EUT is also considered as a kind of computer peripheral, because the connection to computer is necessary for typical use. It has been verified to comply with the requirements of FCC Part 15, Subpart B, Class B (DoC). The test report has been issued separately.

3.4 DESCRIPTION OF SUPPORT UNITS

The EUT has been tested as an independent unit together with other necessary accessories or support units. The following support units or accessories were used to form a representative test configuration during the tests.

NO.	PRODUCT	BRAND	MODEL NO.	SERIAL NO.	FCC ID
1	NOTEBOOK	DELL	D600	CN-0C3038-486 43-3A8-8646	QDS-BRCM1005-D
2	NOTEBOOK	DELL	D820	21498926752	FCC DoC Approved

NO.	SIGNAL CABLE DESCRIPTION OF THE ABOVE SUPPORT UNITS
1	10m RJ45 UTP cable
2	10m RJ45 UTP cable

NOTE:

1. All power cords of the above support units are non shielded (1.8m).
2. Items 1~2acted as communication partners to transfer data.



A D T

4. TEST TYPES AND RESULTS

4.1 RADIATED EMISSION MEASUREMENT

4.1.1 LIMITS OF RADIATED EMISSION MEASUREMENT

Emissions radiated outside of the specified bands, shall be according to the general radiated limits in 15.209 as following:

FREQUENCIES (MHz)	FIELD STRENGTH (microvolts/meter)	MEASUREMENT DISTANCE (meters)
0.009 ~ 0.490	2400/F(kHz)	300
0.490 ~ 1.705	24000/F(kHz)	30
1.705 ~ 30.0	30	30
30 ~ 88	100	3
88 ~ 216	150	3
216 ~ 960	200	3
Above 960	500	3

NOTE:

1. The lower limit shall apply at the transition frequencies.
2. Emission level (dBuV/m) = 20 log Emission level (uV/m).
3. As shown in 15.35(b), for frequencies above 1000MHz, the field strength limits are based on average detector, however, the peak field strength of any emission shall not exceed the maximum permitted average limits, specified above by more than 20dB under any condition of modulation.



A D T

4.1.2 TEST INSTRUMENTS

DESCRIPTION & MANUFACTURER	MODEL NO.	SERIAL NO.	DATE OF CALIBRATION	DUE DATE OF CALIBRATION
Test Receiver ROHDE & SCHWARZ	ESIB7	100188	Dec. 21, 2009	Dec. 20, 2010
Spectrum Analyzer ROHDE & SCHWARZ	FSP40	100041	Jul. 09, 2010	Jul. 08, 2011
BILOG Antenna SCHWARZBECK	VULB9168	9168-156	Apr. 30, 2010	Apr. 29, 2011
HORN Antenna SCHWARZBECK	BBHA 9120 D	9120D-209	Aug. 02, 2010	Aug. 01, 2011
HORN Antenna SCHWARZBECK	BBHA 9170	BBHA9170242	Dec. 25, 2009	Dec. 24, 2010
Preamplifier Agilent	8449B	3008A01910	Sep. 09, 2010	Sep. 08, 2011
Preamplifier Agilent	8447D	2944A10638	Dec. 21, 2009	Dec. 20, 2010
RF signal cable HUBER+SUHNNER	SUCOFLEX 104	218190/4 231241/4	May 14, 2010	May 13, 2011
RF signal cable Worken	8D-FB	Cable-HYCH9-01	Aug. 20, 2010	Aug. 19, 2011
Software	ADT_Radiated_ V7.6.15.9.2	NA	NA	NA
Antenna Tower EMCO	2070/2080	512.835.4684	NA	NA
Turn Table EMCO	2087-2.03	NA	NA	NA
Antenna Tower & Turn Table Controller EMCO	2090	NA	NA	NA

- NOTE:**
1. The calibration interval of the above test instruments is 12 months and the calibrations are traceable to NML/ROC and NIST/USA.
 2. The test was performed in HwaYa Chamber 9.
 3. The horn antenna and HP preamplifier (model: 8449B) are used only for the measurement of emission frequency above 1GHz if tested.
 4. The FCC Site Registration No. is 460141.
 5. The IC Site Registration No. is IC 7450F-4.



4.1.3 TEST PROCEDURES

- a. The EUT was placed on the top of a rotating table 0.8 meters above the ground at a 3 meters semi-anechoic chamber. The table was rotated 360 degrees to determine the position of the highest radiation.
- b. The EUT was set 3 meters away from the interference-receiving antenna, which was mounted on the top of a variable-height antenna tower.
- c. The antenna is a broadband antenna, and its height is varied from one meter to four meters above the ground to determine the maximum value of the field strength. Both horizontal and vertical polarizations of the antenna are set to make the measurement.
- d. For each suspected emission, the EUT was arranged to its worst case and then the antenna was tuned to heights from 1 meter to 4 meters and the rotatable table was turned from 0 degrees to 360 degrees to find the maximum reading.
- e. The test-receiver system was set to Peak Detect Function and Specified Bandwidth with Maximum Hold Mode.
- f. If the emission level of the EUT in peak mode was lower than the limit specified, then testing could be stopped and the peak values of the EUT would be reported. Otherwise the emissions would be re-tested one by one using peak, quasi-peak or average method as specified and then reported in a data sheet.

NOTE:

1. The resolution bandwidth and video bandwidth of test receiver/spectrum analyzer is 120kHz for Quasi-peak detection at frequency below 1GHz.
2. The resolution bandwidth of test receiver/spectrum analyzer is 1MHz and video bandwidth is 3MHz for Peak detection at frequency above 1GHz.
3. The resolution bandwidth of test receiver/spectrum analyzer is 1MHz and the video bandwidth is 10Hz for Average detection (AV) at frequency above 1GHz.
4. All modes of operation were investigated and the worst-case emissions are reported.

4.1.4 DEVIATION FROM TEST STANDARD

No deviation.

4.1.5 TEST SETUP

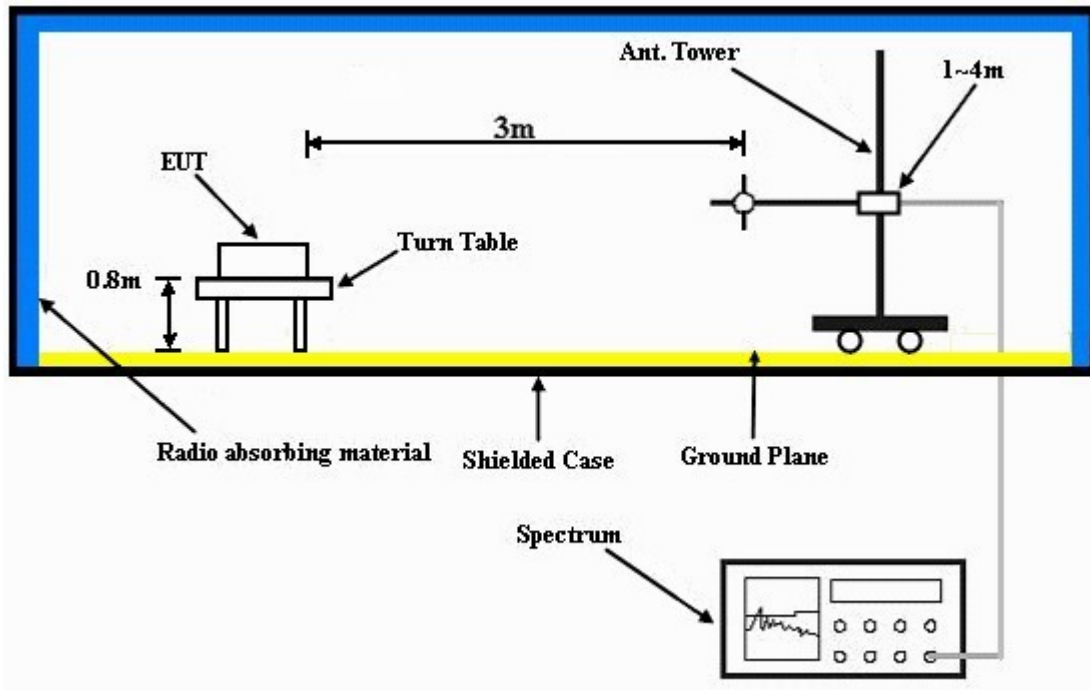

For the actual test configuration, please refer to the attached file (Test Setup Photo).

4.1.6 EUT OPERATING CONDITIONS

- a. Placed the EUT on the testing table.
- b. Prepared notebooks system outside of testing area to act as communication partners.
- c. The communication partner connected with EUT via a RJ45 UTP cable and run a test program (provided by manufacturer) to enable EUT under transmission condition continuously at specific channel frequency.
- d. The communication partner sent data to EUT by command "PING".



A D T

4.1.7 TEST RESULTS

802.11b: 1TX

EUT TEST CONDITION		MEASUREMENT DETAIL	
CHANNEL	Channel 1	FREQUENCY RANGE	1 ~ 25GHz
INPUT POWER (SYSTEM)	120Vac, 60 Hz	DETECTOR FUNCTION	Peak (PK) Average (AV)
ENVIRONMENTAL CONDITIONS	25deg. C, 65%RH 1008 hPa	TEST MODE	A1
TESTED BY	Antony Lee		

ANTENNA POLARITY & TEST DISTANCE: HORIZONTAL AT 3 M								
NO.	FREQ. (MHz)	EMISSION LEVEL (dBuV/m)	LIMIT (dBuV/m)	MARGIN (dB)	ANTENNA HEIGHT (m)	TABLE ANGLE (Degree)	RAW VALUE (dBuV)	CORRECTION FACTOR (dB/m)
1	2390.00	60.0 PK	74.0	-14.0	1.29 H	206	28.80	31.20
2	2390.00	49.6 AV	54.0	-4.4	1.29 H	206	18.40	31.20
3	*2412.00	105.3 PK			1.29 H	207	74.00	31.30
4	*2412.00	100.5 AV			1.29 H	207	69.20	31.30
5	4824.00	50.7 PK	74.0	-23.3	1.14 H	336	13.50	37.20
6	4824.00	44.7 AV	54.0	-9.3	1.14 H	336	7.50	37.20
ANTENNA POLARITY & TEST DISTANCE: VERTICAL AT 3 M								
NO.	FREQ. (MHz)	EMISSION LEVEL (dBuV/m)	LIMIT (dBuV/m)	MARGIN (dB)	ANTENNA HEIGHT (m)	TABLE ANGLE (Degree)	RAW VALUE (dBuV)	CORRECTION FACTOR (dB/m)
1	2390.00	61.1 PK	74.0	-12.9	1.00 V	6	29.90	31.20
2	2390.00	52.3 AV	54.0	-1.7	1.00 V	6	21.10	31.20
3	*2412.00	110.4 PK			1.00 V	5	79.10	31.30
4	*2412.00	105.8 AV			1.00 V	5	74.50	31.30
5	4824.00	55.0 PK	74.0	-19.0	1.00 V	291	17.80	37.20
6	4824.00	51.7 AV	54.0	-2.3	1.00 V	291	14.50	37.20

- REMARKS:**
1. Emission level (dBuV/m) = Raw Value (dBuV) + Correction Factor (dB/m).
 2. Correction Factor (dB/m) = Antenna Factor (dB/m) + Cable Factor (dB).
 3. The other emission levels were very low against the limit.
 4. Margin value = Emission level – Limit value.
 5. “ * ”: Fundamental frequency.



A D T

EUT TEST CONDITION		MEASUREMENT DETAIL	
CHANNEL	Channel 6	FREQUENCY RANGE	1 ~ 25GHz
INPUT POWER (SYSTEM)	120Vac, 60 Hz	DETECTOR FUNCTION	Peak (PK) Average (AV)
ENVIRONMENTAL CONDITIONS	25deg. C, 65%RH 1008 hPa	TEST MODE	A1
TESTED BY	Antony Lee		

ANTENNA POLARITY & TEST DISTANCE: HORIZONTAL AT 3 M								
NO.	FREQ. (MHz)	EMISSION LEVEL (dBuV/m)	LIMIT (dBuV/m)	MARGIN (dB)	ANTENNA HEIGHT (m)	TABLE ANGLE (Degree)	RAW VALUE (dBuV)	CORRECTION FACTOR (dB/m)
1	*2437.00	105.4 PK			1.20 H	213	74.10	31.30
2	*2437.00	100.2 AV			1.20 H	213	68.90	31.30
3	4874.00	47.9 PK	74.0	-26.1	1.46 H	182	10.60	37.30
4	4874.00	39.5 AV	54.0	-14.5	1.46 H	182	2.20	37.30

ANTENNA POLARITY & TEST DISTANCE: VERTICAL AT 3 M								
NO.	FREQ. (MHz)	EMISSION LEVEL (dBuV/m)	LIMIT (dBuV/m)	MARGIN (dB)	ANTENNA HEIGHT (m)	TABLE ANGLE (Degree)	RAW VALUE (dBuV)	CORRECTION FACTOR (dB/m)
1	*2437.00	110.4 PK			1.14 V	16	79.10	31.30
2	*2437.00	105.8 AV			1.14 V	16	74.50	31.30
3	4874.00	53.7 PK	74.0	-20.3	1.00 V	208	16.40	37.30
4	4874.00	49.5 AV	54.0	-4.5	1.00 V	208	12.20	37.30

- REMARKS:**
1. Emission level (dBuV/m) = Raw Value (dBuV) + Correction Factor (dB/m).
 2. Correction Factor (dB/m) = Antenna Factor (dB/m) + Cable Factor (dB).
 3. The other emission levels were very low against the limit.
 4. Margin value = Emission level – Limit value.
 5. “ * “: Fundamental frequency.



A D T

EUT TEST CONDITION		MEASUREMENT DETAIL	
CHANNEL	Channel 11	FREQUENCY RANGE	1 ~ 25GHz
INPUT POWER (SYSTEM)	120Vac, 60 Hz	DETECTOR FUNCTION	Peak (PK) Average (AV)
ENVIRONMENTAL CONDITIONS	25deg. C, 65%RH 1008 hPa	TEST MODE	A1
TESTED BY	Antony Lee		

ANTENNA POLARITY & TEST DISTANCE: HORIZONTAL AT 3 M								
NO.	FREQ. (MHz)	EMISSION LEVEL (dBuV/m)	LIMIT (dBuV/m)	MARGIN (dB)	ANTENNA HEIGHT (m)	TABLE ANGLE (Degree)	RAW VALUE (dBuV)	CORRECTION FACTOR (dB/m)
1	*2462.00	105.8 PK			1.00 H	220	74.40	31.40
2	*2462.00	100.1 AV			1.00 H	220	68.70	31.40
3	2483.50	59.1 PK	74.0	-14.9	1.00 H	215	27.60	31.50
4	2483.50	50.1 AV	54.0	-3.9	1.00 H	215	18.60	31.50
5	4924.00	48.3 PK	74.0	-25.7	1.00 H	193	10.90	37.40
6	4924.00	39.7 AV	54.0	-14.3	1.00 H	193	2.30	37.40
ANTENNA POLARITY & TEST DISTANCE: VERTICAL AT 3 M								
NO.	FREQ. (MHz)	EMISSION LEVEL (dBuV/m)	LIMIT (dBuV/m)	MARGIN (dB)	ANTENNA HEIGHT (m)	TABLE ANGLE (Degree)	RAW VALUE (dBuV)	CORRECTION FACTOR (dB/m)
1	*2462.00	110.0 PK			1.42 V	187	78.60	31.40
2	*2462.00	105.2 AV			1.42 V	187	73.80	31.40
3	2483.50	63.4 PK	74.0	-10.6	1.08 V	273	31.90	31.50
4	2483.50	53.0 AV	54.0	-1.0	1.08 V	273	21.50	31.50
5	4924.00	54.3 PK	74.0	-19.7	1.00 V	198	16.90	37.40
6	4924.00	49.5 AV	54.0	-4.5	1.00 V	198	12.10	37.40

- REMARKS:**
1. Emission level (dBuV/m) = Raw Value (dBuV) + Correction Factor (dB/m).
 2. Correction Factor (dB/m) = Antenna Factor (dB/m) + Cable Factor (dB).
 3. The other emission levels were very low against the limit.
 4. Margin value = Emission level – Limit value.
 5. “ * “: Fundamental frequency.



A D T

EUT TEST CONDITION		MEASUREMENT DETAIL	
CHANNEL	Channel 1	FREQUENCY RANGE	1 ~ 25GHz
INPUT POWER (SYSTEM)	120Vac, 60 Hz	DETECTOR FUNCTION	Peak (PK) Average (AV)
ENVIRONMENTAL CONDITIONS	25deg. C, 65%RH 1008 hPa	TEST MODE	A2
TESTED BY	Match Tsui		

ANTENNA POLARITY & TEST DISTANCE: HORIZONTAL AT 3 M								
NO.	FREQ. (MHz)	EMISSION LEVEL (dBuV/m)	LIMIT (dBuV/m)	MARGIN (dB)	ANTENNA HEIGHT (m)	TABLE ANGLE (Degree)	RAW VALUE (dBuV)	CORRECTION FACTOR (dB/m)
1	2390.00	59.8 PK	74.0	-14.2	1.22 H	193	28.60	31.20
2	2390.00	49.3 AV	54.0	-4.7	1.22 H	193	18.10	31.20
3	*2412.00	106.1 PK			1.25 H	210	74.80	31.30
4	*2412.00	99.1 AV			1.25 H	210	67.80	31.30
5	4824.00	51.1 PK	74.0	-22.9	1.10 H	142	13.90	37.20
6	4824.00	45.3 AV	54.0	-8.7	1.10 H	142	8.10	37.20
ANTENNA POLARITY & TEST DISTANCE: VERTICAL AT 3 M								
NO.	FREQ. (MHz)	EMISSION LEVEL (dBuV/m)	LIMIT (dBuV/m)	MARGIN (dB)	ANTENNA HEIGHT (m)	TABLE ANGLE (Degree)	RAW VALUE (dBuV)	CORRECTION FACTOR (dB/m)
1	2390.00	61.3 PK	74.0	-12.7	1.02 V	12	30.10	31.20
2	2390.00	52.6 AV	54.0	-1.4	1.02 V	12	21.40	31.20
3	*2412.00	109.1 PK			1.03 V	55	77.80	31.30
4	*2412.00	104.6 AV			1.03 V	55	73.30	31.30
5	4824.00	55.5 PK	74.0	-18.5	1.10 V	125	18.30	37.20
6	4824.00	52.2 AV	54.0	-1.8	1.10 V	125	15.00	37.20

- REMARKS:**
1. Emission level (dBuV/m) = Raw Value (dBuV) + Correction Factor (dB/m).
 2. Correction Factor (dB/m) = Antenna Factor (dB/m) + Cable Factor (dB).
 3. The other emission levels were very low against the limit.
 4. Margin value = Emission level – Limit value.
 5. “ * “: Fundamental frequency.



A D T

EUT TEST CONDITION		MEASUREMENT DETAIL	
CHANNEL	Channel 6	FREQUENCY RANGE	1 ~ 25GHz
INPUT POWER (SYSTEM)	120Vac, 60 Hz	DETECTOR FUNCTION	Peak (PK) Average (AV)
ENVIRONMENTAL CONDITIONS	25deg. C, 65%RH 1008 hPa	TEST MODE	A2
TESTED BY	Match Tsui		

ANTENNA POLARITY & TEST DISTANCE: HORIZONTAL AT 3 M								
NO.	FREQ. (MHz)	EMISSION LEVEL (dBuV/m)	LIMIT (dBuV/m)	MARGIN (dB)	ANTENNA HEIGHT (m)	TABLE ANGLE (Degree)	RAW VALUE (dBuV)	CORRECTION FACTOR (dB/m)
1	*2437.00	104.0 PK			1.11 H	130	72.70	31.30
2	*2437.00	98.8 AV			1.11 H	130	67.50	31.30
3	4874.00	50.1 PK	74.0	-23.9	1.52 H	133	12.80	37.30
4	4874.00	45.1 AV	54.0	-8.9	1.52 H	133	7.80	37.30
ANTENNA POLARITY & TEST DISTANCE: VERTICAL AT 3 M								
NO.	FREQ. (MHz)	EMISSION LEVEL (dBuV/m)	LIMIT (dBuV/m)	MARGIN (dB)	ANTENNA HEIGHT (m)	TABLE ANGLE (Degree)	RAW VALUE (dBuV)	CORRECTION FACTOR (dB/m)
1	*2437.00	109.2 PK			1.18 V	32	77.90	31.30
2	*2437.00	104.5 AV			1.18 V	32	73.20	31.30
3	4874.00	55.5 PK	74.0	-18.5	1.05 V	163	18.20	37.30
4	4874.00	52.5 AV	54.0	-1.5	1.05 V	163	15.20	37.30

- REMARKS:**
1. Emission level (dBuV/m) = Raw Value (dBuV) + Correction Factor (dB/m).
 2. Correction Factor (dB/m) = Antenna Factor (dB/m) + Cable Factor (dB).
 3. The other emission levels were very low against the limit.
 4. Margin value = Emission level – Limit value.
 5. “ * “: Fundamental frequency.



A D T

EUT TEST CONDITION		MEASUREMENT DETAIL	
CHANNEL	Channel 11	FREQUENCY RANGE	1 ~ 25GHz
INPUT POWER (SYSTEM)	120Vac, 60 Hz	DETECTOR FUNCTION	Peak (PK) Average (AV)
ENVIRONMENTAL CONDITIONS	25deg. C, 65%RH 1008 hPa	TEST MODE	A2
TESTED BY	Match Tsui		

ANTENNA POLARITY & TEST DISTANCE: HORIZONTAL AT 3 M								
NO.	FREQ. (MHz)	EMISSION LEVEL (dBuV/m)	LIMIT (dBuV/m)	MARGIN (dB)	ANTENNA HEIGHT (m)	TABLE ANGLE (Degree)	RAW VALUE (dBuV)	CORRECTION FACTOR (dB/m)
1	*2462.00	104.5 PK			1.05 H	203	73.10	31.40
2	*2462.00	98.9 AV			1.05 H	203	67.50	31.40
3	2483.50	59.6 PK	74.0	-14.4	1.02 H	233	28.10	31.50
4	2483.50	50.7 AV	54.0	-3.3	1.02 H	233	19.20	31.50
5	4924.00	50.8 PK	74.0	-23.2	1.22 H	149	13.40	37.40
6	4924.00	44.7 AV	54.0	-9.3	1.22 H	149	7.30	37.40
ANTENNA POLARITY & TEST DISTANCE: VERTICAL AT 3 M								
NO.	FREQ. (MHz)	EMISSION LEVEL (dBuV/m)	LIMIT (dBuV/m)	MARGIN (dB)	ANTENNA HEIGHT (m)	TABLE ANGLE (Degree)	RAW VALUE (dBuV)	CORRECTION FACTOR (dB/m)
1	*2462.00	108.7 PK			1.21 V	93	77.30	31.40
2	*2462.00	103.8 AV			1.21 V	93	72.40	31.40
3	2483.50	63.2 PK	74.0	-10.8	1.12 V	266	31.70	31.50
4	2483.50	52.9 AV	54.0	-1.1	1.12 V	266	21.40	31.50
5	4924.00	55.2 PK	74.0	-18.8	1.03 V	255	17.80	37.40
6	4924.00	52.7 AV	54.0	-1.3	1.03 V	255	15.30	37.40

- REMARKS:**
1. Emission level (dBuV/m) = Raw Value (dBuV) + Correction Factor (dB/m).
 2. Correction Factor (dB/m) = Antenna Factor (dB/m) + Cable Factor (dB).
 3. The other emission levels were very low against the limit.
 4. Margin value = Emission level – Limit value.
 5. “ * “: Fundamental frequency.



A D T

802.11g: 1TX

EUT TEST CONDITION		MEASUREMENT DETAIL	
CHANNEL	Channel 1	FREQUENCY RANGE	1 ~ 25GHz
INPUT POWER (SYSTEM)	120Vac, 60 Hz	DETECTOR FUNCTION	Peak (PK) Average (AV)
ENVIRONMENTAL CONDITIONS	25deg. C, 65%RH 1008 hPa	TEST MODE	A1
TESTED BY	Antony Lee		

ANTENNA POLARITY & TEST DISTANCE: HORIZONTAL AT 3 M								
NO.	FREQ. (MHz)	EMISSION LEVEL (dBuV/m)	LIMIT (dBuV/m)	MARGIN (dB)	ANTENNA HEIGHT (m)	TABLE ANGLE (Degree)	RAW VALUE (dBuV)	CORRECTION FACTOR (dB/m)
1	2390.00	59.5 PK	74.0	-14.5	1.00 H	168	28.30	31.20
2	2390.00	46.8 AV	54.0	-7.2	1.00 H	168	15.60	31.20
3	*2412.00	99.5 PK			1.00 H	168	68.20	31.30
4	*2412.00	89.8 AV			1.00 H	168	58.50	31.30
5	4824.00	48.3 PK	74.0	-25.7	1.00 H	201	11.10	37.20
6	4824.00	36.9 AV	54.0	-17.1	1.00 H	201	-0.30	37.20
ANTENNA POLARITY & TEST DISTANCE: VERTICAL AT 3 M								
NO.	FREQ. (MHz)	EMISSION LEVEL (dBuV/m)	LIMIT (dBuV/m)	MARGIN (dB)	ANTENNA HEIGHT (m)	TABLE ANGLE (Degree)	RAW VALUE (dBuV)	CORRECTION FACTOR (dB/m)
1	2390.00	67.3 PK	74.0	-6.7	1.00 V	194	36.10	31.20
2	2390.00	52.7 AV	54.0	-1.3	1.00 V	194	21.50	31.20
3	*2412.00	105.9 PK			1.00 V	197	74.60	31.30
4	*2412.00	95.4 AV			1.00 V	197	64.10	31.30
5	4824.00	50.0 PK	74.0	-24.0	1.00 V	163	12.80	37.20
6	4824.00	36.6 AV	54.0	-17.4	1.00 V	163	-0.60	37.20

- REMARKS:**
1. Emission level (dBuV/m) = Raw Value (dBuV) + Correction Factor (dB/m).
 2. Correction Factor (dB/m) = Antenna Factor (dB/m) + Cable Factor (dB).
 3. The other emission levels were very low against the limit.
 4. Margin value = Emission level – Limit value.
 5. “ * “: Fundamental frequency.



A D T

EUT TEST CONDITION		MEASUREMENT DETAIL	
CHANNEL	Channel 6	FREQUENCY RANGE	1 ~ 25GHz
INPUT POWER (SYSTEM)	120Vac, 60 Hz	DETECTOR FUNCTION	Peak (PK) Average (AV)
ENVIRONMENTAL CONDITIONS	25deg. C, 65%RH 1008 hPa	TEST MODE	A1
TESTED BY	Antony Lee		

ANTENNA POLARITY & TEST DISTANCE: HORIZONTAL AT 3 M								
NO.	FREQ. (MHz)	EMISSION LEVEL (dBuV/m)	LIMIT (dBuV/m)	MARGIN (dB)	ANTENNA HEIGHT (m)	TABLE ANGLE (Degree)	RAW VALUE (dBuV)	CORRECTION FACTOR (dB/m)
1	*2437.00	99.8 PK			1.00 H	183	68.50	31.30
2	*2437.00	89.2 AV			1.00 H	183	57.90	31.30
3	4874.00	43.1 PK	74.0	-30.9	1.00 H	198	5.80	37.30
4	4874.00	30.8 AV	54.0	-23.2	1.00 H	198	-6.50	37.30
ANTENNA POLARITY & TEST DISTANCE: VERTICAL AT 3 M								
NO.	FREQ. (MHz)	EMISSION LEVEL (dBuV/m)	LIMIT (dBuV/m)	MARGIN (dB)	ANTENNA HEIGHT (m)	TABLE ANGLE (Degree)	RAW VALUE (dBuV)	CORRECTION FACTOR (dB/m)
1	*2437.00	105.4 PK			1.06 V	182	74.10	31.30
2	*2437.00	95.8 AV			1.06 V	182	64.50	31.30
3	4874.00	46.2 PK	74.0	-27.8	1.00 V	159	8.90	37.30
4	4874.00	33.2 AV	54.0	-20.8	1.00 V	159	-4.10	37.30

- REMARKS:**
1. Emission level (dBuV/m) = Raw Value (dBuV) + Correction Factor (dB/m).
 2. Correction Factor (dB/m) = Antenna Factor (dB/m) + Cable Factor (dB).
 3. The other emission levels were very low against the limit.
 4. Margin value = Emission level – Limit value.
 5. “ * “: Fundamental frequency.



A D T

EUT TEST CONDITION		MEASUREMENT DETAIL	
CHANNEL	Channel 11	FREQUENCY RANGE	1 ~ 25GHz
INPUT POWER (SYSTEM)	120Vac, 60 Hz	DETECTOR FUNCTION	Peak (PK) Average (AV)
ENVIRONMENTAL CONDITIONS	25deg. C, 65%RH 1008 hPa	TEST MODE	A1
TESTED BY	Antony Lee		

ANTENNA POLARITY & TEST DISTANCE: HORIZONTAL AT 3 M								
NO.	FREQ. (MHz)	EMISSION LEVEL (dBuV/m)	LIMIT (dBuV/m)	MARGIN (dB)	ANTENNA HEIGHT (m)	TABLE ANGLE (Degree)	RAW VALUE (dBuV)	CORRECTION FACTOR (dB/m)
1	*2462.00	98.4 PK			1.00 H	164	67.00	31.40
2	*2462.00	88.9 AV			1.00 H	164	57.50	31.40
3	2483.50	59.7 PK	74.0	-14.3	1.00 H	191	28.20	31.50
4	2483.50	46.3 AV	54.0	-7.7	1.00 H	191	14.80	31.50
5	4924.00	43.4 PK	74.0	-30.6	1.00 H	105	6.00	37.40
6	4924.00	29.9 AV	54.0	-24.1	1.00 H	105	-7.50	37.40
ANTENNA POLARITY & TEST DISTANCE: VERTICAL AT 3 M								
NO.	FREQ. (MHz)	EMISSION LEVEL (dBuV/m)	LIMIT (dBuV/m)	MARGIN (dB)	ANTENNA HEIGHT (m)	TABLE ANGLE (Degree)	RAW VALUE (dBuV)	CORRECTION FACTOR (dB/m)
1	*2462.00	105.6 PK			1.00 V	177	74.20	31.40
2	*2462.00	95.9 AV			1.00 V	177	64.50	31.40
3	2483.50	69.7 PK	74.0	-4.3	1.00 V	185	38.20	31.50
4	2483.50	52.8 AV	54.0	-1.2	1.00 V	185	21.30	31.50
5	4924.00	45.7 PK	74.0	-28.3	1.00 V	23	8.30	37.40
6	4924.00	32.3 AV	54.0	-21.7	1.00 V	23	-5.10	37.40

- REMARKS:**
1. Emission level (dBuV/m) = Raw Value (dBuV) + Correction Factor (dB/m).
 2. Correction Factor (dB/m) = Antenna Factor (dB/m) + Cable Factor (dB).
 3. The other emission levels were very low against the limit.
 4. Margin value = Emission level – Limit value.
 5. “ * “: Fundamental frequency.



A D T

EUT TEST CONDITION		MEASUREMENT DETAIL	
CHANNEL	Channel 1	FREQUENCY RANGE	1 ~ 25GHz
INPUT POWER (SYSTEM)	120Vac, 60 Hz	DETECTOR FUNCTION	Peak (PK) Average (AV)
ENVIRONMENTAL CONDITIONS	25deg. C, 65%RH 1008 hPa	TEST MODE	A2
TESTED BY	Match Tsui		

ANTENNA POLARITY & TEST DISTANCE: HORIZONTAL AT 3 M								
NO.	FREQ. (MHz)	EMISSION LEVEL (dBuV/m)	LIMIT (dBuV/m)	MARGIN (dB)	ANTENNA HEIGHT (m)	TABLE ANGLE (Degree)	RAW VALUE (dBuV)	CORRECTION FACTOR (dB/m)
1	2390.00	59.2 PK	74.0	-14.8	1.02 H	172	28.00	31.20
2	2390.00	46.5 AV	54.0	-7.5	1.02 H	172	15.30	31.20
3	*2412.00	101.7 PK			1.06 H	152	70.40	31.30
4	*2412.00	91.8 AV			1.06 H	152	60.50	31.30
5	4824.00	51.4 PK	74.0	-22.6	1.22 H	193	14.20	37.20
6	4824.00	37.3 AV	54.0	-16.7	1.22 H	193	0.10	37.20
ANTENNA POLARITY & TEST DISTANCE: VERTICAL AT 3 M								
NO.	FREQ. (MHz)	EMISSION LEVEL (dBuV/m)	LIMIT (dBuV/m)	MARGIN (dB)	ANTENNA HEIGHT (m)	TABLE ANGLE (Degree)	RAW VALUE (dBuV)	CORRECTION FACTOR (dB/m)
1	2390.00	67.0 PK	74.0	-7.0	1.04 V	127	35.80	31.20
2	2390.00	52.5 AV	54.0	-1.5	1.04 V	127	21.30	31.20
3	*2412.00	108.1 PK			1.03 V	188	76.80	31.30
4	*2412.00	97.5 AV			1.03 V	188	66.20	31.30
5	4824.00	52.3 PK	74.0	-21.7	1.06 V	321	15.10	37.20
6	4824.00	38.2 AV	54.0	-15.8	1.06 V	321	1.00	37.20

- REMARKS:**
1. Emission level (dBuV/m) = Raw Value (dBuV) + Correction Factor (dB/m).
 2. Correction Factor (dB/m) = Antenna Factor (dB/m) + Cable Factor (dB).
 3. The other emission levels were very low against the limit.
 4. Margin value = Emission level – Limit value.
 5. “ * ”: Fundamental frequency.



A D T

EUT TEST CONDITION		MEASUREMENT DETAIL	
CHANNEL	Channel 6	FREQUENCY RANGE	1 ~ 25GHz
INPUT POWER (SYSTEM)	120Vac, 60 Hz	DETECTOR FUNCTION	Peak (PK) Average (AV)
ENVIRONMENTAL CONDITIONS	25deg. C, 65%RH 1008 hPa	TEST MODE	A2
TESTED BY	Match Tsui		

ANTENNA POLARITY & TEST DISTANCE: HORIZONTAL AT 3 M								
NO.	FREQ. (MHz)	EMISSION LEVEL (dBuV/m)	LIMIT (dBuV/m)	MARGIN (dB)	ANTENNA HEIGHT (m)	TABLE ANGLE (Degree)	RAW VALUE (dBuV)	CORRECTION FACTOR (dB/m)
1	*2437.00	101.9 PK			1.01 H	124	70.60	31.30
2	*2437.00	91.3 AV			1.01 H	124	60.00	31.30
3	4874.00	50.8 PK	74.0	-23.2	1.08 H	53	13.50	37.30
4	4874.00	36.9 AV	54.0	-17.1	1.08 H	53	-0.40	37.30
ANTENNA POLARITY & TEST DISTANCE: VERTICAL AT 3 M								
NO.	FREQ. (MHz)	EMISSION LEVEL (dBuV/m)	LIMIT (dBuV/m)	MARGIN (dB)	ANTENNA HEIGHT (m)	TABLE ANGLE (Degree)	RAW VALUE (dBuV)	CORRECTION FACTOR (dB/m)
1	*2437.00	107.6 PK			1.03 V	193	76.30	31.30
2	*2437.00	98.1 AV			1.03 V	193	66.80	31.30
3	4874.00	51.8 PK	74.0	-22.2	1.20 V	241	14.50	37.30
4	4874.00	37.8 AV	54.0	-16.2	1.20 V	241	0.50	37.30

- REMARKS:**
1. Emission level (dBuV/m) = Raw Value (dBuV) + Correction Factor (dB/m).
 2. Correction Factor (dB/m) = Antenna Factor (dB/m) + Cable Factor (dB).
 3. The other emission levels were very low against the limit.
 4. Margin value = Emission level – Limit value.
 5. “ * ”: Fundamental frequency.



A D T

EUT TEST CONDITION		MEASUREMENT DETAIL	
CHANNEL	Channel 11	FREQUENCY RANGE	1 ~ 25GHz
INPUT POWER (SYSTEM)	120Vac, 60 Hz	DETECTOR FUNCTION	Peak (PK) Average (AV)
ENVIRONMENTAL CONDITIONS	25deg. C, 65%RH 1008 hPa	TEST MODE	A2
TESTED BY	Match Tsui		

ANTENNA POLARITY & TEST DISTANCE: HORIZONTAL AT 3 M								
NO.	FREQ. (MHz)	EMISSION LEVEL (dBuV/m)	LIMIT (dBuV/m)	MARGIN (dB)	ANTENNA HEIGHT (m)	TABLE ANGLE (Degree)	RAW VALUE (dBuV)	CORRECTION FACTOR (dB/m)
1	*2462.00	100.5 PK			1.05 H	144	69.10	31.40
2	*2462.00	91.0 AV			1.05 H	144	59.60	31.40
3	2483.50	59.4 PK	74.0	-14.6	1.03 H	171	27.90	31.50
4	2483.50	46.0 AV	54.0	-8.0	1.03 H	171	14.50	31.50
5	4924.00	50.7 PK	74.0	-23.3	1.08 H	143	13.30	37.40
6	4924.00	36.1 AV	54.0	-17.9	1.08 H	143	-1.30	37.40
ANTENNA POLARITY & TEST DISTANCE: VERTICAL AT 3 M								
NO.	FREQ. (MHz)	EMISSION LEVEL (dBuV/m)	LIMIT (dBuV/m)	MARGIN (dB)	ANTENNA HEIGHT (m)	TABLE ANGLE (Degree)	RAW VALUE (dBuV)	CORRECTION FACTOR (dB/m)
1	*2462.00	107.7 PK			1.03 V	188	76.30	31.40
2	*2462.00	98.0 AV			1.03 V	188	66.60	31.40
3	2483.50	67.2 PK	74.0	-6.8	1.09 V	169	35.70	31.50
4	2483.50	52.5 AV	54.0	-1.5	1.09 V	169	21.00	31.50
5	4924.00	51.6 PK	74.0	-22.4	1.15 V	194	14.20	37.40
6	4924.00	37.5 AV	54.0	-16.5	1.15 V	194	0.10	37.40

- REMARKS:**
1. Emission level (dBuV/m) = Raw Value (dBuV) + Correction Factor (dB/m).
 2. Correction Factor (dB/m) = Antenna Factor (dB/m) + Cable Factor (dB).
 3. The other emission levels were very low against the limit.
 4. Margin value = Emission level – Limit value.
 5. “ * ”: Fundamental frequency.



A D T

802.11n (20MHz): 1TX

EUT TEST CONDITION		MEASUREMENT DETAIL	
CHANNEL	Channel 1	FREQUENCY RANGE	1 ~ 25GHz
INPUT POWER (SYSTEM)	120Vac, 60 Hz	DETECTOR FUNCTION	Peak (PK) Average (AV)
ENVIRONMENTAL CONDITIONS	25deg. C, 65%RH 1008 hPa	TEST MODE	A1
TESTED BY	Antony Lee		

ANTENNA POLARITY & TEST DISTANCE: HORIZONTAL AT 3 M								
NO.	FREQ. (MHz)	EMISSION LEVEL (dBuV/m)	LIMIT (dBuV/m)	MARGIN (dB)	ANTENNA HEIGHT (m)	TABLE ANGLE (Degree)	RAW VALUE (dBuV)	CORRECTION FACTOR (dB/m)
1	2390.00	61.6 PK	74.0	-12.4	1.00 H	150	30.40	31.20
2	2390.00	46.1 AV	54.0	-7.9	1.00 H	150	14.90	31.20
3	*2412.00	99.1 PK			1.00 H	149	67.80	31.30
4	*2412.00	89.4 AV			1.00 H	149	58.10	31.30
5	4824.00	44.5 PK	74.0	-29.5	1.00 H	130	7.30	37.20
6	4824.00	31.0 AV	54.0	-23.0	1.00 H	130	-6.20	37.20
ANTENNA POLARITY & TEST DISTANCE: VERTICAL AT 3 M								
NO.	FREQ. (MHz)	EMISSION LEVEL (dBuV/m)	LIMIT (dBuV/m)	MARGIN (dB)	ANTENNA HEIGHT (m)	TABLE ANGLE (Degree)	RAW VALUE (dBuV)	CORRECTION FACTOR (dB/m)
1	2390.00	71.6 PK	74.0	-2.4	1.24 V	212	40.40	31.20
2	2390.00	52.5 AV	54.0	-1.5	1.24 V	212	21.30	31.20
3	*2412.00	105.0 PK			1.25 V	212	73.70	31.30
4	*2412.00	94.8 AV			1.25 V	212	63.50	31.30
5	4824.00	47.9 PK	74.0	-26.1	1.00 V	166	10.70	37.20
6	4824.00	34.4 AV	54.0	-19.6	1.00 V	166	-2.80	37.20

- REMARKS:**
1. Emission level (dBuV/m) = Raw Value (dBuV) + Correction Factor (dB/m).
 2. Correction Factor (dB/m) = Antenna Factor (dB/m) + Cable Factor (dB).
 3. The other emission levels were very low against the limit.
 4. Margin value = Emission level – Limit value.
 5. “ * “: Fundamental frequency.



A D T

EUT TEST CONDITION		MEASUREMENT DETAIL	
CHANNEL	Channel 6	FREQUENCY RANGE	1 ~ 25GHz
INPUT POWER (SYSTEM)	120Vac, 60 Hz	DETECTOR FUNCTION	Peak (PK) Average (AV)
ENVIRONMENTAL CONDITIONS	25deg. C, 65%RH 1008 hPa	TEST MODE	A1
TESTED BY	Antony Lee		

ANTENNA POLARITY & TEST DISTANCE: HORIZONTAL AT 3 M								
NO.	FREQ. (MHz)	EMISSION LEVEL (dBuV/m)	LIMIT (dBuV/m)	MARGIN (dB)	ANTENNA HEIGHT (m)	TABLE ANGLE (Degree)	RAW VALUE (dBuV)	CORRECTION FACTOR (dB/m)
1	*2437.00	99.5 PK			1.00 H	152	68.20	31.30
2	*2437.00	89.3 AV			1.00 H	152	58.00	31.30
3	4874.00	43.7 PK	74.0	-30.3	1.00 H	125	6.40	37.30
4	4874.00	31.6 AV	54.0	-22.4	1.00 H	125	-5.70	37.30
ANTENNA POLARITY & TEST DISTANCE: VERTICAL AT 3 M								
NO.	FREQ. (MHz)	EMISSION LEVEL (dBuV/m)	LIMIT (dBuV/m)	MARGIN (dB)	ANTENNA HEIGHT (m)	TABLE ANGLE (Degree)	RAW VALUE (dBuV)	CORRECTION FACTOR (dB/m)
1	*2437.00	105.8 PK			1.00 V	208	74.50	31.30
2	*2437.00	95.5 AV			1.00 V	208	64.20	31.30
3	4874.00	47.4 PK	74.0	-26.6	1.00 V	169	10.10	37.30
4	4874.00	35.7 AV	54.0	-18.3	1.00 V	169	-1.60	37.30

- REMARKS:**
1. Emission level (dBuV/m) = Raw Value (dBuV) + Correction Factor (dB/m).
 2. Correction Factor (dB/m) = Antenna Factor (dB/m) + Cable Factor (dB).
 3. The other emission levels were very low against the limit.
 4. Margin value = Emission level – Limit value.
 5. “ * “: Fundamental frequency.



A D T

EUT TEST CONDITION		MEASUREMENT DETAIL	
CHANNEL	Channel 11	FREQUENCY RANGE	1 ~ 25GHz
INPUT POWER (SYSTEM)	120Vac, 60 Hz	DETECTOR FUNCTION	Peak (PK) Average (AV)
ENVIRONMENTAL CONDITIONS	25deg. C, 65%RH 1008 hPa	TEST MODE	A1
TESTED BY	Antony Lee		

ANTENNA POLARITY & TEST DISTANCE: HORIZONTAL AT 3 M								
NO.	FREQ. (MHz)	EMISSION LEVEL (dBuV/m)	LIMIT (dBuV/m)	MARGIN (dB)	ANTENNA HEIGHT (m)	TABLE ANGLE (Degree)	RAW VALUE (dBuV)	CORRECTION FACTOR (dB/m)
1	*2462.00	98.9 PK			1.00 H	183	67.50	31.40
2	*2462.00	89.8 AV			1.00 H	183	58.40	31.40
3	2483.50	62.7 PK	74.0	-11.3	1.00 H	182	31.20	31.50
4	2483.50	47.7 AV	54.0	-6.3	1.00 H	182	16.20	31.50
5	4924.00	44.8 PK	74.0	-29.2	1.00 H	125	7.40	37.40
6	4924.00	31.3 AV	54.0	-22.7	1.00 H	125	-6.10	37.40
ANTENNA POLARITY & TEST DISTANCE: VERTICAL AT 3 M								
NO.	FREQ. (MHz)	EMISSION LEVEL (dBuV/m)	LIMIT (dBuV/m)	MARGIN (dB)	ANTENNA HEIGHT (m)	TABLE ANGLE (Degree)	RAW VALUE (dBuV)	CORRECTION FACTOR (dB/m)
1	*2462.00	105.2 PK			1.45 V	202	73.80	31.40
2	*2462.00	94.1 AV			1.45 V	202	62.70	31.40
3	2483.50	68.7 PK	74.0	-5.3	1.44 V	201	37.20	31.50
4	2483.50	52.9 AV	54.0	-1.1	1.44 V	201	21.40	31.50
5	4924.00	48.3 PK	74.0	-25.7	1.00 V	168	10.90	37.40
6	4924.00	34.6 AV	54.0	-19.4	1.00 V	168	-2.80	37.40

- REMARKS:**
1. Emission level (dBuV/m) = Raw Value (dBuV) + Correction Factor (dB/m).
 2. Correction Factor (dB/m) = Antenna Factor (dB/m) + Cable Factor (dB).
 3. The other emission levels were very low against the limit.
 4. Margin value = Emission level – Limit value.
 5. “ * “: Fundamental frequency.



A D T

EUT TEST CONDITION		MEASUREMENT DETAIL	
CHANNEL	Channel 1	FREQUENCY RANGE	1 ~ 25GHz
INPUT POWER (SYSTEM)	120Vac, 60 Hz	DETECTOR FUNCTION	Peak (PK) Average (AV)
ENVIRONMENTAL CONDITIONS	25deg. C, 65%RH 1008 hPa	TEST MODE	A2
TESTED BY	Match Tsui		

ANTENNA POLARITY & TEST DISTANCE: HORIZONTAL AT 3 M								
NO.	FREQ. (MHz)	EMISSION LEVEL (dBuV/m)	LIMIT (dBuV/m)	MARGIN (dB)	ANTENNA HEIGHT (m)	TABLE ANGLE (Degree)	RAW VALUE (dBuV)	CORRECTION FACTOR (dB/m)
1	2390.00	61.9 PK	74.0	-12.1	1.04 H	103	30.70	31.20
2	2390.00	46.3 AV	54.0	-7.7	1.04 H	103	15.10	31.20
3	*2412.00	101.3 PK			1.05 H	193	70.00	31.30
4	*2412.00	91.7 AV			1.05 H	193	60.40	31.30
5	4824.00	51.0 PK	74.0	-23.0	1.12 H	10	13.80	37.20
6	4824.00	36.7 AV	54.0	-17.3	1.12 H	10	-0.50	37.20
ANTENNA POLARITY & TEST DISTANCE: VERTICAL AT 3 M								
NO.	FREQ. (MHz)	EMISSION LEVEL (dBuV/m)	LIMIT (dBuV/m)	MARGIN (dB)	ANTENNA HEIGHT (m)	TABLE ANGLE (Degree)	RAW VALUE (dBuV)	CORRECTION FACTOR (dB/m)
1	2390.00	72.5 PK	74.0	-1.5	1.02 V	188	41.30	31.20
2	2390.00	52.8 AV	54.0	-1.2	1.02 V	188	21.60	31.20
3	*2412.00	107.0 PK			1.13 V	125	75.70	31.30
4	*2412.00	96.7 AV			1.13 V	125	65.40	31.30
5	4824.00	52.7 PK	74.0	-21.3	1.02 V	13	15.50	37.20
6	4824.00	38.6 AV	54.0	-15.4	1.02 V	13	1.40	37.20

- REMARKS:**
1. Emission level (dBuV/m) = Raw Value (dBuV) + Correction Factor (dB/m).
 2. Correction Factor (dB/m) = Antenna Factor (dB/m) + Cable Factor (dB).
 3. The other emission levels were very low against the limit.
 4. Margin value = Emission level – Limit value.
 5. “ * “: Fundamental frequency.



A D T

EUT TEST CONDITION		MEASUREMENT DETAIL	
CHANNEL	Channel 6	FREQUENCY RANGE	1 ~ 25GHz
INPUT POWER (SYSTEM)	120Vac, 60 Hz	DETECTOR FUNCTION	Peak (PK) Average (AV)
ENVIRONMENTAL CONDITIONS	25deg. C, 65%RH 1008 hPa	TEST MODE	A2
TESTED BY	Match Tsui		

ANTENNA POLARITY & TEST DISTANCE: HORIZONTAL AT 3 M								
NO.	FREQ. (MHz)	EMISSION LEVEL (dBuV/m)	LIMIT (dBuV/m)	MARGIN (dB)	ANTENNA HEIGHT (m)	TABLE ANGLE (Degree)	RAW VALUE (dBuV)	CORRECTION FACTOR (dB/m)
1	*2437.00	101.5 PK			1.12 H	252	70.20	31.30
2	*2437.00	91.4 AV			1.12 H	252	60.10	31.30
3	4874.00	51.2 PK	74.0	-22.8	1.08 H	144	13.90	37.30
4	4874.00	37.2 AV	54.0	-16.8	1.08 H	144	-0.10	37.30
ANTENNA POLARITY & TEST DISTANCE: VERTICAL AT 3 M								
NO.	FREQ. (MHz)	EMISSION LEVEL (dBuV/m)	LIMIT (dBuV/m)	MARGIN (dB)	ANTENNA HEIGHT (m)	TABLE ANGLE (Degree)	RAW VALUE (dBuV)	CORRECTION FACTOR (dB/m)
1	*2437.00	108.0 PK			1.12 V	135	76.70	31.30
2	*2437.00	97.6 AV			1.12 V	135	66.30	31.30
3	4874.00	52.2 PK	74.0	-21.8	1.16 V	63	14.90	37.30
4	4874.00	38.0 AV	54.0	-16.0	1.16 V	63	0.70	37.30

- REMARKS:**
1. Emission level (dBuV/m) = Raw Value (dBuV) + Correction Factor (dB/m).
 2. Correction Factor (dB/m) = Antenna Factor (dB/m) + Cable Factor (dB).
 3. The other emission levels were very low against the limit.
 4. Margin value = Emission level – Limit value.
 5. “ * ”: Fundamental frequency.



A D T

EUT TEST CONDITION		MEASUREMENT DETAIL	
CHANNEL	Channel 11	FREQUENCY RANGE	1 ~ 25GHz
INPUT POWER (SYSTEM)	120Vac, 60 Hz	DETECTOR FUNCTION	Peak (PK) Average (AV)
ENVIRONMENTAL CONDITIONS	25deg. C, 65%RH 1008 hPa	TEST MODE	A2
TESTED BY	Match Tsui		

ANTENNA POLARITY & TEST DISTANCE: HORIZONTAL AT 3 M								
NO.	FREQ. (MHz)	EMISSION LEVEL (dBuV/m)	LIMIT (dBuV/m)	MARGIN (dB)	ANTENNA HEIGHT (m)	TABLE ANGLE (Degree)	RAW VALUE (dBuV)	CORRECTION FACTOR (dB/m)
1	*2462.00	101.1 PK			1.06 H	169	69.70	31.40
2	*2462.00	92.0 AV			1.06 H	169	60.60	31.40
3	2483.50	62.4 PK	74.0	-11.6	1.09 H	144	30.90	31.50
4	2483.50	47.2 AV	54.0	-6.8	1.09 H	144	15.70	31.50
5	4924.00	50.8 PK	74.0	-23.2	1.19 H	25	13.40	37.40
6	4924.00	36.4 AV	54.0	-17.6	1.19 H	25	-1.00	37.40
ANTENNA POLARITY & TEST DISTANCE: VERTICAL AT 3 M								
NO.	FREQ. (MHz)	EMISSION LEVEL (dBuV/m)	LIMIT (dBuV/m)	MARGIN (dB)	ANTENNA HEIGHT (m)	TABLE ANGLE (Degree)	RAW VALUE (dBuV)	CORRECTION FACTOR (dB/m)
1	*2462.00	107.4 PK			1.25 V	100	76.00	31.40
2	*2462.00	96.2 AV			1.25 V	100	64.80	31.40
3	2483.50	68.3 PK	74.0	-5.7	1.53 V	101	36.80	31.50
4	2483.50	52.6 AV	54.0	-1.4	1.53 V	101	21.10	31.50
5	4924.00	51.6 PK	74.0	-22.4	1.06 V	175	14.20	37.40
6	4924.00	38.1 AV	54.0	-15.9	1.06 V	175	0.70	37.40

- REMARKS:**
1. Emission level (dBuV/m) = Raw Value (dBuV) + Correction Factor (dB/m).
 2. Correction Factor (dB/m) = Antenna Factor (dB/m) + Cable Factor (dB).
 3. The other emission levels were very low against the limit.
 4. Margin value = Emission level – Limit value.
 5. “ * “: Fundamental frequency.



A D T

802.11n (20MHz): 2TX

EUT TEST CONDITION		MEASUREMENT DETAIL	
CHANNEL	Channel 1	FREQUENCY RANGE	1 ~ 25GHz
INPUT POWER (SYSTEM)	120Vac, 60 Hz	DETECTOR FUNCTION	Peak (PK) Average (AV)
ENVIRONMENTAL CONDITIONS	25deg. C, 65%RH 1008 hPa	TEST MODE	A1
TESTED BY	Antony Lee		

ANTENNA POLARITY & TEST DISTANCE: HORIZONTAL AT 3 M								
NO.	FREQ. (MHz)	EMISSION LEVEL (dBuV/m)	LIMIT (dBuV/m)	MARGIN (dB)	ANTENNA HEIGHT (m)	TABLE ANGLE (Degree)	RAW VALUE (dBuV)	CORRECTION FACTOR (dB/m)
1	2390.00	60.6 PK	74.0	-13.4	1.00 H	184	29.40	31.20
2	2390.00	48.4 AV	54.0	-5.6	1.00 H	184	17.20	31.20
3	*2412.00	101.6 PK			1.00 H	182	70.30	31.30
4	*2412.00	90.2 AV			1.00 H	182	58.90	31.30
5	4824.00	46.4 PK	74.0	-27.6	1.00 H	169	9.20	37.20
6	4824.00	33.0 AV	54.0	-21.0	1.00 H	169	-4.20	37.20
ANTENNA POLARITY & TEST DISTANCE: VERTICAL AT 3 M								
NO.	FREQ. (MHz)	EMISSION LEVEL (dBuV/m)	LIMIT (dBuV/m)	MARGIN (dB)	ANTENNA HEIGHT (m)	TABLE ANGLE (Degree)	RAW VALUE (dBuV)	CORRECTION FACTOR (dB/m)
1	2390.00	67.3 PK	74.0	-6.7	1.36 V	191	36.10	31.20
2	2390.00	53.0 AV	54.0	-1.0	1.36 V	191	21.80	31.20
3	*2412.00	110.5 PK			1.36 V	191	79.20	31.30
4	*2412.00	98.6 AV			1.36 V	191	67.30	31.30
5	4824.00	52.5 PK	74.0	-21.5	1.00 V	246	15.30	37.20
6	4824.00	37.5 AV	54.0	-16.5	1.00 V	246	0.30	37.20

- REMARKS:**
1. Emission level (dBuV/m) = Raw Value (dBuV) + Correction Factor (dB/m).
 2. Correction Factor (dB/m) = Antenna Factor (dB/m) + Cable Factor (dB).
 3. The other emission levels were very low against the limit.
 4. Margin value = Emission level – Limit value.
 5. “ * ”: Fundamental frequency.



A D T

EUT TEST CONDITION		MEASUREMENT DETAIL	
CHANNEL	Channel 6	FREQUENCY RANGE	1 ~ 25GHz
INPUT POWER (SYSTEM)	120Vac, 60 Hz	DETECTOR FUNCTION	Peak (PK) Average (AV)
ENVIRONMENTAL CONDITIONS	25deg. C, 65%RH 1008 hPa	TEST MODE	A1
TESTED BY	Antony Lee		

ANTENNA POLARITY & TEST DISTANCE: HORIZONTAL AT 3 M								
NO.	FREQ. (MHz)	EMISSION LEVEL (dBuV/m)	LIMIT (dBuV/m)	MARGIN (dB)	ANTENNA HEIGHT (m)	TABLE ANGLE (Degree)	RAW VALUE (dBuV)	CORRECTION FACTOR (dB/m)
1	*2437.00	101.9 PK			1.00 H	176	70.60	31.30
2	*2437.00	90.6 AV			1.00 H	176	59.30	31.30
3	4874.00	45.8 PK	74.0	-28.2	1.00 H	172	8.50	37.30
4	4874.00	33.1 AV	54.0	-20.9	1.00 H	172	-4.20	37.30
ANTENNA POLARITY & TEST DISTANCE: VERTICAL AT 3 M								
NO.	FREQ. (MHz)	EMISSION LEVEL (dBuV/m)	LIMIT (dBuV/m)	MARGIN (dB)	ANTENNA HEIGHT (m)	TABLE ANGLE (Degree)	RAW VALUE (dBuV)	CORRECTION FACTOR (dB/m)
1	*2437.00	109.7 PK			1.07 V	194	78.40	31.30
2	*2437.00	98.3 AV			1.07 V	194	67.00	31.30
3	4874.00	51.5 PK	74.0	-22.5	1.00 V	238	14.20	37.30
4	4874.00	37.7 AV	54.0	-16.3	1.00 V	238	0.40	37.30

- REMARKS:**
1. Emission level (dBuV/m) = Raw Value (dBuV) + Correction Factor (dB/m).
 2. Correction Factor (dB/m) = Antenna Factor (dB/m) + Cable Factor (dB).
 3. The other emission levels were very low against the limit.
 4. Margin value = Emission level – Limit value.
 5. “ * “: Fundamental frequency.



A D T

EUT TEST CONDITION		MEASUREMENT DETAIL	
CHANNEL	Channel 11	FREQUENCY RANGE	1 ~ 25GHz
INPUT POWER (SYSTEM)	120Vac, 60 Hz	DETECTOR FUNCTION	Peak (PK) Average (AV)
ENVIRONMENTAL CONDITIONS	25deg. C, 65%RH 1008 hPa	TEST MODE	A1
TESTED BY	Antony Lee		

ANTENNA POLARITY & TEST DISTANCE: HORIZONTAL AT 3 M								
NO.	FREQ. (MHz)	EMISSION LEVEL (dBuV/m)	LIMIT (dBuV/m)	MARGIN (dB)	ANTENNA HEIGHT (m)	TABLE ANGLE (Degree)	RAW VALUE (dBuV)	CORRECTION FACTOR (dB/m)
1	*2462.00	99.8 PK			1.00 H	176	68.40	31.40
2	*2462.00	87.9 AV			1.00 H	176	56.50	31.40
3	2483.50	58.8 PK	74.0	-15.2	1.00 H	179	27.30	31.50
4	2483.50	46.6 AV	54.0	-7.4	1.00 H	179	15.10	31.50
5	4924.00	43.5 PK	74.0	-30.5	1.00 H	16	6.10	37.40
6	4924.00	31.5 AV	54.0	-22.5	1.00 H	16	-5.90	37.40
ANTENNA POLARITY & TEST DISTANCE: VERTICAL AT 3 M								
NO.	FREQ. (MHz)	EMISSION LEVEL (dBuV/m)	LIMIT (dBuV/m)	MARGIN (dB)	ANTENNA HEIGHT (m)	TABLE ANGLE (Degree)	RAW VALUE (dBuV)	CORRECTION FACTOR (dB/m)
1	*2462.00	108.3 PK			1.00 V	190	76.90	31.40
2	*2462.00	96.9 AV			1.00 V	190	65.50	31.40
3	2483.50	66.2 PK	74.0	-7.8	1.00 V	192	34.70	31.50
4	2483.50	52.4 AV	54.0	-1.6	1.00 V	192	20.90	31.50
5	4924.00	46.6 PK	74.0	-27.4	1.00 V	16	9.20	37.40
6	4924.00	33.0 AV	54.0	-21.0	1.00 V	16	-4.40	37.40

- REMARKS:**
1. Emission level (dBuV/m) = Raw Value (dBuV) + Correction Factor (dB/m).
 2. Correction Factor (dB/m) = Antenna Factor (dB/m) + Cable Factor (dB).
 3. The other emission levels were very low against the limit.
 4. Margin value = Emission level – Limit value.
 5. “ * “: Fundamental frequency.



A D T

EUT TEST CONDITION		MEASUREMENT DETAIL	
CHANNEL	Channel 1	FREQUENCY RANGE	1 ~ 25GHz
INPUT POWER (SYSTEM)	120Vac, 60 Hz	DETECTOR FUNCTION	Peak (PK) Average (AV)
ENVIRONMENTAL CONDITIONS	25deg. C, 65%RH 1008 hPa	TEST MODE	A2
TESTED BY	Match Tsui		

ANTENNA POLARITY & TEST DISTANCE: HORIZONTAL AT 3 M								
NO.	FREQ. (MHz)	EMISSION LEVEL (dBuV/m)	LIMIT (dBuV/m)	MARGIN (dB)	ANTENNA HEIGHT (m)	TABLE ANGLE (Degree)	RAW VALUE (dBuV)	CORRECTION FACTOR (dB/m)
1	2390.00	60.3 PK	74.0	-13.7	1.06 H	130	29.10	31.20
2	2390.00	48.1 AV	54.0	-5.9	1.06 H	130	16.90	31.20
3	*2412.00	101.1 PK			1.08 H	123	69.80	31.30
4	*2412.00	89.7 AV			1.08 H	123	58.40	31.30
5	4824.00	47.3 PK	74.0	-26.7	1.09 H	58	10.10	37.20
6	4824.00	34.6 AV	54.0	-19.4	1.09 H	58	-2.60	37.20
ANTENNA POLARITY & TEST DISTANCE: VERTICAL AT 3 M								
NO.	FREQ. (MHz)	EMISSION LEVEL (dBuV/m)	LIMIT (dBuV/m)	MARGIN (dB)	ANTENNA HEIGHT (m)	TABLE ANGLE (Degree)	RAW VALUE (dBuV)	CORRECTION FACTOR (dB/m)
1	2390.00	67.1 PK	74.0	-6.9	1.40 V	153	35.90	31.20
2	2390.00	52.8 AV	54.0	-1.2	1.40 V	153	21.60	31.20
3	*2412.00	110.0 PK			1.05 V	320	78.70	31.30
4	*2412.00	98.2 AV			1.05 V	320	66.90	31.30
5	4824.00	53.9 PK	74.0	-20.1	1.22 V	153	16.70	37.20
6	4824.00	38.8 AV	54.0	-15.2	1.22 V	153	1.60	37.20

- REMARKS:**
1. Emission level (dBuV/m) = Raw Value (dBuV) + Correction Factor (dB/m).
 2. Correction Factor (dB/m) = Antenna Factor (dB/m) + Cable Factor (dB).
 3. The other emission levels were very low against the limit.
 4. Margin value = Emission level – Limit value.
 5. “ * ”: Fundamental frequency.



A D T

EUT TEST CONDITION		MEASUREMENT DETAIL	
CHANNEL	Channel 6	FREQUENCY RANGE	1 ~ 25GHz
INPUT POWER (SYSTEM)	120Vac, 60 Hz	DETECTOR FUNCTION	Peak (PK) Average (AV)
ENVIRONMENTAL CONDITIONS	25deg. C, 65%RH 1008 hPa	TEST MODE	A2
TESTED BY	Match Tsui		

ANTENNA POLARITY & TEST DISTANCE: HORIZONTAL AT 3 M								
NO.	FREQ. (MHz)	EMISSION LEVEL (dBuV/m)	LIMIT (dBuV/m)	MARGIN (dB)	ANTENNA HEIGHT (m)	TABLE ANGLE (Degree)	RAW VALUE (dBuV)	CORRECTION FACTOR (dB/m)
1	*2437.00	101.5 PK			1.07 H	186	70.20	31.30
2	*2437.00	90.2 AV			1.07 H	186	58.90	31.30
3	4874.00	47.0 PK	74.0	-27.0	1.12 H	69	9.70	37.30
4	4874.00	34.1 AV	54.0	-19.9	1.12 H	69	-3.20	37.30
ANTENNA POLARITY & TEST DISTANCE: VERTICAL AT 3 M								
NO.	FREQ. (MHz)	EMISSION LEVEL (dBuV/m)	LIMIT (dBuV/m)	MARGIN (dB)	ANTENNA HEIGHT (m)	TABLE ANGLE (Degree)	RAW VALUE (dBuV)	CORRECTION FACTOR (dB/m)
1	*2437.00	109.4 PK			1.05 V	221	78.10	31.30
2	*2437.00	98.0 AV			1.05 V	221	66.70	31.30
3	4874.00	53.6 PK	74.0	-20.4	1.05 V	331	16.30	37.30
4	4874.00	38.4 AV	54.0	-15.6	1.05 V	331	1.10	37.30

- REMARKS:**
1. Emission level (dBuV/m) = Raw Value (dBuV) + Correction Factor (dB/m).
 2. Correction Factor (dB/m) = Antenna Factor (dB/m) + Cable Factor (dB).
 3. The other emission levels were very low against the limit.
 4. Margin value = Emission level – Limit value.
 5. “ * “: Fundamental frequency.



A D T

EUT TEST CONDITION		MEASUREMENT DETAIL	
CHANNEL	Channel 11	FREQUENCY RANGE	1 ~ 25GHz
INPUT POWER (SYSTEM)	120Vac, 60 Hz	DETECTOR FUNCTION	Peak (PK) Average (AV)
ENVIRONMENTAL CONDITIONS	25deg. C, 65%RH 1008 hPa	TEST MODE	A2
TESTED BY	Match Tsui		

ANTENNA POLARITY & TEST DISTANCE: HORIZONTAL AT 3 M								
NO.	FREQ. (MHz)	EMISSION LEVEL (dBuV/m)	LIMIT (dBuV/m)	MARGIN (dB)	ANTENNA HEIGHT (m)	TABLE ANGLE (Degree)	RAW VALUE (dBuV)	CORRECTION FACTOR (dB/m)
1	*2462.00	99.3 PK			1.03 H	155	67.90	31.40
2	*2462.00	87.3 AV			1.03 H	155	55.90	31.40
3	2483.50	60.2 PK	74.0	-13.8	1.20 H	152	28.70	31.50
4	2483.50	46.9 AV	54.0	-7.1	1.20 H	152	15.40	31.50
5	4824.00	47.9 PK	74.0	-26.1	1.12 H	69	10.70	37.20
6	4824.00	35.2 AV	54.0	-18.8	1.12 H	69	-2.00	37.20
ANTENNA POLARITY & TEST DISTANCE: VERTICAL AT 3 M								
NO.	FREQ. (MHz)	EMISSION LEVEL (dBuV/m)	LIMIT (dBuV/m)	MARGIN (dB)	ANTENNA HEIGHT (m)	TABLE ANGLE (Degree)	RAW VALUE (dBuV)	CORRECTION FACTOR (dB/m)
1	*2462.00	108.0 PK			1.12 V	130	76.60	31.40
2	*2462.00	96.5 AV			1.12 V	130	65.10	31.40
3	2483.50	66.8 PK	74.0	-7.2	1.09 V	142	35.30	31.50
4	2483.50	52.7 AV	54.0	-1.3	1.09 V	142	21.20	31.50
5	4924.00	53.4 PK	74.0	-20.6	1.06 V	152	16.00	37.40
6	4924.00	38.2 AV	54.0	-15.8	1.06 V	152	0.80	37.40

- REMARKS:**
1. Emission level (dBuV/m) = Raw Value (dBuV) + Correction Factor (dB/m).
 2. Correction Factor (dB/m) = Antenna Factor (dB/m) + Cable Factor (dB).
 3. The other emission levels were very low against the limit.
 4. Margin value = Emission level – Limit value.
 5. “ * “: Fundamental frequency.



A D T

802.11n (40MHz): 1TX

EUT TEST CONDITION		MEASUREMENT DETAIL	
CHANNEL	Channel 1	FREQUENCY RANGE	1 ~ 25GHz
INPUT POWER (SYSTEM)	120Vac, 60 Hz	DETECTOR FUNCTION	Peak (PK) Average (AV)
ENVIRONMENTAL CONDITIONS	25deg. C, 65%RH 1008 hPa	TEST MODE	A1
TESTED BY	Antony Lee		

ANTENNA POLARITY & TEST DISTANCE: HORIZONTAL AT 3 M								
NO.	FREQ. (MHz)	EMISSION LEVEL (dBuV/m)	LIMIT (dBuV/m)	MARGIN (dB)	ANTENNA HEIGHT (m)	TABLE ANGLE (Degree)	RAW VALUE (dBuV)	CORRECTION FACTOR (dB/m)
1	2390.00	59.7 PK	74.0	-14.3	1.00 H	233	28.50	31.20
2	2390.00	47.8 AV	54.0	-6.2	1.00 H	233	16.60	31.20
3	*2422.00	93.9 PK			1.00 H	235	62.60	31.30
4	*2422.00	83.4 AV			1.00 H	235	52.10	31.30
5	4844.00	43.0 PK	74.0	-31.0	1.00 H	116	5.70	37.30
6	4844.00	31.1 AV	54.0	-22.9	1.00 H	116	-6.20	37.30
ANTENNA POLARITY & TEST DISTANCE: VERTICAL AT 3 M								
NO.	FREQ. (MHz)	EMISSION LEVEL (dBuV/m)	LIMIT (dBuV/m)	MARGIN (dB)	ANTENNA HEIGHT (m)	TABLE ANGLE (Degree)	RAW VALUE (dBuV)	CORRECTION FACTOR (dB/m)
1	2390.00	65.9 PK	74.0	-8.1	1.00 V	26	34.70	31.20
2	2390.00	53.0 AV	54.0	-1.0	1.00 V	26	21.80	31.20
3	*2422.00	102.0 PK			1.22 V	18	70.70	31.30
4	*2422.00	91.6 AV			1.22 V	18	60.30	31.30
5	4844.00	43.9 PK	74.0	-30.1	1.00 V	158	6.60	37.30
6	4844.00	31.5 AV	54.0	-22.5	1.00 V	158	-5.80	37.30

- REMARKS:**
1. Emission level (dBuV/m) = Raw Value (dBuV) + Correction Factor (dB/m).
 2. Correction Factor (dB/m) = Antenna Factor (dB/m) + Cable Factor (dB).
 3. The other emission levels were very low against the limit.
 4. Margin value = Emission level – Limit value.
 5. “ * “: Fundamental frequency.



A D T

EUT TEST CONDITION		MEASUREMENT DETAIL	
CHANNEL	Channel 4	FREQUENCY RANGE	1 ~ 25GHz
INPUT POWER (SYSTEM)	120Vac, 60 Hz	DETECTOR FUNCTION	Peak (PK) Average (AV)
ENVIRONMENTAL CONDITIONS	25deg. C, 65%RH 1008 hPa	TEST MODE	A1
TESTED BY	Antony Lee		

ANTENNA POLARITY & TEST DISTANCE: HORIZONTAL AT 3 M								
NO.	FREQ. (MHz)	EMISSION LEVEL (dBuV/m)	LIMIT (dBuV/m)	MARGIN (dB)	ANTENNA HEIGHT (m)	TABLE ANGLE (Degree)	RAW VALUE (dBuV)	CORRECTION FACTOR (dB/m)
1	*2437.00	93.2 PK			1.00 H	235	61.90	31.30
2	*2437.00	83.1 AV			1.00 H	235	51.80	31.30
3	4874.00	43.2 PK	74.0	-30.8	1.00 H	112	5.90	37.30
4	4874.00	31.4 AV	54.0	-22.6	1.00 H	112	-5.90	37.30
ANTENNA POLARITY & TEST DISTANCE: VERTICAL AT 3 M								
NO.	FREQ. (MHz)	EMISSION LEVEL (dBuV/m)	LIMIT (dBuV/m)	MARGIN (dB)	ANTENNA HEIGHT (m)	TABLE ANGLE (Degree)	RAW VALUE (dBuV)	CORRECTION FACTOR (dB/m)
1	*2437.00	101.7 PK			1.00 V	28	70.40	31.30
2	*2437.00	90.8 AV			1.00 V	28	59.50	31.30
3	4874.00	44.6 PK	74.0	-29.4	1.00 V	153	7.30	37.30
4	4874.00	32.5 AV	54.0	-21.5	1.00 V	153	-4.80	37.30

- REMARKS:**
1. Emission level (dBuV/m) = Raw Value (dBuV) + Correction Factor (dB/m).
 2. Correction Factor (dB/m) = Antenna Factor (dB/m) + Cable Factor (dB).
 3. The other emission levels were very low against the limit.
 4. Margin value = Emission level – Limit value.
 5. “ * “: Fundamental frequency.



A D T

EUT TEST CONDITION		MEASUREMENT DETAIL	
CHANNEL	Channel 7	FREQUENCY RANGE	1 ~ 25GHz
INPUT POWER (SYSTEM)	120Vac, 60 Hz	DETECTOR FUNCTION	Peak (PK) Average (AV)
ENVIRONMENTAL CONDITIONS	25deg. C, 65%RH 1008 hPa	TEST MODE	A1
TESTED BY	Antony Lee		

ANTENNA POLARITY & TEST DISTANCE: HORIZONTAL AT 3 M								
NO.	FREQ. (MHz)	EMISSION LEVEL (dBuV/m)	LIMIT (dBuV/m)	MARGIN (dB)	ANTENNA HEIGHT (m)	TABLE ANGLE (Degree)	RAW VALUE (dBuV)	CORRECTION FACTOR (dB/m)
1	*2452.00	92.7 PK			1.00 H	141	61.30	31.40
2	*2452.00	82.7 AV			1.00 H	141	51.30	31.40
3	2483.50	64.4 PK	74.0	-9.6	1.00 H	141	32.90	31.50
4	2483.50	48.1 AV	54.0	-5.9	1.00 H	141	16.60	31.50
5	4904.00	41.7 PK	74.0	-32.3	1.00 H	150	4.30	37.40
6	4904.00	30.0 AV	54.0	-24.0	1.00 H	150	-7.40	37.40
ANTENNA POLARITY & TEST DISTANCE: VERTICAL AT 3 M								
NO.	FREQ. (MHz)	EMISSION LEVEL (dBuV/m)	LIMIT (dBuV/m)	MARGIN (dB)	ANTENNA HEIGHT (m)	TABLE ANGLE (Degree)	RAW VALUE (dBuV)	CORRECTION FACTOR (dB/m)
1	*2452.00	101.1 PK			1.22 V	18	69.70	31.40
2	*2452.00	90.2 AV			1.22 V	18	58.80	31.40
3	2483.50	68.4 PK	74.0	-5.6	1.22 V	20	36.90	31.50
4	2483.50	52.6 AV	54.0	-1.4	1.22 V	20	21.10	31.50
5	4904.00	44.2 PK	74.0	-29.8	1.00 V	163	6.80	37.40
6	4904.00	31.7 AV	54.0	-22.3	1.00 V	163	-5.70	37.40

- REMARKS:**
1. Emission level (dBuV/m) = Raw Value (dBuV) + Correction Factor (dB/m).
 2. Correction Factor (dB/m) = Antenna Factor (dB/m) + Cable Factor (dB).
 3. The other emission levels were very low against the limit.
 4. Margin value = Emission level – Limit value.
 5. “ * “: Fundamental frequency.



A D T

EUT TEST CONDITION		MEASUREMENT DETAIL	
CHANNEL	Channel 1	FREQUENCY RANGE	1 ~ 25GHz
INPUT POWER (SYSTEM)	120Vac, 60 Hz	DETECTOR FUNCTION	Peak (PK) Average (AV)
ENVIRONMENTAL CONDITIONS	25deg. C, 65%RH 1008 hPa	TEST MODE	A2
TESTED BY	Match Tsui		

ANTENNA POLARITY & TEST DISTANCE: HORIZONTAL AT 3 M								
NO.	FREQ. (MHz)	EMISSION LEVEL (dBuV/m)	LIMIT (dBuV/m)	MARGIN (dB)	ANTENNA HEIGHT (m)	TABLE ANGLE (Degree)	RAW VALUE (dBuV)	CORRECTION FACTOR (dB/m)
1	2390.00	59.5 PK	74.0	-14.5	1.22 H	139	28.30	31.20
2	2390.00	47.3 AV	54.0	-6.7	1.22 H	139	16.10	31.20
3	*2422.00	95.4 PK			1.06 H	193	64.10	31.30
4	*2422.00	85.1 AV			1.06 H	193	53.80	31.30
5	4844.00	46.0 PK	74.0	-28.0	1.20 H	163	8.70	37.30
6	4844.00	33.2 AV	54.0	-20.8	1.20 H	163	-4.10	37.30
ANTENNA POLARITY & TEST DISTANCE: VERTICAL AT 3 M								
NO.	FREQ. (MHz)	EMISSION LEVEL (dBuV/m)	LIMIT (dBuV/m)	MARGIN (dB)	ANTENNA HEIGHT (m)	TABLE ANGLE (Degree)	RAW VALUE (dBuV)	CORRECTION FACTOR (dB/m)
1	2390.00	65.7 PK	74.0	-8.3	1.03 V	52	34.50	31.20
2	2390.00	52.8 AV	54.0	-1.2	1.03 V	52	21.60	31.20
3	*2422.00	103.7 PK			1.29 V	83	72.40	31.30
4	*2422.00	93.2 AV			1.29 V	83	61.90	31.30
5	4844.00	46.3 PK	74.0	-27.7	1.22 V	36	9.00	37.30
6	4844.00	33.9 AV	54.0	-20.1	1.22 V	36	-3.40	37.30

- REMARKS:**
1. Emission level (dBuV/m) = Raw Value (dBuV) + Correction Factor (dB/m).
 2. Correction Factor (dB/m) = Antenna Factor (dB/m) + Cable Factor (dB).
 3. The other emission levels were very low against the limit.
 4. Margin value = Emission level – Limit value.
 5. “ * “: Fundamental frequency.



A D T

EUT TEST CONDITION		MEASUREMENT DETAIL	
CHANNEL	Channel 4	FREQUENCY RANGE	1 ~ 25GHz
INPUT POWER (SYSTEM)	120Vac, 60 Hz	DETECTOR FUNCTION	Peak (PK) Average (AV)
ENVIRONMENTAL CONDITIONS	25deg. C, 65%RH 1008 hPa	TEST MODE	A2
TESTED BY	Match Tsui		

ANTENNA POLARITY & TEST DISTANCE: HORIZONTAL AT 3 M								
NO.	FREQ. (MHz)	EMISSION LEVEL (dBuV/m)	LIMIT (dBuV/m)	MARGIN (dB)	ANTENNA HEIGHT (m)	TABLE ANGLE (Degree)	RAW VALUE (dBuV)	CORRECTION FACTOR (dB/m)
1	*2437.00	94.8 PK			1.15 H	153	63.50	31.30
2	*2437.00	84.6 AV			1.15 H	153	53.30	31.30
3	4874.00	45.5 PK	74.0	-28.5	1.22 H	63	8.20	37.30
4	4874.00	32.7 AV	54.0	-21.3	1.22 H	63	-4.60	37.30
ANTENNA POLARITY & TEST DISTANCE: VERTICAL AT 3 M								
NO.	FREQ. (MHz)	EMISSION LEVEL (dBuV/m)	LIMIT (dBuV/m)	MARGIN (dB)	ANTENNA HEIGHT (m)	TABLE ANGLE (Degree)	RAW VALUE (dBuV)	CORRECTION FACTOR (dB/m)
1	*2437.00	103.4 PK			1.03 V	52	72.10	31.30
2	*2437.00	92.4 AV			1.03 V	52	61.10	31.30
3	4874.00	45.9 PK	74.0	-28.1	1.22 V	253	8.60	37.30
4	4874.00	33.4 AV	54.0	-20.6	1.22 V	253	-3.90	37.30

- REMARKS:**
1. Emission level (dBuV/m) = Raw Value (dBuV) + Correction Factor (dB/m).
 2. Correction Factor (dB/m) = Antenna Factor (dB/m) + Cable Factor (dB).
 3. The other emission levels were very low against the limit.
 4. Margin value = Emission level – Limit value.
 5. “ * ”: Fundamental frequency.



A D T

EUT TEST CONDITION		MEASUREMENT DETAIL	
CHANNEL	Channel 7	FREQUENCY RANGE	1 ~ 25GHz
INPUT POWER (SYSTEM)	120Vac, 60 Hz	DETECTOR FUNCTION	Peak (PK) Average (AV)
ENVIRONMENTAL CONDITIONS	25deg. C, 65%RH 1008 hPa	TEST MODE	A2
TESTED BY	Match Tsui		

ANTENNA POLARITY & TEST DISTANCE: HORIZONTAL AT 3 M								
NO.	FREQ. (MHz)	EMISSION LEVEL (dBuV/m)	LIMIT (dBuV/m)	MARGIN (dB)	ANTENNA HEIGHT (m)	TABLE ANGLE (Degree)	RAW VALUE (dBuV)	CORRECTION FACTOR (dB/m)
1	*2452.00	94.3 PK			1.06 H	210	62.90	31.40
2	*2452.00	84.2 AV			1.06 H	210	52.80	31.40
3	2483.50	64.1 PK	74.0	-9.9	1.05 H	155	32.60	31.50
4	2483.50	47.6 AV	54.0	-6.4	1.05 H	155	16.10	31.50
5	4904.00	45.2 PK	74.0	-28.8	1.12 H	299	7.80	37.40
6	4904.00	32.5 AV	54.0	-21.5	1.12 H	299	-4.90	37.40
ANTENNA POLARITY & TEST DISTANCE: VERTICAL AT 3 M								
NO.	FREQ. (MHz)	EMISSION LEVEL (dBuV/m)	LIMIT (dBuV/m)	MARGIN (dB)	ANTENNA HEIGHT (m)	TABLE ANGLE (Degree)	RAW VALUE (dBuV)	CORRECTION FACTOR (dB/m)
1	*2452.00	102.6 PK			1.16 V	91	71.20	31.40
2	*2452.00	91.7 AV			1.16 V	91	60.30	31.40
3	2483.50	68.1 PK	74.0	-5.9	1.06 V	63	36.60	31.50
4	2483.50	52.5 AV	54.0	-1.5	1.06 V	63	21.00	31.50
5	4904.00	45.6 PK	74.0	-28.4	1.08 V	302	8.20	37.40
6	4904.00	33.1 AV	54.0	-20.9	1.08 V	302	-4.30	37.40

- REMARKS:**
1. Emission level (dBuV/m) = Raw Value (dBuV) + Correction Factor (dB/m).
 2. Correction Factor (dB/m) = Antenna Factor (dB/m) + Cable Factor (dB).
 3. The other emission levels were very low against the limit.
 4. Margin value = Emission level – Limit value.
 5. “ * ”: Fundamental frequency.



A D T

802.11n (40MHz): 2TX

EUT TEST CONDITION		MEASUREMENT DETAIL	
CHANNEL	Channel 1	FREQUENCY RANGE	1 ~ 25GHz
INPUT POWER (SYSTEM)	120Vac, 60 Hz	DETECTOR FUNCTION	Peak (PK) Average (AV)
ENVIRONMENTAL CONDITIONS	25deg. C, 65%RH 1008 hPa	TEST MODE	A1
TESTED BY	Antony Lee		

ANTENNA POLARITY & TEST DISTANCE: HORIZONTAL AT 3 M								
NO.	FREQ. (MHz)	EMISSION LEVEL (dBuV/m)	LIMIT (dBuV/m)	MARGIN (dB)	ANTENNA HEIGHT (m)	TABLE ANGLE (Degree)	RAW VALUE (dBuV)	CORRECTION FACTOR (dB/m)
1	2390.00	58.4 PK	74.0	-15.6	1.00 H	179	27.20	31.20
2	2390.00	47.9 AV	54.0	-6.1	1.00 H	179	16.70	31.20
3	*2422.00	97.0 PK			1.00 H	180	65.70	31.30
4	*2422.00	86.3 AV			1.00 H	180	55.00	31.30
5	4844.00	42.8 PK	74.0	-31.2	1.00 H	203	5.50	37.30
6	4844.00	31.3 AV	54.0	-22.7	1.00 H	203	-6.00	37.30
ANTENNA POLARITY & TEST DISTANCE: VERTICAL AT 3 M								
NO.	FREQ. (MHz)	EMISSION LEVEL (dBuV/m)	LIMIT (dBuV/m)	MARGIN (dB)	ANTENNA HEIGHT (m)	TABLE ANGLE (Degree)	RAW VALUE (dBuV)	CORRECTION FACTOR (dB/m)
1	2390.00	65.2 PK	74.0	-8.8	1.00 V	12	34.00	31.20
2	2390.00	52.8 AV	54.0	-1.2	1.00 V	12	21.60	31.20
3	*2422.00	105.5 PK			1.26 V	192	74.20	31.30
4	*2422.00	94.9 AV			1.26 V	192	63.60	31.30
5	4844.00	45.7 PK	74.0	-28.3	1.00 V	161	8.40	37.30
6	4844.00	33.9 AV	54.0	-20.1	1.00 V	161	-3.40	37.30

- REMARKS:**
1. Emission level (dBuV/m) = Raw Value (dBuV) + Correction Factor (dB/m).
 2. Correction Factor (dB/m) = Antenna Factor (dB/m) + Cable Factor (dB).
 3. The other emission levels were very low against the limit.
 4. Margin value = Emission level – Limit value.
 5. “ * “: Fundamental frequency.



A D T

EUT TEST CONDITION		MEASUREMENT DETAIL	
CHANNEL	Channel 4	FREQUENCY RANGE	1 ~ 25GHz
INPUT POWER (SYSTEM)	120Vac, 60 Hz	DETECTOR FUNCTION	Peak (PK) Average (AV)
ENVIRONMENTAL CONDITIONS	25deg. C, 65%RH 1008 hPa	TEST MODE	A1
TESTED BY	Antony Lee		

ANTENNA POLARITY & TEST DISTANCE: HORIZONTAL AT 3 M								
NO.	FREQ. (MHz)	EMISSION LEVEL (dBuV/m)	LIMIT (dBuV/m)	MARGIN (dB)	ANTENNA HEIGHT (m)	TABLE ANGLE (Degree)	RAW VALUE (dBuV)	CORRECTION FACTOR (dB/m)
1	*2437.00	97.4 PK			1.00 H	181	66.10	31.30
2	*2437.00	86.8 AV			1.00 H	181	55.50	31.30
3	4874.00	42.6 PK	74.0	-31.4	1.00 H	205	5.30	37.30
4	4874.00	30.9 AV	54.0	-23.1	1.00 H	205	-6.40	37.30
ANTENNA POLARITY & TEST DISTANCE: VERTICAL AT 3 M								
NO.	FREQ. (MHz)	EMISSION LEVEL (dBuV/m)	LIMIT (dBuV/m)	MARGIN (dB)	ANTENNA HEIGHT (m)	TABLE ANGLE (Degree)	RAW VALUE (dBuV)	CORRECTION FACTOR (dB/m)
1	*2437.00	105.7 PK			1.00 V	198	74.40	31.30
2	*2437.00	94.3 AV			1.00 V	198	63.00	31.30
3	4874.00	45.9 PK	74.0	-28.1	1.00 V	158	8.60	37.30
4	4874.00	33.6 AV	54.0	-20.4	1.00 V	158	-3.70	37.30

- REMARKS:**
1. Emission level (dBuV/m) = Raw Value (dBuV) + Correction Factor (dB/m).
 2. Correction Factor (dB/m) = Antenna Factor (dB/m) + Cable Factor (dB).
 3. The other emission levels were very low against the limit.
 4. Margin value = Emission level – Limit value.
 5. “ * “: Fundamental frequency.



A D T

EUT TEST CONDITION		MEASUREMENT DETAIL	
CHANNEL	Channel 7	FREQUENCY RANGE	1 ~ 25GHz
INPUT POWER (SYSTEM)	120Vac, 60 Hz	DETECTOR FUNCTION	Peak (PK) Average (AV)
ENVIRONMENTAL CONDITIONS	25deg. C, 65%RH 1008 hPa	TEST MODE	A1
TESTED BY	Antony Lee		

ANTENNA POLARITY & TEST DISTANCE: HORIZONTAL AT 3 M								
NO.	FREQ. (MHz)	EMISSION LEVEL (dBuV/m)	LIMIT (dBuV/m)	MARGIN (dB)	ANTENNA HEIGHT (m)	TABLE ANGLE (Degree)	RAW VALUE (dBuV)	CORRECTION FACTOR (dB/m)
1	*2452.00	96.6 PK			1.00 H	178	65.20	31.40
2	*2452.00	86.2 AV			1.00 H	178	54.80	31.40
3	2483.50	61.9 PK	74.0	-12.1	1.00 H	181	30.40	31.50
4	2483.50	48.8 AV	54.0	-5.2	1.00 H	181	17.30	31.50
5	4904.00	42.9 PK	74.0	-31.1	1.00 H	26	5.50	37.40
6	4904.00	30.4 AV	54.0	-23.6	1.00 H	26	-7.00	37.40
ANTENNA POLARITY & TEST DISTANCE: VERTICAL AT 3 M								
NO.	FREQ. (MHz)	EMISSION LEVEL (dBuV/m)	LIMIT (dBuV/m)	MARGIN (dB)	ANTENNA HEIGHT (m)	TABLE ANGLE (Degree)	RAW VALUE (dBuV)	CORRECTION FACTOR (dB/m)
1	*2452.00	104.8 PK			1.00 V	201	73.40	31.40
2	*2452.00	93.9 AV			1.00 V	201	62.50	31.40
3	2483.50	67.7 PK	74.0	-6.3	1.00 V	190	36.20	31.50
4	2483.50	53.0 AV	54.0	-1.0	1.00 V	190	21.50	31.50
5	4904.00	45.6 PK	74.0	-28.4	1.00 V	23	8.20	37.40
6	4904.00	32.2 AV	54.0	-21.8	1.00 V	23	-5.20	37.40

- REMARKS:**
1. Emission level (dBuV/m) = Raw Value (dBuV) + Correction Factor (dB/m).
 2. Correction Factor (dB/m) = Antenna Factor (dB/m) + Cable Factor (dB).
 3. The other emission levels were very low against the limit.
 4. Margin value = Emission level – Limit value.
 5. “ * “: Fundamental frequency.



A D T

EUT TEST CONDITION		MEASUREMENT DETAIL	
CHANNEL	Channel 1	FREQUENCY RANGE	1 ~ 25GHz
INPUT POWER (SYSTEM)	120Vac, 60 Hz	DETECTOR FUNCTION	Peak (PK) Average (AV)
ENVIRONMENTAL CONDITIONS	25deg. C, 65%RH 1008 hPa	TEST MODE	A2
TESTED BY	Match Tsui		

ANTENNA POLARITY & TEST DISTANCE: HORIZONTAL AT 3 M								
NO.	FREQ. (MHz)	EMISSION LEVEL (dBuV/m)	LIMIT (dBuV/m)	MARGIN (dB)	ANTENNA HEIGHT (m)	TABLE ANGLE (Degree)	RAW VALUE (dBuV)	CORRECTION FACTOR (dB/m)
1	2390.00	58.6 PK	74.0	-15.4	1.03 H	188	27.40	31.20
2	2390.00	48.3 AV	54.0	-5.7	1.03 H	188	17.10	31.20
3	*2422.00	97.7 PK			1.02 H	129	66.40	31.30
4	*2422.00	87.0 AV			1.02 H	129	55.70	31.30
5	4844.00	43.5 PK	74.0	-30.5	1.03 H	210	6.20	37.30
6	4844.00	32.1 AV	54.0	-21.9	1.03 H	210	-5.20	37.30
ANTENNA POLARITY & TEST DISTANCE: VERTICAL AT 3 M								
NO.	FREQ. (MHz)	EMISSION LEVEL (dBuV/m)	LIMIT (dBuV/m)	MARGIN (dB)	ANTENNA HEIGHT (m)	TABLE ANGLE (Degree)	RAW VALUE (dBuV)	CORRECTION FACTOR (dB/m)
1	2390.00	65.0 PK	74.0	-9.0	1.02 V	67	33.80	31.20
2	2390.00	52.6 AV	54.0	-1.4	1.02 V	67	21.40	31.20
3	*2422.00	106.2 PK			1.33 V	199	74.90	31.30
4	*2422.00	95.5 AV			1.33 V	199	64.20	31.30
5	4844.00	47.2 PK	74.0	-26.8	1.13 V	152	9.90	37.30
6	4844.00	35.1 AV	54.0	-18.9	1.13 V	152	-2.20	37.30

- REMARKS:**
1. Emission level (dBuV/m) = Raw Value (dBuV) + Correction Factor (dB/m).
 2. Correction Factor (dB/m) = Antenna Factor (dB/m) + Cable Factor (dB).
 3. The other emission levels were very low against the limit.
 4. Margin value = Emission level – Limit value.
 5. “ * ”: Fundamental frequency.



A D T

EUT TEST CONDITION		MEASUREMENT DETAIL	
CHANNEL	Channel 4	FREQUENCY RANGE	1 ~ 25GHz
INPUT POWER (SYSTEM)	120Vac, 60 Hz	DETECTOR FUNCTION	Peak (PK) Average (AV)
ENVIRONMENTAL CONDITIONS	25deg. C, 65%RH 1008 hPa	TEST MODE	A2
TESTED BY	Match Tsui		

ANTENNA POLARITY & TEST DISTANCE: HORIZONTAL AT 3 M								
NO.	FREQ. (MHz)	EMISSION LEVEL (dBuV/m)	LIMIT (dBuV/m)	MARGIN (dB)	ANTENNA HEIGHT (m)	TABLE ANGLE (Degree)	RAW VALUE (dBuV)	CORRECTION FACTOR (dB/m)
1	*2437.00	98.2 PK			1.06 H	201	66.90	31.30
2	*2437.00	87.4 AV			1.06 H	201	56.10	31.30
3	4874.00	43.8 PK	74.0	-30.2	1.02 H	211	6.50	37.30
4	4874.00	32.3 AV	54.0	-21.7	1.02 H	211	-5.00	37.30
ANTENNA POLARITY & TEST DISTANCE: VERTICAL AT 3 M								
NO.	FREQ. (MHz)	EMISSION LEVEL (dBuV/m)	LIMIT (dBuV/m)	MARGIN (dB)	ANTENNA HEIGHT (m)	TABLE ANGLE (Degree)	RAW VALUE (dBuV)	CORRECTION FACTOR (dB/m)
1	*2437.00	106.4 PK			1.02 V	144	75.10	31.30
2	*2437.00	95.0 AV			1.02 V	144	63.70	31.30
3	4874.00	47.5 PK	74.0	-26.5	1.12 V	293	10.20	37.30
4	4874.00	35.3 AV	54.0	-18.7	1.12 V	293	-2.00	37.30

- REMARKS:**
1. Emission level (dBuV/m) = Raw Value (dBuV) + Correction Factor (dB/m).
 2. Correction Factor (dB/m) = Antenna Factor (dB/m) + Cable Factor (dB).
 3. The other emission levels were very low against the limit.
 4. Margin value = Emission level – Limit value.
 5. “ * “: Fundamental frequency.



A D T

EUT TEST CONDITION		MEASUREMENT DETAIL	
CHANNEL	Channel 7	FREQUENCY RANGE	1 ~ 25GHz
INPUT POWER (SYSTEM)	120Vac, 60 Hz	DETECTOR FUNCTION	Peak (PK) Average (AV)
ENVIRONMENTAL CONDITIONS	25deg. C, 65%RH 1008 hPa	TEST MODE	A2
TESTED BY	Match Tsui		

ANTENNA POLARITY & TEST DISTANCE: HORIZONTAL AT 3 M								
NO.	FREQ. (MHz)	EMISSION LEVEL (dBuV/m)	LIMIT (dBuV/m)	MARGIN (dB)	ANTENNA HEIGHT (m)	TABLE ANGLE (Degree)	RAW VALUE (dBuV)	CORRECTION FACTOR (dB/m)
1	*2452.00	96.3 PK			1.02 H	131	64.90	31.40
2	*2452.00	86.0 AV			1.02 H	131	54.60	31.40
3	2483.50	61.5 PK	74.0	-12.5	1.06 H	122	30.00	31.50
4	2483.50	48.4 AV	54.0	-5.6	1.06 H	122	16.90	31.50
5	4904.00	43.5 PK	74.0	-30.5	1.12 H	200	6.10	37.40
6	4904.00	32.0 AV	54.0	-22.0	1.12 H	200	-5.40	37.40
ANTENNA POLARITY & TEST DISTANCE: VERTICAL AT 3 M								
NO.	FREQ. (MHz)	EMISSION LEVEL (dBuV/m)	LIMIT (dBuV/m)	MARGIN (dB)	ANTENNA HEIGHT (m)	TABLE ANGLE (Degree)	RAW VALUE (dBuV)	CORRECTION FACTOR (dB/m)
1	*2452.00	105.4 PK			1.05 V	120	74.00	31.40
2	*2452.00	94.6 AV			1.05 V	120	63.20	31.40
3	2483.50	67.4 PK	74.0	-6.6	1.06 V	155	35.90	31.50
4	2483.50	52.5 AV	54.0	-1.5	1.06 V	155	21.00	31.50
5	4904.00	47.8 PK	74.0	-26.2	1.22 V	36	10.40	37.40
6	4904.00	35.6 AV	54.0	-18.4	1.22 V	36	-1.80	37.40

- REMARKS:**
1. Emission level (dBuV/m) = Raw Value (dBuV) + Correction Factor (dB/m).
 2. Correction Factor (dB/m) = Antenna Factor (dB/m) + Cable Factor (dB).
 3. The other emission levels were very low against the limit.
 4. Margin value = Emission level – Limit value.
 5. “ * “: Fundamental frequency.



A D T

BELOW 1GHz WORST-CASE DATA : 802.11n (20MHz): 2TX

EUT TEST CONDITION		MEASUREMENT DETAIL	
CHANNEL	Channel 6	FREQUENCY RANGE	Below 1000MHz
INPUT POWER (SYSTEM)	120Vac, 60 Hz	DETECTOR FUNCTION	Quasi-Peak
ENVIRONMENTAL CONDITIONS	25deg. C, 65%RH 1008 hPa	TEST MODE	A1
TESTED BY	Antony Lee		

ANTENNA POLARITY & TEST DISTANCE: HORIZONTAL AT 3 M								
NO.	FREQ. (MHz)	EMISSION LEVEL (dBuV/m)	LIMIT (dBuV/m)	MARGIN (dB)	ANTENNA HEIGHT (m)	TABLE ANGLE (Degree)	RAW VALUE (dBuV)	CORRECTION FACTOR (dB/m)
1	148.50	36.1 QP	43.5	-7.4	2.25 H	106	22.40	13.70
2	249.60	33.6 QP	46.0	-12.4	1.75 H	82	20.70	12.90
3	305.99	32.9 QP	46.0	-13.1	1.25 H	295	19.00	13.90
4	500.42	39.5 QP	46.0	-6.5	1.00 H	316	20.20	19.30
5	698.74	31.7 QP	46.0	-14.3	1.50 H	235	8.90	22.80
6	799.84	34.4 QP	46.0	-11.6	1.00 H	283	9.00	25.40
ANTENNA POLARITY & TEST DISTANCE: VERTICAL AT 3 M								
NO.	FREQ. (MHz)	EMISSION LEVEL (dBuV/m)	LIMIT (dBuV/m)	MARGIN (dB)	ANTENNA HEIGHT (m)	TABLE ANGLE (Degree)	RAW VALUE (dBuV)	CORRECTION FACTOR (dB/m)
1	43.51	35.1 QP	40.0	-4.9	1.25 V	223	22.60	12.50
2	99.89	34.0 QP	43.5	-9.5	1.50 V	253	24.60	9.40
3	249.60	35.0 QP	46.0	-11.0	1.00 V	52	22.10	12.90
4	319.60	33.9 QP	46.0	-12.1	1.50 V	178	19.70	14.20
5	500.42	39.2 QP	46.0	-6.8	1.00 V	298	19.90	19.30
6	764.84	32.3 QP	46.0	-13.7	1.25 V	199	7.90	24.40

- REMARKS:**
1. Emission level (dBuV/m) = Raw Value (dBuV) + Correction Factor (dB/m).
 2. Correction Factor (dB/m) = Antenna Factor (dB/m) + Cable Factor (dB).
 3. The other emission levels were very low against the limit.
 4. Margin value = Emission level – Limit value.



A D T

EUT TEST CONDITION		MEASUREMENT DETAIL	
CHANNEL	Channel 6	FREQUENCY RANGE	Below 1000MHz
INPUT POWER (SYSTEM)	120Vac, 60 Hz	DETECTOR FUNCTION	Quasi-Peak
ENVIRONMENTAL CONDITIONS	25deg. C, 65%RH 1008 hPa	TEST MODE	B1
TESTED BY	Antony Lee		

ANTENNA POLARITY & TEST DISTANCE: HORIZONTAL AT 3 M								
NO.	FREQ. (MHz)	EMISSION LEVEL (dBuV/m)	LIMIT (dBuV/m)	MARGIN (dB)	ANTENNA HEIGHT (m)	TABLE ANGLE (Degree)	RAW VALUE (dBuV)	CORRECTION FACTOR (dB/m)
1	113.50	28.3 QP	43.5	-15.2	1.50 H	73	17.30	11.00
2	146.56	32.6 QP	43.5	-10.9	2.00 H	112	19.10	13.50
3	360.43	32.3 QP	46.0	-13.7	1.00 H	340	17.20	15.10
4	500.42	40.1 QP	46.0	-5.9	1.75 H	238	20.80	19.30
5	698.74	30.4 QP	46.0	-15.6	1.25 H	253	7.60	22.80
6	836.78	35.2 QP	46.0	-10.8	1.00 H	223	9.60	25.60

ANTENNA POLARITY & TEST DISTANCE: VERTICAL AT 3 M								
NO.	FREQ. (MHz)	EMISSION LEVEL (dBuV/m)	LIMIT (dBuV/m)	MARGIN (dB)	ANTENNA HEIGHT (m)	TABLE ANGLE (Degree)	RAW VALUE (dBuV)	CORRECTION FACTOR (dB/m)
1	43.51	34.8 QP	40.0	-5.2	1.00 V	25	22.30	12.50
2	101.84	35.9 QP	43.5	-7.6	1.00 V	316	26.30	9.60
3	319.60	30.7 QP	46.0	-15.3	1.75 V	151	16.50	14.20
4	535.42	34.2 QP	46.0	-11.8	1.25 V	343	13.80	20.40
5	799.84	37.1 QP	46.0	-8.9	1.25 V	193	11.70	25.40
6	916.50	32.2 QP	46.0	-13.8	1.25 V	31	5.90	26.30

- REMARKS:**
1. Emission level (dBuV/m) = Raw Value (dBuV) + Correction Factor (dB/m).
 2. Correction Factor (dB/m) = Antenna Factor (dB/m) + Cable Factor (dB).
 3. The other emission levels were very low against the limit.
 4. Margin value = Emission level – Limit value.



A D T

EUT TEST CONDITION		MEASUREMENT DETAIL	
CHANNEL	Channel 6	FREQUENCY RANGE	Below 1000MHz
INPUT POWER (SYSTEM)	120Vac, 60 Hz	DETECTOR FUNCTION	Quasi-Peak
ENVIRONMENTAL CONDITIONS	25deg. C, 65%RH 1008 hPa	TEST MODE	C1
TESTED BY	Antony Lee		

ANTENNA POLARITY & TEST DISTANCE: HORIZONTAL AT 3 M								
NO.	FREQ. (MHz)	EMISSION LEVEL (dBuV/m)	LIMIT (dBuV/m)	MARGIN (dB)	ANTENNA HEIGHT (m)	TABLE ANGLE (Degree)	RAW VALUE (dBuV)	CORRECTION FACTOR (dB/m)
1	160.17	31.0 QP	43.5	-12.5	1.25 H	304	17.30	13.70
2	356.54	33.2 QP	46.0	-12.8	1.00 H	115	18.10	15.10
3	424.59	35.2 QP	46.0	-10.8	2.25 H	157	18.30	16.90
4	500.42	38.1 QP	46.0	-7.9	1.50 H	202	18.80	19.30
5	799.84	33.3 QP	46.0	-12.7	1.00 H	244	7.90	25.40
6	916.50	36.3 QP	46.0	-9.7	1.50 H	199	10.00	26.30
ANTENNA POLARITY & TEST DISTANCE: VERTICAL AT 3 M								
NO.	FREQ. (MHz)	EMISSION LEVEL (dBuV/m)	LIMIT (dBuV/m)	MARGIN (dB)	ANTENNA HEIGHT (m)	TABLE ANGLE (Degree)	RAW VALUE (dBuV)	CORRECTION FACTOR (dB/m)
1	31.84	36.0 QP	40.0	-4.0	1.00 V	175	23.70	12.30
2	156.28	35.6 QP	43.5	-7.9	1.50 V	10	21.80	13.80
3	249.60	34.0 QP	46.0	-12.0	1.00 V	67	21.10	12.90
4	510.14	37.6 QP	46.0	-8.4	1.00 V	19	18.00	19.60
5	799.84	34.8 QP	46.0	-11.2	1.75 V	178	9.40	25.40
6	897.05	35.9 QP	46.0	-10.1	2.25 V	130	9.80	26.10

- REMARKS:**
1. Emission level (dBuV/m) = Raw Value (dBuV) + Correction Factor (dB/m).
 2. Correction Factor (dB/m) = Antenna Factor (dB/m) + Cable Factor (dB).
 3. The other emission levels were very low against the limit.
 4. Margin value = Emission level – Limit value.



A D T

EUT TEST CONDITION		MEASUREMENT DETAIL	
CHANNEL	Channel 6	FREQUENCY RANGE	Below 1000MHz
INPUT POWER (SYSTEM)	120Vac, 60 Hz	DETECTOR FUNCTION	Quasi-Peak
ENVIRONMENTAL CONDITIONS	25deg. C, 65%RH 1008 hPa	TEST MODE	A2
TESTED BY	Match Tsui		

ANTENNA POLARITY & TEST DISTANCE: HORIZONTAL AT 3 M								
NO.	FREQ. (MHz)	EMISSION LEVEL (dBuV/m)	LIMIT (dBuV/m)	MARGIN (dB)	ANTENNA HEIGHT (m)	TABLE ANGLE (Degree)	RAW VALUE (dBuV)	CORRECTION FACTOR (dB/m)
1	156.28	33.5 QP	43.5	-10.0	1.25 H	94	19.70	13.80
2	175.72	30.2 QP	43.5	-13.3	1.50 H	277	17.60	12.60
3	245.72	31.2 QP	46.0	-14.8	1.00 H	277	18.50	12.70
4	307.93	35.2 QP	46.0	-10.8	1.00 H	199	21.30	13.90
5	469.31	32.0 QP	46.0	-14.0	2.00 H	145	13.60	18.40
6	782.34	35.3 QP	46.0	-10.7	1.25 H	166	10.40	24.90
ANTENNA POLARITY & TEST DISTANCE: VERTICAL AT 3 M								
NO.	FREQ. (MHz)	EMISSION LEVEL (dBuV/m)	LIMIT (dBuV/m)	MARGIN (dB)	ANTENNA HEIGHT (m)	TABLE ANGLE (Degree)	RAW VALUE (dBuV)	CORRECTION FACTOR (dB/m)
1	55.18	36.0 QP	40.0	-4.0	1.25 V	343	22.40	13.60
2	64.90	29.4 QP	40.0	-10.6	1.25 V	22	16.90	12.50
3	107.67	33.8 QP	43.5	-9.7	1.25 V	268	23.50	10.30
4	311.82	33.3 QP	46.0	-12.7	1.50 V	337	19.30	14.00
5	469.31	33.3 QP	46.0	-12.7	1.00 V	205	14.90	18.40
6	521.81	35.2 QP	46.0	-10.8	2.00 V	160	15.20	20.00
7	782.34	35.8 QP	46.0	-10.2	1.25 V	202	10.90	24.90

- REMARKS:**
1. Emission level (dBuV/m) = Raw Value (dBuV) + Correction Factor (dB/m).
 2. Correction Factor (dB/m) = Antenna Factor (dB/m) + Cable Factor (dB).
 3. The other emission levels were very low against the limit.
 4. Margin value = Emission level – Limit value.



A D T

EUT TEST CONDITION		MEASUREMENT DETAIL	
CHANNEL	Channel 6	FREQUENCY RANGE	Below 1000MHz
INPUT POWER (SYSTEM)	120Vac, 60 Hz	DETECTOR FUNCTION	Quasi-Peak
ENVIRONMENTAL CONDITIONS	25deg. C, 65%RH 1008 hPa	TEST MODE	B2
TESTED BY	Match Tsui		

ANTENNA POLARITY & TEST DISTANCE: HORIZONTAL AT 3 M								
NO.	FREQ. (MHz)	EMISSION LEVEL (dBuV/m)	LIMIT (dBuV/m)	MARGIN (dB)	ANTENNA HEIGHT (m)	TABLE ANGLE (Degree)	RAW VALUE (dBuV)	CORRECTION FACTOR (dB/m)
1	103.78	33.9 QP	43.5	-9.6	2.00 H	157	23.30	10.60
2	156.28	34.7 QP	43.5	-8.8	2.00 H	280	20.20	14.50
3	311.82	38.1 QP	46.0	-7.9	1.00 H	100	23.10	15.00
4	469.31	35.3 QP	46.0	-10.7	2.00 H	235	16.20	19.10
5	624.85	34.4 QP	46.0	-11.6	1.50 H	349	11.90	22.50
6	782.34	36.5 QP	46.0	-9.5	1.00 H	184	12.00	24.50
ANTENNA POLARITY & TEST DISTANCE: VERTICAL AT 3 M								
NO.	FREQ. (MHz)	EMISSION LEVEL (dBuV/m)	LIMIT (dBuV/m)	MARGIN (dB)	ANTENNA HEIGHT (m)	TABLE ANGLE (Degree)	RAW VALUE (dBuV)	CORRECTION FACTOR (dB/m)
1	43.51	35.6 QP	40.0	-4.4	1.00 V	26	21.10	14.50
2	101.84	35.1 QP	43.5	-8.4	1.00 V	178	24.80	10.30
3	156.28	36.1 QP	43.5	-7.4	1.50 V	133	21.60	14.50
4	311.82	36.4 QP	46.0	-9.6	1.75 V	202	21.40	15.00
5	519.86	35.8 QP	46.0	-10.2	2.00 V	235	15.40	20.40
6	782.34	35.3 QP	46.0	-10.7	1.25 V	196	10.80	24.50

- REMARKS:**
1. Emission level (dBuV/m) = Raw Value (dBuV) + Correction Factor (dB/m).
 2. Correction Factor (dB/m) = Antenna Factor (dB/m) + Cable Factor (dB).
 3. The other emission levels were very low against the limit.
 4. Margin value = Emission level – Limit value.



A D T

EUT TEST CONDITION		MEASUREMENT DETAIL	
CHANNEL	Channel 6	FREQUENCY RANGE	Below 1000MHz
INPUT POWER (SYSTEM)	120Vac, 60 Hz	DETECTOR FUNCTION	Quasi-Peak
ENVIRONMENTAL CONDITIONS	25deg. C, 65%RH 1008 hPa	TEST MODE	C2
TESTED BY	Match Tsui		

ANTENNA POLARITY & TEST DISTANCE: HORIZONTAL AT 3 M								
NO.	FREQ. (MHz)	EMISSION LEVEL (dBuV/m)	LIMIT (dBuV/m)	MARGIN (dB)	ANTENNA HEIGHT (m)	TABLE ANGLE (Degree)	RAW VALUE (dBuV)	CORRECTION FACTOR (dB/m)
1	156.28	36.1 QP	43.5	-7.4	1.50 H	256	22.30	13.80
2	253.49	32.7 QP	46.0	-13.3	1.25 H	265	19.80	12.90
3	311.82	34.9 QP	46.0	-11.1	1.00 H	145	20.90	14.00
4	469.31	34.9 QP	46.0	-11.1	2.00 H	214	16.50	18.40
5	624.85	31.5 QP	46.0	-14.5	1.50 H	349	9.30	22.20
6	782.34	36.1 QP	46.0	-9.9	1.25 H	184	11.20	24.90
ANTENNA POLARITY & TEST DISTANCE: VERTICAL AT 3 M								
NO.	FREQ. (MHz)	EMISSION LEVEL (dBuV/m)	LIMIT (dBuV/m)	MARGIN (dB)	ANTENNA HEIGHT (m)	TABLE ANGLE (Degree)	RAW VALUE (dBuV)	CORRECTION FACTOR (dB/m)
1	55.18	35.8 QP	40.0	-4.2	1.00 V	1	22.20	13.60
2	62.95	29.3 QP	40.0	-10.7	1.00 V	22	16.40	12.90
3	101.84	32.7 QP	43.5	-10.8	1.00 V	268	23.10	9.60
4	311.82	33.8 QP	46.0	-12.2	2.00 V	181	19.80	14.00
5	469.31	35.3 QP	46.0	-10.7	1.00 V	196	16.90	18.40
6	521.81	39.6 QP	46.0	-6.4	1.00 V	10	19.60	20.00
7	782.34	35.6 QP	46.0	-10.4	1.25 V	199	10.70	24.90

- REMARKS:**
1. Emission level (dBuV/m) = Raw Value (dBuV) + Correction Factor (dB/m).
 2. Correction Factor (dB/m) = Antenna Factor (dB/m) + Cable Factor (dB).
 3. The other emission levels were very low against the limit.
 4. Margin value = Emission level – Limit value.



4.2 CONDUCTED EMISSION MEASUREMENT

4.2.1 LIMITS OF CONDUCTED EMISSION MEASUREMENT

FREQUENCY OF EMISSION (MHz)	CONDUCTED LIMIT (dBµV)	
	Quasi-peak	Average
0.15 ~ 0.5	66 to 56	56 to 46
0.5 ~ 5	56	46
5 ~ 30	60	50

- NOTE:** 1. The lower limit shall apply at the transition frequencies.
 2. The limit decreases in line with the logarithm of the frequency in the range of 0.15 to 0.50MHz.
 3. All emanations from a class A/B digital device or system, including any network of conductors and apparatus connected thereto, shall not exceed the level of field strengths specified above.

4.2.2 TEST INSTRUMENTS

DESCRIPTION & MANUFACTURER	MODEL NO.	SERIAL NO.	DATE OF CALIBRATION	DUE DATE OF CALIBRATION
Test Receiver ROHDE & SCHWARZ	ESCS30	100291	Nov. 30, 2010	Nov. 29, 2011
RF signal cable Woken	5D-FB	Cable-HYC01-01	Dec. 30, 2009	Dec. 29, 2010
LISN ROHDE & SCHWARZ	ESH3-Z5	100312	Jun. 28, 2010	Jun. 27, 2011
LISN ROHDE & SCHWARZ	ESH3-Z5	835239/001	Feb. 10, 2010	Feb. 09, 2011
V-LISN SCHWARZBECK	NNBL 8226-2	8226-142	Jul. 12, 2010	Jul. 11, 2011
Software ADT	ADT_Cond_ V7.3.7	NA	NA	NA

- NOTE:** 1. The calibration interval of the above test instruments is 12 months and the calibrations are traceable to NML/ROC and NIST/USA.
 2. The test was performed in HwaYa Shielded Room 1.
 3. The VCCI Site Registration No. is C-2040.



A D T

4.2.3 TEST PROCEDURES

- a. The EUT was placed 0.4 meters from the conducting wall of the shielded room with EUT being connected to the power mains through a line impedance stabilization network (LISN). Other support units were connected to the power mains through another LISN. The two LISNs provide 50 ohm/ 50uH of coupling impedance for the measuring instrument.
- b. Both lines of the power mains connected to the EUT were checked for maximum conducted interference.
- c. The frequency range from 150kHz to 30MHz was searched. Emission levels under (Limit - 20dB) was not recorded.

NOTE: All modes of operation were investigated and the worst-case emissions are reported.

4.2.4 DEVIATION FROM TEST STANDARD

No deviation.

4.2.5 TEST SETUP

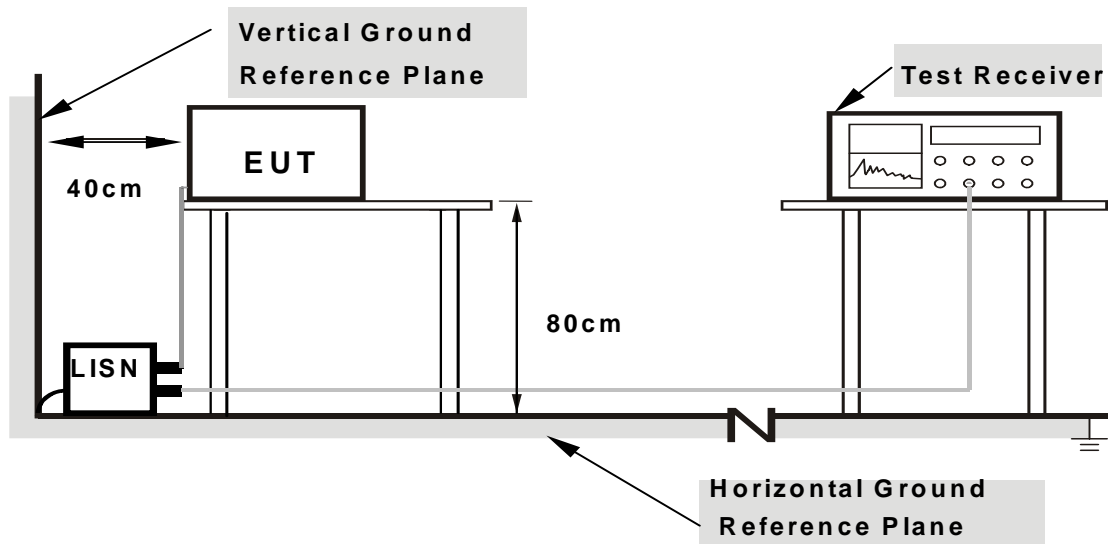

- Note:**
1. Support units were connected to second LISN.
 2. Both of LISNs (AMN) are 80 cm from EUT and at least 80 from other units and other metal planes

For the actual test configuration, please refer to the attached file (Test Setup Photo).

4.2.6 EUT OPERATING CONDITIONS

Same as 4.1.6.

4.2.7 TEST RESULTS

CONDUCTED WORST-CASE DATA : 802.11n (20MHz): 2TX

PHASE	Line 1	6dB BANDWIDTH	9kHz
TEST MODE	A1		

No	Freq. [MHz]	Corr. Factor (dB)	Reading Value		Emission Level		Limit		Margin	
			[dB (uV)]		[dB (uV)]		[dB (uV)]		(dB)	
			Q.P.	AV.	Q.P.	AV.	Q.P.	AV.	Q.P.	AV.
1	0.162	0.12	36.56	-	36.68	-	65.38	55.38	-28.70	-
2	0.349	0.12	24.85	-	24.97	-	58.98	48.98	-34.01	-
3	0.431	0.13	19.54	-	19.67	-	57.23	47.23	-37.56	-
4	1.406	0.21	14.95	-	15.16	-	56.00	46.00	-40.84	-
5	4.117	0.36	6.31	-	6.67	-	56.00	46.00	-49.33	-
6	18.242	1.34	35.39	-	36.73	-	60.00	50.00	-23.27	-

- REMARKS:**
1. Q.P. and AV. are abbreviations of quasi-peak and average individually.
 2. "-": The Quasi-peak reading value also meets average limit and measurement with the average detector is unnecessary.
 3. The emission levels of other frequencies were very low against the limit.
 4. Margin value = Emission level - Limit value
 5. Correction factor = Insertion loss + Cable loss
 6. Emission Level = Correction Factor + Reading Value.

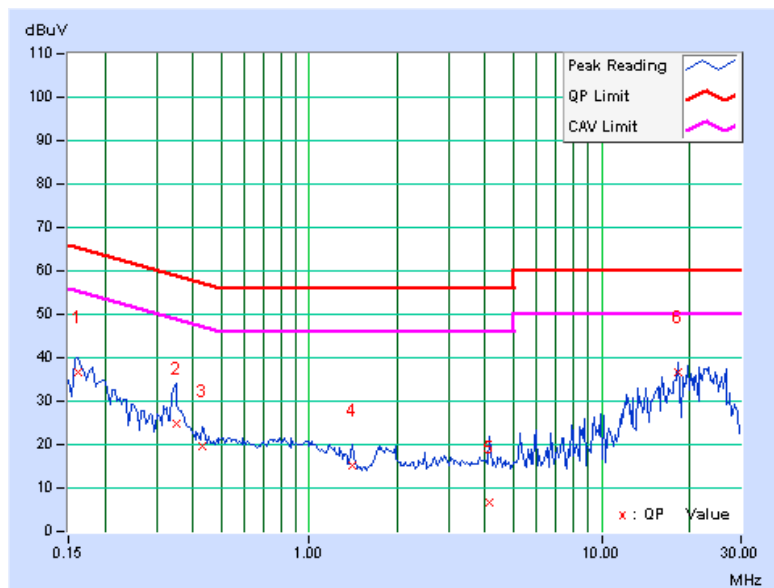



A D T

PHASE	Line 2	6dB BANDWIDTH	9kHz
TEST MODE	A1		

No	Freq. [MHz]	Corr. Factor (dB)	Reading Value		Emission Level		Limit		Margin	
			[dB (uV)]		[dB (uV)]		[dB (uV)]		(dB)	
			Q.P.	AV.	Q.P.	AV.	Q.P.	AV.	Q.P.	AV.
1	0.158	0.10	36.97	-	37.07	-	65.58	55.58	-28.51	-
2	0.341	0.11	32.48	-	32.59	-	59.17	49.17	-26.57	-
3	0.740	0.15	17.25	-	17.40	-	56.00	46.00	-38.60	-
4	1.734	0.22	16.12	-	16.34	-	56.00	46.00	-39.66	-
5	7.922	0.48	19.35	-	19.83	-	60.00	50.00	-40.17	-
6	23.129	1.47	35.58	-	37.05	-	60.00	50.00	-22.95	-

- REMARKS:**
1. Q.P. and AV. are abbreviations of quasi-peak and average individually.
 2. "-": The Quasi-peak reading value also meets average limit and measurement with the average detector is unnecessary.
 3. The emission levels of other frequencies were very low against the limit.
 4. Margin value = Emission level - Limit value
 5. Correction factor = Insertion loss + Cable loss
 6. Emission Level = Correction Factor + Reading Value.

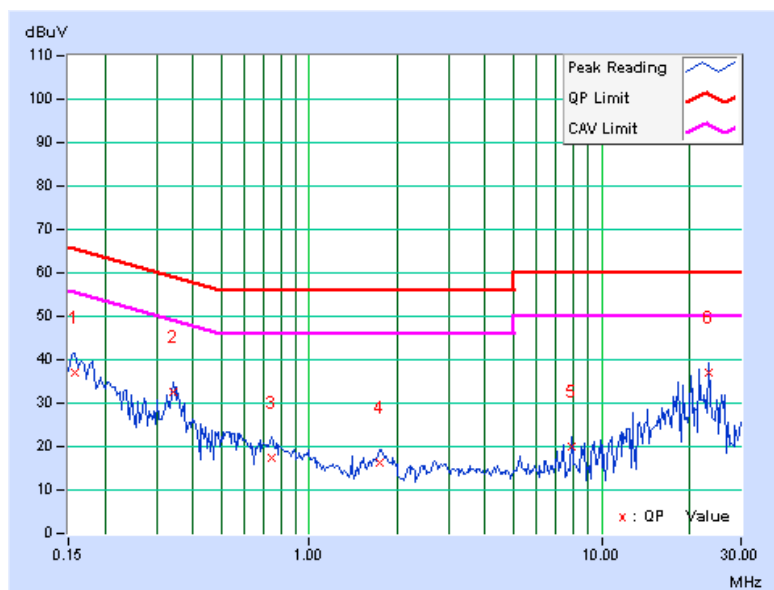



A D T

PHASE	Line 1	6dB BANDWIDTH	9kHz
TEST MODE	B1		

No	Freq. [MHz]	Corr. Factor (dB)	Reading Value		Emission Level		Limit		Margin	
			[dB (uV)]		[dB (uV)]		[dB (uV)]		(dB)	
			Q.P.	AV.	Q.P.	AV.	Q.P.	AV.	Q.P.	AV.
1	0.181	0.11	38.49	-	38.60	-	64.43	54.43	-25.82	-
2	0.498	0.14	36.18	-	36.32	-	56.04	46.04	-19.72	-
3	0.599	0.15	34.59	-	34.74	-	56.00	46.00	-21.26	-
4	2.289	0.26	37.40	-	37.66	-	56.00	46.00	-18.34	-
5	3.672	0.33	37.10	-	37.43	-	56.00	46.00	-18.57	-
6	10.926	0.72	44.80	-	45.52	-	60.00	50.00	-14.48	-

- REMARKS:**
1. Q.P. and AV. are abbreviations of quasi-peak and average individually.
 2. "-": The Quasi-peak reading value also meets average limit and measurement with the average detector is unnecessary.
 3. The emission levels of other frequencies were very low against the limit.
 4. Margin value = Emission level - Limit value
 5. Correction factor = Insertion loss + Cable loss
 6. Emission Level = Correction Factor + Reading Value.

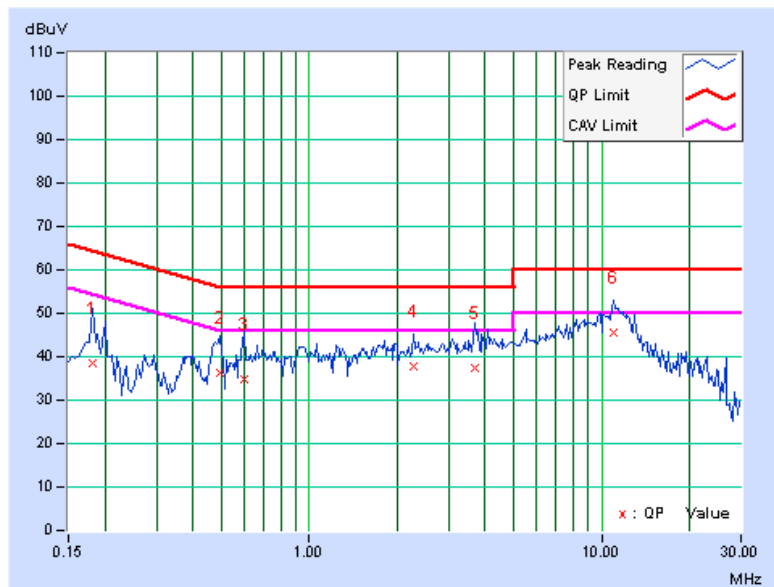



A D T

PHASE	Line 2	6dB BANDWIDTH	9kHz
TEST MODE	B1		

No	Freq. [MHz]	Corr. Factor (dB)	Reading Value		Emission Level		Limit		Margin	
			[dB (uV)]		[dB (uV)]		[dB (uV)]		(dB)	
			Q.P.	AV.	Q.P.	AV.	Q.P.	AV.	Q.P.	AV.
1	0.193	0.10	40.26	-	40.36	-	63.91	53.91	-23.55	-
2	0.298	0.11	32.26	-	32.37	-	60.29	50.29	-27.92	-
3	0.396	0.12	32.83	-	32.95	-	57.93	47.93	-24.99	-
4	1.113	0.18	31.96	-	32.14	-	56.00	46.00	-23.86	-
5	3.605	0.30	33.33	-	33.63	-	56.00	46.00	-22.37	-
6	10.797	0.62	42.99	-	43.61	-	60.00	50.00	-16.39	-

- REMARKS:**
1. Q.P. and AV. are abbreviations of quasi-peak and average individually.
 2. "-": The Quasi-peak reading value also meets average limit and measurement with the average detector is unnecessary.
 3. The emission levels of other frequencies were very low against the limit.
 4. Margin value = Emission level - Limit value
 5. Correction factor = Insertion loss + Cable loss
 6. Emission Level = Correction Factor + Reading Value.

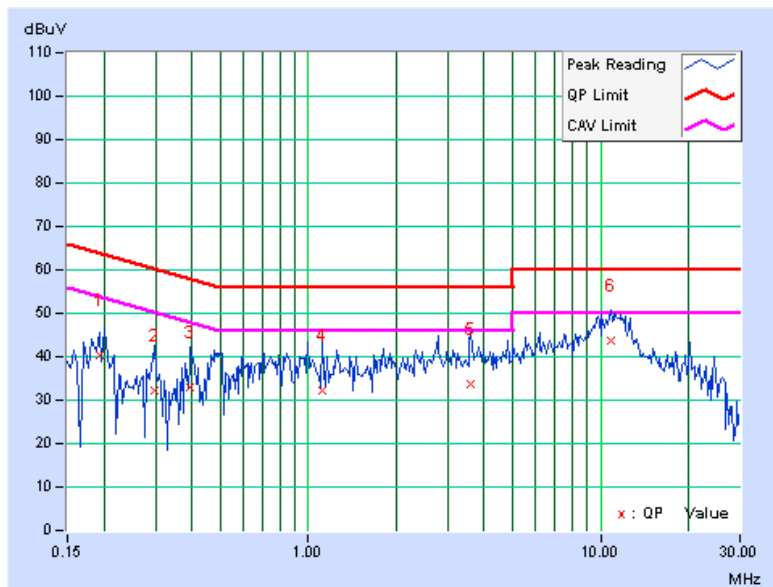



A D T

PHASE	Line 1	6dB BANDWIDTH	9kHz
TEST MODE	C1		

No	Freq. [MHz]	Corr. Factor (dB)	Reading Value		Emission Level		Limit		Margin	
			[dB (uV)]		[dB (uV)]		[dB (uV)]		(dB)	
			Q.P.	AV.	Q.P.	AV.	Q.P.	AV.	Q.P.	AV.
1	0.170	0.12	33.19	-	33.31	-	64.98	54.98	-31.68	-
2	0.420	0.13	36.46	-	36.59	-	57.46	47.46	-20.87	-
3	0.990	0.18	28.54	-	28.72	-	56.00	46.00	-27.28	-
4	3.313	0.32	28.24	-	28.56	-	56.00	46.00	-27.44	-
5	9.867	0.63	29.80	-	30.43	-	60.00	50.00	-29.57	-
6	13.422	0.92	36.39	-	37.31	-	60.00	50.00	-22.69	-

- REMARKS:**
1. Q.P. and AV. are abbreviations of quasi-peak and average individually.
 2. "-": The Quasi-peak reading value also meets average limit and measurement with the average detector is unnecessary.
 3. The emission levels of other frequencies were very low against the limit.
 4. Margin value = Emission level - Limit value
 5. Correction factor = Insertion loss + Cable loss
 6. Emission Level = Correction Factor + Reading Value.

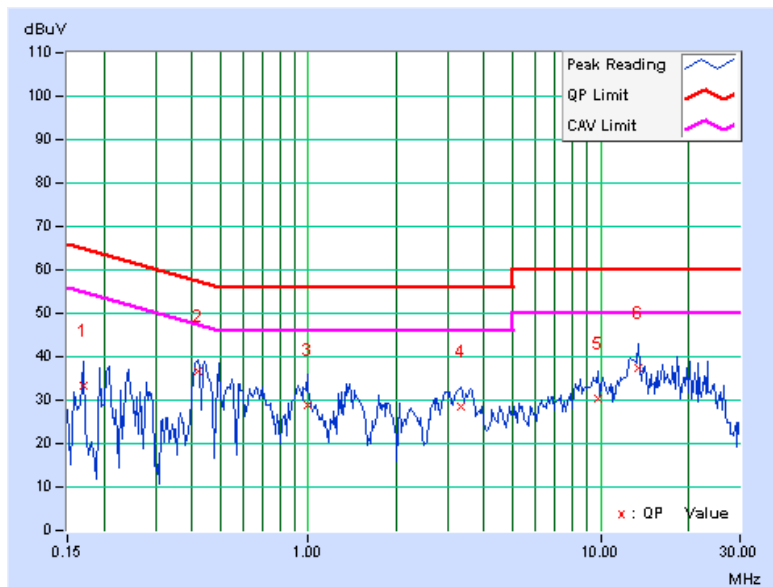



A D T

PHASE	Line 2	6dB BANDWIDTH	9kHz
TEST MODE	C1		

No	Freq.	Corr.	Reading Value		Emission Level		Limit		Margin	
	[MHz]	Factor	[dB (uV)]		[dB (uV)]		[dB (uV)]		(dB)	
		(dB)	Q.P.	AV.	Q.P.	AV.	Q.P.	AV.	Q.P.	AV.
1	0.170	0.10	34.60	-	34.70	-	64.98	54.98	-30.28	-
2	0.244	0.10	34.74	-	34.84	-	61.97	51.97	-27.12	-
3	0.439	0.12	31.33	-	31.45	-	57.08	47.08	-25.63	-
4	3.496	0.30	25.50	-	25.80	-	56.00	46.00	-30.20	-
5	9.957	0.56	30.48	-	31.04	-	60.00	50.00	-28.96	-
6	13.203	0.79	28.51	-	29.30	-	60.00	50.00	-30.70	-

- REMARKS:**
1. Q.P. and AV. are abbreviations of quasi-peak and average individually.
 2. "-": The Quasi-peak reading value also meets average limit and measurement with the average detector is unnecessary.
 3. The emission levels of other frequencies were very low against the limit.
 4. Margin value = Emission level - Limit value
 5. Correction factor = Insertion loss + Cable loss
 6. Emission Level = Correction Factor + Reading Value.

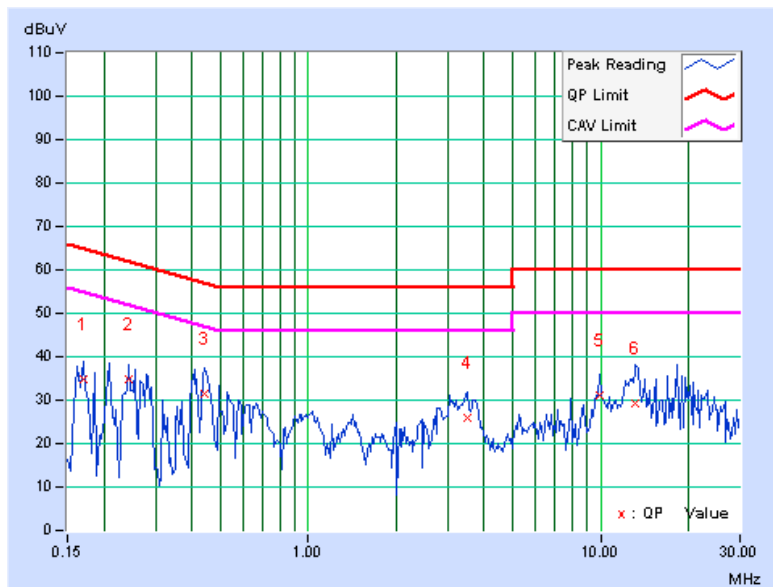



A D T

PHASE	Line 1	6dB BANDWIDTH	9kHz
TEST MODE	A2		

No	Freq. [MHz]	Corr. Factor (dB)	Reading Value		Emission Level		Limit		Margin	
			[dB (uV)]		[dB (uV)]		[dB (uV)]		(dB)	
			Q.P.	AV.	Q.P.	AV.	Q.P.	AV.	Q.P.	AV.
1	0.236	0.11	34.11	-	34.22	-	62.24	52.24	-28.01	-
2	0.349	0.12	31.13	-	31.25	-	58.98	48.98	-27.73	-
3	0.478	0.14	22.14	-	22.28	-	56.37	46.37	-34.09	-
4	0.603	0.15	17.54	-	17.69	-	56.00	46.00	-38.31	-
5	13.418	0.92	27.68	-	28.60	-	60.00	50.00	-31.40	-
6	16.230	1.16	27.67	-	28.83	-	60.00	50.00	-31.17	-

- REMARKS:**
1. Q.P. and AV. are abbreviations of quasi-peak and average individually.
 2. "-": The Quasi-peak reading value also meets average limit and measurement with the average detector is unnecessary.
 3. The emission levels of other frequencies were very low against the limit.
 4. Margin value = Emission level - Limit value
 5. Correction factor = Insertion loss + Cable loss
 6. Emission Level = Correction Factor + Reading Value.

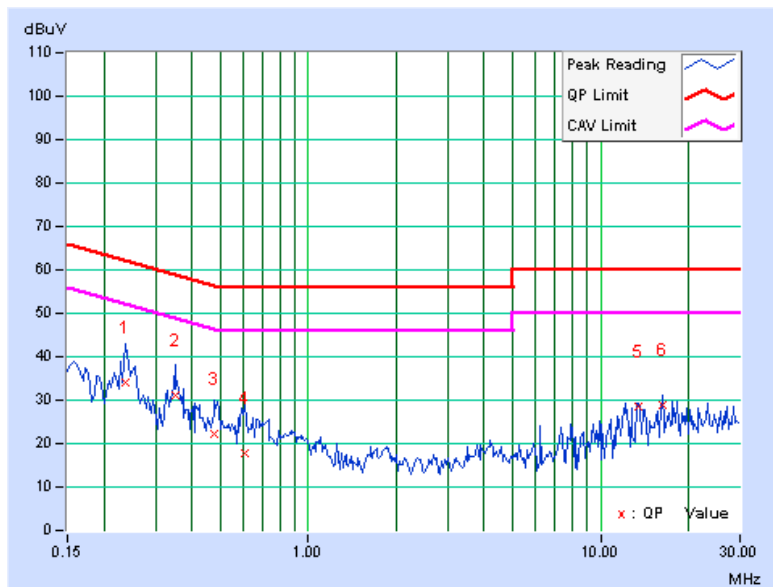



A D T

PHASE	Line 2	6dB BANDWIDTH	9kHz
TEST MODE	A2		

No	Freq. [MHz]	Corr. Factor (dB)	Reading Value		Emission Level		Limit		Margin	
			[dB (uV)]		[dB (uV)]		[dB (uV)]		(dB)	
			Q.P.	AV.	Q.P.	AV.	Q.P.	AV.	Q.P.	AV.
1	0.236	0.10	30.82	-	30.92	-	62.24	52.24	-31.31	-
2	0.349	0.11	34.04	-	34.15	-	58.98	48.98	-24.83	-
3	0.474	0.13	19.27	-	19.40	-	56.44	46.44	-37.04	-
4	12.746	0.76	23.16	-	23.92	-	60.00	50.00	-36.08	-
5	18.242	1.17	26.51	-	27.68	-	60.00	50.00	-32.32	-
6	23.129	1.47	25.64	-	27.11	-	60.00	50.00	-32.89	-

- REMARKS:**
1. Q.P. and AV. are abbreviations of quasi-peak and average individually.
 2. "-": The Quasi-peak reading value also meets average limit and measurement with the average detector is unnecessary.
 3. The emission levels of other frequencies were very low against the limit.
 4. Margin value = Emission level - Limit value
 5. Correction factor = Insertion loss + Cable loss
 6. Emission Level = Correction Factor + Reading Value.

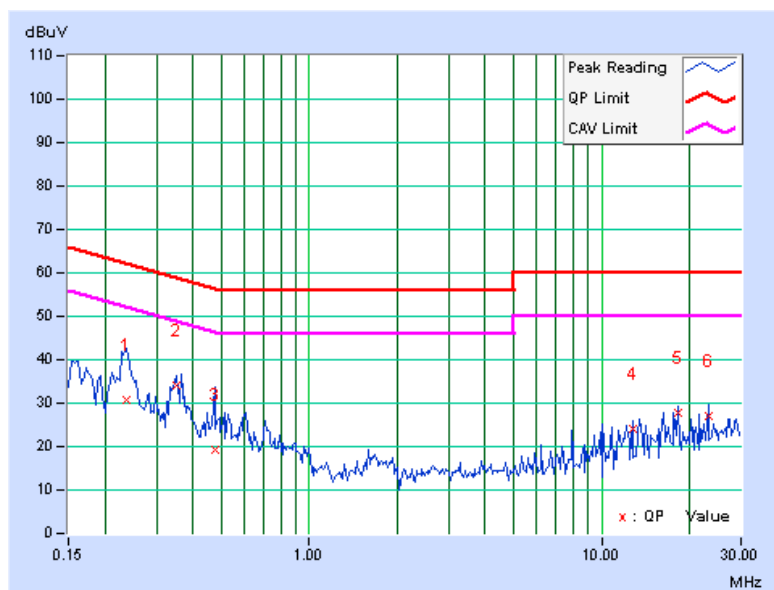



A D T

PHASE	Line 1	6dB BANDWIDTH	9kHz
TEST MODE	B2		

No	Freq. [MHz]	Corr. Factor (dB)	Reading Value [dB (uV)]		Emission Level [dB (uV)]		Limit [dB (uV)]		Margin (dB)	
			Q.P.	AV.	Q.P.	AV.	Q.P.	AV.	Q.P.	AV.
1	0.189	0.11	42.11	-	42.22	-	64.08	54.08	-21.86	-
2	0.451	0.13	34.37	-	34.50	-	56.86	46.86	-22.36	-
3	0.670	0.15	38.39	-	38.54	-	56.00	46.00	-17.46	-
4	0.959	0.18	37.79	-	37.97	-	56.00	46.00	-18.03	-
5	2.398	0.27	36.69	-	36.96	-	56.00	46.00	-19.04	-
6	11.352	0.75	42.87	-	43.62	-	60.00	50.00	-16.38	-

- REMARKS:**
1. Q.P. and AV. are abbreviations of quasi-peak and average individually.
 2. "-": The Quasi-peak reading value also meets average limit and measurement with the average detector is unnecessary.
 3. The emission levels of other frequencies were very low against the limit.
 4. Margin value = Emission level - Limit value
 5. Correction factor = Insertion loss + Cable loss
 6. Emission Level = Correction Factor + Reading Value.

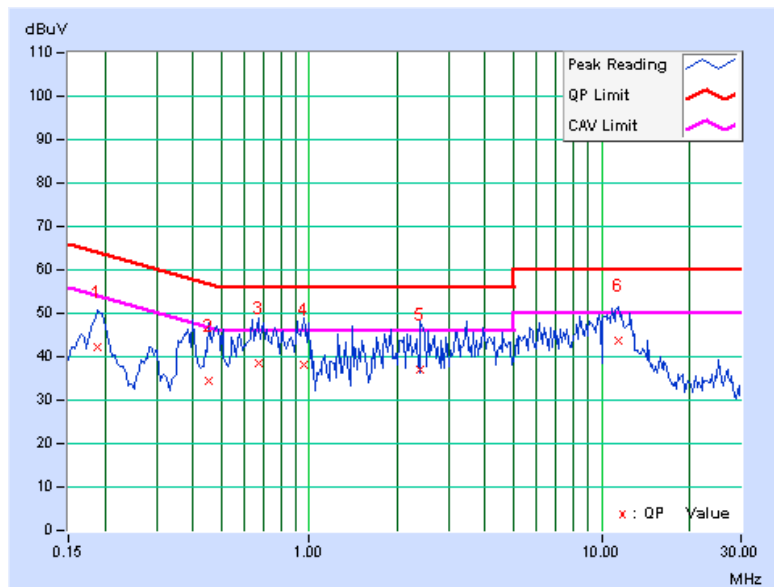



A D T

PHASE	Line 2	6dB BANDWIDTH	9kHz
TEST MODE	B2		

No	Freq. [MHz]	Corr. Factor (dB)	Reading Value		Emission Level		Limit		Margin	
			[dB (uV)]		[dB (uV)]		[dB (uV)]		(dB)	
			Q.P.	AV.	Q.P.	AV.	Q.P.	AV.	Q.P.	AV.
1	0.197	0.10	40.61	-	40.71	-	63.74	53.74	-23.03	-
2	0.377	0.12	33.68	-	33.80	-	58.35	48.35	-24.56	-
3	0.798	0.15	32.22	-	32.37	-	56.00	46.00	-23.63	-
4	0.998	0.17	32.88	-	33.05	-	56.00	46.00	-22.95	-
5	6.770	0.43	34.94	-	35.37	-	60.00	50.00	-24.63	-
6	11.395	0.66	39.78	-	40.44	-	60.00	50.00	-19.56	-

- REMARKS:**
1. Q.P. and AV. are abbreviations of quasi-peak and average individually.
 2. "-": The Quasi-peak reading value also meets average limit and measurement with the average detector is unnecessary.
 3. The emission levels of other frequencies were very low against the limit.
 4. Margin value = Emission level - Limit value
 5. Correction factor = Insertion loss + Cable loss
 6. Emission Level = Correction Factor + Reading Value.

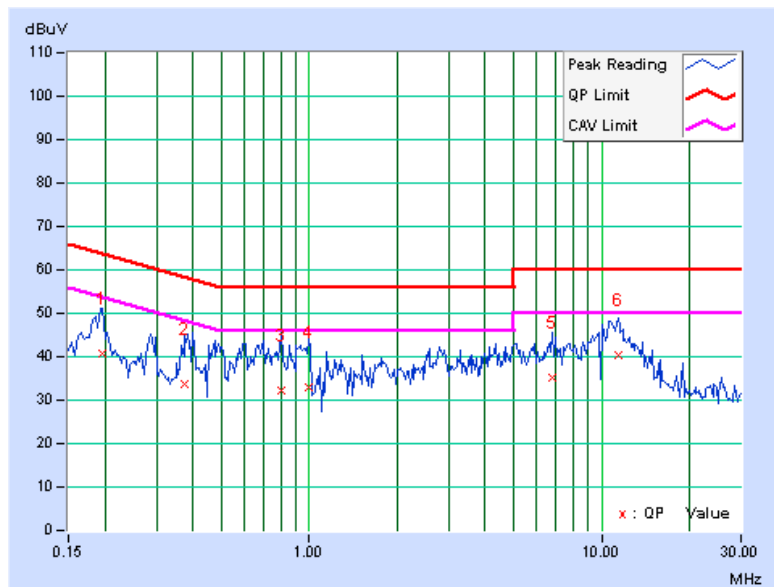



A D T

PHASE	Line 1	6dB BANDWIDTH	9kHz
TEST MODE	C2		

No	Freq. [MHz]	Corr. Factor (dB)	Reading Value		Emission Level		Limit		Margin	
			[dB (uV)]		[dB (uV)]		[dB (uV)]		(dB)	
			Q.P.	AV.	Q.P.	AV.	Q.P.	AV.	Q.P.	AV.
1	0.177	0.11	38.78	-	38.89	-	64.61	54.61	-25.71	-
2	0.220	0.11	40.32	-	40.43	-	62.81	52.81	-22.38	-
3	0.435	0.13	36.84	-	36.97	-	57.15	47.15	-20.18	-
4	1.418	0.21	28.80	-	29.01	-	56.00	46.00	-26.99	-
5	1.934	0.25	27.71	-	27.96	-	56.00	46.00	-28.04	-
6	12.746	0.87	34.26	-	35.13	-	60.00	50.00	-24.87	-

- REMARKS:**
1. Q.P. and AV. are abbreviations of quasi-peak and average individually.
 2. "-": The Quasi-peak reading value also meets average limit and measurement with the average detector is unnecessary.
 3. The emission levels of other frequencies were very low against the limit.
 4. Margin value = Emission level - Limit value
 5. Correction factor = Insertion loss + Cable loss
 6. Emission Level = Correction Factor + Reading Value.

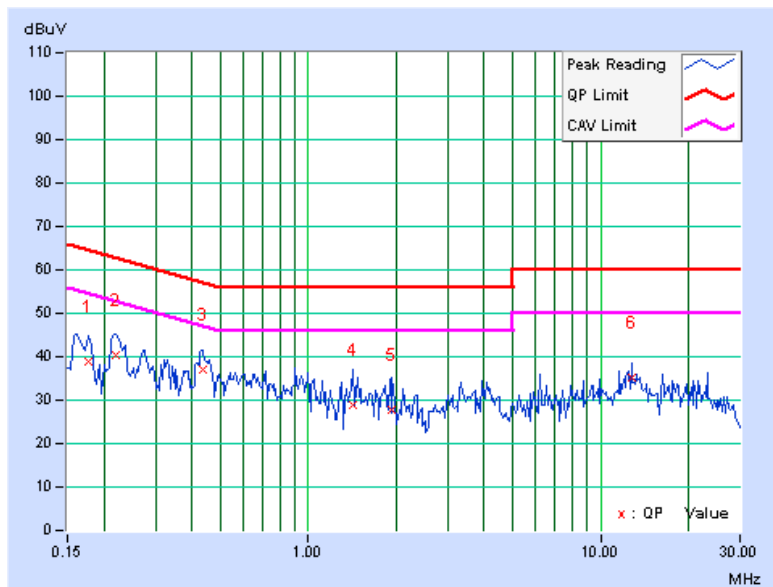



A D T

PHASE	Line 2	6dB BANDWIDTH	9kHz
TEST MODE	C2		

No	Freq. [MHz]	Corr. Factor (dB)	Reading Value		Emission Level		Limit		Margin	
			[dB (uV)]		[dB (uV)]		[dB (uV)]		(dB)	
			Q.P.	AV.	Q.P.	AV.	Q.P.	AV.	Q.P.	AV.
1	0.158	0.10	31.70	-	31.80	-	65.58	55.58	-33.78	-
2	0.213	0.10	35.26	-	35.36	-	63.11	53.11	-27.75	-
3	0.431	0.12	33.46	-	33.58	-	57.23	47.23	-23.65	-
4	1.645	0.22	26.73	-	26.95	-	56.00	46.00	-29.05	-
5	6.242	0.41	31.96	-	32.37	-	60.00	50.00	-27.63	-
6	16.230	1.02	32.65	-	33.67	-	60.00	50.00	-26.33	-

- REMARKS:**
1. Q.P. and AV. are abbreviations of quasi-peak and average individually.
 2. "-": The Quasi-peak reading value also meets average limit and measurement with the average detector is unnecessary.
 3. The emission levels of other frequencies were very low against the limit.
 4. Margin value = Emission level - Limit value
 5. Correction factor = Insertion loss + Cable loss
 6. Emission Level = Correction Factor + Reading Value.

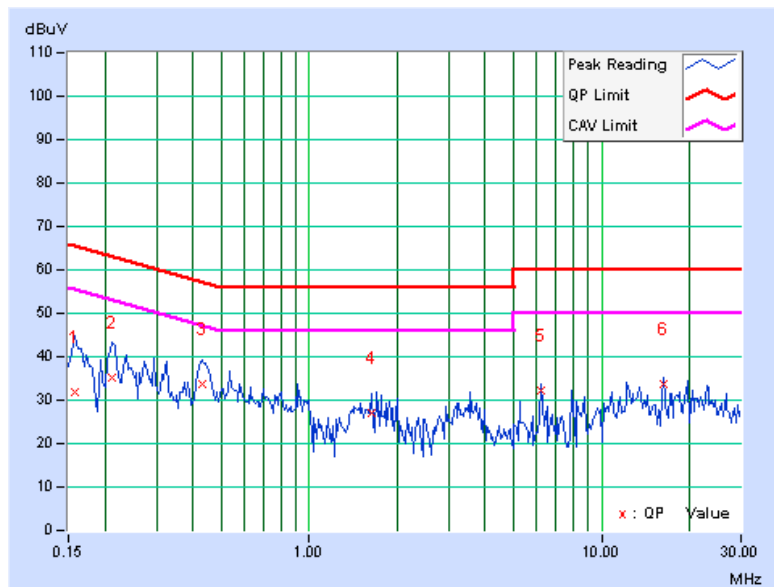



A D T

4.3 6dB BANDWIDTH MEASUREMENT

4.3.1 LIMITS OF 6dB BANDWIDTH MEASUREMENT

The minimum of 6dB Bandwidth Measurement is 0.5 MHz.

4.3.2 TEST INSTRUMENTS

DESCRIPTION & MANUFACTURER	MODEL NO.	SERIAL NO.	DATE OF CALIBRATION	DUE DATE OF CALIBRATION
SPECTRUM ANALYZER	FSP40	100039	Jan. 11, 2010	Jan. 10, 2011

NOTE: The calibration interval of the above test instruments is 12 months and the calibrations are traceable to NML/ROC and NIST/USA.

4.3.3 TEST PROCEDURE

The transmitter output was connected to the spectrum analyzer through an attenuator. The bandwidth of the fundamental frequency was measured by spectrum analyzer with 100kHz RBW and 300kHz VBW. The 6dB bandwidth is defined as the total spectrum the power of which is higher than peak power minus 6dB.

4.3.4 DEVIATION FROM TEST STANDARD

No deviation.

4.3.5 TEST SETUP

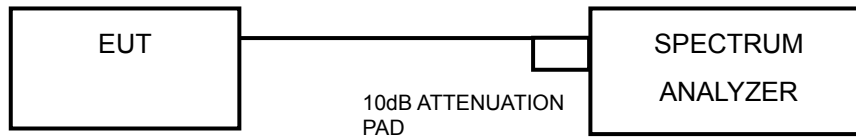

4.3.6 EUT OPERATING CONDITIONS

The software provided by client to enable the EUT under transmission condition continuously at lowest, middle and highest channel frequencies individually.



A D T

4.3.7 TEST RESULTS

802.11b: 1TX

CHANNEL	CHANNEL FREQUENCY (MHz)	6dB BANDWIDTH (MHz)	MINIMUM LIMIT (MHz)	PASS / FAIL
1	2412	10.13	0.5	PASS
6	2437	10.11	0.5	PASS
11	2462	10.13	0.5	PASS

CH 1

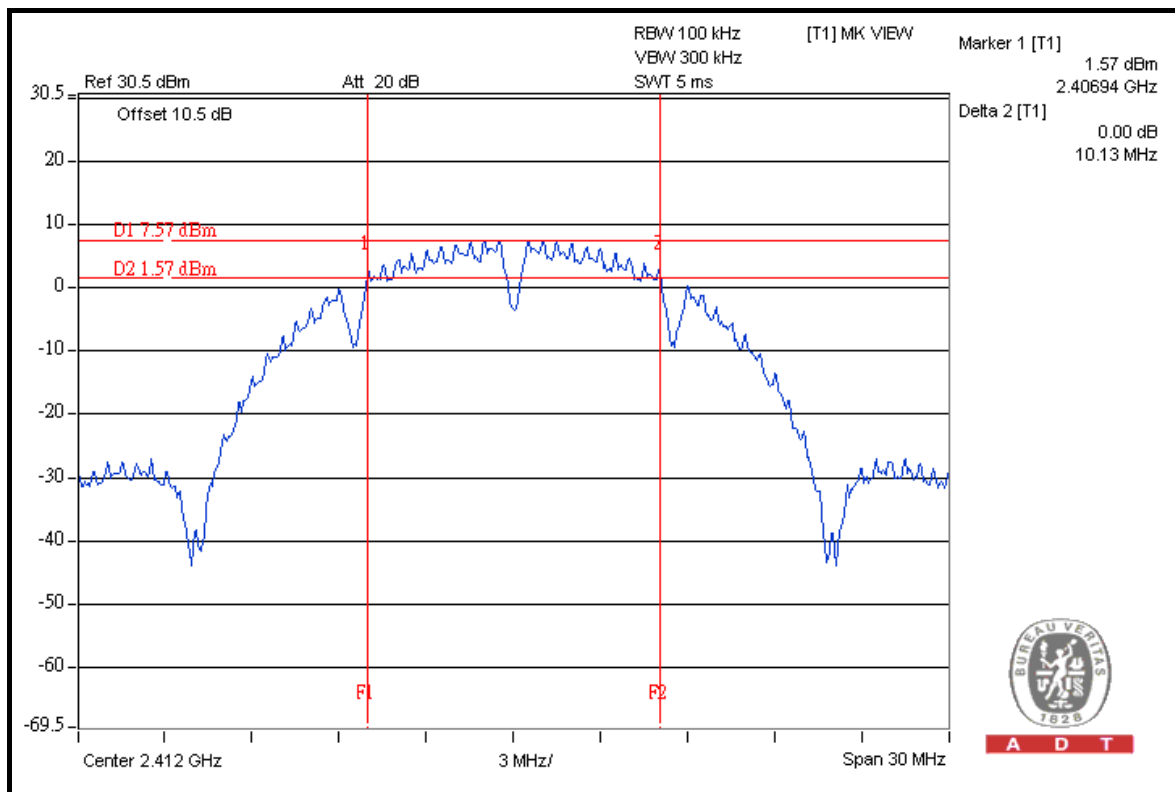



A D T

802.11g: 1TX

CHANNEL	CHANNEL FREQUENCY (MHz)	6dB BANDWIDTH (MHz)	MINIMUM LIMIT (MHz)	PASS / FAIL
1	2412	16.57	0.5	PASS
6	2437	16.61	0.5	PASS
11	2462	16.59	0.5	PASS

CH 6

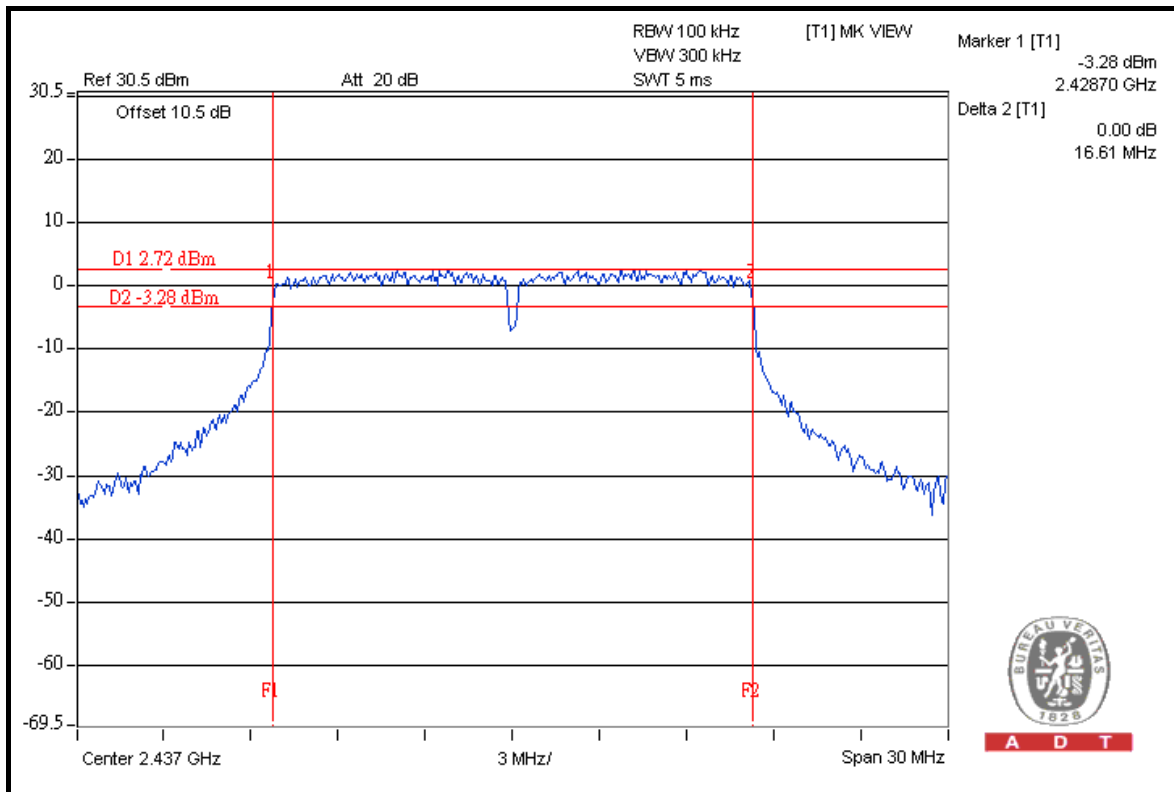

A D T



A D T

802.11n (20MHz): 1TX

CHANNEL	CHANNEL FREQUENCY (MHz)	6dB BANDWIDTH (MHz)	MINIMUM LIMIT (MHz)	PASS / FAIL
1	2412	17.82	0.5	PASS
6	2437	17.84	0.5	PASS
11	2462	17.83	0.5	PASS

CH 6

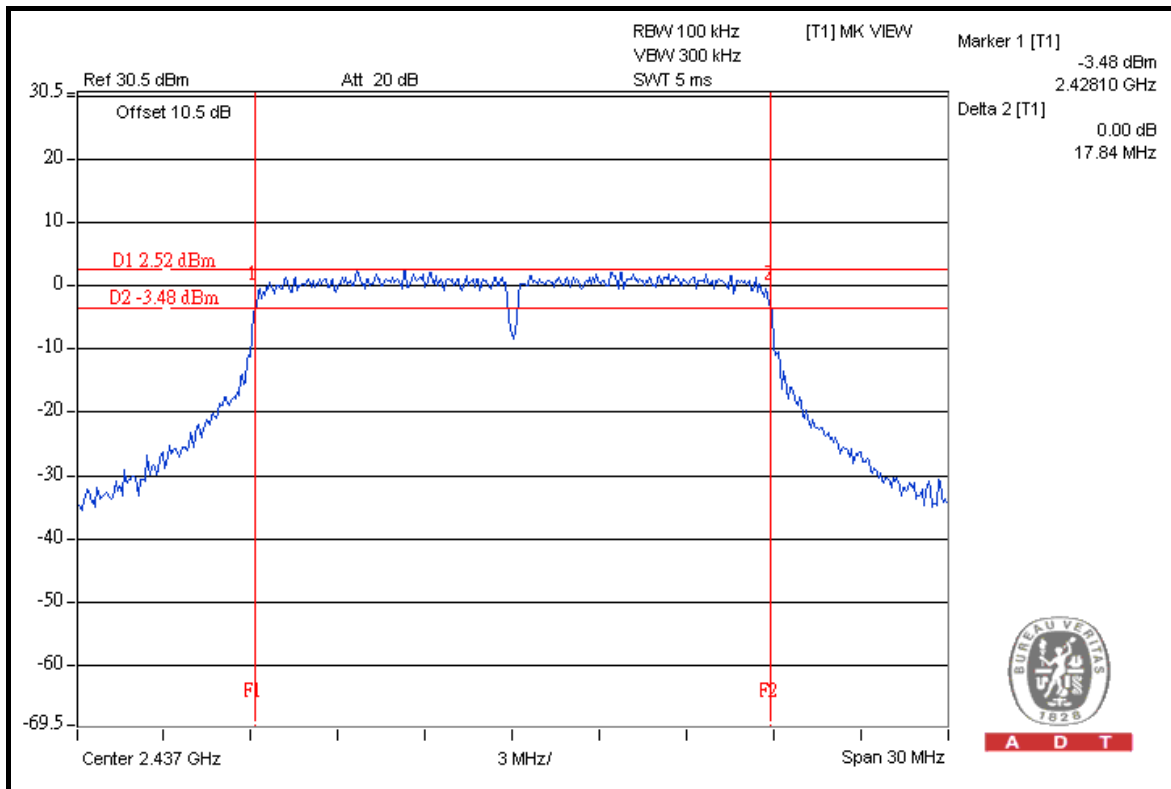



A D T

802.11n (20MHz): 2TX

CHANNEL	CHANNEL FREQUENCY (MHz)	6dB BANDWIDTH (MHz)		MINIMUM LIMIT (MHz)	PASS / FAIL
		CHAIN 0	CHAIN 1		
1	2412	17.81	17.74	0.5	PASS
6	2437	17.83	17.74	0.5	PASS
11	2462	17.79	17.72	0.5	PASS

FOR CHAIN 0: CH 6

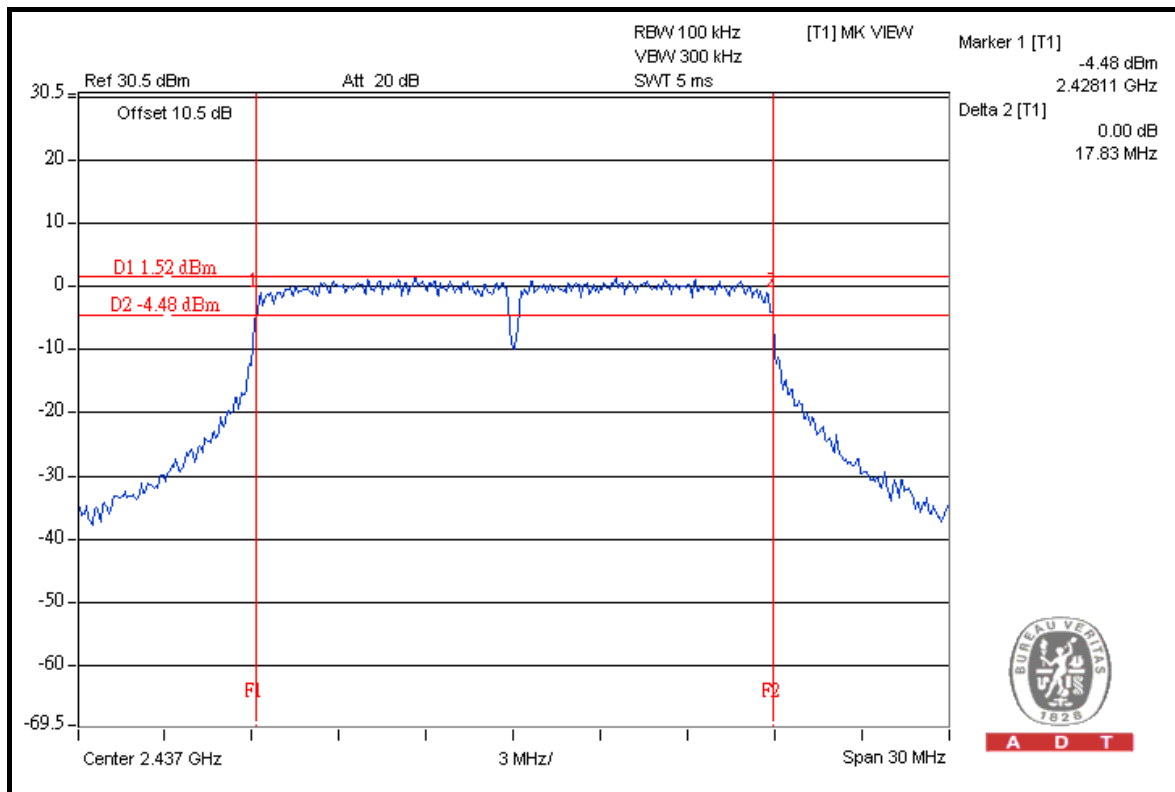



A D T

802.11n (40MHz): 1TX

CHANNEL	CHANNEL FREQUENCY (MHz)	6dB BANDWIDTH (MHz)	MINIMUM LIMIT (MHz)	PASS / FAIL
1	2422	36.55	0.5	PASS
4	2437	36.55	0.5	PASS
7	2452	36.55	0.5	PASS

CH 1

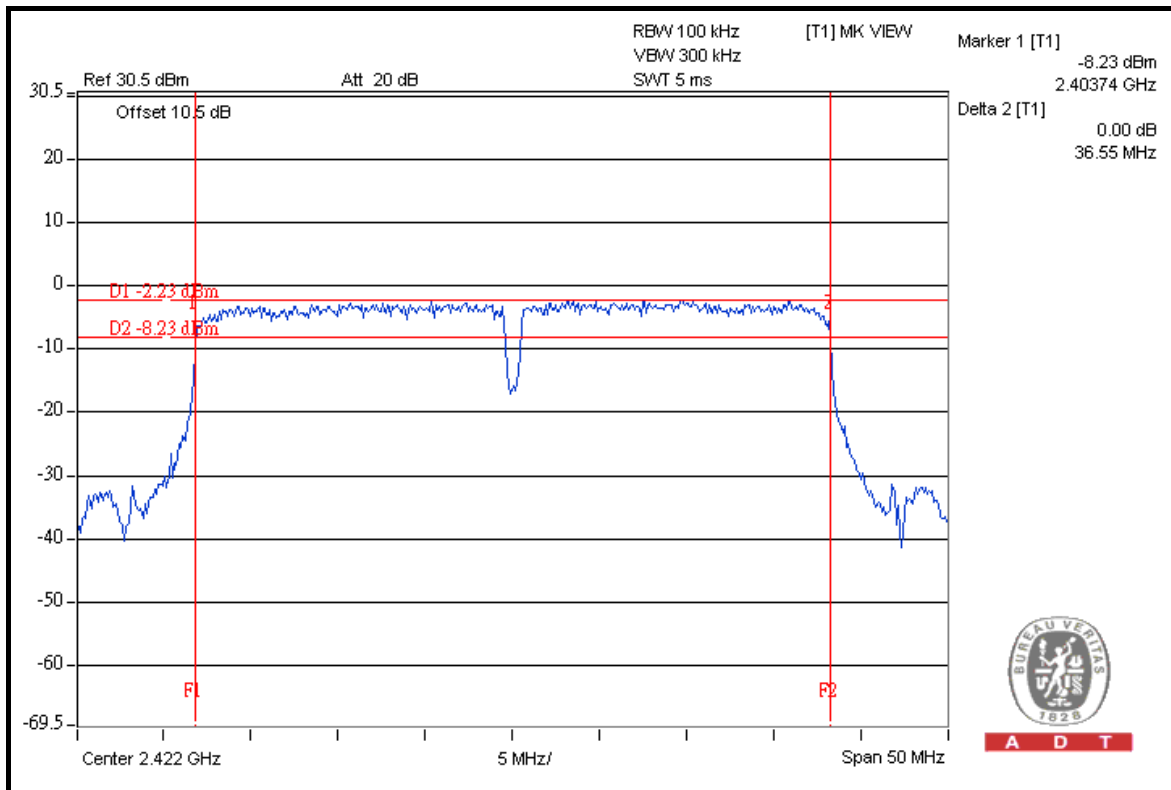



A D T

802.11n (40MHz): 2TX

CHANNEL	CHANNEL FREQUENCY (MHz)	6dB BANDWIDTH (MHz)		MINIMUM LIMIT (MHz)	PASS / FAIL
		CHAIN 0	CHAIN 1		
1	2422	36.52	36.48	0.5	PASS
4	2437	36.54	36.49	0.5	PASS
7	2452	36.54	36.49	0.5	PASS

FOR CHAIN 0: CH 4

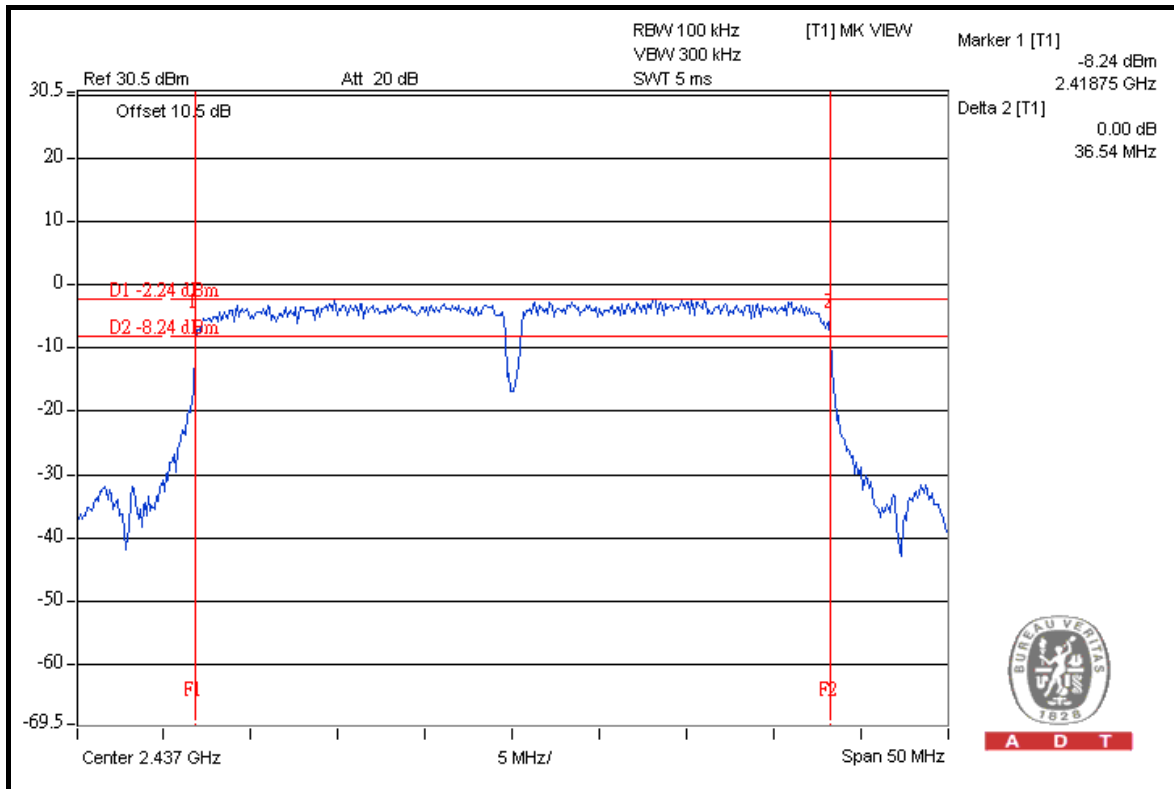



A D T

4.4 MAXIMUM OUTPUT POWER

4.4.1 LIMITS OF MAXIMUM OUTPUT POWER MEASUREMENT

The Maximum Output Power Measurement is 30dBm.

4.4.2 INSTRUMENTS

DESCRIPTION & MANUFACTURER	MODEL NO.	SERIAL NO.	DATE OF CALIBRATION	DUE DATE OF CALIBRATION
High Speed Peak Power Meter	ML2495A	0842014	Apr. 21, 2010	Apr. 20, 2011
Power Sensor	MA2411B	0738404	Apr. 21, 2010	Apr. 20, 2011

NOTE:

1. The calibration interval of the above test instruments is 12 months and the calibrations are traceable to NML/ROC and NIST/USA.
2. Measurement Bandwidth of ML2495A is 65MHz greater than 6dB bandwidth of emission.

4.4.3 TEST PROCEDURES

A power sensor was used on the output port of the EUT. A power meter was used to read the response of the power sensor. Record the power level.

4.4.4 DEVIATION FROM TEST STANDARD

No deviation.

4.4.5 TEST SETUP

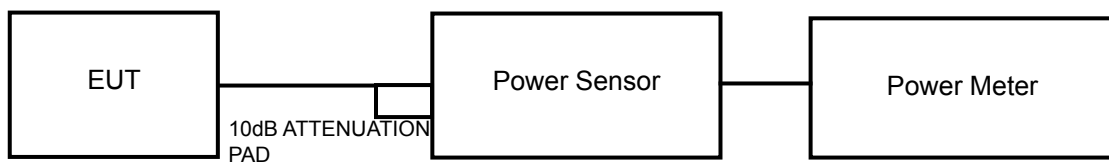

4.4.6 EUT OPERATING CONDITIONS

Same as Item 4.3.6.



A D T

4.4.7 TEST RESULTS

802.11b: 1TX

CHANNEL	CHANNEL FREQUENCY (MHz)	PEAK POWER OUTPUT (mW)	PEAK POWER OUTPUT (dBm)	PEAK POWER LIMIT (dBm)	PASS/FAIL
1	2412	112.2	20.5	30	PASS
6	2437	114.8	20.6	30	PASS
11	2462	107.2	20.3	30	PASS

802.11g: 1TX

CHANNEL	CHANNEL FREQUENCY (MHz)	PEAK POWER OUTPUT (mW)	PEAK POWER OUTPUT (dBm)	PEAK POWER LIMIT (dBm)	PASS/FAIL
1	2412	346.7	25.4	30	PASS
6	2437	380.2	25.8	30	PASS
11	2462	309.0	24.9	30	PASS

802.11n (20MHz): 1TX

CHANNEL	CHANNEL FREQUENCY (MHz)	PEAK POWER OUTPUT (mW)	PEAK POWER OUTPUT (dBm)	PEAK POWER LIMIT (dBm)	PASS/FAIL
1	2412	338.8	25.3	30	PASS
6	2437	354.8	25.5	30	PASS
11	2462	295.1	24.7	30	PASS

802.11n (20MHz): 2TX

CHAN.	CHAN. FREQ. (MHz)	POWER OUTPUT (dBm)		TOTAL POWER (mW)	TOTAL POWER (dBm)	POWER LIMIT (dBm)	PASS / FAIL
		CHAIN 0	CHAIN 1				
1	2412	24.0	24.8	553.2	27.4	30	PASS
6	2437	24.5	25.0	598.1	27.8	30	PASS
11	2462	23.5	23.5	447.7	26.5	30	PASS

802.11n (40MHz): 1TX

CHANNEL	CHANNEL FREQUENCY (MHz)	PEAK POWER OUTPUT (mW)	PEAK POWER OUTPUT (dBm)	PEAK POWER LIMIT (dBm)	PASS/FAIL
1	2422	316.2	25.0	30	PASS
4	2437	331.1	25.2	30	PASS
7	2452	281.8	24.5	30	PASS

802.11n (40MHz): 2TX

CHAN.	CHAN. FREQ. (MHz)	POWER OUTPUT (dBm)		TOTAL POWER (mW)	TOTAL POWER (dBm)	POWER LIMIT (dBm)	PASS / FAIL
		CHAIN 0	CHAIN 1				
1	2422	23.5	23.9	469.3	26.7	30	PASS
4	2437	23.7	23.9	479.9	26.8	30	PASS
7	2452	23.1	23.2	413.1	26.2	30	PASS



4.5 POWER SPECTRAL DENSITY MEASUREMENT

4.5.1 LIMITS OF POWER SPECTRAL DENSITY MEASUREMENT

The Maximum of Power Spectral Density Measurement is 8dBm.

4.5.2 TEST INSTRUMENTS

DESCRIPTION & MANUFACTURER	MODEL NO.	SERIAL NO.	DATE OF CALIBRATION	DUE DATE OF CALIBRATION
SPECTRUM ANALYZER	FSP40	100039	Jan. 11, 2010	Jan. 10, 2011

NOTE: The calibration interval of the above test instruments is 12 months and the calibrations are traceable to NML/ROC and NIST/USA.

4.5.3 TEST PROCEDURE

The transmitter output was connected to the spectrum analyzer through an attenuator, the bandwidth of the fundamental frequency was measured with the spectrum analyzer using 3kHz RBW and 30kHz VBW, set sweep time = span/3kHz. The power spectral density was measured and recorded.

The sweep time is allowed to be longer than span/3kHz for a full response of the mixer in the spectrum analyzer.



A D T

4.5.4 DEVIATION FROM TEST STANDARD

No deviation.

4.5.5 TEST SETUP

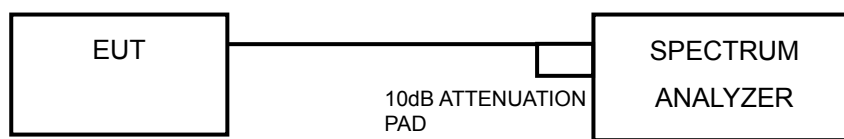

4.5.6 EUT OPERATING CONDITION

Same as Item 4.3.6



A D T

4.5.7 TEST RESULTS

802.11b: 1TX

CHANNEL	CHANNEL FREQUENCY (MHz)	RF POWER LEVEL IN 3 kHz BW (dBm)	MAXIMUM LIMIT (dBm)	PASS/FAIL
1	2412	-12.3	8	PASS
6	2437	-12.1	8	PASS
11	2462	-12.6	8	PASS

CH 6

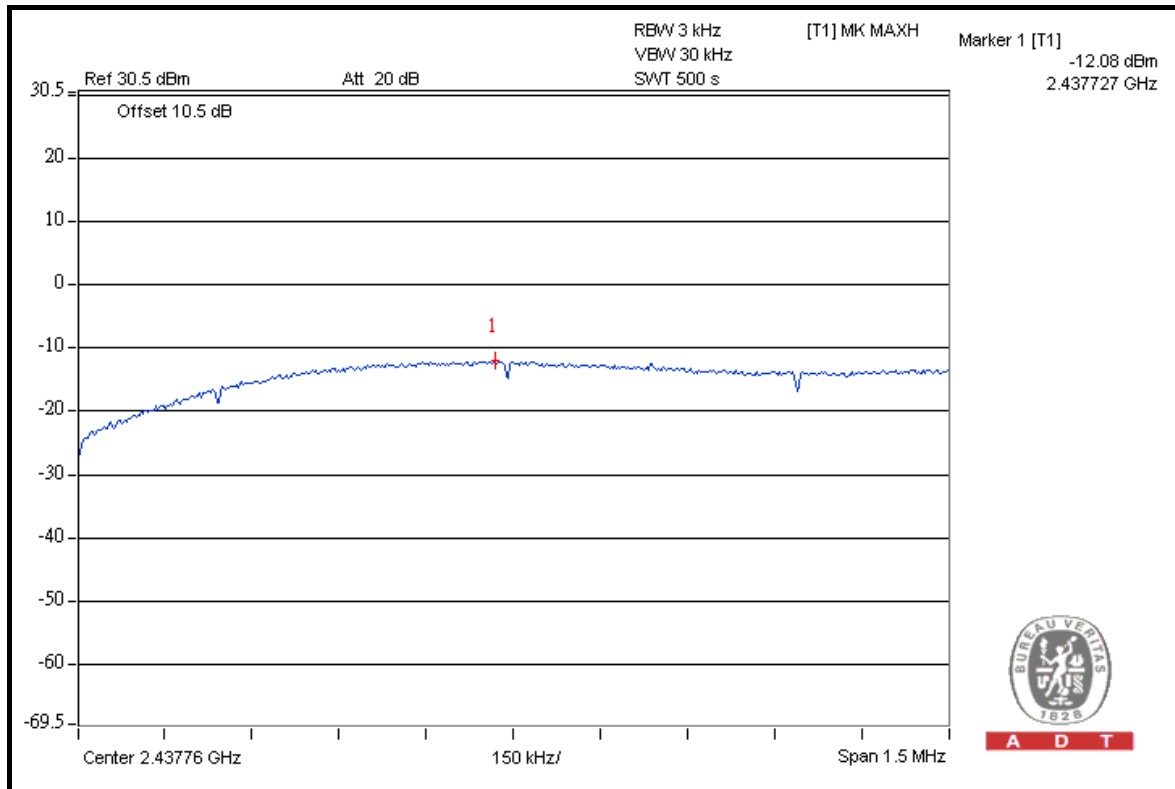



A D T

802.11g: 1TX

CHANNEL	CHANNEL FREQUENCY (MHz)	RF POWER LEVEL IN 3 kHz BW (dBm)	MAXIMUM LIMIT (dBm)	PASS/FAIL
1	2412	-12.0	8	PASS
6	2437	-11.5	8	PASS
11	2462	-12.2	8	PASS

CH 6

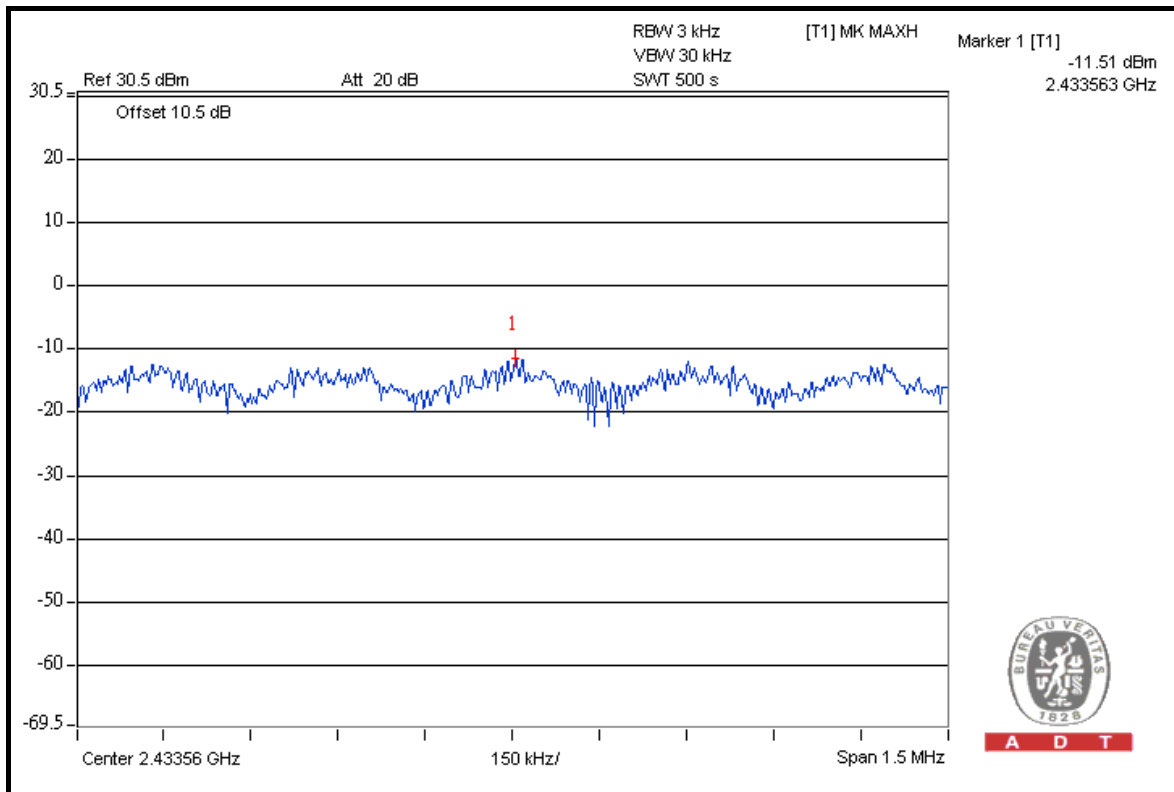

A D T



A D T

802.11n (20MHz): 1TX

CHANNEL	CHANNEL FREQUENCY (MHz)	RF POWER LEVEL IN 3 kHz BW (dBm)	MAXIMUM LIMIT (dBm)	PASS/FAIL
1	2412	-12.0	8	PASS
6	2437	-11.5	8	PASS
11	2462	-12.2	8	PASS

CH 6

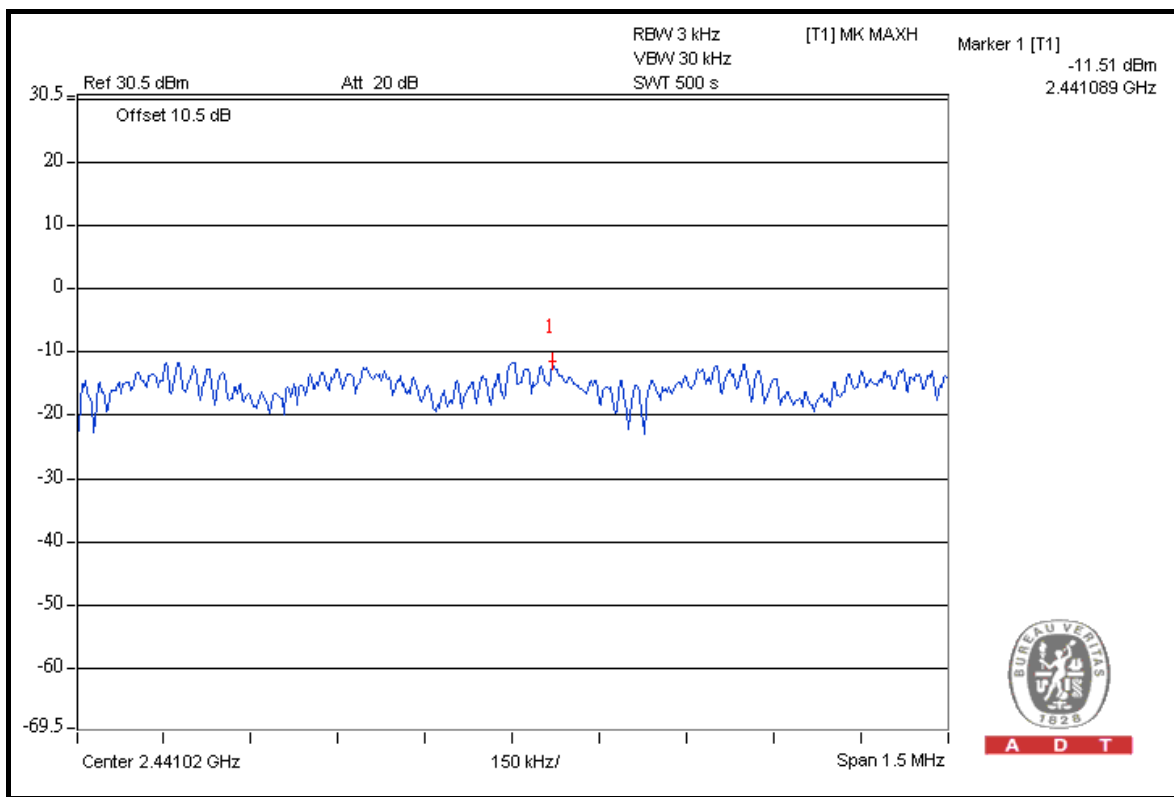



A D T

802.11n (20MHz): 2TX

CHAN.	CHAN. FREQ. (MHz)	RF POWER LEVEL IN 3kHz BW (dBm)		TOTAL POWER DENSITY (dBm)	MAX. LIMIT (dBm)	PASS / FAIL
		CHAIN 0	CHAIN 1			
1	2412	-11.6	-10.9	-8.2	8	PASS
6	2437	-11.3	-10.9	-8.1	8	PASS
11	2462	-12.2	-12.2	-9.2	8	PASS

FOR CHAIN 1: CH 1

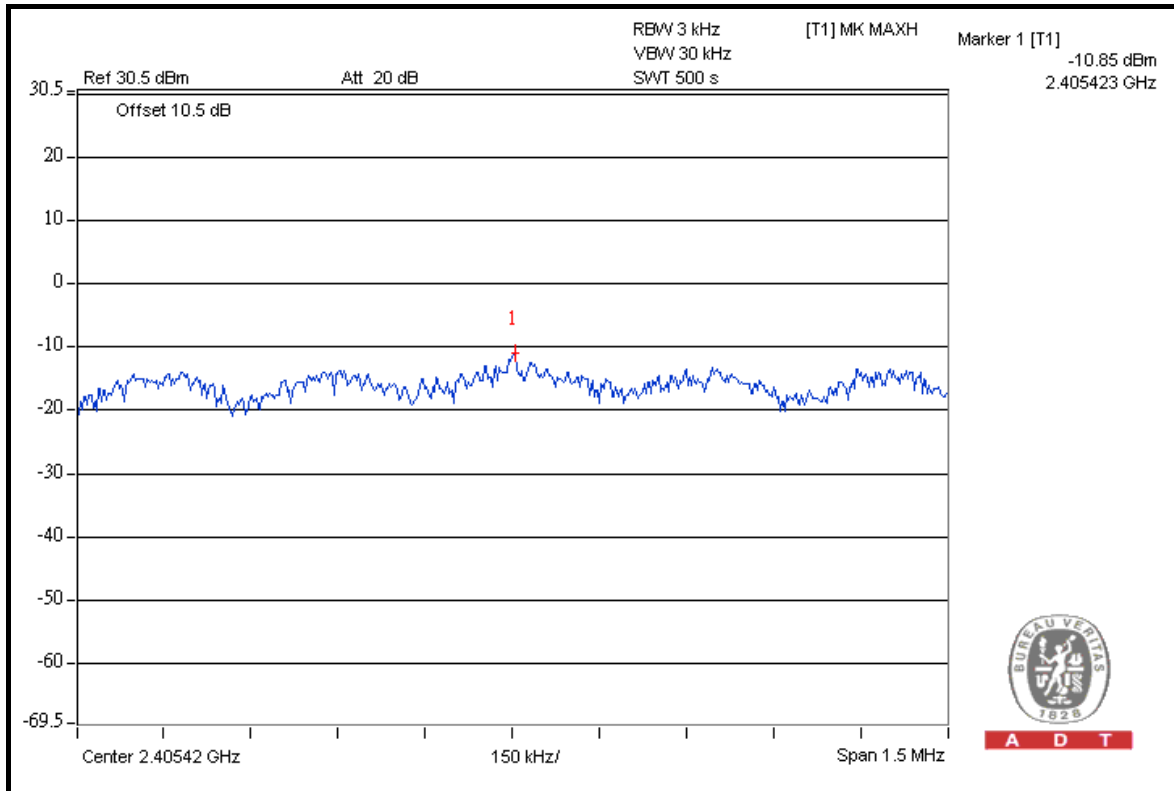

A D T



A D T

802.11n (40MHz): 1TX

CHANNEL	CHANNEL FREQUENCY (MHz)	RF POWER LEVEL IN 3 kHz BW (dBm)	MAXIMUM LIMIT (dBm)	PASS/FAIL
1	2422	-14.8	8	PASS
4	2437	-13.8	8	PASS
7	2452	-15.2	8	PASS

CH 4

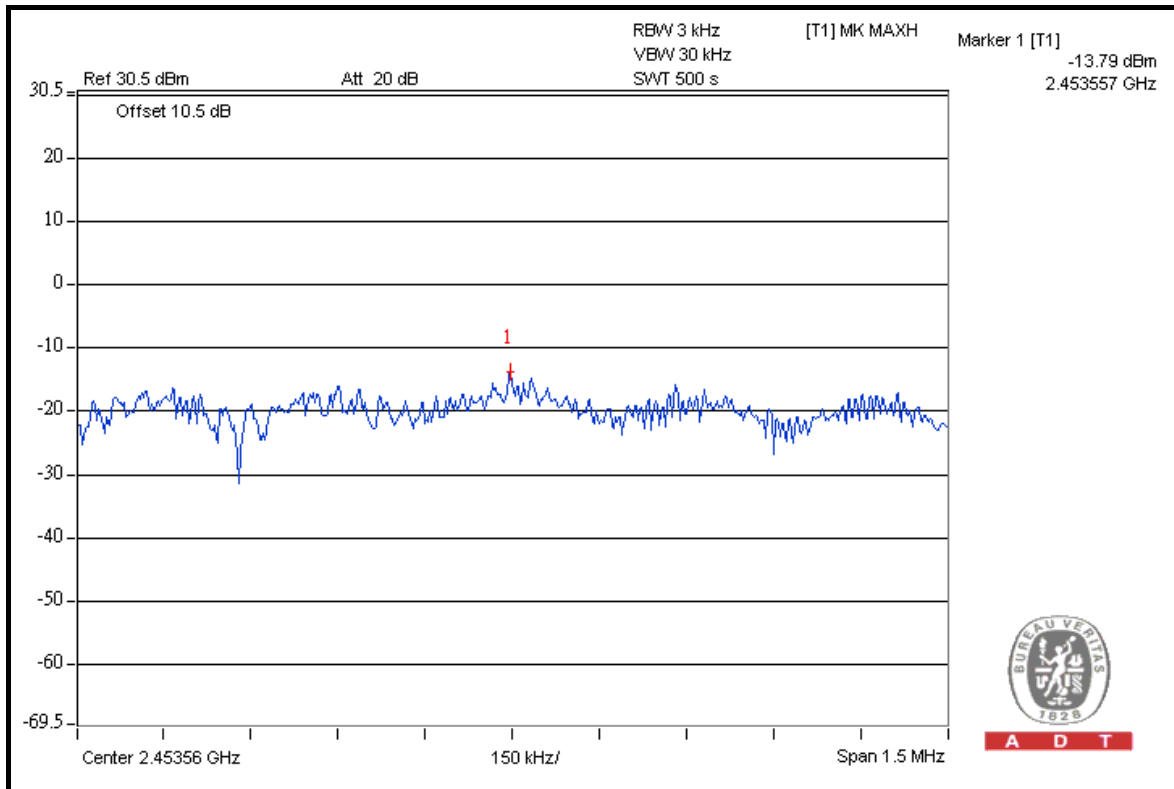



A D T

802.11n (40MHz): 2TX

CHAN.	CHAN. FREQ. (MHz)	RF POWER LEVEL IN 3kHz BW (dBm)		TOTAL POWER DENSITY (dBm)	MAX. LIMIT (dBm)	PASS / FAIL
		CHAIN 0	CHAIN 1			
1	2422	-13.6	-15.2	-11.3	8	PASS
4	2437	-13.2	-15.3	-11.1	8	PASS
7	2452	-13.8	-15.7	-11.6	8	PASS

FOR CHAIN 0: CH 4

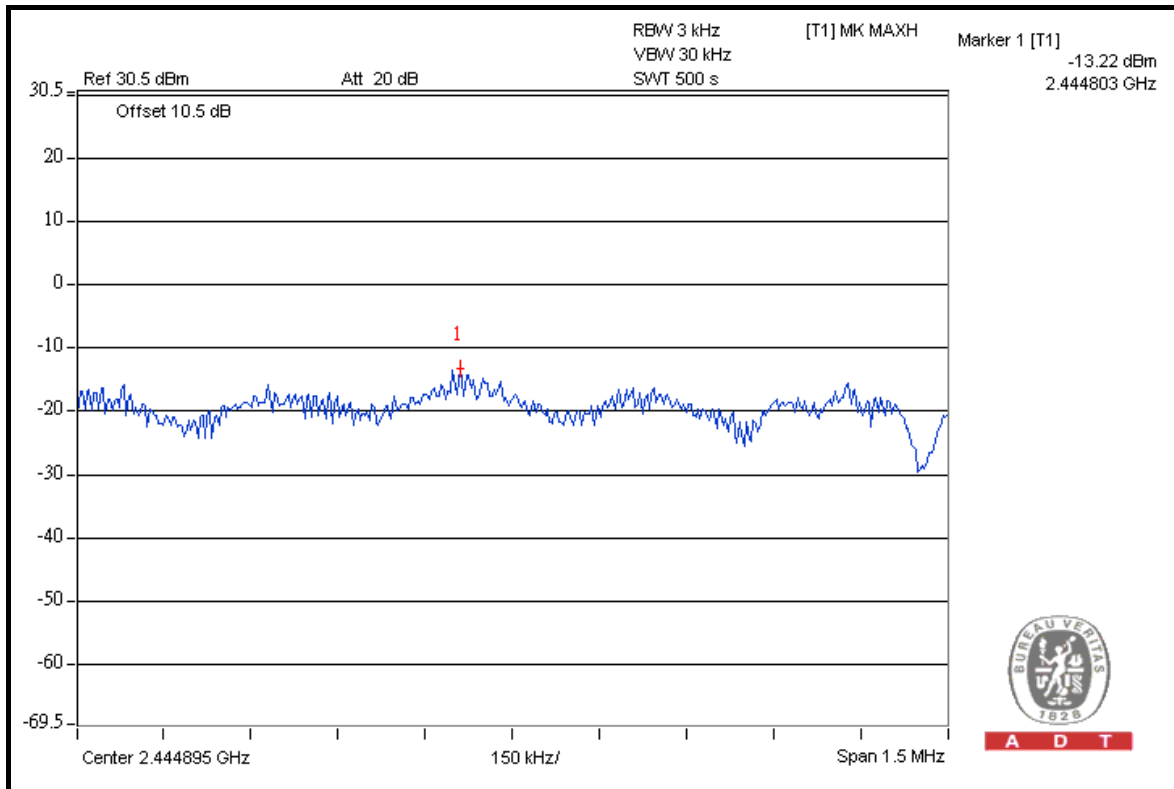



A D T

4.6 BAND EDGES MEASUREMENT

4.6.1 LIMITS OF BAND EDGES MEASUREMENT

Below -20dB of the highest emission level of operating band (in 100kHz Resolution Bandwidth).

4.6.2 TEST INSTRUMENTS

DESCRIPTION & MANUFACTURER	MODEL NO.	SERIAL NO.	DATE OF CALIBRATION	DUE DATE OF CALIBRATION
FOR CONDUCTED MEASUREMENT				
SPECTRUM ANALYZER	FSP40	100039	Jan. 11, 2010	Jan. 10, 2011
FOR RADIATED MEASUREMENT				
Test Receiver ROHDE & SCHWARZ	ESIB7	100188	Dec. 21, 2009	Dec. 20, 2010
Spectrum Analyzer ROHDE & SCHWARZ	FSP40	100041	Jul. 09, 2010	Jul. 08, 2011
BILOG Antenna SCHWARZBECK	VULB9168	9168-156	Apr. 30, 2010	Apr. 29, 2011
HORN Antenna SCHWARZBECK	BBHA 9120 D	9120D-209	Aug. 02, 2010	Aug. 01, 2011
HORN Antenna SCHWARZBECK	BBHA 9170	BBHA9170242	Dec. 25, 2009	Dec. 24, 2010
Preamplifier Agilent	8449B	3008A01910	Sep. 09, 2010	Sep. 08, 2011
Preamplifier Agilent	8447D	2944A10638	Dec. 21, 2009	Dec. 20, 2010
RF signal cable HUBER+SUHNNER	SUCOFLEX 104	218190/4 231241/4	May 14, 2010	May 13, 2011
RF signal cable Worken	8D-FB	Cable-HYCH9-01	Aug. 20, 2010	Aug. 19, 2011
Software	ADT_Radiated_ V7.6.15.9.2	NA	NA	NA
Antenna Tower EMCO	2070/2080	512.835.4684	NA	NA
Turn Table EMCO	2087-2.03	NA	NA	NA
Antenna Tower & Turn Table Controller EMCO	2090	NA	NA	NA

NOTE: The calibration interval of the above test instruments is 12 months and the calibrations are traceable to NML/ROC and NIST/USA.



A D T

4.6.3 TEST PROCEDURE

- a. The EUT was placed on the top of a rotating table 0.8 meters above the ground at a 3 meter semi-anechoic chamber. The table was rotated 360 degrees to determine the position of the highest radiation.
- b. The EUT was set 3 meters away from the interference-receiving antenna, which was mounted on the top of a variable-height antenna tower.
- c. The antenna is a broadband antenna, and its height is varied from one meter to four meters above the ground to determine the maximum value of the field strength. Both horizontal and vertical polarizations of the antenna are set to make the measurement.
- d. For each suspected emission, the EUT was arranged to its worst case and then the antenna was tuned to heights from 1 meter to 4 meters and the rotatable table was turned from 0 degrees to 360 degrees to find the maximum reading.
- e. Set both RBW and VBW of spectrum analyzer to 100kHz and 300kHz with suitable frequency span including 100MHz bandwidth from band edge. The band edges was measured and recorded.
- f. The spectrum plots (Peak RBW = 100kHz, VBW = 300kHz) are attached on the following pages.

NOTE: The resolution bandwidth of test receiver/spectrum analyzer is 1MHz and the video bandwidth is 10Hz for Average detection (AV) at frequency above 1GHz.

4.6.4 DEVIATION FROM TEST STANDARD

No deviation.

4.6.5 EUT OPERATING CONDITION

Same as Item 4.3.6.

4.6.6 TEST RESULTS

The spectrum plots are attached on the following pages. D1 line indicates the highest level, and D2 line indicates the 20dB offset below D1. It shows compliance with the requirement in part 15.247(d).



A D T

802.11b: 1TX

TEST MODE A1

RESTRICT BAND (2310 ~ 2390 MHz)

FREQUENCY (MHz)	FUNDAMENTAL EMISSION (dBuV/m)	DELTA (dB)	MAXIMUM FIELD STRENGTH IN RESTRICT BAND (dBuV/m)	LIMIT (dBuV/m)
2412.00 (PK)	110.4	53.37	57.03	74.00
2412.00 (AV)	105.8	58.37	47.43	54.00

RESTRICT BAND (2483.5 ~ 2500 MHz)

FREQUENCY (MHz)	FUNDAMENTAL EMISSION (dBuV/m)	DELTA (dB)	MAXIMUM FIELD STRENGTH IN RESTRICT BAND (dBuV/m)	LIMIT (dBuV/m)
2462.00 (PK)	110.0	52.74	57.26	74.00
2462.00 (AV)	105.2	56.24	48.96	54.00

TEST MODE A2

RESTRICT BAND (2310 ~ 2390 MHz)

FREQUENCY (MHz)	FUNDAMENTAL EMISSION (dBuV/m)	DELTA (dB)	MAXIMUM FIELD STRENGTH IN RESTRICT BAND (dBuV/m)	LIMIT (dBuV/m)
2412.00 (PK)	109.1	53.37	55.73	74.00
2412.00 (AV)	104.6	58.37	46.23	54.00

RESTRICT BAND (2483.5 ~ 2500 MHz)

FREQUENCY (MHz)	FUNDAMENTAL EMISSION (dBuV/m)	DELTA (dB)	MAXIMUM FIELD STRENGTH IN RESTRICT BAND (dBuV/m)	LIMIT (dBuV/m)
2462.00 (PK)	108.7	52.74	55.96	74.00
2462.00 (AV)	103.8	56.24	47.56	54.00

NOTE:

1. Delta = Amplitude between the peak of the fundamental and the peak of the band edge emission. Please check following 3 pages.
2. Maximum field strength in restrict band = Fundamental emission – Delta.



A D T

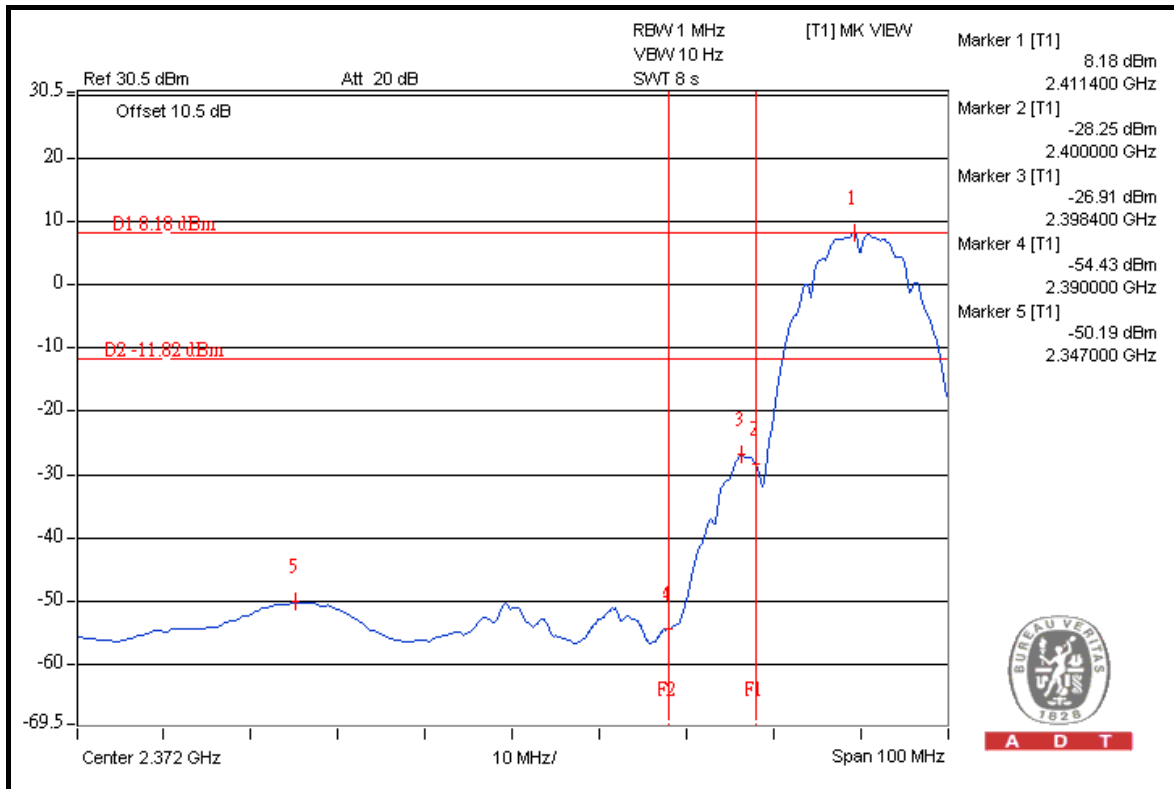
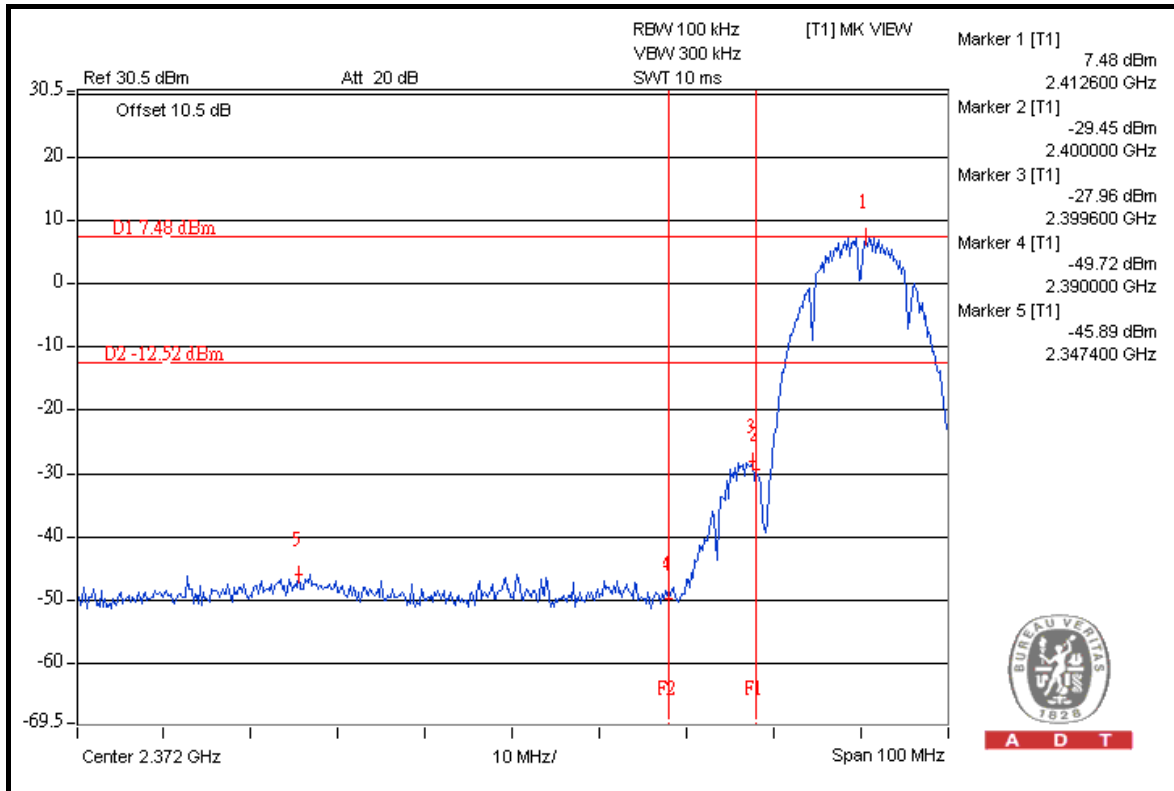



A D T

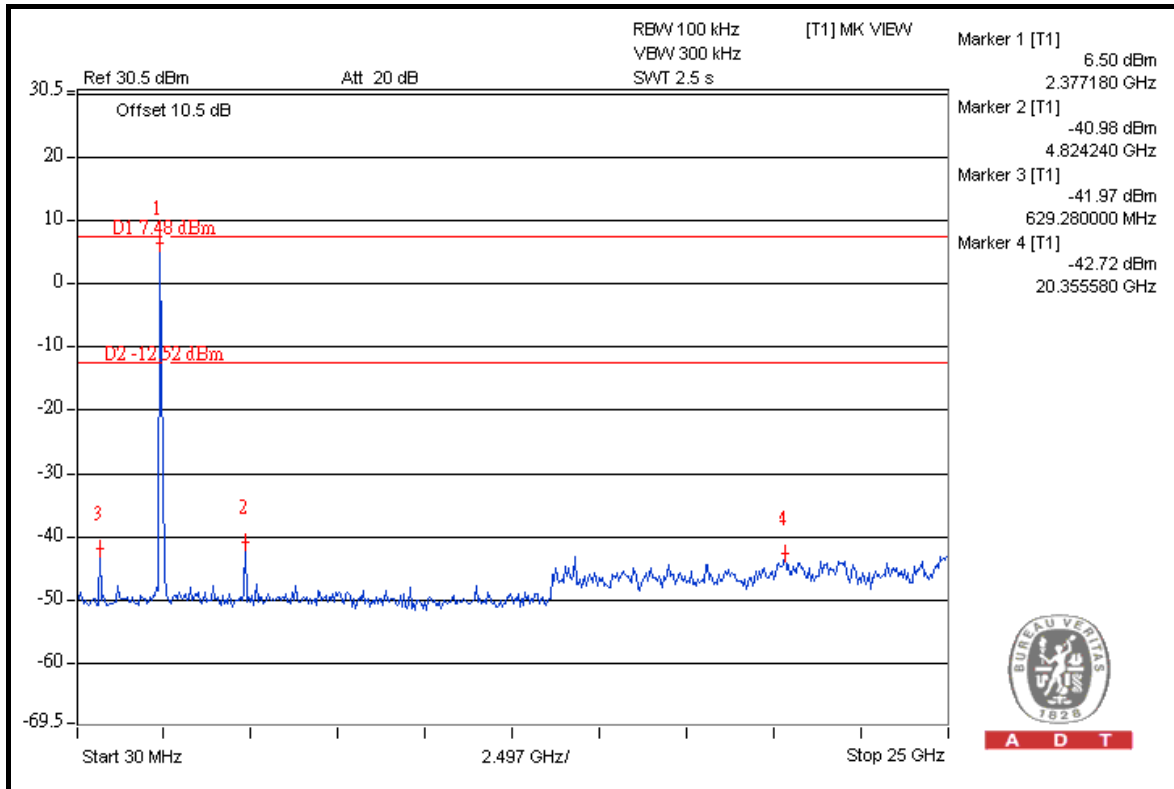

A D T

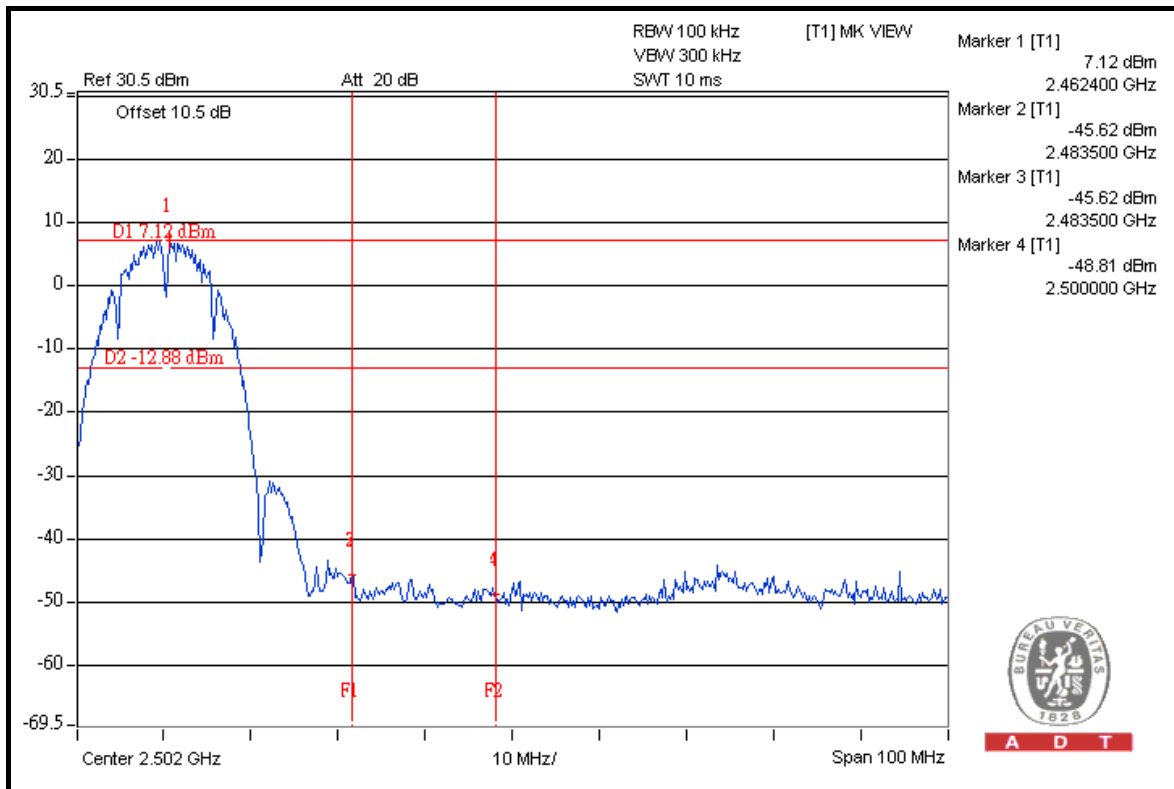

A D T



A D T

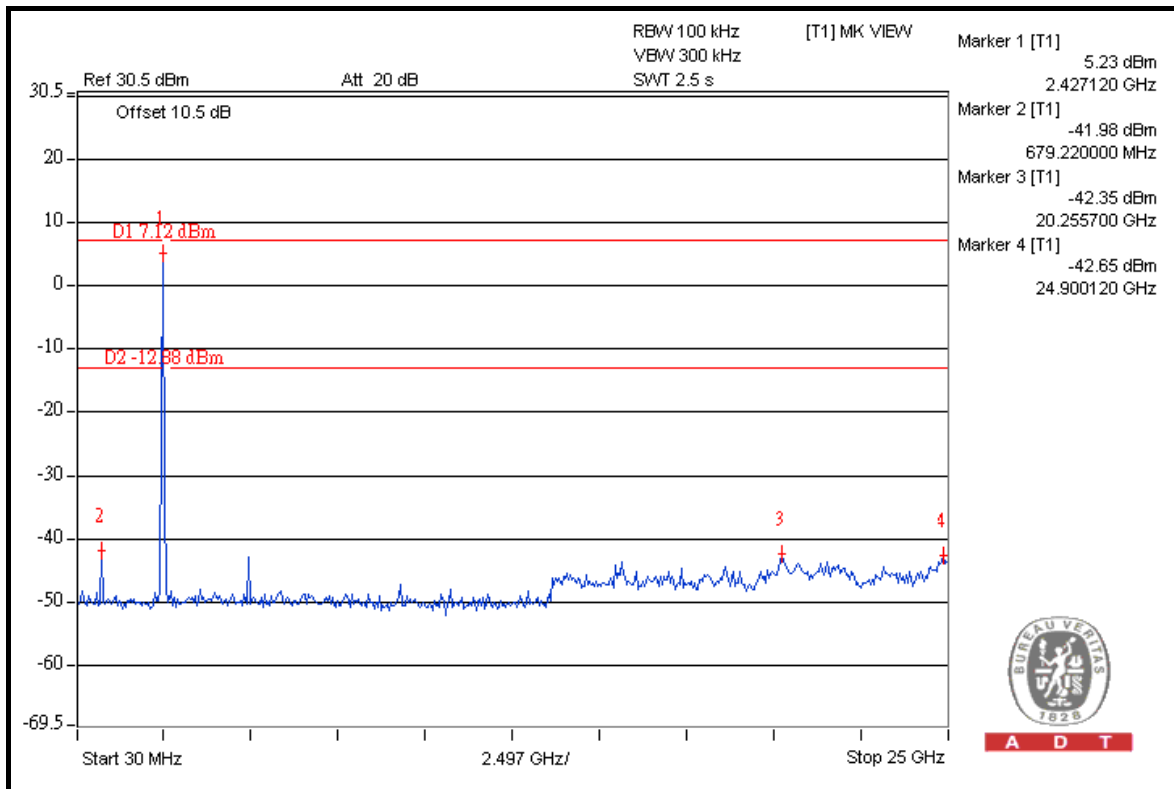
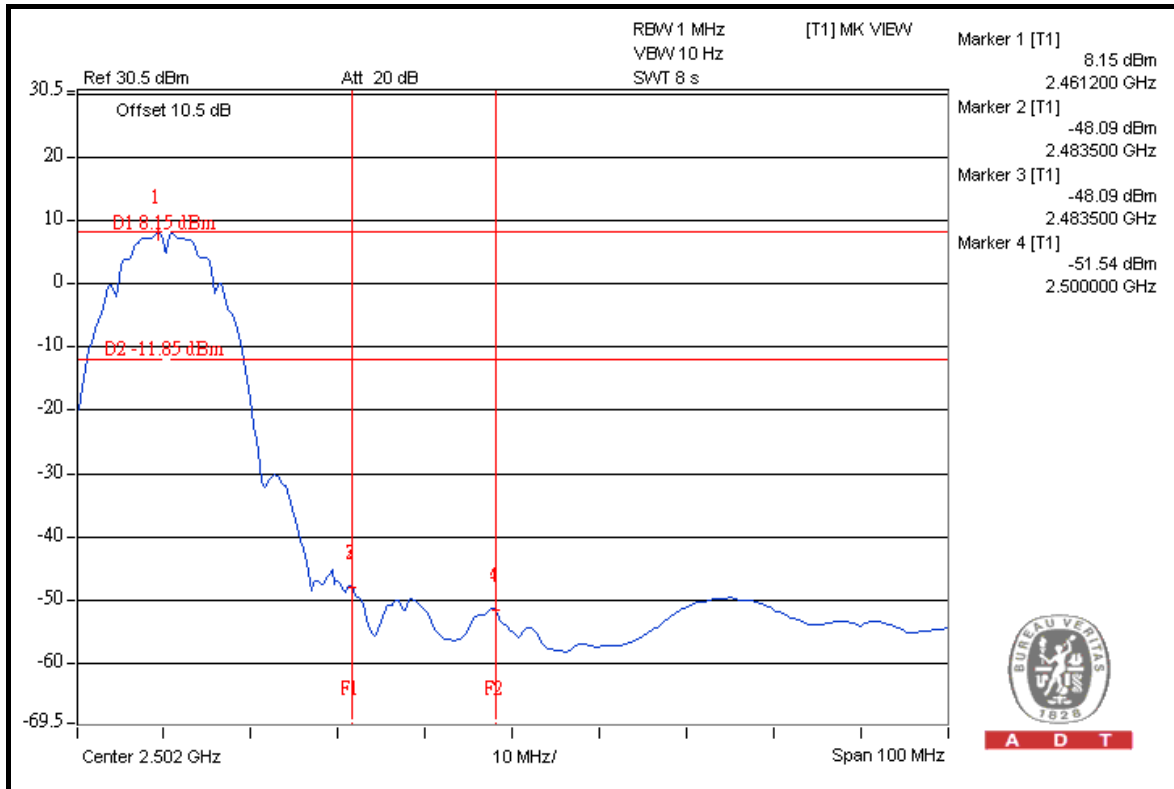



A D T

802.11g: 1TX

TEST MODE A1

RESTRICT BAND (2310 ~ 2390 MHz)

FREQUENCY (MHz)	FUNDAMENTAL EMISSION (dBuV/m)	DELTA (dB)	MAXIMUM FIELD STRENGTH IN RESTRICT BAND (dBuV/m)	LIMIT (dBuV/m)
2412.00 (PK)	105.9	46.10	59.80	74.00
2412.00 (AV)	95.4	52.30	43.10	54.00

RESTRICT BAND (2483.5 ~ 2500 MHz)

FREQUENCY (MHz)	FUNDAMENTAL EMISSION (dBuV/m)	DELTA (dB)	MAXIMUM FIELD STRENGTH IN RESTRICT BAND (dBuV/m)	LIMIT (dBuV/m)
2462.00 (PK)	105.6	44.42	61.18	74.00
2462.00 (AV)	95.9	52.05	43.85	54.00

TEST MODE A2

RESTRICT BAND (2310 ~ 2390 MHz)

FREQUENCY (MHz)	FUNDAMENTAL EMISSION (dBuV/m)	DELTA (dB)	MAXIMUM FIELD STRENGTH IN RESTRICT BAND (dBuV/m)	LIMIT (dBuV/m)
2412.00 (PK)	108.1	46.10	62.0	74.00
2412.00 (AV)	97.5	52.30	45.2	54.00

RESTRICT BAND (2483.5 ~ 2500 MHz)

FREQUENCY (MHz)	FUNDAMENTAL EMISSION (dBuV/m)	DELTA (dB)	MAXIMUM FIELD STRENGTH IN RESTRICT BAND (dBuV/m)	LIMIT (dBuV/m)
2462.00 (PK)	107.7	44.42	63.28	74.00
2462.00 (AV)	98.0	52.05	45.95	54.00

NOTE:

1. Delta = Amplitude between the peak of the fundamental and the peak of the band edge emission. Please check following 3 pages.
2. Maximum field strength in restrict band = Fundamental emission – Delta.



A D T

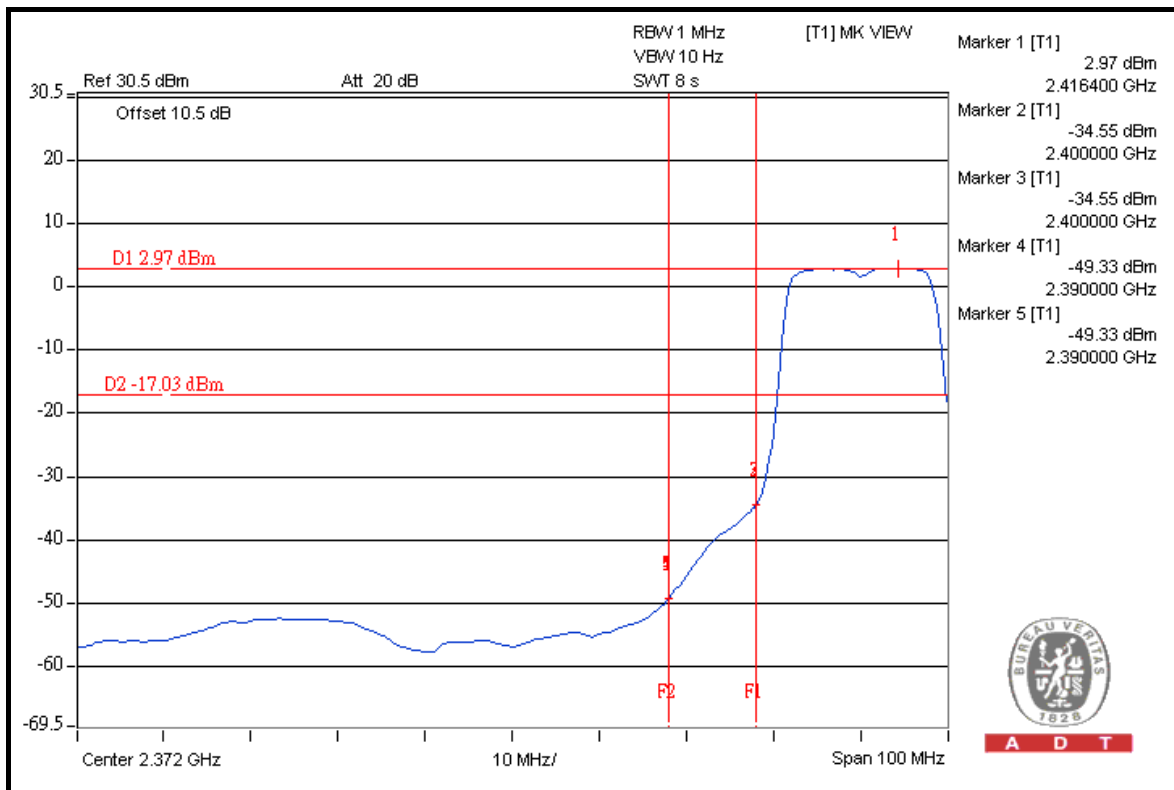
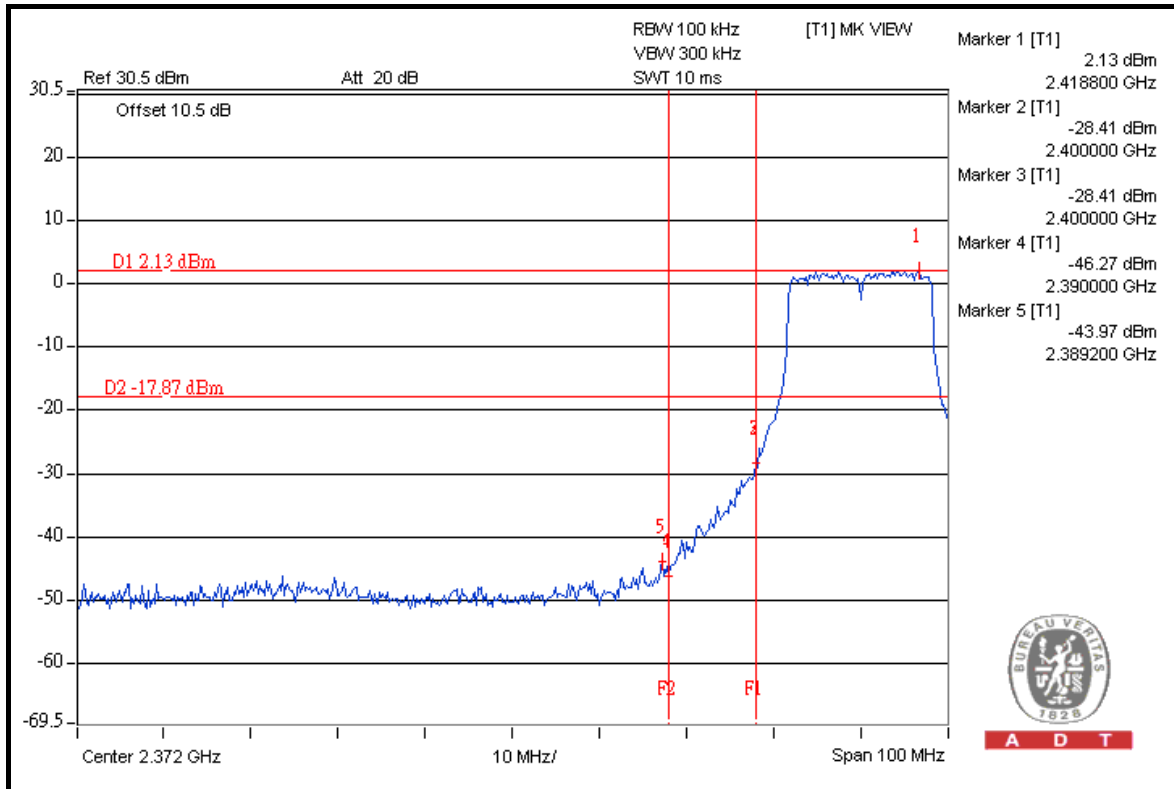



A D T

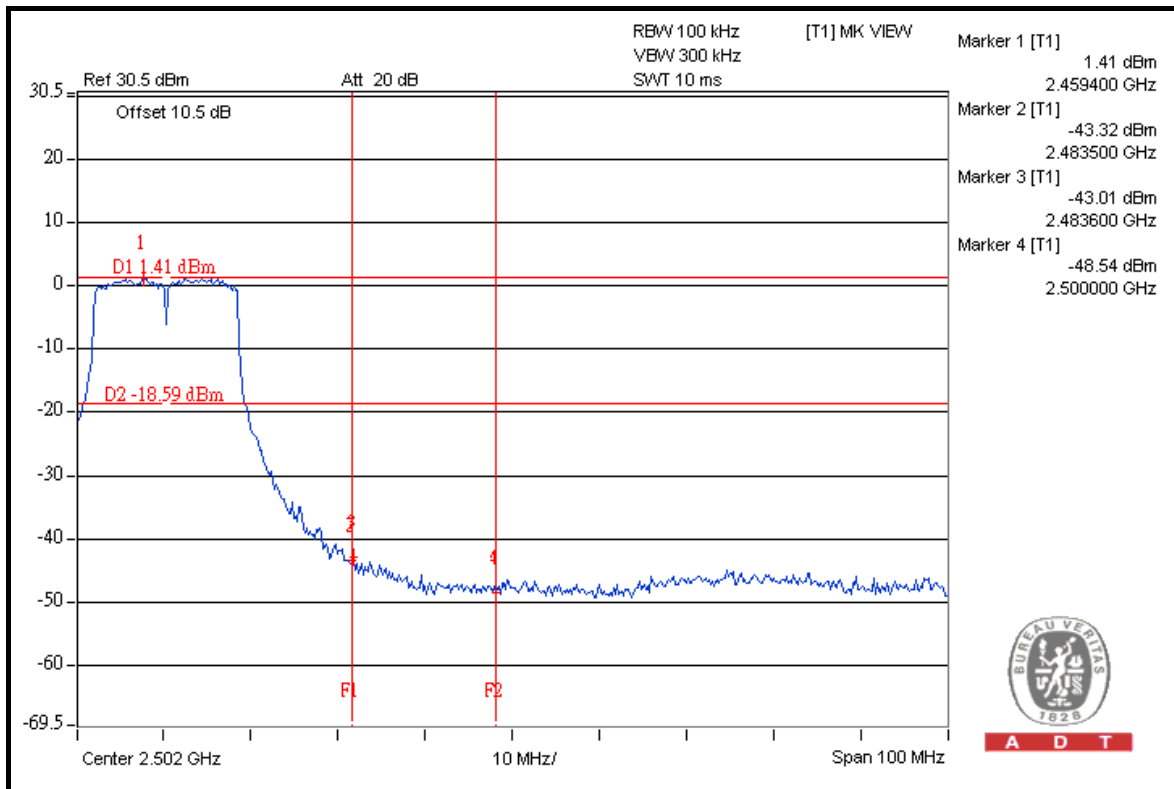
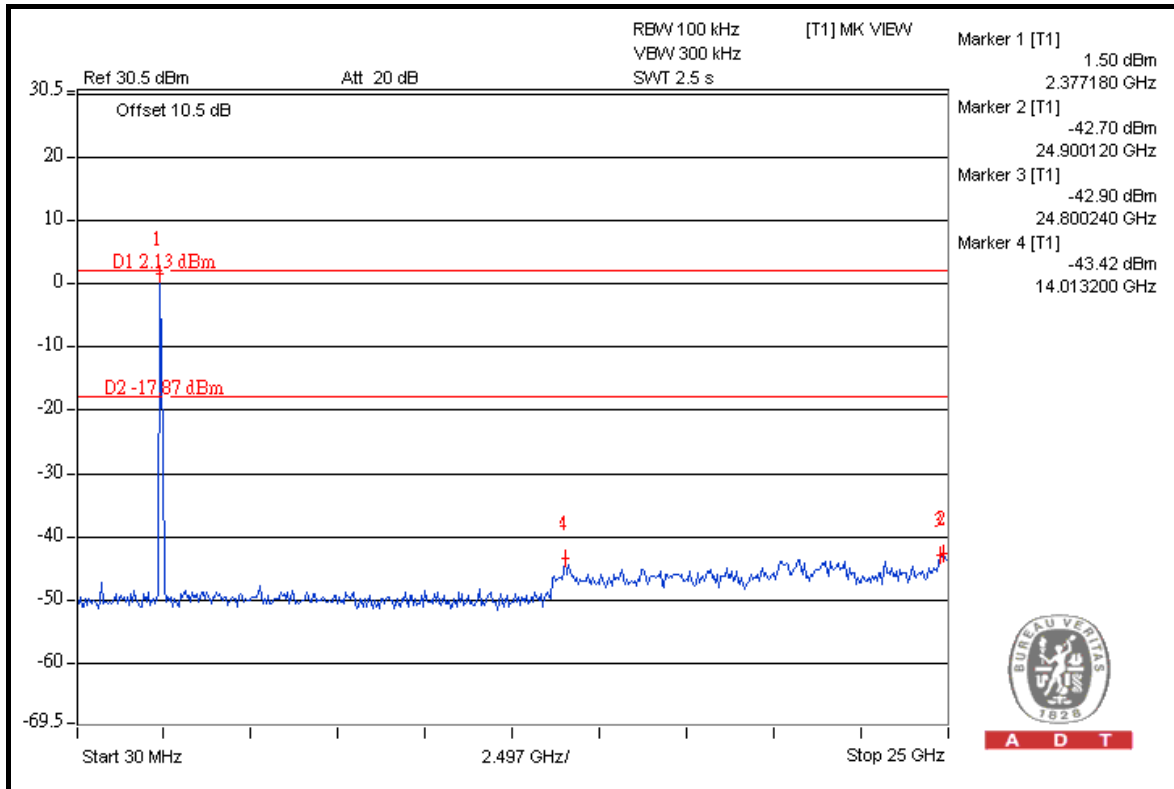



A D T

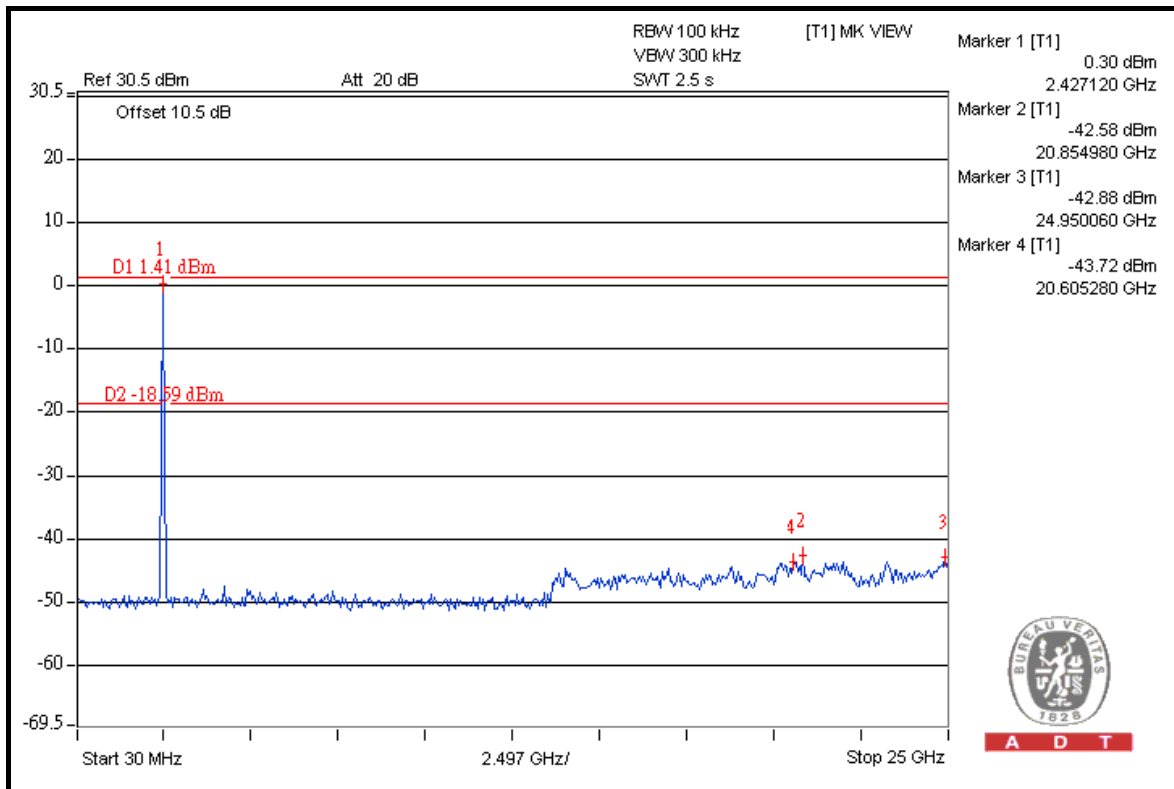
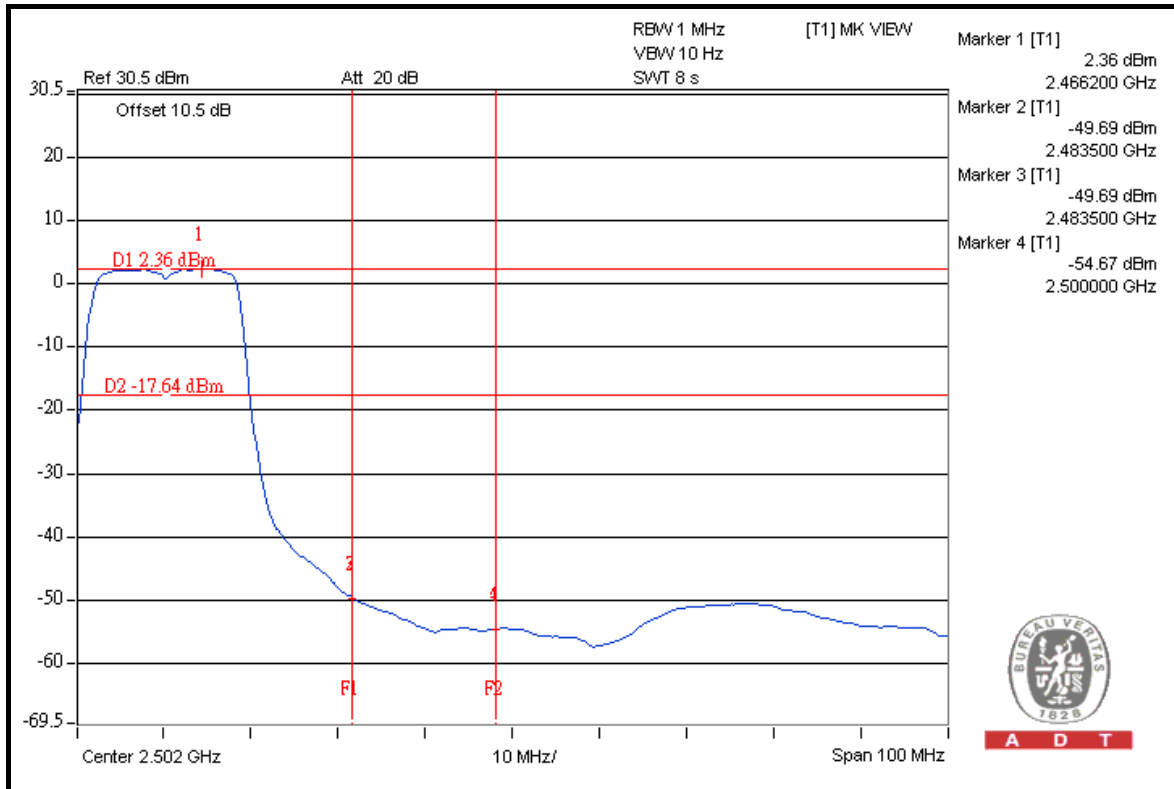



A D T

802.11n (20MHz): 1TX

TEST MODE A1

RESTRICT BAND (2310 ~ 2390 MHz)

FREQUENCY (MHz)	FUNDAMENTAL EMISSION (dBuV/m)	DELTA (dB)	MAXIMUM FIELD STRENGTH IN RESTRICT BAND (dBuV/m)	LIMIT (dBuV/m)
2412.00 (PK)	105.0	45.19	59.81	74.00
2412.00 (AV)	94.8	50.59	44.21	54.00

RESTRICT BAND (2483.5 ~ 2500 MHz)

FREQUENCY (MHz)	FUNDAMENTAL EMISSION (dBuV/m)	DELTA (dB)	MAXIMUM FIELD STRENGTH IN RESTRICT BAND (dBuV/m)	LIMIT (dBuV/m)
2462.00 (PK)	105.2	45.20	60.00	74.00
2462.00 (AV)	94.1	50.80	43.30	54.00

TEST MODE A2

RESTRICT BAND (2310 ~ 2390 MHz)

FREQUENCY (MHz)	FUNDAMENTAL EMISSION (dBuV/m)	DELTA (dB)	MAXIMUM FIELD STRENGTH IN RESTRICT BAND (dBuV/m)	LIMIT (dBuV/m)
2412.00 (PK)	107.0	45.19	61.81	74.00
2412.00 (AV)	96.7	50.59	46.11	54.00

RESTRICT BAND (2483.5 ~ 2500 MHz)

FREQUENCY (MHz)	FUNDAMENTAL EMISSION (dBuV/m)	DELTA (dB)	MAXIMUM FIELD STRENGTH IN RESTRICT BAND (dBuV/m)	LIMIT (dBuV/m)
2462.00 (PK)	107.4	45.20	62.20	74.00
2462.00 (AV)	96.2	50.80	45.40	54.00

NOTE:

1. Delta = Amplitude between the peak of the fundamental and the peak of the band edge emission. Please check following 3 pages.
2. Maximum field strength in restrict band = Fundamental emission – Delta.



A D T

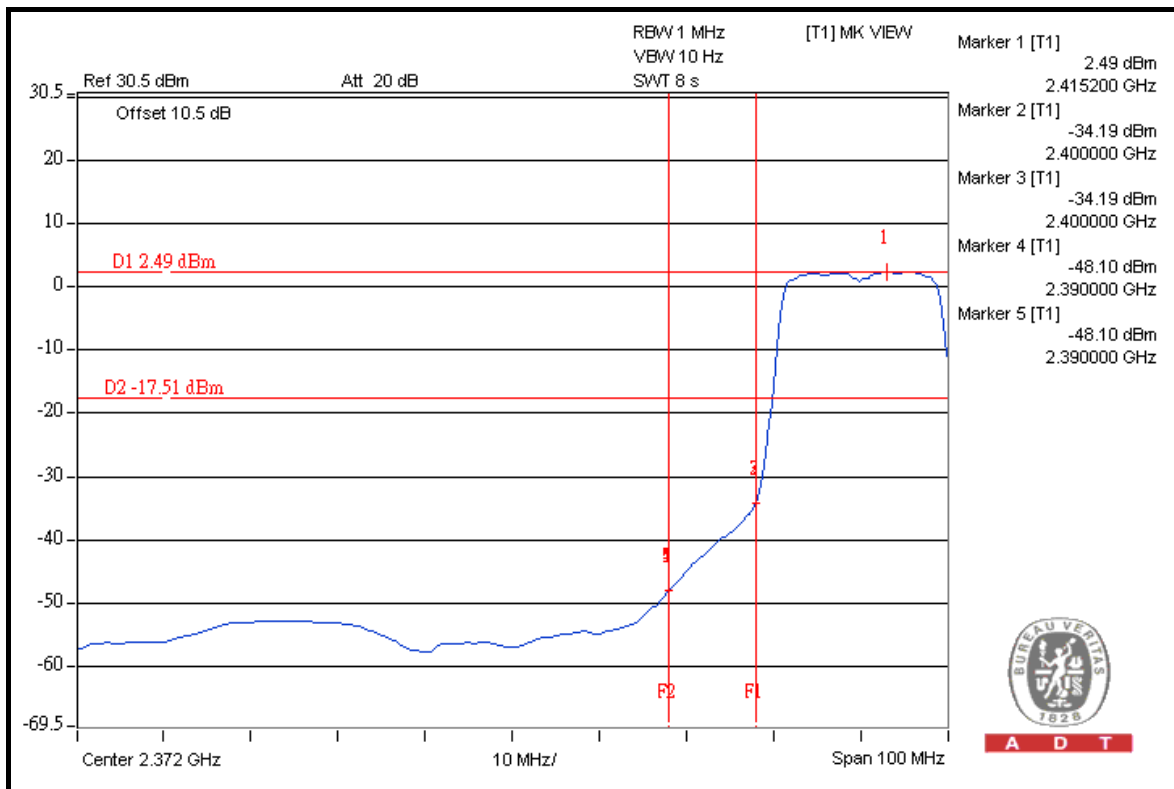
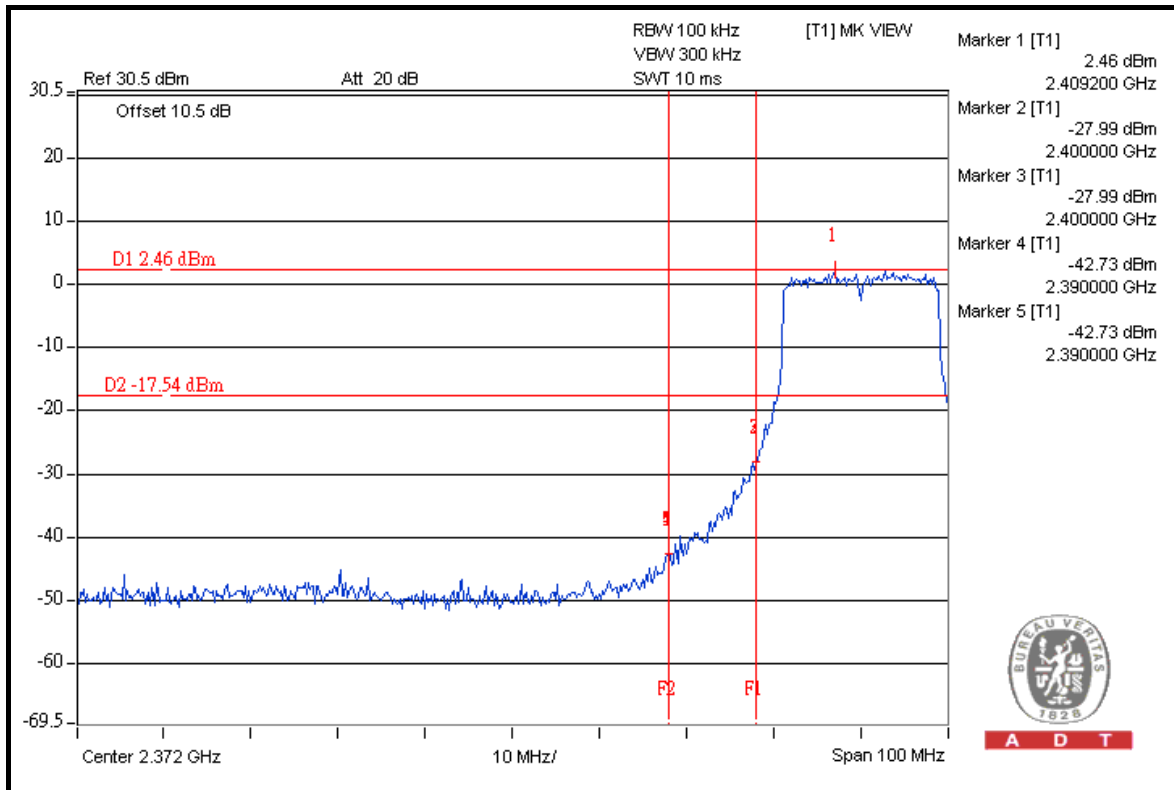



A D T

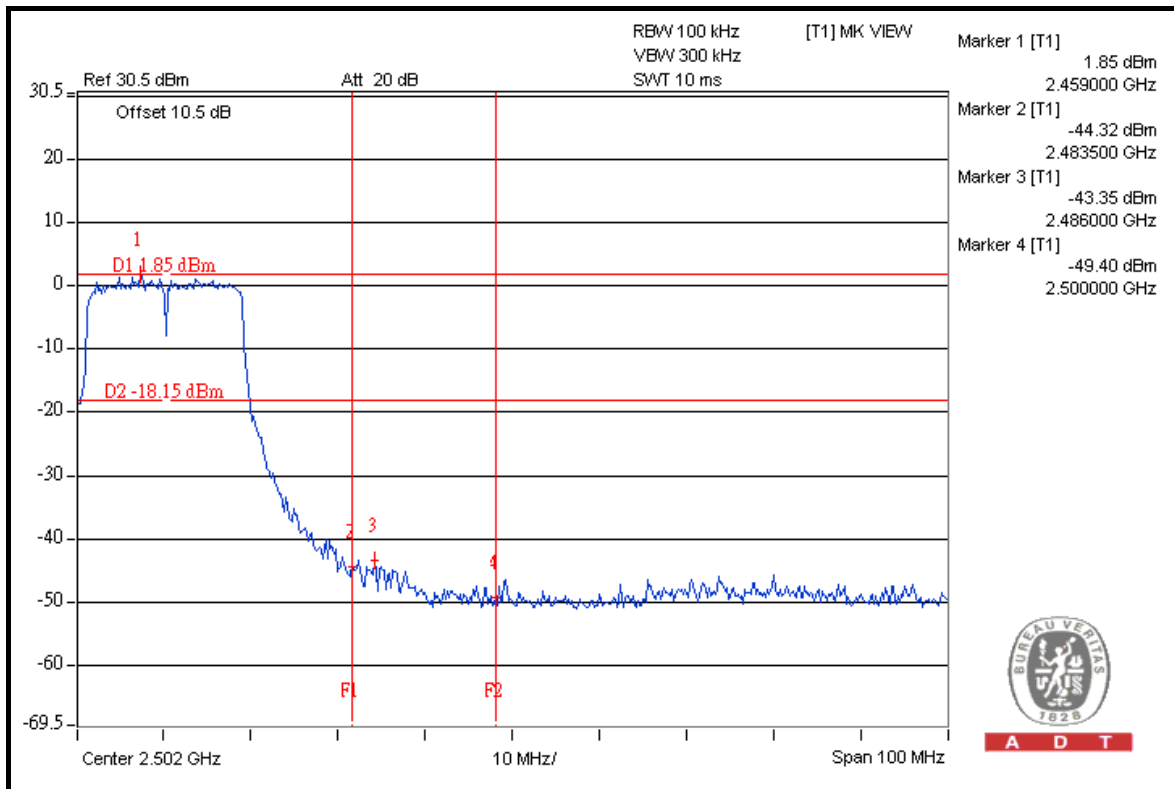
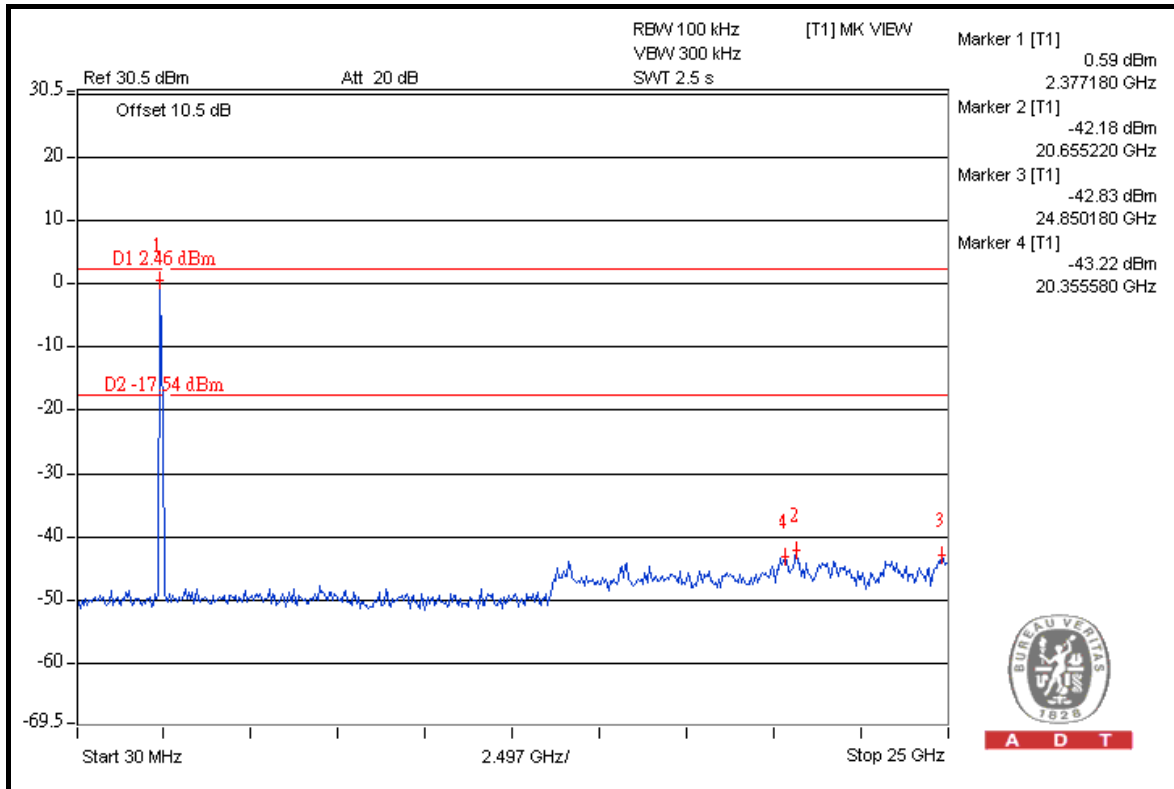



A D T

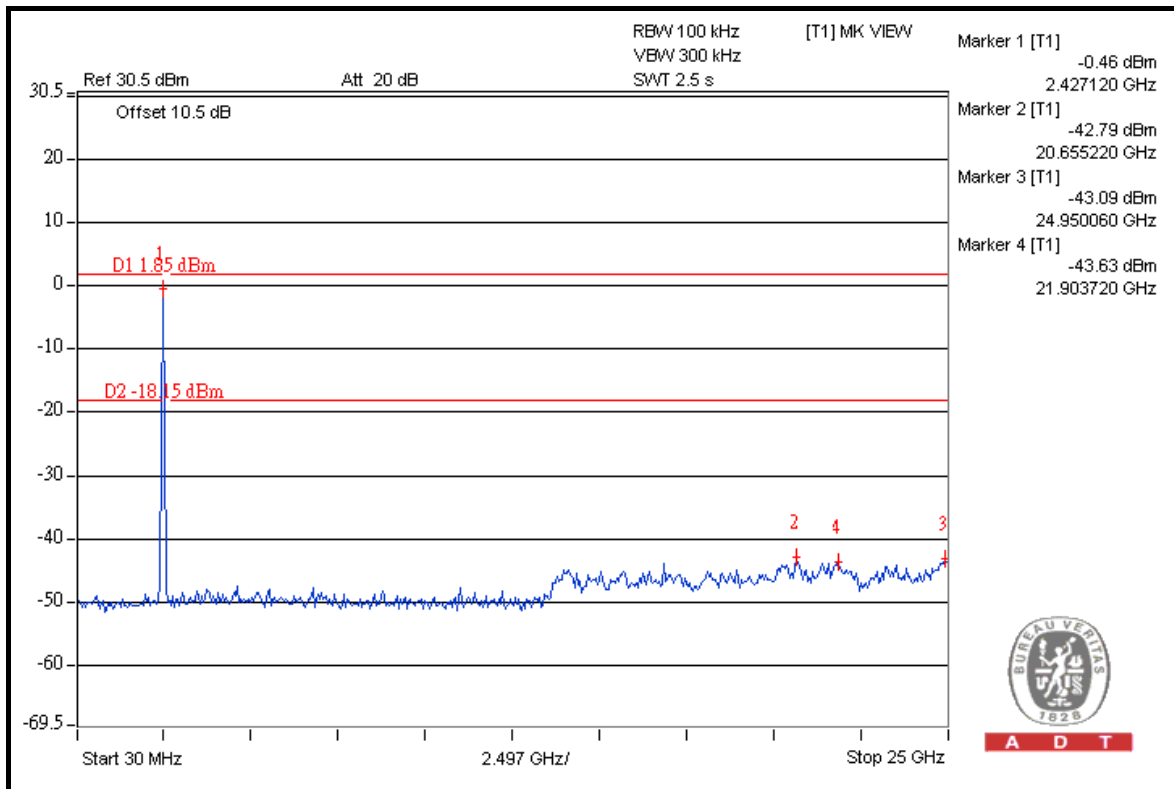
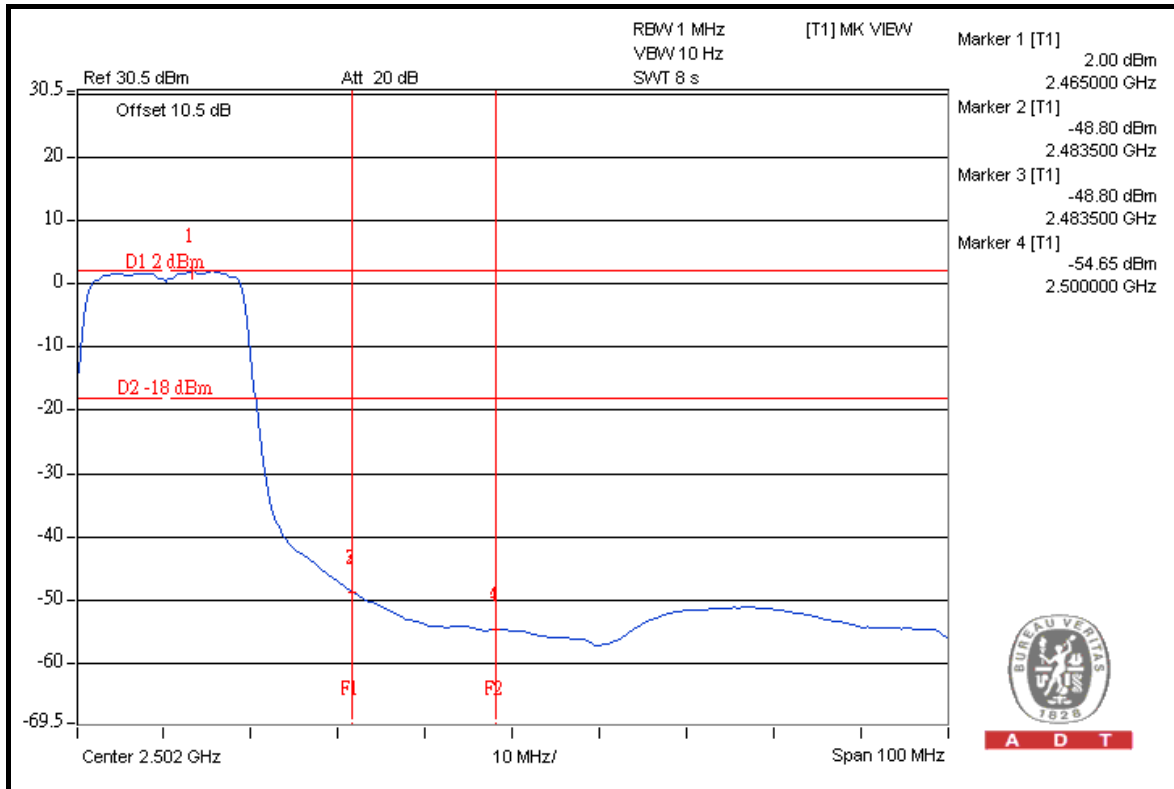



A D T

802.11n (20MHz): 2TX

TEST MODE A1

RESTRICT BAND (2310 ~ 2390 MHz)

FREQUENCY (MHz)	FUNDAMENTAL EMISSION (dBuV/m)	DELTA (dB)	MAXIMUM FIELD STRENGTH IN RESTRICT BAND (dBuV/m)	LIMIT (dBuV/m)
2412.00 (PK)	110.5	41.90	68.60	74.00
2412.00 (AV)	98.6	45.60	53.00	54.00

RESTRICT BAND (2483.5 ~ 2500 MHz)

FREQUENCY (MHz)	FUNDAMENTAL EMISSION (dBuV/m)	DELTA (dB)	MAXIMUM FIELD STRENGTH IN RESTRICT BAND (dBuV/m)	LIMIT (dBuV/m)
2462.00 (PK)	108.3	41.47	66.56	74.00
2462.00 (AV)	96.9	47.28	49.62	54.00



A D T

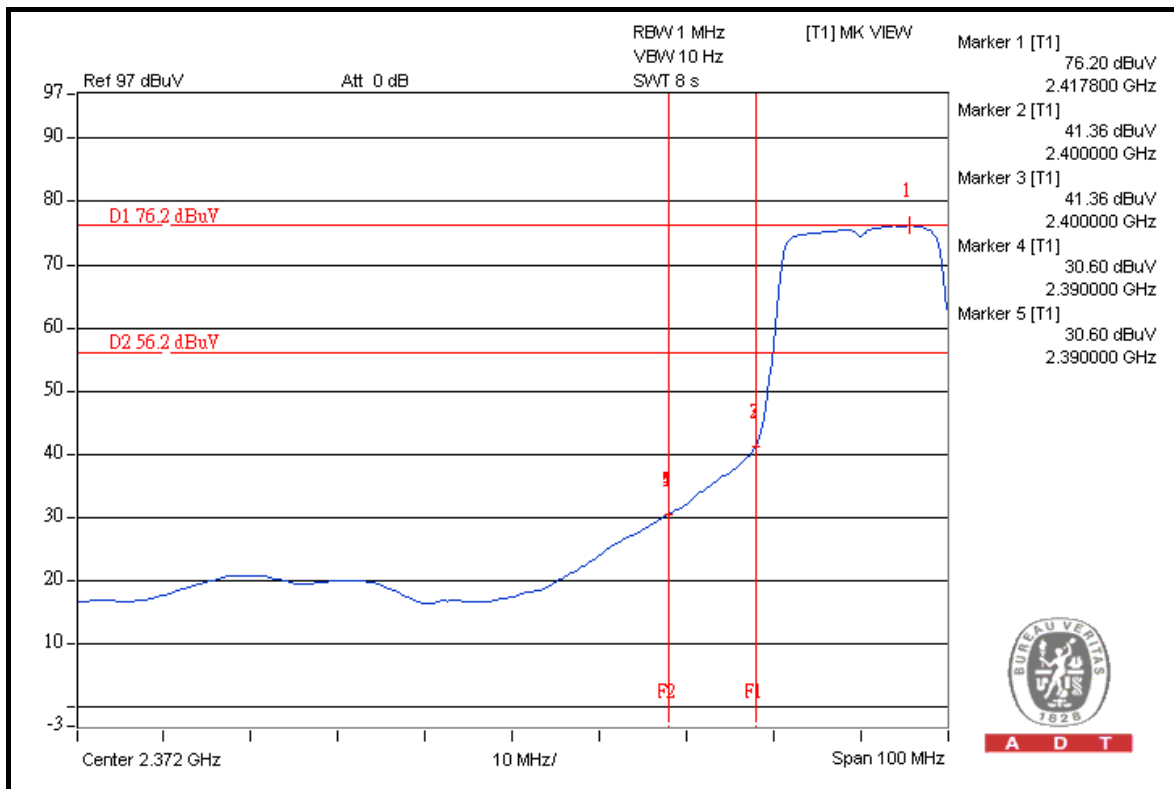
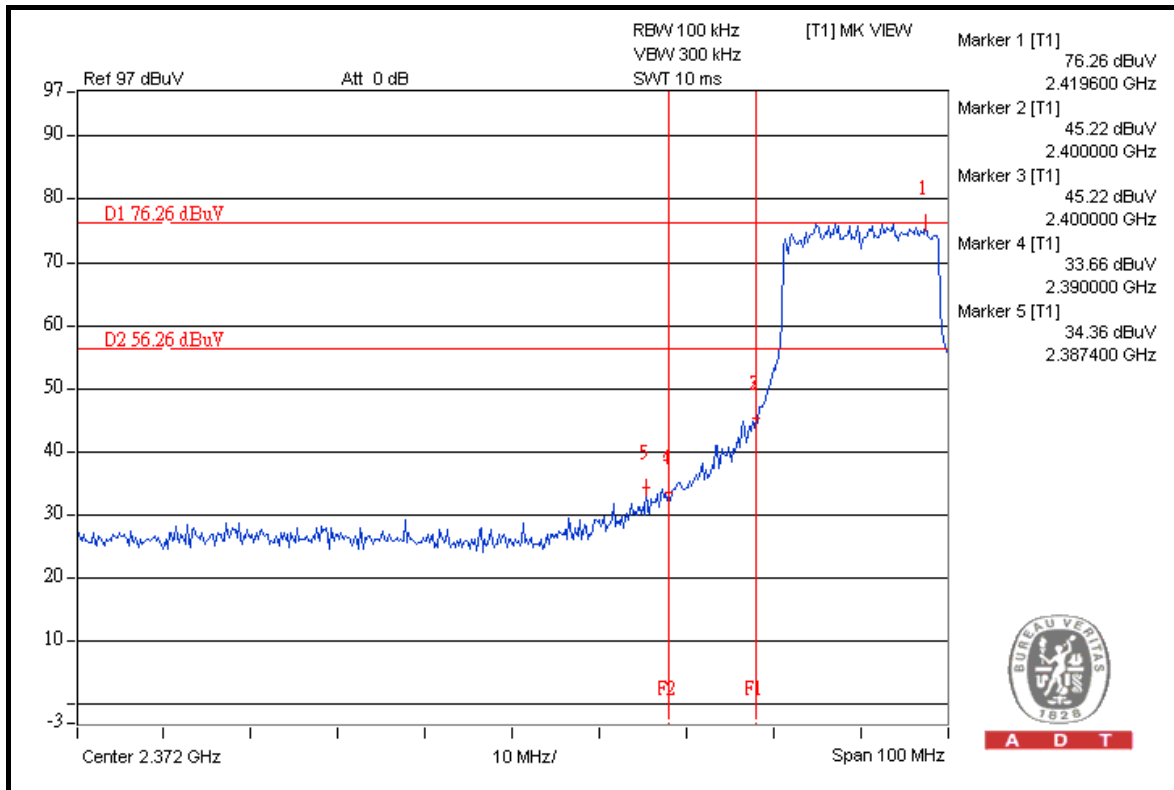



A D T

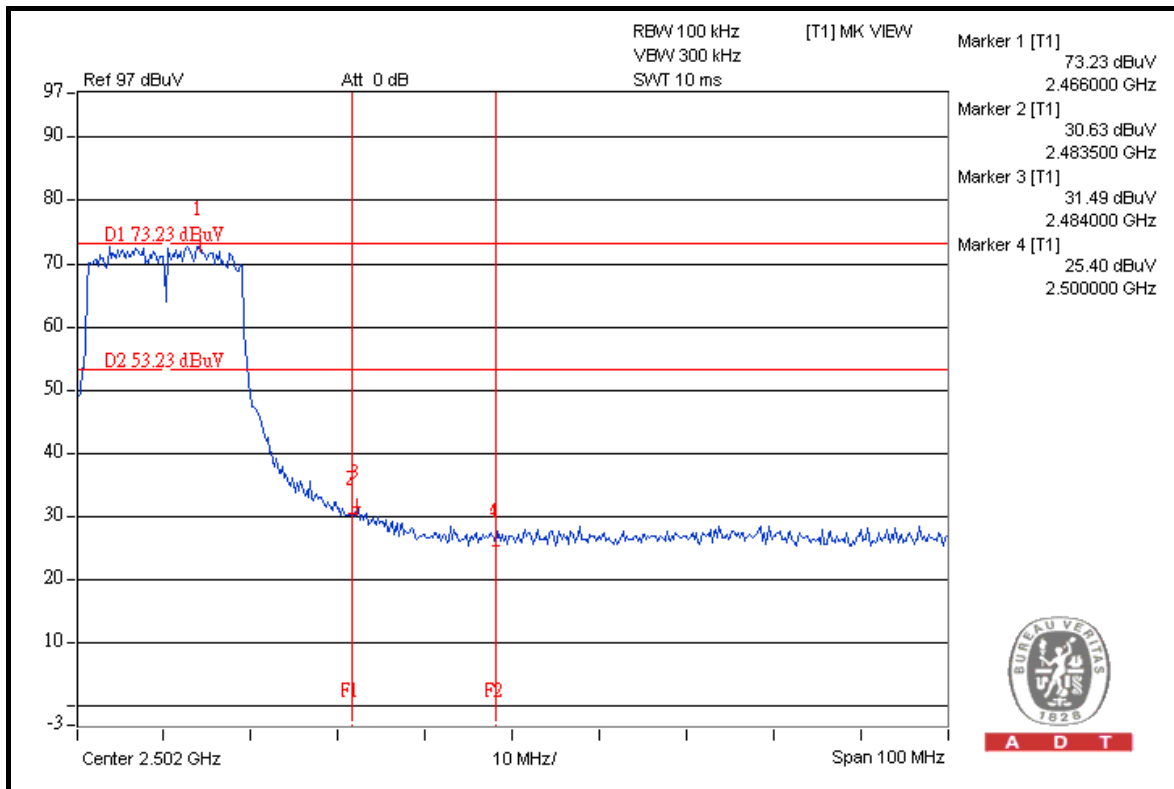
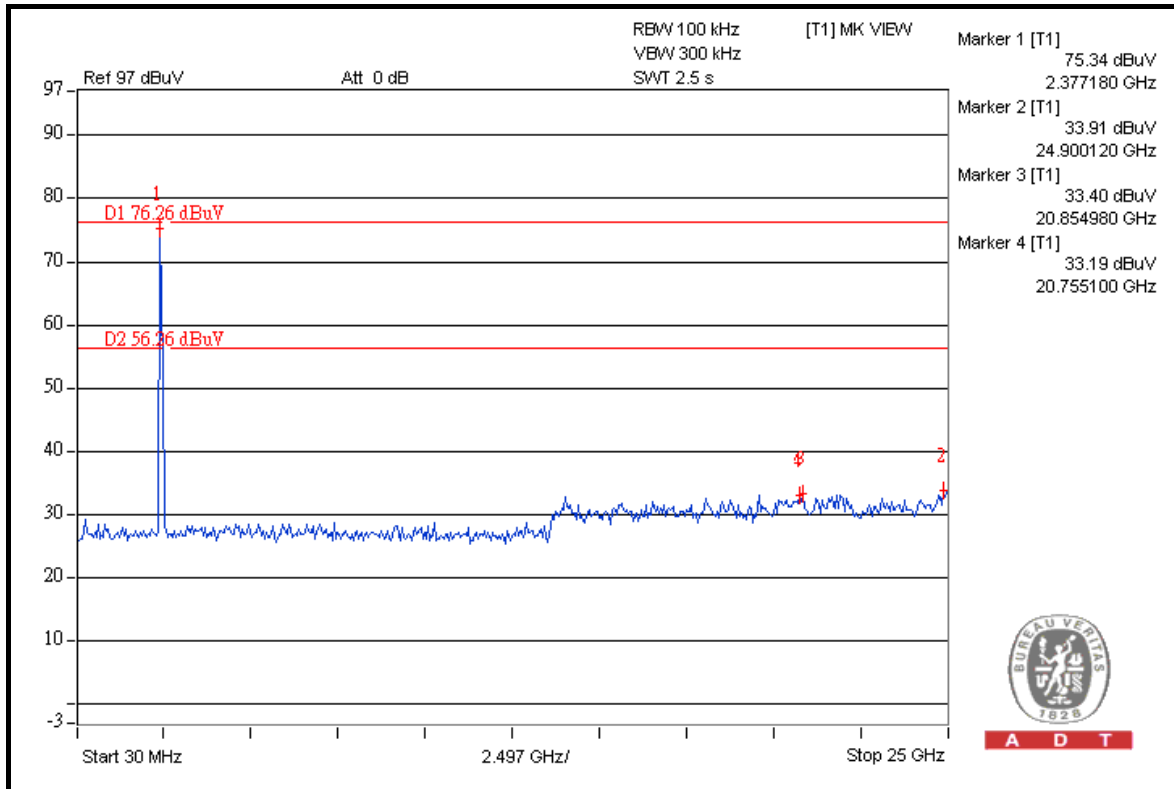



A D T

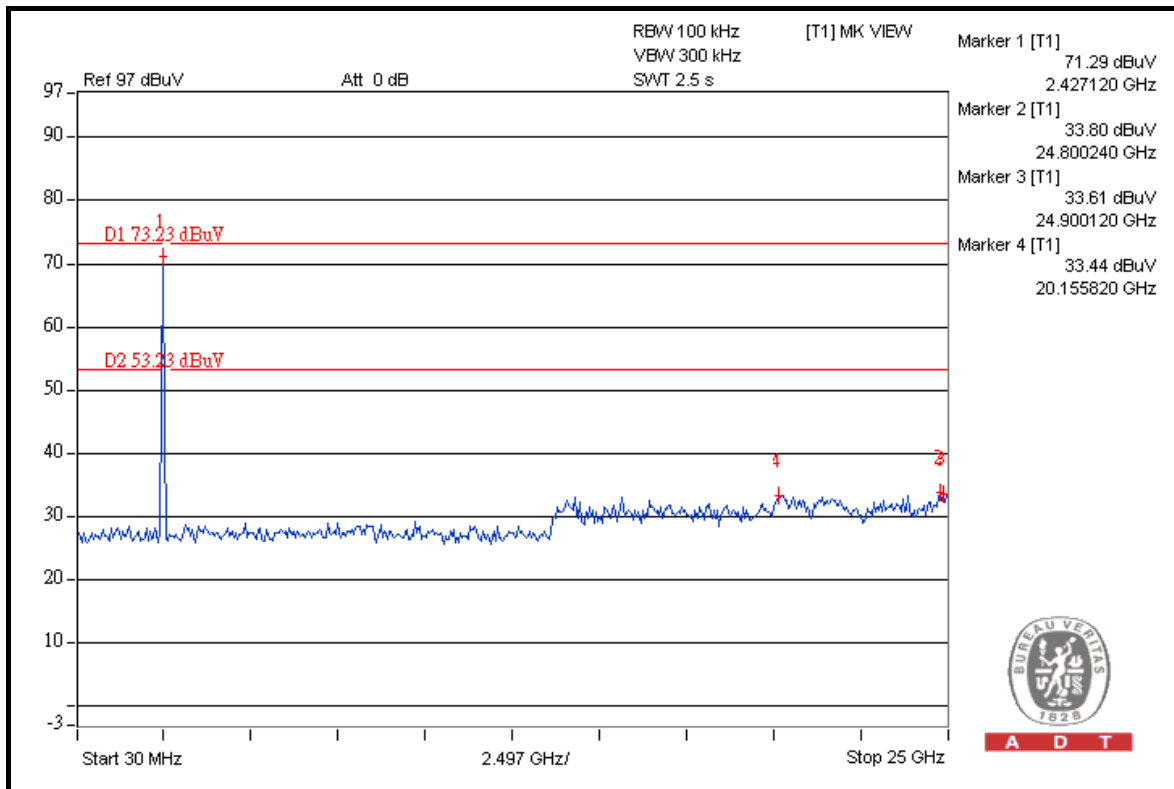
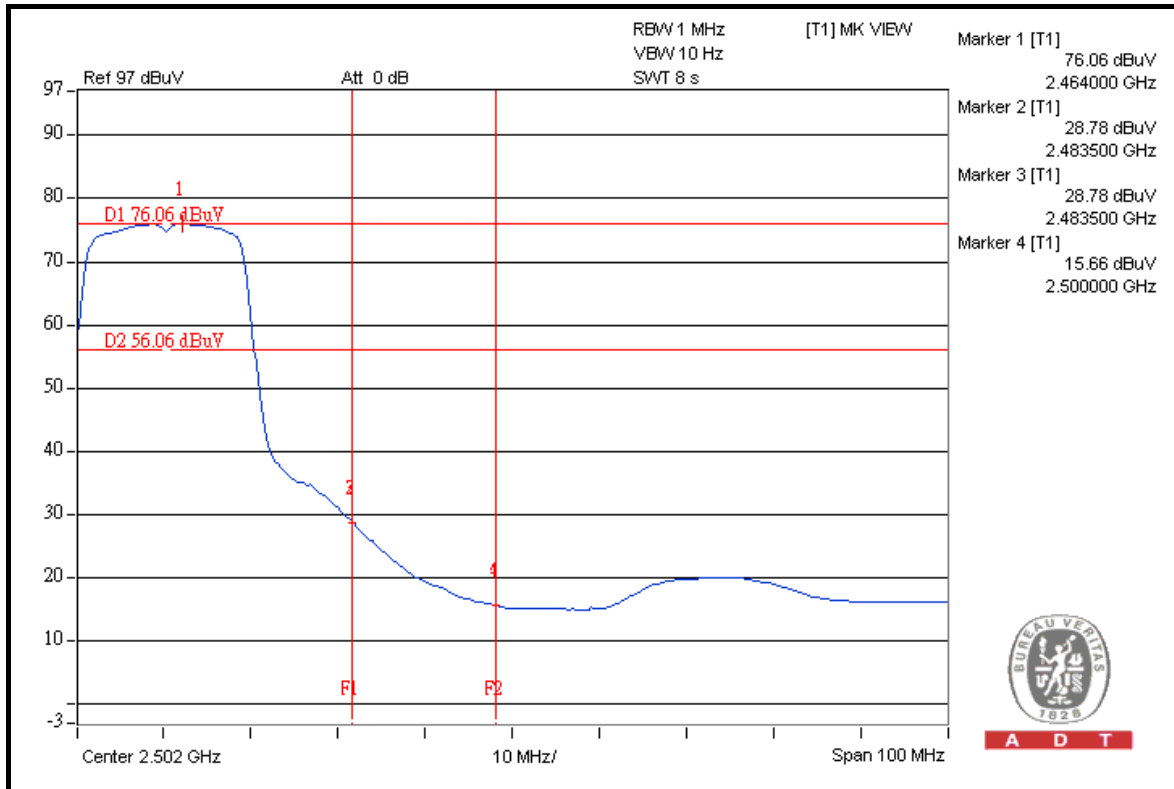



A D T

TEST MODE A2

RESTRICT BAND (2310 ~ 2390 MHz)

FREQUENCY (MHz)	FUNDAMENTAL EMISSION (dBuV/m)	DELTA (dB)	MAXIMUM FIELD STRENGTH IN RESTRICT BAND (dBuV/m)	LIMIT (dBuV/m)
2412.00 (PK)	110.0	45.24	64.76	74.00
2412.00 (AV)	98.2	46.31	51.89	54.00

RESTRICT BAND (2483.5 ~ 2500 MHz)

FREQUENCY (MHz)	FUNDAMENTAL EMISSION (dBuV/m)	DELTA (dB)	MAXIMUM FIELD STRENGTH IN RESTRICT BAND (dBuV/m)	LIMIT (dBuV/m)
2462.00 (PK)	108.0	40.23	67.77	74.00
2462.00 (AV)	96.5	42.57	53.93	54.00

NOTE:

1. Delta = Amplitude between the peak of the fundamental and the peak of the band edge emission. Please check following 3 pages.
2. Maximum field strength in restrict band = Fundamental emission – Delta.



A D T

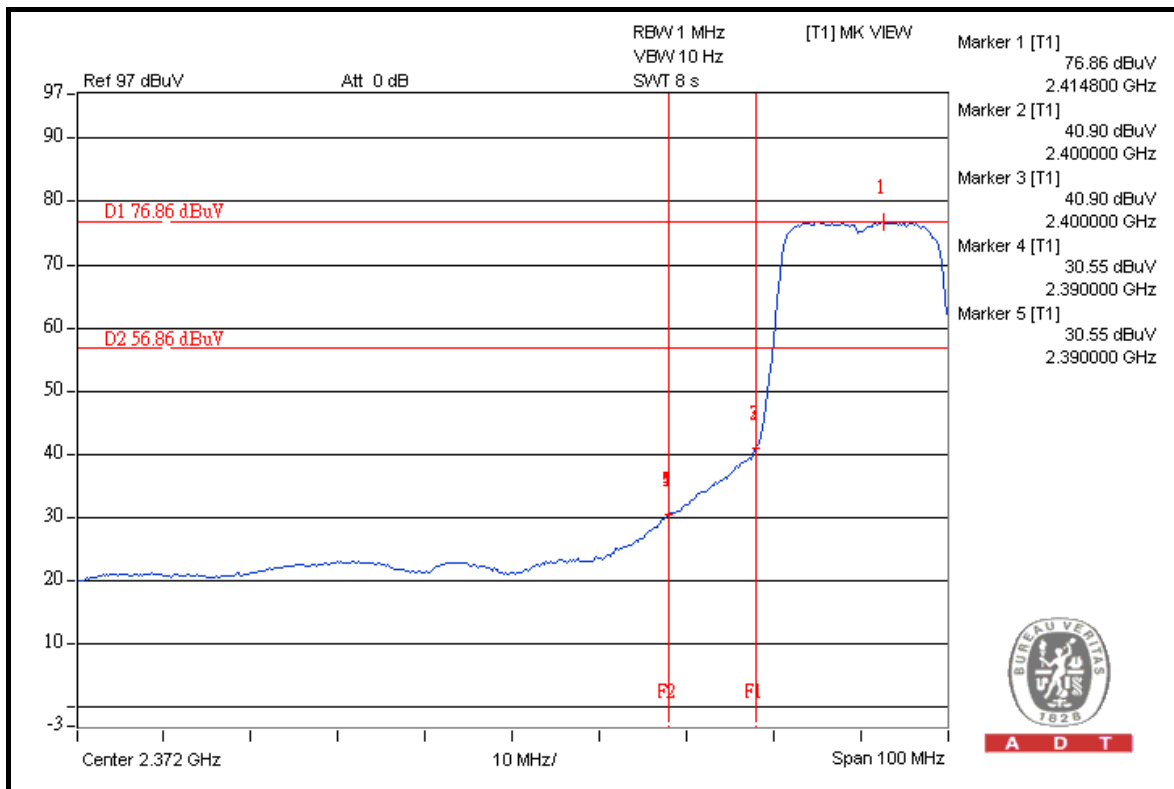
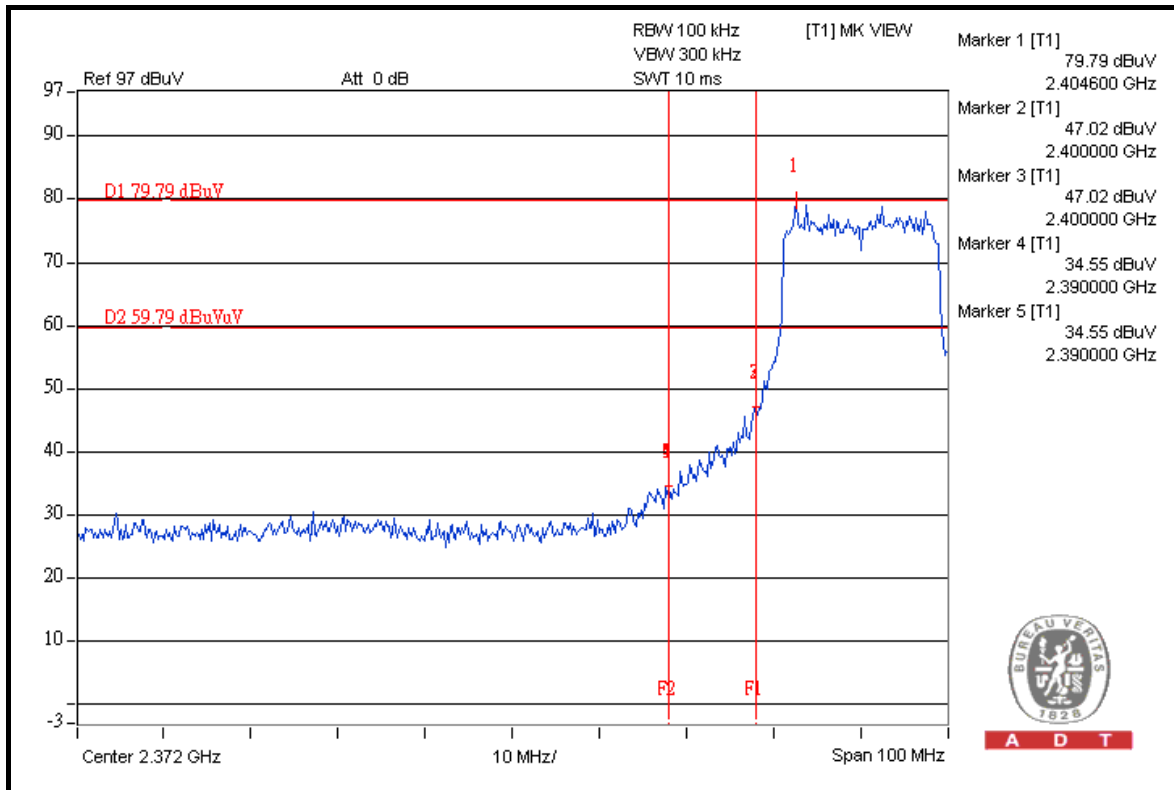



A D T

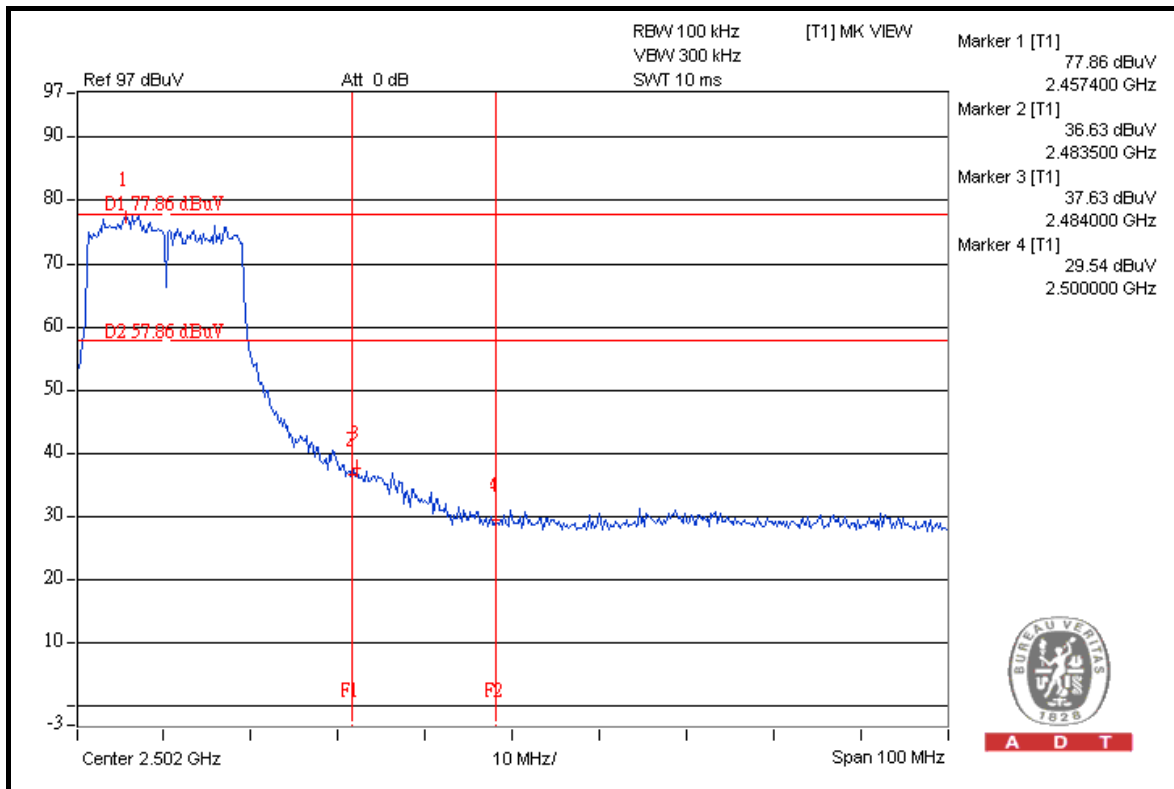
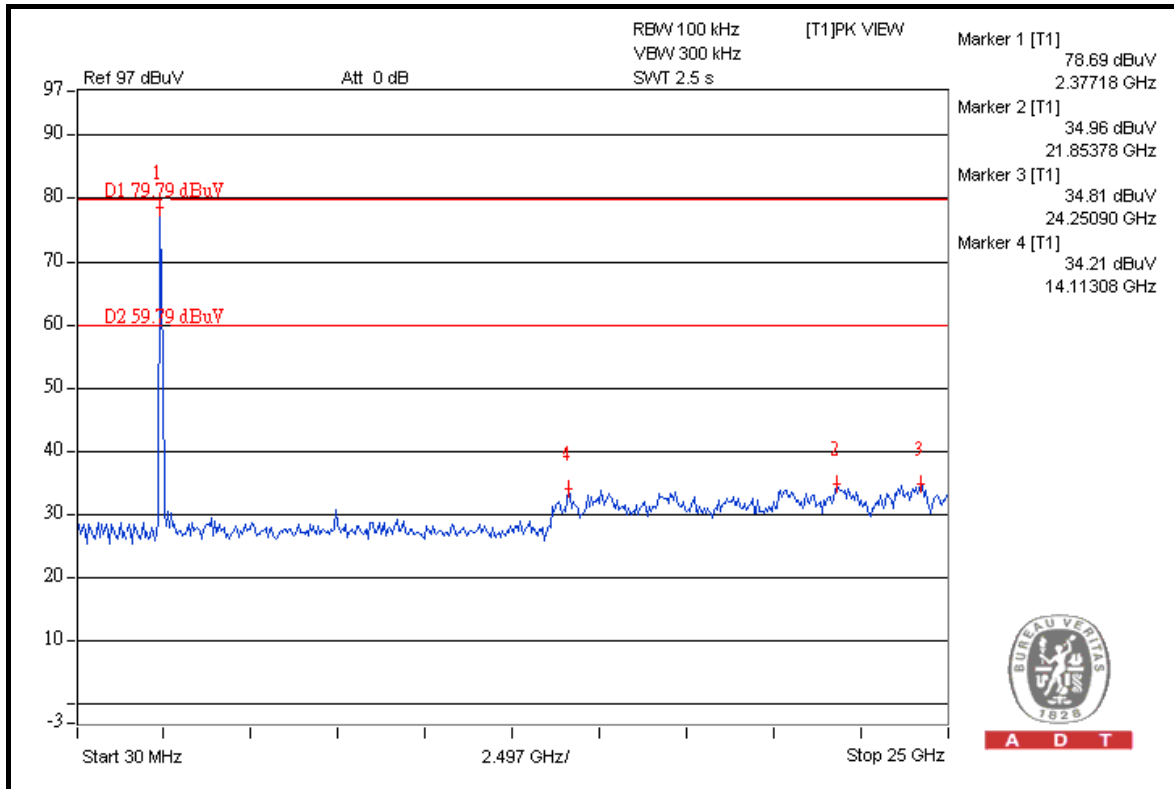



A D T

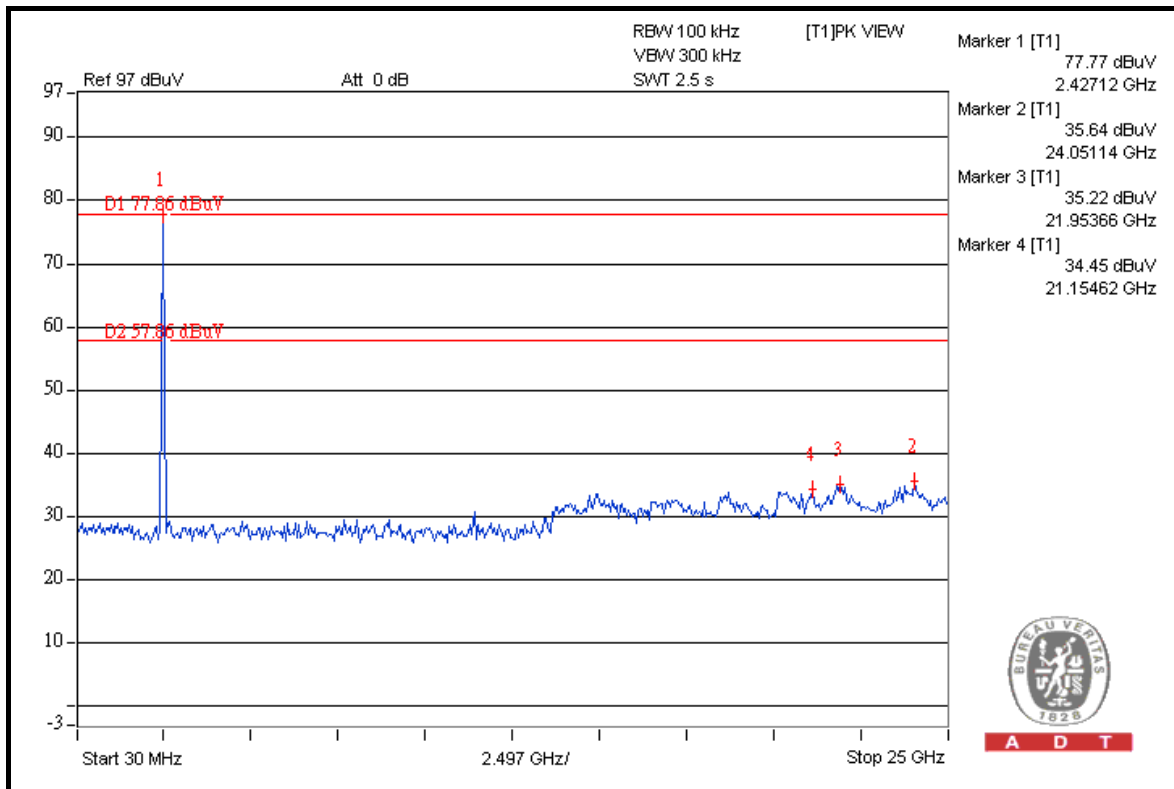
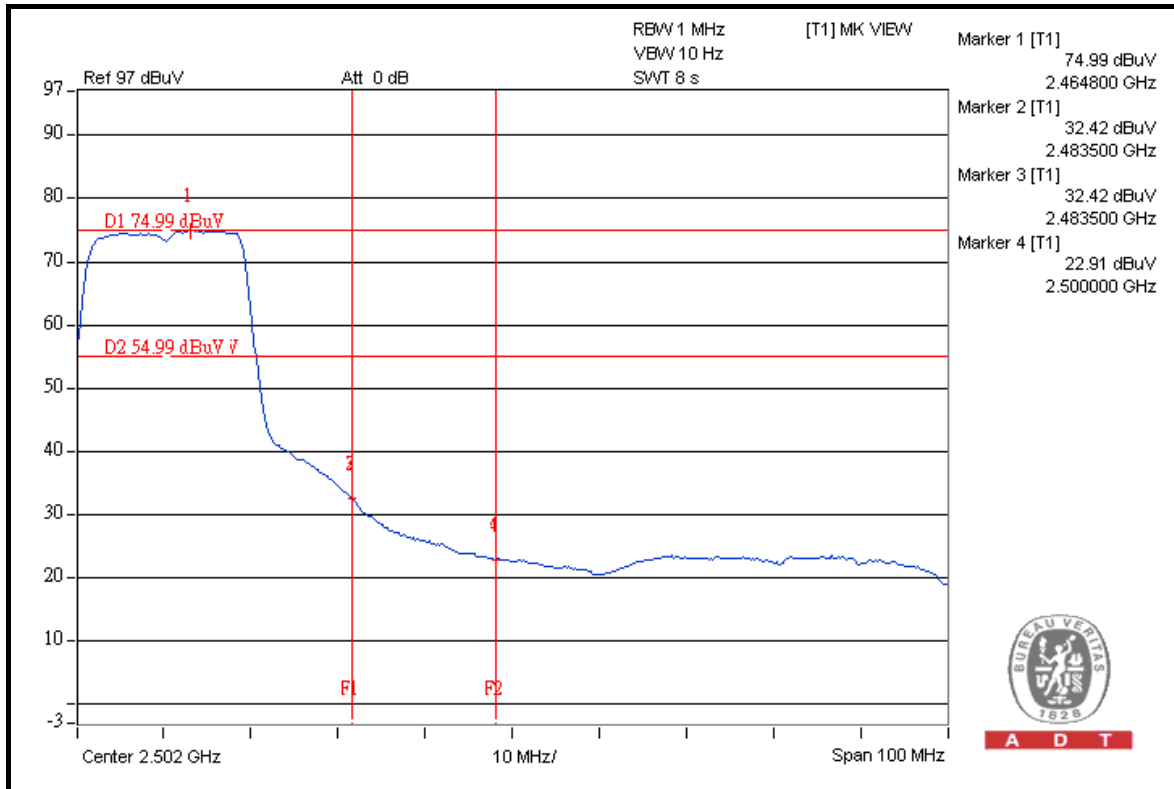



A D T

**802.11n (40MHz): 1TX
TEST MODE A1**

RESTRICT BAND (2310 ~ 2390 MHz)

FREQUENCY (MHz)	FUNDAMENTAL EMISSION (dBuV/m)	DELTA (dB)	MAXIMUM FIELD STRENGTH IN RESTRICT BAND (dBuV/m)	LIMIT (dBuV/m)
2422.00 (PK)	102.0	40.23	61.77	74.00
2422.00 (AV)	91.6	44.41	47.19	54.00

RESTRICT BAND (2483.5 ~ 2500 MHz)

FREQUENCY (MHz)	FUNDAMENTAL EMISSION (dBuV/m)	DELTA (dB)	MAXIMUM FIELD STRENGTH IN RESTRICT BAND (dBuV/m)	LIMIT (dBuV/m)
2452.00 (PK)	101.2	36.44	64.66	74.00
2452.00 (AV)	90.2	40.03	50.17	54.00

TEST MODE A2

RESTRICT BAND (2310 ~ 2390 MHz)

FREQUENCY (MHz)	FUNDAMENTAL EMISSION (dBuV/m)	DELTA (dB)	MAXIMUM FIELD STRENGTH IN RESTRICT BAND (dBuV/m)	LIMIT (dBuV/m)
2422.00 (PK)	103.7	40.23	63.47	74.00
2422.00 (AV)	93.2	44.41	48.79	54.00

RESTRICT BAND (2483.5 ~ 2500 MHz)

FREQUENCY (MHz)	FUNDAMENTAL EMISSION (dBuV/m)	DELTA (dB)	MAXIMUM FIELD STRENGTH IN RESTRICT BAND (dBuV/m)	LIMIT (dBuV/m)
2452.00 (PK)	102.6	36.44	66.16	74.00
2452.00 (AV)	91.7	40.03	51.67	54.00

NOTE:

1. Delta = Amplitude between the peak of the fundamental and the peak of the band edge emission. Please check following 3 pages.
2. Maximum field strength in restrict band = Fundamental emission – Delta.



A D T

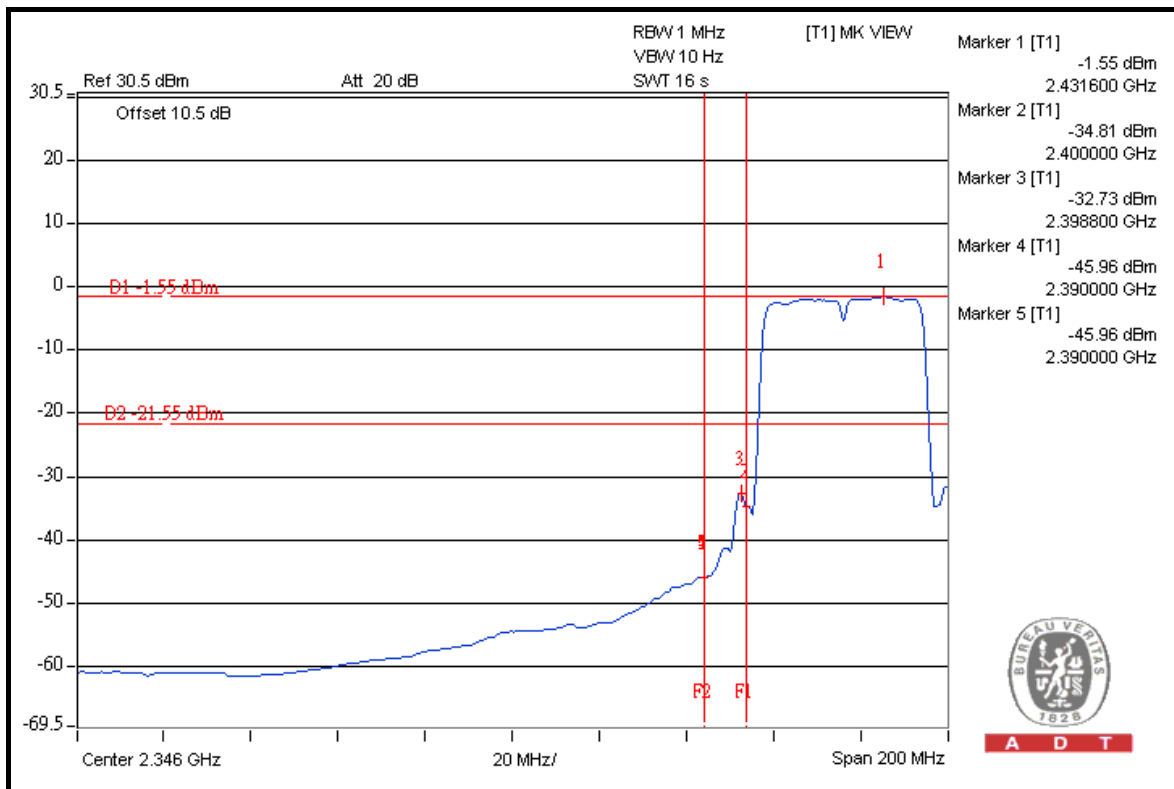
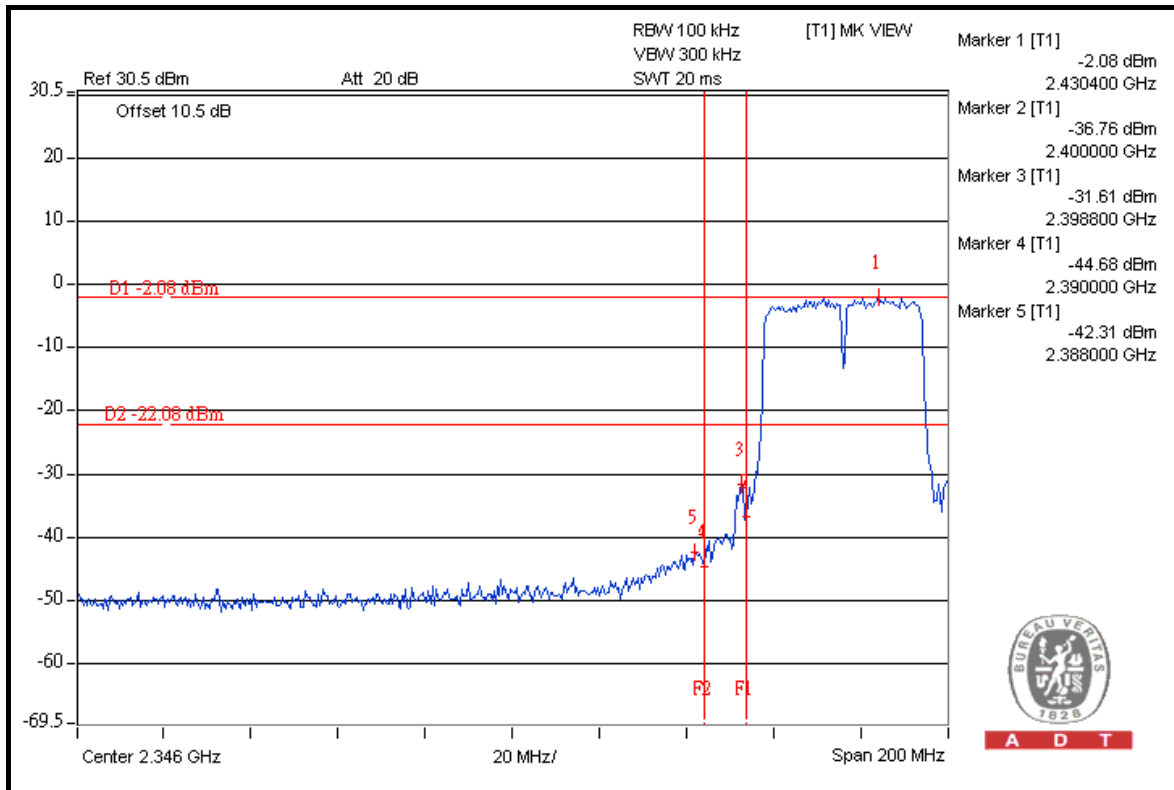



A D T

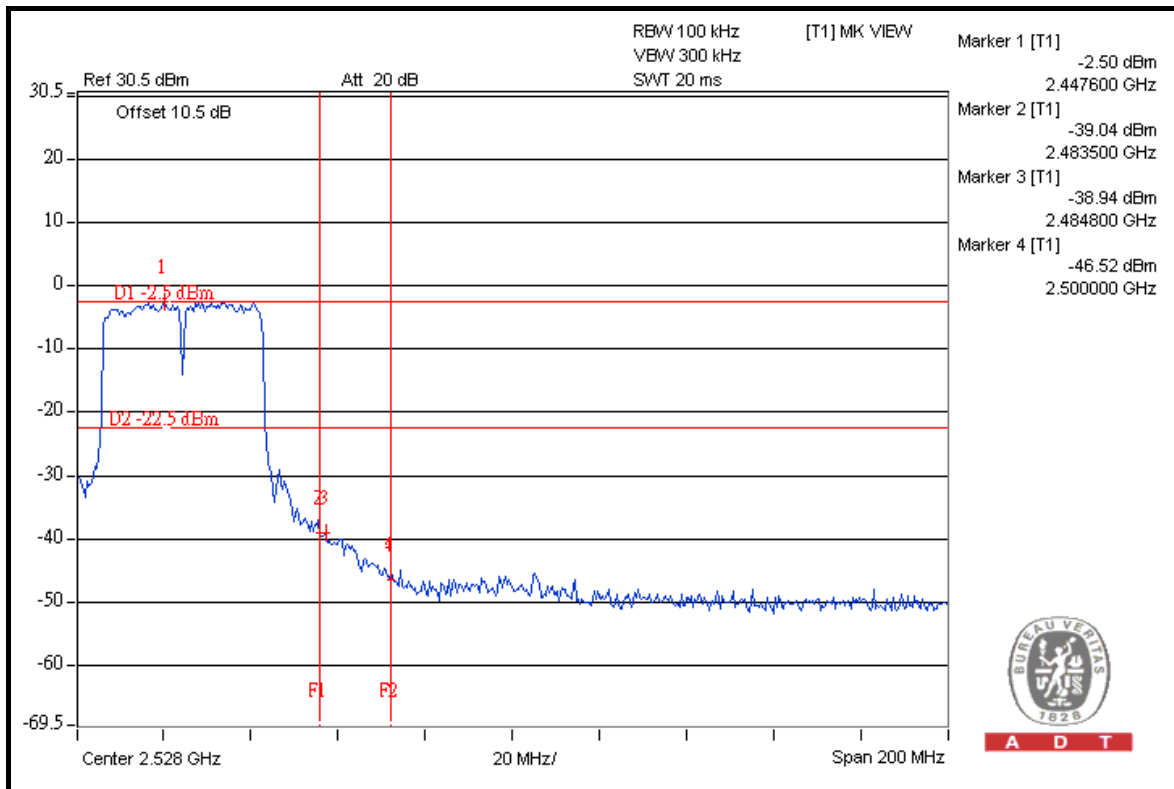
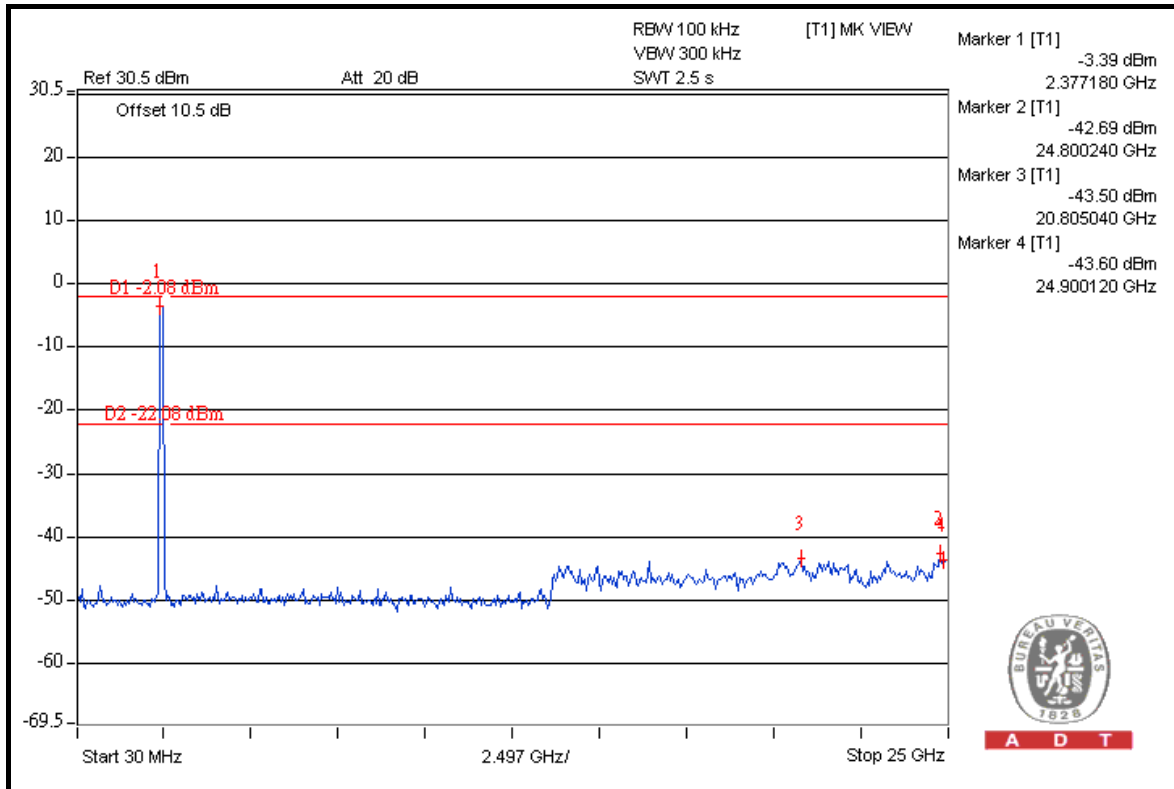



A D T

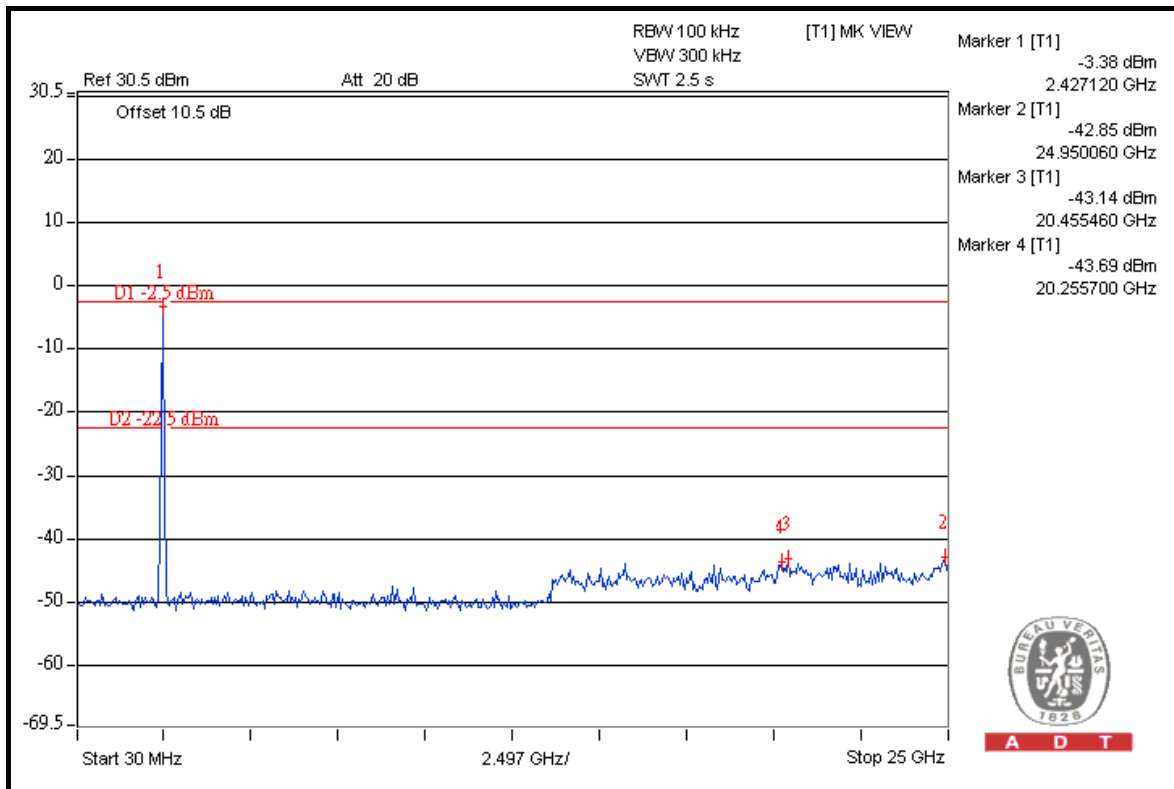
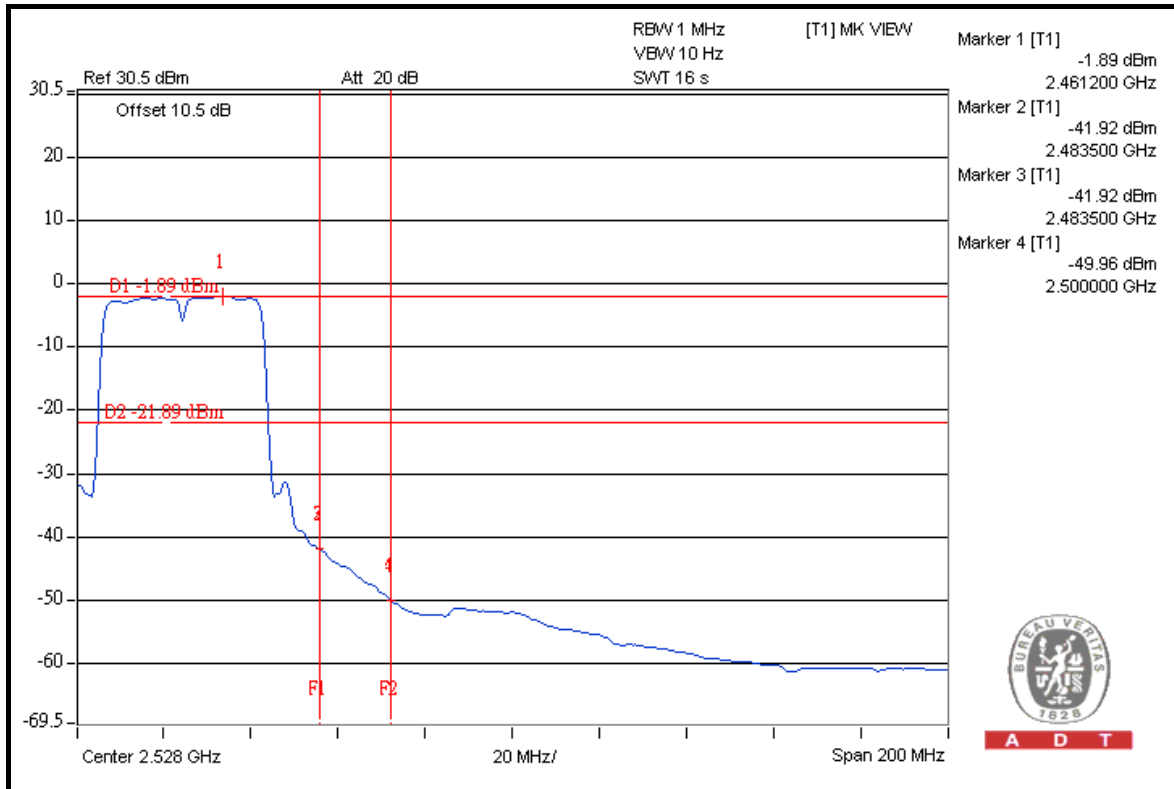



A D T

802.11n (40MHz): 2TX

TEST MODE A1

RESTRICT BAND (2310 ~ 2390 MHz)

FREQUENCY (MHz)	FUNDAMENTAL EMISSION (dBuV/m)	DELTA (dB)	MAXIMUM FIELD STRENGTH IN RESTRICT BAND (dBuV/m)	LIMIT (dBuV/m)
2422.00 (PK)	105.5	38.46	67.04	74.00
2422.00 (AV)	94.9	42.51	52.39	54.00

RESTRICT BAND (2483.5 ~ 2500 MHz)

FREQUENCY (MHz)	FUNDAMENTAL EMISSION (dBuV/m)	DELTA (dB)	MAXIMUM FIELD STRENGTH IN RESTRICT BAND (dBuV/m)	LIMIT (dBuV/m)
2452.00 (PK)	104.8	34.16	70.64	74.00
2452.00 (AV)	93.9	41.14	52.76	54.00

NOTE:

1. Delta = Amplitude between the peak of the fundamental and the peak of the band edge emission. Please check following 3 pages.
2. Maximum field strength in restrict band = Fundamental emission – Delta.



A D T

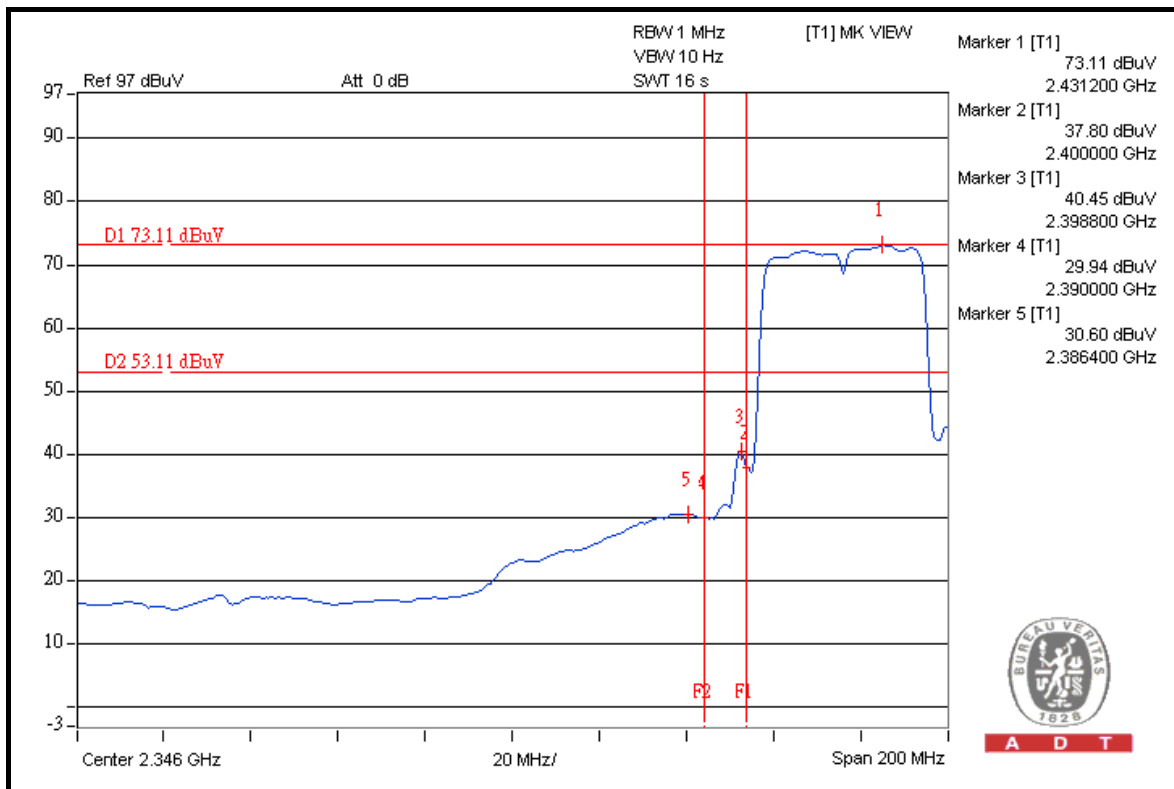
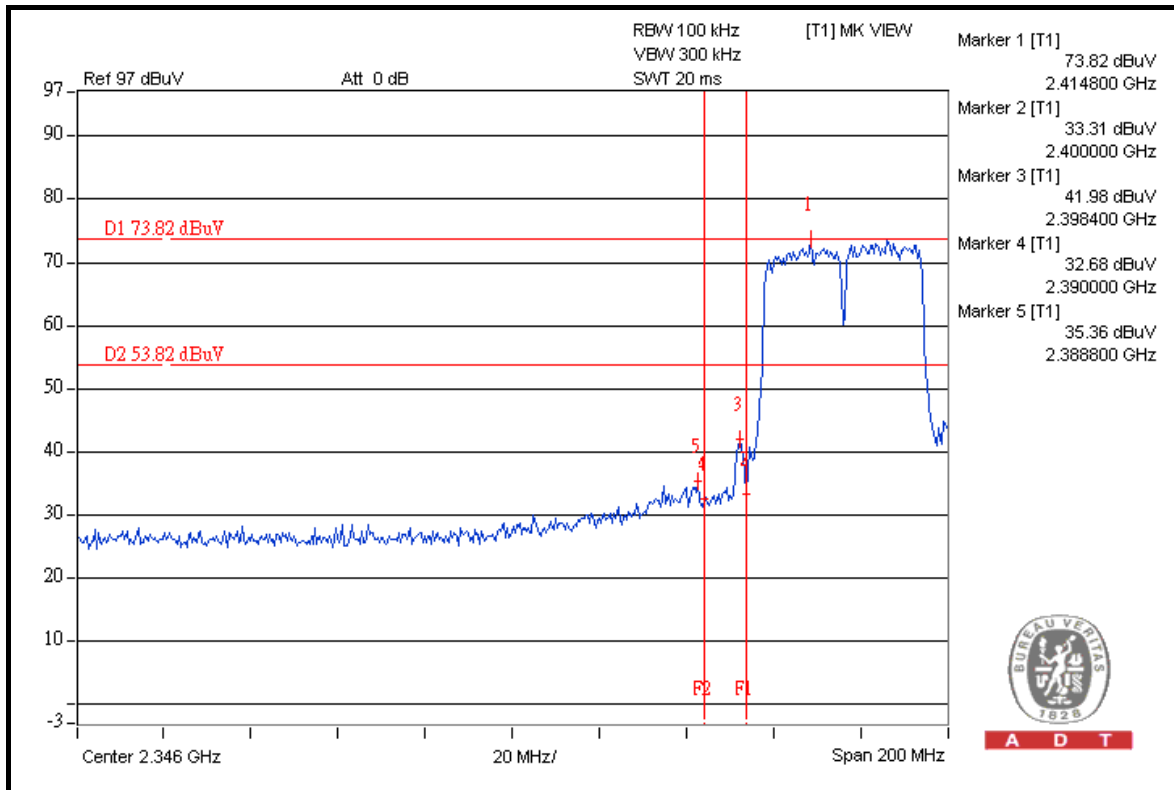



A D T

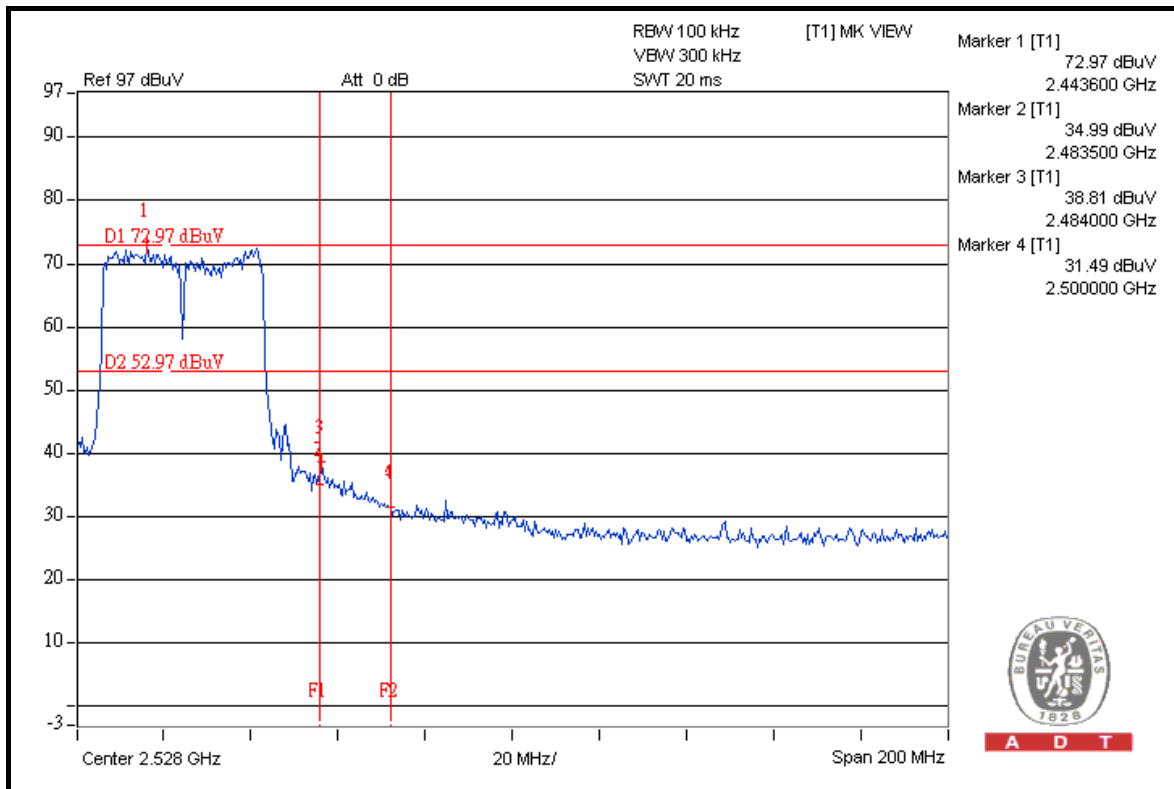
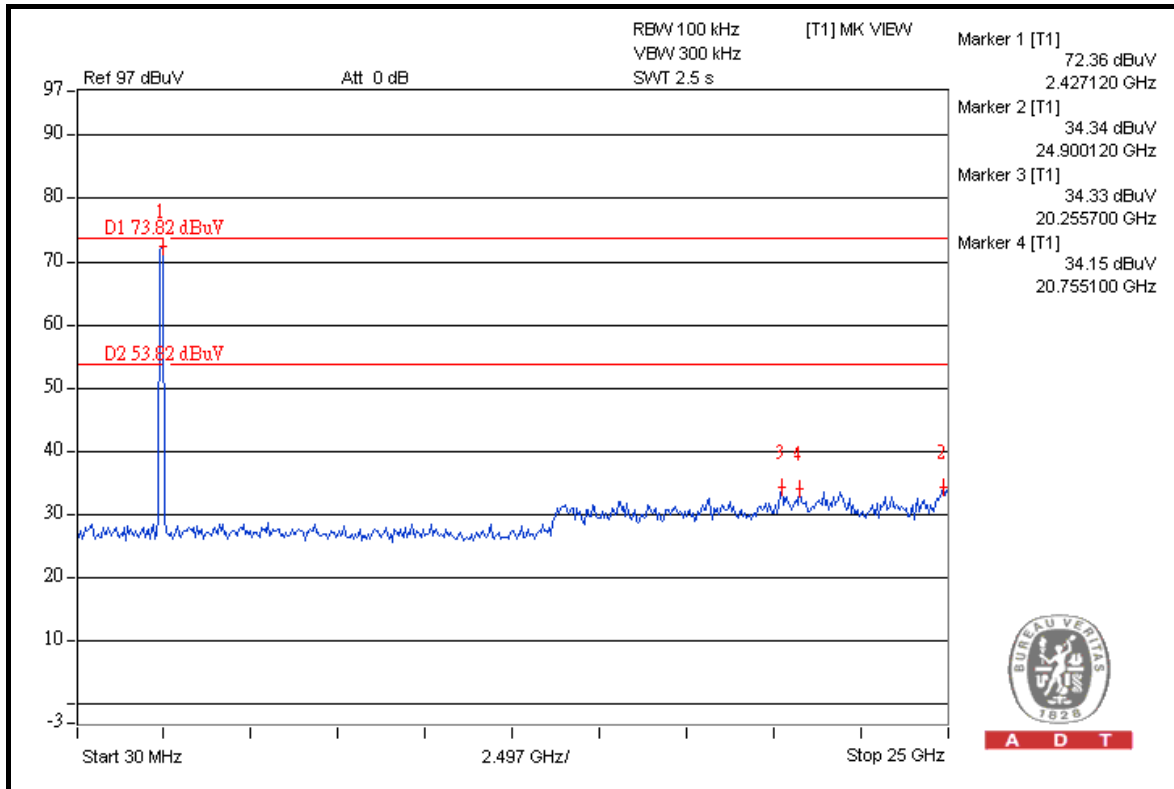



A D T

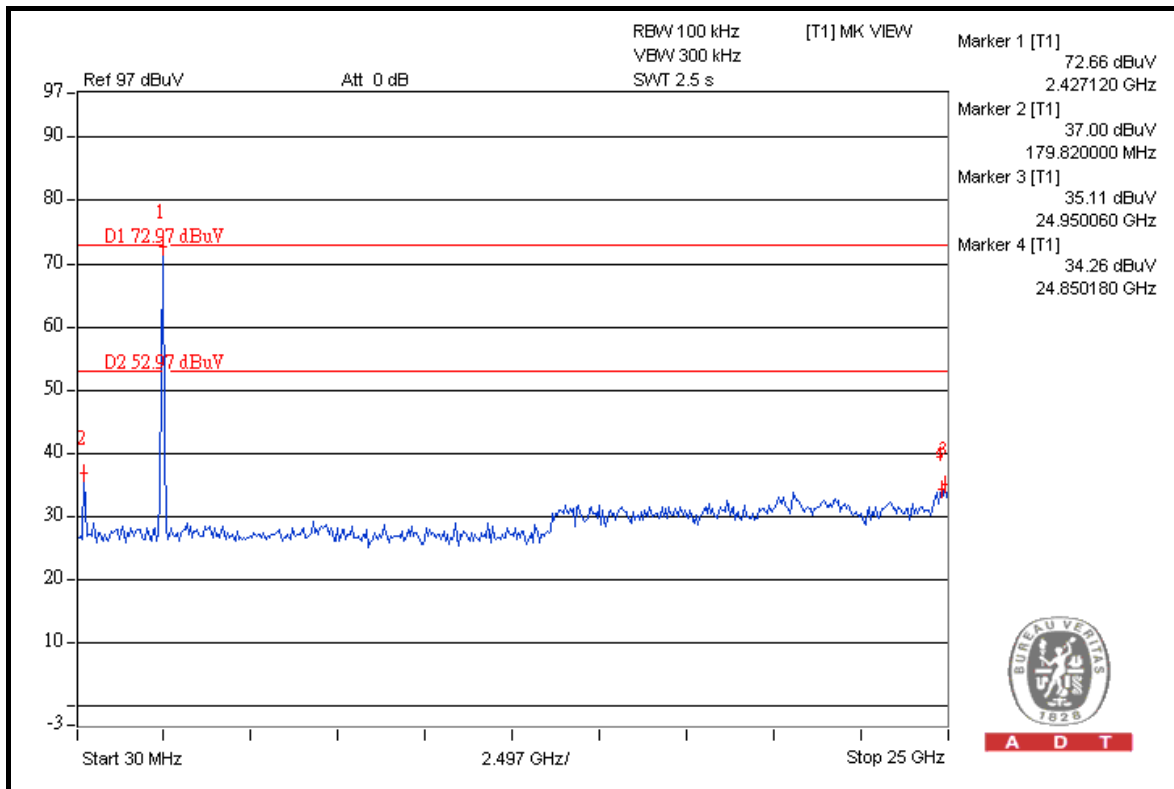
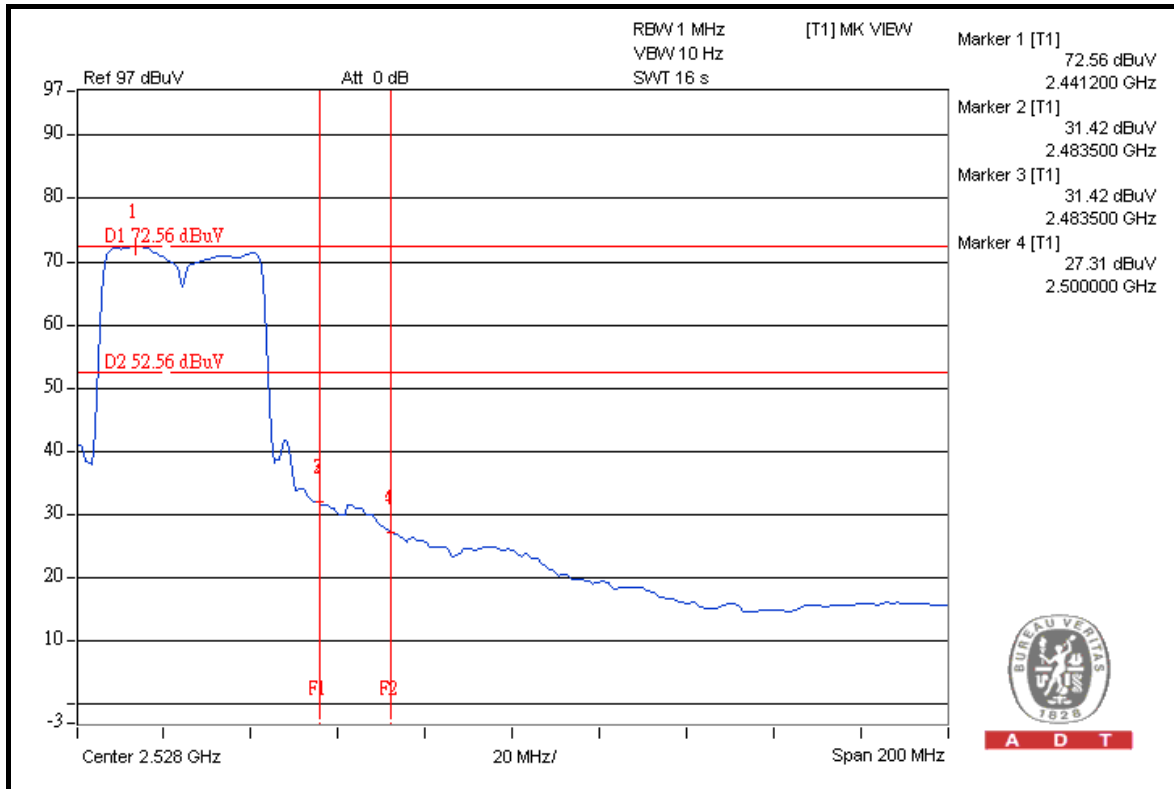



A D T

TEST MODE A2

RESTRICT BAND (2310 ~ 2390 MHz)

FREQUENCY (MHz)	FUNDAMENTAL EMISSION (dBuV/m)	DELTA (dB)	MAXIMUM FIELD STRENGTH IN RESTRICT BAND (dBuV/m)	LIMIT (dBuV/m)
2422.00 (PK)	106.2	38.70	67.50	74.00
2422.00 (AV)	95.5	42.58	52.92	54.00

RESTRICT BAND (2483.5 ~ 2500 MHz)

FREQUENCY (MHz)	FUNDAMENTAL EMISSION (dBuV/m)	DELTA (dB)	MAXIMUM FIELD STRENGTH IN RESTRICT BAND (dBuV/m)	LIMIT (dBuV/m)
2452.00 (PK)	105.4	38.44	66.96	74.00
2452.00 (AV)	94.6	41.80	52.80	54.00

NOTE:

1. Delta = Amplitude between the peak of the fundamental and the peak of the band edge emission. Please check following 3 pages.
2. Maximum field strength in restrict band = Fundamental emission – Delta.



A D T

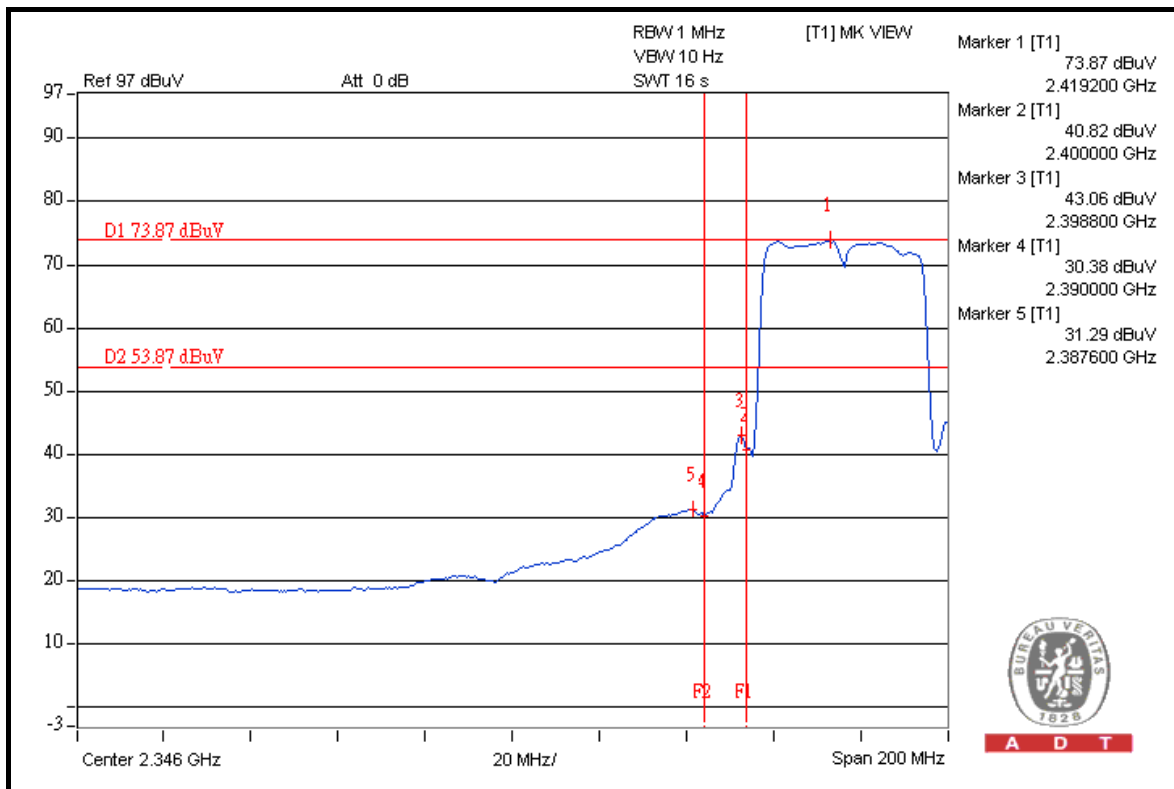
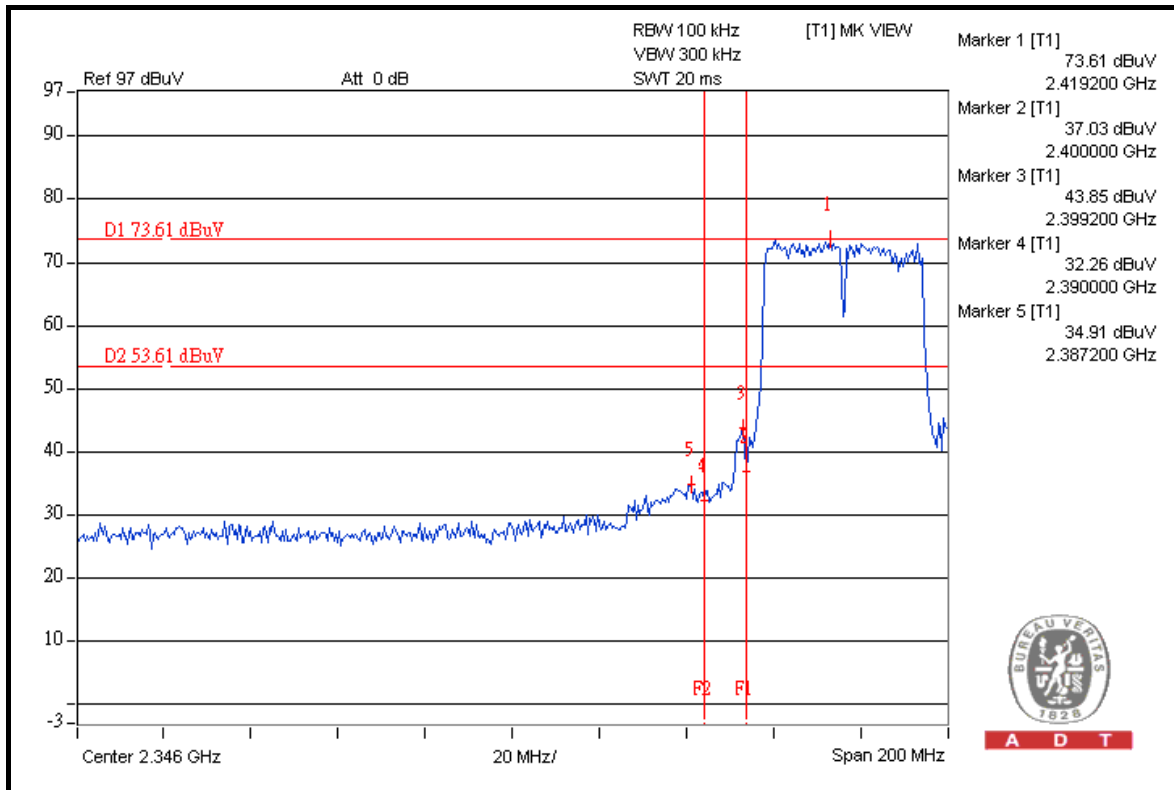



A D T

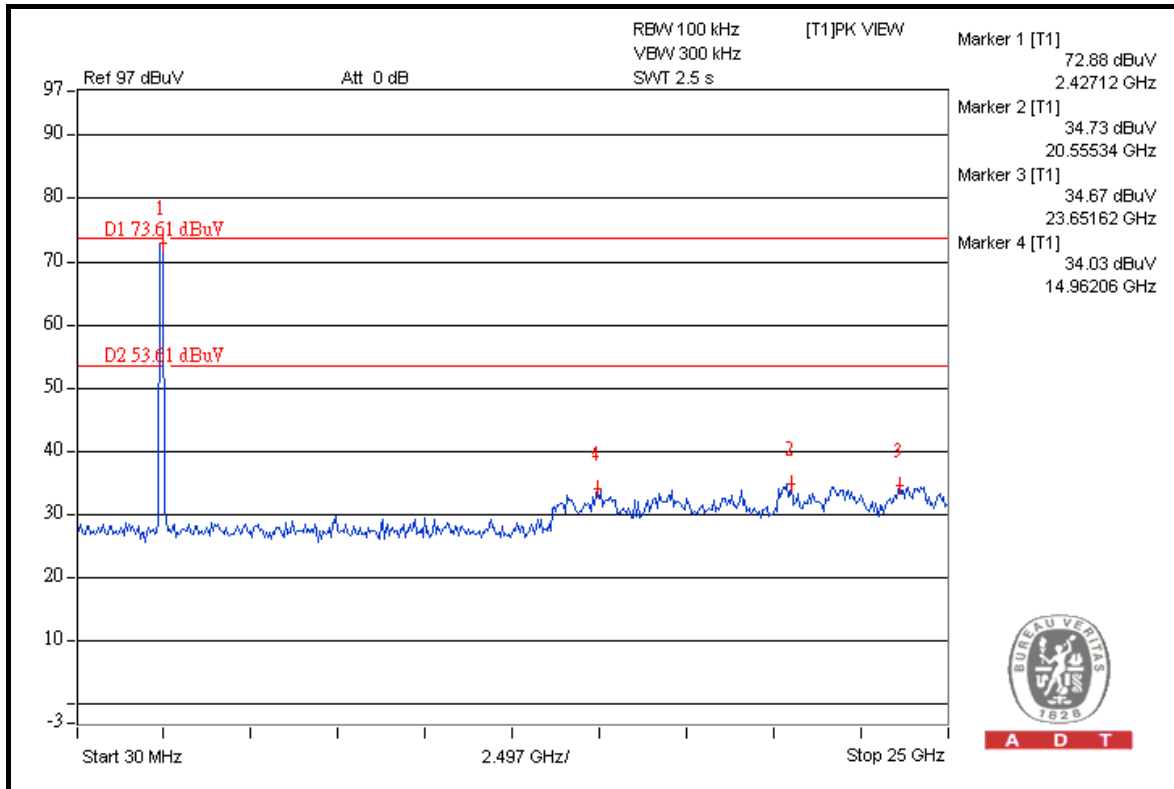

A D T

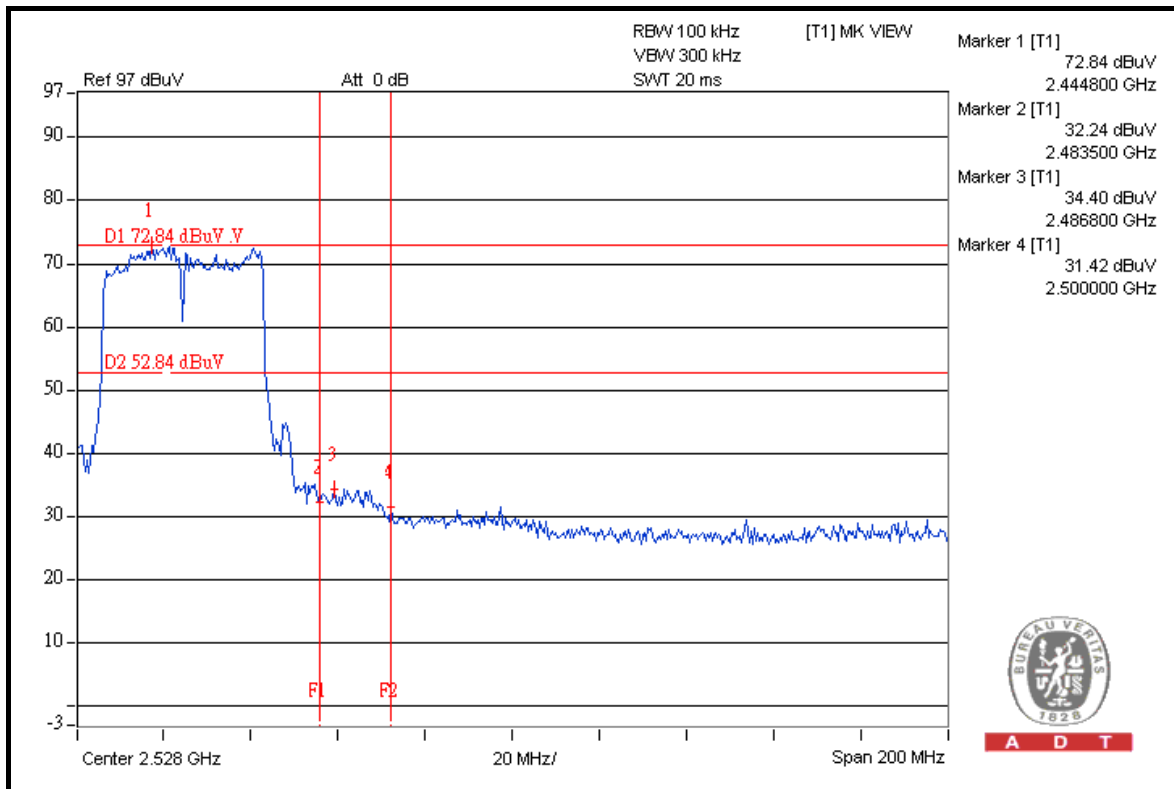

A D T



A D T

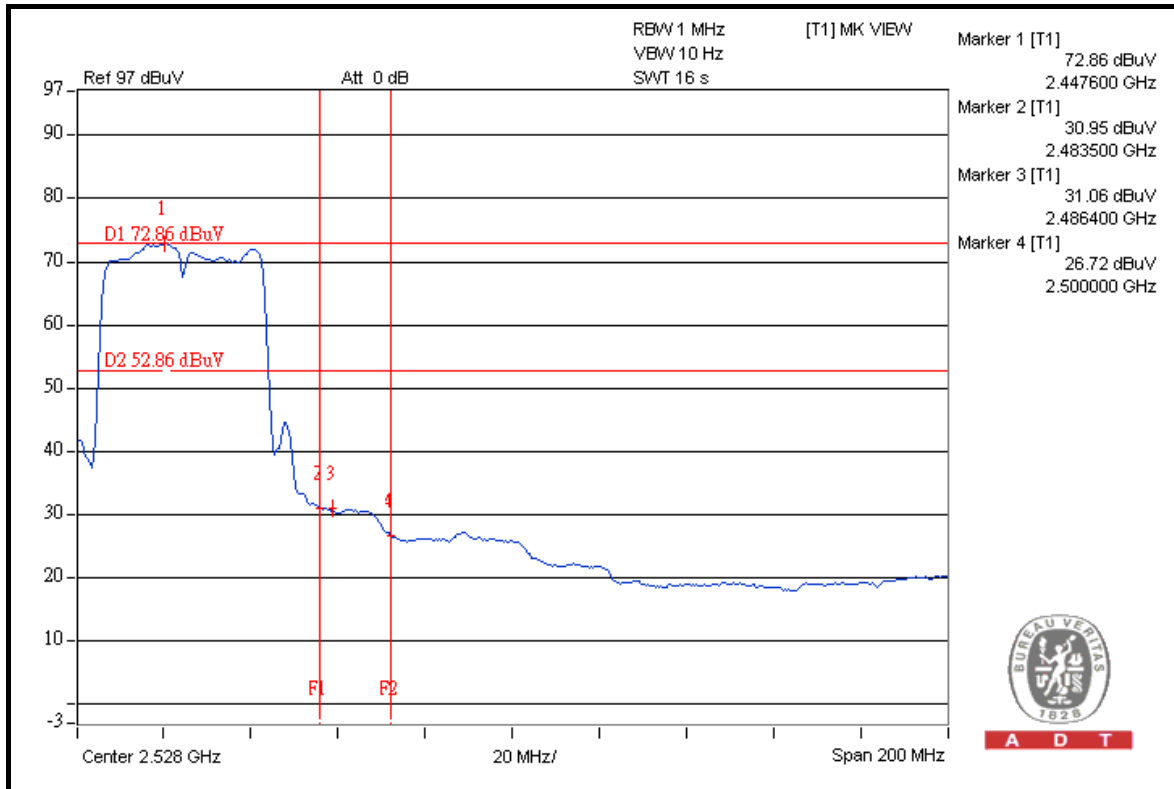

A D T

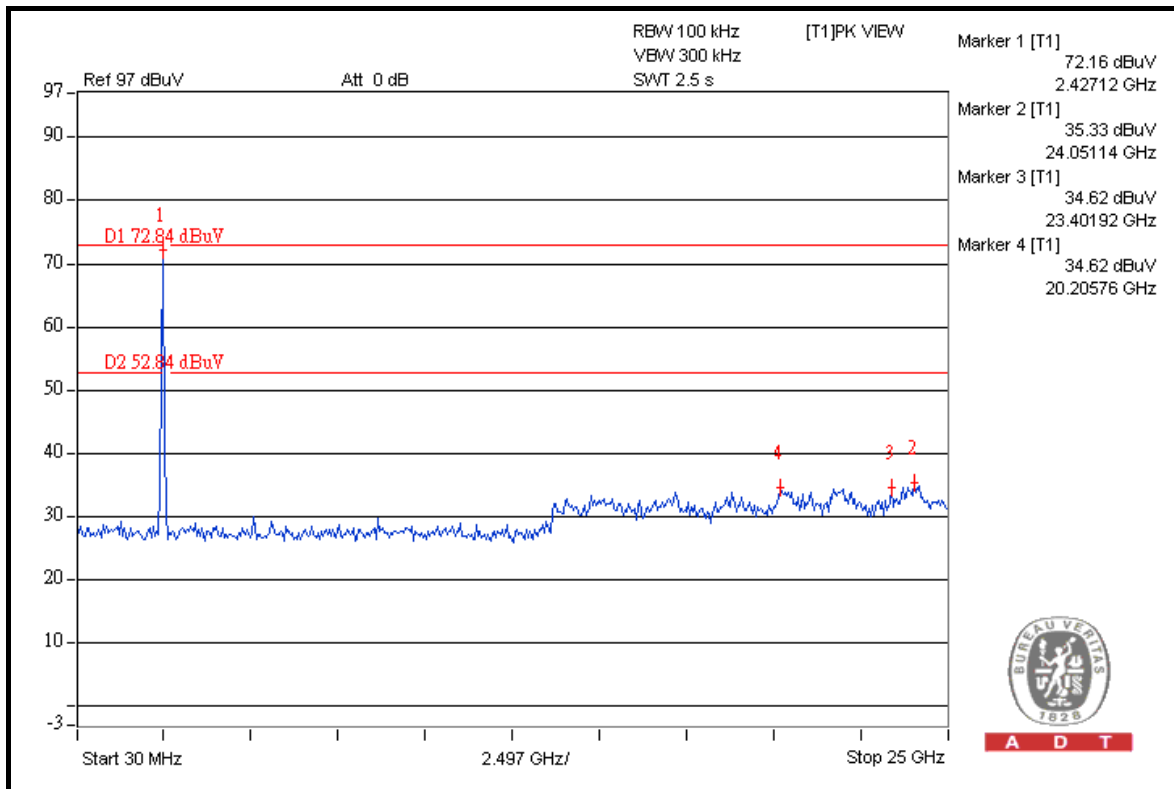

A D T



A D T

5. PHOTOGRAPHS OF THE TEST CONFIGURATION

Please refer to the attached file (Test Setup Photo).



A D T

6. INFORMATION ON THE TESTING LABORATORIES

We, Bureau Veritas Consumer Products Services (H.K.) Ltd., Taoyuan Branch, were founded in 1988 to provide our best service in EMC, Radio, Telecom and Safety consultation. Our laboratories are accredited and approved according to ISO/IEC 17025.

Copies of accreditation certificates of our laboratories obtained from approval agencies can be downloaded from our web site:

www.adt.com.tw/index.5/phtml. If you have any comments, please feel free to contact us at the following:

Linko EMC/RF Lab:

Tel: 886-2-26052180

Fax: 886-2-26051924

Hsin Chu EMC/RF Lab:

Tel: 886-3-5935343

Fax: 886-3-5935342

Hwa Ya EMC/RF/Safety Telecom Lab:

Tel: 886-3-3183232

Fax: 886-3-3185050

Web Site: www.adt.com.tw

The address and road map of all our labs can be found in our web site also.



A D T

7. APPENDIX A - MODIFICATIONS RECORDERS FOR ENGINEERING CHANGES TO THE EUT BY THE LAB

No any modifications are made to the EUT by the lab during the test.

---END---