



A D T

FCC TEST REPORT

REPORT NO.: RF981029L09

MODEL NO.: WLN-2211 (refer to item 3.1 for more detail)

RECEIVED: Aug. 06, 2009

TESTED: Aug. 06 ~ Nov. 03, 2009

ISSUED: Nov. 10, 2009

APPLICANT: CAMEO COMMUNICATIONS, INC.

ADDRESS: 7F., No. 32, Zhongxing Rd., Xizhi City, Taipei
County 221, Taiwan (R.O.C.)

ISSUED BY: Bureau Veritas Consumer Products Services
(H.K.) Ltd., Taoyuan Branch

LAB ADDRESS: No. 47, 14th Ling, Chia Pau Tsuen, Lin Kou
Hsiang, Taipei Hsien 244, Taiwan, R.O.C.

TEST LOCATION: No. 19, Hwa Ya 2nd Rd, Wen Hwa Tsuen, Kwei
Shan Hsiang, Taoyuan Hsien 333, Taiwan,
R.O.C.

This test report consists of 72 pages in total. It may be duplicated completely for legal use with the approval of the applicant. It should not be reproduced except in full, without the written approval of our laboratory. The client should not use it to claim product endorsement by TAF or any government agencies. The test results in the report only apply to the tested sample.





TABLE OF CONTENTS

1.	CERTIFICATION.....	4
2.	SUMMARY OF TEST RESULTS	5
2.1	MEASUREMENT UNCERTAINTY.....	5
3.	GENERAL INFORMATION.....	6
3.1	GENERAL DESCRIPTION OF EUT	6
3.2	DESCRIPTION OF TEST MODES.....	8
3.2.1	CONFIGURATION OF SYSTEM UNDER TEST	8
3.2.2	TEST MODE APPLICABILITY AND TESTED CHANNEL DETAIL	9
3.3	GENERAL DESCRIPTION OF APPLIED STANDARDS	11
3.4	DESCRIPTION OF SUPPORT UNITS	11
4.	TEST TYPES AND RESULTS	12
4.1	RADIATED EMISSION MEASUREMENT	12
4.1.1	LIMITS OF RADIATED EMISSION MEASUREMENT.....	12
4.1.2	TEST INSTRUMENTS.....	13
4.1.3	TEST PROCEDURES	14
4.1.4	DEVIATION FROM TEST STANDARD.....	14
4.1.5	TEST SETUP.....	15
4.1.6	EUT OPERATING CONDITIONS	15
4.1.7	TEST RESULTS	16
4.2	CONDUCTED EMISSION MEASUREMENT	30
4.2.1	LIMITS OF CONDUCTED EMISSION MEASUREMENT	30
4.2.2	TEST INSTRUMENTS.....	30
4.2.3	TEST PROCEDURES	31
4.2.4	DEVIATION FROM TEST STANDARD.....	31
4.2.5	TEST SETUP.....	32
4.2.6	EUT OPERATING CONDITIONS	32
4.2.7	TEST RESULTS	33
4.3	6dB BANDWIDTH MEASUREMENT.....	37
4.3.1	LIMITS OF 6dB BANDWIDTH MEASUREMENT	37
4.3.2	TEST INSTRUMENTS.....	37
4.3.3	TEST PROCEDURE.....	37
4.3.4	DEVIATION FROM TEST STANDARD.....	37
4.3.5	TEST SETUP.....	38
4.3.6	EUT OPERATING CONDITIONS	38
4.3.7	TEST RESULTS	39
4.4	MAXIMUM OUTPUT POWER	43
4.4.1	LIMITS OF MAXIMUM OUTPUT POWER MEASUREMENT.....	43
4.4.2	INSTRUMENTS.....	43
4.4.3	TEST PROCEDURE.....	43
4.4.4	DEVIATION FROM TEST STANDARD.....	44
4.4.5	TEST SETUP.....	44
4.4.6	EUT OPERATING CONDITIONS	44
4.4.7	TEST RESULTS	45
4.5	POWER SPECTRAL DENSITY MEASUREMENT	46
4.5.1	LIMITS OF POWER SPECTRAL DENSITY MEASUREMENT	46
4.5.2	TEST INSTRUMENTS.....	46
4.5.3	TEST PROCEDURE.....	46
4.5.4	DEVIATION FROM TEST STANDARD.....	47



A D T

4.5.5	TEST SETUP	47
4.5.6	EUT OPERATING CONDITION.....	47
4.5.7	TEST RESULTS	48
4.6	BAND EDGES MEASUREMENT	52
4.6.1	LIMITS OF BAND EDGES MEASUREMENT	52
4.6.2	TEST INSTRUMENTS.....	52
4.6.3	TEST PROCEDURE.....	53
4.6.4	DEVIATION FROM TEST STANDARD.....	53
4.6.5	EUT OPERATING CONDITION.....	53
4.6.6	TEST RESULTS	54
5.	PHOTOGRAPHS OF THE TEST CONFIGURATION.....	70
6.	INFORMATION ON THE TESTING LABORATORIES	71
7.	APPENDIX A - MODIFICATIONS RECORDERS FOR ENGINEERING CHANGES TO THE EUT BY THE LAB	72



A D T

1. CERTIFICATION

PRODUCT: IEEE802.11n Wireless LAN Router

MODEL: WLN-2211 (refer to item 3.1 for more detail)

BRAND: Cameo (refer to item 3.1 for more detail)

APPLICANT: CAMEO COMMUNICATIONS, INC.

TEST SAMPLE: ENGINEERING SAMPLE

TESTED: Aug. 06 ~ Nov. 03, 2009

STANDARDS: FCC Part 15, Subpart C (Section 15.247)

ANSI C63.4-2003

The above equipment (Model: WLN-2211) has been tested by **Bureau Veritas Consumer Products Services (H.K.) Ltd., Taoyuan Branch**, and found compliance with the requirement of the above standards. The test record, data evaluation & Equipment Under Test (EUT) configurations represented herein are true and accurate accounts of the measurements of the sample's EMC characteristics under the conditions specified in this report.

PREPARED BY : Andrea Hsia , **DATE** : Nov. 10, 2009
Andrea Hsia / Specialist

TECHNICAL ACCEPTANCE : Long Chen , **DATE** : Nov. 10, 2009
Responsible for RF Long Chen / Senior Engineer

APPROVED BY : Gary Chang , **DATE** : Nov. 10, 2009
Gary Chang / Assistant Manager



A D T

2. SUMMARY OF TEST RESULTS

The EUT has been tested according to the following specifications:

APPLIED STANDARD: FCC PART 15, SUBPART C (SECTION 15.247)			
STANDARD SECTION	TEST TYPE AND LIMIT	RESULT	REMARK
15.207	AC Power Conducted Emission	PASS	Meet the requirement of limit. Minimum passing margin is -14.1dB at 3.016MHz.
15.247(a)(2)	Spectrum Bandwidth of a Direct Sequence Spread Spectrum System Limit: min. 500kHz	PASS	Meet the requirement of limit.
15.247(b)	Maximum Output Power Limit: max. 30dBm	PASS	Meet the requirement of limit.
15.247(d)	Radiated Emissions Limit: Table 15.209	PASS	Meet the requirement of limit. Minimum passing margin is -1.2dB at 2483.50MHz.
15.247(e)	Power Spectral Density Limit: max. 8dBm	PASS	Meet the requirement of limit.
15.247(d)	Band Edge Measurement Limit: 20dB less than the peak value of fundamental frequency	PASS	Meet the requirement of limit.
15.203	Antenna Requirement	PASS	No antenna connector is used.

2.1 MEASUREMENT UNCERTAINTY

Where relevant, the following measurement uncertainty levels have been estimated for tests performed on the EUT as specified in CISPR 16-4-2:

MEASUREMENT	FREQUENCY	UNCERTAINTY
Conducted emissions	150kHz~30MHz	2.44dB
Radiated emissions	30MHz ~ 200MHz	2.93dB
	200MHz ~1000MHz	2.95dB
	1GHz ~ 18GHz	2.26dB
	18GHz ~ 40GHz	1.94dB

This uncertainty represents an expanded uncertainty expressed at approximately the 95% confidence level using a coverage factor of $k = 2$.



3. GENERAL INFORMATION

3.1 GENERAL DESCRIPTION OF EUT

EUT	IEEE802.11n Wireless LAN Router
MODEL NO.	WLN-2211 (refer to note as below)
FCC ID	NHPWLN2211
POWER SUPPLY	5Vdc
MODULATION TYPE	CCK, DQPSK, DBPSK for DSSS 64QAM, 16QAM, QPSK, BPSK for OFDM
MODULATION TECHNOLOGY	DSSS, OFDM
TRANSFER RATE	802.11b:11.0/ 5.5/ 2.0/ 1.0Mbps 802.11g: 54.0/ 48.0/ 36.0/ 24.0/ 18.0/ 12.0/ 9.0/ 6.0Mbps 802.11n: up to 150.0Mbps
OPERATING FREQUENCY	2412 ~ 2462MHz
NUMBER OF CHANNEL	11 for 802.11b, 802.11g, 802.11n (20MHz) 7 for 802.11n (40MHz)
OUTPUT POWER	331.1mW
ANTENNA TYPE	Dipole antenna with 2dBi gain (For TX & RX) Printed antenna (For RX only)
ANTENNA CONNECTOR	NA
I/O PORTS	RJ45
DATA CABLE	NA
ACCESSORY DEVICES	AC Adapter

NOTE:

1. All models are electrically identical, different model names are for marketing purpose.

BRAND NAME	Model Name
CAMEO	WLN-2211
TRENDnet	TEW-651BR
MSI	RG310EX
ENCORE	ENHWI-N4
Atlantis Land	A02-RB-WN

2. The EUT provides one completed transmitter and two receivers.

MODULATION MODE	TX FUNCTION
802.11b	1TX
802.11g	1TX
802.11n (20MHz)	1TX
802.11n (40MHz)	1TX



A D T

3. The EUT were operated with following power adapters:

ADAPTER 1	
BRAND	AMIGO
MODEL	AMS1-0501200FU
INPUT POWER	100-240Vac, 50-60Hz, 0.2A
OUTPUT POWER	5Vdc, 1.2A
POWER LINE	1.5m non-shielded cable without core

ADAPTER 2	
BRAND	JENTEC TECHNOLOGY CO., LTD.
MODEL	CF0605-B IW
INPUT POWER	100-240Vac, 50-60Hz, 0.18A
OUTPUT POWER	5Vdc, 1.2A
POWER LINE	1.5m non-shielded cable without core

4. The above EUT information was declared by manufacturer and for more detailed features description, please refer to the manufacturer's specifications or user's manual.

3.2 DESCRIPTION OF TEST MODES

11 channels are provided for 802.11b, 802.11g and 802.11n (20MHz):

CHANNEL	FREQUENCY	CHANNEL	FREQUENCY
1	2412MHz	7	2442MHz
2	2417MHz	8	2447MHz
3	2422MHz	9	2452MHz
4	2427MHz	10	2457MHz
5	2432MHz	11	2462MHz
6	2437MHz		

7 channels are provided for 802.11n (40MHz):

CHANNEL	FREQUENCY	CHANNEL	FREQUENCY
1	2422MHz	5	2442MHz
2	2427MHz	6	2447MHz
3	2432MHz	7	2452MHz
4	2437MHz		

3.2.1 CONFIGURATION OF SYSTEM UNDER TEST

5m RJ45 UTP cable x 3 + Load

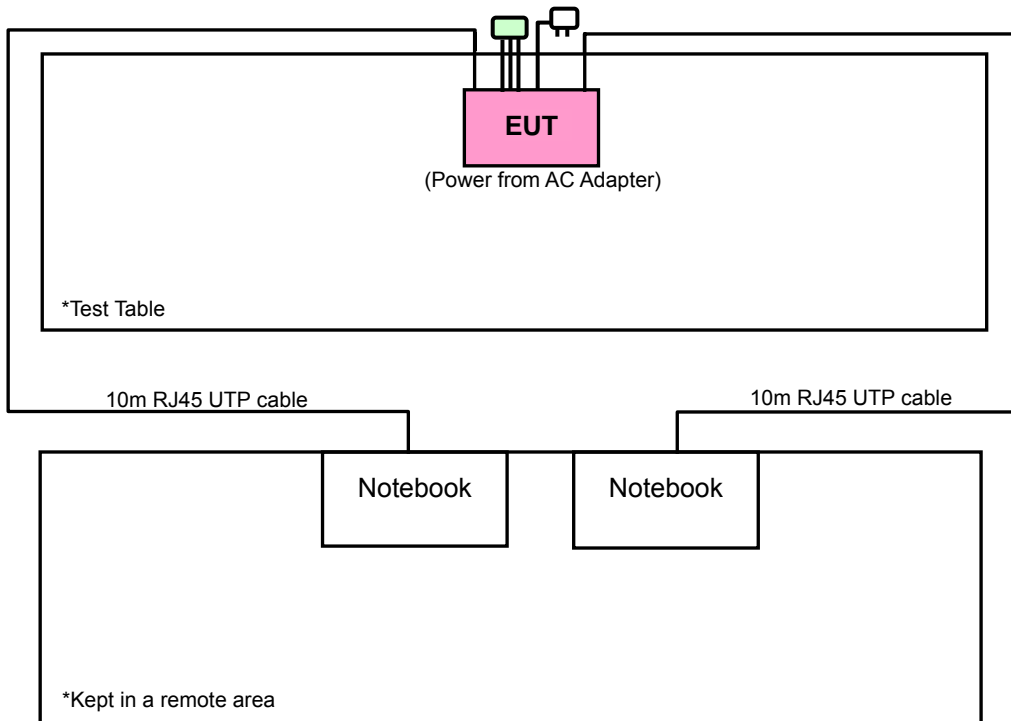

3.2.2 TEST MODE APPLICABILITY AND TESTED CHANNEL DETAIL

EUT CONFIGURE MODE	APPLICABLE TO				DESCRIPTION
	RE \geq 1G	RE<1G	PLC	APCM	
A	√	√	√	√	Power from Adapter 1
B	-	√	-	-	Power from Adapter 2

Where **RE \geq 1G**: Radiated Emission above 1GHz **RE<1G**: Radiated Emission below 1GHz
PLC: Power Line Conducted Emission **APCM**: Antenna Port Conducted Measurement
NOTE: "-" means no effect.

RADIATED EMISSION TEST (ABOVE 1GHz):

- Pre-Scan has been conducted to determine the worst-case mode from all possible combinations between available modulations, data rates and antenna ports (if EUT with antenna diversity architecture).
- Following channel(s) was (were) selected for the final test as listed below.

EUT CONFIGURE MODE	MODE	AVAILABLE CHANNEL	TESTED CHANNEL	MODULATION TECHNOLOGY	MODULATION TYPE	DATA RATE (Mbps)
A	802.11b	1 to 11	1, 6, 11	DSSS	DBPSK	1.0
A	802.11g	1 to 11	1, 6, 11	OFDM	BPSK	6.0
A	802.11n (20MHz)	1 to 11	1, 6, 11	OFDM	BPSK	6.5
A	802.11n (40MHz)	1 to 7	1, 4, 7	OFDM	BPSK	13.5

RADIATED EMISSION TEST (BELOW 1GHz):

- Pre-Scan has been conducted to determine the worst-case mode from all possible combinations between available modulations, data rates and antenna ports (if EUT with antenna diversity architecture).
- Following channel(s) was (were) selected for the final test as listed below.

EUT CONFIGURE MODE	MODE	AVAILABLE CHANNEL	TESTED CHANNEL	MODULATION TECHNOLOGY	MODULATION TYPE	DATA RATE (Mbps)
A	802.11g	1 to 11	6	OFDM	BPSK	6.0
B	802.11g	1 to 11	6	OFDM	BPSK	6.0

POWER LINE CONDUCTED EMISSION TEST:

- Pre-Scan has been conducted to determine the worst-case mode from all possible combinations between available modulations, data rates and antenna ports (if EUT with antenna diversity architecture).
- Following channel(s) was (were) selected for the final test as listed below.

EUT CONFIGURE MODE	MODE	AVAILABLE CHANNEL	TESTED CHANNEL	MODULATION TECHNOLOGY	MODULATION TYPE	DATA RATE (Mbps)
A	802.11g	1 to 11	6	OFDM	BPSK	6.0
B	802.11g	1 to 11	6	OFDM	BPSK	6.0



BANDEDGE MEASUREMENT:

- Pre-Scan has been conducted to determine the worst-case mode from all possible combinations between available modulations, data rates and antenna ports (if EUT with antenna diversity architecture).
- Following channel(s) was (were) selected for the final test as listed below.

EUT CONFIGURE MODE	MODE	AVAILABLE CHANNEL	TESTED CHANNEL	MODULATION TECHNOLOGY	MODULATION TYPE	DATA RATE (Mbps)
A	802.11b	1 to 11	1, 11	DSSS	DBPSK	1.0
A	802.11g	1 to 11	1, 11	OFDM	BPSK	6.0
A	802.11n (20MHz)	1 to 11	1, 11	OFDM	BPSK	6.5
A	802.11n (40MHz)	1 to 7	1, 7	OFDM	BPSK	13.5

ANTENNA PORT CONDUCTED MEASUREMENT:

- This item includes all test value of each mode, but only includes spectrum plot of worst value of each mode.
- Pre-Scan has been conducted to determine the worst-case mode from all possible combinations between available modulations, data rates and antenna ports (if EUT with antenna diversity architecture).
- Following channel(s) was (were) selected for the final test as listed below.

EUT CONFIGURE MODE	MODE	AVAILABLE CHANNEL	TESTED CHANNEL	MODULATION TECHNOLOGY	MODULATION TYPE	DATA RATE (Mbps)
A	802.11b	1 to 11	1, 6, 11	DSSS	DBPSK	1.0
A	802.11g	1 to 11	1, 6, 11	OFDM	BPSK	6.0
A	802.11n (20MHz)	1 to 11	1, 6, 11	OFDM	BPSK	6.5
A	802.11n (40MHz)	1 to 7	1, 4, 7	OFDM	BPSK	13.5

TEST CONDITION:

APPLICABLE TO	ENVIRONMENTAL CONDITIONS	INPUT POWER (SYSTEM)	TESTED BY
RE≥1G	23deg. C, 70%RH, 1006 hPa	120Vac, 60Hz	Lori Chiu
RE<1G	23deg. C, 70%RH, 1006 hPa	120Vac, 60Hz	Lori Chiu
PLC	25deg. C, 65%RH, 1005 hPa	120Vac, 60Hz	Mark Liao
APCM	23deg. C, 61%RH, 1008 hPa	120Vac, 60Hz	Lori Chiu



3.3 GENERAL DESCRIPTION OF APPLIED STANDARDS

The EUT is a RF Product. According to the specifications of the manufacturer, it must comply with the requirements of the following standards:

FCC Part 15, Subpart C (15.247)

ANSI C63.4-2003

All test items have been performed and recorded as per the above standards.

NOTE: The EUT is also considered as a kind of computer peripheral, because the connection to computer is necessary for typical use. It has been verified to comply with the requirements of FCC Part 15, Subpart B, Class B (DoC). The test report has been issued separately.

3.4 DESCRIPTION OF SUPPORT UNITS

The EUT has been tested as an independent unit together with other necessary accessories or support units. The following support units or accessories were used to form a representative test configuration during the tests.

NO.	PRODUCT	BRAND	MODEL NO.	SERIAL NO.	FCC ID
1	NOTEBOOK	DELL	PP05L	25191592336	E2K24CLNS
2	NOTEBOOK	DELL	PP05L	12130898320	E2K24CLNS

NO.	SIGNAL CABLE DESCRIPTION OF THE ABOVE SUPPORT UNITS
1	10m UTP RJ45 cable
2	10m UTP RJ45 cable

NOTE: 1. All power cords of the above support units are non shielded (1.8m).
2. Item 1-2 acted as a communication partner to transfer data.



A D T

4. TEST TYPES AND RESULTS

4.1 RADIATED EMISSION MEASUREMENT

4.1.1 LIMITS OF RADIATED EMISSION MEASUREMENT

Emissions radiated outside of the specified bands, shall be according to the general radiated limits in 15.209 as following:

FREQUENCIES (MHz)	FIELD STRENGTH (microvolts/meter)	MEASUREMENT DISTANCE (meters)
0.009 ~ 0.490	2400/F(kHz)	300
0.490 ~ 1.705	24000/F(kHz)	30
1.705 ~ 30.0	30	30
30 ~ 88	100	3
88 ~ 216	150	3
216 ~ 960	200	3
Above 960	500	3

NOTE:

1. The lower limit shall apply at the transition frequencies.
2. Emission level (dBuV/m) = 20 log Emission level (uV/m).
3. As shown in 15.35(b), for frequencies above 1000MHz, the field strength limits are based on average detector, however, the peak field strength of any emission shall not exceed the maximum permitted average limits, specified above by more than 20dB under any condition of modulation.



A D T

4.1.2 TEST INSTRUMENTS

DESCRIPTION & MANUFACTURER	MODEL NO.	SERIAL NO.	DATE OF CALIBRATION	DUE DATE OF CALIBRATION
Test Receiver ROHDE & SCHWARZ	ESIB7	100212	May 25, 2009	May 24, 2010
Spectrum Analyzer ROHDE & SCHWARZ	FSP40	100040	Jul. 07, 2009	Jul. 06, 2010
BILOG Antenna SCHWARZBECK	VULB9168	9168-156	Apr. 30, 2009	Apr. 29, 2010
HORN Antenna SCHWARZBECK	BBHA 9120 D	9120D-563	Aug. 10, 2009	Aug. 09, 2010
HORN Antenna SCHWARZBECK	BBHA 9170	BBHA9170242	Jan. 06, 2009	Jan. 05, 2010
Preamplifier Agilent	8449B	3008A01910	Sep. 11, 2009	Sep. 10, 2010
Preamplifier Agilent	8447D	2944A10638	Dec. 26, 2008	Dec. 25, 2009
RF signal cable HUBER+SUHNNER	SUCOFLEX 104	218190/4 231241/4	May 13, 2009	May 12, 2010
RF signal cable Worken	8D-FB	Cable-HYCH9-01	Aug. 17, 2009	Aug. 16, 2010
Software	ADT_Radiated_ V7.6.15.9.2	NA	NA	NA
Antenna Tower EMCO	2070/2080	512.835.4684	NA	NA
Turn Table EMCO	2087-2.03	NA	NA	NA
Antenna Tower & Turn Table Controller EMCO	2090	NA	NA	NA

- NOTE:**
1. The calibration interval of the above test instruments is 12 months and the calibrations are traceable to NML/ROC and NIST/USA.
 2. The test was performed in HwaYa Chamber 9.
 3. The horn antenna and HP preamplifier (model: 8449B) are used only for the measurement of emission frequency above 1GHz if tested.
 4. The FCC Site Registration No. is 460141.
 5. The IC Site Registration No. is IC 7450F-4.



A D T

4.1.3 TEST PROCEDURES

- a. The EUT was placed on the top of a rotating table 0.8 meters above the ground at a 3 meters semi-anechoic chamber. The table was rotated 360 degrees to determine the position of the highest radiation.
- b. The EUT was set 3 meters away from the interference-receiving antenna, which was mounted on the top of a variable-height antenna tower.
- c. The antenna is a broadband antenna, and its height is varied from one meter to four meters above the ground to determine the maximum value of the field strength. Both horizontal and vertical polarizations of the antenna are set to make the measurement.
- d. For each suspected emission, the EUT was arranged to its worst case and then the antenna was tuned to heights from 1 meter to 4 meters and the rotatable table was turned from 0 degrees to 360 degrees to find the maximum reading.
- e. The test-receiver system was set to Peak Detect Function and Specified Bandwidth with Maximum Hold Mode.
- f. If the emission level of the EUT in peak mode was lower than the limit specified, then testing could be stopped and the peak values of the EUT would be reported. Otherwise the emissions would be re-tested one by one using peak, quasi-peak or average method as specified and then reported in a data sheet.

NOTE:

1. The resolution bandwidth and video bandwidth of test receiver/spectrum analyzer is 120kHz for Quasi-peak detection at frequency below 1GHz.
2. The resolution bandwidth of test receiver/spectrum analyzer is 1MHz and video bandwidth is 3MHz for Peak detection at frequency above 1GHz.
3. The resolution bandwidth of test receiver/spectrum analyzer is 1MHz and the video bandwidth is 10Hz for Average detection (AV) at frequency above 1GHz.
4. All modes of operation were investigated and the worst-case emissions are reported.

4.1.4 DEVIATION FROM TEST STANDARD

No deviation.

4.1.5 TEST SETUP

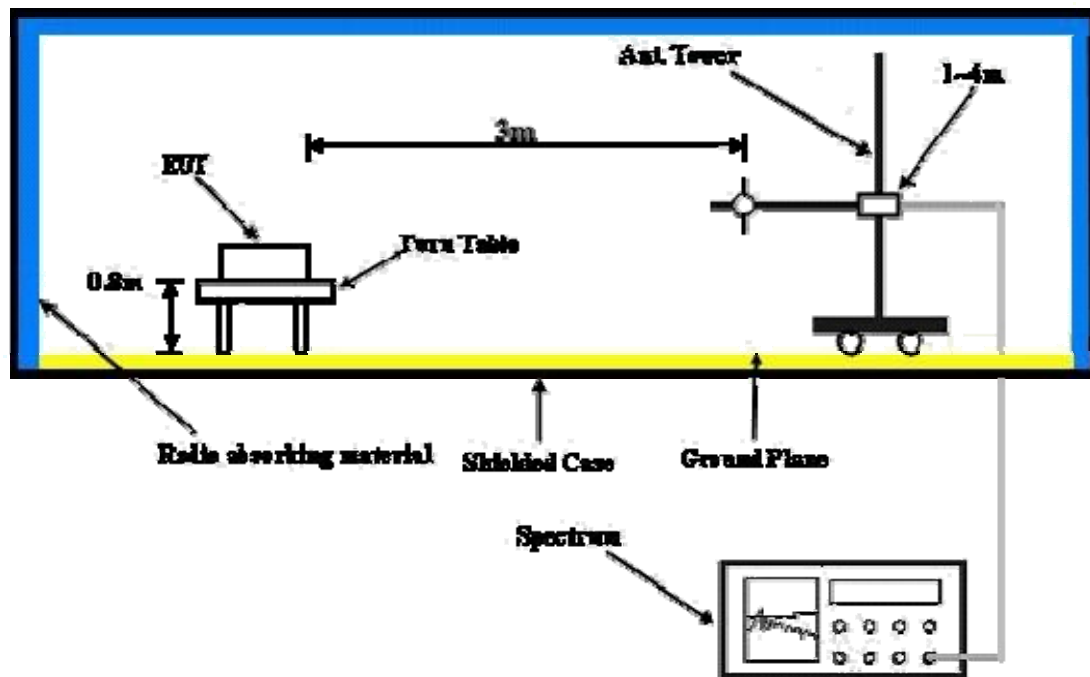

For the actual test configuration, please refer to the attached file (Test Setup Photo).

4.1.6 EUT OPERATING CONDITIONS

- a. Placed the EUT on the testing table.
- b. Prepared notebook systems to act as a communication partner and placed them outside of testing area.
- c. The communication partners connected with EUT via a UTP cable and run a test program (provided by manufacturer) to enable EUT under transmission condition continuously at specific channel frequency.
- d. The communication partners sent data to EUT by command "PING".



A D T

4.1.7 TEST RESULTS

802.11b

EUT TEST CONDITION		MEASUREMENT DETAIL	
CHANNEL	Channel 1	FREQUENCY RANGE	1 ~ 25GHz
INPUT POWER (SYSTEM)	120Vac, 60 Hz	DETECTOR FUNCTION	Peak (PK) Average (AV)
ENVIRONMENTAL CONDITIONS	23deg. C, 70%RH 1000 hPa	TESTED BY	Lori Chiu

ANTENNA POLARITY & TEST DISTANCE: HORIZONTAL AT 3 M								
NO.	FREQ. (MHz)	EMISSION LEVEL (dBuV/m)	LIMIT (dBuV/m)	MARGIN (dB)	ANTENNA HEIGHT (m)	TABLE ANGLE (Degree)	RAW VALUE (dBuV)	CORRECTION FACTOR (dB/m)
1	2386.00	58.1 PK	74.00	-15.9	1.00 H	215	26.24	31.83
2	2386.00	47.2 AV	54.00	-6.9	1.00 H	215	15.32	31.83
3	*2412.00	105.3 PK			1.00 H	215	73.35	31.92
4	*2412.00	100.5 AV			1.00 H	215	68.56	31.92
5	4824.00	50.1 PK	74.00	-23.9	1.26 H	187	12.27	37.83
6	4824.00	41.4 AV	54.00	-12.6	1.26 H	187	3.56	37.83
7	#7236.00	55.0 PK	85.27	-30.2	1.07 H	172	11.27	43.76
8	#7236.00	46.1 AV	80.48	-34.4	1.07 H	172	2.37	43.76
ANTENNA POLARITY & TEST DISTANCE: VERTICAL AT 3 M								
NO.	FREQ. (MHz)	EMISSION LEVEL (dBuV/m)	LIMIT (dBuV/m)	MARGIN (dB)	ANTENNA HEIGHT (m)	TABLE ANGLE (Degree)	RAW VALUE (dBuV)	CORRECTION FACTOR (dB/m)
1	2386.00	61.9 PK	74.00	-12.1	1.18 V	221	30.07	31.83
2	2386.00	52.1 AV	54.00	-1.9	1.18 V	221	20.27	31.83
3	*2412.00	112.2 PK			1.14 V	223	80.29	31.92
4	*2412.00	107.6 AV			1.14 V	223	75.67	31.92
5	4824.00	47.8 PK	74.00	-26.2	1.16 V	4	9.94	37.83
6	4824.00	37.7 AV	54.00	-16.3	1.16 V	4	-0.16	37.83
7	#7236.00	61.8 PK	92.21	-30.5	1.46 V	84	17.99	43.76
8	#7236.00	55.5 AV	87.59	-32.1	1.46 V	84	11.70	43.76

- REMARKS:**
1. Emission level (dBuV/m) = Raw Value (dBuV) + Correction Factor (dB/m).
 2. Correction Factor (dB/m) = Antenna Factor (dB/m) + Cable Factor (dB).
 3. The other emission levels were very low against the limit.
 4. Margin value = Emission level – Limit value.
 5. “ * “: Fundamental frequency.
 6. “#”: The radiated frequency is out the restricted band.



A D T

EUT TEST CONDITION		MEASUREMENT DETAIL	
CHANNEL	Channel 6	FREQUENCY RANGE	1 ~ 25GHz
INPUT POWER (SYSTEM)	120Vac, 60 Hz	DETECTOR FUNCTION	Peak (PK) Average (AV)
ENVIRONMENTAL CONDITIONS	23deg. C, 70%RH 1000 hPa	TESTED BY	Lori Chiu

ANTENNA POLARITY & TEST DISTANCE: HORIZONTAL AT 3 M								
NO.	FREQ. (MHz)	EMISSION LEVEL (dBuV/m)	LIMIT (dBuV/m)	MARGIN (dB)	ANTENNA HEIGHT (m)	TABLE ANGLE (Degree)	RAW VALUE (dBuV)	CORRECTION FACTOR (dB/m)
1	*2437.00	106.4 PK			1.11 H	220	74.34	32.01
2	*2437.00	101.7 AV			1.11 H	220	69.71	32.01
3	4874.00	53.3 PK	74.00	-20.7	1.23 H	20	15.41	37.91
4	4874.00	47.1 AV	54.00	-6.9	1.23 H	20	9.20	37.91
5	7311.00	52.2 PK	74.00	-21.8	1.34 H	211	8.30	43.89
6	7311.00	45.4 AV	54.00	-8.6	1.34 H	211	1.50	43.89
ANTENNA POLARITY & TEST DISTANCE: VERTICAL AT 3 M								
NO.	FREQ. (MHz)	EMISSION LEVEL (dBuV/m)	LIMIT (dBuV/m)	MARGIN (dB)	ANTENNA HEIGHT (m)	TABLE ANGLE (Degree)	RAW VALUE (dBuV)	CORRECTION FACTOR (dB/m)
1	*2437.00	113.3 PK			1.12 V	229	81.32	32.01
2	*2437.00	108.6 AV			1.12 V	229	76.61	32.01
3	4874.00	50.8 PK	74.00	-23.2	1.12 V	160	12.87	37.91
4	4874.00	44.3 AV	54.00	-9.7	1.12 V	160	6.39	37.91
5	7311.00	58.8 PK	74.00	-15.2	1.25 V	156	14.89	43.89
6	7311.00	51.7 AV	54.00	-2.3	1.25 V	156	7.78	43.89

- REMARKS:**
1. Emission level (dBuV/m) = Raw Value (dBuV) + Correction Factor (dB/m).
 2. Correction Factor (dB/m) = Antenna Factor (dB/m) + Cable Factor (dB).
 3. The other emission levels were very low against the limit.
 4. Margin value = Emission level – Limit value.
 5. “ * “: Fundamental frequency.



A D T

EUT TEST CONDITION		MEASUREMENT DETAIL	
CHANNEL	Channel 11	FREQUENCY RANGE	1 ~ 25GHz
INPUT POWER (SYSTEM)	120Vac, 60 Hz	DETECTOR FUNCTION	Peak (PK) Average (AV)
ENVIRONMENTAL CONDITIONS	23deg. C, 70%RH 1000 hPa	TESTED BY	Lori Chiu

ANTENNA POLARITY & TEST DISTANCE: HORIZONTAL AT 3 M								
NO.	FREQ. (MHz)	EMISSION LEVEL (dBuV/m)	LIMIT (dBuV/m)	MARGIN (dB)	ANTENNA HEIGHT (m)	TABLE ANGLE (Degree)	RAW VALUE (dBuV)	CORRECTION FACTOR (dB/m)
1	*2462.00	104.6 PK			1.01 H	210	72.48	32.09
2	*2462.00	99.7 AV			1.01 H	210	67.60	32.09
3	2483.50	57.9 PK	74.00	-16.1	1.01 H	211	25.70	32.16
4	2483.50	46.5 AV	54.00	-7.5	1.01 H	211	14.36	32.16
5	4924.00	51.6 PK	74.00	-22.4	1.11 H	127	13.63	38.01
6	4924.00	42.5 AV	54.00	-11.5	1.11 H	127	4.49	38.01
7	7386.00	54.2 PK	74.00	-19.8	1.00 H	260	10.17	44.02
8	7386.00	45.6 AV	54.00	-8.4	1.00 H	260	1.62	44.02

ANTENNA POLARITY & TEST DISTANCE: VERTICAL AT 3 M								
NO.	FREQ. (MHz)	EMISSION LEVEL (dBuV/m)	LIMIT (dBuV/m)	MARGIN (dB)	ANTENNA HEIGHT (m)	TABLE ANGLE (Degree)	RAW VALUE (dBuV)	CORRECTION FACTOR (dB/m)
1	*2462.00	111.7 PK			1.11 V	156	79.63	32.09
2	*2462.00	107.1 AV			1.11 V	156	75.04	32.09
3	2483.50	61.8 PK	74.00	-12.3	1.11 V	223	29.59	32.16
4	2483.50	52.0 AV	54.00	-2.0	1.11 V	223	19.82	32.16
5	4924.00	48.4 PK	74.00	-25.6	1.01 V	224	10.36	38.01
6	4924.00	35.4 AV	54.00	-18.6	1.01 V	224	-2.66	38.01
7	7386.00	60.2 PK	74.00	-13.8	1.44 V	12	16.17	44.02
8	7386.00	52.3 AV	54.00	-1.8	1.44 V	12	8.23	44.02

- REMARKS:**
1. Emission level (dBuV/m) = Raw Value (dBuV) + Correction Factor (dB/m).
 2. Correction Factor (dB/m) = Antenna Factor (dB/m) + Cable Factor (dB).
 3. The other emission levels were very low against the limit.
 4. Margin value = Emission level – Limit value.
 5. “ * “: Fundamental frequency.



A D T

802.11g

EUT TEST CONDITION		MEASUREMENT DETAIL	
CHANNEL	Channel 1	FREQUENCY RANGE	1 ~ 25GHz
INPUT POWER (SYSTEM)	120Vac, 60 Hz	DETECTOR FUNCTION	Peak (PK) Average (AV)
ENVIRONMENTAL CONDITIONS	23deg. C, 70%RH 1000 hPa	TESTED BY	Lori Chiu

ANTENNA POLARITY & TEST DISTANCE: HORIZONTAL AT 3 M								
NO.	FREQ. (MHz)	EMISSION LEVEL (dBuV/m)	LIMIT (dBuV/m)	MARGIN (dB)	ANTENNA HEIGHT (m)	TABLE ANGLE (Degree)	RAW VALUE (dBuV)	CORRECTION FACTOR (dB/m)
1	2390.00	65.7 PK	74.00	-8.3	1.01 H	274	33.83	31.84
2	2390.00	48.4 AV	54.00	-5.6	1.01 H	274	16.55	31.84
3	*2412.00	105.2 PK			1.01 H	274	73.29	31.92
4	*2412.00	94.9 AV			1.01 H	274	62.97	31.92
5	4824.00	47.2 PK	74.00	-26.8	1.10 H	136	9.36	37.83
6	4824.00	36.7 AV	54.00	-17.3	1.10 H	136	-1.11	37.83
ANTENNA POLARITY & TEST DISTANCE: VERTICAL AT 3 M								
NO.	FREQ. (MHz)	EMISSION LEVEL (dBuV/m)	LIMIT (dBuV/m)	MARGIN (dB)	ANTENNA HEIGHT (m)	TABLE ANGLE (Degree)	RAW VALUE (dBuV)	CORRECTION FACTOR (dB/m)
1	2390.00	68.3 PK	74.00	-5.7	1.16 V	227	36.43	31.84
2	2390.00	52.3 AV	54.00	-1.7	1.16 V	227	20.42	31.84
3	*2412.00	111.5 PK			1.13 V	232	79.56	31.92
4	*2412.00	100.8 AV			1.13 V	232	68.87	31.92
5	4824.00	48.2 PK	74.00	-25.8	1.24 V	258	10.41	37.83
6	4824.00	38.0 AV	54.00	-16.0	1.24 V	258	0.14	37.83

- REMARKS:**
1. Emission level (dBuV/m) = Raw Value (dBuV) + Correction Factor (dB/m).
 2. Correction Factor (dB/m) = Antenna Factor (dB/m) + Cable Factor (dB).
 3. The other emission levels were very low against the limit.
 4. Margin value = Emission level – Limit value.
 5. “ * “: Fundamental frequency.



A D T

EUT TEST CONDITION		MEASUREMENT DETAIL	
CHANNEL	Channel 6	FREQUENCY RANGE	1 ~ 25GHz
INPUT POWER (SYSTEM)	120Vac, 60 Hz	DETECTOR FUNCTION	Peak (PK) Average (AV)
ENVIRONMENTAL CONDITIONS	23deg. C, 70%RH 1000 hPa	TESTED BY	Lori Chiu

ANTENNA POLARITY & TEST DISTANCE: HORIZONTAL AT 3 M								
NO.	FREQ. (MHz)	EMISSION LEVEL (dBuV/m)	LIMIT (dBuV/m)	MARGIN (dB)	ANTENNA HEIGHT (m)	TABLE ANGLE (Degree)	RAW VALUE (dBuV)	CORRECTION FACTOR (dB/m)
1	*2437.00	105.2 PK			1.00 H	155	73.17	32.01
2	*2437.00	94.8 AV			1.00 H	155	62.81	32.01
3	4874.00	48.1 PK	74.00	-25.9	1.25 H	317	10.20	37.91
4	4874.00	38.0 AV	54.00	-16.0	1.25 H	317	0.09	37.91

ANTENNA POLARITY & TEST DISTANCE: VERTICAL AT 3 M								
NO.	FREQ. (MHz)	EMISSION LEVEL (dBuV/m)	LIMIT (dBuV/m)	MARGIN (dB)	ANTENNA HEIGHT (m)	TABLE ANGLE (Degree)	RAW VALUE (dBuV)	CORRECTION FACTOR (dB/m)
1	*2437.00	111.4 PK			1.11 V	221	79.38	32.01
2	*2437.00	100.7 AV			1.11 V	221	68.66	32.01
3	4874.00	48.6 PK	74.00	-25.4	1.25 V	36	10.73	37.91
4	4874.00	38.3 AV	54.00	-15.7	1.25 V	36	0.35	37.91

- REMARKS:**
1. Emission level (dBuV/m) = Raw Value (dBuV) + Correction Factor (dB/m).
 2. Correction Factor (dB/m) = Antenna Factor (dB/m) + Cable Factor (dB).
 3. The other emission levels were very low against the limit.
 4. Margin value = Emission level – Limit value.
 5. “ * “: Fundamental frequency.



A D T

EUT TEST CONDITION		MEASUREMENT DETAIL	
CHANNEL	Channel 11	FREQUENCY RANGE	1 ~ 25GHz
INPUT POWER (SYSTEM)	120Vac, 60 Hz	DETECTOR FUNCTION	Peak (PK) Average (AV)
ENVIRONMENTAL CONDITIONS	23deg. C, 70%RH 1000 hPa	TESTED BY	Lori Chiu

ANTENNA POLARITY & TEST DISTANCE: HORIZONTAL AT 3 M								
NO.	FREQ. (MHz)	EMISSION LEVEL (dBuV/m)	LIMIT (dBuV/m)	MARGIN (dB)	ANTENNA HEIGHT (m)	TABLE ANGLE (Degree)	RAW VALUE (dBuV)	CORRECTION FACTOR (dB/m)
1	*2462.00	104.0 PK			1.01 H	167	71.95	32.09
2	*2462.00	93.7 AV			1.01 H	167	61.60	32.09
3	2483.50	64.2 PK	74.00	-9.8	1.01 H	166	32.03	32.16
4	2483.50	47.6 AV	54.00	-6.4	1.01 H	166	15.47	32.16
5	4924.00	46.5 PK	74.00	-27.5	1.21 H	107	8.51	38.01
6	4924.00	38.1 AV	54.00	-15.9	1.21 H	107	0.08	38.01

ANTENNA POLARITY & TEST DISTANCE: VERTICAL AT 3 M								
NO.	FREQ. (MHz)	EMISSION LEVEL (dBuV/m)	LIMIT (dBuV/m)	MARGIN (dB)	ANTENNA HEIGHT (m)	TABLE ANGLE (Degree)	RAW VALUE (dBuV)	CORRECTION FACTOR (dB/m)
1	*2462.00	110.3 PK			1.08 V	152	78.16	32.09
2	*2462.00	99.6 AV			1.08 V	152	67.48	32.09
3	2483.50	69.4 PK	74.00	-4.6	1.08 V	232	37.25	32.16
4	2483.50	52.8 AV	54.00	-1.3	1.08 V	232	20.59	32.16
5	4924.00	47.6 PK	74.00	-26.4	1.10 V	112	9.62	38.01
6	4924.00	37.4 AV	54.00	-16.6	1.10 V	112	-0.61	38.01

- REMARKS:**
1. Emission level (dBuV/m) = Raw Value (dBuV) + Correction Factor (dB/m).
 2. Correction Factor (dB/m) = Antenna Factor (dB/m) + Cable Factor (dB).
 3. The other emission levels were very low against the limit.
 4. Margin value = Emission level – Limit value.
 5. “ * “: Fundamental frequency.



A D T

802.11n (20MHz)

EUT TEST CONDITION		MEASUREMENT DETAIL	
CHANNEL	Channel 1	FREQUENCY RANGE	1 ~ 25GHz
INPUT POWER (SYSTEM)	120Vac, 60 Hz	DETECTOR FUNCTION	Peak (PK) Average (AV)
ENVIRONMENTAL CONDITIONS	23deg. C, 70%RH 1000 hPa	TESTED BY	Lori Chiu

ANTENNA POLARITY & TEST DISTANCE: HORIZONTAL AT 3 M								
NO.	FREQ. (MHz)	EMISSION LEVEL (dBuV/m)	LIMIT (dBuV/m)	MARGIN (dB)	ANTENNA HEIGHT (m)	TABLE ANGLE (Degree)	RAW VALUE (dBuV)	CORRECTION FACTOR (dB/m)
1	2390.00	65.8 PK	74.00	-8.2	1.00 H	216	33.95	31.84
2	2390.00	48.5 AV	54.00	-5.5	1.00 H	216	16.62	31.84
3	*2412.00	105.7 PK			1.00 H	216	73.80	31.92
4	*2412.00	95.2 AV			1.00 H	216	63.30	31.92
5	4824.00	48.1 PK	74.00	-26.0	1.25 H	188	10.22	37.83
6	4824.00	36.7 AV	54.00	-17.3	1.25 H	188	-1.10	37.83
ANTENNA POLARITY & TEST DISTANCE: VERTICAL AT 3 M								
NO.	FREQ. (MHz)	EMISSION LEVEL (dBuV/m)	LIMIT (dBuV/m)	MARGIN (dB)	ANTENNA HEIGHT (m)	TABLE ANGLE (Degree)	RAW VALUE (dBuV)	CORRECTION FACTOR (dB/m)
1	2390.00	72.2 PK	74.00	-1.8	1.14 V	231	40.34	31.84
2	2390.00	52.6 AV	54.00	-1.4	1.14 V	231	20.75	31.84
3	*2412.00	112.1 PK			1.11 V	146	80.21	31.92
4	*2412.00	101.7 AV			1.11 V	146	69.73	31.92
5	4824.00	48.1 PK	74.00	-25.9	1.10 V	274	10.25	37.83
6	4824.00	37.8 AV	54.00	-16.3	1.10 V	274	-0.08	37.83

- REMARKS:**
1. Emission level (dBuV/m) = Raw Value (dBuV) + Correction Factor (dB/m).
 2. Correction Factor (dB/m) = Antenna Factor (dB/m) + Cable Factor (dB).
 3. The other emission levels were very low against the limit.
 4. Margin value = Emission level – Limit value.
 5. “ * “: Fundamental frequency.



A D T

EUT TEST CONDITION		MEASUREMENT DETAIL	
CHANNEL	Channel 6	FREQUENCY RANGE	1 ~ 25GHz
INPUT POWER (SYSTEM)	120Vac, 60 Hz	DETECTOR FUNCTION	Peak (PK) Average (AV)
ENVIRONMENTAL CONDITIONS	23deg. C, 70%RH 1000 hPa	TESTED BY	Lori Chiu

ANTENNA POLARITY & TEST DISTANCE: HORIZONTAL AT 3 M								
NO.	FREQ. (MHz)	EMISSION LEVEL (dBuV/m)	LIMIT (dBuV/m)	MARGIN (dB)	ANTENNA HEIGHT (m)	TABLE ANGLE (Degree)	RAW VALUE (dBuV)	CORRECTION FACTOR (dB/m)
1	*2437.00	105.8 PK			1.01 H	220	73.79	32.01
2	*2437.00	95.4 AV			1.01 H	220	63.36	32.01
3	4874.00	48.0 PK	74.00	-26.0	1.32 H	167	10.10	37.91
4	4874.00	37.2 AV	54.00	-16.8	1.32 H	167	-0.72	37.91
ANTENNA POLARITY & TEST DISTANCE: VERTICAL AT 3 M								
NO.	FREQ. (MHz)	EMISSION LEVEL (dBuV/m)	LIMIT (dBuV/m)	MARGIN (dB)	ANTENNA HEIGHT (m)	TABLE ANGLE (Degree)	RAW VALUE (dBuV)	CORRECTION FACTOR (dB/m)
1	*2437.00	112.6 PK			1.14 V	231	80.62	32.01
2	*2437.00	101.9 AV			1.14 V	231	69.85	32.01
3	4874.00	48.4 PK	74.00	-25.6	1.16 V	251	10.47	37.91
4	4874.00	38.2 AV	54.00	-15.8	1.16 V	251	0.27	37.91

- REMARKS:**
1. Emission level (dBuV/m) = Raw Value (dBuV) + Correction Factor (dB/m).
 2. Correction Factor (dB/m) = Antenna Factor (dB/m) + Cable Factor (dB).
 3. The other emission levels were very low against the limit.
 4. Margin value = Emission level – Limit value.
 5. “ * “: Fundamental frequency.



A D T

EUT TEST CONDITION		MEASUREMENT DETAIL	
CHANNEL	Channel 11	FREQUENCY RANGE	1 ~ 25GHz
INPUT POWER (SYSTEM)	120Vac, 60 Hz	DETECTOR FUNCTION	Peak (PK) Average (AV)
ENVIRONMENTAL CONDITIONS	23deg. C, 70%RH 1000 hPa	TESTED BY	Lori Chiu

ANTENNA POLARITY & TEST DISTANCE: HORIZONTAL AT 3 M								
NO.	FREQ. (MHz)	EMISSION LEVEL (dBuV/m)	LIMIT (dBuV/m)	MARGIN (dB)	ANTENNA HEIGHT (m)	TABLE ANGLE (Degree)	RAW VALUE (dBuV)	CORRECTION FACTOR (dB/m)
1	*2462.00	104.7 PK			1.05 H	22	72.64	32.09
2	*2462.00	94.2 AV			1.05 H	22	62.15	32.09
3	2483.50	64.3 PK	74.00	-9.7	1.05 H	22	32.10	32.16
4	2483.50	47.8 AV	54.00	-6.2	1.05 H	22	15.61	32.16
5	4924.00	46.7 PK	74.00	-27.3	1.01 H	115	8.65	38.01
6	4924.00	38.2 AV	54.00	-15.8	1.01 H	115	0.15	38.01
ANTENNA POLARITY & TEST DISTANCE: VERTICAL AT 3 M								
NO.	FREQ. (MHz)	EMISSION LEVEL (dBuV/m)	LIMIT (dBuV/m)	MARGIN (dB)	ANTENNA HEIGHT (m)	TABLE ANGLE (Degree)	RAW VALUE (dBuV)	CORRECTION FACTOR (dB/m)
1	*2462.00	111.0 PK			1.09 V	150	78.95	32.09
2	*2462.00	100.6 AV			1.09 V	150	68.55	32.09
3	2483.50	71.8 PK	74.00	-2.2	1.08 V	233	39.68	32.16
4	2483.50	52.8 AV	54.00	-1.2	1.08 V	233	20.67	32.16
5	4924.00	47.5 PK	74.00	-26.5	1.09 V	270	9.52	38.01
6	4924.00	37.1 AV	54.00	-16.9	1.09 V	270	-0.92	38.01

- REMARKS:**
1. Emission level (dBuV/m) = Raw Value (dBuV) + Correction Factor (dB/m).
 2. Correction Factor (dB/m) = Antenna Factor (dB/m) + Cable Factor (dB).
 3. The other emission levels were very low against the limit.
 4. Margin value = Emission level – Limit value.
 5. “ * “: Fundamental frequency.



A D T

802.11n (40MHz)

EUT TEST CONDITION		MEASUREMENT DETAIL	
CHANNEL	Channel 1	FREQUENCY RANGE	1 ~ 25GHz
INPUT POWER (SYSTEM)	120Vac, 60 Hz	DETECTOR FUNCTION	Peak (PK) Average (AV)
ENVIRONMENTAL CONDITIONS	23deg. C, 70%RH 1000 hPa	TESTED BY	Lori Chiu

ANTENNA POLARITY & TEST DISTANCE: HORIZONTAL AT 3 M								
NO.	FREQ. (MHz)	EMISSION LEVEL (dBuV/m)	LIMIT (dBuV/m)	MARGIN (dB)	ANTENNA HEIGHT (m)	TABLE ANGLE (Degree)	RAW VALUE (dBuV)	CORRECTION FACTOR (dB/m)
1	2390.00	61.9 PK	74.00	-12.2	1.00 H	216	30.01	31.84
2	2390.00	48.2 AV	54.00	-5.8	1.00 H	216	16.37	31.84
3	*2422.00	101.7 PK			1.00 H	216	69.79	31.95
4	*2422.00	91.6 AV			1.00 H	216	59.67	31.95
5	4844.00	47.3 PK	74.00	-26.7	1.11 H	315	9.46	37.86
6	4844.00	37.1 AV	54.00	-16.9	1.11 H	315	-0.76	37.86
ANTENNA POLARITY & TEST DISTANCE: VERTICAL AT 3 M								
NO.	FREQ. (MHz)	EMISSION LEVEL (dBuV/m)	LIMIT (dBuV/m)	MARGIN (dB)	ANTENNA HEIGHT (m)	TABLE ANGLE (Degree)	RAW VALUE (dBuV)	CORRECTION FACTOR (dB/m)
1	2390.00	69.4 PK	74.00	-4.6	1.14 V	228	37.53	31.84
2	2390.00	52.7 AV	54.00	-1.3	1.14 V	228	20.85	31.84
3	*2422.00	108.5 PK			1.12 V	228	76.54	31.95
4	*2422.00	98.0 AV			1.12 V	228	66.04	31.95
5	4844.00	47.9 PK	74.00	-26.1	1.22 V	64	10.03	37.86
6	4844.00	37.3 AV	54.00	-16.7	1.22 V	64	-0.59	37.86

- REMARKS:**
1. Emission level (dBuV/m) = Raw Value (dBuV) + Correction Factor (dB/m).
 2. Correction Factor (dB/m) = Antenna Factor (dB/m) + Cable Factor (dB).
 3. The other emission levels were very low against the limit.
 4. Margin value = Emission level – Limit value.
 5. “ * “: Fundamental frequency.



A D T

EUT TEST CONDITION		MEASUREMENT DETAIL	
CHANNEL	Channel 4	FREQUENCY RANGE	1 ~ 25GHz
INPUT POWER (SYSTEM)	120Vac, 60 Hz	DETECTOR FUNCTION	Peak (PK) Average (AV)
ENVIRONMENTAL CONDITIONS	23deg. C, 70%RH 1000 hPa	TESTED BY	Lori Chiu

ANTENNA POLARITY & TEST DISTANCE: HORIZONTAL AT 3 M								
NO.	FREQ. (MHz)	EMISSION LEVEL (dBuV/m)	LIMIT (dBuV/m)	MARGIN (dB)	ANTENNA HEIGHT (m)	TABLE ANGLE (Degree)	RAW VALUE (dBuV)	CORRECTION FACTOR (dB/m)
1	*2437.00	101.7 PK			1.01 H	255	69.68	32.01
2	*2437.00	91.6 AV			1.01 H	255	59.57	32.01
3	4874.00	47.1 PK	74.00	-26.9	1.52 H	277	9.23	37.91
4	4874.00	37.1 AV	54.00	-16.9	1.52 H	277	-0.85	37.91
ANTENNA POLARITY & TEST DISTANCE: VERTICAL AT 3 M								
NO.	FREQ. (MHz)	EMISSION LEVEL (dBuV/m)	LIMIT (dBuV/m)	MARGIN (dB)	ANTENNA HEIGHT (m)	TABLE ANGLE (Degree)	RAW VALUE (dBuV)	CORRECTION FACTOR (dB/m)
1	*2437.00	108.5 PK			1.11 V	235	76.49	32.01
2	*2437.00	98.0 AV			1.11 V	235	65.98	32.01
3	4874.00	47.7 PK	74.00	-26.3	1.09 V	182	9.77	37.91
4	4874.00	37.2 AV	54.00	-16.8	1.09 V	182	-0.71	37.91

- REMARKS:**
1. Emission level (dBuV/m) = Raw Value (dBuV) + Correction Factor (dB/m).
 2. Correction Factor (dB/m) = Antenna Factor (dB/m) + Cable Factor (dB).
 3. The other emission levels were very low against the limit.
 4. Margin value = Emission level – Limit value.
 5. “ * “: Fundamental frequency.



A D T

EUT TEST CONDITION		MEASUREMENT DETAIL	
CHANNEL	Channel 7	FREQUENCY RANGE	1 ~ 25GHz
INPUT POWER (SYSTEM)	120Vac, 60 Hz	DETECTOR FUNCTION	Peak (PK) Average (AV)
ENVIRONMENTAL CONDITIONS	23deg. C, 70%RH 1000 hPa	TESTED BY	Lori Chiu

ANTENNA POLARITY & TEST DISTANCE: HORIZONTAL AT 3 M								
NO.	FREQ. (MHz)	EMISSION LEVEL (dBuV/m)	LIMIT (dBuV/m)	MARGIN (dB)	ANTENNA HEIGHT (m)	TABLE ANGLE (Degree)	RAW VALUE (dBuV)	CORRECTION FACTOR (dB/m)
1	*2452.00	99.7 PK			1.01 H	178	67.61	32.06
2	*2452.00	89.8 AV			1.01 H	178	57.74	32.06
3	2483.50	61.8 PK	74.00	-12.2	1.01 H	178	29.65	32.16
4	2483.50	48.2 AV	54.00	-5.8	1.01 H	178	16.03	32.16
5	4904.00	46.7 PK	74.00	-27.3	1.25 H	5	8.73	37.96
6	4904.00	36.4 AV	54.00	-17.6	1.25 H	5	-1.58	37.96
ANTENNA POLARITY & TEST DISTANCE: VERTICAL AT 3 M								
NO.	FREQ. (MHz)	EMISSION LEVEL (dBuV/m)	LIMIT (dBuV/m)	MARGIN (dB)	ANTENNA HEIGHT (m)	TABLE ANGLE (Degree)	RAW VALUE (dBuV)	CORRECTION FACTOR (dB/m)
1	*2452.00	106.4 PK			1.12 V	234	74.38	32.06
2	*2452.00	96.1 AV			1.12 V	234	64.05	32.06
3	2483.50	69.2 PK	74.00	-4.9	1.10 V	233	36.99	32.16
4	2483.50	52.8 AV	54.00	-1.2	1.10 V	233	20.62	32.16
5	4904.00	47.0 PK	74.00	-27.0	1.23 V	216	9.05	37.96
6	4904.00	37.1 AV	54.00	-16.9	1.23 V	216	-0.85	37.96

- REMARKS:**
1. Emission level (dBuV/m) = Raw Value (dBuV) + Correction Factor (dB/m).
 2. Correction Factor (dB/m) = Antenna Factor (dB/m) + Cable Factor (dB).
 3. The other emission levels were very low against the limit.
 4. Margin value = Emission level – Limit value.
 5. “ * “: Fundamental frequency.



A D T

BELOW 1GHz WORST-CASE DATA : 802.11g

EUT TEST CONDITION		MEASUREMENT DETAIL	
CHANNEL	Channel 6	FREQUENCY RANGE	Below 1000MHz
INPUT POWER (SYSTEM)	120Vac, 60 Hz	DETECTOR FUNCTION	Quasi-Peak
ENVIRONMENTAL CONDITIONS	23deg. C, 70%RH 999 hPa	TEST MODE	A
TESTED BY	Lori Chiu		

ANTENNA POLARITY & TEST DISTANCE: HORIZONTAL AT 3 M								
NO.	FREQ. (MHz)	EMISSION LEVEL (dBuV/m)	LIMIT (dBuV/m)	MARGIN (dB)	ANTENNA HEIGHT (m)	TABLE ANGLE (Degree)	RAW VALUE (dBuV)	CORRECTION FACTOR (dB/m)
1	191.28	34.4 QP	43.50	-9.1	1.75 H	292	23.09	11.29
2	500.42	37.1 QP	46.00	-8.9	1.75 H	217	17.86	19.25
3	593.74	37.3 QP	46.00	-8.7	1.50 H	229	15.54	21.77
4	743.45	40.9 QP	46.00	-5.1	1.00 H	223	17.07	23.79
5	786.23	35.4 QP	46.00	-10.6	1.00 H	10	10.45	24.94
6	912.61	35.7 QP	46.00	-10.3	1.75 H	100	9.50	26.21
7	949.55	40.8 QP	46.00	-5.2	2.00 H	145	14.28	26.49
ANTENNA POLARITY & TEST DISTANCE: VERTICAL AT 3 M								
NO.	FREQ. (MHz)	EMISSION LEVEL (dBuV/m)	LIMIT (dBuV/m)	MARGIN (dB)	ANTENNA HEIGHT (m)	TABLE ANGLE (Degree)	RAW VALUE (dBuV)	CORRECTION FACTOR (dB/m)
1	30.00	37.8 QP	40.00	-2.3	1.00 V	10	25.47	12.28
2	90.17	33.5 QP	43.50	-10.0	1.00 V	298	24.30	9.22
3	144.61	40.9 QP	43.50	-2.6	1.25 V	256	27.71	13.16
4	467.36	36.5 QP	46.00	-9.5	1.00 V	211	18.25	18.25
5	743.45	39.8 QP	46.00	-6.2	1.25 V	193	16.01	23.79
6	891.22	36.4 QP	46.00	-9.6	1.00 V	190	10.42	26.03
7	949.55	40.9 QP	46.00	-5.1	2.00 V	295	14.38	26.49

- REMARKS:**
1. Emission level (dBuV/m) = Raw Value (dBuV) + Correction Factor (dB/m).
 2. Correction Factor (dB/m) = Antenna Factor (dB/m) + Cable Factor (dB).
 3. The other emission levels were very low against the limit.
 4. Margin value = Emission level – Limit value.



A D T

EUT TEST CONDITION		MEASUREMENT DETAIL	
CHANNEL	Channel 6	FREQUENCY RANGE	Below 1000MHz
INPUT POWER (SYSTEM)	120Vac, 60 Hz	DETECTOR FUNCTION	Quasi-Peak
ENVIRONMENTAL CONDITIONS	23deg. C, 70%RH 999 hPa	TEST MODE	B
TESTED BY	Lori Chiu		

ANTENNA POLARITY & TEST DISTANCE: HORIZONTAL AT 3 M								
NO.	FREQ. (MHz)	EMISSION LEVEL (dBuV/m)	LIMIT (dBuV/m)	MARGIN (dB)	ANTENNA HEIGHT (m)	TABLE ANGLE (Degree)	RAW VALUE (dBuV)	CORRECTION FACTOR (dB/m)
1	169.89	32.8 QP	43.50	-10.7	1.25 H	100	19.87	12.96
2	206.83	32.3 QP	43.50	-11.2	1.00 H	268	21.40	10.90
3	296.27	34.0 QP	46.00	-12.0	1.25 H	151	20.43	13.61
4	593.74	38.5 QP	46.00	-7.5	1.50 H	217	16.71	21.77
5	743.45	42.0 QP	46.00	-4.0	1.00 H	214	18.21	23.79
6	786.23	40.5 QP	46.00	-5.5	1.00 H	217	15.53	24.94
ANTENNA POLARITY & TEST DISTANCE: VERTICAL AT 3 M								
NO.	FREQ. (MHz)	EMISSION LEVEL (dBuV/m)	LIMIT (dBuV/m)	MARGIN (dB)	ANTENNA HEIGHT (m)	TABLE ANGLE (Degree)	RAW VALUE (dBuV)	CORRECTION FACTOR (dB/m)
1	30.00	36.2 QP	40.00	-3.8	1.00 V	343	23.89	12.28
2	62.95	33.2 QP	40.00	-6.8	1.50 V	292	20.35	12.85
3	107.67	32.7 QP	43.50	-10.9	1.25 V	151	22.39	10.26
4	296.27	34.2 QP	46.00	-11.8	1.50 V	166	20.63	13.61
5	360.43	35.2 QP	46.00	-10.8	1.50 V	184	20.06	15.10
6	445.98	36.2 QP	46.00	-9.8	1.25 V	175	18.66	17.59
7	500.42	34.1 QP	46.00	-11.9	1.00 V	220	14.87	19.25
8	743.45	38.7 QP	46.00	-7.3	1.25 V	184	14.94	23.79
9	807.62	34.4 QP	46.00	-11.6	1.00 V	10	9.06	25.37
10	891.22	36.7 QP	46.00	-9.3	1.00 V	184	10.67	26.03

- REMARKS:**
1. Emission level (dBuV/m) = Raw Value (dBuV) + Correction Factor (dB/m).
 2. Correction Factor (dB/m) = Antenna Factor (dB/m) + Cable Factor (dB).
 3. The other emission levels were very low against the limit.
 4. Margin value = Emission level – Limit value.



4.2 CONDUCTED EMISSION MEASUREMENT

4.2.1 LIMITS OF CONDUCTED EMISSION MEASUREMENT

FREQUENCY OF EMISSION (MHz)	CONDUCTED LIMIT (dBµV)	
	Quasi-peak	Average
0.15 ~ 0.5	66 to 56	56 to 46
0.5 ~ 5	56	46
5 ~ 30	60	50

- NOTE:**
1. The lower limit shall apply at the transition frequencies.
 2. The limit decreases in line with the logarithm of the frequency in the range of 0.15 to 0.50MHz.
 3. All emanations from a class A/B digital device or system, including any network of conductors and apparatus connected thereto, shall not exceed the level of field strengths specified above.

4.2.2 TEST INSTRUMENTS

DESCRIPTION & MANUFACTURER	MODEL NO.	SERIAL NO.	DATE OF CALIBRATION	DUE DATE OF CALIBRATION
Test Receiver ROHDE & SCHWARZ	ESCS30	100288	Sep. 24, 2009	Sep. 23, 2010
RF signal cable Woken	5D-FB	Cable-HYCO2-01	Dec. 31, 2008	Dec. 30, 2009
LISN ROHDE & SCHWARZ	ESH2-Z5	100100	Dec. 29, 2008	Dec. 28, 2009
LISN ROHDE & SCHWARZ	ESH3-Z5	100311	Jul. 29, 2009	Jul. 28, 2010
Software ADT	ADT_Cond_ V7.3.7	NA	NA	NA

- NOTE:**
1. The calibration interval of the above test instruments is 12 months and the calibrations are traceable to NML/ROC and NIST/USA.
 2. The test was performed in HwaYa Shielded Room 2.
 3. The VCCI Site Registration No. is C-2047.



A D T

4.2.3 TEST PROCEDURES

- a. The EUT was placed 0.4 meters from the conducting wall of the shielded room with EUT being connected to the power mains through a line impedance stabilization network (LISN). Other support units were connected to the power mains through another LISN. The two LISNs provide 50 ohm/ 50uH of coupling impedance for the measuring instrument.
- b. Both lines of the power mains connected to the EUT were checked for maximum conducted interference.
- c. The frequency range from 150kHz to 30MHz was searched. Emission levels under (Limit - 20dB) was not recorded.

NOTE: All modes of operation were investigated and the worst-case emissions are reported.

4.2.4 DEVIATION FROM TEST STANDARD

No deviation.

4.2.5 TEST SETUP

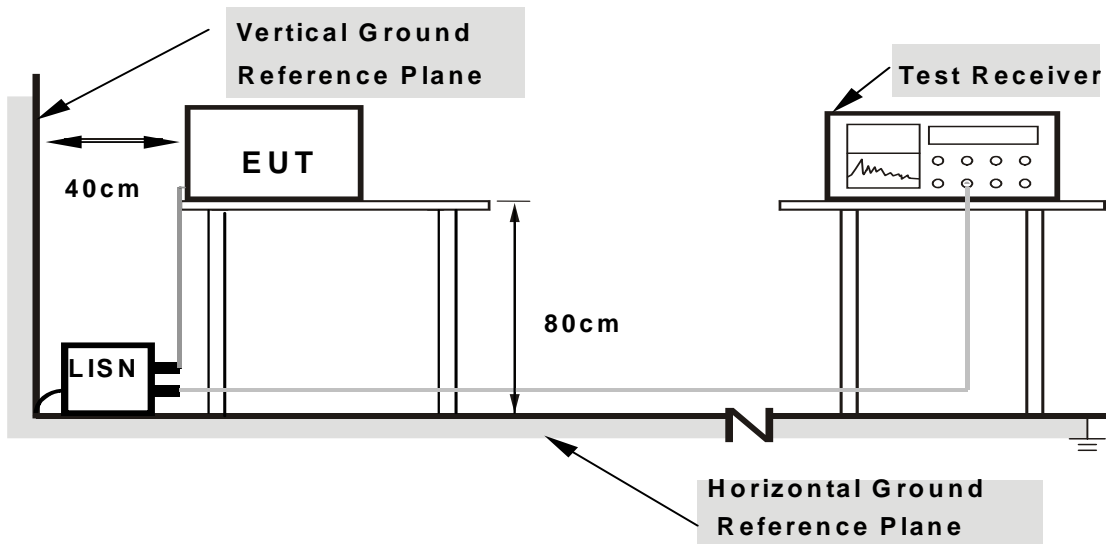

- Note:**
1. Support units were connected to second LISN.
 2. Both of LISNs (AMN) are 80 cm from EUT and at least 80 from other units and other metal planes

For the actual test configuration, please refer to the attached file (Test Setup Photo).

4.2.6 EUT OPERATING CONDITIONS

Same as 4.1.6.

4.2.7 TEST RESULTS

CONDUCTED WORST-CASE DATA : 802.11g

PHASE	Line 1	6dB BANDWIDTH	9kHz
TEST MODE	A		

No	Freq. [MHz]	Corr. Factor (dB)	Reading Value [dB (uV)]		Emission Level [dB (uV)]		Limit [dB (uV)]		Margin (dB)	
			Q.P.	AV.	Q.P.	AV.	Q.P.	AV.	Q.P.	AV.
1	0.173	0.13	40.44	-	40.57	-	64.79	54.79	-24.22	-
2	0.228	0.13	35.39	-	35.52	-	62.52	52.52	-27.00	-
3	0.662	0.15	35.13	-	35.28	-	56.00	46.00	-20.72	-
4	2.836	0.23	37.10	-	37.33	-	56.00	46.00	-18.67	-
5	9.613	0.42	37.07	-	37.49	-	60.00	50.00	-22.51	-
6	11.574	0.47	34.84	-	35.31	-	60.00	50.00	-24.69	-

- REMARKS:**
1. Q.P. and AV. are abbreviations of quasi-peak and average individually.
 2. "-": The Quasi-peak reading value also meets average limit and measurement with the average detector is unnecessary.
 3. The emission levels of other frequencies were very low against the limit.
 4. Margin value = Emission level - Limit value
 5. Correction factor = Insertion loss + Cable loss
 6. Emission Level = Correction Factor + Reading Value.

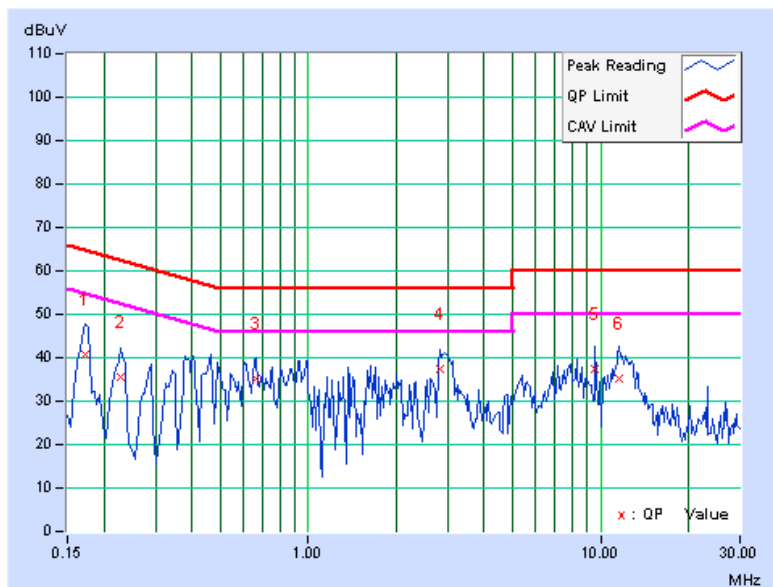



A D T

PHASE	Line 2	6dB BANDWIDTH	9kHz
TEST MODE	A		

No	Freq. [MHz]	Corr. Factor (dB)	Reading Value		Emission Level		Limit		Margin	
			[dB (uV)]		[dB (uV)]		[dB (uV)]		(dB)	
			Q.P.	AV.	Q.P.	AV.	Q.P.	AV.	Q.P.	AV.
1	0.173	0.13	40.93	-	41.06	-	64.79	54.79	-23.73	-
2	0.404	0.15	42.25	-	42.40	-	57.77	47.77	-15.37	-
3	0.463	0.15	40.95	-	41.10	-	56.65	46.65	-15.55	-
4	0.806	0.16	37.03	-	37.19	-	56.00	46.00	-18.81	-
5	3.016	0.25	41.61	-	41.86	-	56.00	46.00	-14.14	-
6	8.621	0.45	38.63	-	39.08	-	60.00	50.00	-20.92	-

- REMARKS:**
1. Q.P. and AV. are abbreviations of quasi-peak and average individually.
 2. "-": The Quasi-peak reading value also meets average limit and measurement with the average detector is unnecessary.
 3. The emission levels of other frequencies were very low against the limit.
 4. Margin value = Emission level - Limit value
 5. Correction factor = Insertion loss + Cable loss
 6. Emission Level = Correction Factor + Reading Value.

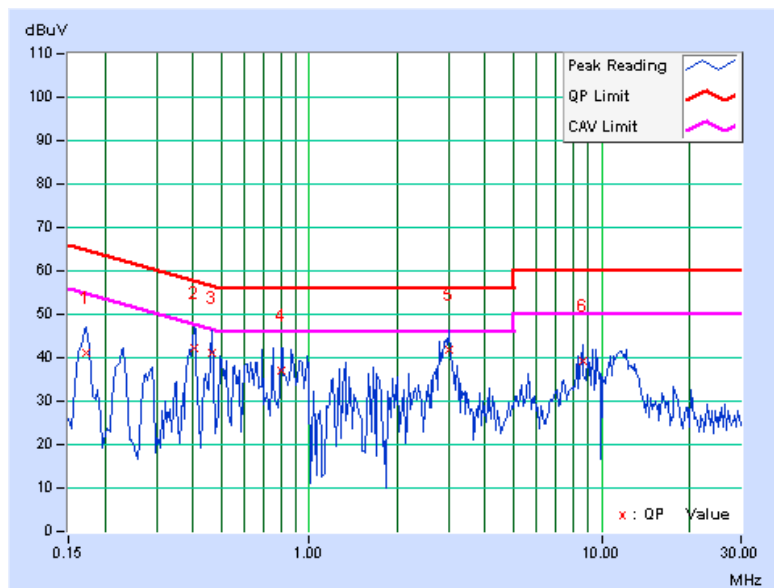



A D T

PHASE	Line 1	6dB BANDWIDTH	9kHz
TEST MODE	B		

No	Freq. [MHz]	Corr. Factor (dB)	Reading Value		Emission Level		Limit		Margin	
			[dB (uV)]		[dB (uV)]		[dB (uV)]		(dB)	
			Q.P.	AV.	Q.P.	AV.	Q.P.	AV.	Q.P.	AV.
1	0.166	0.13	37.53	-	37.66	-	65.18	55.18	-27.52	-
2	0.330	0.14	32.72	-	32.86	-	59.46	49.46	-26.60	-
3	1.379	0.18	16.82	-	17.00	-	56.00	46.00	-39.00	-
4	9.266	0.41	28.95	-	29.36	-	60.00	50.00	-30.64	-
5	14.336	0.54	23.00	-	23.54	-	60.00	50.00	-36.46	-
6	27.160	0.63	27.45	-	28.08	-	60.00	50.00	-31.92	-

- REMARKS:**
1. Q.P. and AV. are abbreviations of quasi-peak and average individually.
 2. "-": The Quasi-peak reading value also meets average limit and measurement with the average detector is unnecessary.
 3. The emission levels of other frequencies were very low against the limit.
 4. Margin value = Emission level - Limit value
 5. Correction factor = Insertion loss + Cable loss
 6. Emission Level = Correction Factor + Reading Value.

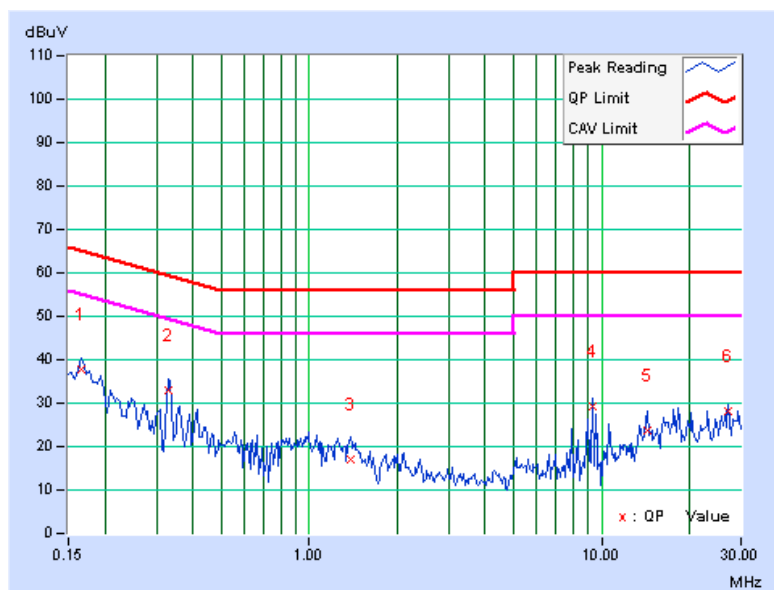

PHASE	Line 2	6dB BANDWIDTH	9kHz
TEST MODE	B		

No	Freq.	Corr.	Reading Value		Emission Level		Limit		Margin	
	[MHz]	Factor (dB)	[dB (uV)]		[dB (uV)]		[dB (uV)]		(dB)	
			Q.P.	AV.	Q.P.	AV.	Q.P.	AV.	Q.P.	AV.
1	0.166	0.13	38.33	-	38.46	-	65.18	55.18	-26.72	-
2	0.334	0.14	34.02	-	34.16	-	59.36	49.36	-25.20	-
3	1.965	0.20	18.77	-	18.97	-	56.00	46.00	-37.03	-
4	8.273	0.44	21.16	-	21.60	-	60.00	50.00	-38.40	-
5	16.230	0.70	24.33	-	25.03	-	60.00	50.00	-34.97	-
6	23.129	0.80	25.76	-	26.56	-	60.00	50.00	-33.44	-

- REMARKS:**
1. Q.P. and AV. are abbreviations of quasi-peak and average individually.
 2. "-": The Quasi-peak reading value also meets average limit and measurement with the average detector is unnecessary.
 3. The emission levels of other frequencies were very low against the limit.
 4. Margin value = Emission level - Limit value
 5. Correction factor = Insertion loss + Cable loss
 6. Emission Level = Correction Factor + Reading Value.

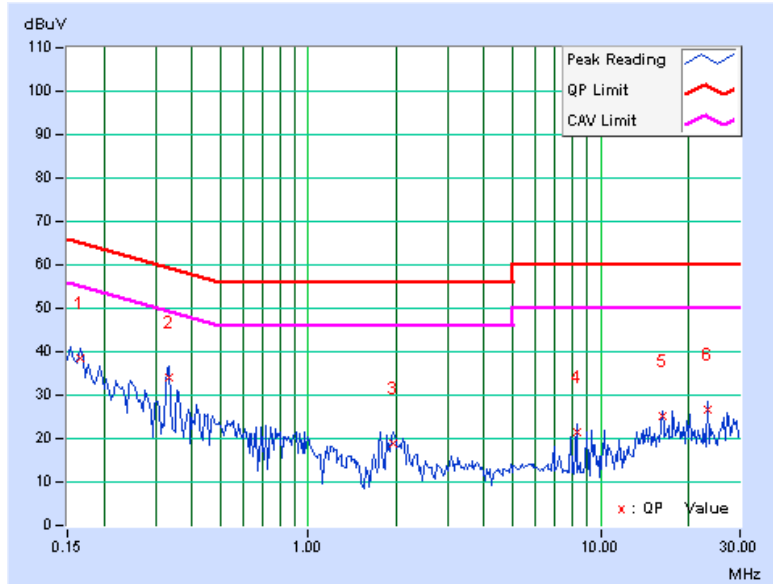



A D T

4.3 6dB BANDWIDTH MEASUREMENT

4.3.1 LIMITS OF 6dB BANDWIDTH MEASUREMENT

The minimum of 6dB Bandwidth Measurement is 0.5 MHz.

4.3.2 TEST INSTRUMENTS

DESCRIPTION & MANUFACTURER	MODEL NO.	SERIAL NO.	DATE OF CALIBRATION	CALIBRATED UNTIL
R&S SPECTRUM ANALYZER	FSP40	100040	Jul. 07, 2009	Jul. 06, 2010

NOTE: The calibration interval of the above test instruments is 12 months and the calibrations are traceable to NML/ROC and NIST/USA.

4.3.3 TEST PROCEDURE

The transmitter output was connected to the spectrum analyzer through an attenuator. The bandwidth of the fundamental frequency was measured by spectrum analyzer with 100kHz RBW and 300kHz VBW. The 6dB bandwidth is defined as the total spectrum the power of which is higher than peak power minus 6dB.

4.3.4 DEVIATION FROM TEST STANDARD

No deviation.

4.3.5 TEST SETUP

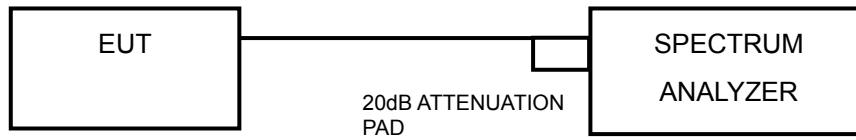

4.3.6 EUT OPERATING CONDITIONS

The software provided by client to enable the EUT under transmission condition continuously at lowest, middle and highest channel frequencies individually.



A D T

4.3.7 TEST RESULTS

802.11b

CHANNEL	CHANNEL FREQUENCY (MHz)	6dB BANDWIDTH (MHz)	MINIMUM LIMIT (MHz)	PASS / FAIL
1	2412	10.11	0.5	PASS
6	2437	10.11	0.5	PASS
11	2462	10.12	0.5	PASS

CH 11

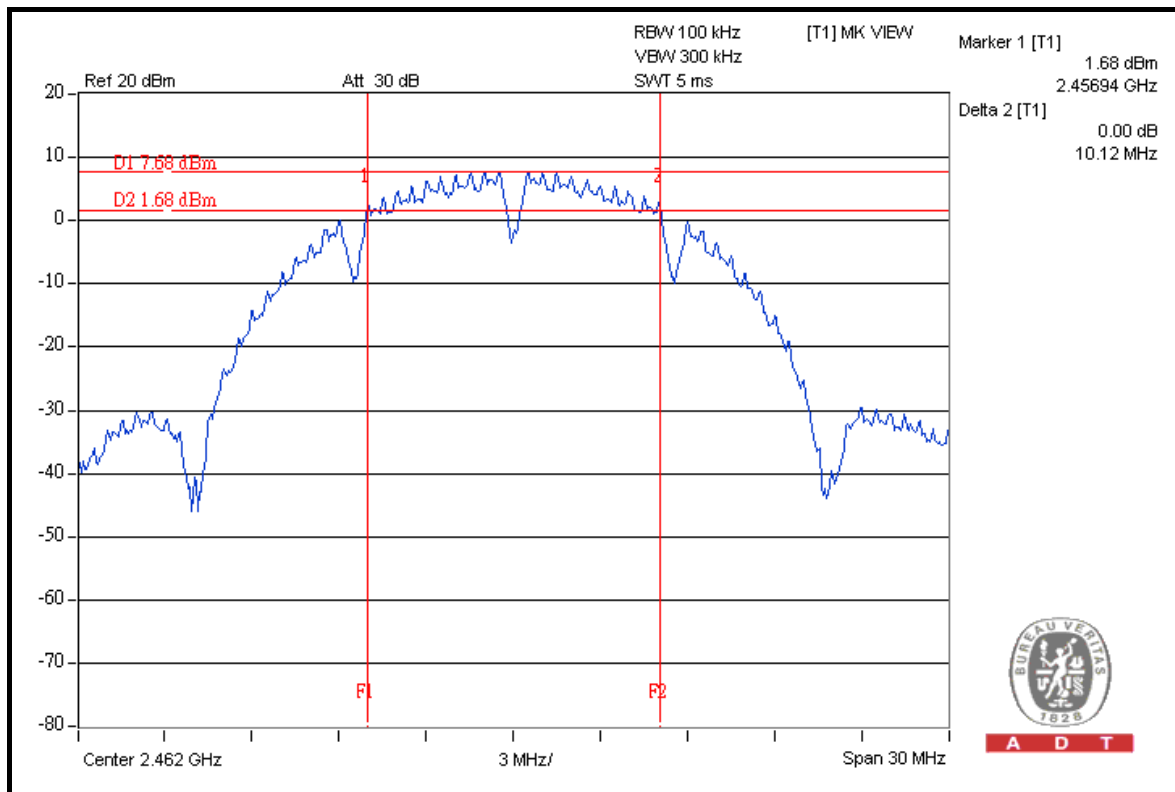



A D T

802.11g

CHANNEL	CHANNEL FREQUENCY (MHz)	6dB BANDWIDTH (MHz)	MINIMUM LIMIT (MHz)	PASS / FAIL
1	2412	16.57	0.5	PASS
6	2437	16.58	0.5	PASS
11	2462	16.56	0.5	PASS

CH 6

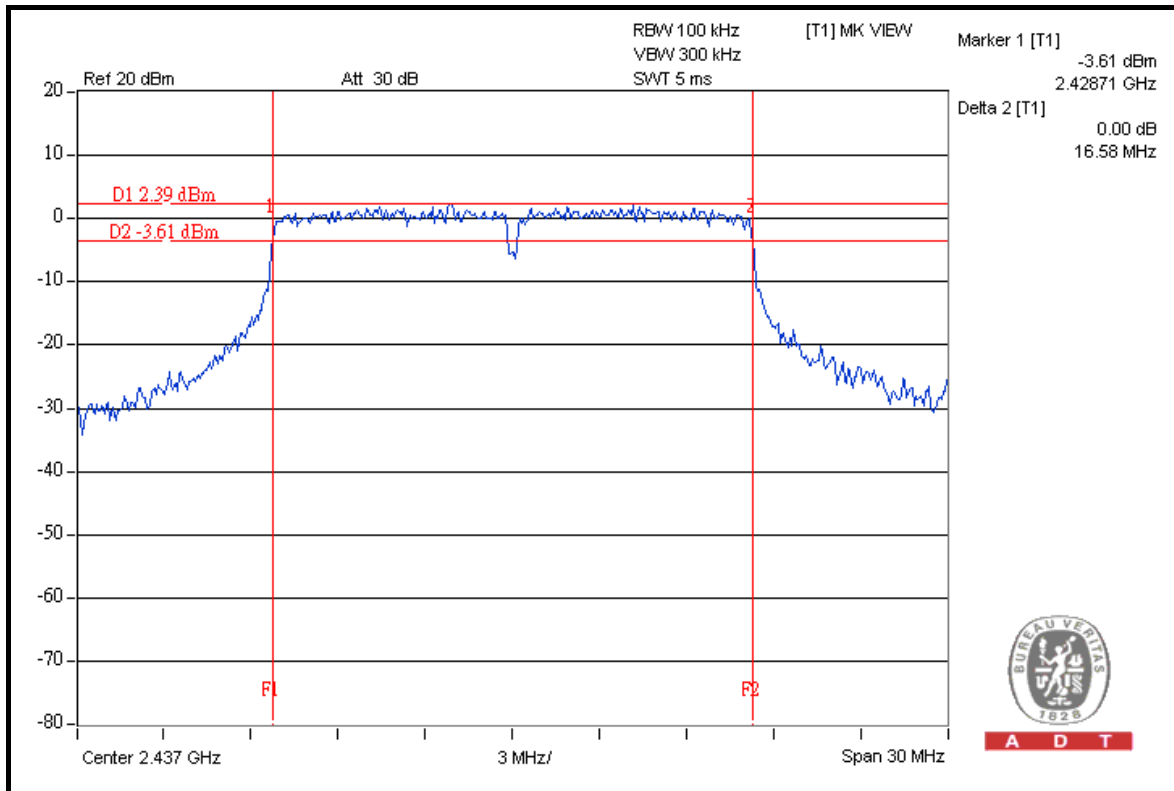



A D T

802.11n (20MHz)

CHANNEL	CHANNEL FREQUENCY (MHz)	6dB BANDWIDTH (MHz)	MINIMUM LIMIT (MHz)	PASS / FAIL
1	2412	17.79	0.5	PASS
6	2437	17.77	0.5	PASS
11	2462	17.76	0.5	PASS

CH 1

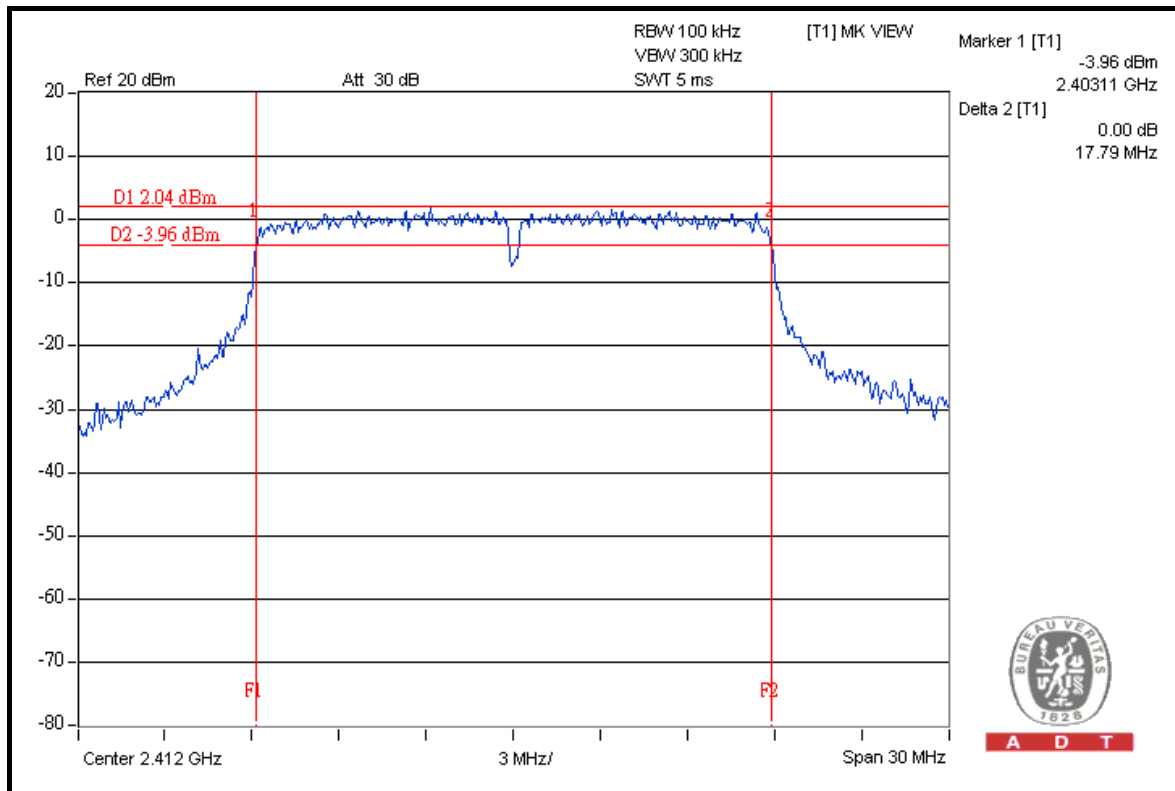



A D T

802.11n (40MHz)

CHANNEL	CHANNEL FREQUENCY (MHz)	6dB BANDWIDTH (MHz)	MINIMUM LIMIT (MHz)	PASS / FAIL
1	2422	36.52	0.5	PASS
4	2437	36.55	0.5	PASS
7	2452	36.54	0.5	PASS

CH 4

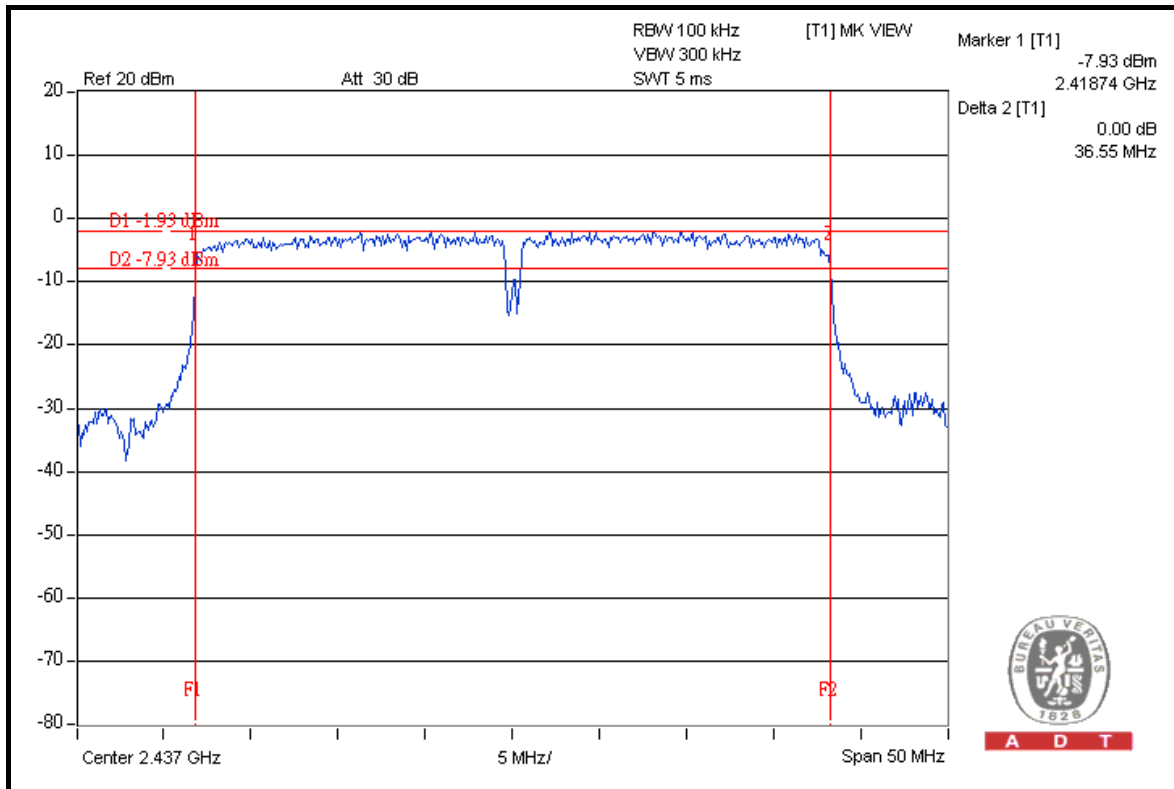



A D T

4.4 MAXIMUM OUTPUT POWER

4.4.1 LIMITS OF MAXIMUM OUTPUT POWER MEASUREMENT

The Maximum Output Power Measurement is 30dBm.

4.4.2 INSTRUMENTS

DESCRIPTION & MANUFACTURER	MODEL NO.	SERIAL NO.	DATE OF CALIBRATION	CALIBRATED UNTIL
High Speed Peak Power Meter	ML2495A	0824012	Aug. 10, 2009	Aug. 09, 2010
Power Sensor	MA2411B	0738138	Aug. 10, 2009	Aug. 09, 2010

Note:

1. The calibration interval of the above test instruments is 12 months and the calibrations are traceable to NML/ROC and NIST/USA.
2. Measurement Bandwidth of ML2495A is 65MHz greater than 6dB bandwidth of emission.

4.4.3 TEST PROCEDURE

A power sensor was used on the output port of the EUT. A power meter was used to read the response of the power sensor. Record the power level.

4.4.4 DEVIATION FROM TEST STANDARD

No deviation.

4.4.5 TEST SETUP

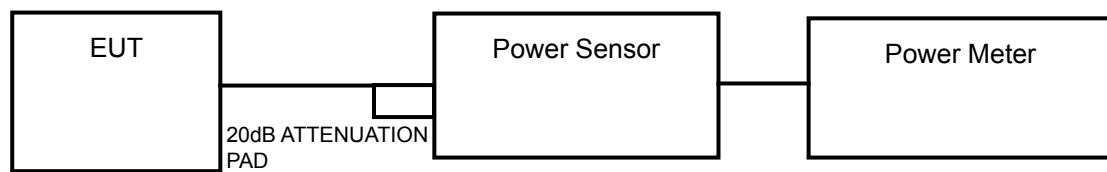

4.4.6 EUT OPERATING CONDITIONS

Same as Item 4.3.6.



A D T

4.4.7 TEST RESULTS

802.11b

CHAN	CHANNEL FREQUENCY (MHz)	POWER OUTPUT (mW)	POWER OUTPUT (dBm)	POWER LIMIT (dBm)	PASS/FAIL
1	2412	144.5	21.6	30	PASS
6	2437	190.5	22.8	30	PASS
11	2462	138.0	21.4	30	PASS

802.11g

CHAN	CHANNEL FREQUENCY (MHz)	POWER OUTPUT (mW)	POWER OUTPUT (dBm)	POWER LIMIT (dBm)	PASS/FAIL
1	2412	323.6	25.1	30	PASS
6	2437	331.1	25.2	30	PASS
11	2462	263.0	24.2	30	PASS

802.11n (20MHz)

CHAN	CHANNEL FREQUENCY (MHz)	POWER OUTPUT (mW)	POWER OUTPUT (dBm)	POWER LIMIT (dBm)	PASS/FAIL
1	2412	281.8	24.5	30	PASS
6	2437	302.0	24.8	30	PASS
11	2462	263.0	24.2	30	PASS

802.11n (40MHz)

CHAN	CHANNEL FREQUENCY (MHz)	POWER OUTPUT (mW)	POWER OUTPUT (dBm)	POWER LIMIT (dBm)	PASS/FAIL
1	2422	257.0	24.1	30	PASS
4	2437	263.0	24.2	30	PASS
7	2452	213.8	23.3	30	PASS



4.5 POWER SPECTRAL DENSITY MEASUREMENT

4.5.1 LIMITS OF POWER SPECTRAL DENSITY MEASUREMENT

The Maximum of Power Spectral Density Measurement is 8dBm.

4.5.2 TEST INSTRUMENTS

DESCRIPTION & MANUFACTURER	MODEL NO.	SERIAL NO.	DATE OF CALIBRATION	CALIBRATED UNTIL
R&S SPECTRUM ANALYZER	FSP40	100040	Jul. 07, 2009	Jul. 06, 2010

NOTE: The calibration interval of the above test instruments is 12 months and the calibrations are traceable to NML/ROC and NIST/USA.

4.5.3 TEST PROCEDURE

The transmitter output was connected to the spectrum analyzer through an attenuator, the bandwidth of the fundamental frequency was measured with the spectrum analyzer using 3kHz RBW and 30kHz VBW, set sweep time = span/3kHz. The power spectral density was measured and recorded.

The sweep time is allowed to be longer than span/3kHz for a full response of the mixer in the spectrum analyzer.

4.5.4 DEVIATION FROM TEST STANDARD

No deviation

4.5.5 TEST SETUP

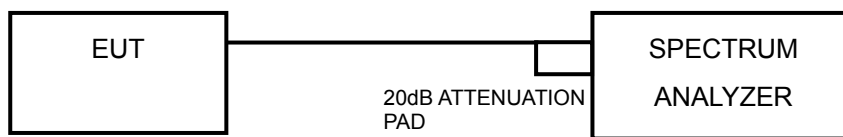

4.5.6 EUT OPERATING CONDITION

Same as Item 4.3.6



A D T

4.5.7 TEST RESULTS

802.11b

CHANNEL	CHANNEL FREQUENCY (MHz)	RF POWER LEVEL IN 3 kHz BW (dBm)	MAXIMUM LIMIT (dBm)	PASS/FAIL
1	2412	-12.2	8	PASS
6	2437	-10.8	8	PASS
11	2462	-12.3	8	PASS

CH 6

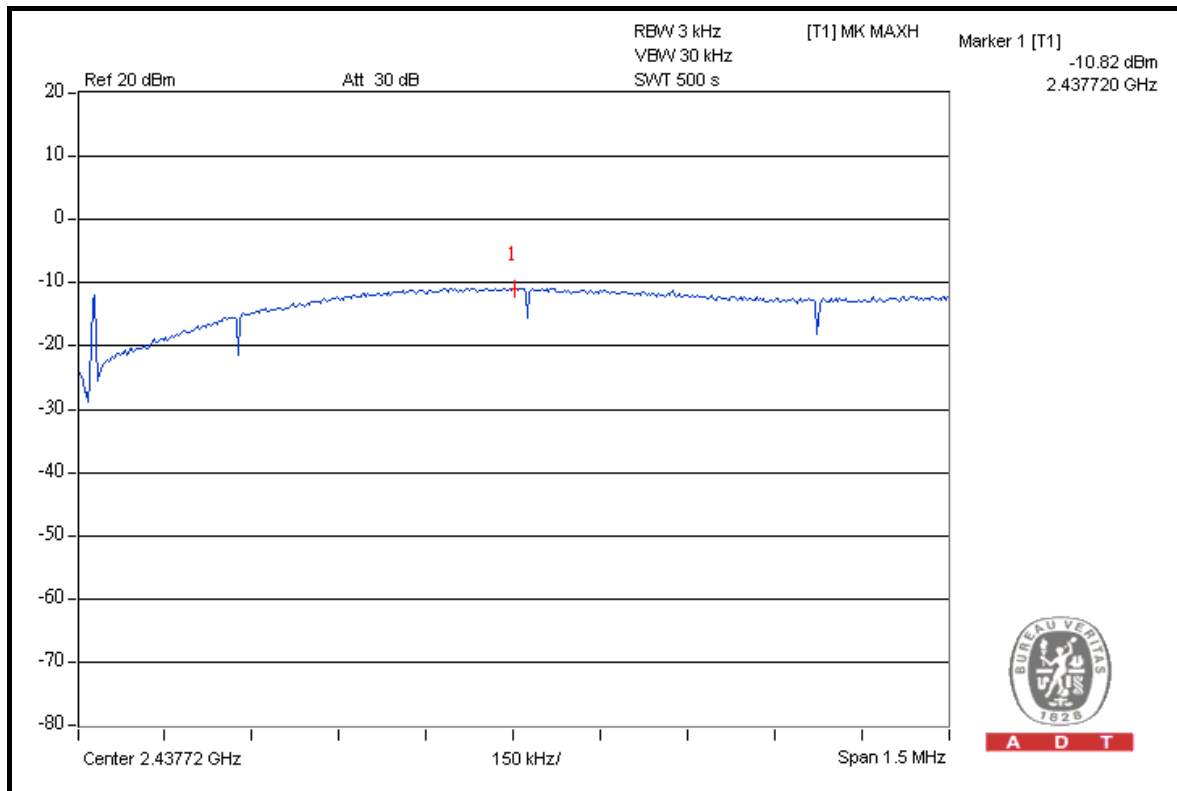



A D T

802.11g

CHANNEL	CHANNEL FREQUENCY (MHz)	RF POWER LEVEL IN 3 kHz BW (dBm)	MAXIMUM LIMIT (dBm)	PASS/FAIL
1	2412	-12.6	8	PASS
6	2437	-12.4	8	PASS
11	2462	-13.3	8	PASS

CH 6

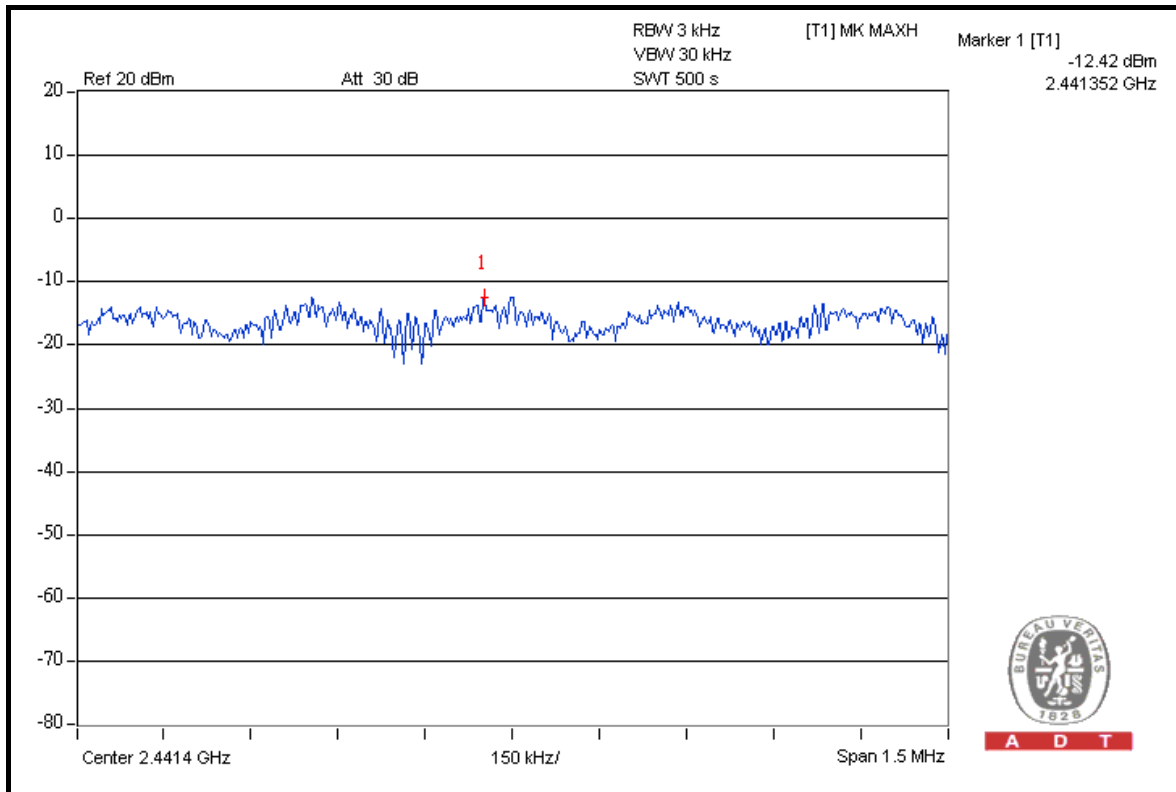



A D T

802.11n (20MHz)

CHANNEL	CHANNEL FREQUENCY (MHz)	RF POWER LEVEL IN 3 kHz BW (dBm)	MAXIMUM LIMIT (dBm)	PASS/FAIL
1	2412	-12.2	8	PASS
6	2437	-11.7	8	PASS
11	2462	-12.3	8	PASS

CH 6

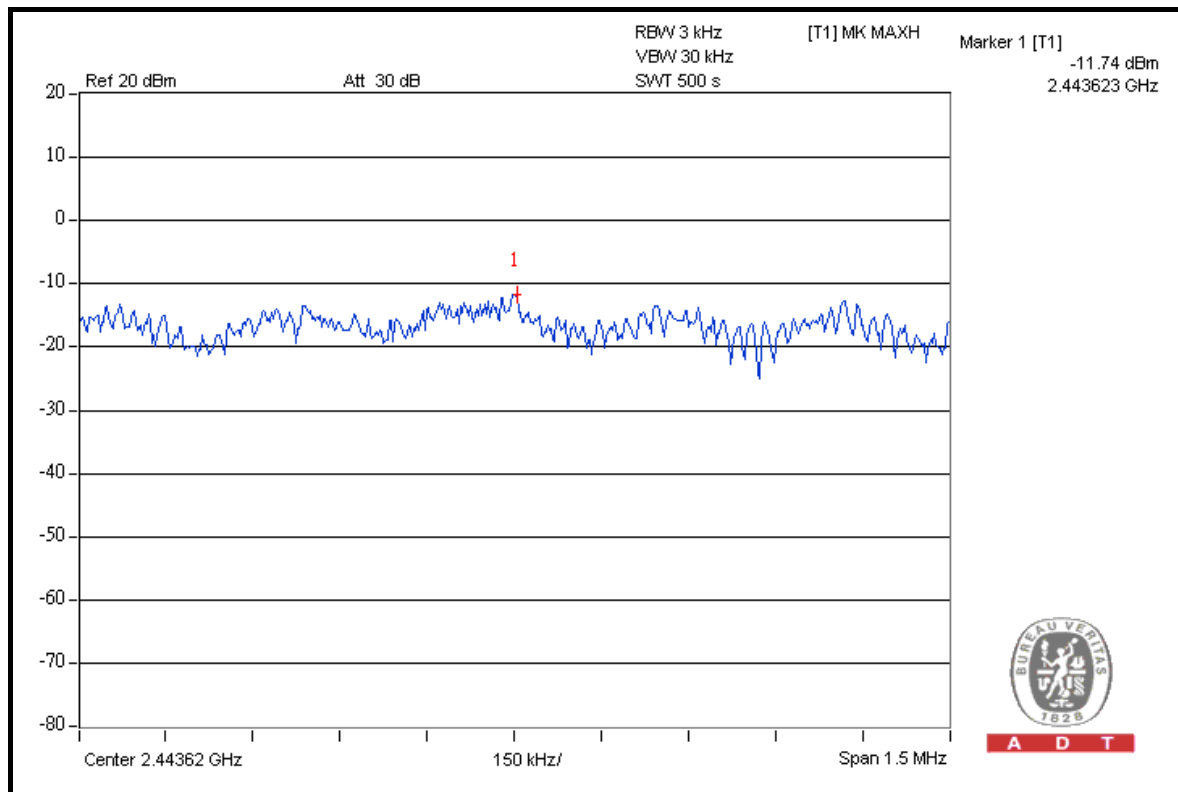



A D T

802.11n (40MHz)

CHANNEL	CHANNEL FREQUENCY (MHz)	RF POWER LEVEL IN 3 kHz BW (dBm)	MAXIMUM LIMIT (dBm)	PASS/FAIL
1	2422	-13.3	8	PASS
4	2437	-13.0	8	PASS
7	2452	-13.8	8	PASS

CH 4

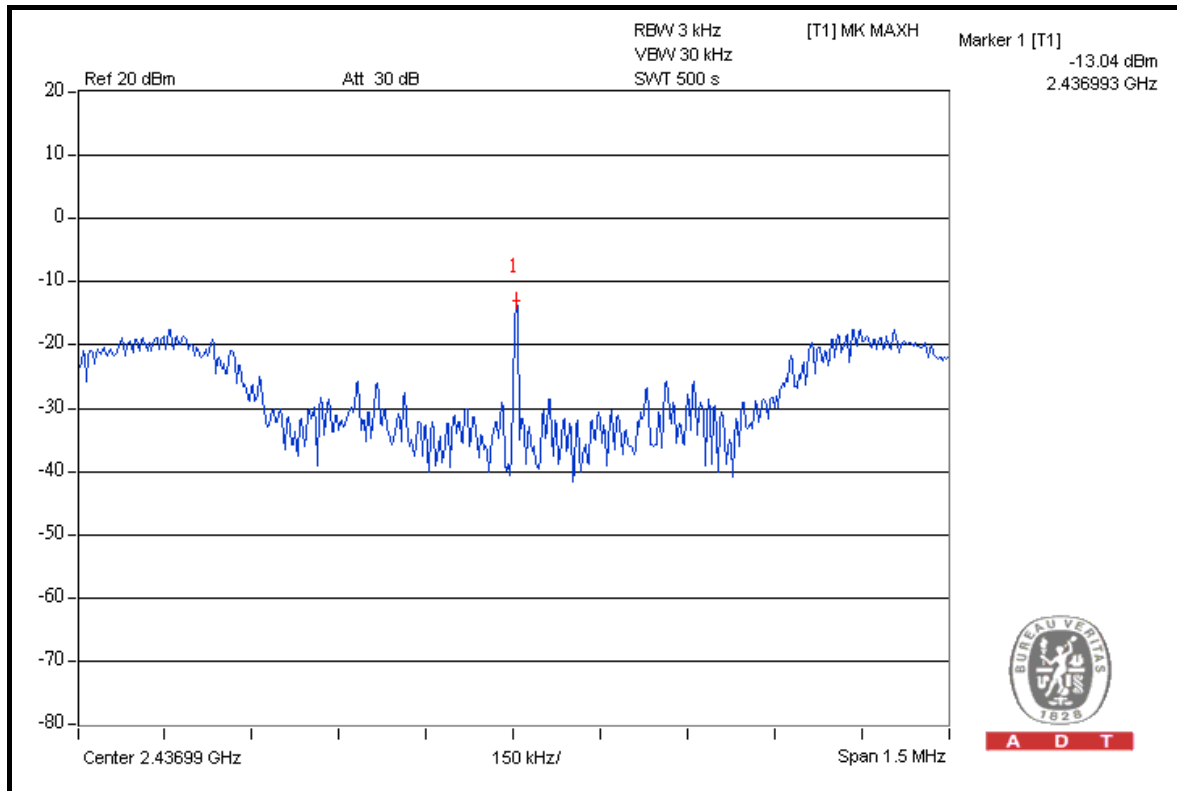



A D T

4.6 BAND EDGES MEASUREMENT

4.6.1 LIMITS OF BAND EDGES MEASUREMENT

Below -20dB of the highest emission level of operating band (in 100kHz Resolution Bandwidth).

4.6.2 TEST INSTRUMENTS

DESCRIPTION & MANUFACTURER	MODEL NO.	SERIAL NO.	DATE OF CALIBRATION	CALIBRATED UNTIL
R&S SPECTRUM ANALYZER	FSP40	100040	Jul. 07, 2009	Jul. 06, 2010

NOTE: The calibration interval of the above test instruments is 12 months and the calibrations are traceable to NML/ROC and NIST/USA.



A D T

4.6.3 TEST PROCEDURE

The transmitter output was connected to the spectrum analyzer via a low loss cable. Set both RBW and VBW of spectrum analyzer to 100kHz with suitable frequency span including 300kHz bandwidth from band edge. The band edges was measured and recorded.

The spectrum plots (Peak RBW = 100kHz, VBW = 300kHz; Average RBW = 1MHz, VBW = 10Hz) are attached on the following pages.

4.6.4 DEVIATION FROM TEST STANDARD

No deviation.

4.6.5 EUT OPERATING CONDITION

Same as Item 4.3.6.



A D T

4.6.6 TEST RESULTS

The spectrum plots are attached on the following pages. D1 line indicates the highest level, and D2 line indicates the 20dB offset below D1. It shows compliance with the requirement in part 15.247(d).

802.11b

RESTRICT BAND (2310 ~ 2390 MHz)

FREQUENCY (MHz)	FUNDAMENTAL EMISSION (dBuV/m)	DELTA (dB)	MAXIMUM FIELD STRENGTH IN RESTRICT BAND (dBuV/m)	LIMIT (dBuV/m)
2412.00 (PK)	112.2	53.71	58.49	74.00
2412.00 (AV)	107.6	57.32	50.28	54.00

RESTRICT BAND (2483.5 ~ 2500 MHz)

FREQUENCY (MHz)	FUNDAMENTAL EMISSION (dBuV/m)	DELTA (dB)	MAXIMUM FIELD STRENGTH IN RESTRICT BAND (dBuV/m)	LIMIT (dBuV/m)
2462.00 (PK)	111.7	53.83	57.87	74.00
2462.00 (AV)	107.1	55.93	51.17	54.00

NOTE:

1. Delta = Amplitude between the peak of the fundamental and the peak of the band edge emission. Please check following 3 pages.
2. Maximum field strength in restrict band = Fundamental emission – Delta.



A D T

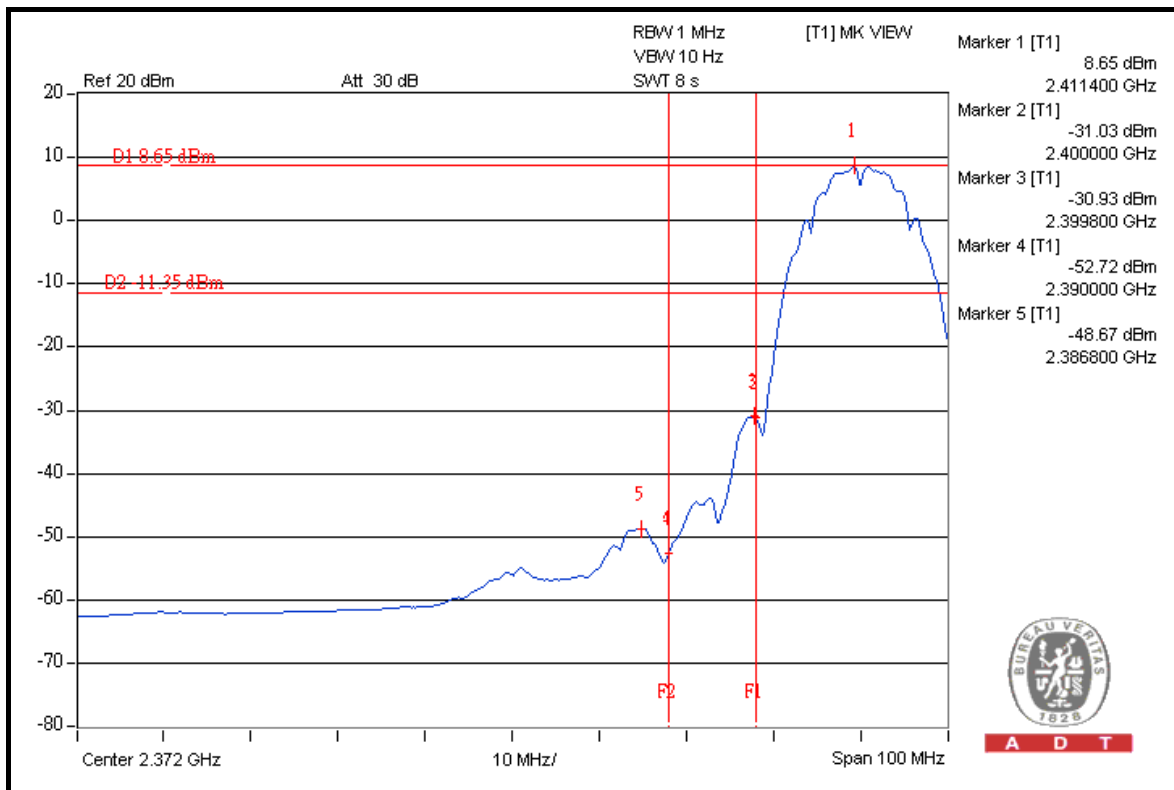
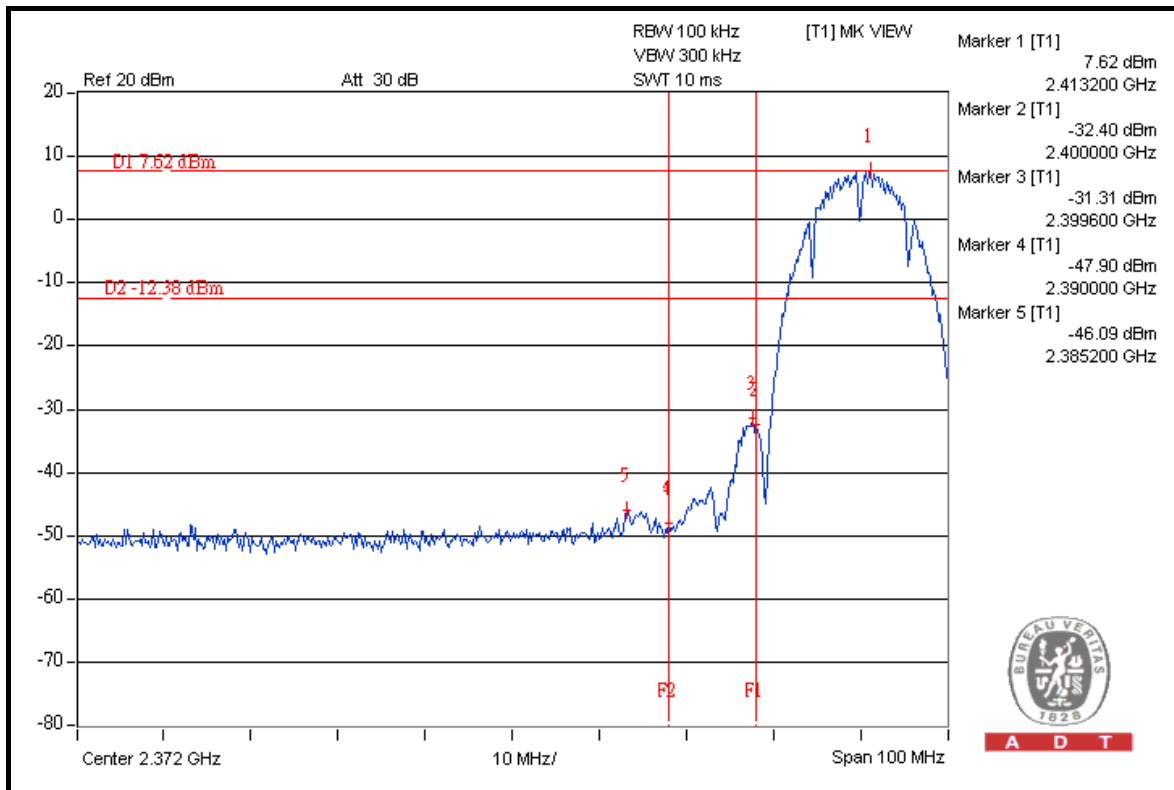



A D T

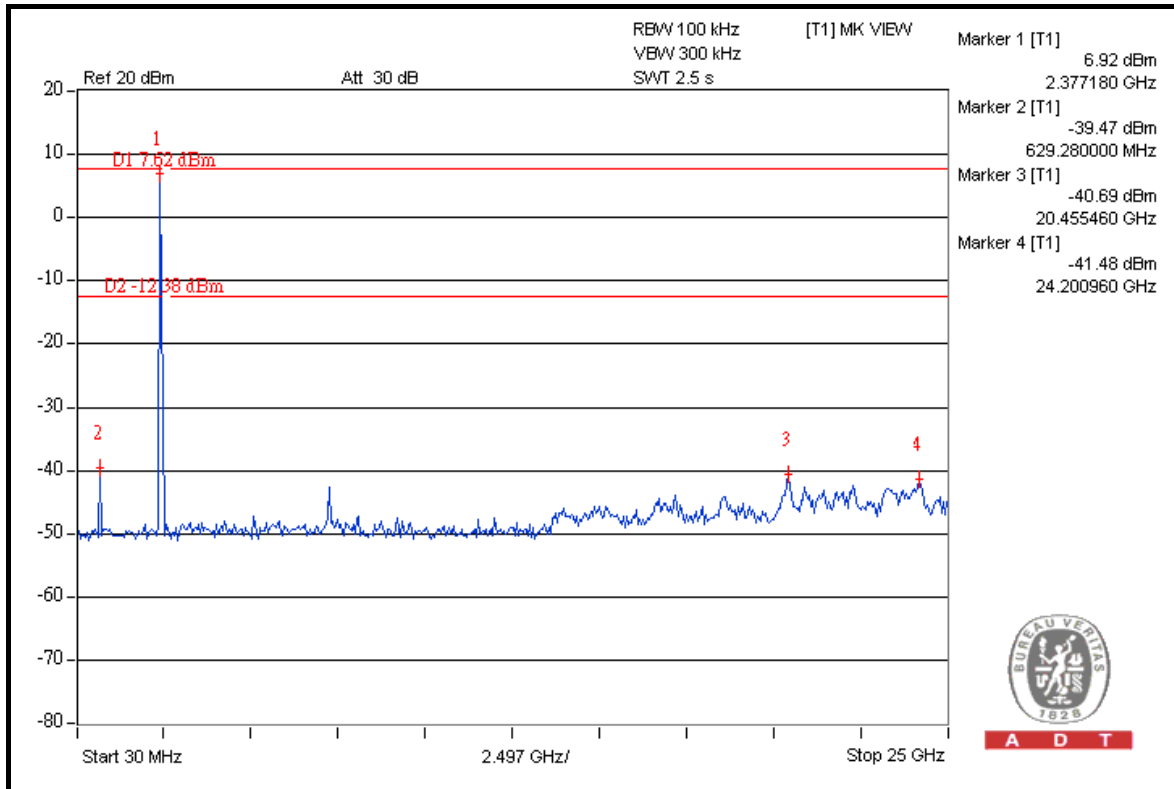

A D T

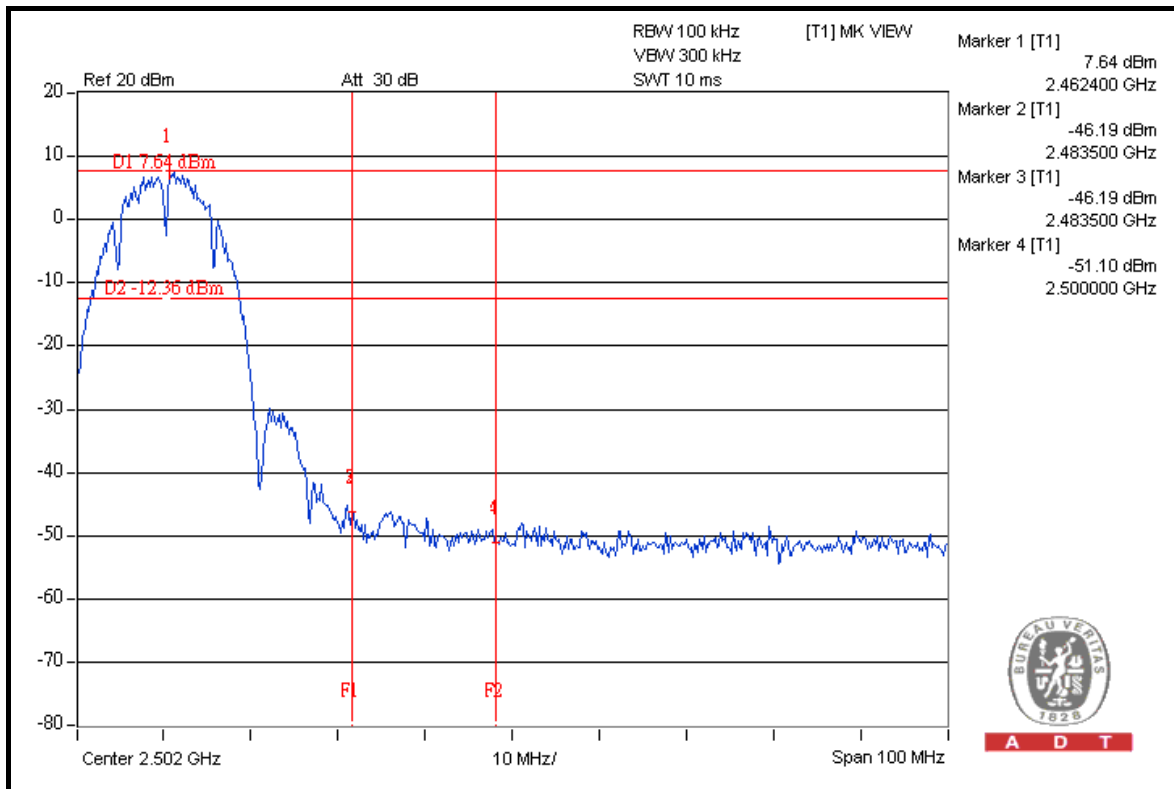

A D T



A D T

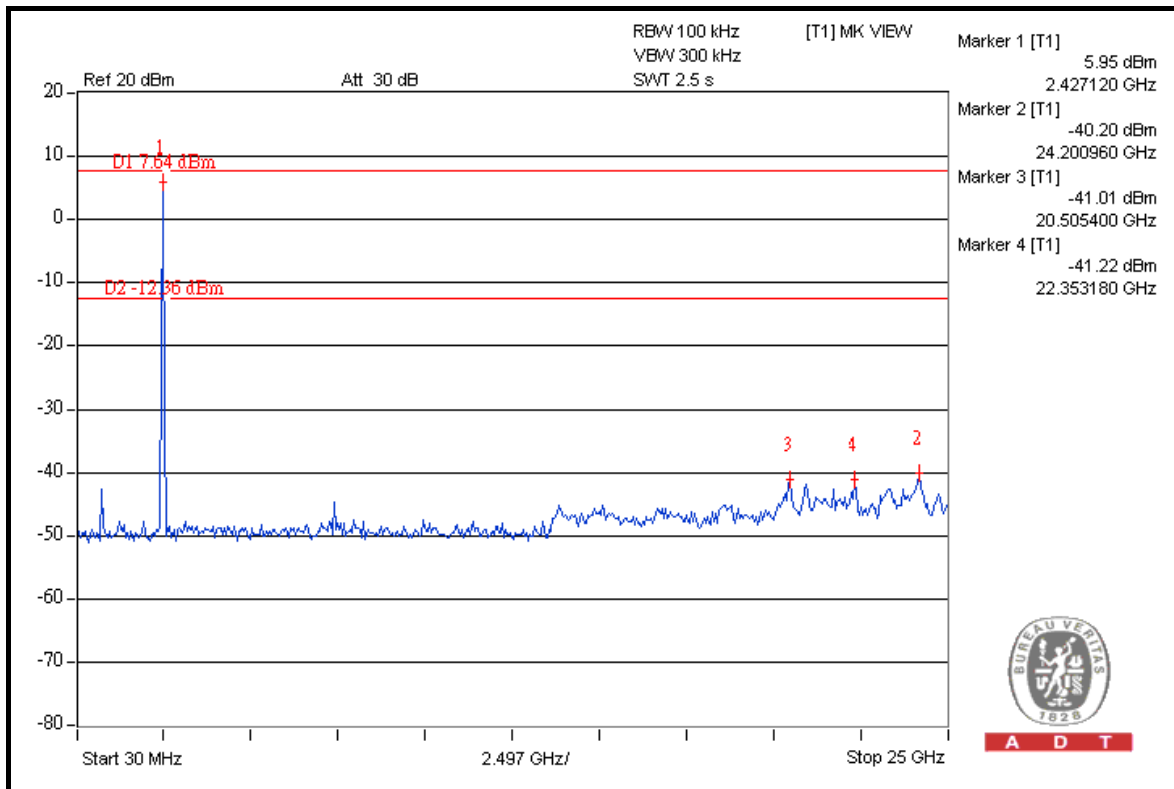
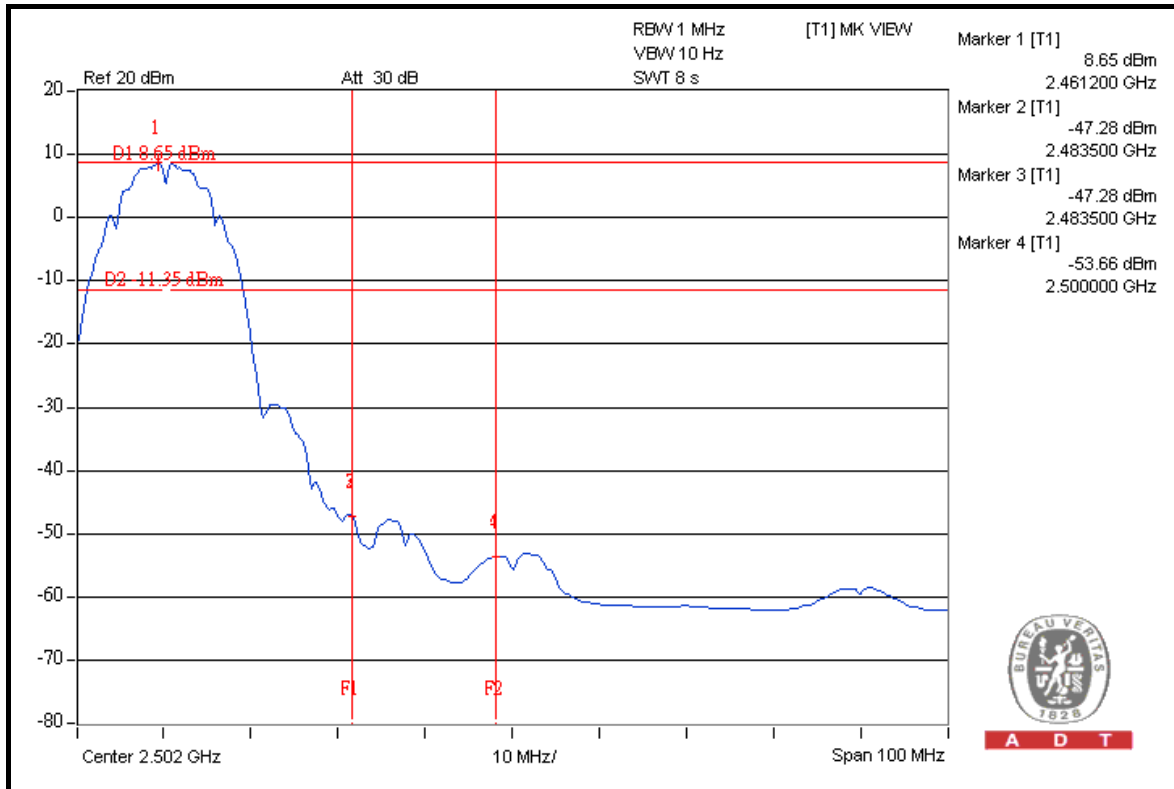



A D T

802.11g

RESTRICT BAND (2310 ~ 2390 MHz)

FREQUENCY (MHz)	FUNDAMENTAL EMISSION (dBuV/m)	DELTA (dB)	MAXIMUM FIELD STRENGTH IN RESTRICT BAND (dBuV/m)	LIMIT (dBuV/m)
2412.00 (PK)	111.5	43.03	68.47	74.00
2412.00 (AV)	100.8	48.32	52.48	54.00

RESTRICT BAND (2483.5 ~ 2500 MHz)

FREQUENCY (MHz)	FUNDAMENTAL EMISSION (dBuV/m)	DELTA (dB)	MAXIMUM FIELD STRENGTH IN RESTRICT BAND (dBuV/m)	LIMIT (dBuV/m)
2462.00 (PK)	110.3	41.92	68.38	74.00
2462.00 (AV)	99.6	47.47	52.13	54.00

NOTE:

1. Delta = Amplitude between the peak of the fundamental and the peak of the band edge emission. Please check following 3 pages.
2. Maximum field strength in restrict band = Fundamental emission – Delta.



A D T

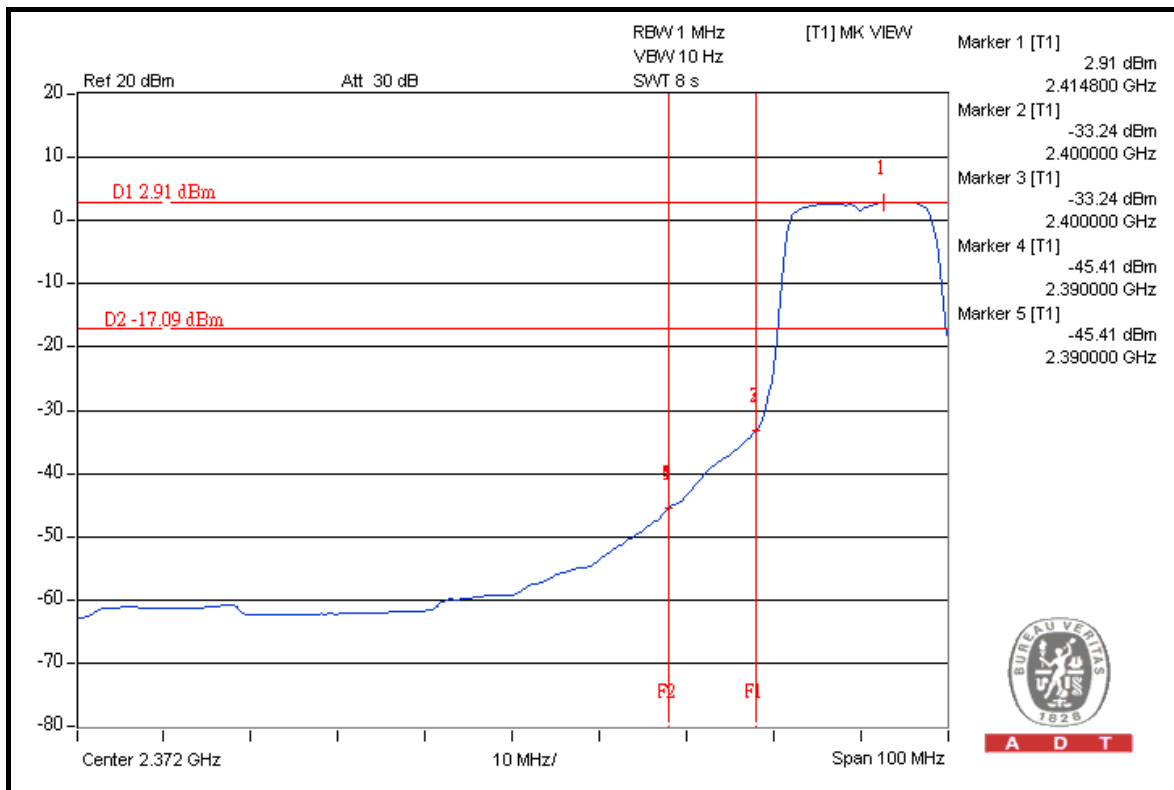
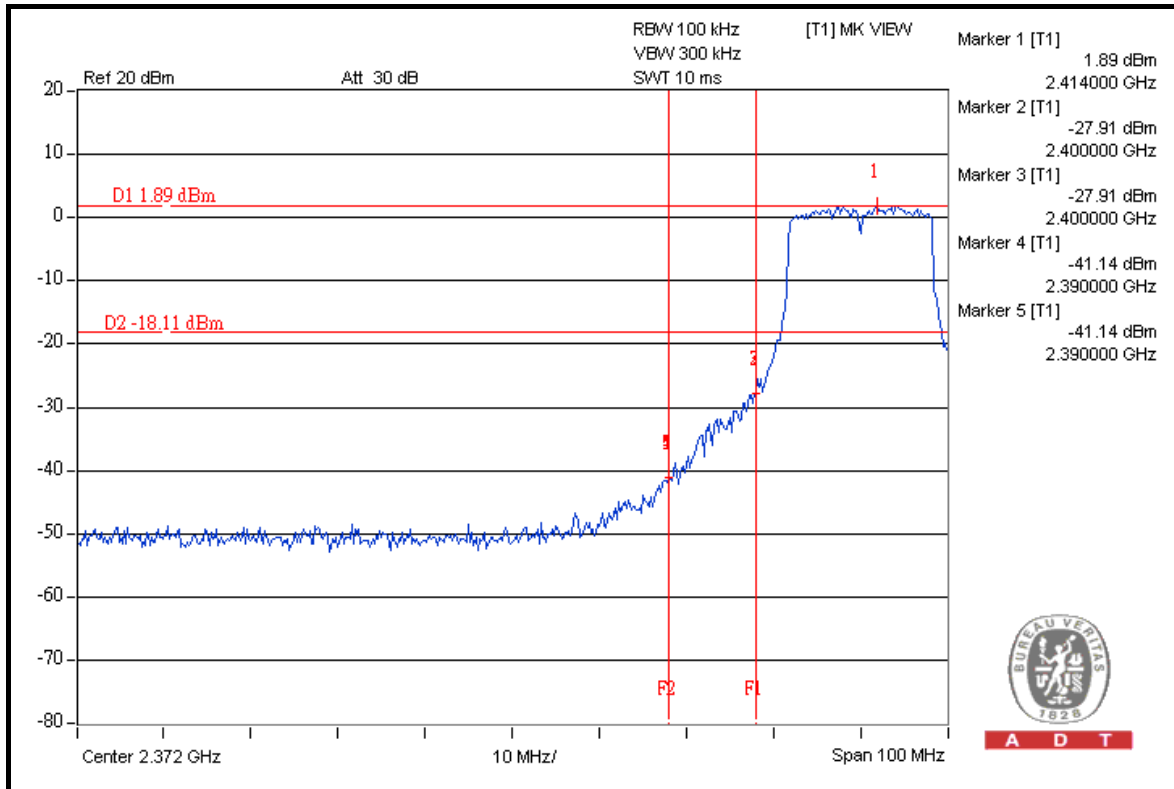



A D T

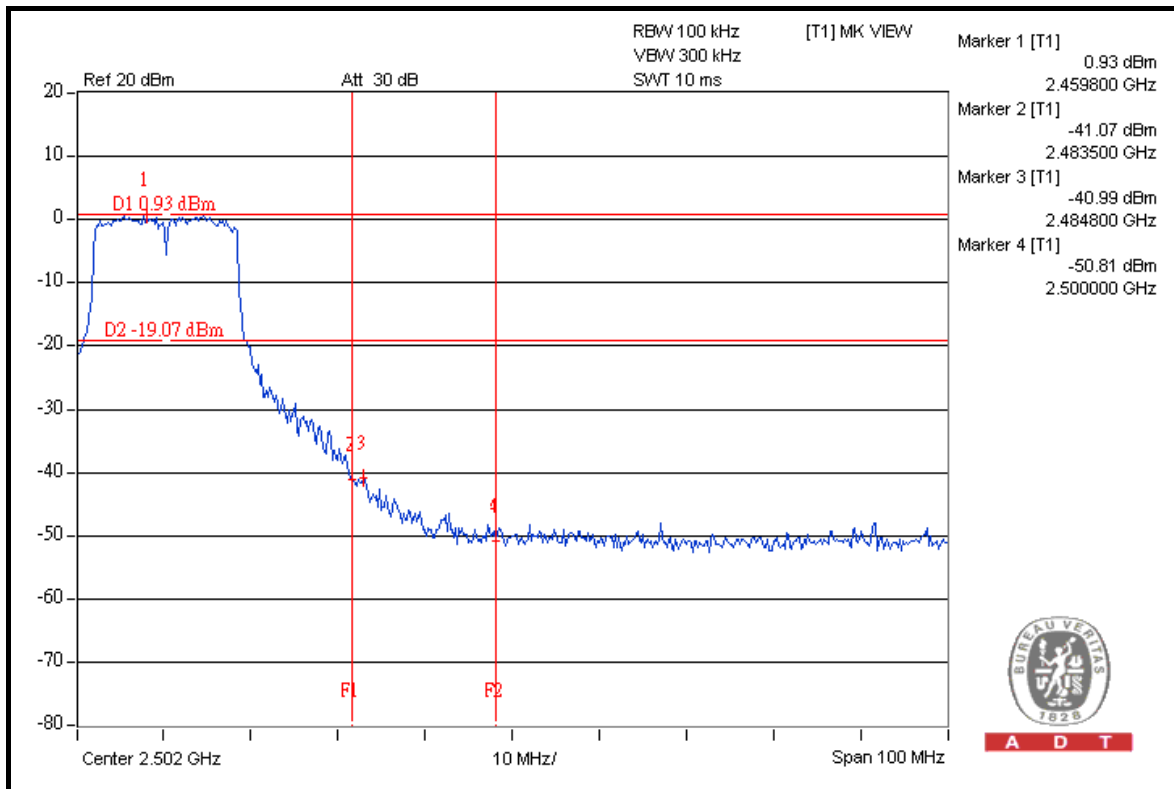
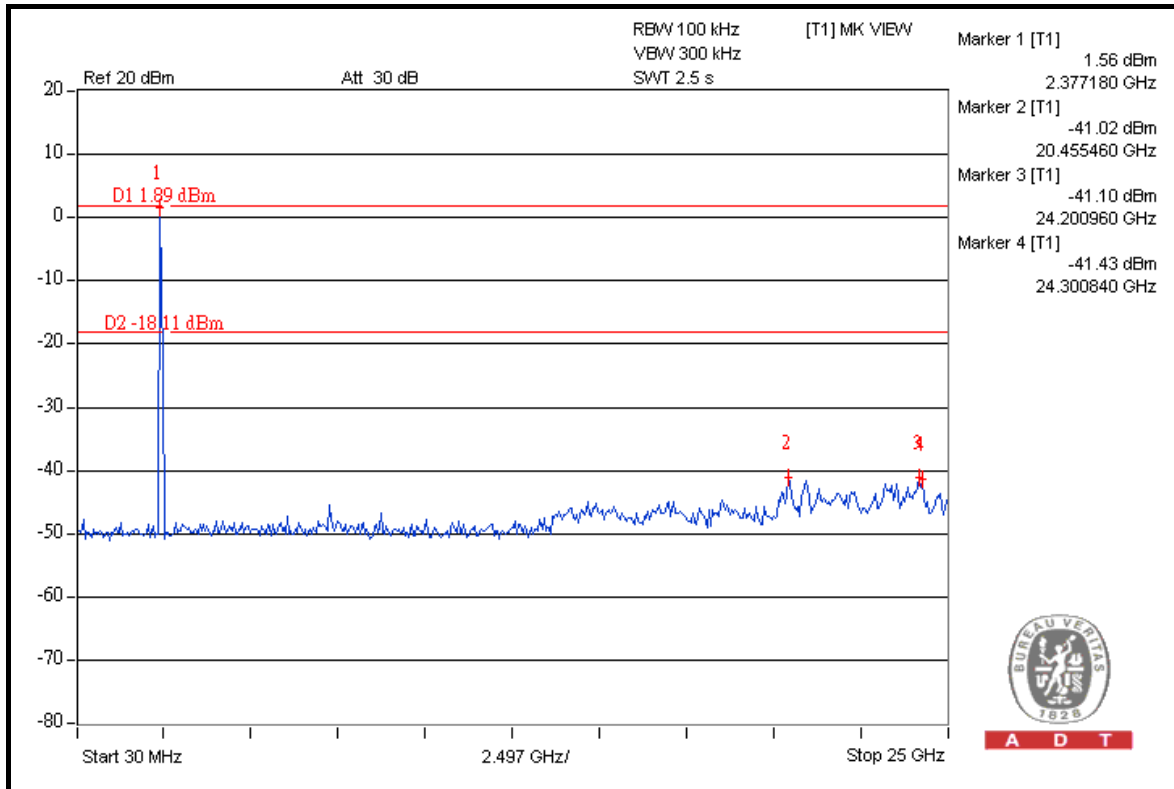



A D T

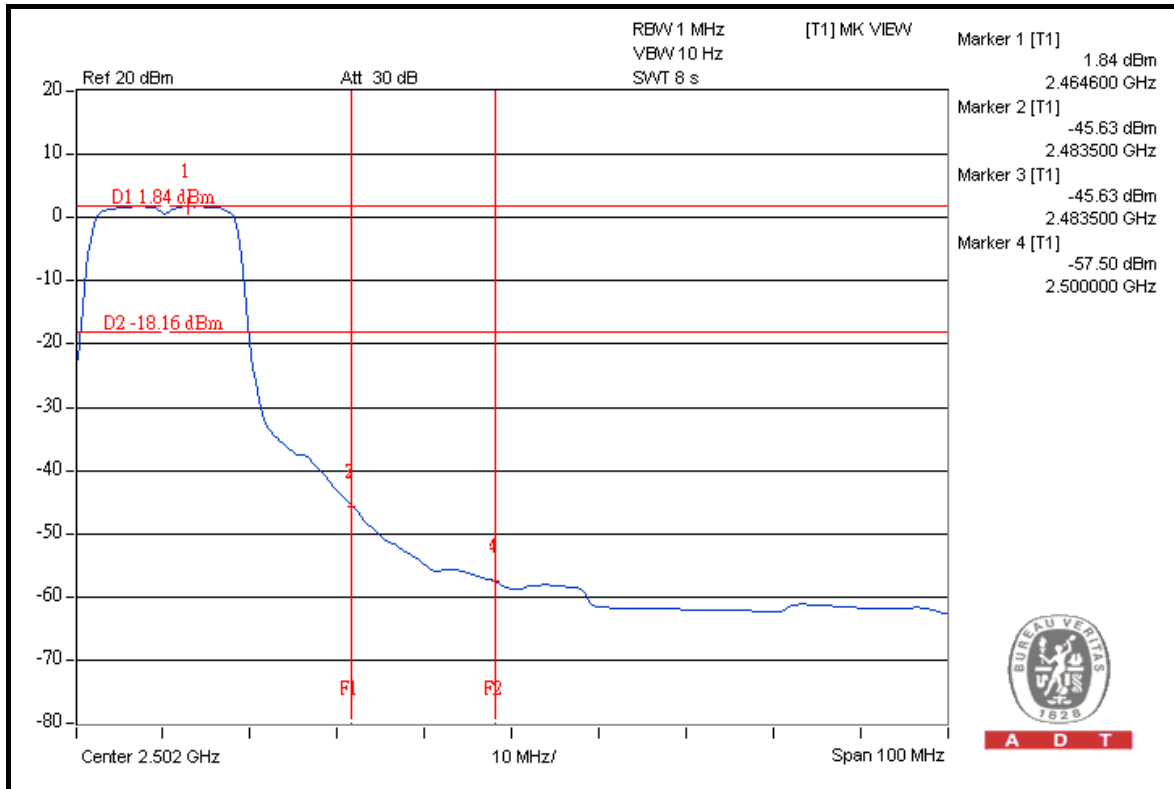

A D T

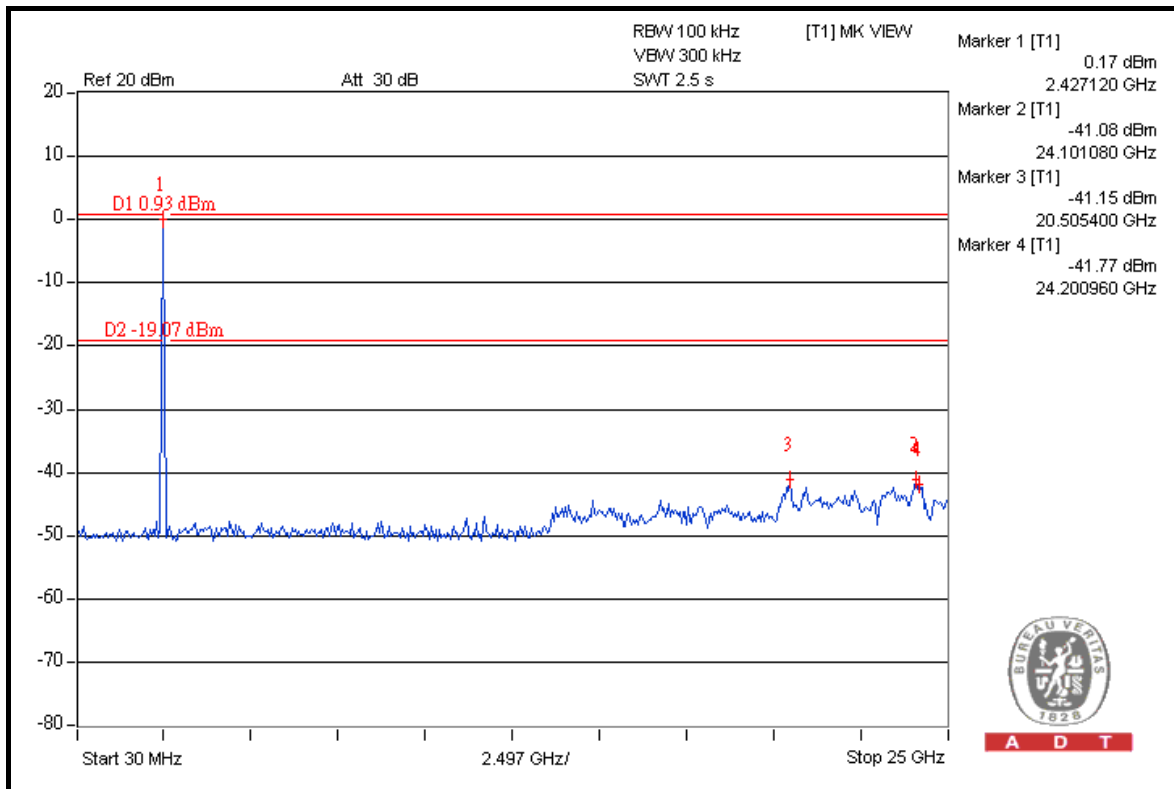

A D T



A D T

802.11n (20MHz)

RESTRICT BAND (2310 ~ 2390 MHz)

FREQUENCY (MHz)	FUNDAMENTAL EMISSION (dBuV/m)	DELTA (dB)	MAXIMUM FIELD STRENGTH IN RESTRICT BAND (dBuV/m)	LIMIT (dBuV/m)
2412.00 (PK)	112.1	40.67	71.43	74.00
2412.00 (AV)	101.7	50.14	51.56	54.00

RESTRICT BAND (2483.5 ~ 2500 MHz)

FREQUENCY (MHz)	FUNDAMENTAL EMISSION (dBuV/m)	DELTA (dB)	MAXIMUM FIELD STRENGTH IN RESTRICT BAND (dBuV/m)	LIMIT (dBuV/m)
2462.00 (PK)	111.0	38.09	72.91	74.00
2462.00 (AV)	100.6	50.54	50.06	54.00

NOTE:

1. Delta = Amplitude between the peak of the fundamental and the peak of the band edge emission. Please check following 3 pages.
2. Maximum field strength in restrict band = Fundamental emission – Delta.



A D T

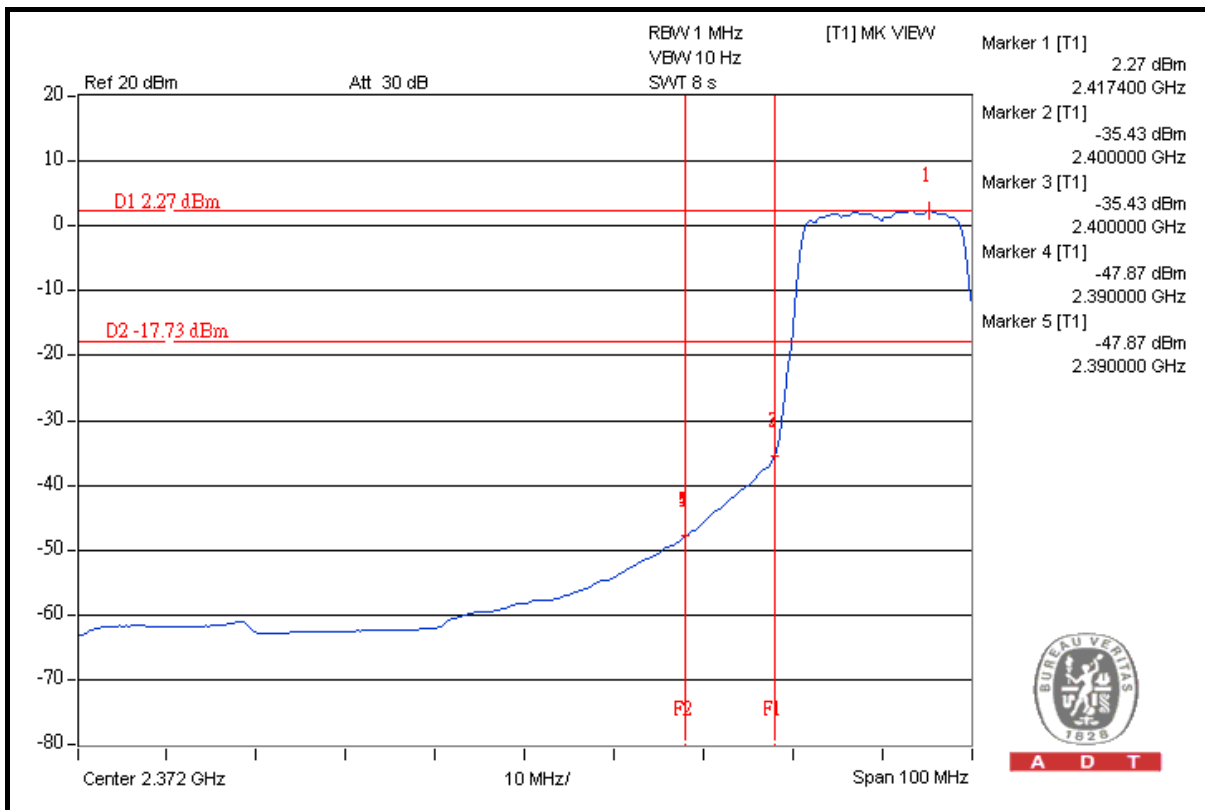
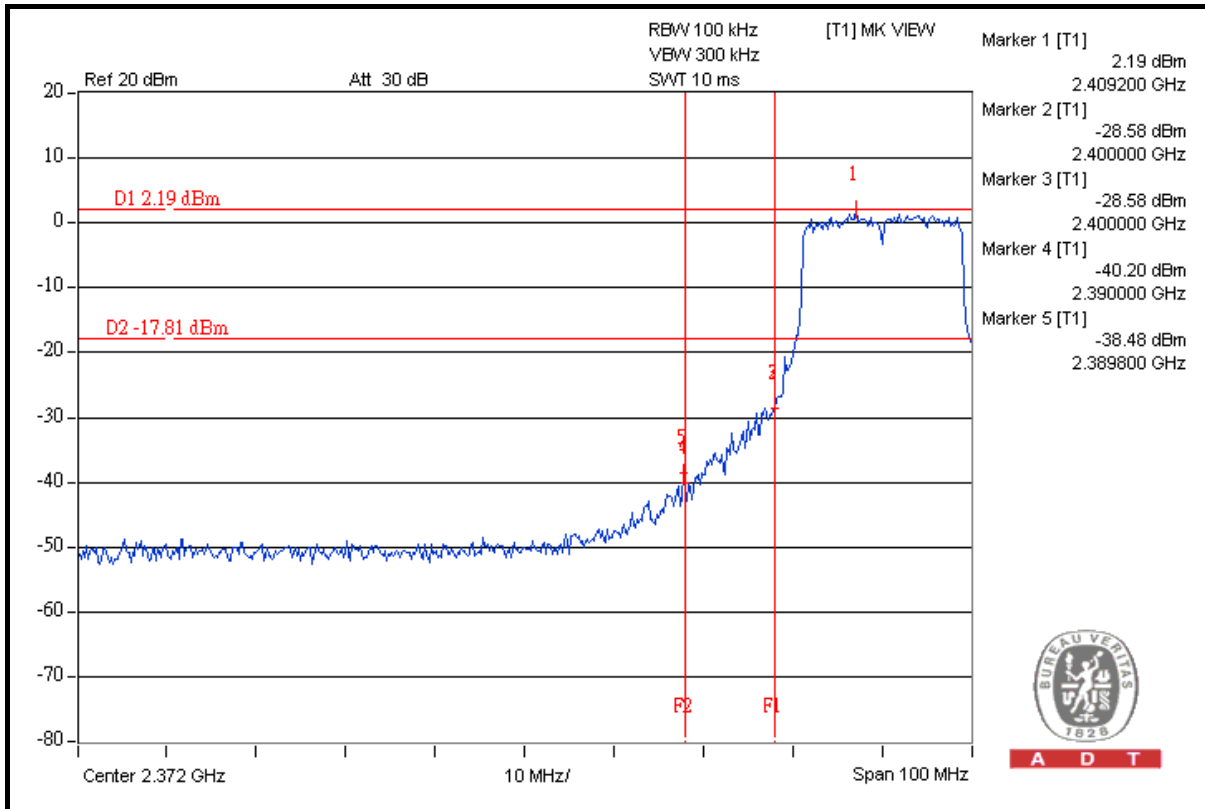



A D T

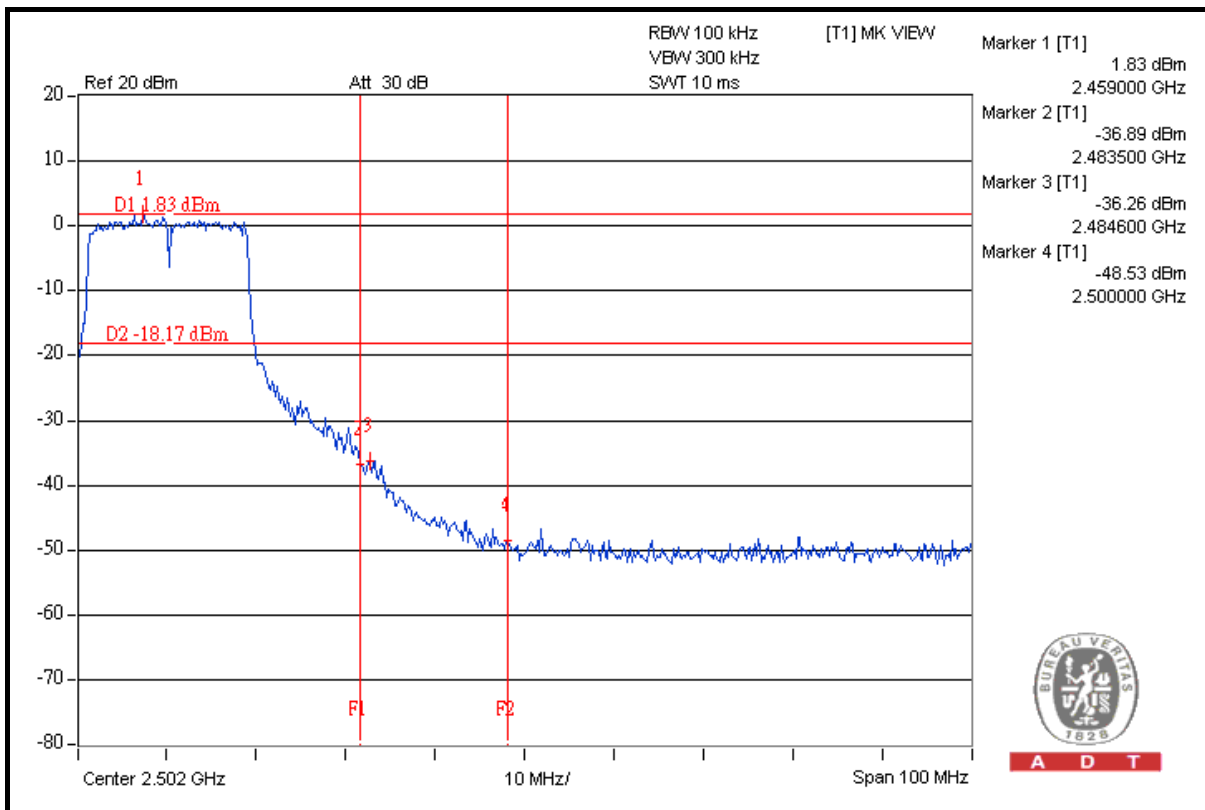
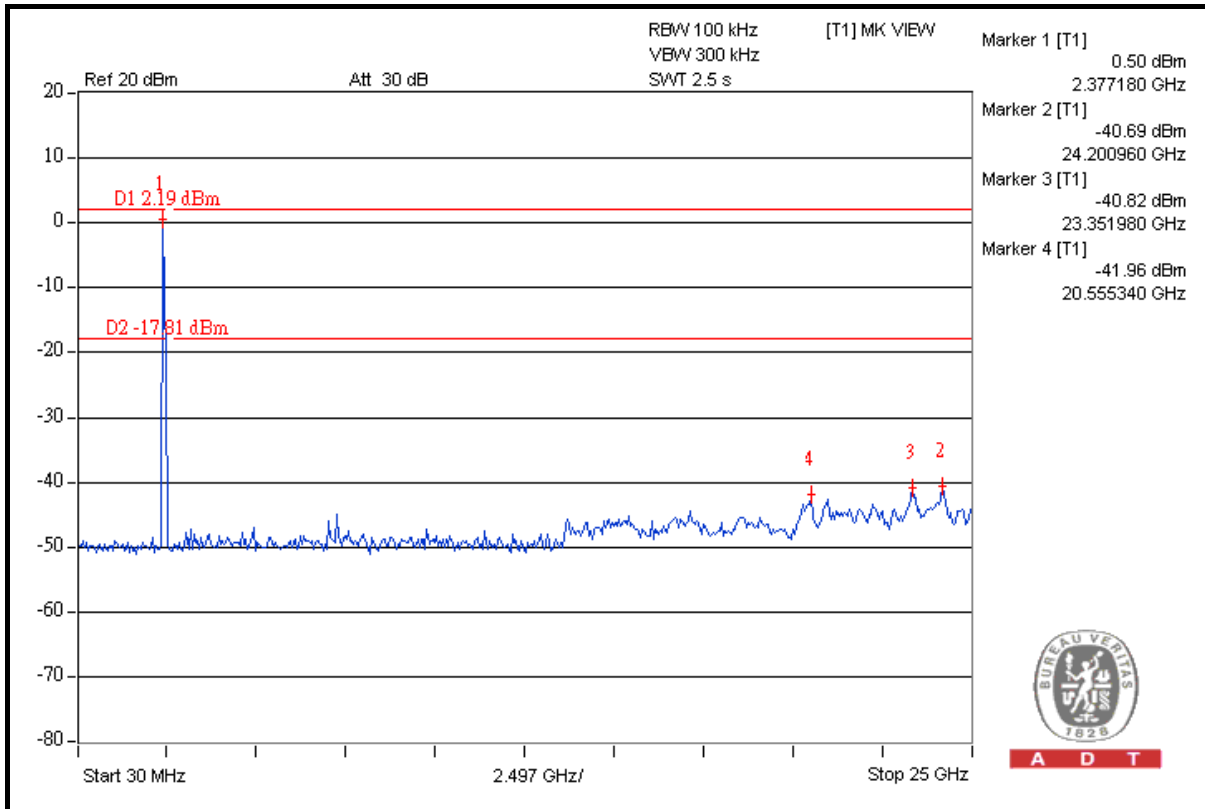



A D T

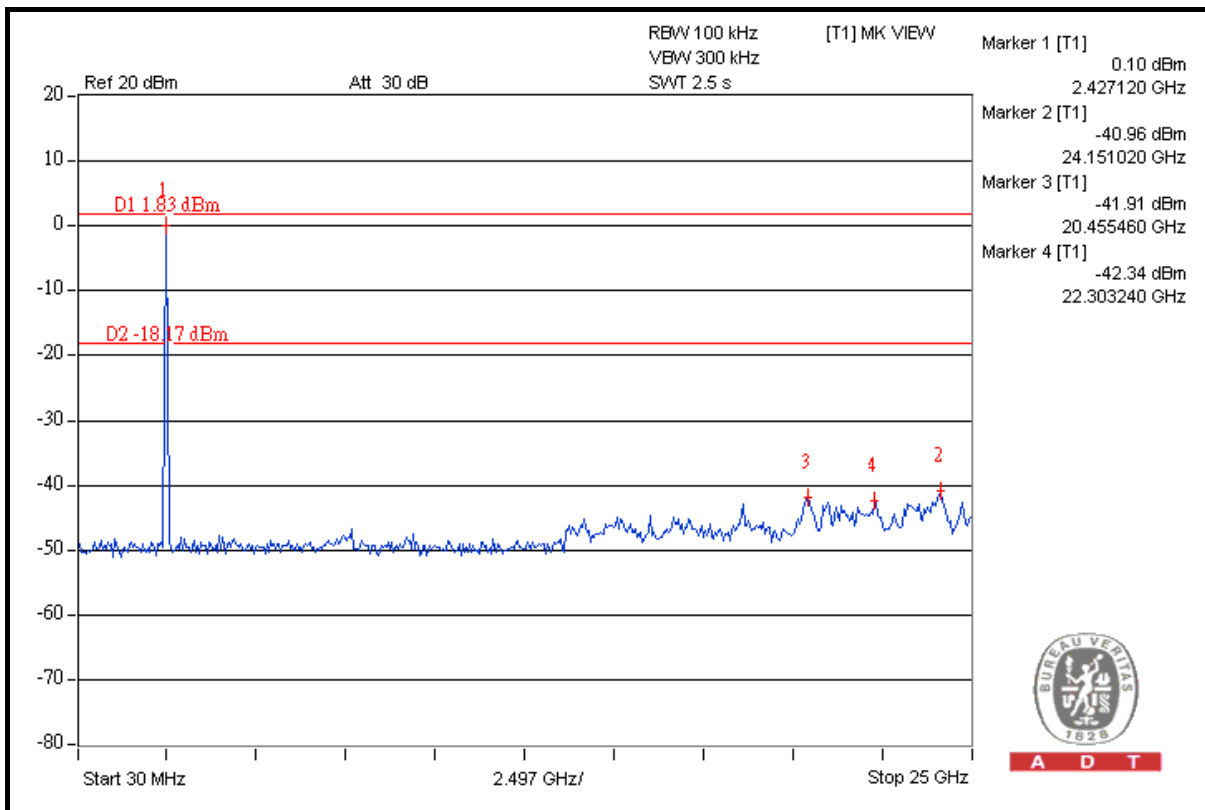
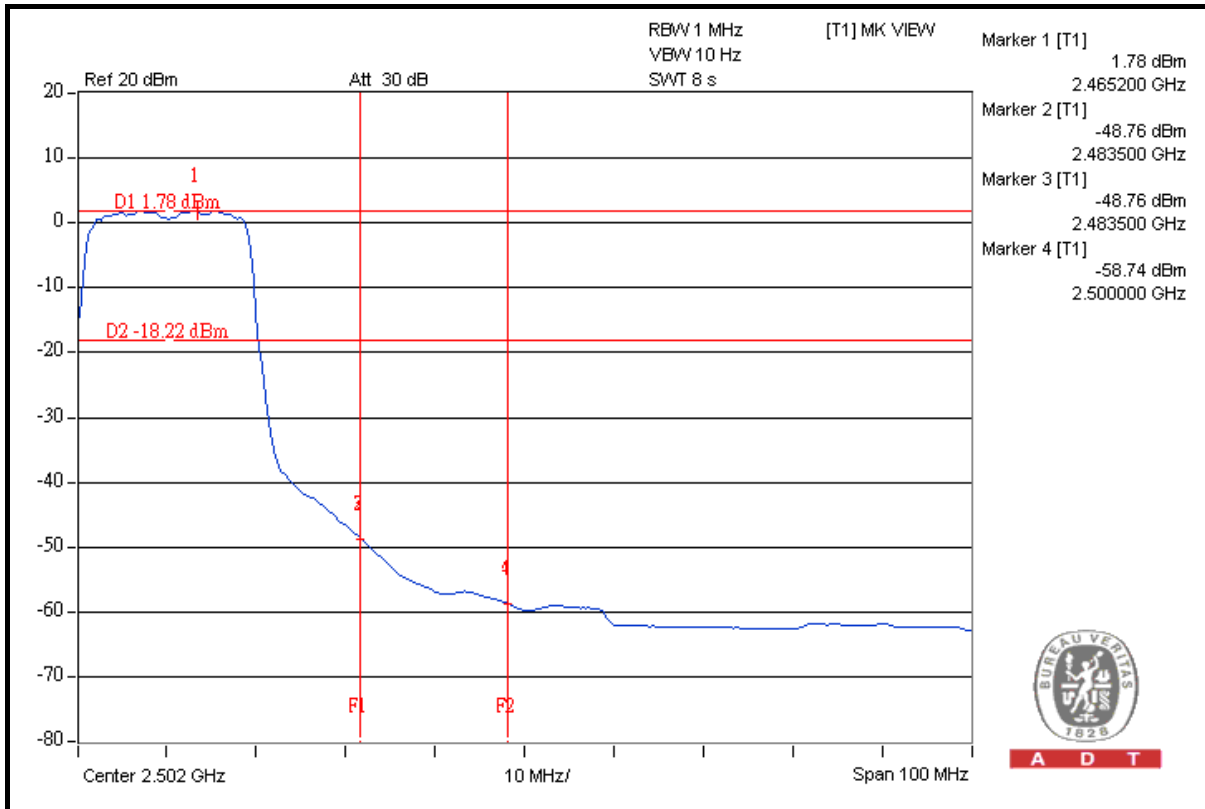



A D T

802.11n (40MHz)

RESTRICT BAND (2310 ~ 2390 MHz)

FREQUENCY (MHz)	FUNDAMENTAL EMISSION (dBuV/m)	DELTA (dB)	MAXIMUM FIELD STRENGTH IN RESTRICT BAND (dBuV/m)	LIMIT (dBuV/m)
2422.00 (PK)	108.5	38.07	70.43	74.00
2422.00 (AV)	98.0	46.88	51.12	54.00

RESTRICT BAND (2483.5 ~ 2500 MHz)

FREQUENCY (MHz)	FUNDAMENTAL EMISSION (dBuV/m)	DELTA (dB)	MAXIMUM FIELD STRENGTH IN RESTRICT BAND (dBuV/m)	LIMIT (dBuV/m)
2452.00 (PK)	106.4	33.51	72.89	74.00
2452.00 (AV)	96.1	43.90	52.20	54.00

NOTE:

1. Delta = Amplitude between the peak of the fundamental and the peak of the band edge emission. Please check following 3 pages.
2. Maximum field strength in restrict band = Fundamental emission – Delta.



A D T

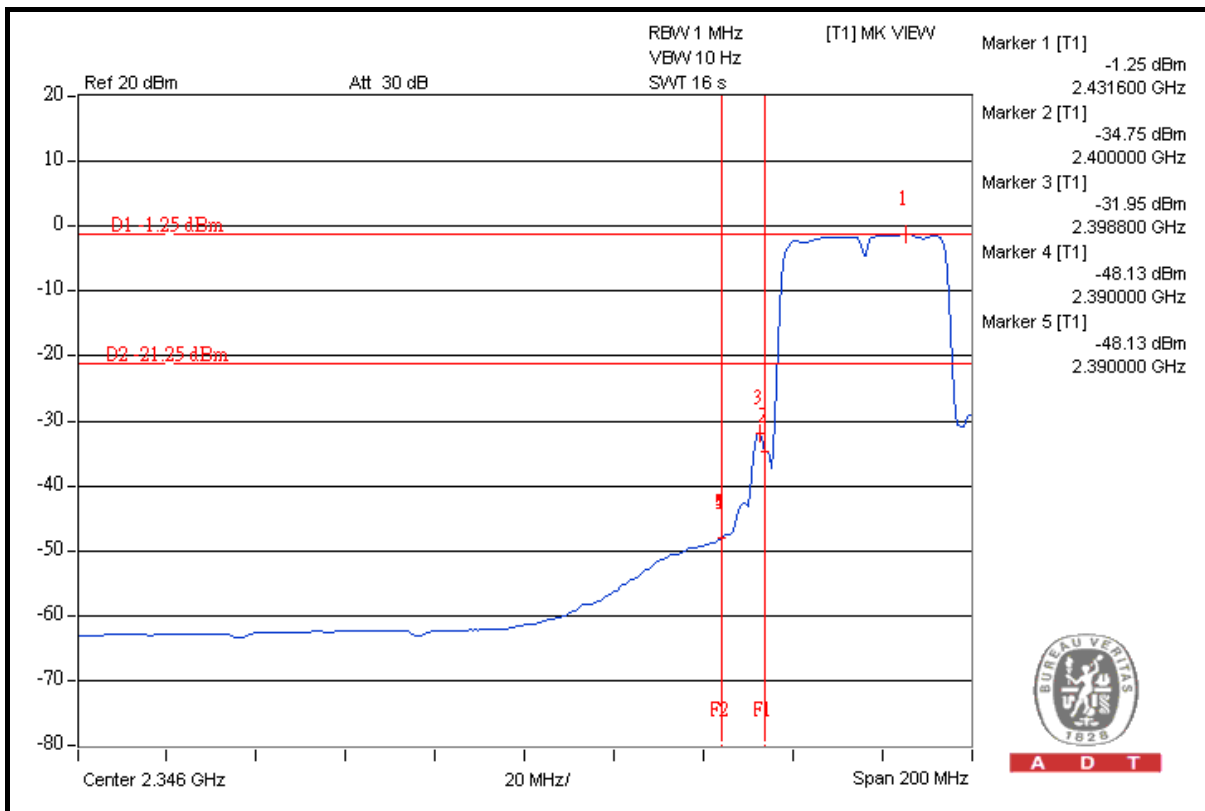
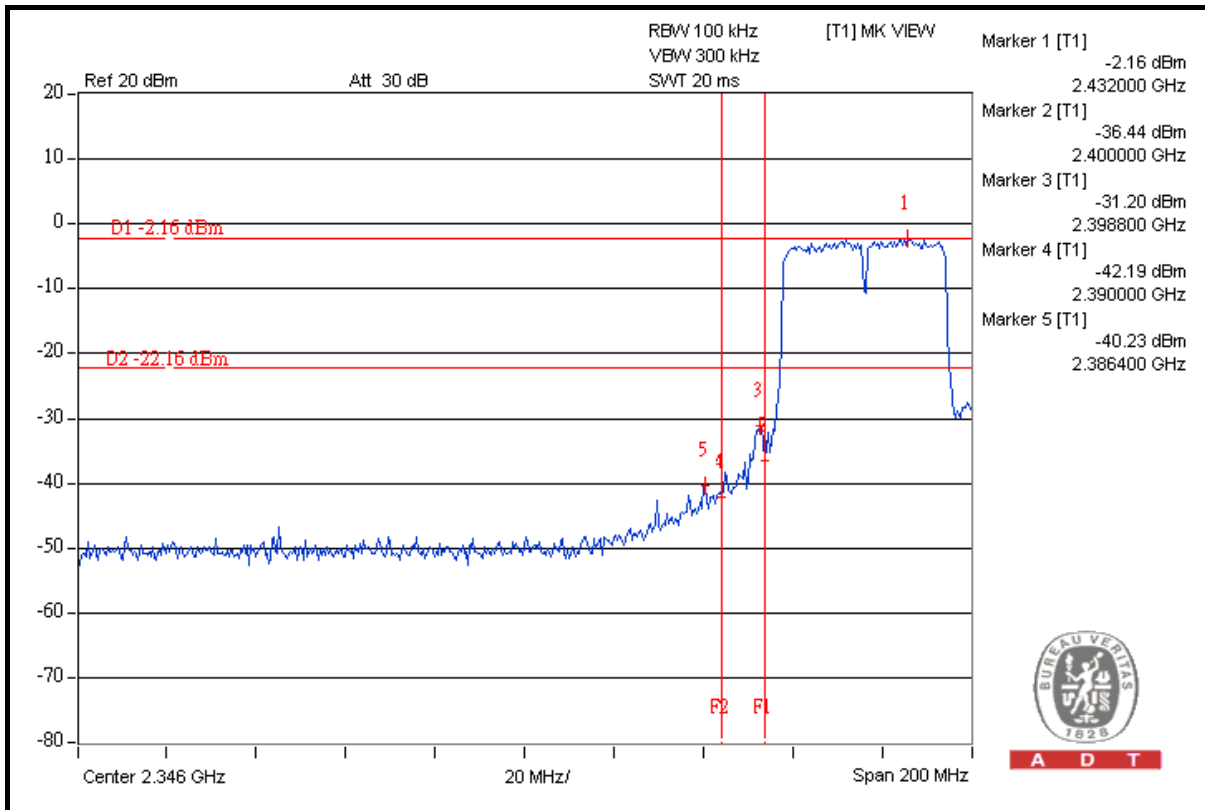



A D T

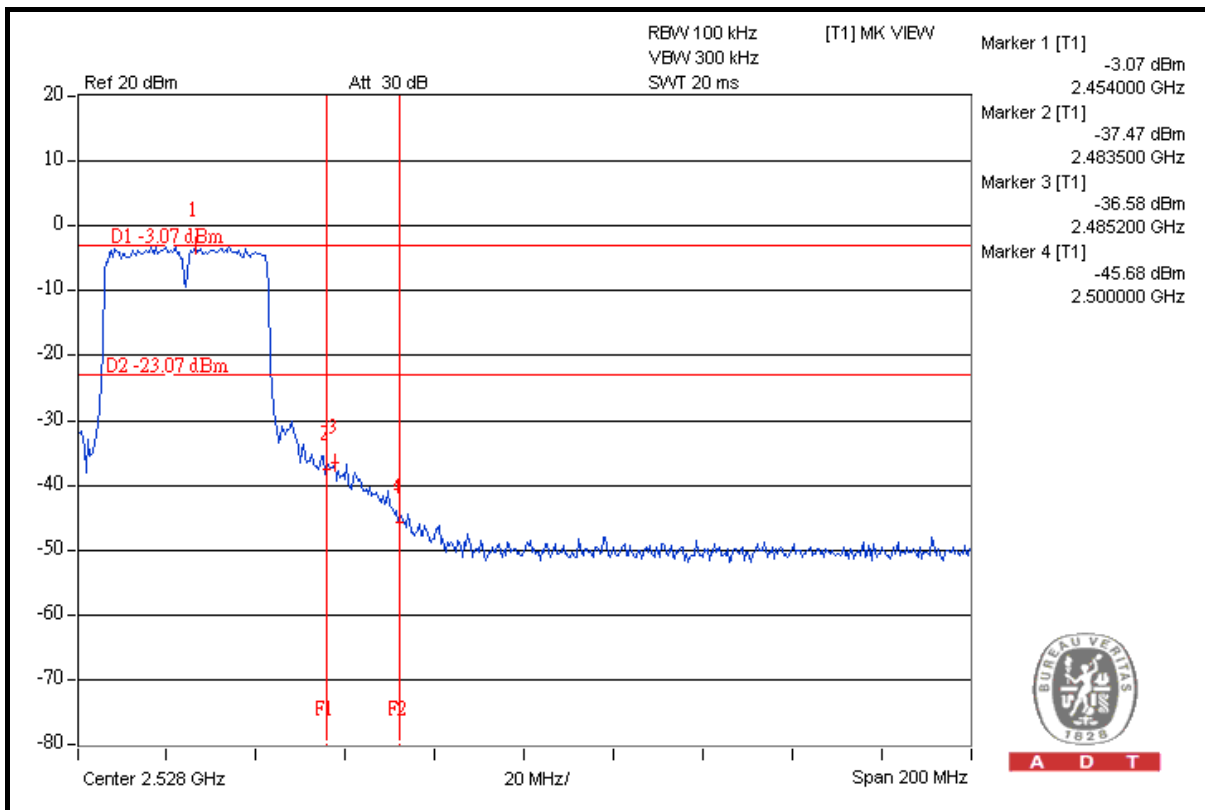
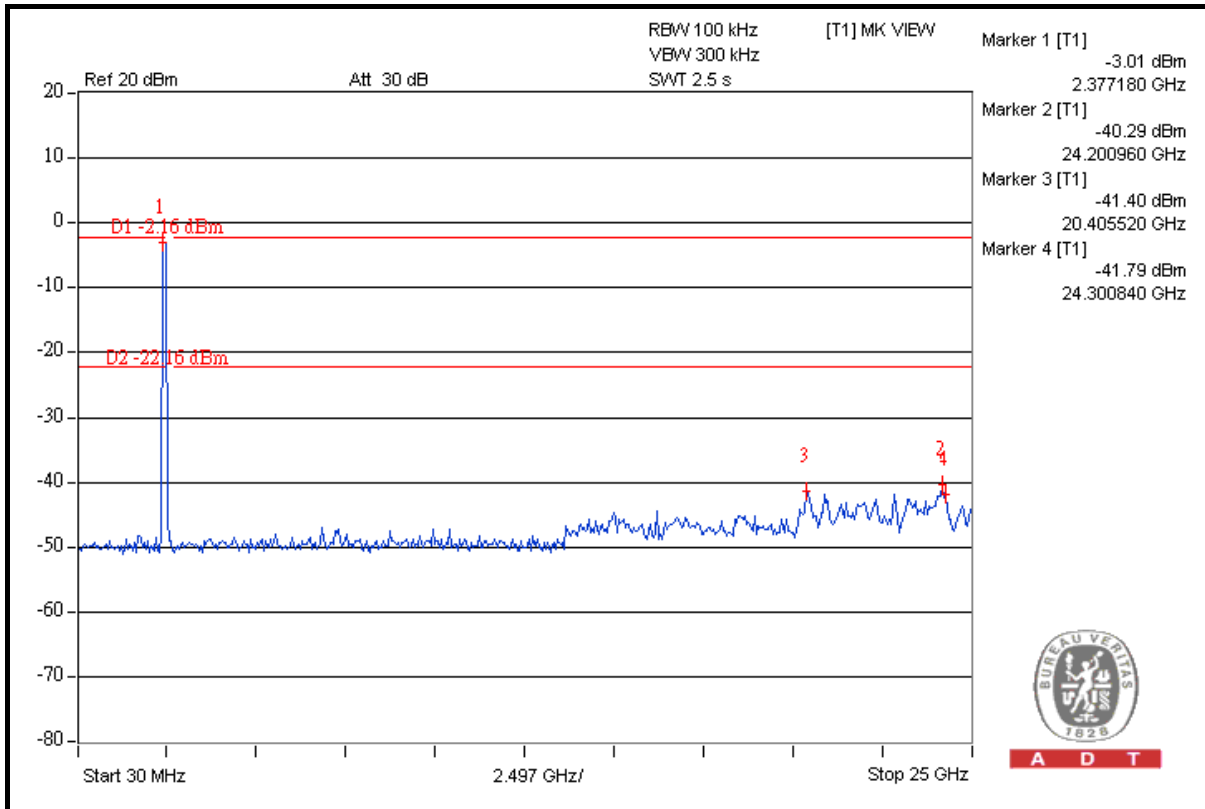



A D T

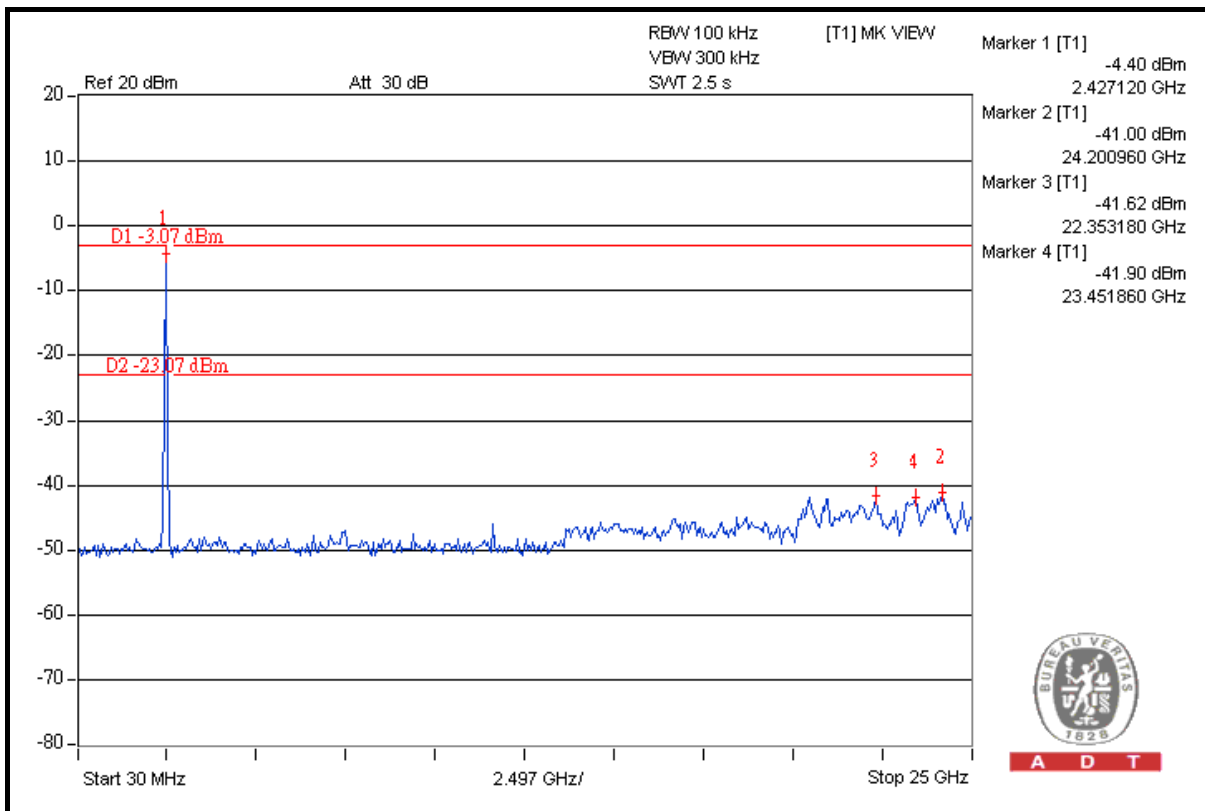
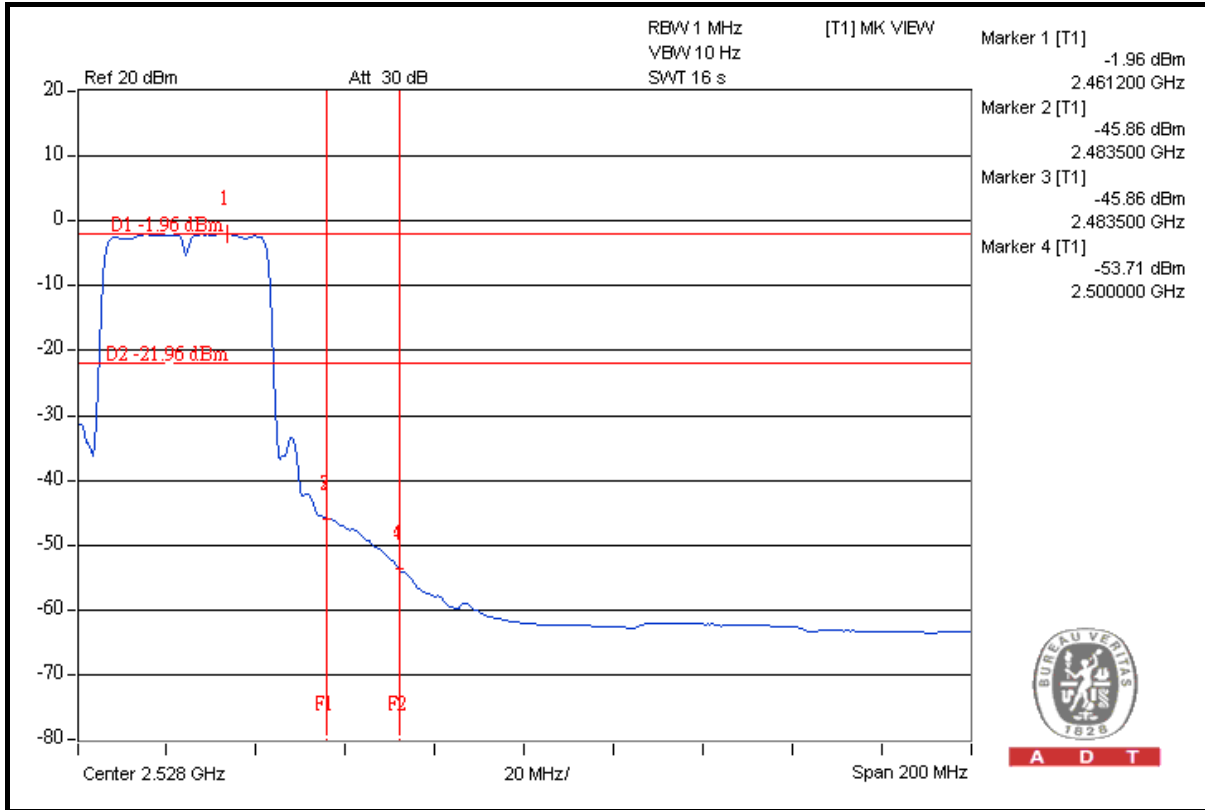



A D T

5. PHOTOGRAPHS OF THE TEST CONFIGURATION

Please refer to the attached file (Test Setup Photo).



A D T

6. INFORMATION ON THE TESTING LABORATORIES

We, Bureau Veritas Consumer Products Services (H.K.) Ltd., Taoyuan Branch, were founded in 1988 to provide our best service in EMC, Radio, Telecom and Safety consultation. Our laboratories are accredited and approved by the following approval agencies according to ISO/IEC 17025.

USA	FCC, NVLAP
Germany	TUV Rheinland
Japan	VCCI
Norway	NEMKO
Canada	INDUSTRY CANADA , CSA
R.O.C.	TAF, BSMI, NCC
Netherlands	Telefication
Singapore	GOST-ASIA(MOU)
Russia	CERTIS(MOU)

Copies of accreditation certificates of our laboratories obtained from approval agencies can be downloaded from our web site:

www.adt.com.tw/index.5/phtml. If you have any comments, please feel free to contact us at the following:

Linko EMC/RF Lab:

Tel: 886-2-26052180

Fax: 886-2-26051924

Hsin Chu EMC/RF Lab:

Tel: 886-3-5935343

Fax: 886-3-5935342

Hwa Ya EMC/RF/Safety Telecom Lab:

Tel: 886-3-3183232

Fax: 886-3-3185050

Web Site: www.adt.com.tw

The address and road map of all our labs can be found in our web site also.



A D T

7. APPENDIX A - MODIFICATIONS RECORDERS FOR ENGINEERING CHANGES TO THE EUT BY THE LAB

No any modifications are made to the EUT by the lab during the test.

---END---