



# FCC TEST REPORT

**REPORT NO.:** RF980225L04

**MODEL NO.:** WLN-2210

(refer to item 3.1 for more details)

**RECEIVED:** Mar. 19, 2009

**TESTED:** Mar. 27 ~ May 21, 2009

**ISSUED:** Jun. 19, 2009

**APPLICANT:** CAMEO COMMUNICATIONS, INC.

**ADDRESS:** 5F, No. 42, Sec. 6, Mincyuan E. Rd., Neihu District, Taipei City 114, Taiwan

**ISSUED BY:** Bureau Veritas Consumer Products Services (H.K.) Ltd., Taoyuan Branch

**LAB ADDRESS:** No. 47, 14th Ling, Chia Pau Tsuen, Lin Kou Hsiang, Taipei Hsien 244, Taiwan, R.O.C.

**TEST LOCATION:** No. 19, Hwa Ya 2nd Rd, Wen Hwa Tsuen, Kwei Shan Hsiang, Taoyuan Hsien 333, Taiwan, R.O.C.

This test report consists of 116 pages in total. It may be duplicated completely for legal use with the approval of the applicant. It should not be reproduced except in full, without the written approval of our laboratory. The client should not use it to claim product endorsement by TAF or any government agencies. The test results in the report only apply to the tested sample.





## TABLE OF CONTENTS

1.	CERTIFICATION .....	4
2.	SUMMARY OF TEST RESULTS .....	5
2.1	MEASUREMENT UNCERTAINTY .....	5
3.	GENERAL INFORMATION .....	6
3.1	GENERAL DESCRIPTION OF EUT .....	6
3.2	DESCRIPTION OF TEST MODES .....	8
3.2.1	CONFIGURATION OF SYSTEM UNDER TEST .....	8
3.2.2	TEST MODE APPLICABILITY AND TESTED CHANNEL DETAIL .....	9
3.3	GENERAL DESCRIPTION OF APPLIED STANDARDS .....	11
3.4	DESCRIPTION OF SUPPORT UNITS .....	11
4.	TEST TYPES AND RESULTS .....	12
4.1	RADIATED EMISSION MEASUREMENT .....	12
4.1.1	LIMITS OF RADIATED EMISSION MEASUREMENT .....	12
4.1.2	TEST INSTRUMENTS .....	13
4.1.3	TEST PROCEDURES .....	14
4.1.4	DEVIATION FROM TEST STANDARD .....	14
4.1.5	TEST SETUP .....	15
4.1.6	EUT OPERATING CONDITIONS .....	15
4.1.7	TEST RESULTS .....	16
4.2	CONDUCTED EMISSION MEASUREMENT .....	37
4.2.1	LIMITS OF CONDUCTED EMISSION MEASUREMENT .....	37
4.2.2	TEST INSTRUMENTS .....	37
4.2.3	TEST PROCEDURES .....	38
4.2.4	DEVIATION FROM TEST STANDARD .....	38
4.2.5	TEST SETUP .....	39
4.2.6	EUT OPERATING CONDITIONS .....	39
4.2.7	TEST RESULTS .....	40
4.3	6dB BANDWIDTH MEASUREMENT .....	46
4.3.1	LIMITS OF 6dB BANDWIDTH MEASUREMENT .....	46
4.3.2	TEST INSTRUMENTS .....	46
4.3.3	TEST PROCEDURE .....	46
4.3.4	DEVIATION FROM TEST STANDARD .....	46
4.3.5	TEST SETUP .....	47
4.3.6	EUT OPERATING CONDITIONS .....	47
4.3.7	TEST RESULTS .....	48



A D T

4.4	MAXIMUM PEAK OUTPUT POWER .....	64
4.4.1	LIMITS OF MAXIMUM PEAK OUTPUT POWER MEASUREMENT.....	64
4.4.2	INSTRUMENTS .....	64
4.4.3	TEST PROCEDURES.....	64
4.4.4	DEVIATION FROM TEST STANDARD .....	64
4.4.5	TEST SETUP .....	65
4.4.6	EUT OPERATING CONDITIONS.....	65
4.4.7	TEST RESULTS .....	66
4.5	POWER SPECTRAL DENSITY MEASUREMENT .....	69
4.5.1	LIMITS OF POWER SPECTRAL DENSITY MEASUREMENT .....	69
4.5.2	TEST INSTRUMENTS .....	69
4.5.3	TEST PROCEDURE .....	69
4.5.4	DEVIATION FROM TEST STANDARD .....	69
4.5.5	TEST SETUP .....	70
4.5.6	EUT OPERATING CONDITION .....	70
4.5.7	TEST RESULTS .....	71
4.6	BAND EDGES MEASUREMENT .....	87
4.6.1	LIMITS OF BAND EDGES MEASUREMENT .....	87
4.6.2	TEST INSTRUMENTS .....	87
4.6.3	TEST PROCEDURE .....	88
4.6.4	DEVIATION FROM TEST STANDARD .....	88
4.6.5	EUT OPERATING CONDITION .....	89
4.6.6	TEST RESULTS .....	89
4.7	ANTENNA REQUIREMENT .....	113
4.7.1	STANDARD APPLICABLE .....	113
4.7.2	ANTENNA CONNECTED CONSTRUCTION.....	113
5.	PHOTOGRAPHS OF THE TEST CONFIGURATION .....	114
6.	INFORMATION ON THE TESTING LABORATORIES.....	115
7.	APPENDIX A - MODIFICATIONS RECORDERS FOR ENGINEERING CHANGES TO THE EUT BY THE LAB.....	116



## 1. CERTIFICATION

**PRODUCT:** IEEE802.11n Draft 2.0 Wireless LAN Router

**MODEL:** WLN-2210 (refer to item 3.1 for more details)

**BRAND:** CAMEO (refer to item 3.1 for more details)

**APPLICANT:** CAMEO COMMUNICATIONS, INC.

**TESTED:** Mar. 27 ~ May 21, 2009

**TEST SAMPLE:** ENGINEERING SAMPLE

**STANDARDS:** FCC Part 15, Subpart C (Section 15.247)  
ANSI C63.4-2003

The above equipment (model: WLN-2210) has been tested by **Bureau Veritas Consumer Products Services (H.K.) Ltd., Taoyuan Branch,** and found compliance with the requirement of the above standards. The test record, data evaluation & Equipment Under Test (EUT) configurations represented herein are true and accurate accounts of the measurements of the sample's EMC characteristics under the conditions specified in this report.

**PREPARED BY** : *Polly Chien* , **DATE** : Jun. 19, 2009  
Polly Chien / Specialist

**TECHNICAL ACCEPTANCE** : *Long Chen* , **DATE** : Jun. 19, 2009  
Responsible for RF Long Chen / Senior Engineer

**APPROVED BY** : *Gary Chang* , **DATE** : Jun. 19, 2009  
Gary Chang / Assistant Manager

## 2. SUMMARY OF TEST RESULTS

The EUT has been tested according to the following specifications:

APPLIED STANDARD: FCC Part 15, Subpart C			
Standard Section	Test Type and Limit	Result	Remark
15.207	AC Power Conducted Emission	PASS	Meet the requirement of limit. Minimum passing margin is -15.47dB at 9.945MHz.
15.247(a)(2)	Spectrum Bandwidth of a Direct Sequence Spread Spectrum System Limit: min. 500kHz	PASS	Meet the requirement of limit.
15.247(b)	Maximum Peak Output Power Limit: max. 30dBm	PASS	Meet the requirement of limit.
15.247(d)	Radiated Emissions Limit: Table 15.209	PASS	Meet the requirement of limit. Minimum passing margin is -1.02dB at 2483.50MHz.
15.247(e)	Power Spectral Density Limit: max. 8dBm	PASS	Meet the requirement of limit.
15.247(d)	Band Edge Measurement Limit: 20dB less than the peak value of fundamental frequency	PASS	Meet the requirement of limit.

### 2.1 MEASUREMENT UNCERTAINTY

Where relevant, the following measurement uncertainty levels have been estimated for tests performed on the EUT as specified in CISPR 16-4-2:

MEASUREMENT	FREQUENCY	UNCERTAINTY
Conducted emissions	150kHz~30MHz	2.44 dB
Radiated emissions	30MHz ~ 200MHz	2.93 dB
	200MHz ~1000MHz	2.95 dB
	1GHz ~ 18GHz	2.26 dB
	18GHz ~ 40GHz	1.94 dB

This uncertainty represents an expanded uncertainty expressed at approximately the 95% confidence level using a coverage factor of k=2.



A D T

### 3. GENERAL INFORMATION

#### 3.1 GENERAL DESCRIPTION OF EUT

<b>PRODUCT</b>	IEEE802.11n Draft 2.0 Wireless LAN Router
<b>MODEL NO.</b>	WLN-2210 (refer to note as below)
<b>FCC ID</b>	NHPWLN2210
<b>POWER SUPPLY</b>	7.5Vdc from AC Adapter
<b>MODULATION TYPE</b>	CCK, DQPSK, DBPSK for DSSS 64QAM, 16QAM, QPSK, BPSK for OFDM
<b>MODULATION TECHNOLOGY</b>	DSSS, OFDM
<b>TRANSFER RATE</b>	802.11b: 11.0/ 5.5/ 2.0/ 1.0Mbps 802.11g: 54.0/ 48.0/ 36.0/ 24.0/ 18.0/ 12.0/ 9.0/ 6.0Mbps Draft 802.11n: up to 300.0Mbps
<b>OPERATING FREQUENCY</b>	2412MHz ~ 2462MHz
<b>NUMBER OF CHANNEL</b>	11 for 802.11b, 802.11g, Draft 802.11n (20MHz) 7 for Draft 802.11n (40MHz)
<b>MAXIMUM OUTPUT POWER</b>	256.448mW
<b>ANTENNA TYPE</b>	Dipole antenna with 2dBi gain
<b>DATA CABLE</b>	NA
<b>I/O PORTS</b>	RJ45
<b>ACCESSORY DEVICES</b>	AC Adapter

**NOTE:**

1. The EUT incorporates a MIMO function. Physically, the EUT provides two completed transmitters and two receivers.

MODULATION MODE	TX FUNCTION
802.11b	1TX
802.11g	1TX
Draft 802.11n (20MHz)	1TX / 2TX
Draft 802.11n (40MHz)	1TX / 2TX

2. The following models are provided to this EUT.

BRAND	MODEL	DIFFERENCE
CAEMO	WLN-2210	Marketing different
TRENDnet	TEW-652BRP	
ENCORE	ENHWI-N4	
Atlantisland	A02-RB-W300N	

3. The EUT was powered by the following adapters:

Adapter 1	
<b>BRAND:</b>	LEADER ELECTRONICS INC.
<b>MODEL:</b>	MU12-2075100-A1
<b>INPUT:</b>	100-240Vac, 50/60Hz, 0.5A
<b>OUTPUT:</b>	7.5Vdc, 1.0A
<b>POWER LINE:</b>	1.8 m non-shielded cable without core

Adapter 2	
<b>BRAND:</b>	LEADER ELECTRONICS INC.
<b>MODEL:</b>	MT12-Y075100-A1
<b>INPUT:</b>	120Vac, 60Hz, 0.3A
<b>OUTPUT:</b>	7.5Vdc, 1.0A
<b>POWER LINE:</b>	1.5m non-shielded cable without core

Adapter 3	
<b>BRAND:</b>	AMIGO
<b>MODEL:</b>	AMS9-0751000FU2
<b>INPUT:</b>	100-240Vac, 50/60Hz, 0.5A
<b>OUTPUT:</b>	7.5Vdc, 1.0A
<b>POWER LINE:</b>	1.5m non-shielded cable without core

4. The above EUT information was declared by manufacturer and for more detailed features description, please refer to the manufacturer's specifications or user's manual.

### 3.2 DESCRIPTION OF TEST MODES

Eleven channels are provided for 802.11b, 802.11g and draft 802.11n (20MHz):

CHANNEL	FREQUENCY	CHANNEL	FREQUENCY
1	2412MHz	7	2442MHz
2	2417MHz	8	2447MHz
3	2422MHz	9	2452MHz
4	2427MHz	10	2457MHz
5	2432MHz	11	2462MHz
6	2437MHz		

Seven channels are provided for draft 802.11n (40MHz):

CHANNEL	FREQUENCY	CHANNEL	FREQUENCY
1	2422MHz	5	2442MHz
2	2427MHz	6	2447MHz
3	2432MHz	7	2452MHz
4	2437MHz		

#### 3.2.1 CONFIGURATION OF SYSTEM UNDER TEST

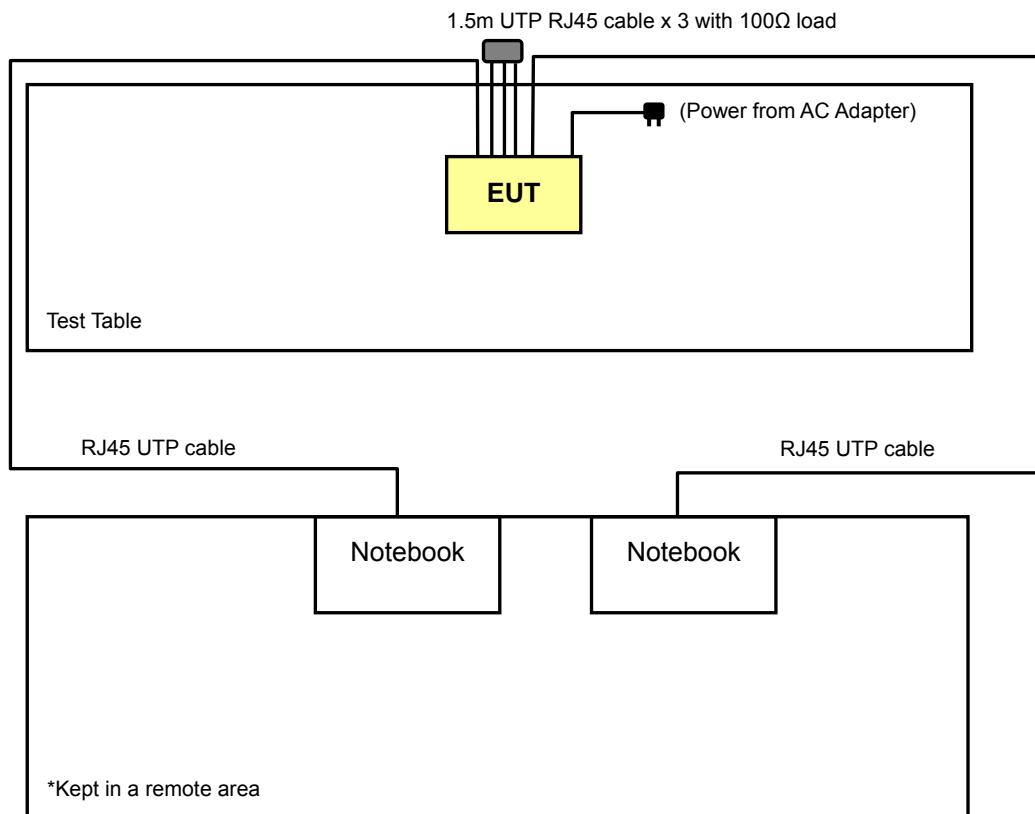





### 3.2.2 TEST MODE APPLICABILITY AND TESTED CHANNEL DETAIL

EUT CONFIGURE MODE	APPLICABLE TO				DESCRIPTION
	RE $\geq$ 1G	RE<1G	PLC	APCM	
A	√	√	√	√	Adapter 1: MU12-2075100-A1
B	-	√	√	-	Adapter 2: MT12-Y075100-A1
C	-	√	√	-	Adapter 3: AMS9-0751000FU2

Where **PLC**: Power Line Conducted Emission      **RE<1G**: Radiated Emission below 1GHz  
**RE $\geq$ 1G**: Radiated Emission above 1GHz      **APCM**: Antenna Port Conducted Measurement

**NOTE:** “-” means no effect

#### RADIATED EMISSION TEST (ABOVE 1 GHz):

- Pre-Scan has been conducted to determine the worst-case mode from all possible combinations between available modulations, data rates and antenna ports (if EUT with antenna diversity architecture).
- Following channel(s) was (were) selected for the final test as listed below.

EUT CONFIGURE MODE	MODE	AVAILABLE CHANNEL	TESTED CHANNEL	MODULATION TECHNOLOGY	MODULATION TYPE	DATA RATE (Mbps)	TX FUNCTION
A	802.11b	1 to 11	1, 6, 11	DSSS	DBPSK	1.0	1TX
A	802.11g	1 to 11	1, 6, 11	OFDM	BPSK	6.0	1TX
A	Draft 802.11n (20MHz)	1 to 11	1, 6, 11	OFDM	BPSK	7.2	1TX
A	Draft 802.11n (20MHz)	1 to 11	1, 6, 11	OFDM	BPSK	14.4	2TX
A	Draft 802.11n (40MHz)	1 to 7	1, 4, 7	OFDM	BPSK	15.0	1TX
A	Draft 802.11n (40MHz)	1 to 7	1, 4, 7	OFDM	BPSK	30.0	2TX

#### RADIATED EMISSION TEST (BELOW 1 GHz):

- Pre-Scan has been conducted to determine the worst-case mode from all possible combinations between available modulations, data rates and antenna ports (if EUT with antenna diversity architecture).
- Following channel(s) was (were) selected for the final test as listed below.

EUT CONFIGURE MODE	MODE	AVAILABLE CHANNEL	TESTED CHANNEL	MODULATION TECHNOLOGY	MODULATION TYPE	DATA RATE (Mbps)	TX FUNCTION
A, B, C	802.11g	1 to 11	6	OFDM	BPSK	6.0	1TX

**POWER LINE CONDUCTED EMISSION TEST:**

- Pre-Scan has been conducted to determine the worst-case mode from all possible combinations between available modulations, data rates and antenna ports (if EUT with antenna diversity architecture).
- Following channel(s) was (were) selected for the final test as listed below.

EUT CONFIGURE MODE	MODE	AVAILABLE CHANNEL	TESTED CHANNEL	MODULATION TECHNOLOGY	MODULATION TYPE	DATA RATE (Mbps)	TX FUNCTION
A, B, C	802.11g	1 to 11	6	OFDM	BPSK	6.0	1TX

**BANDEDGE MEASUREMENT:**

- Pre-Scan has been conducted to determine the worst-case mode from all possible combinations between available modulations, data rates and antenna ports (if EUT with antenna diversity architecture).
- Following channel(s) was (were) selected for the final test as listed below.

EUT CONFIGURE MODE	MODE	AVAILABLE CHANNEL	TESTED CHANNEL	MODULATION TECHNOLOGY	MODULATION TYPE	DATA RATE (Mbps)	TX FUNCTION
A	802.11b	1 to 11	1, 11	DSSS	DBPSK	1.0	1TX
A	802.11g	1 to 11	1, 11	OFDM	BPSK	6.0	1TX
A	Draft 802.11n (20MHz)	1 to 11	1, 11	OFDM	BPSK	7.2	1TX
A	Draft 802.11n (20MHz)	1 to 11	1, 11	OFDM	BPSK	14.4	2TX
A	Draft 802.11n (40MHz)	1 to 7	1, 7	OFDM	BPSK	15.0	1TX
A	Draft 802.11n (40MHz)	1 to 7	1, 7	OFDM	BPSK	30.0	2TX

**ANTENNA PORT CONDUCTED MEASUREMENT:**

- Pre-Scan has been conducted to determine the worst-case mode from all possible combinations between available modulations, data rates, TX function and antenna ports (if EUT with antenna diversity architecture).
- Following channel(s) was (were) selected for the final test as listed below.

EUT CONFIGURE MODE	MODE	AVAILABLE CHANNEL	TESTED CHANNEL	MODULATION TECHNOLOGY	MODULATION TYPE	DATA RATE (Mbps)	TX FUNCTION
A	802.11b	1 to 11	1, 6, 11	DSSS	DBPSK	1.0	1TX
A	802.11g	1 to 11	1, 6, 11	OFDM	BPSK	6.0	1TX
A	Draft 802.11n (20MHz)	1 to 11	1, 6, 11	OFDM	BPSK	7.2	1TX
A	Draft 802.11n (20MHz)	1 to 11	1, 6, 11	OFDM	BPSK	14.4	2TX
A	Draft 802.11n (40MHz)	1 to 7	1, 4, 7	OFDM	BPSK	15.0	1TX
A	Draft 802.11n (40MHz)	1 to 7	1, 4, 7	OFDM	BPSK	30.0	2TX

### 3.3 GENERAL DESCRIPTION OF APPLIED STANDARDS

The EUT is a RF product. According to the specifications of the manufacturer, it must comply with the requirements of the following standards:

#### **FCC Part 15, Subpart C. (15.247)**

#### **ANSI C63.4-2003**

All test items have been performed and recorded as per the above standards.

**NOTE:** The EUT is also considered as a kind of computer peripheral, because the connection to computer is necessary for typical use. It has been verified to comply with the requirements of FCC Part 15, Subpart B, Class B (DoC). The test report has been issued separately.

### 3.4 DESCRIPTION OF SUPPORT UNITS

The EUT has been tested as an independent unit together with other necessary accessories or support units. The following support units or accessories were used to form a representative test configuration during the tests.

NO.	PRODUCT	BRAND	MODEL NO.	SERIAL NO.	FCC ID
1	NOTEBOOK	DELL	PP05L	16484462992	E2K24CLNS
2	NOTEBOOK	DELL	PP05L	12130898320	E2K24CLNS

NO.	SIGNAL CABLE DESCRIPTION OF THE ABOVE SUPPORT UNITS
1	10m RJ45 UTP cable.
2	10m RJ45 UTP cable.

**NOTE:** 1. All power cords of the above support units are non shielded (1.8m).  
 2. Items 1 & 2 acted as communication partners to transfer data.

## 4. TEST TYPES AND RESULTS

### 4.1 RADIATED EMISSION MEASUREMENT

#### 4.1.1 LIMITS OF RADIATED EMISSION MEASUREMENT

Emissions radiated outside of the specified bands, shall be according to the general radiated limits in 15.209 as following:

FREQUENCIES (MHz)	FIELD STRENGTH (microvolts/meter)	MEASUREMENT DISTANCE (meters)
0.009 ~ 0.490	2400 / F(kHz)	300
0.490 ~ 1.705	24000 / F(kHz)	30
1.705 ~ 30.0	30	30
30 ~ 88	100	3
88 ~ 216	150	3
216 ~ 960	200	3
Above 960	500	3

**NOTE:**

1. The lower limit shall apply at the transition frequencies.
2. Emission level (dBuV/m) = 20 log Emission level (uV/m).
3. As shown in 15.35(b), for frequencies above 1000MHz, the field strength limits are based on average detector, however, the peak field strength of any emission shall not exceed the maximum permitted average limits, specified above by more than 20dB under any condition of modulation.

#### 4.1.2 TEST INSTRUMENTS

DESCRIPTION & MANUFACTURER	MODEL NO.	SERIAL NO.	DATE OF CALIBRATION	DUE DATE OF CALIBRATION
Test Receiver ROHDE & SCHWARZ	ESIB7	100212	May 28, 2008	May 27, 2009
Spectrum Analyzer ROHDE & SCHWARZ	FSP40	100269	Aug. 08, 2008	Aug. 07, 2009
BILOG Antenna SCHWARZBECK	VULB9168	9168-155	Apr. 30, 2008	Apr. 28, 2010
HORN Antenna SCHWARZBECK	BBHA 9120 D	9120D-563	Aug. 06, 2008	Aug. 05, 2009
HORN Antenna SCHWARZBECK	BBHA 9170	BBHA9170242	Jan. 06, 2009	Jan. 05, 2010
Preamplifier Agilent	8449B	3008A01911	Sep. 10, 2008	Sep. 09, 2009
Preamplifier Agilent	8447D	2944A10638	Dec. 26, 2008	Dec. 25, 2009
RF signal cable HUBER+SUHNER	SUCOFLEX 104	218190/4 231241/4	Aug. 21, 2008	Aug. 20, 2009
RF signal cable Worken	8D-FB	Cable-HYCH9-01	Aug. 09, 2008	Aug. 08, 2009
Software	ADT_Radiated_ V7.6.15.9.2	NA	NA	NA
Antenna Tower EMCO	2070/2080	512.835.4684	NA	NA
Turn Table EMCO	2087-2.03	NA	NA	NA
Antenna Tower & Turn Table Controller EMCO	2090	NA	NA	NA

- NOTE:**
1. The calibration interval of the above test instruments is 12 months and the calibrations are traceable to NML/ROC and NIST/USA.
  2. The test was performed in HwaYa Chamber 9.
  3. The horn antenna and HP preamplifier (model: 8449B) are used only for the measurement of emission frequency above 1GHz if tested.
  4. The FCC Site Registration No. is 460141.
  5. The IC Site Registration No. is IC 7450F-4.

#### 4.1.3 TEST PROCEDURES

- a. The EUT was placed on the top of a rotating table 0.8 meters above the ground at a 3 meters semi-anechoic chamber. The table was rotated 360 degrees to determine the position of the highest radiation.
- b. The EUT was set 3 meters away from the interference-receiving antenna, which was mounted on the top of a variable-height antenna tower.
- c. The antenna is a broadband antenna, and its height is varied from one meter to four meters above the ground to determine the maximum value of the field strength. Both horizontal and vertical polarizations of the antenna are set to make the measurement.
- d. For each suspected emission, the EUT was arranged to its worst case and then the antenna was tuned to heights from 1 meter to 4 meters and the rotatable table was turned from 0 degrees to 360 degrees to find the maximum reading.
- e. The test-receiver system was set to Peak Detect Function and Specified Bandwidth with Maximum Hold Mode.
- f. If the emission level of the EUT in peak mode was lower than the limit specified, then testing could be stopped and the peak values of the EUT would be reported. Otherwise the emissions would be re-tested one by one using peak, quasi-peak or average method as specified and then reported in a data sheet.

**NOTE:**

1. The resolution bandwidth and video bandwidth of test receiver/spectrum analyzer is 120kHz for Peak detection (PK) and Quasi-peak detection (QP) at frequency below 1GHz.
2. The resolution bandwidth of test receiver/spectrum analyzer is 1 MHz and video bandwidth is 3MHz for Peak detection at frequency above 1GHz.
3. The resolution bandwidth of test receiver/spectrum analyzer is 1MHz and the video bandwidth is 10Hz for Average detection (AV) at frequency above 1GHz.
4. All modes of operation were investigated and the worst-case emissions are reported.

#### 4.1.4 DEVIATION FROM TEST STANDARD

No deviation

#### 4.1.5 TEST SETUP

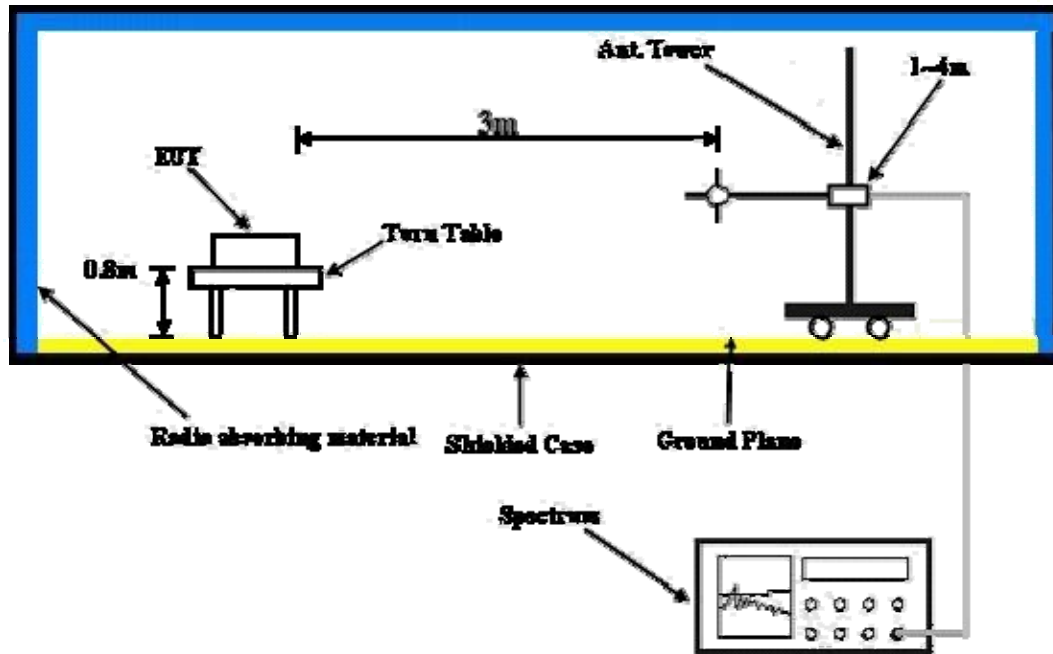

For the actual test configuration, please refer to the attached file (Test Setup Photo)

#### 4.1.6 EUT OPERATING CONDITIONS

- a. Placed the EUT on the testing table.
- b. Prepared notebooks system outside of testing area to act as communication partners.
- c. The communication partner connected with EUT via a RJ45 UTP cable and run a test program (provided by manufacturer) to enable EUT under transmission condition continuously at specific channel frequency.
- d. The communication partner sent data to EUT by command "PING".

#### 4.1.7 TEST RESULTS

##### 802.11b DSSS MODULATION: 1TX

EUT TEST CONDITION		MEASUREMENT DETAIL	
CHANNEL	Channel 1	FREQUENCY RANGE	1 ~ 25GHz
INPUT POWER	120Vac, 60 Hz	DETECTOR FUNCTION	Peak (PK) Average (AV)
ENVIRONMENTAL CONDITIONS	23.0deg. C, 70.0%RH 1000hPa	TESTED BY	Lori Chiu

ANTENNA POLARITY & TEST DISTANCE: HORIZONTAL AT 3 M								
NO.	FREQ. (MHz)	EMISSION LEVEL (dBuV/m)	LIMIT (dBuV/m)	MARGIN (dB)	ANTENNA HEIGHT (m)	TABLE ANGLE (Degree)	RAW VALUE (dBuV)	CORRECTION FACTOR (dB/m)
1	2387.00	59.57 PK	74.00	-14.43	1.06 H	174	26.51	33.06
2	2387.00	48.17 AV	54.00	-5.83	1.06 H	174	15.11	33.06
3	*2412.00	103.92 PK			1.05 H	171	70.74	33.18
4	*2412.00	99.45 AV			1.05 H	171	66.27	33.18
5	4824.00	49.23 PK	74.00	-24.77	1.13 H	142	10.08	39.15
6	4824.00	37.53 AV	54.00	-16.47	1.13 H	142	-1.62	39.15
7	#7236.00	52.80 PK	83.92	-31.12	1.13 H	3	7.50	45.30
8	#7236.00	40.45 AV	79.45	-39.00	1.13 H	3	-4.85	45.30
ANTENNA POLARITY & TEST DISTANCE: VERTICAL AT 3 M								
NO.	FREQ. (MHz)	EMISSION LEVEL (dBuV/m)	LIMIT (dBuV/m)	MARGIN (dB)	ANTENNA HEIGHT (m)	TABLE ANGLE (Degree)	RAW VALUE (dBuV)	CORRECTION FACTOR (dB/m)
1	2386.00	62.37 PK	74.00	-11.63	1.18 V	34	29.31	33.06
2	2386.00	52.24 AV	54.00	-1.76	1.18 V	34	19.18	33.06
3	*2412.00	112.88 PK			1.17 V	208	79.70	33.18
4	*2412.00	108.06 AV			1.17 V	208	74.88	33.18
5	4824.00	52.65 PK	74.00	-21.35	1.14 V	217	13.50	39.15
6	4824.00	44.90 AV	54.00	-9.10	1.14 V	217	5.75	39.15
7	#7236.00	62.22 PK	92.88	-30.66	1.13 V	220	16.92	45.30
8	#7236.00	55.58 AV	88.06	-32.48	1.13 V	220	10.28	45.30

- REMARKS:**
1. Emission level (dBuV/m) = Raw Value (dBuV) + Correction Factor (dB/m).
  2. Correction Factor (dB/m) = Antenna Factor (dB/m) + Cable Factor (dB).
  3. The other emission levels were very low against the limit.
  4. Margin value = Emission level – Limit value.
  5. “ \* “: Fundamental frequency.
  6. “#”: The radiated frequency is out the restricted band.





A D T

EUT TEST CONDITION		MEASUREMENT DETAIL	
CHANNEL	Channel 6	FREQUENCY RANGE	1 ~ 25GHz
INPUT POWER	120Vac, 60 Hz	DETECTOR FUNCTION	Peak (PK) Average (AV)
ENVIRONMENTAL CONDITIONS	23.0deg. C, 70.0%RH 1000hPa	TESTED BY	Lori Chiu

ANTENNA POLARITY & TEST DISTANCE: HORIZONTAL AT 3 M								
NO.	FREQ. (MHz)	EMISSION LEVEL (dBuV/m)	LIMIT (dBuV/m)	MARGIN (dB)	ANTENNA HEIGHT (m)	TABLE ANGLE (Degree)	RAW VALUE (dBuV)	CORRECTION FACTOR (dB/m)
1	*2437.00	103.33 PK			1.02 H	166	70.05	33.28
2	*2437.00	99.28 AV			1.02 H	166	66.00	33.28
3	4874.00	49.54 PK	74.00	-24.46	1.00 H	34	10.40	39.14
4	4874.00	37.58 AV	54.00	-16.42	1.00 H	34	-1.56	39.14
5	7311.00	52.48 PK	74.00	-21.52	1.20 H	135	6.95	45.53
6	7311.00	40.45 AV	54.00	-13.55	1.20 H	135	-5.08	45.53
ANTENNA POLARITY & TEST DISTANCE: VERTICAL AT 3 M								
NO.	FREQ. (MHz)	EMISSION LEVEL (dBuV/m)	LIMIT (dBuV/m)	MARGIN (dB)	ANTENNA HEIGHT (m)	TABLE ANGLE (Degree)	RAW VALUE (dBuV)	CORRECTION FACTOR (dB/m)
1	*2437.00	112.70 PK			1.10 V	258	79.42	33.28
2	*2437.00	107.89 AV			1.10 V	258	74.61	33.28
3	4874.00	51.94 PK	74.00	-22.06	1.01 V	227	12.79	39.14
4	4874.00	43.93 AV	54.00	-10.07	1.01 V	227	4.78	39.14
5	7311.00	60.20 PK	74.00	-13.80	1.09 V	193	14.67	45.53
6	7311.00	52.89 AV	54.00	-1.11	1.09 V	193	7.36	45.53

- REMARKS:**
1. Emission level (dBuV/m) = Raw Value (dBuV) + Correction Factor (dB/m).
  2. Correction Factor (dB/m) = Antenna Factor (dB/m) + Cable Factor (dB).
  3. The other emission levels were very low against the limit.
  4. Margin value = Emission level – Limit value.
  5. “ \* “: Fundamental frequency.



A D T

EUT TEST CONDITION		MEASUREMENT DETAIL	
CHANNEL	Channel 11	FREQUENCY RANGE	1 ~ 25GHz
INPUT POWER	120Vac, 60 Hz	DETECTOR FUNCTION	Peak (PK) Average (AV)
ENVIRONMENTAL CONDITIONS	23.0deg. C, 70.0%RH 1000hPa	TESTED BY	Lori Chiu

ANTENNA POLARITY & TEST DISTANCE: HORIZONTAL AT 3 M								
NO.	FREQ. (MHz)	EMISSION LEVEL (dBuV/m)	LIMIT (dBuV/m)	MARGIN (dB)	ANTENNA HEIGHT (m)	TABLE ANGLE (Degree)	RAW VALUE (dBuV)	CORRECTION FACTOR (dB/m)
1	*2462.00	103.86 PK			1.00 H	135	70.48	33.38
2	*2462.00	99.38 AV			1.00 H	135	66.00	33.38
3	2483.50	59.50 PK	74.00	-14.50	1.00 H	135	26.04	33.46
4	2483.50	48.21 AV	54.00	-5.79	1.00 H	135	14.75	33.46
5	4924.00	49.35 PK	74.00	-24.65	1.11 H	18	10.00	39.35
6	4924.00	37.61 AV	54.00	-16.39	1.11 H	18	-1.74	39.35
7	7386.00	52.94 PK	74.00	-21.06	1.02 H	276	7.18	45.76
8	7386.00	42.61 AV	54.00	-11.39	1.02 H	276	-3.15	45.76
ANTENNA POLARITY & TEST DISTANCE: VERTICAL AT 3 M								
NO.	FREQ. (MHz)	EMISSION LEVEL (dBuV/m)	LIMIT (dBuV/m)	MARGIN (dB)	ANTENNA HEIGHT (m)	TABLE ANGLE (Degree)	RAW VALUE (dBuV)	CORRECTION FACTOR (dB/m)
1	*2462.00	112.85 PK			1.08 V	289	79.47	33.38
2	*2462.00	108.24 AV			1.08 V	289	74.86	33.38
3	2483.50	61.07 PK	74.00	-12.93	1.09 V	306	27.61	33.46
4	2483.50	51.34 AV	54.00	-2.66	1.09 V	306	17.88	33.46
5	4924.00	52.43 PK	74.00	-21.57	1.01 V	226	13.07	39.35
6	4924.00	45.64 AV	54.00	-8.36	1.01 V	226	6.28	39.35
7	7386.00	59.88 PK	74.00	-14.12	1.00 V	350	14.13	45.76
8	7386.00	50.57 AV	54.00	-3.43	1.00 V	350	4.82	45.76

- REMARKS:**
1. Emission level (dBuV/m) = Raw Value (dBuV) + Correction Factor (dB/m).
  2. Correction Factor (dB/m) = Antenna Factor (dB/m) + Cable Factor (dB).
  3. The other emission levels were very low against the limit.
  4. Margin value = Emission level – Limit value.
  5. “ \* “: Fundamental frequency.

### 802.11g OFDM MODULATION: 1TX

EUT TEST CONDITION		MEASUREMENT DETAIL	
CHANNEL	Channel 1	FREQUENCY RANGE	1 ~ 25GHz
INPUT POWER	120Vac, 60 Hz	DETECTOR FUNCTION	Peak (PK) Average (AV)
ENVIRONMENTAL CONDITIONS	23.0deg. C, 70.0%RH 1000hPa	TESTED BY	Lori Chiu

ANTENNA POLARITY & TEST DISTANCE: HORIZONTAL AT 3 M								
NO.	FREQ. (MHz)	EMISSION LEVEL (dBuV/m)	LIMIT (dBuV/m)	MARGIN (dB)	ANTENNA HEIGHT (m)	TABLE ANGLE (Degree)	RAW VALUE (dBuV)	CORRECTION FACTOR (dB/m)
1	2390.00	60.51 PK	74.00	-13.49	1.42 H	211	27.43	33.08
2	2390.00	48.04 AV	54.00	-5.96	1.42 H	211	14.96	33.08
3	*2412.00	102.39 PK			1.39 H	21	69.21	33.18
4	*2412.00	92.32 AV			1.39 H	21	59.14	33.18
5	4824.00	49.01 PK	74.00	-24.99	1.10 H	124	9.86	39.15
6	4824.00	36.24 AV	54.00	-17.76	1.10 H	124	-2.91	39.15
7	#7236.00	55.03 PK	82.39	-27.36	1.19 H	319	9.73	45.30
8	#7236.00	41.36 AV	72.32	-30.96	1.19 H	319	-3.94	45.30
ANTENNA POLARITY & TEST DISTANCE: VERTICAL AT 3 M								
NO.	FREQ. (MHz)	EMISSION LEVEL (dBuV/m)	LIMIT (dBuV/m)	MARGIN (dB)	ANTENNA HEIGHT (m)	TABLE ANGLE (Degree)	RAW VALUE (dBuV)	CORRECTION FACTOR (dB/m)
1	2390.00	67.79 PK	74.00	-6.21	1.19 V	205	34.71	33.08
2	2390.00	52.22 AV	54.00	-1.78	1.19 V	205	19.14	33.08
3	*2412.00	111.48 PK			1.19 V	202	78.30	33.18
4	*2412.00	101.62 AV			1.19 V	202	68.44	33.18
5	4824.00	49.15 PK	74.00	-24.85	1.11 V	108	10.00	39.15
6	4824.00	37.29 AV	54.00	-16.71	1.11 V	108	-1.86	39.15
7	#7236.00	63.15 PK	91.48	-28.33	1.20 V	39	17.85	45.30
8	#7236.00	48.13 AV	81.62	-33.49	1.20 V	39	2.83	45.30

- REMARKS:**
1. Emission level (dBuV/m) = Raw Value (dBuV) + Correction Factor (dB/m).
  2. Correction Factor (dB/m) = Antenna Factor (dB/m) + Cable Factor (dB).
  3. The other emission levels were very low against the limit.
  4. Margin value = Emission level – Limit value.
  5. “ \* “: Fundamental frequency.
  6. “#”:The radiated frequency is out the restricted band.



A D T

EUT TEST CONDITION		MEASUREMENT DETAIL	
CHANNEL	Channel 6	FREQUENCY RANGE	1 ~ 25GHz
INPUT POWER	120Vac, 60 Hz	DETECTOR FUNCTION	Peak (PK) Average (AV)
ENVIRONMENTAL CONDITIONS	23.0deg. C, 70.0%RH 1000hPa	TESTED BY	Lori Chiu

ANTENNA POLARITY & TEST DISTANCE: HORIZONTAL AT 3 M								
NO.	FREQ. (MHz)	EMISSION LEVEL (dBuV/m)	LIMIT (dBuV/m)	MARGIN (dB)	ANTENNA HEIGHT (m)	TABLE ANGLE (Degree)	RAW VALUE (dBuV)	CORRECTION FACTOR (dB/m)
1	*2437.00	102.25 PK			1.44 H	216	68.97	33.28
2	*2437.00	92.28 AV			1.44 H	216	59.00	33.28
3	4874.00	48.88 PK	74.00	-25.12	1.20 H	147	9.74	39.14
4	4874.00	35.49 AV	54.00	-18.51	1.20 H	147	-3.65	39.14
5	7311.00	54.10 PK	74.00	-19.90	1.00 H	320	8.57	45.53
6	7311.00	41.22 AV	54.00	-12.78	1.00 H	320	-4.31	45.53
ANTENNA POLARITY & TEST DISTANCE: VERTICAL AT 3 M								
NO.	FREQ. (MHz)	EMISSION LEVEL (dBuV/m)	LIMIT (dBuV/m)	MARGIN (dB)	ANTENNA HEIGHT (m)	TABLE ANGLE (Degree)	RAW VALUE (dBuV)	CORRECTION FACTOR (dB/m)
1	*2437.00	111.35 PK			1.20 V	326	78.07	33.28
2	*2437.00	101.59 AV			1.20 V	326	68.31	33.28
3	4874.00	49.16 PK	74.00	-24.84	1.00 V	167	10.02	39.14
4	4874.00	37.64 AV	54.00	-16.36	1.00 V	167	-1.50	39.14
5	7311.00	61.54 PK	74.00	-12.46	1.19 V	6	16.01	45.53
6	7311.00	46.46 AV	54.00	-7.54	1.19 V	6	0.93	45.53

- REMARKS:**
1. Emission level (dBuV/m) = Raw Value (dBuV) + Correction Factor (dB/m).
  2. Correction Factor (dB/m) = Antenna Factor (dB/m) + Cable Factor (dB).
  3. The other emission levels were very low against the limit.
  4. Margin value = Emission level – Limit value.
  5. “ \* “: Fundamental frequency.



A D T

EUT TEST CONDITION		MEASUREMENT DETAIL	
CHANNEL	Channel 11	FREQUENCY RANGE	1 ~ 25GHz
INPUT POWER	120Vac, 60 Hz	DETECTOR FUNCTION	Peak (PK) Average (AV)
ENVIRONMENTAL CONDITIONS	23.0deg. C, 70.0%RH 1000hPa	TESTED BY	Lori Chiu

ANTENNA POLARITY & TEST DISTANCE: HORIZONTAL AT 3 M								
NO.	FREQ. (MHz)	EMISSION LEVEL (dBuV/m)	LIMIT (dBuV/m)	MARGIN (dB)	ANTENNA HEIGHT (m)	TABLE ANGLE (Degree)	RAW VALUE (dBuV)	CORRECTION FACTOR (dB/m)
1	*2462.00	101.89 PK			1.26 H	254	68.51	33.38
2	*2462.00	91.58 AV			1.26 H	254	58.20	33.38
3	2483.50	60.43 PK	74.00	-13.57	1.26 H	254	26.97	33.46
4	2483.50	47.84 AV	54.00	-6.16	1.26 H	254	14.38	33.46
5	4824.00	47.89 PK	74.00	-26.11	1.14 H	73	8.74	39.15
6	4824.00	35.52 AV	54.00	-18.48	1.14 H	73	-3.63	39.15
7	7386.00	53.24 PK	74.00	-20.76	1.01 H	228	7.49	45.76
8	7386.00	41.02 AV	54.00	-12.98	1.01 H	228	-4.73	45.76
ANTENNA POLARITY & TEST DISTANCE: VERTICAL AT 3 M								
NO.	FREQ. (MHz)	EMISSION LEVEL (dBuV/m)	LIMIT (dBuV/m)	MARGIN (dB)	ANTENNA HEIGHT (m)	TABLE ANGLE (Degree)	RAW VALUE (dBuV)	CORRECTION FACTOR (dB/m)
1	*2462.00	110.48 PK			1.08 V	263	77.10	33.38
2	*2462.00	100.41 AV			1.08 V	263	67.03	33.38
3	2483.50	69.22 PK	74.00	-4.78	1.07 V	265	35.76	33.46
4	2483.50	52.00 AV	54.00	-2.00	1.07 V	265	18.54	33.46
5	4924.00	48.90 PK	74.00	-25.10	1.37 V	93	9.54	39.35
6	4924.00	37.88 AV	54.00	-16.12	1.37 V	93	-1.48	39.35
7	7386.00	58.05 PK	74.00	-15.95	1.26 V	347	12.30	45.76
8	7386.00	42.75 AV	54.00	-11.25	1.26 V	347	-3.00	45.76

- REMARKS:**
1. Emission level (dBuV/m) = Raw Value (dBuV) + Correction Factor (dB/m).
  2. Correction Factor (dB/m) = Antenna Factor (dB/m) + Cable Factor (dB).
  3. The other emission levels were very low against the limit.
  4. Margin value = Emission level – Limit value.
  5. “ \* “: Fundamental frequency.

**DRAFT 802.11n (20MHz) OFDM MODULATION: 1TX**

EUT TEST CONDITION		MEASUREMENT DETAIL	
CHANNEL	Channel 1	FREQUENCY RANGE	1 ~ 25GHz
INPUT POWER	120Vac, 60 Hz	DETECTOR FUNCTION	Peak (PK) Average (AV)
ENVIRONMENTAL CONDITIONS	23.0deg. C, 70.0%RH 1000hPa	TESTED BY	Mark Liao

ANTENNA POLARITY & TEST DISTANCE: HORIZONTAL AT 3 M								
NO.	FREQ. (MHz)	EMISSION LEVEL (dBuV/m)	LIMIT (dBuV/m)	MARGIN (dB)	ANTENNA HEIGHT (m)	TABLE ANGLE (Degree)	RAW VALUE (dBuV)	CORRECTION FACTOR (dB/m)
1	2390.00	62.37 PK	74.00	-11.63	1.31 H	219	29.29	33.08
2	2390.00	47.81 AV	54.00	-6.19	1.31 H	219	14.73	33.08
3	*2412.00	103.23 PK			1.31 H	219	70.05	33.18
4	*2412.00	91.99 AV			1.31 H	219	58.81	33.18
5	4824.00	48.42 PK	74.00	-25.58	1.21 H	12	9.27	39.15
6	4824.00	35.83 AV	54.00	-18.17	1.21 H	12	-3.32	39.15
7	#7236.00	55.37 PK	83.23	-27.86	1.17 H	325	10.07	45.30
8	#7236.00	40.38 AV	71.99	-31.61	1.17 H	325	-4.92	45.30

ANTENNA POLARITY & TEST DISTANCE: VERTICAL AT 3 M								
NO.	FREQ. (MHz)	EMISSION LEVEL (dBuV/m)	LIMIT (dBuV/m)	MARGIN (dB)	ANTENNA HEIGHT (m)	TABLE ANGLE (Degree)	RAW VALUE (dBuV)	CORRECTION FACTOR (dB/m)
1	2390.00	66.89 PK	74.00	-7.11	1.17 V	202	33.81	33.08
2	2390.00	50.71 AV	54.00	-3.29	1.17 V	202	17.63	33.08
3	*2412.00	110.91 PK			1.17 V	202	77.73	33.18
4	*2412.00	100.44 AV			1.17 V	202	67.26	33.18
5	4824.00	49.18 PK	74.00	-24.82	1.11 V	55	10.03	39.15
6	4824.00	37.19 AV	54.00	-16.81	1.11 V	55	-1.96	39.15
7	#7236.00	63.30 PK	90.91	-27.61	1.21 V	199	18.00	45.30
8	#7236.00	46.14 AV	80.44	-34.30	1.21 V	199	0.84	45.30

- REMARKS:**
1. Emission level (dBuV/m) = Raw Value (dBuV) + Correction Factor (dB/m).
  2. Correction Factor (dB/m) = Antenna Factor (dB/m) + Cable Factor (dB).
  3. The other emission levels were very low against the limit.
  4. Margin value = Emission level – Limit value.
  5. “ \* “: Fundamental frequency.
  6. "#":The radiated frequency is out the restricted band.

EUT TEST CONDITION		MEASUREMENT DETAIL	
CHANNEL	Channel 6	FREQUENCY RANGE	1 ~ 25GHz
INPUT POWER	120Vac, 60 Hz	DETECTOR FUNCTION	Peak (PK) Average (AV)
ENVIRONMENTAL CONDITIONS	23.0deg. C, 70.0%RH 1000hPa	TESTED BY	Mark Liao

ANTENNA POLARITY & TEST DISTANCE: HORIZONTAL AT 3 M								
NO.	FREQ. (MHz)	EMISSION LEVEL (dBuV/m)	LIMIT (dBuV/m)	MARGIN (dB)	ANTENNA HEIGHT (m)	TABLE ANGLE (Degree)	RAW VALUE (dBuV)	CORRECTION FACTOR (dB/m)
1	*2437.00	103.30 PK			1.28 H	178	70.02	33.28
2	*2437.00	92.10 AV			1.28 H	178	58.82	33.28
3	4874.00	48.69 PK	74.00	-25.31	1.23 H	155	9.54	39.14
4	4874.00	36.21 AV	54.00	-17.79	1.23 H	155	-2.94	39.14
5	7311.00	52.79 PK	74.00	-21.21	1.12 H	317	7.26	45.53
6	7311.00	40.04 AV	54.00	-13.96	1.12 H	317	-5.49	45.53
ANTENNA POLARITY & TEST DISTANCE: VERTICAL AT 3 M								
NO.	FREQ. (MHz)	EMISSION LEVEL (dBuV/m)	LIMIT (dBuV/m)	MARGIN (dB)	ANTENNA HEIGHT (m)	TABLE ANGLE (Degree)	RAW VALUE (dBuV)	CORRECTION FACTOR (dB/m)
1	*2437.00	111.12 PK			1.20 V	193	77.84	33.28
2	*2437.00	100.53 AV			1.20 V	193	67.25	33.28
3	4874.00	48.95 PK	74.00	-25.05	1.37 V	50	9.80	39.14
4	4874.00	36.76 AV	54.00	-17.24	1.37 V	50	-2.39	39.14
5	7311.00	62.60 PK	74.00	-11.40	1.37 V	316	17.07	45.53
6	7311.00	43.98 AV	54.00	-10.02	1.37 V	316	-1.55	45.53

- REMARKS:**
1. Emission level (dBuV/m) = Raw Value (dBuV) + Correction Factor (dB/m).
  2. Correction Factor (dB/m) = Antenna Factor (dB/m) + Cable Factor (dB).
  3. The other emission levels were very low against the limit.
  4. Margin value = Emission level – Limit value.
  5. “ \* “: Fundamental frequency.

EUT TEST CONDITION		MEASUREMENT DETAIL	
CHANNEL	Channel 11	FREQUENCY RANGE	1 ~ 25GHz
INPUT POWER	120Vac, 60 Hz	DETECTOR FUNCTION	Peak (PK) Average (AV)
ENVIRONMENTAL CONDITIONS	23.0deg. C, 70.0%RH 1000hPa	TESTED BY	Mark Liao

ANTENNA POLARITY & TEST DISTANCE: HORIZONTAL AT 3 M								
NO.	FREQ. (MHz)	EMISSION LEVEL (dBuV/m)	LIMIT (dBuV/m)	MARGIN (dB)	ANTENNA HEIGHT (m)	TABLE ANGLE (Degree)	RAW VALUE (dBuV)	CORRECTION FACTOR (dB/m)
1	*2462.00	103.32 PK			1.04 H	171	69.94	33.38
2	*2462.00	92.15 AV			1.04 H	171	58.77	33.38
3	2483.50	66.74 PK	74.00	-7.26	1.04 H	171	33.28	33.46
4	2483.50	49.71 AV	54.00	-4.29	1.04 H	171	16.25	33.46
5	4924.00	49.72 PK	74.00	-24.28	1.12 H	167	10.36	39.35
6	4924.00	35.46 AV	54.00	-18.54	1.12 H	167	-3.90	39.35
7	7386.00	53.08 PK	74.00	-20.92	1.22 H	285	7.33	45.76
8	7386.00	40.52 AV	54.00	-13.48	1.22 H	285	-5.23	45.76
ANTENNA POLARITY & TEST DISTANCE: VERTICAL AT 3 M								
NO.	FREQ. (MHz)	EMISSION LEVEL (dBuV/m)	LIMIT (dBuV/m)	MARGIN (dB)	ANTENNA HEIGHT (m)	TABLE ANGLE (Degree)	RAW VALUE (dBuV)	CORRECTION FACTOR (dB/m)
1	*2462.00	110.90 PK			1.15 V	33	77.52	33.38
2	*2462.00	100.40 AV			1.15 V	33	67.02	33.38
3	2483.50	72.72 PK	74.00	-1.28	1.13 V	184	39.26	33.46
4	<b>2483.50</b>	<b>52.98 AV</b>	<b>54.00</b>	<b>-1.02</b>	<b>1.13 V</b>	<b>184</b>	<b>19.52</b>	<b>33.46</b>
5	4924.00	48.90 PK	74.00	-25.10	1.39 V	228	9.54	39.35
6	4924.00	36.43 AV	54.00	-17.57	1.39 V	228	-2.93	39.35
7	7386.00	58.06 PK	74.00	-15.94	1.40 V	74	12.31	45.76
8	7386.00	41.64 AV	54.00	-12.36	1.40 V	74	-4.11	45.76

- REMARKS:**
1. Emission level (dBuV/m) = Raw Value (dBuV) + Correction Factor (dB/m).
  2. Correction Factor (dB/m) = Antenna Factor (dB/m) + Cable Factor (dB).
  3. The other emission levels were very low against the limit.
  4. Margin value = Emission level – Limit value.
  5. “ \* “: Fundamental frequency.



**DRAFT 802.11n (20MHz) OFDM MODULATION: 2TX**

EUT TEST CONDITION		MEASUREMENT DETAIL	
CHANNEL	Channel 1	FREQUENCY RANGE	1 ~ 25GHz
INPUT POWER	120Vac, 60 Hz	DETECTOR FUNCTION	Peak (PK) Average (AV)
ENVIRONMENTAL CONDITIONS	23.0deg. C, 70.0%RH 1000hPa	TESTED BY	Mark Liao

ANTENNA POLARITY & TEST DISTANCE: HORIZONTAL AT 3 M								
NO.	FREQ. (MHz)	EMISSION LEVEL (dBuV/m)	LIMIT (dBuV/m)	MARGIN (dB)	ANTENNA HEIGHT (m)	TABLE ANGLE (Degree)	RAW VALUE (dBuV)	CORRECTION FACTOR (dB/m)
1	2390.00	61.29 PK	74.00	-12.71	1.05 H	172	28.21	33.08
2	2390.00	46.64 AV	54.00	-7.36	1.05 H	172	13.56	33.08
3	*2412.00	100.57 PK			1.05 H	172	67.39	33.18
4	*2412.00	88.79 AV			1.05 H	172	55.61	33.18
5	4824.00	48.96 PK	74.00	-25.04	1.13 H	186	9.81	39.15
6	4824.00	36.07 AV	54.00	-17.93	1.13 H	186	-3.08	39.15
7	#7236.00	52.73 PK	80.57	-27.84	1.22 H	46	7.43	45.30
8	#7236.00	39.84 AV	68.79	-28.95	1.22 H	46	-5.46	45.30
ANTENNA POLARITY & TEST DISTANCE: VERTICAL AT 3 M								
NO.	FREQ. (MHz)	EMISSION LEVEL (dBuV/m)	LIMIT (dBuV/m)	MARGIN (dB)	ANTENNA HEIGHT (m)	TABLE ANGLE (Degree)	RAW VALUE (dBuV)	CORRECTION FACTOR (dB/m)
1	2390.00	65.34 PK	74.00	-8.66	1.13 V	139	32.26	33.08
2	2390.00	49.35 AV	54.00	-4.65	1.13 V	139	16.27	33.08
3	*2412.00	105.58 PK			1.11 V	95	72.40	33.18
4	*2412.00	93.85 AV			1.11 V	95	60.67	33.18
5	4824.00	49.38 PK	74.00	-24.62	1.11 V	54	10.23	39.15
6	4824.00	37.56 AV	54.00	-16.44	1.11 V	54	-1.59	39.15
7	#7236.00	55.33 PK	85.58	-30.25	1.41 V	294	10.03	45.30
8	#7236.00	40.49 AV	73.85	-33.36	1.41 V	294	-4.81	45.30

- REMARKS:**
1. Emission level (dBuV/m) = Raw Value (dBuV) + Correction Factor (dB/m).
  2. Correction Factor (dB/m) = Antenna Factor (dB/m) + Cable Factor (dB).
  3. The other emission levels were very low against the limit.
  4. Margin value = Emission level – Limit value.
  5. “ \* “: Fundamental frequency.
  6. “#”:The radiated frequency is out the restricted band.



A D T

EUT TEST CONDITION		MEASUREMENT DETAIL	
CHANNEL	Channel 6	FREQUENCY RANGE	1 ~ 25GHz
INPUT POWER	120Vac, 60 Hz	DETECTOR FUNCTION	Peak (PK) Average (AV)
ENVIRONMENTAL CONDITIONS	23.0deg. C, 70.0%RH 1000hPa	TESTED BY	Mark Liao

ANTENNA POLARITY & TEST DISTANCE: HORIZONTAL AT 3 M								
NO.	FREQ. (MHz)	EMISSION LEVEL (dBuV/m)	LIMIT (dBuV/m)	MARGIN (dB)	ANTENNA HEIGHT (m)	TABLE ANGLE (Degree)	RAW VALUE (dBuV)	CORRECTION FACTOR (dB/m)
1	*2437.00	101.54 PK			1.04 H	171	68.26	33.28
2	*2437.00	89.70 AV			1.04 H	171	56.42	33.28
3	4874.00	48.61 PK	74.00	-25.39	1.09 H	195	9.46	39.14
4	4874.00	35.94 AV	54.00	-18.06	1.09 H	195	-3.21	39.14
5	7311.00	52.51 PK	74.00	-21.49	1.22 H	109	6.98	45.53
6	7311.00	39.34 AV	54.00	-14.66	1.22 H	109	-6.19	45.53
ANTENNA POLARITY & TEST DISTANCE: VERTICAL AT 3 M								
NO.	FREQ. (MHz)	EMISSION LEVEL (dBuV/m)	LIMIT (dBuV/m)	MARGIN (dB)	ANTENNA HEIGHT (m)	TABLE ANGLE (Degree)	RAW VALUE (dBuV)	CORRECTION FACTOR (dB/m)
1	*2437.00	106.54 PK			1.14 V	186	73.26	33.28
2	*2437.00	94.88 AV			1.14 V	186	61.60	33.28
3	4874.00	49.45 PK	74.00	-24.55	1.02 V	101	10.30	39.14
4	4874.00	37.69 AV	54.00	-16.31	1.02 V	101	-1.46	39.14
5	7311.00	53.29 PK	74.00	-20.71	1.19 V	49	7.76	45.53
6	7311.00	39.80 AV	54.00	-14.20	1.19 V	49	-5.73	45.53

- REMARKS:**
1. Emission level (dBuV/m) = Raw Value (dBuV) + Correction Factor (dB/m).
  2. Correction Factor (dB/m) = Antenna Factor (dB/m) + Cable Factor (dB).
  3. The other emission levels were very low against the limit.
  4. Margin value = Emission level – Limit value.
  5. “ \* “: Fundamental frequency.

EUT TEST CONDITION		MEASUREMENT DETAIL	
CHANNEL	Channel 11	FREQUENCY RANGE	1 ~ 25GHz
INPUT POWER	120Vac, 60 Hz	DETECTOR FUNCTION	Peak (PK) Average (AV)
ENVIRONMENTAL CONDITIONS	23.0deg. C, 70.0%RH 1000hPa	TESTED BY	Mark Liao

ANTENNA POLARITY & TEST DISTANCE: HORIZONTAL AT 3 M								
NO.	FREQ. (MHz)	EMISSION LEVEL (dBuV/m)	LIMIT (dBuV/m)	MARGIN (dB)	ANTENNA HEIGHT (m)	TABLE ANGLE (Degree)	RAW VALUE (dBuV)	CORRECTION FACTOR (dB/m)
1	*2462.00	101.15 PK			1.05 H	229	67.77	33.38
2	*2462.00	89.48 AV			1.05 H	229	56.10	33.38
3	2483.50	59.58 PK	74.00	-14.42	1.05 H	229	26.12	33.46
4	2483.50	47.24 AV	54.00	-6.76	1.05 H	229	13.78	33.46
5	4924.00	48.99 PK	74.00	-25.01	1.16 H	86	9.63	39.35
6	4924.00	35.74 AV	54.00	-18.26	1.16 H	86	-3.62	39.35
7	7386.00	54.43 PK	74.00	-19.57	1.22 H	7	8.68	45.76
8	7386.00	41.10 AV	54.00	-12.90	1.22 H	7	-4.65	45.76
ANTENNA POLARITY & TEST DISTANCE: VERTICAL AT 3 M								
NO.	FREQ. (MHz)	EMISSION LEVEL (dBuV/m)	LIMIT (dBuV/m)	MARGIN (dB)	ANTENNA HEIGHT (m)	TABLE ANGLE (Degree)	RAW VALUE (dBuV)	CORRECTION FACTOR (dB/m)
1	*2462.00	106.22 PK			1.13 V	189	72.84	33.38
2	*2462.00	94.48 AV			1.13 V	189	61.10	33.38
3	2483.50	60.90 PK	74.00	-13.10	1.12 V	197	27.44	33.46
4	2483.50	48.56 AV	54.00	-5.44	1.12 V	197	15.10	33.46
5	4924.00	48.93 PK	74.00	-25.07	1.08 V	47	9.57	39.35
6	4924.00	37.12 AV	54.00	-16.88	1.08 V	47	-2.24	39.35
7	7386.00	53.46 PK	74.00	-20.54	1.25 V	310	7.71	45.76
8	7386.00	40.57 AV	54.00	-13.43	1.25 V	310	-5.18	45.76

- REMARKS:**
1. Emission level (dBuV/m) = Raw Value (dBuV) + Correction Factor (dB/m).
  2. Correction Factor (dB/m) = Antenna Factor (dB/m) + Cable Factor (dB).
  3. The other emission levels were very low against the limit.
  4. Margin value = Emission level – Limit value.
  5. “ \* “: Fundamental frequency.

**DRAFT 802.11n (40MHz) OFDM MODULATION: 1TX**

EUT TEST CONDITION		MEASUREMENT DETAIL	
CHANNEL	Channel 1	FREQUENCY RANGE	1 ~ 25GHz
INPUT POWER	120Vac, 60 Hz	DETECTOR FUNCTION	Peak (PK) Average (AV)
ENVIRONMENTAL CONDITIONS	23.0deg. C, 70.0%RH 1000hPa	TESTED BY	Mark Liao

ANTENNA POLARITY & TEST DISTANCE: HORIZONTAL AT 3 M								
NO.	FREQ. (MHz)	EMISSION LEVEL (dBuV/m)	LIMIT (dBuV/m)	MARGIN (dB)	ANTENNA HEIGHT (m)	TABLE ANGLE (Degree)	RAW VALUE (dBuV)	CORRECTION FACTOR (dB/m)
1	2390.00	61.85 PK	74.00	-12.15	1.04 H	172	28.77	33.08
2	2390.00	48.66 AV	54.00	-5.34	1.04 H	172	15.58	33.08
3	*2422.00	101.68 PK			1.04 H	172	68.46	33.22
4	*2422.00	91.45 AV			1.04 H	172	58.23	33.22
5	4844.00	48.82 PK	74.00	-25.18	1.12 H	277	9.68	39.15
6	4844.00	35.81 AV	54.00	-18.19	1.12 H	277	-3.33	39.15
7	7266.00	52.47 PK	74.00	-21.53	1.30 H	28	7.07	45.39
8	7266.00	39.06 AV	54.00	-14.94	1.30 H	28	-6.34	45.39
ANTENNA POLARITY & TEST DISTANCE: VERTICAL AT 3 M								
NO.	FREQ. (MHz)	EMISSION LEVEL (dBuV/m)	LIMIT (dBuV/m)	MARGIN (dB)	ANTENNA HEIGHT (m)	TABLE ANGLE (Degree)	RAW VALUE (dBuV)	CORRECTION FACTOR (dB/m)
1	2390.00	67.79 PK	74.00	-6.21	1.12 V	261	34.71	33.08
2	2390.00	51.27 AV	54.00	-2.73	1.12 V	261	18.19	33.08
3	*2422.00	107.59 PK			1.12 V	261	74.37	33.22
4	*2422.00	97.13 AV			1.12 V	261	63.91	33.22
5	4844.00	49.50 PK	74.00	-24.50	1.23 V	53	10.36	39.15
6	4844.00	36.96 AV	54.00	-17.04	1.23 V	53	-2.18	39.15
7	7266.00	56.86 PK	74.00	-17.14	1.42 V	315	11.46	45.39
8	7266.00	41.94 AV	54.00	-12.06	1.42 V	315	-3.46	45.39

- REMARKS:**
1. Emission level (dBuV/m) = Raw Value (dBuV) + Correction Factor (dB/m).
  2. Correction Factor (dB/m) = Antenna Factor (dB/m) + Cable Factor (dB).
  3. The other emission levels were very low against the limit.
  4. Margin value = Emission level – Limit value.
  5. “ \* “: Fundamental frequency.



A D T

EUT TEST CONDITION		MEASUREMENT DETAIL	
CHANNEL	Channel 4	FREQUENCY RANGE	1 ~ 25GHz
INPUT POWER	120Vac, 60 Hz	DETECTOR FUNCTION	Peak (PK) Average (AV)
ENVIRONMENTAL CONDITIONS	23.0deg. C, 70.0%RH 1000hPa	TESTED BY	Mark Liao

ANTENNA POLARITY & TEST DISTANCE: HORIZONTAL AT 3 M								
NO.	FREQ. (MHz)	EMISSION LEVEL (dBuV/m)	LIMIT (dBuV/m)	MARGIN (dB)	ANTENNA HEIGHT (m)	TABLE ANGLE (Degree)	RAW VALUE (dBuV)	CORRECTION FACTOR (dB/m)
1	*2437.00	101.58 PK			1.08 H	180	68.30	33.28
2	*2437.00	91.38 AV			1.08 H	180	58.10	33.28
3	4874.00	48.72 PK	74.00	-25.28	1.10 H	40	9.57	39.14
4	4874.00	35.84 AV	54.00	-18.16	1.10 H	40	-3.31	39.14
5	7311.00	52.63 PK	74.00	-21.37	1.10 H	232	7.10	45.53
6	7311.00	39.34 AV	54.00	-14.66	1.10 H	232	-6.19	45.53
ANTENNA POLARITY & TEST DISTANCE: VERTICAL AT 3 M								
NO.	FREQ. (MHz)	EMISSION LEVEL (dBuV/m)	LIMIT (dBuV/m)	MARGIN (dB)	ANTENNA HEIGHT (m)	TABLE ANGLE (Degree)	RAW VALUE (dBuV)	CORRECTION FACTOR (dB/m)
1	*2437.00	107.51 PK			1.15 V	275	74.23	33.28
2	*2437.00	97.06 AV			1.15 V	275	63.78	33.28
3	4874.00	49.74 PK	74.00	-24.26	1.05 V	102	10.59	39.14
4	4874.00	38.20 AV	54.00	-15.80	1.05 V	102	-0.95	39.14
5	7311.00	53.79 PK	74.00	-20.21	1.58 V	13	8.26	45.53
6	7311.00	40.11 AV	54.00	-13.89	1.58 V	13	-5.42	45.53

- REMARKS:**
1. Emission level (dBuV/m) = Raw Value (dBuV) + Correction Factor (dB/m).
  2. Correction Factor (dB/m) = Antenna Factor (dB/m) + Cable Factor (dB).
  3. The other emission levels were very low against the limit.
  4. Margin value = Emission level – Limit value.
  5. “ \* “: Fundamental frequency.

EUT TEST CONDITION		MEASUREMENT DETAIL	
CHANNEL	Channel 7	FREQUENCY RANGE	1 ~ 25GHz
INPUT POWER	120Vac, 60 Hz	DETECTOR FUNCTION	Peak (PK) Average (AV)
ENVIRONMENTAL CONDITIONS	23.0deg. C, 70.0%RH 1000hPa	TESTED BY	Mark Liao

ANTENNA POLARITY & TEST DISTANCE: HORIZONTAL AT 3 M								
NO.	FREQ. (MHz)	EMISSION LEVEL (dBuV/m)	LIMIT (dBuV/m)	MARGIN (dB)	ANTENNA HEIGHT (m)	TABLE ANGLE (Degree)	RAW VALUE (dBuV)	CORRECTION FACTOR (dB/m)
1	*2452.00	100.55 PK			1.05 H	171	67.21	33.34
2	*2452.00	90.39 AV			1.05 H	171	57.05	33.34
3	2483.50	60.60 PK	74.00	-13.40	1.05 H	171	27.14	33.46
4	2483.50	48.86 AV	54.00	-5.14	1.05 H	171	15.40	33.46
5	4904.00	49.10 PK	74.00	-24.90	1.16 H	319	9.92	39.18
6	4904.00	35.68 AV	54.00	-18.32	1.16 H	319	-3.50	39.18
7	7356.00	53.55 PK	74.00	-20.45	1.15 H	100	7.88	45.67
8	7356.00	39.87 AV	54.00	-14.13	1.15 H	100	-5.80	45.67
ANTENNA POLARITY & TEST DISTANCE: VERTICAL AT 3 M								
NO.	FREQ. (MHz)	EMISSION LEVEL (dBuV/m)	LIMIT (dBuV/m)	MARGIN (dB)	ANTENNA HEIGHT (m)	TABLE ANGLE (Degree)	RAW VALUE (dBuV)	CORRECTION FACTOR (dB/m)
1	*2452.00	106.48 PK			1.09 V	259	73.14	33.34
2	*2452.00	96.03 AV			1.09 V	259	62.69	33.34
3	2483.50	65.88 PK	74.00	-8.12	1.08 V	283	32.42	33.46
4	2483.50	52.43 AV	54.00	-1.57	1.08 V	283	18.97	33.46
5	4904.00	49.05 PK	74.00	-24.95	1.21 V	103	9.87	39.18
6	4904.00	37.72 AV	54.00	-16.28	1.21 V	103	-1.46	39.18
7	7356.00	53.95 PK	74.00	-20.05	1.24 V	85	8.28	45.67
8	7356.00	39.43 AV	54.00	-14.57	1.24 V	85	-6.24	45.67

- REMARKS:**
1. Emission level (dBuV/m) = Raw Value (dBuV) + Correction Factor (dB/m).
  2. Correction Factor (dB/m) = Antenna Factor (dB/m) + Cable Factor (dB).
  3. The other emission levels were very low against the limit.
  4. Margin value = Emission level – Limit value.
  5. “ \* “: Fundamental frequency.

**DRAFT 802.11n (40MHz) OFDM MODULATION: 2TX**

EUT TEST CONDITION		MEASUREMENT DETAIL	
CHANNEL	Channel 1	FREQUENCY RANGE	1 ~ 25GHz
INPUT POWER	120Vac, 60 Hz	DETECTOR FUNCTION	Peak (PK) Average (AV)
ENVIRONMENTAL CONDITIONS	23.0deg. C, 70.0%RH 1000hPa	TESTED BY	Mark Liao

ANTENNA POLARITY & TEST DISTANCE: HORIZONTAL AT 3 M								
NO.	FREQ. (MHz)	EMISSION LEVEL (dBuV/m)	LIMIT (dBuV/m)	MARGIN (dB)	ANTENNA HEIGHT (m)	TABLE ANGLE (Degree)	RAW VALUE (dBuV)	CORRECTION FACTOR (dB/m)
1	2390.00	58.36 PK	74.00	-15.64	1.04 H	172	25.28	33.08
2	2390.00	47.00 AV	54.00	-7.00	1.04 H	172	13.92	33.08
3	*2422.00	96.83 PK			1.04 H	172	63.61	33.22
4	*2422.00	85.91 AV			1.04 H	172	52.69	33.22
5	4844.00	48.77 PK	74.00	-25.23	1.15 H	153	9.63	39.15
6	4844.00	36.00 AV	54.00	-18.00	1.15 H	153	-3.14	39.15
7	7266.00	51.52 PK	74.00	-22.48	1.13 H	93	6.12	45.39
8	7266.00	39.70 AV	54.00	-14.30	1.13 H	93	-5.70	45.39

ANTENNA POLARITY & TEST DISTANCE: VERTICAL AT 3 M								
NO.	FREQ. (MHz)	EMISSION LEVEL (dBuV/m)	LIMIT (dBuV/m)	MARGIN (dB)	ANTENNA HEIGHT (m)	TABLE ANGLE (Degree)	RAW VALUE (dBuV)	CORRECTION FACTOR (dB/m)
1	2390.00	59.92 PK	74.00	-14.08	1.15 V	188	26.84	33.08
2	2390.00	48.36 AV	54.00	-5.64	1.15 V	188	15.28	33.08
3	*2422.00	102.56 PK			1.15 V	188	69.34	33.22
4	*2422.00	90.87 AV			1.15 V	188	57.65	33.22
5	4844.00	48.94 PK	74.00	-25.06	1.15 V	103	9.80	39.15
6	4844.00	36.66 AV	54.00	-17.34	1.15 V	103	-2.48	39.15
7	7266.00	52.06 PK	74.00	-21.94	1.09 V	247	6.66	45.39
8	7266.00	39.28 AV	54.00	-14.72	1.09 V	247	-6.12	45.39

- REMARKS:**
1. Emission level (dBuV/m) = Raw Value (dBuV) + Correction Factor (dB/m).
  2. Correction Factor (dB/m) = Antenna Factor (dB/m) + Cable Factor (dB).
  3. The other emission levels were very low against the limit.
  4. Margin value = Emission level – Limit value.
  5. “ \* “: Fundamental frequency.

EUT TEST CONDITION		MEASUREMENT DETAIL	
CHANNEL	Channel 4	FREQUENCY RANGE	1 ~ 25GHz
INPUT POWER	120Vac, 60 Hz	DETECTOR FUNCTION	Peak (PK) Average (AV)
ENVIRONMENTAL CONDITIONS	23.0deg. C, 70.0%RH 1000hPa	TESTED BY	Mark Liao

ANTENNA POLARITY & TEST DISTANCE: HORIZONTAL AT 3 M								
NO.	FREQ. (MHz)	EMISSION LEVEL (dBuV/m)	LIMIT (dBuV/m)	MARGIN (dB)	ANTENNA HEIGHT (m)	TABLE ANGLE (Degree)	RAW VALUE (dBuV)	CORRECTION FACTOR (dB/m)
1	*2437.00	96.58 PK			1.06 H	188	63.30	33.28
2	*2437.00	85.81 AV			1.06 H	188	52.53	33.28
3	4874.00	49.45 PK	74.00	-24.55	1.09 H	311	10.31	39.14
4	4874.00	36.06 AV	54.00	-17.94	1.09 H	311	-3.08	39.14
5	7311.00	52.56 PK	74.00	-21.44	1.25 H	144	7.03	45.53
6	7311.00	39.74 AV	54.00	-14.26	1.25 H	144	-5.79	45.53
ANTENNA POLARITY & TEST DISTANCE: VERTICAL AT 3 M								
NO.	FREQ. (MHz)	EMISSION LEVEL (dBuV/m)	LIMIT (dBuV/m)	MARGIN (dB)	ANTENNA HEIGHT (m)	TABLE ANGLE (Degree)	RAW VALUE (dBuV)	CORRECTION FACTOR (dB/m)
1	*2437.00	102.46 PK			1.19 V	193	69.18	33.28
2	*2437.00	90.78 AV			1.19 V	193	57.50	33.28
3	4874.00	48.87 PK	74.00	-25.13	1.19 V	69	9.73	39.14
4	4874.00	36.66 AV	54.00	-17.34	1.19 V	69	-2.48	39.14
5	7311.00	52.64 PK	74.00	-21.36	1.20 V	152	7.11	45.53
6	7311.00	39.72 AV	54.00	-14.28	1.20 V	152	-5.81	45.53

- REMARKS:**
1. Emission level (dBuV/m) = Raw Value (dBuV) + Correction Factor (dB/m).
  2. Correction Factor (dB/m) = Antenna Factor (dB/m) + Cable Factor (dB).
  3. The other emission levels were very low against the limit.
  4. Margin value = Emission level – Limit value.
  5. “ \* “: Fundamental frequency.



EUT TEST CONDITION		MEASUREMENT DETAIL	
CHANNEL	Channel 7	FREQUENCY RANGE	1 ~ 25GHz
INPUT POWER	120Vac, 60 Hz	DETECTOR FUNCTION	Peak (PK) Average (AV)
ENVIRONMENTAL CONDITIONS	23.0deg. C, 70.0%RH 1000hPa	TESTED BY	Mark Liao

ANTENNA POLARITY & TEST DISTANCE: HORIZONTAL AT 3 M								
NO.	FREQ. (MHz)	EMISSION LEVEL (dBuV/m)	LIMIT (dBuV/m)	MARGIN (dB)	ANTENNA HEIGHT (m)	TABLE ANGLE (Degree)	RAW VALUE (dBuV)	CORRECTION FACTOR (dB/m)
1	*2452.00	96.37 PK			1.04 H	170	63.03	33.34
2	*2452.00	85.43 AV			1.04 H	170	52.09	33.34
3	2483.50	59.83 PK	74.00	-14.17	1.04 H	170	26.37	33.46
4	2483.50	47.81 AV	54.00	-6.19	1.04 H	170	14.35	33.46
5	4904.00	49.38 PK	74.00	-24.62	1.04 H	327	10.20	39.18
6	4904.00	35.95 AV	54.00	-18.05	1.04 H	327	-3.23	39.18
7	7356.00	52.52 PK	74.00	-21.48	1.09 H	140	6.85	45.67
8	7356.00	39.67 AV	54.00	-14.33	1.09 H	140	-6.00	45.67
ANTENNA POLARITY & TEST DISTANCE: VERTICAL AT 3 M								
NO.	FREQ. (MHz)	EMISSION LEVEL (dBuV/m)	LIMIT (dBuV/m)	MARGIN (dB)	ANTENNA HEIGHT (m)	TABLE ANGLE (Degree)	RAW VALUE (dBuV)	CORRECTION FACTOR (dB/m)
1	*2452.00	102.09 PK			1.08 V	263	68.75	33.34
2	*2452.00	90.38 AV			1.08 V	263	57.04	33.34
3	2483.50	61.64 PK	74.00	-12.36	1.08 V	263	28.18	33.46
4	2483.50	49.49 AV	54.00	-4.51	1.08 V	263	16.03	33.46
5	4904.00	48.73 PK	74.00	-25.27	1.24 V	44	9.55	39.18
6	4904.00	36.59 AV	54.00	-17.41	1.24 V	44	-2.59	39.18
7	7356.00	52.58 PK	74.00	-21.42	1.15 V	162	6.91	45.67
8	7356.00	39.68 AV	54.00	-14.32	1.15 V	162	-5.99	45.67

- REMARKS:**
1. Emission level (dBuV/m) = Raw Value (dBuV) + Correction Factor (dB/m).
  2. Correction Factor (dB/m) = Antenna Factor (dB/m) + Cable Factor (dB).
  3. The other emission levels were very low against the limit.
  4. Margin value = Emission level – Limit value.
  5. “ \* “: Fundamental frequency.

**BELOW 1GHz WORST-CASE DATA : 802.11g OFDM MODULATION**

EUT TEST CONDITION		MEASUREMENT DETAIL	
CHANNEL	Channel 6	FREQUENCY RANGE	Below 1000MHz
INPUT POWER	120Vac, 60 Hz	DETECTOR FUNCTION	Quasi-Peak
ENVIRONMENTAL CONDITIONS	24.0deg. C, 64.0%RH 999hPa	TESTED BY	Match Tsui
TEST MODE	A		

ANTENNA POLARITY & TEST DISTANCE: HORIZONTAL AT 3 M								
NO.	FREQ. (MHz)	EMISSION LEVEL (dBuV/m)	LIMIT (dBuV/m)	MARGIN (dB)	ANTENNA HEIGHT (m)	TABLE ANGLE (Degree)	RAW VALUE (dBuV)	CORRECTION FACTOR (dB/m)
1	183.50	31.32 QP	43.50	-12.18	2.00 H	106	19.40	11.92
2	222.38	33.08 QP	46.00	-12.92	1.50 H	262	21.49	11.59
3	296.27	33.69 QP	46.00	-12.31	1.00 H	244	20.09	13.61
4	445.98	33.46 QP	46.00	-12.54	2.00 H	79	15.88	17.59
5	595.69	37.92 QP	46.00	-8.08	1.25 H	238	16.11	21.81
6	745.40	42.68 QP	46.00	-3.32	1.00 H	220	18.85	23.83
7	893.16	35.24 QP	46.00	-10.76	1.50 H	217	9.20	26.04
8	914.55	33.89 QP	46.00	-12.11	1.25 H	157	7.67	26.22
ANTENNA POLARITY & TEST DISTANCE: VERTICAL AT 3 M								
NO.	FREQ. (MHz)	EMISSION LEVEL (dBuV/m)	LIMIT (dBuV/m)	MARGIN (dB)	ANTENNA HEIGHT (m)	TABLE ANGLE (Degree)	RAW VALUE (dBuV)	CORRECTION FACTOR (dB/m)
1	43.51	37.85 QP	40.00	-2.15	1.25 V	7	25.38	12.47
2	62.95	33.24 QP	40.00	-6.76	1.00 V	205	20.39	12.85
3	97.95	33.67 QP	43.50	-9.83	1.00 V	190	24.36	9.31
4	169.89	34.58 QP	43.50	-8.92	1.50 V	190	21.63	12.96
5	276.82	34.96 QP	46.00	-11.04	2.00 V	199	21.69	13.27
6	422.65	34.26 QP	46.00	-11.74	1.00 V	175	17.44	16.81
7	445.98	36.56 QP	46.00	-9.44	1.00 V	169	18.98	17.59
8	595.69	34.96 QP	46.00	-11.04	1.50 V	190	13.15	21.81
9	745.40	38.14 QP	46.00	-7.86	1.25 V	163	14.31	23.83
10	788.17	34.50 QP	46.00	-11.50	2.00 V	160	9.51	24.99

- REMARKS:**
1. Emission level (dBuV/m) = Raw Value (dBuV) + Correction Factor (dB/m).
  2. Correction Factor (dB/m) = Antenna Factor (dB/m) + Cable Factor (dB).
  3. The other emission levels were very low against the limit.
  4. Margin value = Emission level – Limit value.



A D T

EUT TEST CONDITION		MEASUREMENT DETAIL	
CHANNEL	Channel 6	FREQUENCY RANGE	Below 1000MHz
INPUT POWER	120Vac, 60 Hz	DETECTOR FUNCTION	Quasi-Peak
ENVIRONMENTAL CONDITIONS	24.0deg. C, 64.0%RH 999hPa	TESTED BY	Match Tsui
TEST MODE	B		

ANTENNA POLARITY & TEST DISTANCE: HORIZONTAL AT 3 M								
NO.	FREQ. (MHz)	EMISSION LEVEL (dBuV/m)	LIMIT (dBuV/m)	MARGIN (dB)	ANTENNA HEIGHT (m)	TABLE ANGLE (Degree)	RAW VALUE (dBuV)	CORRECTION FACTOR (dB/m)
1	179.61	30.54 QP	43.50	-12.96	2.00 H	109	18.31	12.23
2	296.27	33.83 QP	46.00	-12.17	1.00 H	223	20.22	13.61
3	500.42	33.04 QP	46.00	-12.96	1.50 H	226	13.79	19.25
4	595.69	38.32 QP	46.00	-7.68	1.50 H	226	16.50	21.81
5	659.85	34.47 QP	46.00	-11.53	1.00 H	244	12.07	22.40
6	745.40	42.87 QP	46.00	-3.13	1.00 H	211	19.04	23.83
7	766.79	34.92 QP	46.00	-11.08	1.00 H	352	10.51	24.41
8	893.16	36.69 QP	46.00	-9.31	1.50 H	220	10.64	26.04
9	935.94	35.77 QP	46.00	-10.23	1.50 H	328	9.39	26.38
10	957.33	36.31 QP	46.00	-9.69	1.50 H	268	9.79	26.52
ANTENNA POLARITY & TEST DISTANCE: VERTICAL AT 3 M								
NO.	FREQ. (MHz)	EMISSION LEVEL (dBuV/m)	LIMIT (dBuV/m)	MARGIN (dB)	ANTENNA HEIGHT (m)	TABLE ANGLE (Degree)	RAW VALUE (dBuV)	CORRECTION FACTOR (dB/m)
1	43.51	37.89 QP	40.00	-2.11	1.00 V	10	25.42	12.47
2	64.90	32.99 QP	40.00	-7.01	1.00 V	310	20.50	12.49
3	97.95	34.93 QP	43.50	-8.57	1.25 V	175	25.62	9.31
4	144.61	30.84 QP	43.50	-12.66	1.25 V	196	17.67	13.16
5	191.28	30.54 QP	43.50	-12.96	1.25 V	52	19.25	11.29
6	445.98	33.38 QP	46.00	-12.62	1.25 V	304	15.79	17.59
7	595.69	33.47 QP	46.00	-12.53	1.50 V	181	11.66	21.81
8	745.40	39.14 QP	46.00	-6.86	1.25 V	199	15.31	23.83
9	893.16	37.19 QP	46.00	-8.81	1.00 V	187	11.15	26.04

- REMARKS:**
1. Emission level (dBuV/m) = Raw Value (dBuV) + Correction Factor (dB/m).
  2. Correction Factor (dB/m) = Antenna Factor (dB/m) + Cable Factor (dB).
  3. The other emission levels were very low against the limit.
  4. Margin value = Emission level – Limit value.

EUT TEST CONDITION		MEASUREMENT DETAIL	
CHANNEL	Channel 6	FREQUENCY RANGE	Below 1000MHz
INPUT POWER	120Vac, 60 Hz	DETECTOR FUNCTION	Quasi-Peak
ENVIRONMENTAL CONDITIONS	24.0deg. C, 64.0%RH 999hPa	TESTED BY	Match Tsui
TEST MODE	C		

ANTENNA POLARITY & TEST DISTANCE: HORIZONTAL AT 3 M								
NO.	FREQ. (MHz)	EMISSION LEVEL (dBuV/m)	LIMIT (dBuV/m)	MARGIN (dB)	ANTENNA HEIGHT (m)	TABLE ANGLE (Degree)	RAW VALUE (dBuV)	CORRECTION FACTOR (dB/m)
1	191.28	41.59 QP	43.50	-1.91	2.00 H	244	30.30	11.29
2	595.69	39.37 QP	46.00	-6.63	1.25 H	235	17.56	21.81
3	659.85	36.62 QP	46.00	-9.38	1.25 H	208	14.22	22.40
4	745.40	40.66 QP	46.00	-5.34	1.00 H	214	16.83	23.83
5	893.16	37.73 QP	46.00	-8.27	1.50 H	214	11.68	26.04
6	935.94	35.95 QP	46.00	-10.05	1.50 H	97	9.57	26.38
ANTENNA POLARITY & TEST DISTANCE: VERTICAL AT 3 M								
NO.	FREQ. (MHz)	EMISSION LEVEL (dBuV/m)	LIMIT (dBuV/m)	MARGIN (dB)	ANTENNA HEIGHT (m)	TABLE ANGLE (Degree)	RAW VALUE (dBuV)	CORRECTION FACTOR (dB/m)
1	43.51	37.94 QP	40.00	-2.06	1.00 V	304	25.47	12.47
2	64.90	33.37 QP	40.00	-6.63	1.00 V	328	20.88	12.49
3	659.85	37.21 QP	46.00	-8.79	1.50 V	160	14.81	22.40
4	745.40	39.45 QP	46.00	-6.55	1.25 V	196	15.62	23.83
5	893.16	36.40 QP	46.00	-9.60	1.00 V	196	10.35	26.04
6	935.94	37.79 QP	46.00	-8.21	1.50 V	172	11.41	26.38

- REMARKS:**
1. Emission level (dBuV/m) = Raw Value (dBuV) + Correction Factor (dB/m).
  2. Correction Factor (dB/m) = Antenna Factor (dB/m) + Cable Factor (dB).
  3. The other emission levels were very low against the limit.
  4. Margin value = Emission level – Limit value.

## 4.2 CONDUCTED EMISSION MEASUREMENT

### 4.2.1 LIMITS OF CONDUCTED EMISSION MEASUREMENT

FREQUENCY OF EMISSION (MHz)	CONDUCTED LIMIT (dB $\mu$ V)	
	Quasi-peak	Average
0.15-0.5	66 to 56	56 to 46
0.5-5	56	46
5-30	60	50

- NOTE:**
1. The lower limit shall apply at the transition frequencies.
  2. The limit decreases in line with the logarithm of the frequency in the range of 0.15 to 0.50 MHz.
  3. All emanations from a class A/B digital device or system, including any network of conductors and apparatus connected thereto, shall not exceed the level of field strengths specified above.

### 4.2.2 TEST INSTRUMENTS

DESCRIPTION & MANUFACTURER	MODEL NO.	SERIAL NO.	DATE OF CALIBRATION	DUE DATE OF CALIBRATION
Test Receiver ROHDE & SCHWARZ	ESCS30	100291	Nov. 19, 2008	Nov. 18, 2009
RF signal cable Woken	5D-FB	Cable-HYC01-01	Dec. 31, 2008	Dec. 30, 2009
LISN ROHDE & SCHWARZ	ESH3-Z5	100312	Jun. 13, 2008	Jun. 12, 2009
LISN ROHDE & SCHWARZ	ESH2-Z5	100104	Dec. 04, 2008	Dec. 03, 2009
Software ADT	ADT_Cond_ V7.3.7	NA	NA	NA

- NOTE:**
1. The calibration interval of the above test instruments is 12 months and the calibrations are traceable to NML/ROC and NIST/USA.
  2. The test was performed in HwaYa Shielded Room 1.
  3. The VCCI Site Registration No. is C-2040.

#### 4.2.3 TEST PROCEDURES

- a. The EUT was placed 0.4 meters from the conducting wall of the shielded room with EUT being connected to the power mains through a line impedance stabilization network (LISN). Other support units were connected to the power mains through another LISN. The two LISNs provide 50 ohm/ 50uH of coupling impedance for the measuring instrument.
- b. Both lines of the power mains connected to the EUT were checked for maximum conducted interference.
- c. The frequency range from 150kHz to 30MHz was searched. Emission levels under (Limit - 20dB) was not recorded.

#### 4.2.4 DEVIATION FROM TEST STANDARD

No deviation

#### 4.2.5 TEST SETUP

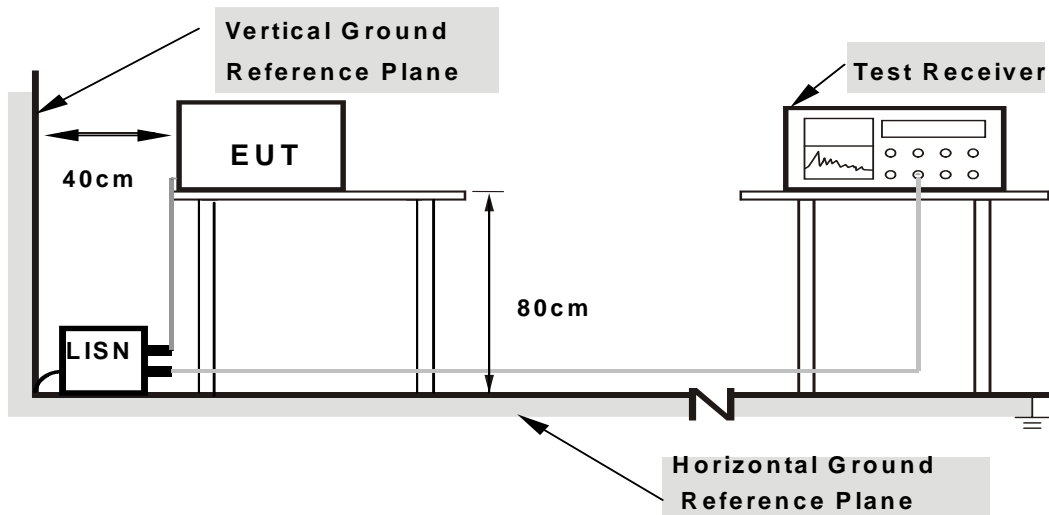

- Note:**
1. Support units were connected to second LISN.
  2. Both of LISNs (AMN) are 80 cm from EUT and at least 80 cm from other units and other metal planes

For the actual test configuration, please refer to the attached file (Test Setup Photo).

#### 4.2.6 EUT OPERATING CONDITIONS

Same as 4.1.6



A D T

### 4.2.7 TEST RESULTS

#### CONDUCTED WORST-CASE DATA: 802.11g OFDM MODULATION: 1TX

EUT TEST CONDITION		MEASUREMENT DETAIL	
CHANNEL	Channel 6	PHASE	Line 1
MODULATION TYPE	BPSK	6dB BANDWIDTH	9 kHz
TRANSFER RATE	6.0Mbps	INPUT POWER	120Vac, 60 Hz
ENVIRONMENTAL CONDITIONS	25deg. C, 65%RH, 991hPa	TEST MODE	A
TESTED BY	Mark Liao		

No	Freq. [MHz]	Corr. Factor (dB)	Reading Value [dB (uV)]		Emission Level [dB (uV)]		Limit [dB (uV)]		Margin (dB)	
			Q.P.	AV.	Q.P.	AV.	Q.P.	AV.	Q.P.	AV.
1	0.205	0.13	46.53	-	46.66	-	63.42	53.42	-16.76	-
2	0.275	0.13	38.93	-	39.06	-	60.97	50.97	-21.90	-
3	0.412	0.14	34.64	-	34.78	-	57.61	47.61	-22.83	-
4	1.930	0.23	30.27	-	30.50	-	56.00	46.00	-25.50	-
5	2.480	0.26	27.26	-	27.52	-	56.00	46.00	-28.48	-
6	10.609	0.69	27.36	-	28.05	-	60.00	50.00	-31.95	-

- REMARKS:**
1. Q.P. and AV. are abbreviations of quasi-peak and average individually.
  2. "-": The Quasi-peak reading value also meets average limit and measurement with the average detector is unnecessary.
  3. The emission levels of other frequencies were very low against the limit.
  4. Margin value = Emission level - Limit value
  5. Correction factor = Insertion loss + Cable loss
  6. Emission Level = Correction Factor + Reading Value.

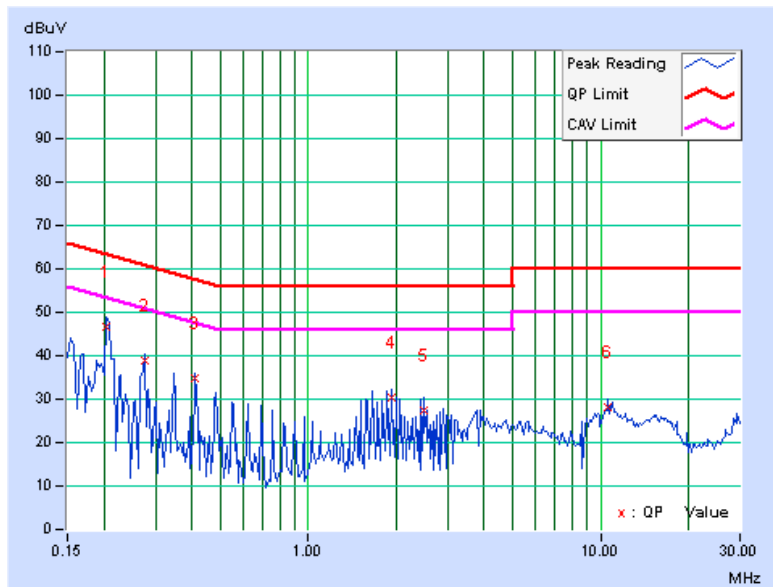





A D T

EUT TEST CONDITION		MEASUREMENT DETAIL	
CHANNEL	Channel 6	PHASE	Line 2
MODULATION TYPE	BPSK	6dB BANDWIDTH	9 kHz
TRANSFER RATE	6.0Mbps	INPUT POWER	120Vac, 60 Hz
ENVIRONMENTAL CONDITIONS	25deg. C, 65%RH, 991hPa	TEST MODE	A
TESTED BY	Mark Liao		

No	Freq. [MHz]	Corr. Factor (dB)	Reading Value		Emission Level		Limit		Margin	
			[dB (uV)]		[dB (uV)]		[dB (uV)]		(dB)	
			Q.P.	AV.	Q.P.	AV.	Q.P.	AV.	Q.P.	AV.
1	0.209	0.15	47.27	-	47.42	-	63.26	53.26	-15.84	-
2	0.275	0.15	38.42	-	38.57	-	60.97	50.97	-22.39	-
3	0.416	0.16	32.92	-	33.08	-	57.54	47.54	-24.45	-
4	0.966	0.20	25.97	-	26.17	-	56.00	46.00	-29.83	-
5	2.137	0.26	27.61	-	27.87	-	56.00	46.00	-28.13	-
6	9.942	0.66	17.74	-	18.40	-	60.00	50.00	-41.60	-

- REMARKS:**
1. Q.P. and AV. are abbreviations of quasi-peak and average individually.
  2. "-": The Quasi-peak reading value also meets average limit and measurement with the average detector is unnecessary.
  3. The emission levels of other frequencies were very low against the limit.
  4. Margin value = Emission level - Limit value
  5. Correction factor = Insertion loss + Cable loss
  6. Emission Level = Correction Factor + Reading Value.

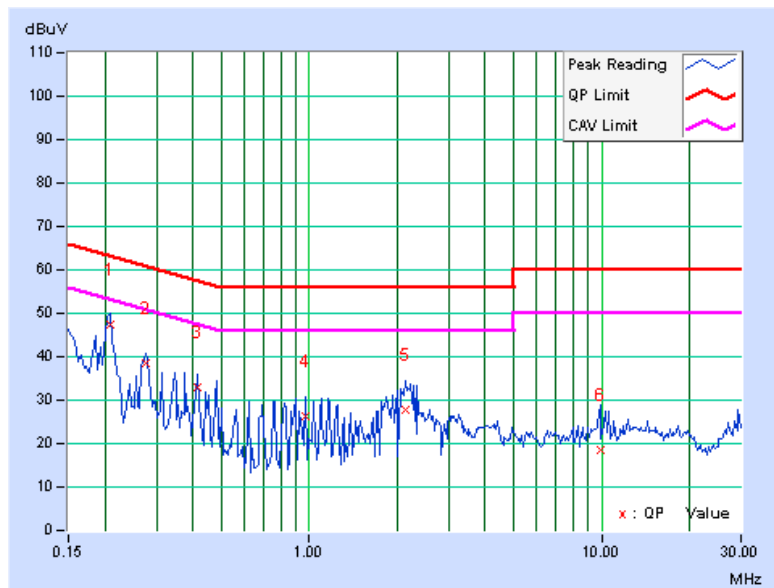



A D T

EUT TEST CONDITION		MEASUREMENT DETAIL	
CHANNEL	Channel 6	PHASE	Line 1
MODULATION TYPE	BPSK	6dB BANDWIDTH	9 kHz
TRANSFER RATE	6.0Mbps	INPUT POWER	120Vac, 60 Hz
ENVIRONMENTAL CONDITIONS	25deg. C, 65%RH, 991hPa	TEST MODE	B
TESTED BY	Mark Liao		

No	Freq. [MHz]	Corr. Factor (dB)	Reading Value		Emission Level		Limit		Margin	
			[dB (uV)]		[dB (uV)]		[dB (uV)]		(dB)	
			Q.P.	AV.	Q.P.	AV.	Q.P.	AV.	Q.P.	AV.
1	0.150	0.13	40.64	-	40.77	-	66.00	56.00	-25.23	-
2	0.216	0.13	39.95	-	40.08	-	62.96	52.96	-22.87	-
3	0.271	0.13	35.09	-	35.22	-	61.08	51.08	-25.86	-
4	3.746	0.35	28.93	-	29.28	-	56.00	46.00	-26.72	-
5	9.609	0.64	43.21	-	43.85	-	60.00	50.00	-16.15	-
6	11.602	0.74	34.30	-	35.04	-	60.00	50.00	-24.96	-

- REMARKS:**
1. Q.P. and AV. are abbreviations of quasi-peak and average individually.
  2. "-": The Quasi-peak reading value also meets average limit and measurement with the average detector is unnecessary.
  3. The emission levels of other frequencies were very low against the limit.
  4. Margin value = Emission level - Limit value
  5. Correction factor = Insertion loss + Cable loss
  6. Emission Level = Correction Factor + Reading Value.

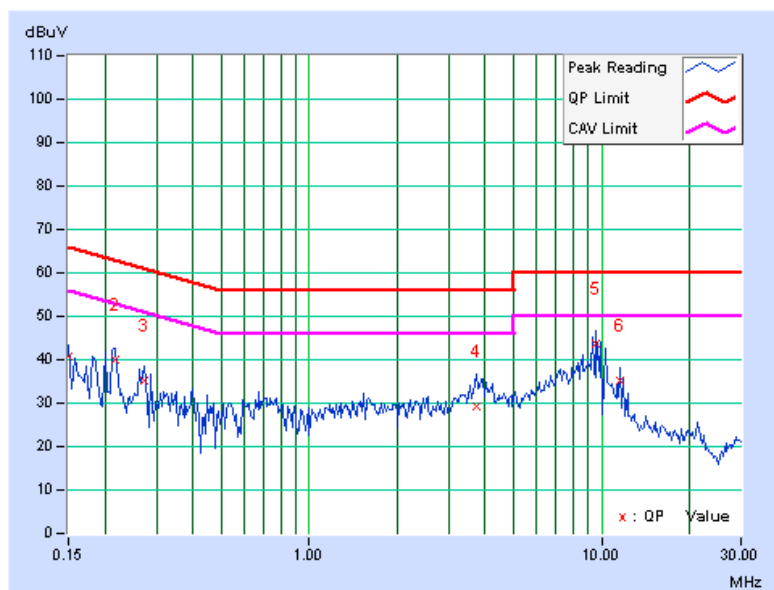



A D T

EUT TEST CONDITION		MEASUREMENT DETAIL	
CHANNEL	Channel 6	PHASE	Line 2
MODULATION TYPE	BPSK	6dB BANDWIDTH	9 kHz
TRANSFER RATE	6.0Mbps	INPUT POWER	120Vac, 60 Hz
ENVIRONMENTAL CONDITIONS	25deg. C, 65%RH, 991hPa	TEST MODE	B
TESTED BY	Mark Liao		

No	Freq. [MHz]	Corr. Factor (dB)	Reading Value		Emission Level		Limit		Margin	
			[dB (uV)]		[dB (uV)]		[dB (uV)]		(dB)	
			Q.P.	AV.	Q.P.	AV.	Q.P.	AV.	Q.P.	AV.
1	0.154	0.14	34.87	-	35.01	-	65.79	55.79	-30.78	-
2	0.205	0.15	35.92	-	36.07	-	63.42	53.42	-27.35	-
3	0.263	0.15	30.97	-	31.12	-	61.33	51.33	-30.20	-
4	0.400	0.16	26.25	-	26.41	-	57.85	47.85	-31.44	-
5	8.617	0.60	36.75	-	37.35	-	60.00	50.00	-22.65	-
6	9.945	0.66	43.87	-	44.53	-	60.00	50.00	-15.47	-

- REMARKS:**
1. Q.P. and AV. are abbreviations of quasi-peak and average individually.
  2. "-": The Quasi-peak reading value also meets average limit and measurement with the average detector is unnecessary.
  3. The emission levels of other frequencies were very low against the limit.
  4. Margin value = Emission level - Limit value
  5. Correction factor = Insertion loss + Cable loss
  6. Emission Level = Correction Factor + Reading Value.

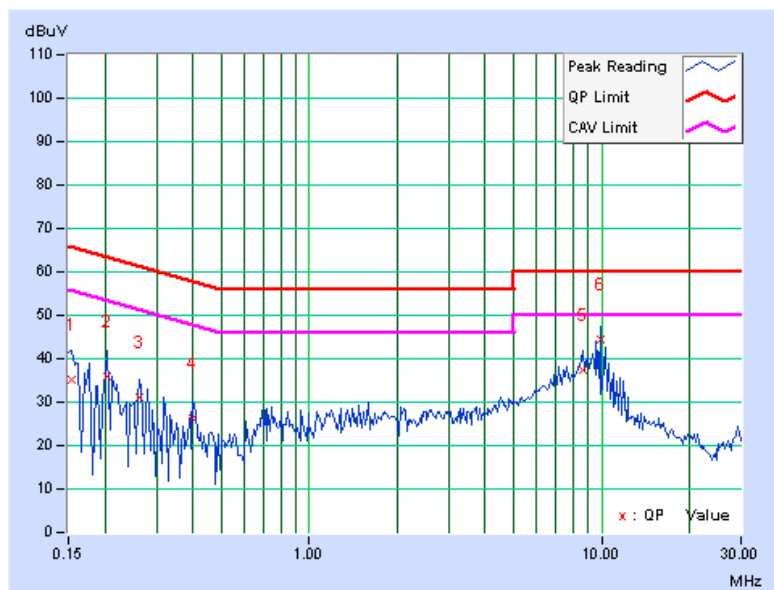



A D T

EUT TEST CONDITION		MEASUREMENT DETAIL	
CHANNEL	Channel 6	PHASE	Line 1
MODULATION TYPE	BPSK	6dB BANDWIDTH	9 kHz
TRANSFER RATE	6.0Mbps	INPUT POWER	120Vac, 60 Hz
ENVIRONMENTAL CONDITIONS	25deg. C, 65%RH, 991hPa	TEST MODE	C
TESTED BY	Mark Liao		

No	Freq. [MHz]	Corr. Factor (dB)	Reading Value		Emission Level		Limit		Margin	
			[dB (uV)]		[dB (uV)]		[dB (uV)]		(dB)	
			Q.P.	AV.	Q.P.	AV.	Q.P.	AV.	Q.P.	AV.
1	0.154	0.13	41.24	-	41.37	-	65.79	55.79	-24.42	-
2	0.197	0.13	40.81	-	40.94	-	63.74	53.74	-22.80	-
3	0.248	0.13	36.51	-	36.64	-	61.84	51.84	-25.19	-
4	2.156	0.24	26.54	-	26.78	-	56.00	46.00	-29.22	-
5	6.434	0.49	25.40	-	25.89	-	60.00	50.00	-34.11	-
6	10.617	0.69	29.79	-	30.48	-	60.00	50.00	-29.52	-

- REMARKS:**
1. Q.P. and AV. are abbreviations of quasi-peak and average individually.
  2. "-": The Quasi-peak reading value also meets average limit and measurement with the average detector is unnecessary.
  3. The emission levels of other frequencies were very low against the limit.
  4. Margin value = Emission level - Limit value
  5. Correction factor = Insertion loss + Cable loss
  6. Emission Level = Correction Factor + Reading Value.

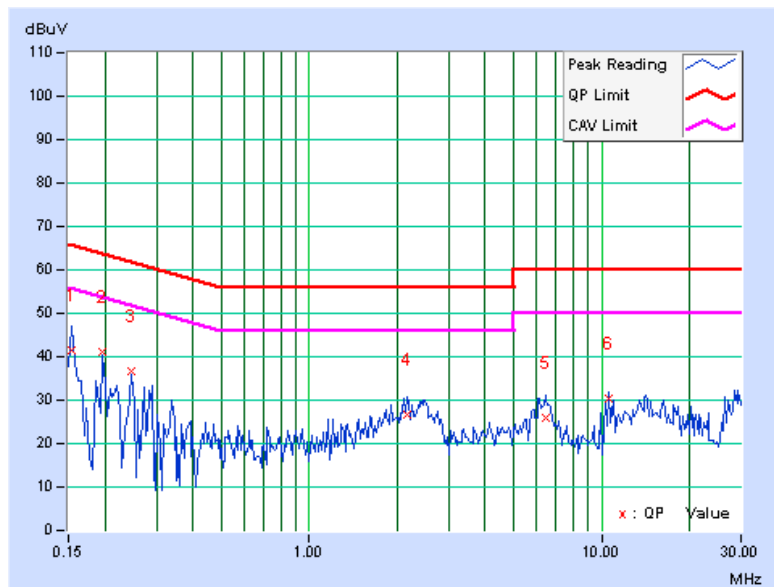



A D T

EUT TEST CONDITION		MEASUREMENT DETAIL	
CHANNEL	Channel 6	PHASE	Line 2
MODULATION TYPE	BPSK	6dB BANDWIDTH	9 kHz
TRANSFER RATE	6.0Mbps	INPUT POWER	120Vac, 60 Hz
ENVIRONMENTAL CONDITIONS	25deg. C, 65%RH, 991hPa	TEST MODE	C
TESTED BY	Mark Liao		

No	Freq. [MHz]	Corr. Factor (dB)	Reading Value		Emission Level		Limit		Margin	
			[dB (uV)]		[dB (uV)]		[dB (uV)]		(dB)	
			Q.P.	AV.	Q.P.	AV.	Q.P.	AV.	Q.P.	AV.
1	0.150	0.14	45.57	-	45.71	-	66.00	56.00	-20.29	-
2	0.197	0.15	41.52	-	41.67	-	63.74	53.74	-22.07	-
3	0.236	0.15	37.11	-	37.26	-	62.24	52.24	-24.98	-
4	2.422	0.28	25.54	-	25.82	-	56.00	46.00	-30.18	-
5	6.527	0.50	20.13	-	20.63	-	60.00	50.00	-39.37	-
6	28.688	0.75	29.33	-	30.08	-	60.00	50.00	-29.92	-

- REMARKS:**
1. Q.P. and AV. are abbreviations of quasi-peak and average individually.
  2. "-": The Quasi-peak reading value also meets average limit and measurement with the average detector is unnecessary.
  3. The emission levels of other frequencies were very low against the limit.
  4. Margin value = Emission level - Limit value
  5. Correction factor = Insertion loss + Cable loss
  6. Emission Level = Correction Factor + Reading Value.

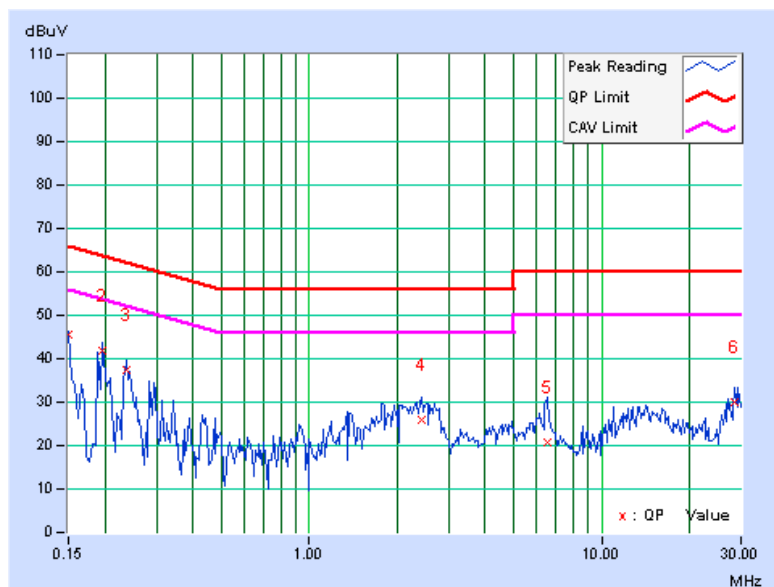

### 4.3 6dB BANDWIDTH MEASUREMENT

#### 4.3.1 LIMITS OF 6dB BANDWIDTH MEASUREMENT

The minimum of 6dB Bandwidth Measurement is 0.5 MHz.

#### 4.3.2 TEST INSTRUMENTS

DESCRIPTION & MANUFACTURER	MODEL NO.	SERIAL NO.	DATE OF CALIBRATION	DUE DATE OF CALIBRATION
SPECTRUM ANALYZER	FSP40	100040	Jul. 04, 2008	Jul. 03, 2009

**NOTE:** The calibration interval of the above test instruments is 12 months and the calibrations are traceable to NML/ROC and NIST/USA.

#### 4.3.3 TEST PROCEDURE

The transmitter output was connected to the spectrum analyzer through an attenuator. The bandwidth of the fundamental frequency was measured by spectrum analyzer with 100kHz RBW and 100kHz VBW. The 6dB bandwidth is defined as the total spectrum the power of which is higher than peak power minus 6dB.

#### 4.3.4 DEVIATION FROM TEST STANDARD

No deviation

#### 4.3.5 TEST SETUP

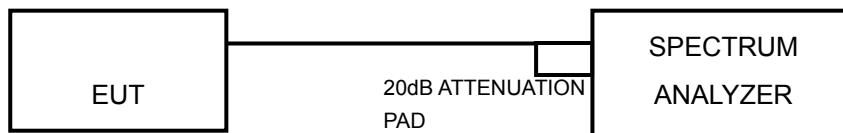

#### 4.3.6 EUT OPERATING CONDITIONS

The software provided by client to enable the EUT under transmission condition continuously at lowest, middle and highest channel frequencies individually.



A D T

### 4.3.7 TEST RESULTS

#### 802.11b DSSS MODULATION: 1TX

<b>MODULATION TYPE</b>	DBPSK	<b>TRANSFER RATE</b>	1.0Mbps
<b>INPUT POWER</b>	120Vac, 60 Hz	<b>ENVIRONMENTAL CONDITIONS</b>	25deg.C, 65%RH, 991hPa
<b>TESTED BY</b>	Lori Chiu		

CHANNEL	CHANNEL FREQUENCY (MHz)	6dB BANDWIDTH (MHz)	MINIMUM LIMIT (MHz)	PASS / FAIL
1	2412	10.08	0.5	PASS
6	2437	10.11	0.5	PASS
11	2462	10.10	0.5	PASS

#### CH 1

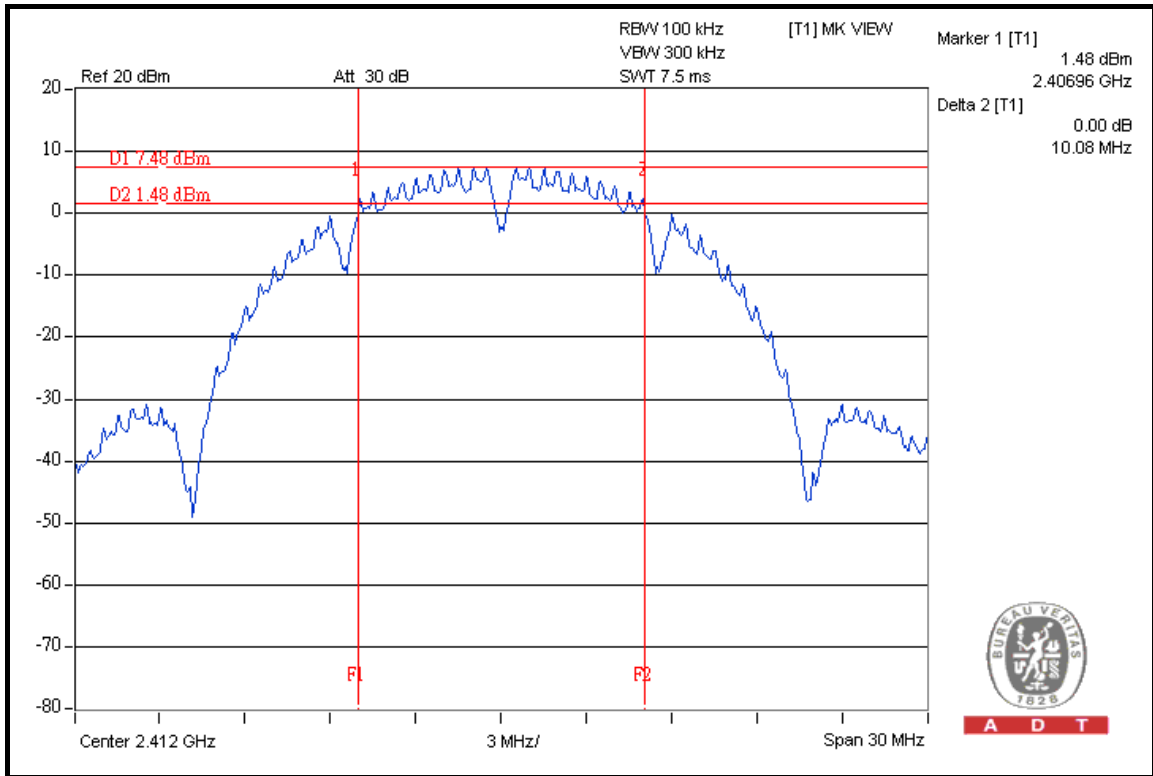





A D T

### CH 6

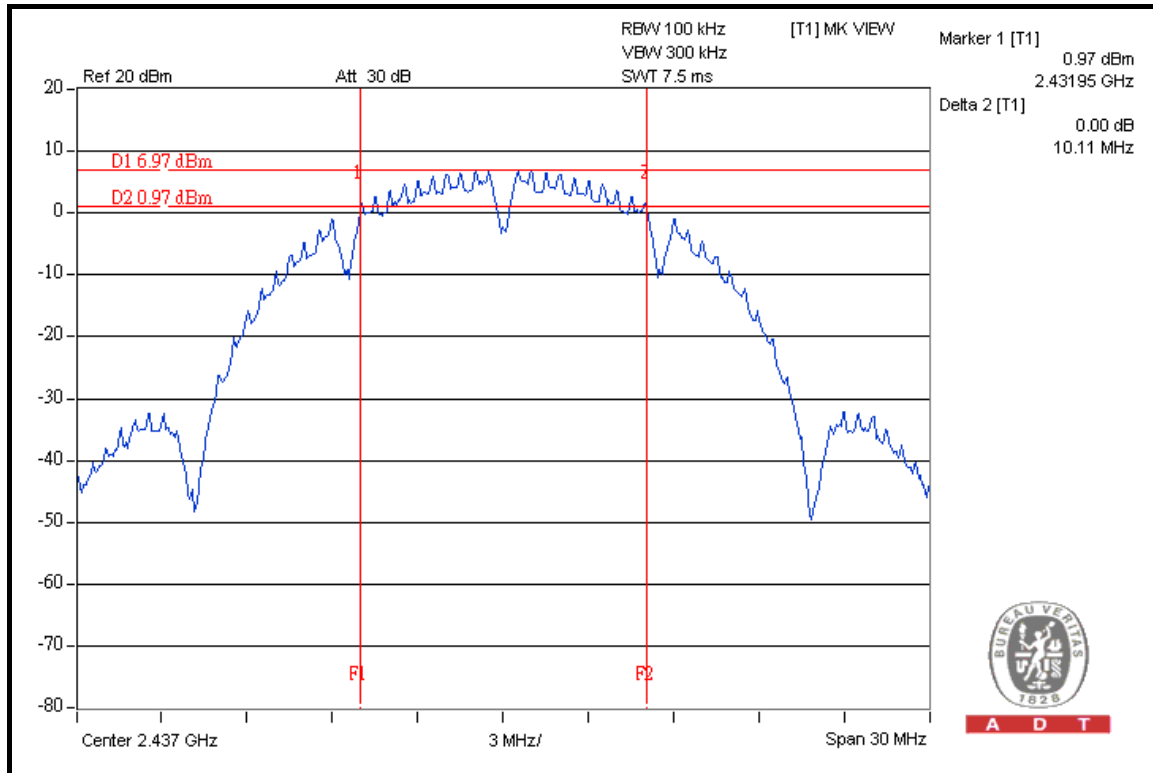

### CH 11

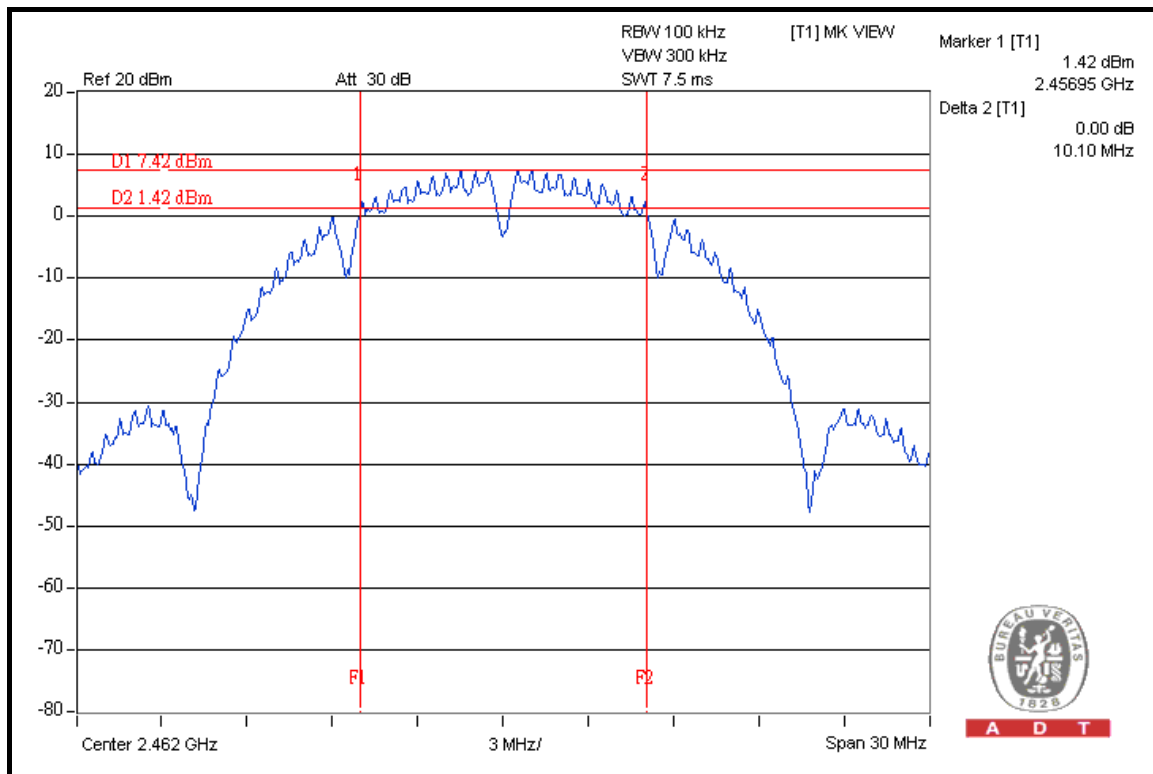



A D T

### 802.11g OFDM MODULATION: 1TX

<b>MODULATION TYPE</b>	BPSK	<b>TRANSFER RATE</b>	6.0Mbps
<b>INPUT POWER</b>	120Vac, 60 Hz	<b>ENVIRONMENTAL CONDITIONS</b>	25deg.C, 65%RH, 991hPa
<b>TESTED BY</b>	Lori Chiu		

CHANNEL	CHANNEL FREQUENCY (MHz)	6dB BANDWIDTH (MHz)	MINIMUM LIMIT (MHz)	PASS / FAIL
1	2412	16.51	0.5	PASS
6	2437	16.51	0.5	PASS
11	2462	16.53	0.5	PASS

### CH 1

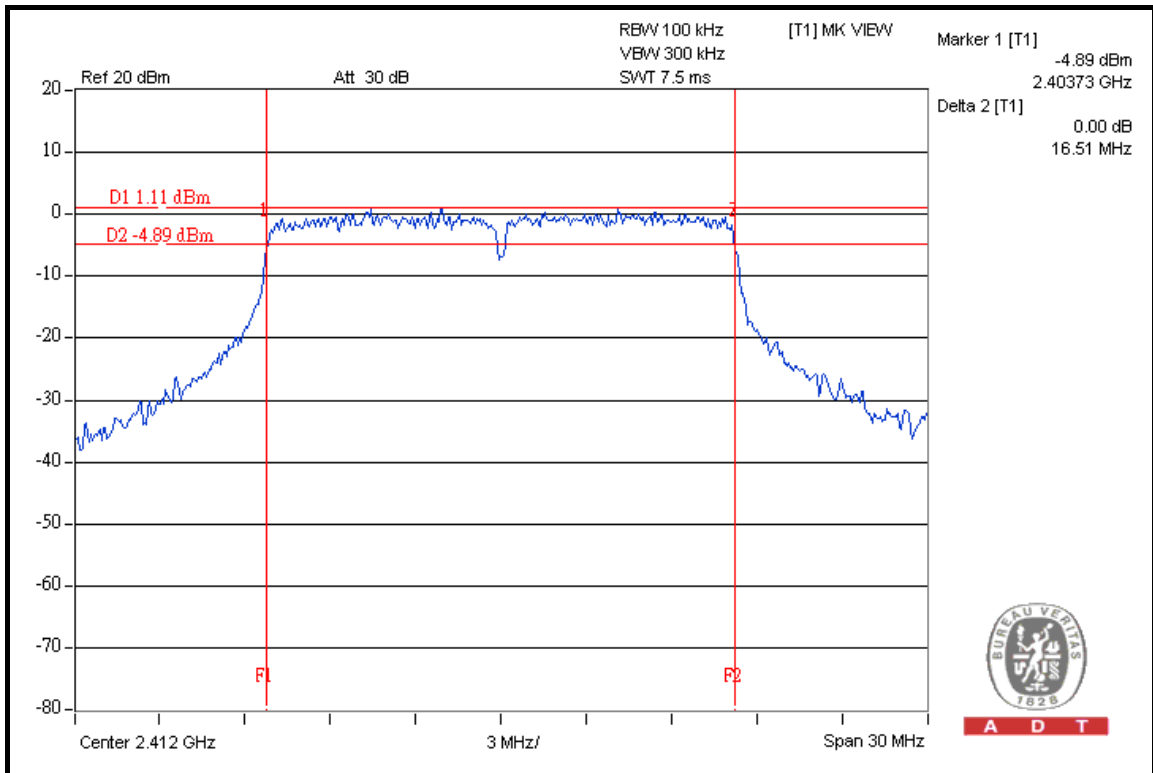



A D T

### CH 6

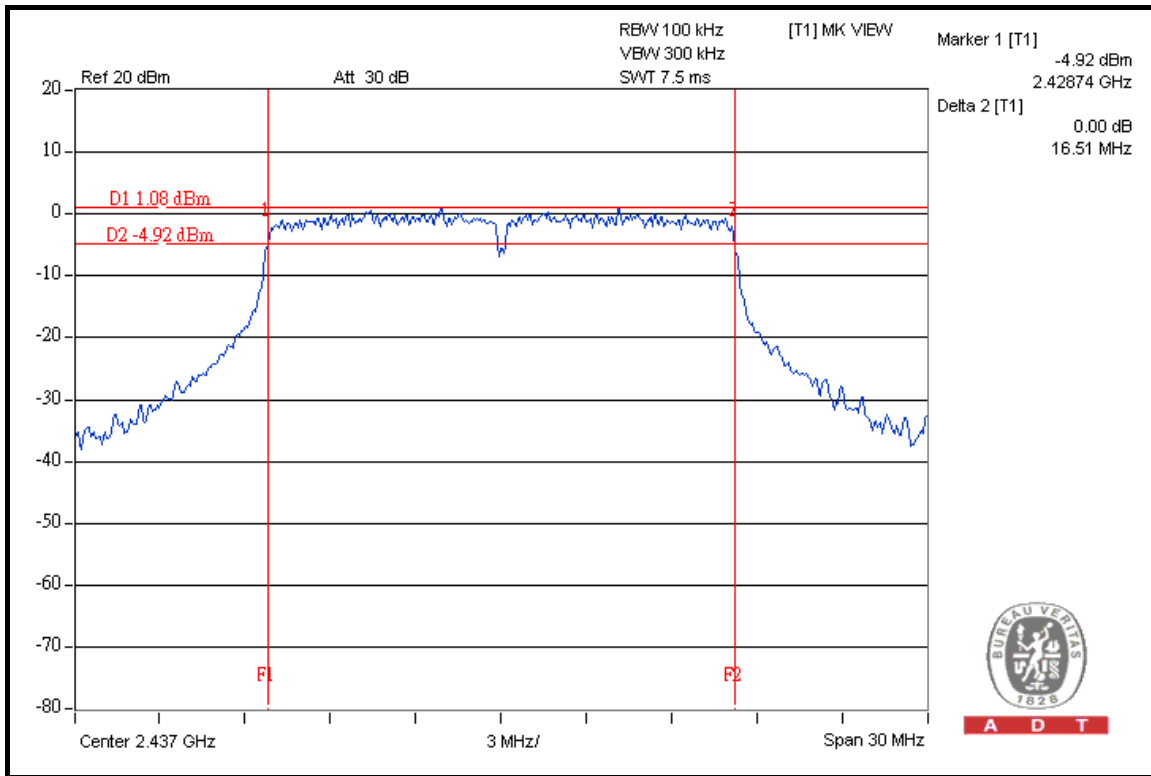

### CH 11

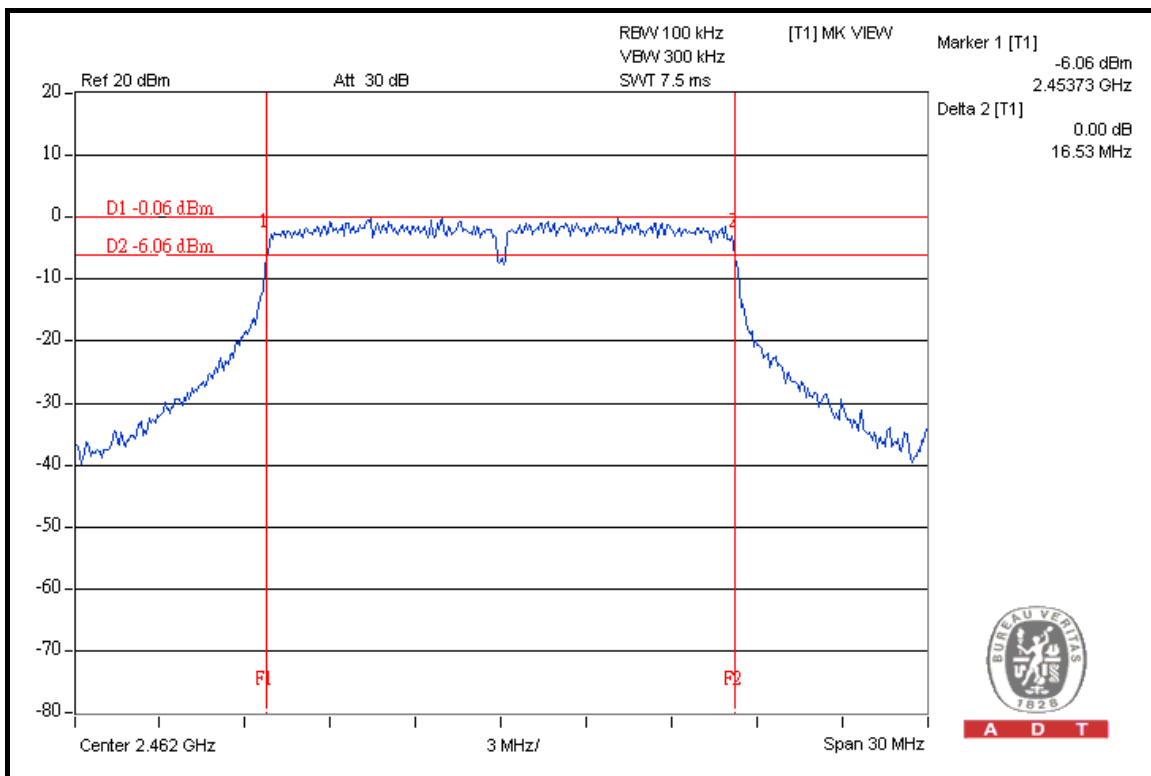



A D T

### DRAFT 802.11n (20MHz) OFDM MODULATION: 1TX

<b>MODULATION TYPE</b>	BPSK	<b>TRANSFER RATE</b>	7.2Mbps
<b>INPUT POWER</b>	120Vac, 60 Hz	<b>ENVIRONMENTAL CONDITIONS</b>	25deg.C, 65%RH, 991hPa
<b>TESTED BY</b>	Lori Chiu		

CHANNEL	CHANNEL FREQUENCY (MHz)	6dB BANDWIDTH (MHz)	MINIMUM LIMIT (MHz)	PASS / FAIL
1	2412	17.80	0.5	PASS
6	2437	17.80	0.5	PASS
11	2462	17.74	0.5	PASS

### CH 1

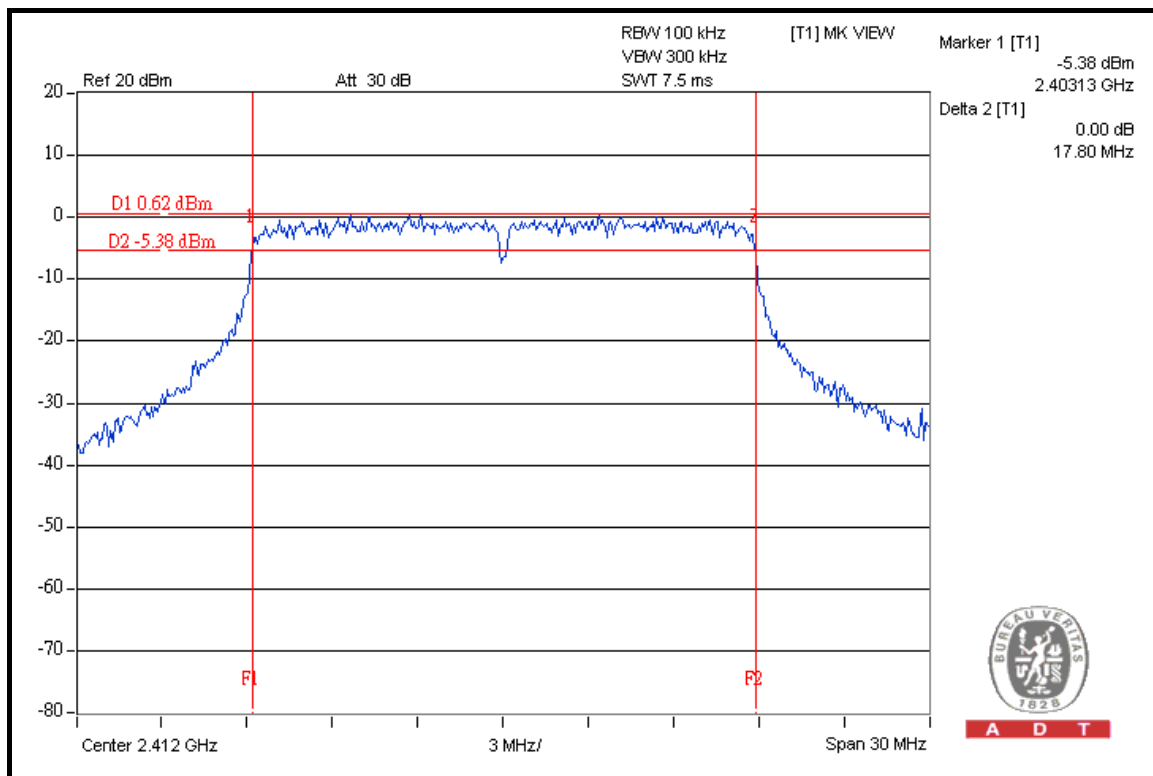

A D T



A D T

### CH 6

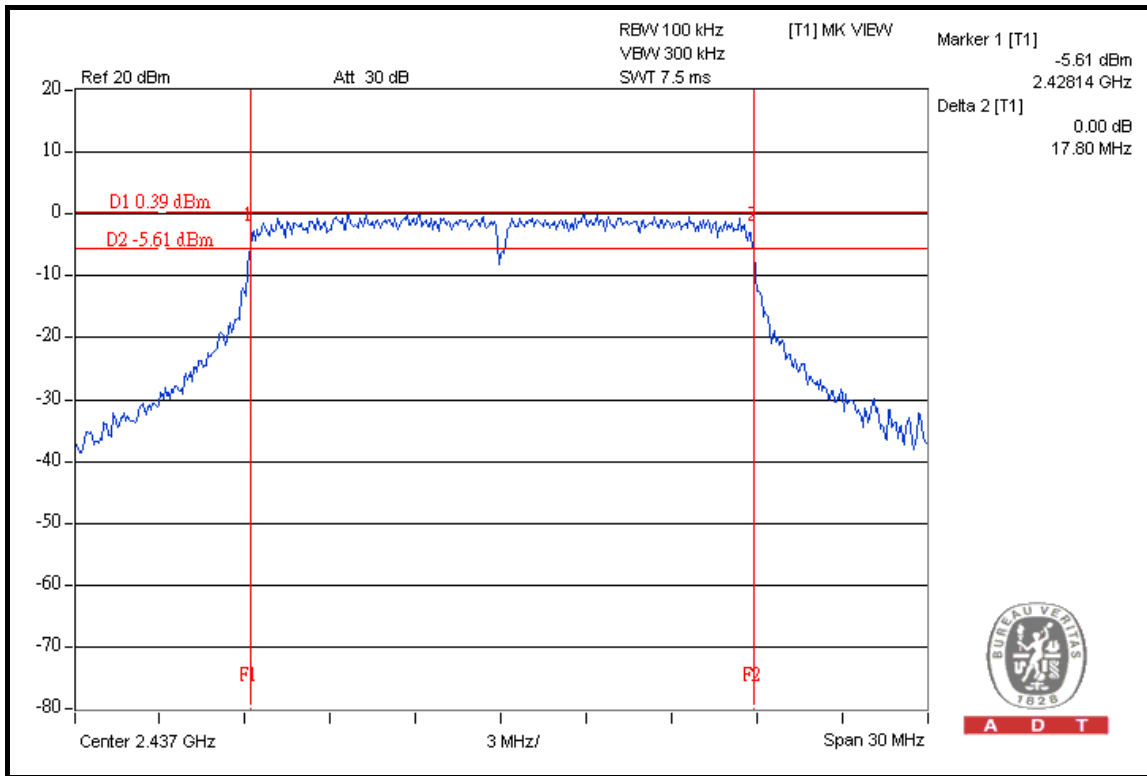

### CH 11

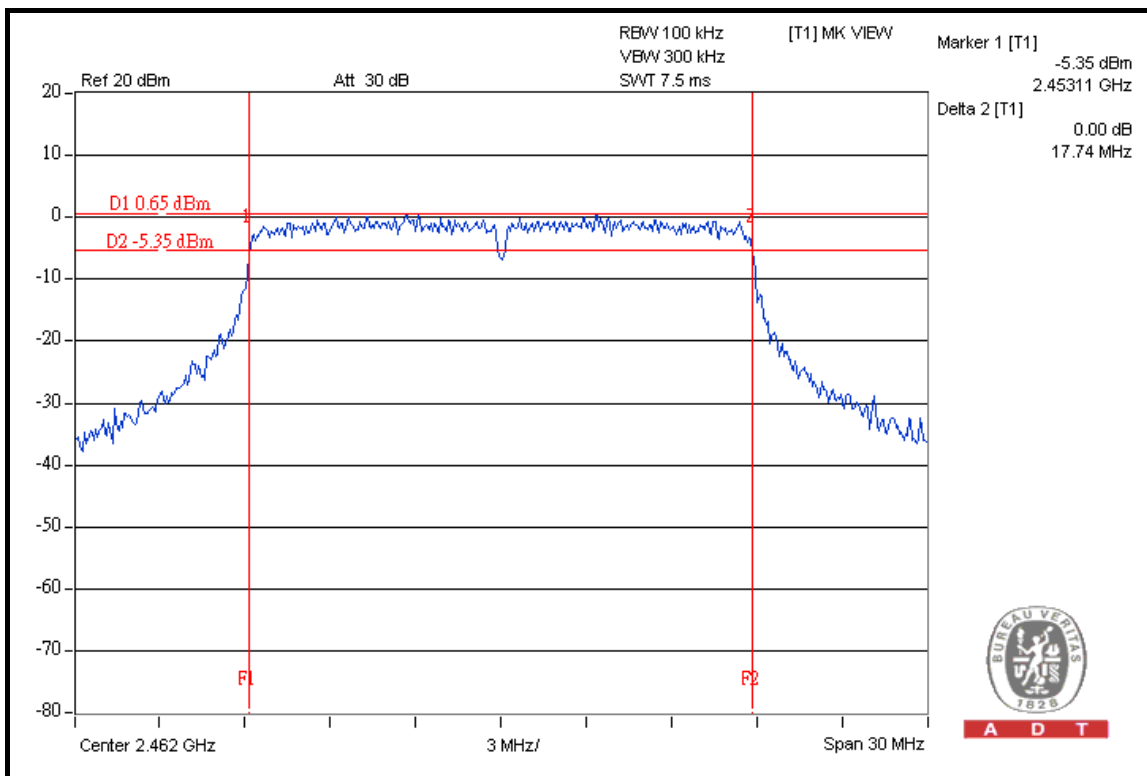



A D T

**DRAFT 802.11n (20MHz) OFDM MODULATION: 2TX**

<b>MODULATION TYPE</b>	BPSK	<b>TRANSFER RATE</b>	14.4Mbps
<b>INPUT POWER</b>	120Vac, 60 Hz	<b>ENVIRONMENTAL CONDITIONS</b>	25deg.C, 65%RH, 991hPa
<b>TESTED BY</b>	Lori Chiu		

CHANNEL	CHANNEL FREQUENCY (MHz)	6dB BANDWIDTH (MHz)		MINIMUM LIMIT (MHz)	PASS / FAIL
		CHAIN 0	CHAIN 1		
1	2412	17.76	17.69	0.5	PASS
6	2437	17.75	17.68	0.5	PASS
11	2462	17.74	17.71	0.5	PASS



A D T

### FOR CHAIN 0: CH 1

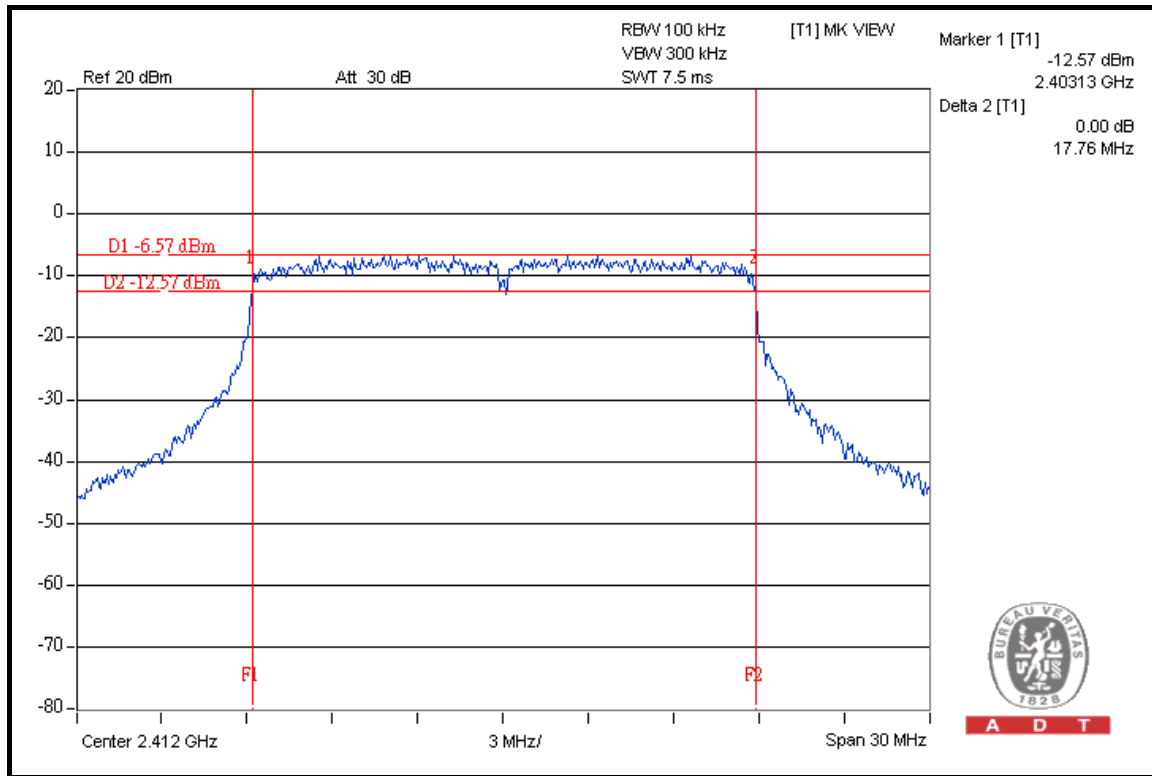

### CH 6

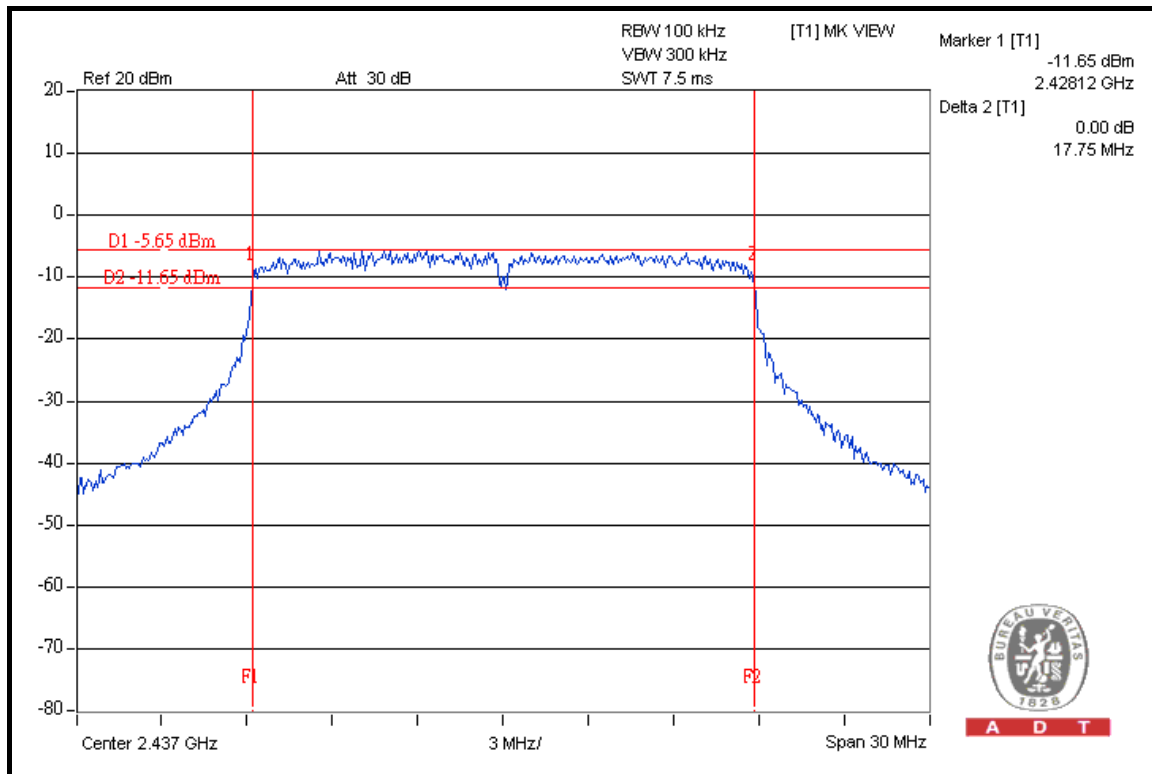



A D T

### CH 11

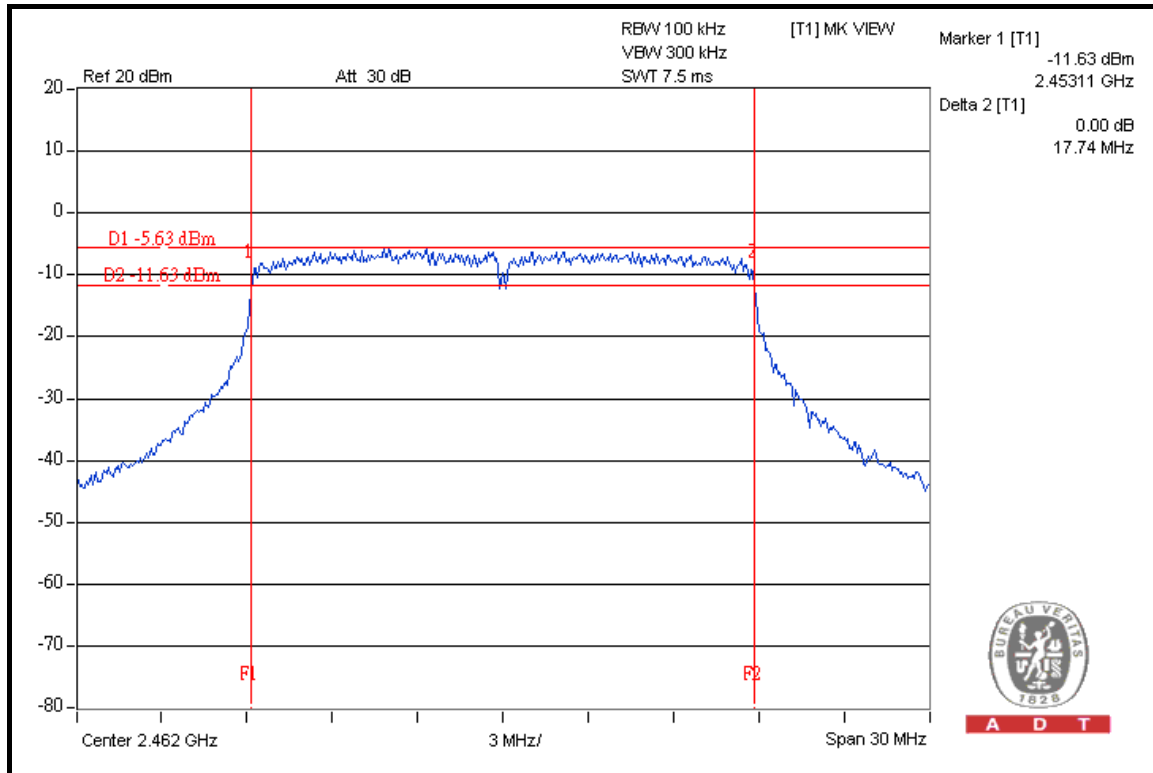

A D T

### FOR CHAIN 1: CH 1

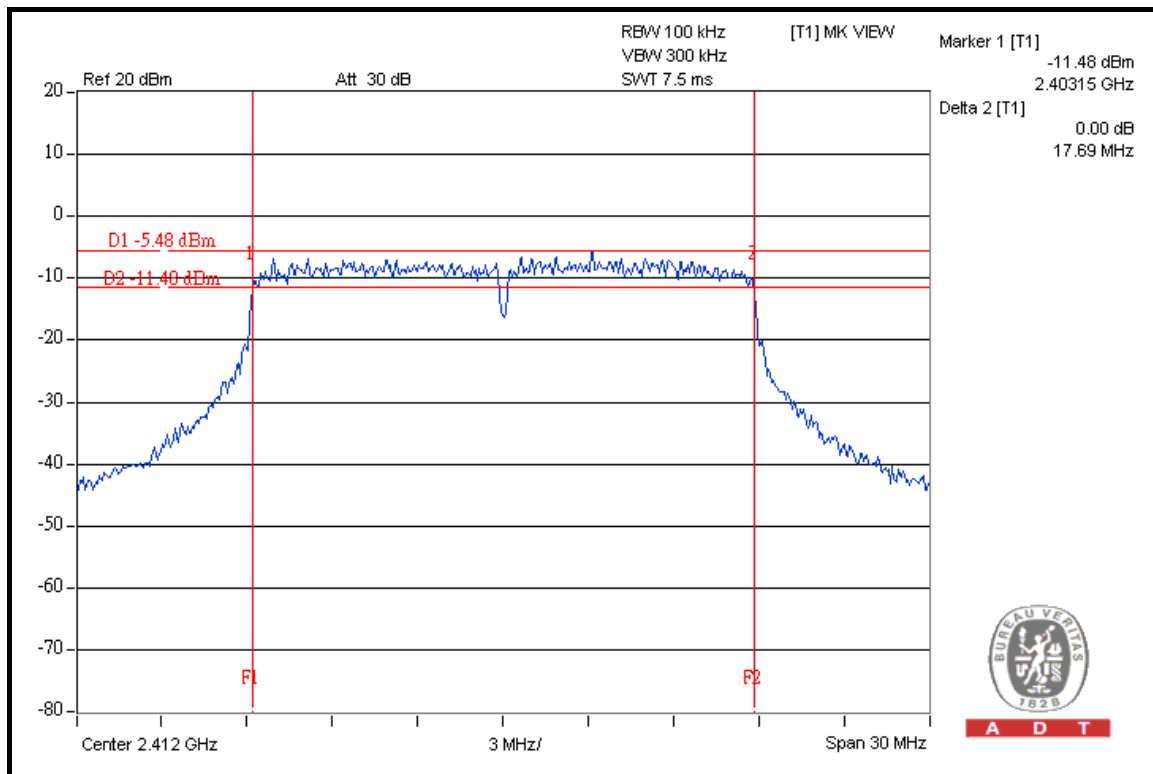

A D T





A D T

### CH 6

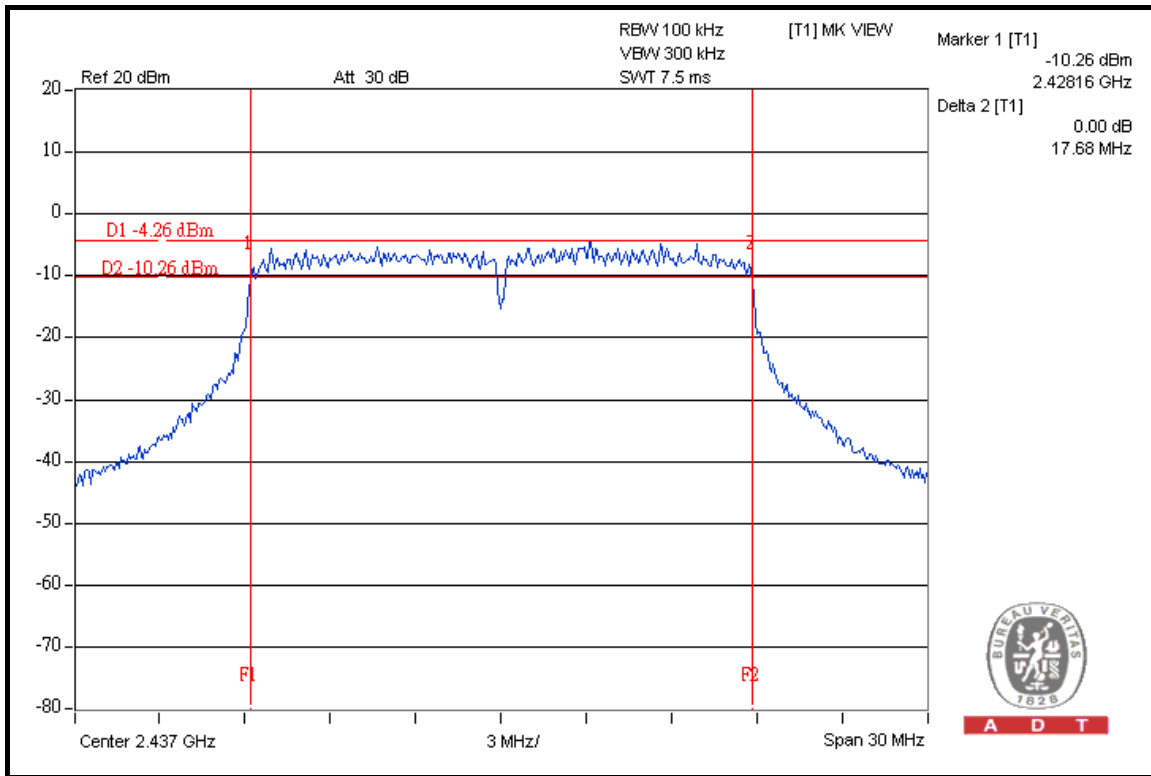

A D T

### CH 11

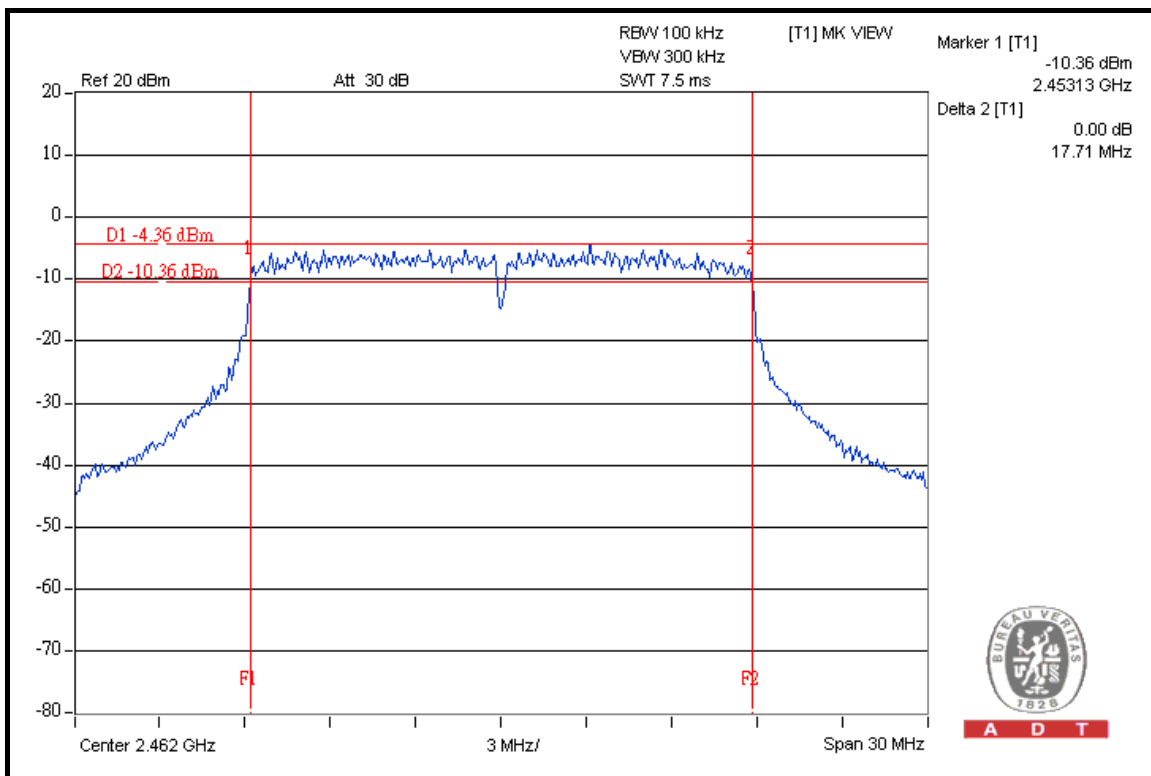

A D T



A D T

### DRAFT 802.11n (40MHz) OFDM MODULATION: 1TX

<b>MODULATION TYPE</b>	BPSK	<b>TRANSFER RATE</b>	15.0Mbps
<b>INPUT POWER</b>	120Vac, 60 Hz	<b>ENVIRONMENTAL CONDITIONS</b>	25deg.C, 65%RH, 991hPa
<b>TESTED BY</b>	Lori Chiu		

CHANNEL	CHANNEL FREQUENCY (MHz)	6dB BANDWIDTH (MHz)	MINIMUM LIMIT (MHz)	PASS / FAIL
1	2422	36.50	0.5	PASS
4	2437	36.51	0.5	PASS
7	2452	36.47	0.5	PASS

### CH 1

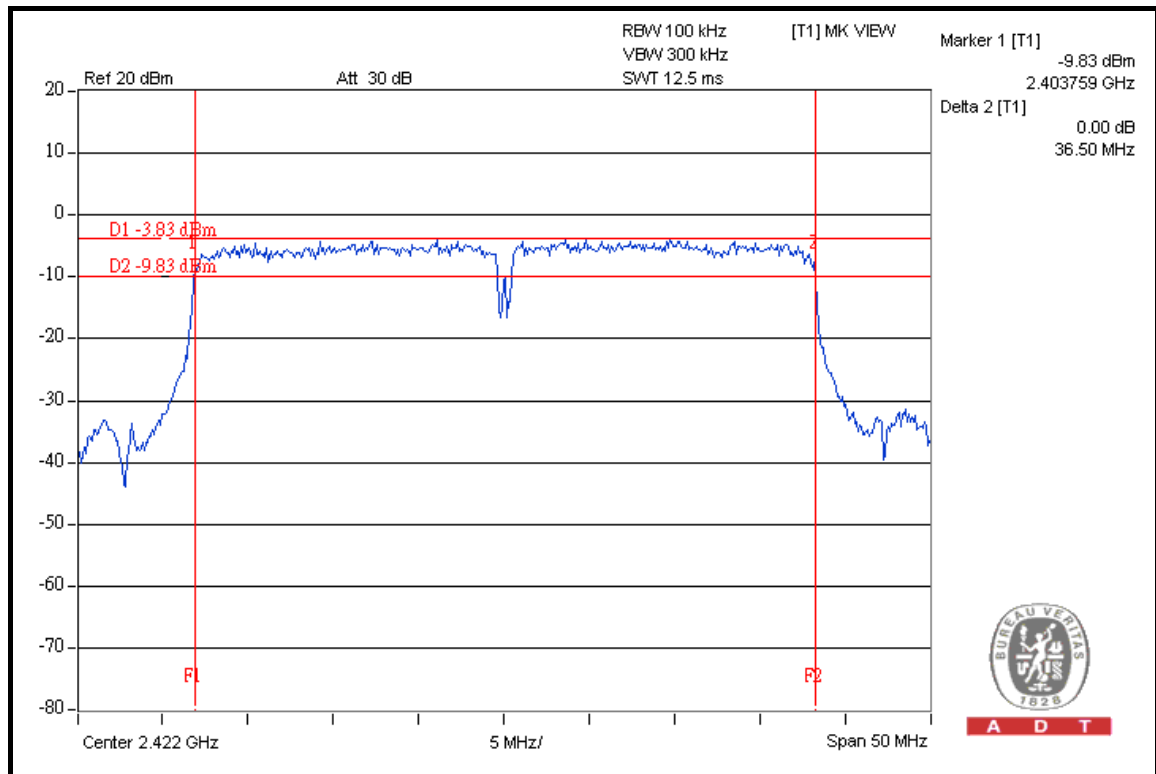

A D T



A D T

### CH 4

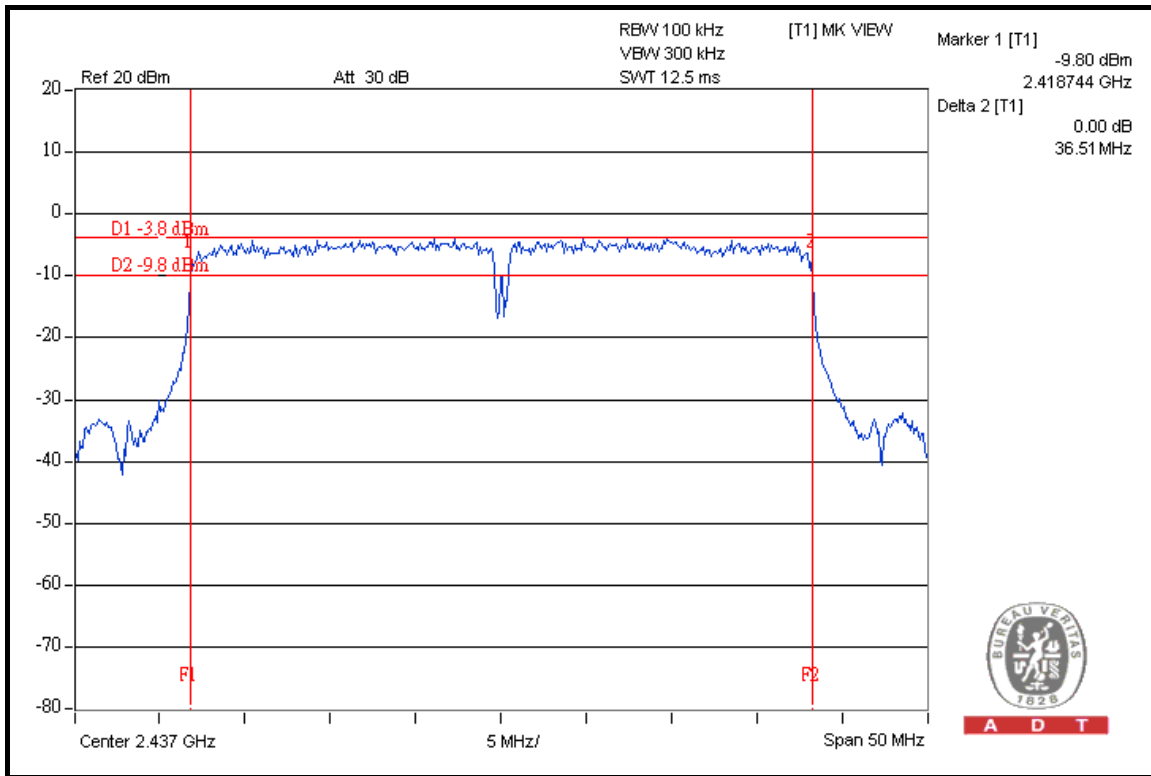

### CH 7

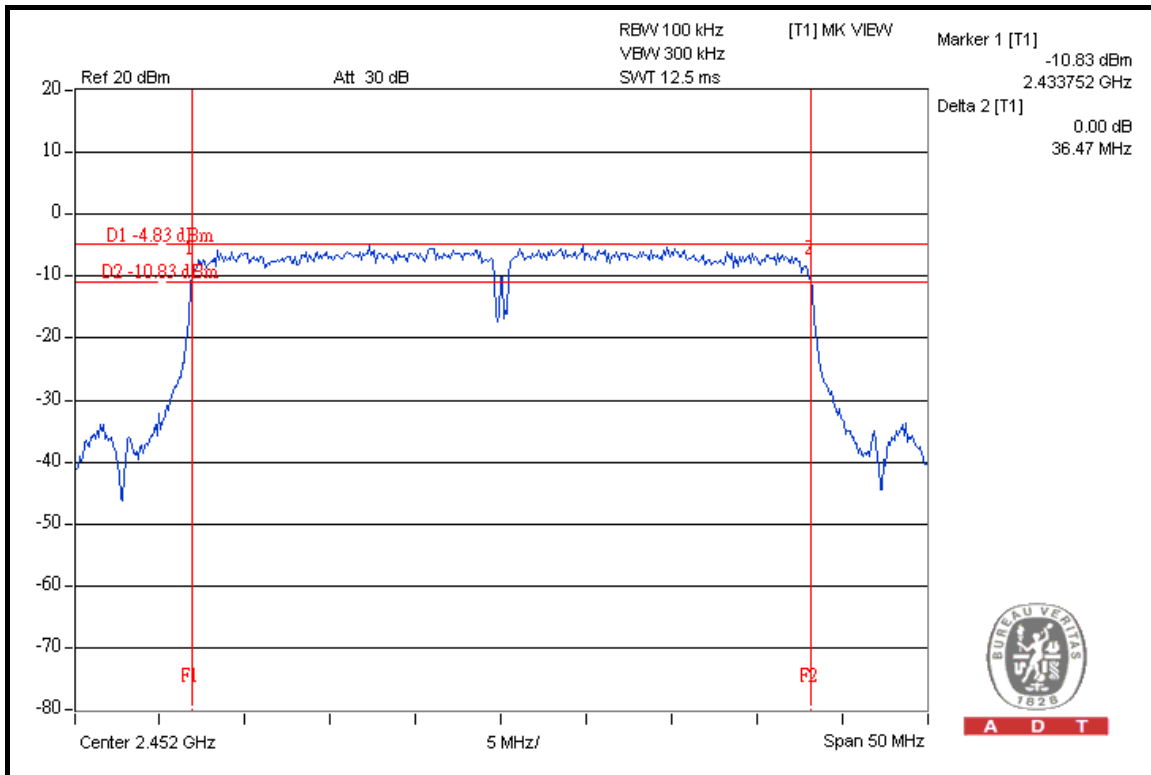



A D T

**DRAFT 802.11n (40MHz) OFDM MODULATION: 2TX**

<b>MODULATION TYPE</b>	BPSK	<b>TRANSFER RATE</b>	30.0Mbps
<b>INPUT POWER</b>	120Vac, 60 Hz	<b>ENVIRONMENTAL CONDITIONS</b>	25deg.C, 65%RH, 991hPa
<b>TESTED BY</b>	Lori Chiu		

CHANNEL	CHANNEL FREQUENCY (MHz)	6dB BANDWIDTH (MHz)		MINIMUM LIMIT (MHz)	PASS / FAIL
		CHAIN 0	CHAIN 1		
1	2422	36.44	36.44	0.5	PASS
4	2437	36.48	36.42	0.5	PASS
7	2452	36.46	36.45	0.5	PASS



A D T

### FOR CHAIN 0: CH 1

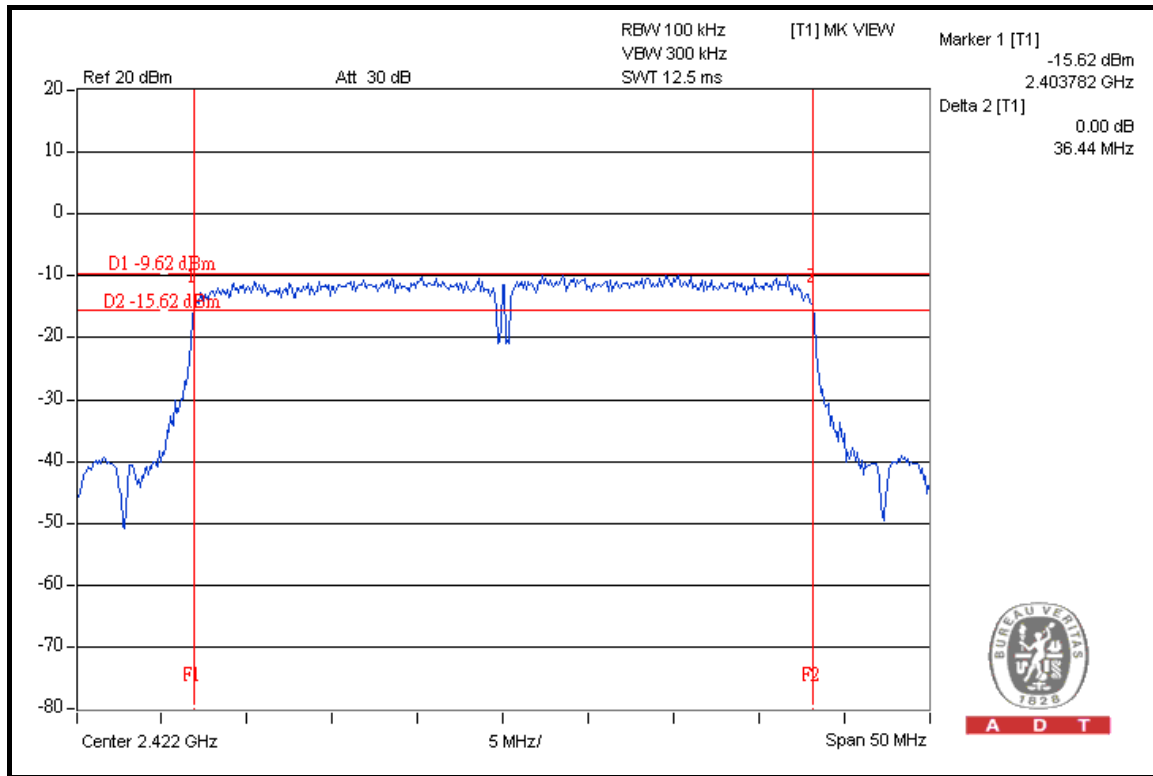

### CH 4

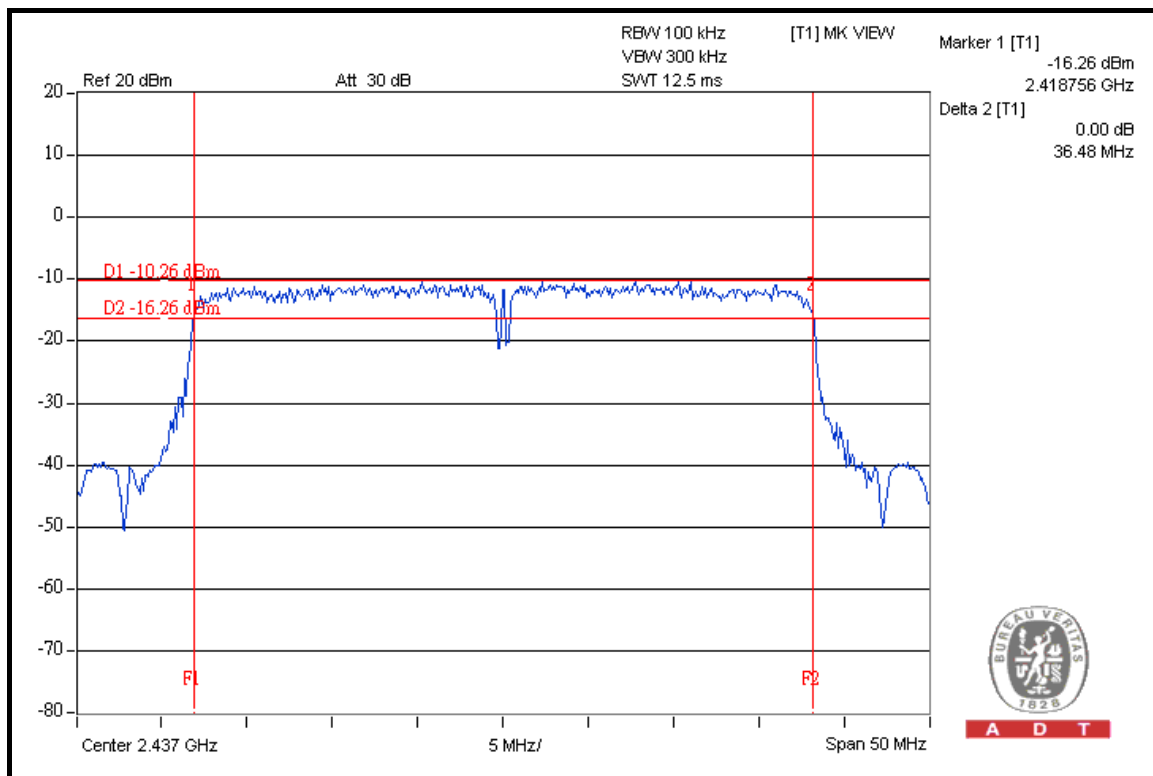



A D T

### CH 7

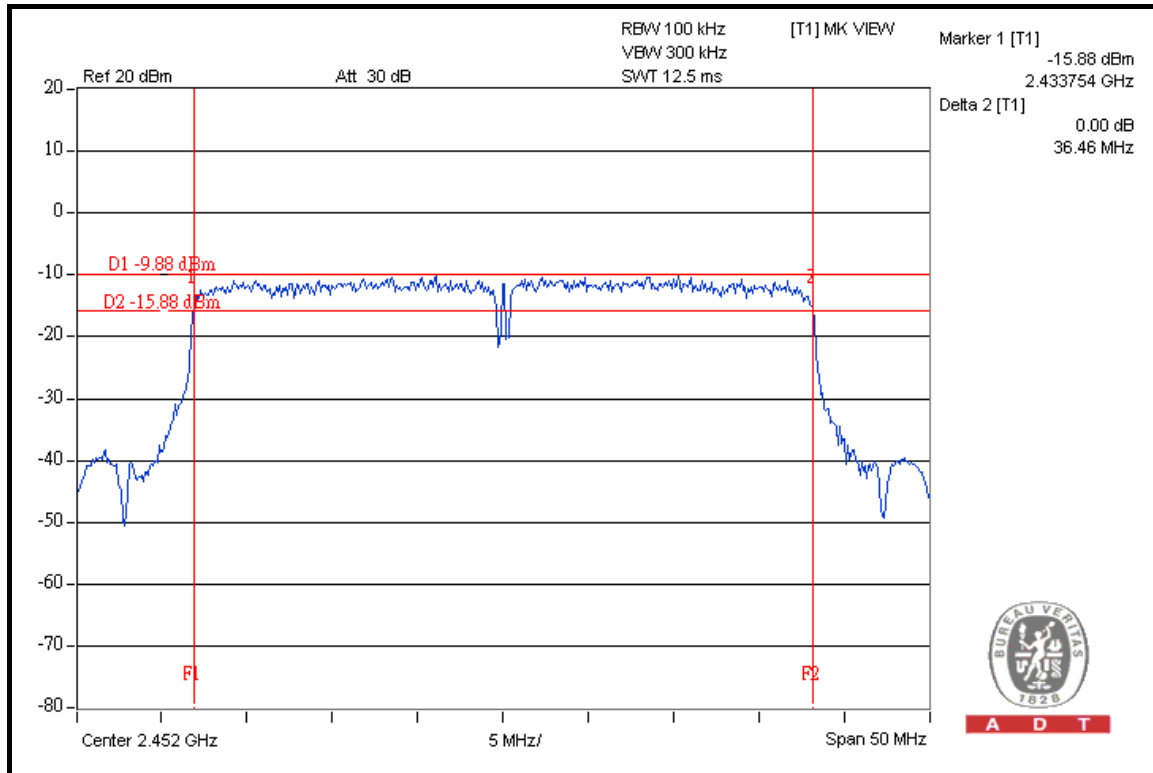

### FOR CHAIN 1: CH 1

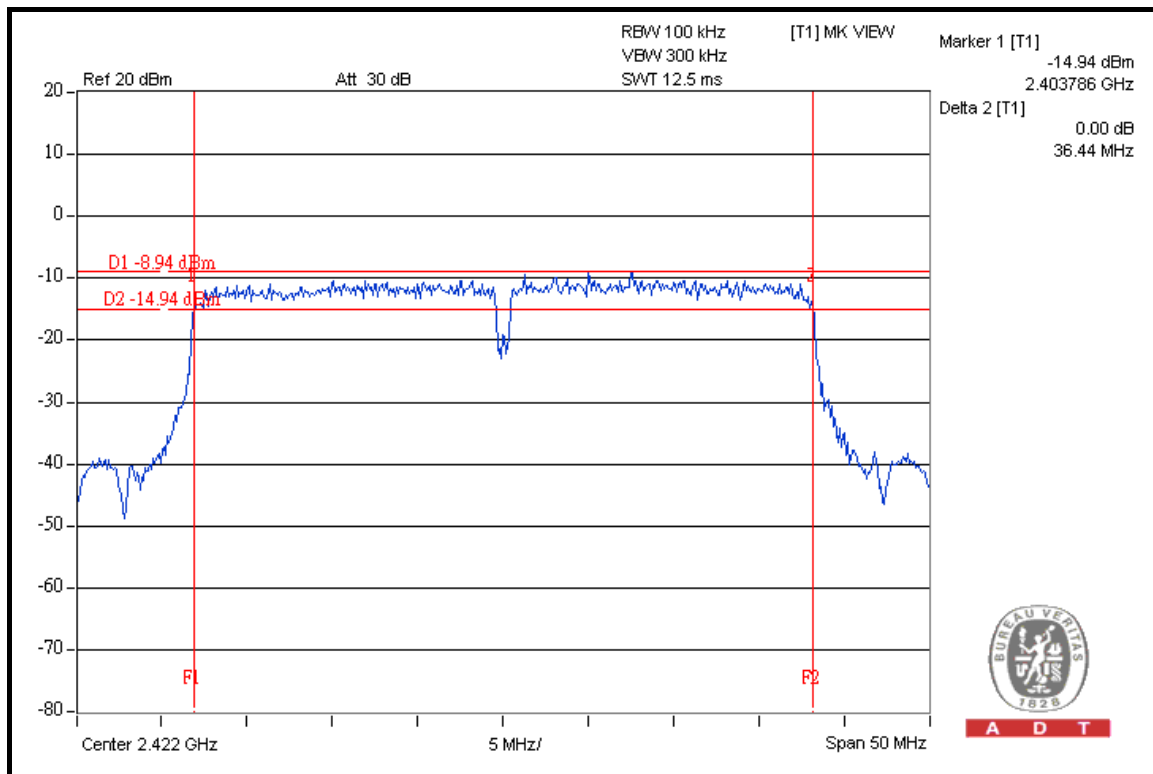



A D T

### CH 4

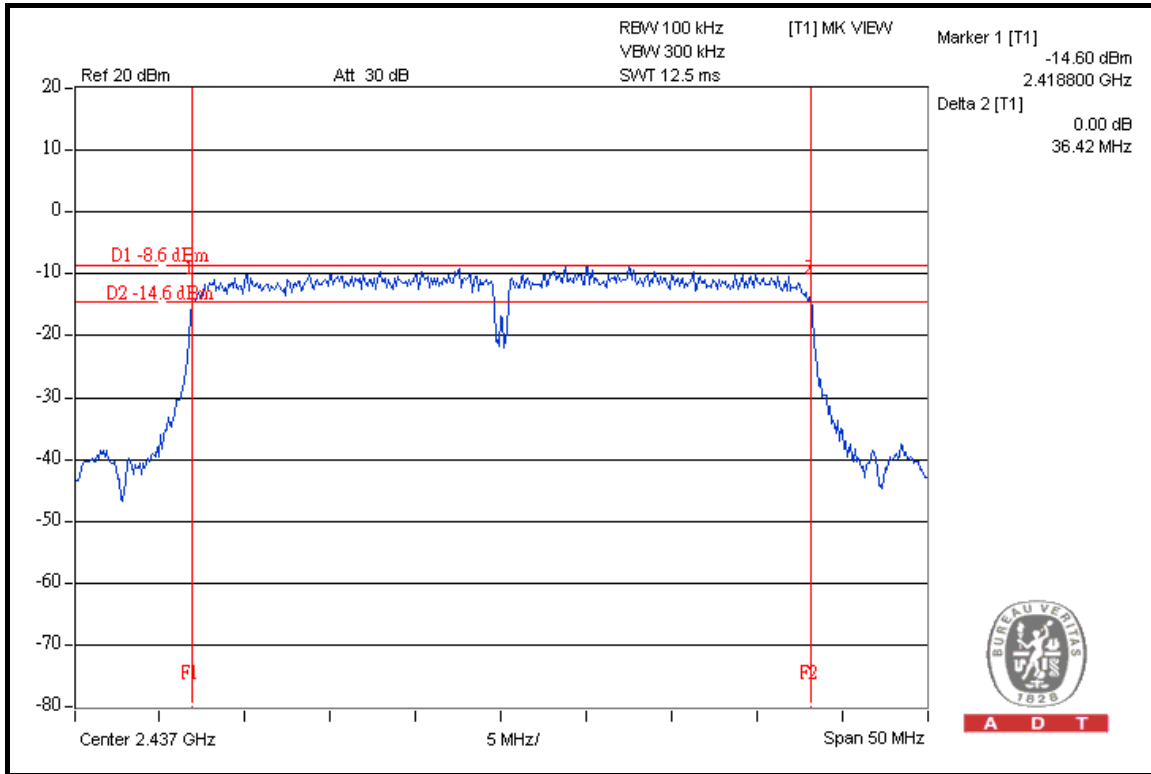

A D T

### CH 7

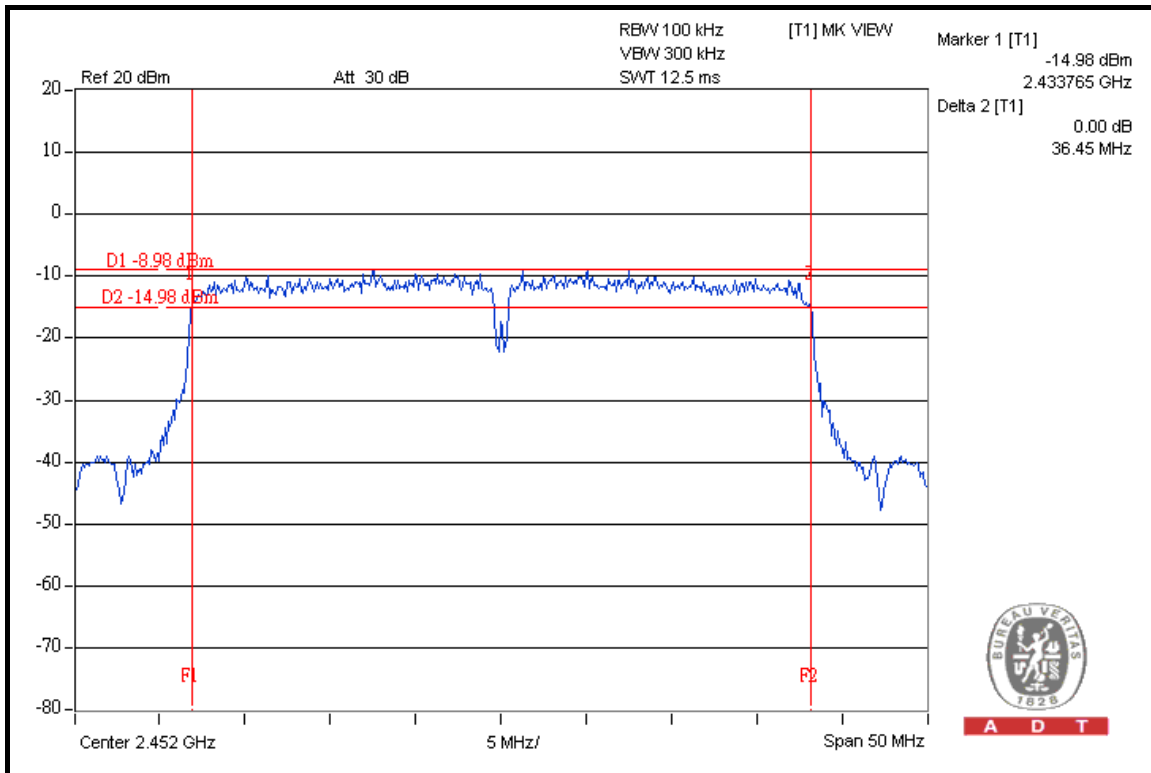

A D T

#### 4.4 MAXIMUM PEAK OUTPUT POWER

##### 4.4.1 LIMITS OF MAXIMUM PEAK OUTPUT POWER MEASUREMENT

The Maximum Peak Output Power Measurement is 30dBm.

##### 4.4.2 INSTRUMENTS

DESCRIPTION & MANUFACTURER	MODEL NO.	SERIAL NO.	DATE OF CALIBRATION	DUE DATE OF CALIBRATION
HIGH SPEED PEAK POWER METER	ML2495A	0824012	Aug. 04, 2008	Aug. 03, 2009
POWER SENSOR	MA2411B	0738138	Aug. 04, 2008	Aug. 03, 2009

**NOTE:**

1. The calibration interval of the above test instruments is 12 months and the calibrations are traceable to NML/ROC and NIST/USA.
2. Measurement Bandwidth of ML2495A is 65MHz greater than 6dB bandwidth of emission.

##### 4.4.3 TEST PROCEDURES

A power sensor was used on the output port of the EUT. A power meter was used to read the response of the power sensor. Record the power level.

##### 4.4.4 DEVIATION FROM TEST STANDARD

No deviation



#### 4.4.5 TEST SETUP

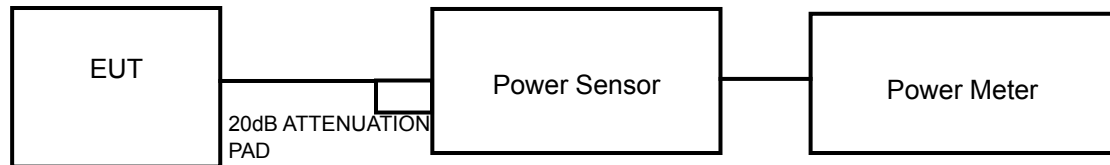

#### 4.4.6 EUT OPERATING CONDITIONS

Same as Item 4.3.6

#### 4.4.7 TEST RESULTS

##### 802.11b DSSS MODULATION: 1TX

<b>MODULATION TYPE</b>	DBPSK	<b>TRANSFER RATE</b>	1.0Mbps
<b>INPUT POWER</b>	120Vac, 60 Hz	<b>ENVIRONMENTAL CONDITIONS</b>	25deg.C, 65%RH, 991hPa
<b>TESTED BY</b>	Lori Chiu		

CHAN	CHANNEL FREQUENCY (MHz)	PEAK POWER OUTPUT (mW)	PEAK POWER OUTPUT (dBm)	PEAK POWER LIMIT (dBm)	PASS/FAIL
1	2412	79.799	19.02	30	PASS
6	2437	71.450	18.54	30	PASS
11	2462	80.538	19.06	30	PASS

##### 802.11g OFDM MODULATIO: 1TX

<b>MODULATION TYPE</b>	BPSK	<b>TRANSFER RATE</b>	6.0Mbps
<b>INPUT POWER</b>	120Vac, 60 Hz	<b>ENVIRONMENTAL CONDITIONS</b>	25deg.C, 65%RH, 991hPa
<b>TESTED BY</b>	Lori Chiu		

CHAN	CHANNEL FREQUENCY (MHz)	PEAK POWER OUTPUT (mW)	PEAK POWER OUTPUT (dBm)	PEAK POWER LIMIT (dBm)	PASS/FAIL
1	2412	252.930	24.03	30	PASS
6	2437	256.448	24.09	30	PASS
11	2462	199.986	23.01	30	PASS



A D T

**DRAFT 802.11n (20MHz) OFDM MODULATION: 1TX**

<b>MODULATION TYPE</b>	BPSK	<b>TRANSFER RATE</b>	7.2Mbps
<b>INPUT POWER</b>	120Vac, 60 Hz	<b>ENVIRONMENTAL CONDITIONS</b>	25deg.C, 65%RH, 991hPa
<b>TESTED BY</b>	Lori Chiu		

CHAN	CHANNEL FREQUENCY (MHz)	PEAK POWER OUTPUT (mW)	PEAK POWER OUTPUT (dBm)	PEAK POWER LIMIT (dBm)	PASS/FAIL
1	2412	252.348	24.02	30	PASS
6	2437	254.683	24.06	30	PASS
11	2462	254.097	24.05	30	PASS

**DRAFT 802.11n (20MHz) OFDM MODULATION: 2TX**

<b>MODULATION TYPE</b>	BPSK	<b>TRANSFER RATE</b>	14.4Mbps
<b>INPUT POWER</b>	120Vac, 60 Hz	<b>ENVIRONMENTAL CONDITIONS</b>	25deg.C, 65%RH, 991hPa
<b>TESTED BY</b>	Lori Chiu		

CHANNEL	CHANNEL FREQUENCY (MHz)	PEAK POWER OUTPUT (dBm)		TOTAL PEAK POWER (mW)	TOTAL PEAK POWER (dBm)	PEAK POWER LIMIT (dBm)	PASS / FAIL
		CHAIN 0	CHAIN 1				
1	2412	18.02	18.03	126.920	21.04	30	PASS
6	2437	19.01	19.06	160.154	22.05	30	PASS
11	2462	19.03	19.07	160.707	22.06	30	PASS

**DRAFT 802.11n (40MHz) OFDM MODULATION: 1TX**

<b>MODULATION TYPE</b>	BPSK	<b>TRANSFER RATE</b>	15.0Mbps
<b>INPUT POWER</b>	120Vac, 60 Hz	<b>ENVIRONMENTAL CONDITIONS</b>	25deg.C, 65%RH, 991hPa
<b>TESTED BY</b>	Lori Chiu		

CHAN	CHANNEL FREQUENCY (MHz)	PEAK POWER OUTPUT (mW)	PEAK POWER OUTPUT (dBm)	PEAK POWER LIMIT (dBm)	PASS/FAIL
1	2422	200.447	23.02	30	PASS
4	2437	203.236	23.08	30	PASS
7	2452	159.956	22.04	30	PASS

**DRAFT 802.11n (40MHz) OFDM MODULATION: 2TX**

<b>MODULATION TYPE</b>	BPSK	<b>TRANSFER RATE</b>	30.0.Mbps
<b>INPUT POWER</b>	120Vac, 60 Hz	<b>ENVIRONMENTAL CONDITIONS</b>	25deg.C, 65%RH, 991hPa
<b>TESTED BY</b>	Lori Chiu		

CHANNEL	CHANNEL FREQUENCY (MHz)	PEAK POWER OUTPUT (dBm)		TOTAL PEAK POWER (mW)	TOTAL PEAK POWER (dBm)	PEAK POWER LIMIT (dBm)	PASS / FAIL
		CHAIN 0	CHAIN 1				
1	2422	18.02	18.09	127.804	21.07	30	PASS
4	2437	17.58	18.57	129.225	21.11	30	PASS
7	2452	17.53	18.12	121.487	20.85	30	PASS

## 4.5 POWER SPECTRAL DENSITY MEASUREMENT

### 4.5.1 LIMITS OF POWER SPECTRAL DENSITY MEASUREMENT

The Maximum of Power Spectral Density Measurement is 8dBm.

### 4.5.2 TEST INSTRUMENTS

DESCRIPTION & MANUFACTURER	MODEL NO.	SERIAL NO.	DATE OF CALIBRATION	DUE DATE OF CALIBRATION
SPECTRUM ANALYZER	FSP40	100040	Jul. 04, 2008	Jul. 03, 2009

**NOTE:** The calibration interval of the above test instruments is 12 months and the calibrations are traceable to NML/ROC and NIST/USA.

### 4.5.3 TEST PROCEDURE

The transmitter output was connected to the spectrum analyzer through an attenuator, the bandwidth of the fundamental frequency was measured with the spectrum analyzer using 3kHz RBW and 30kHz VBW, set sweep time = span/3kHz. The power spectral density was measured and recorded.

The sweep time is allowed to be longer than span/3kHz for a full response of the mixer in the spectrum analyzer.

### 4.5.4 DEVIATION FROM TEST STANDARD

No deviation

#### 4.5.5 TEST SETUP

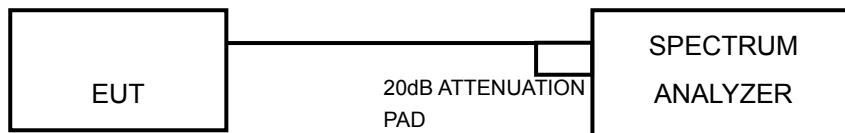

#### 4.5.6 EUT OPERATING CONDITION

Same as Item 4.3.6



A D T

### 4.5.7 TEST RESULTS

#### 802.11b DSSS MODULATION: TX

<b>MODULATION TYPE</b>	DBPSK	<b>TRANSFER RATE</b>	1.0Mbps
<b>INPUT POWER</b>	120Vac, 60 Hz	<b>ENVIRONMENTAL CONDITIONS</b>	25deg.C, 65%RH, 991hPa
<b>TESTED BY</b>	Lori Chiu		

CHANNEL	CHANNEL FREQUENCY (MHz)	RF POWER LEVEL IN 3 kHz BW (dBm)	MAXIMUM LIMIT (dBm)	PASS/FAIL
1	2412	-11.65	8	PASS
6	2437	-12.20	8	PASS
11	2462	-11.86	8	PASS

#### CH 1

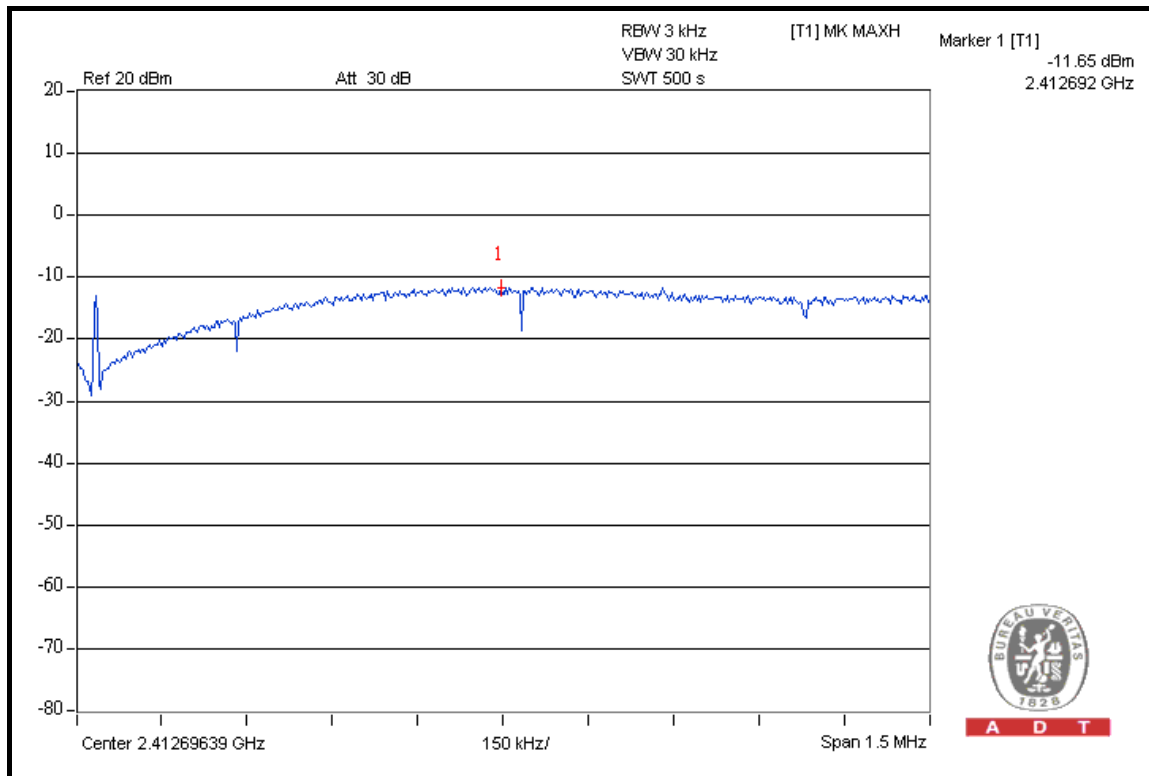

A D T



A D T

### CH 6

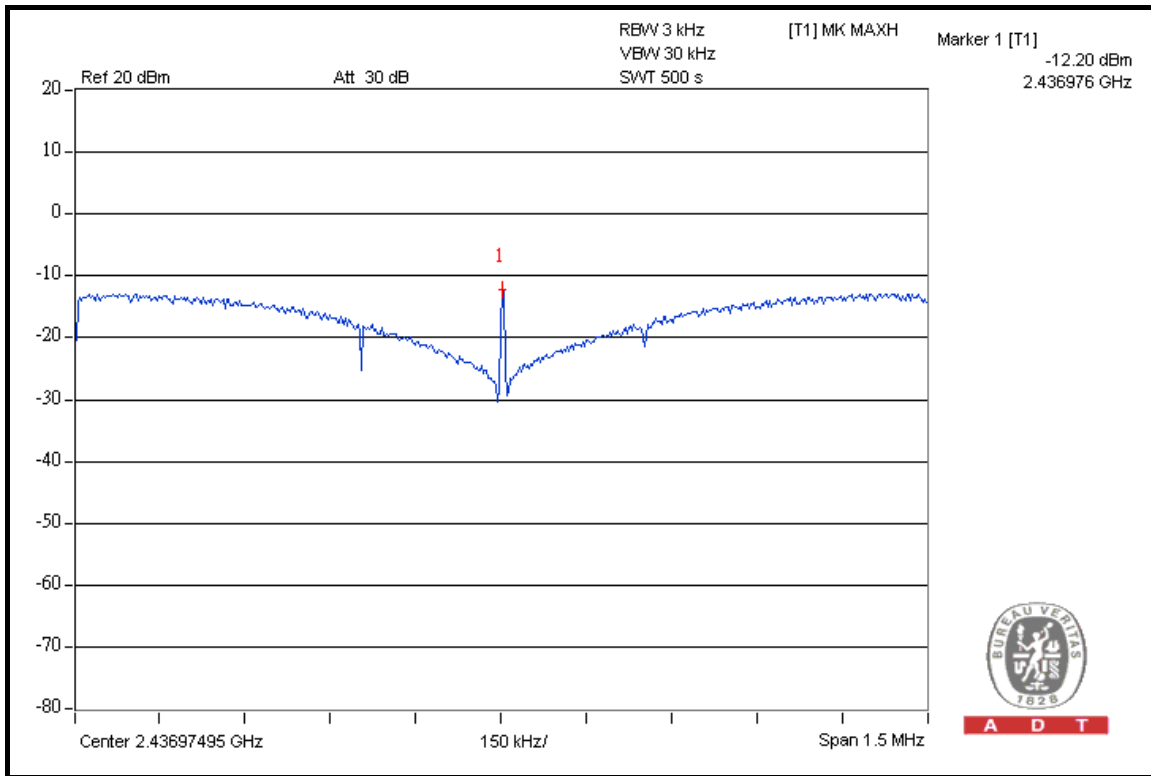

### CH 11

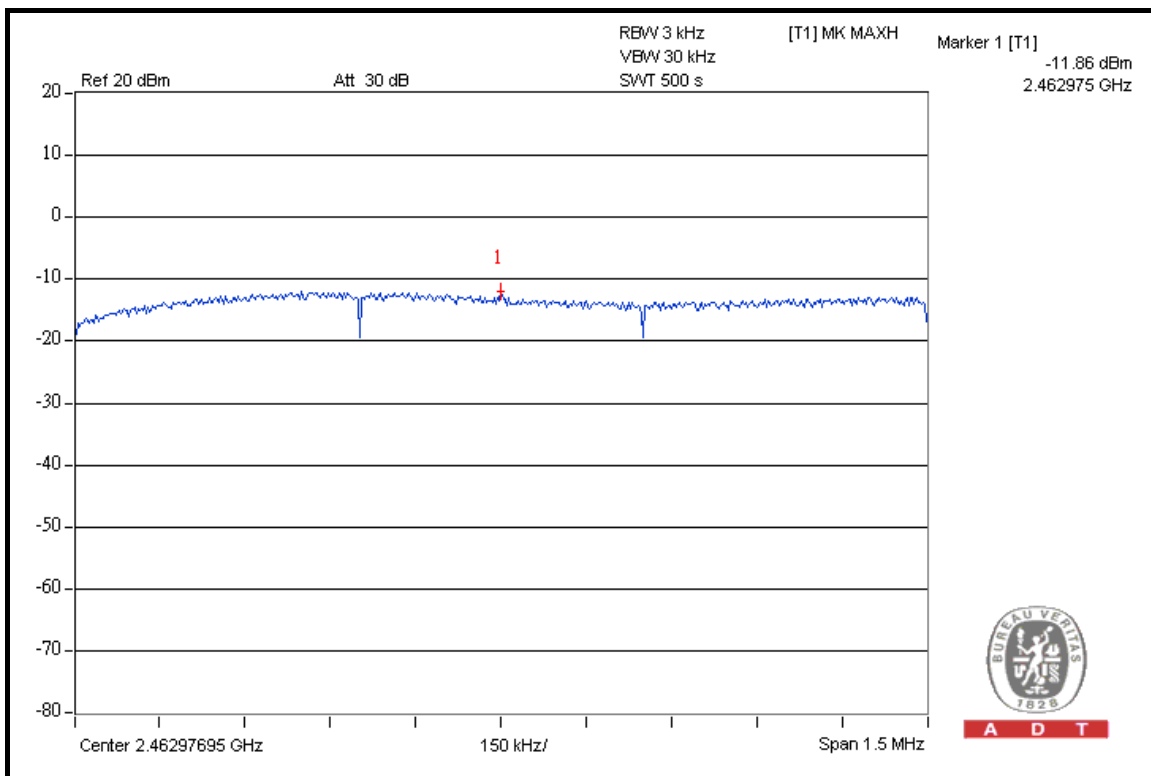





A D T

802.11g OFDM MODULATION: 1TX

<b>MODULATION TYPE</b>	BPSK	<b>TRANSFER RATE</b>	6.0Mbps
<b>INPUT POWER</b>	120Vac, 60 Hz	<b>ENVIRONMENTAL CONDITIONS</b>	25deg.C, 65%RH, 991hPa
<b>TESTED BY</b>	Lori Chiu		

CHANNEL	CHANNEL FREQUENCY (MHz)	RF POWER LEVEL IN 3 kHz BW (dBm)	MAXIMUM LIMIT (dBm)	PASS/FAIL
1	2412	-12.86	8	PASS
6	2437	-12.72	8	PASS
11	2462	-13.62	8	PASS

CH 1

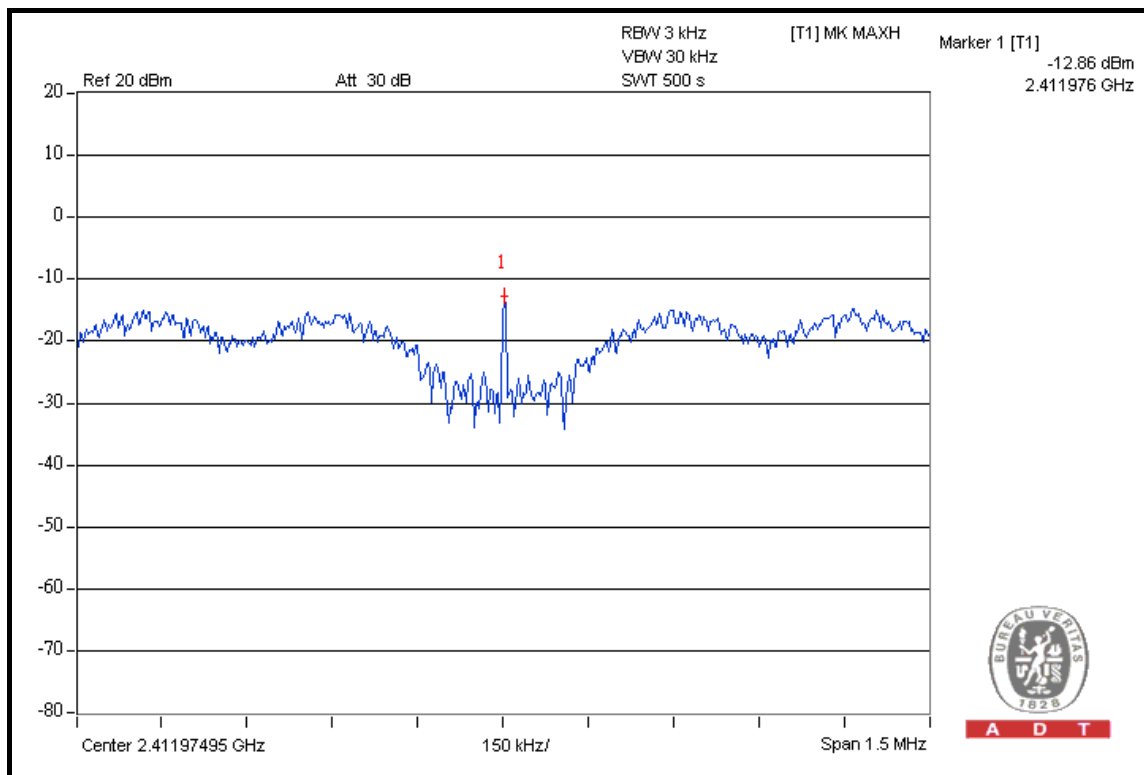



A D T

### CH 6

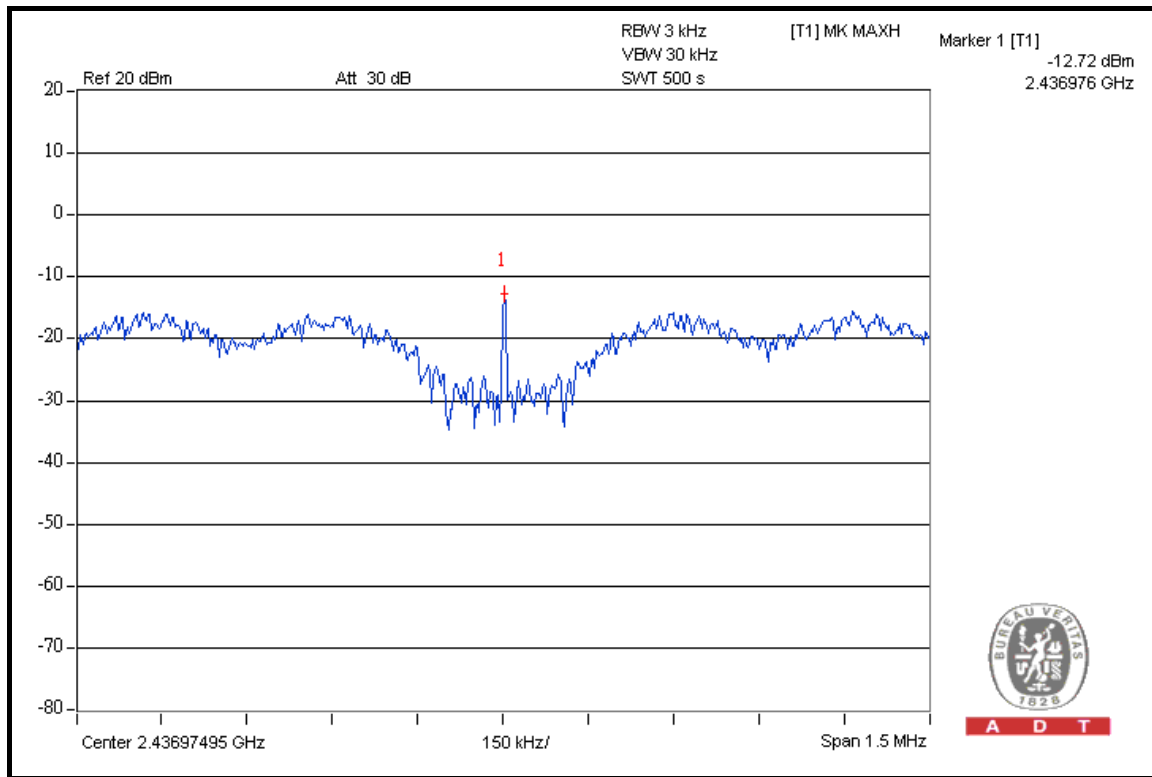

### CH 11

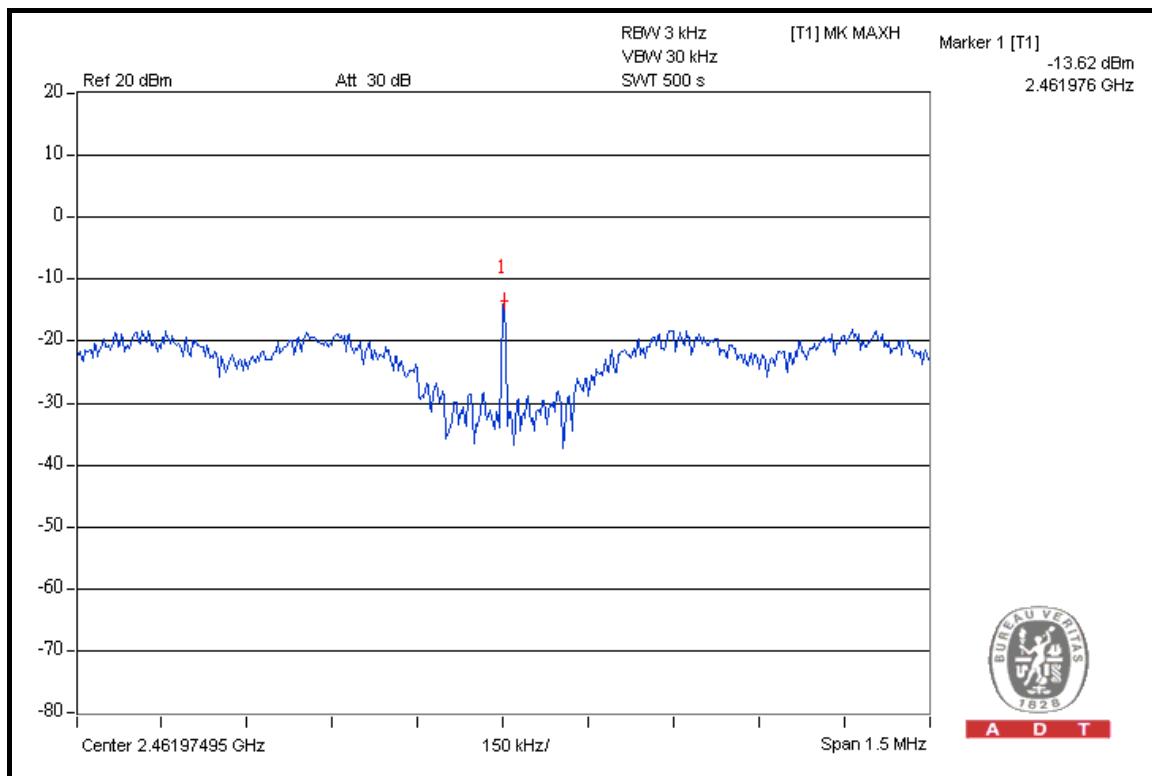



A D T

### DRAFT 802.11n (20MHz) OFDM MODULATION: 1TX

<b>MODULATION TYPE</b>	BPSK	<b>TRANSFER RATE</b>	7.2Mbps
<b>INPUT POWER</b>	120Vac, 60 Hz	<b>ENVIRONMENTAL CONDITIONS</b>	25deg.C, 65%RH, 991hPa
<b>TESTED BY</b>	Lori Chiu		

CHANNEL	CHANNEL FREQUENCY (MHz)	RF POWER LEVEL IN 3 kHz BW (dBm)	MAXIMUM LIMIT (dBm)	PASS/FAIL
1	2412	-12.88	8	PASS
6	2437	-12.74	8	PASS
11	2462	-12.69	8	PASS

### CH 1

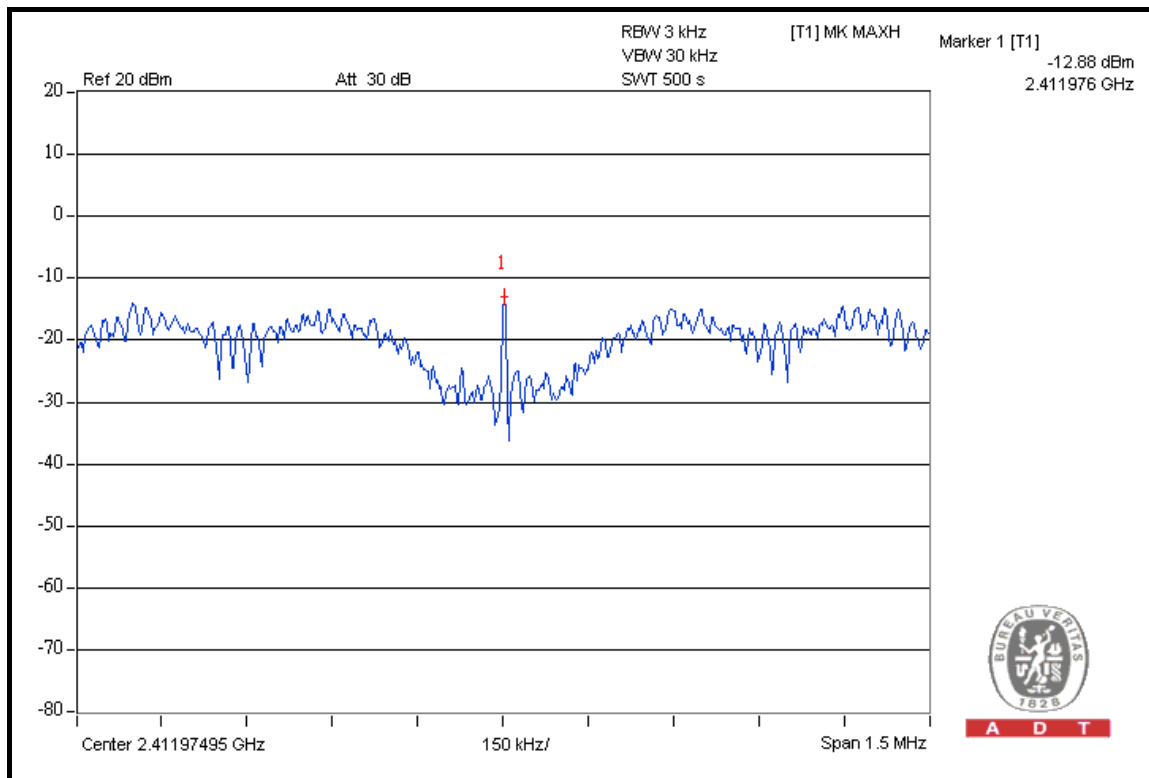

A D T



A D T

### CH 6

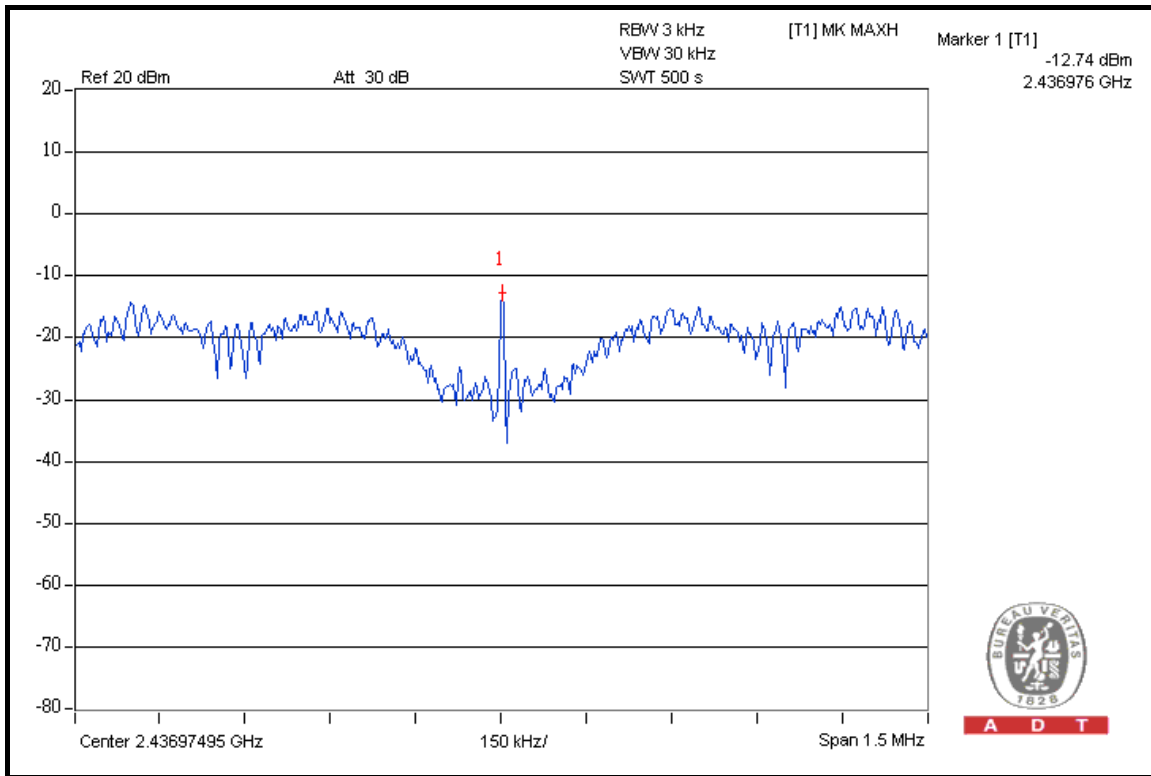

### CH 11

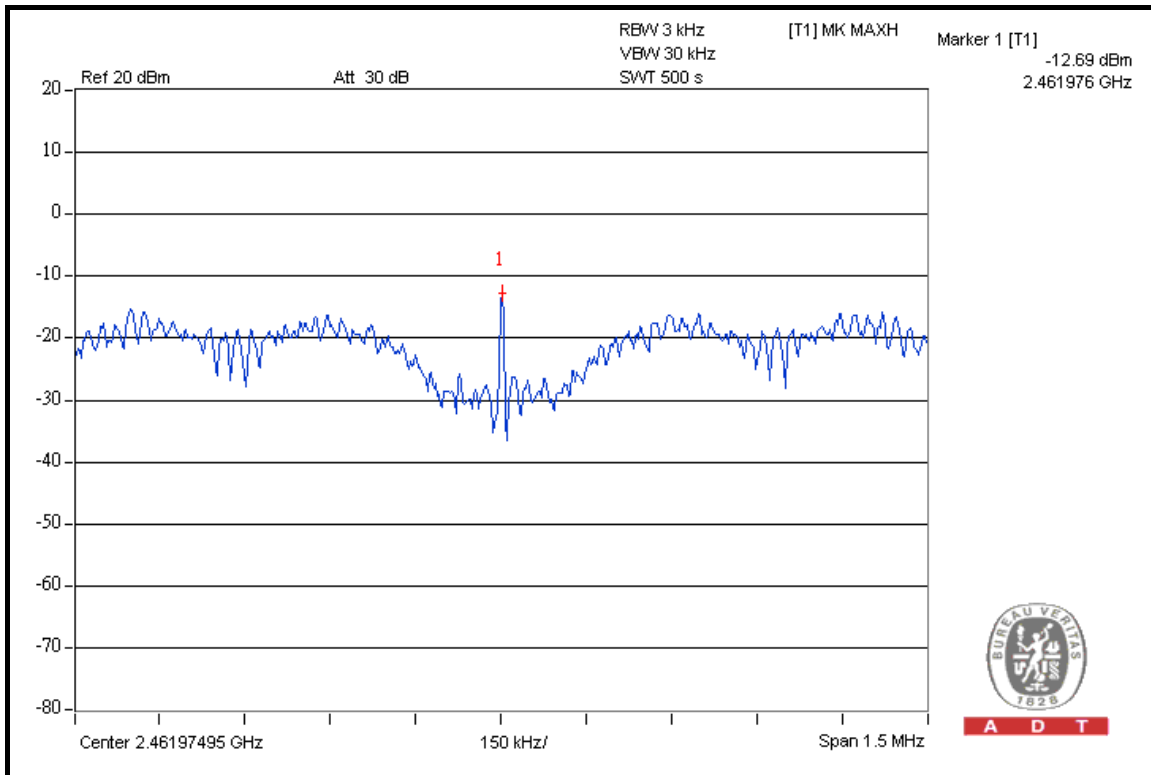



A D T

**DRAFT 802.11n (20MHz) OFDM MODULATION: 2TX**

<b>MODULATION TYPE</b>	BPSK	<b>TRANSFER RATE</b>	14.4Mbps
<b>INPUT POWER</b>	120Vac, 60 Hz	<b>ENVIRONMENTAL CONDITIONS</b>	25deg.C, 65%RH, 991hPa
<b>TESTED BY</b>	Lori Chiu		

CHANNEL	CHANNEL FREQUENCY (MHz)	RF POWER LEVEL IN 3kHz BW (dBm)		TOTAL POWER DENSITY (mW)	TOTAL POWER DENSITY (dBm)	MAX. LIMIT (dBm)	PASS / FAIL
		CHAIN 0	CHAIN 1				
1	2412	-13.37	-19.98	0.056	-12.51	8	PASS
6	2437	-12.54	-18.99	0.068	-11.65	8	PASS
11	2462	-12.53	-19.10	0.068	-11.67	8	PASS



A D T

### FOR CHAIN 0: CH 1

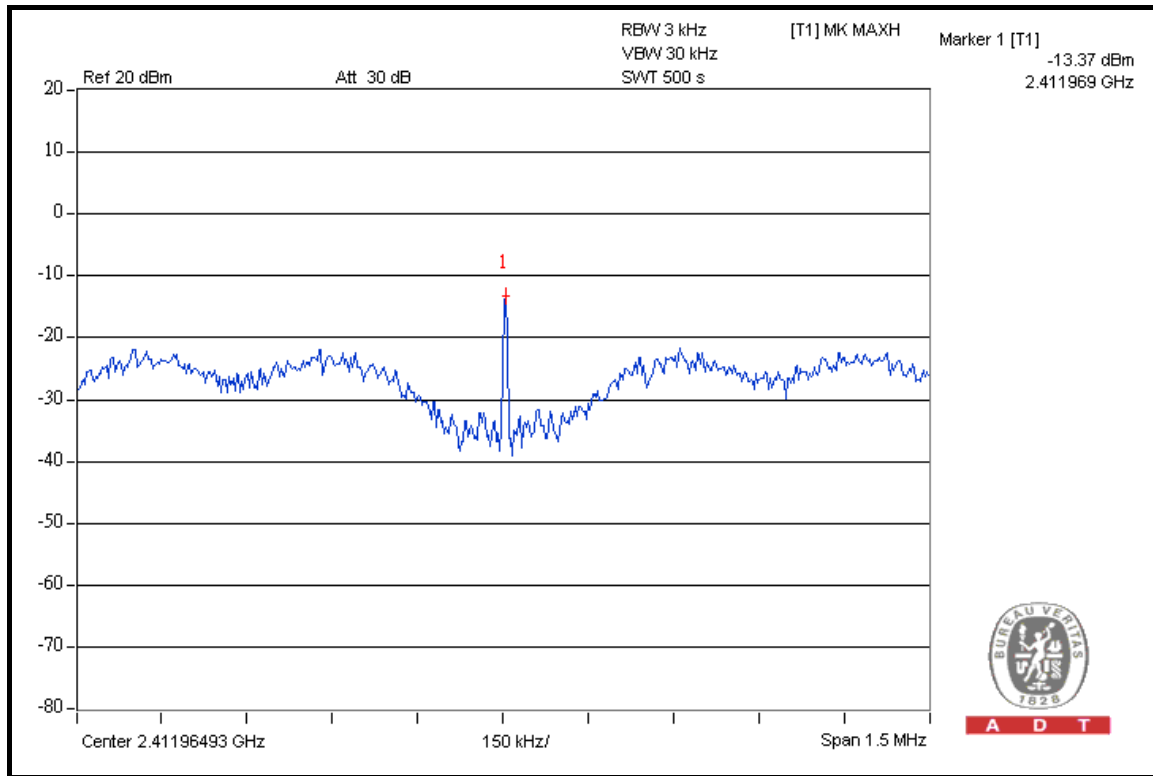

### CH 6

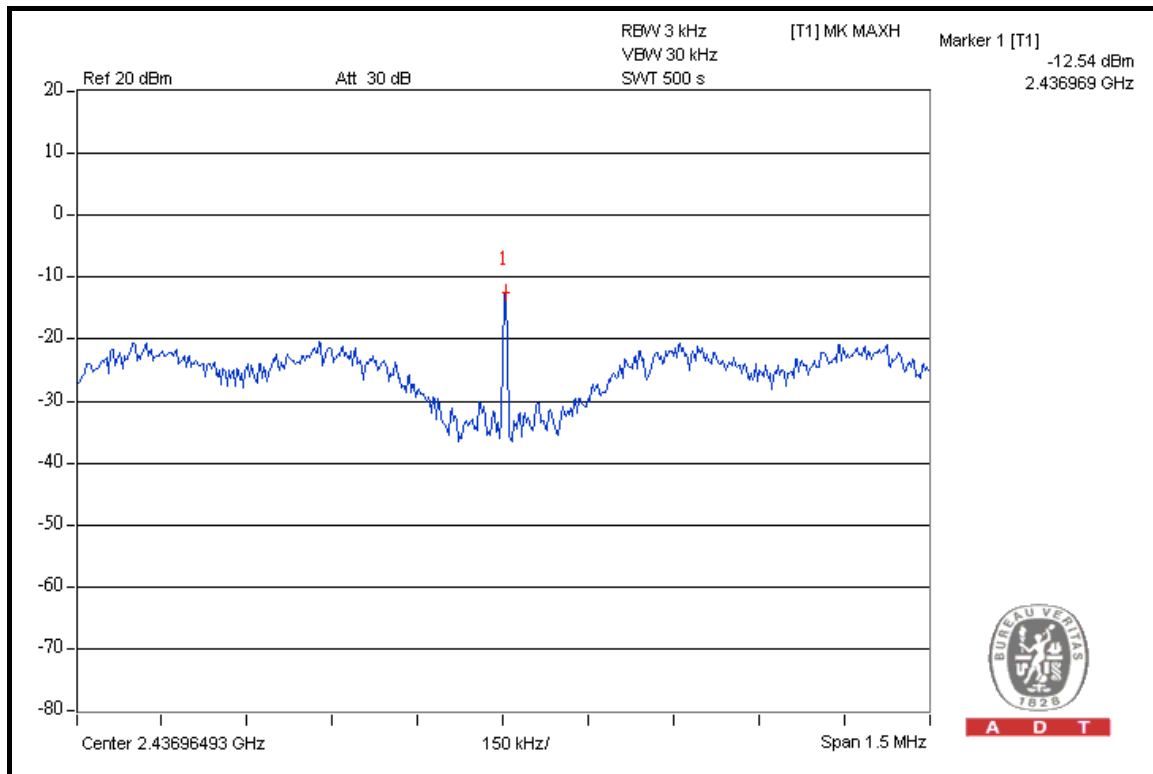



A D T

### CH 11

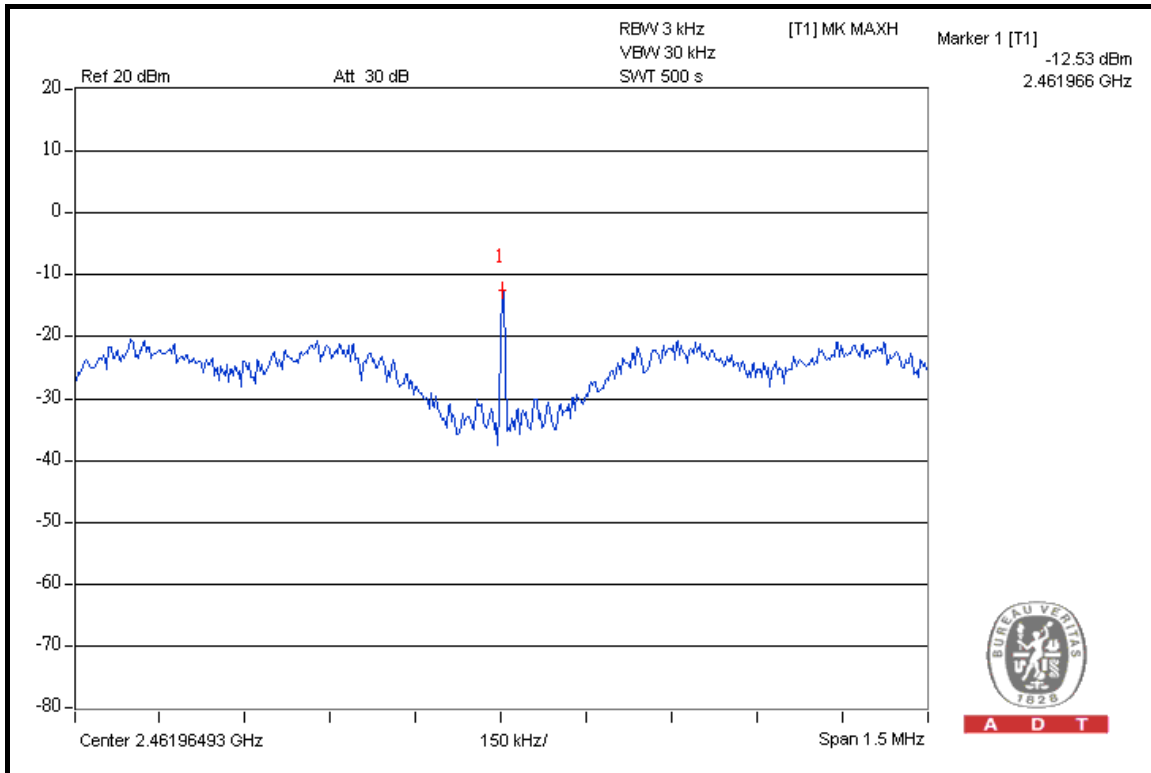

### FOR CHAIN 1: CH 1

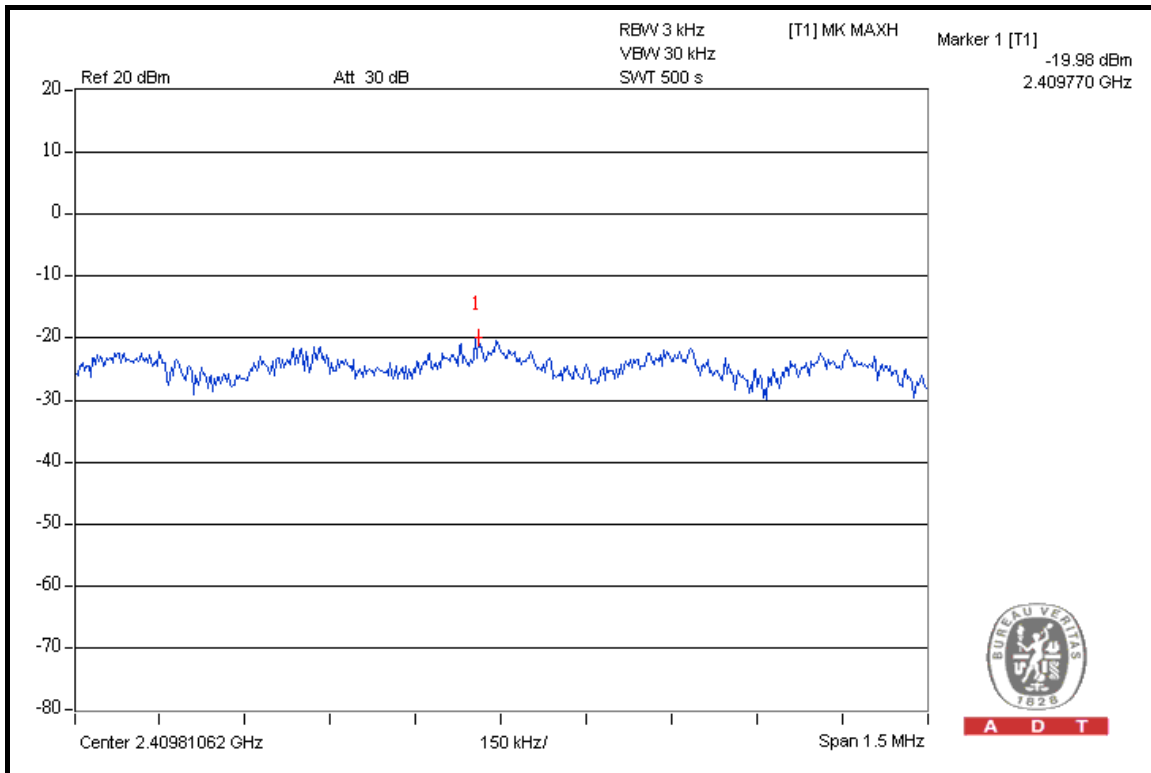



A D T

### CH 6

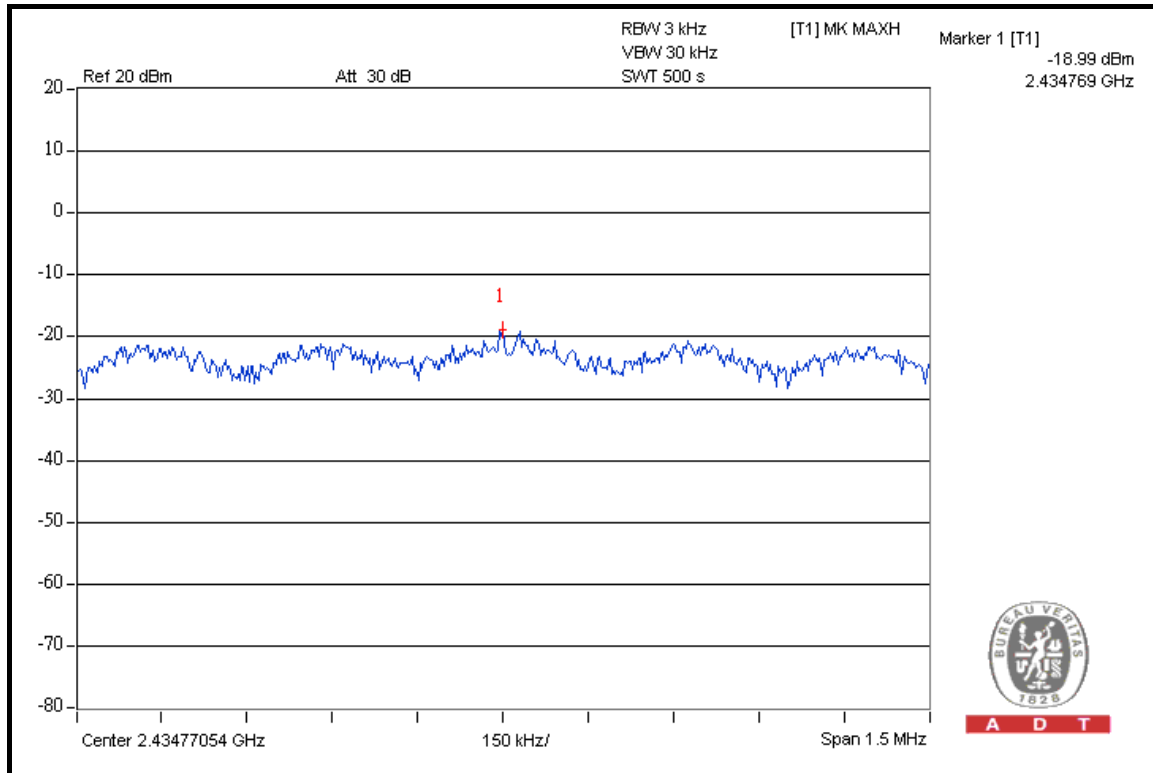

### CH 11

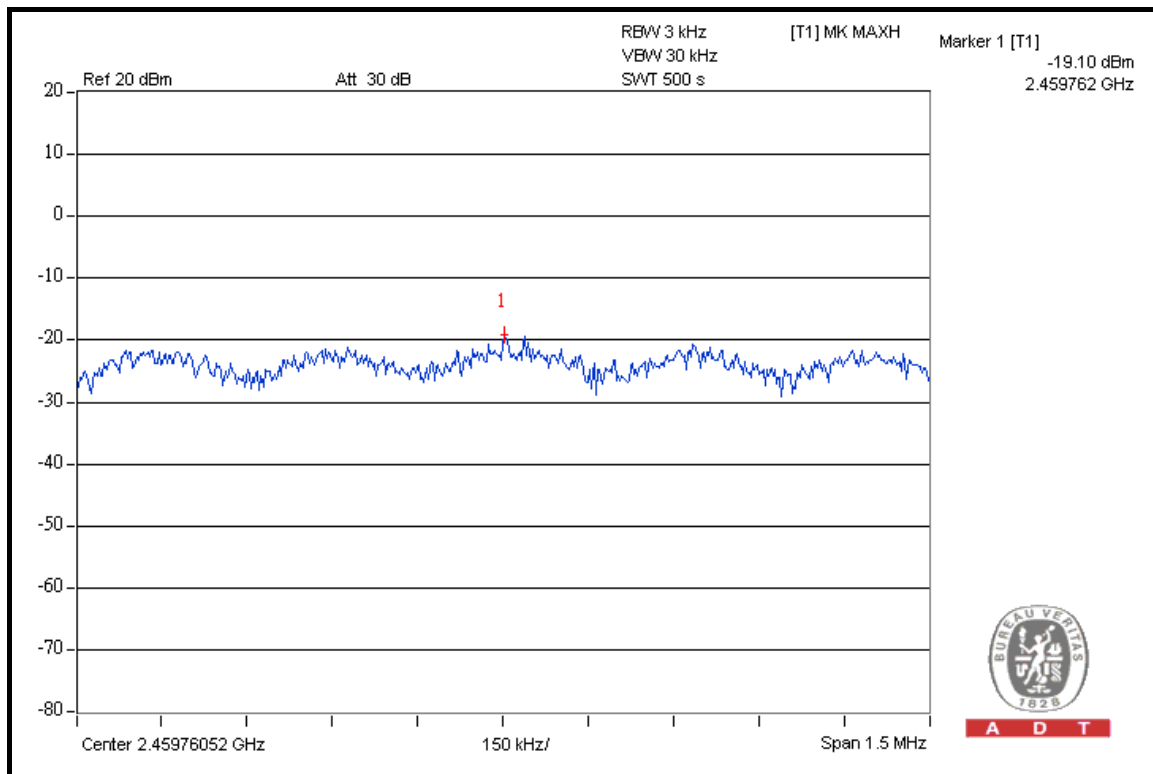





A D T

### DRAFT 802.11n (40MHz) OFDM MODULATION: 1TX

<b>MODULATION TYPE</b>	BPSK	<b>TRANSFER RATE</b>	15.0Mbps
<b>INPUT POWER</b>	120Vac, 60 Hz	<b>ENVIRONMENTAL CONDITIONS</b>	25deg.C, 65%RH, 991hPa
<b>TESTED BY</b>	Lori Chiu		

CHANNEL	CHANNEL FREQUENCY (MHz)	RF POWER LEVEL IN 3 kHz BW (dBm)	MAXIMUM LIMIT (dBm)	PASS/FAIL
1	2422	-12.75	8	PASS
4	2437	-12.52	8	PASS
7	2452	-13.51	8	PASS

### CH 1

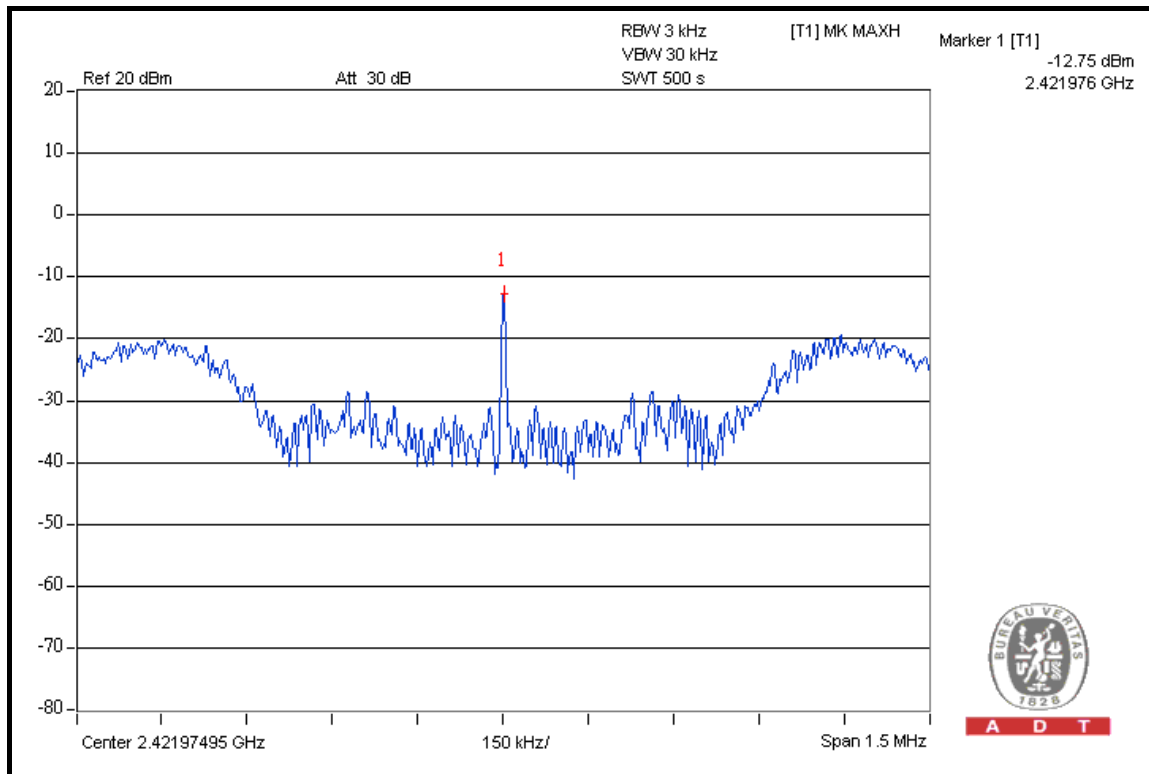

A D T



A D T

### CH 4

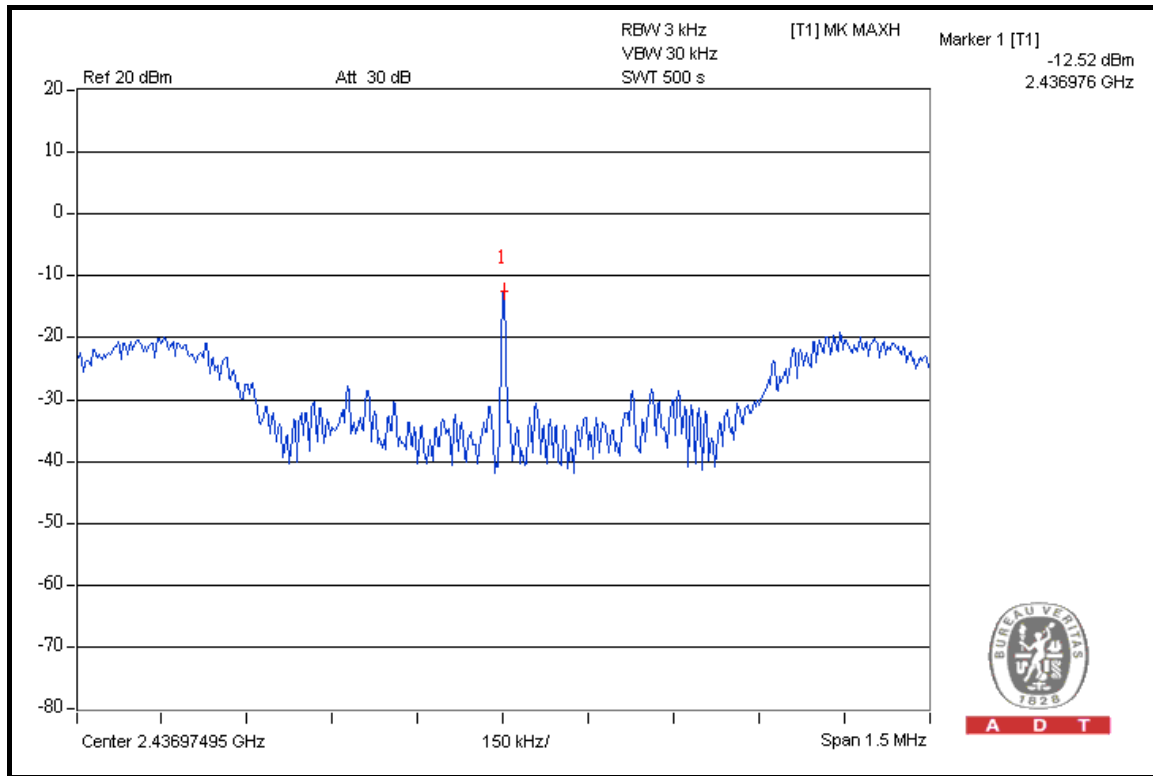

### CH 7

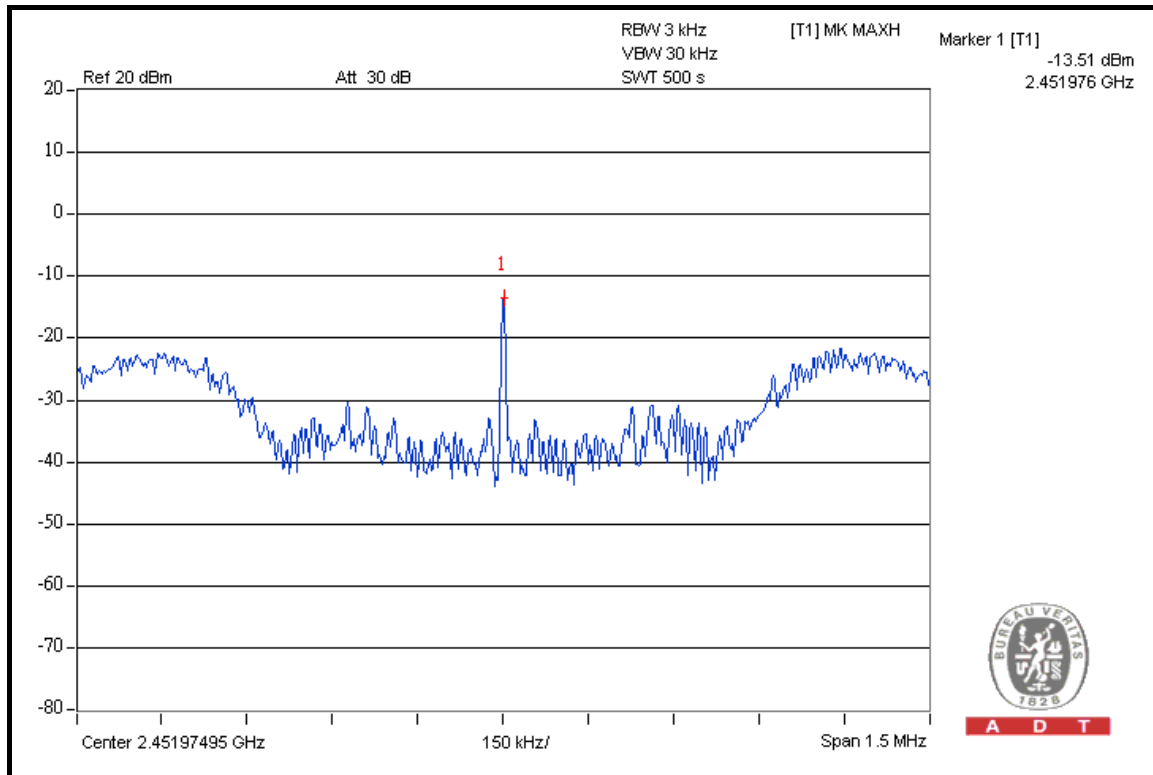



A D T

**DRAFT 802.11n (40MHz) OFDM MODULATION: 2TX**

<b>MODULATION TYPE</b>	BPSK	<b>TRANSFER RATE</b>	30.0Mbps
<b>INPUT POWER</b>	120Vac, 60 Hz	<b>ENVIRONMENTAL CONDITIONS</b>	25deg.C, 65%RH, 991hPa
<b>TESTED BY</b>	Lori Chiu		

CHANNEL	CHANNEL FREQUENCY (MHz)	RF POWER LEVEL IN 3kHz BW (dBm)		TOTAL POWER DENSITY (mW)	TOTAL POWER DENSITY (dBm)	MAX. LIMIT (dBm)	PASS / FAIL
		CHAIN 0	CHAIN 1				
1	2422	-13.47	-23.16	0.050	-13.03	8	PASS
4	2437	-13.85	-22.57	0.047	-13.30	8	PASS
7	2452	-13.81	-22.94	0.047	-13.31	8	PASS



A D T

### FOR CHAIN 0: CH 1

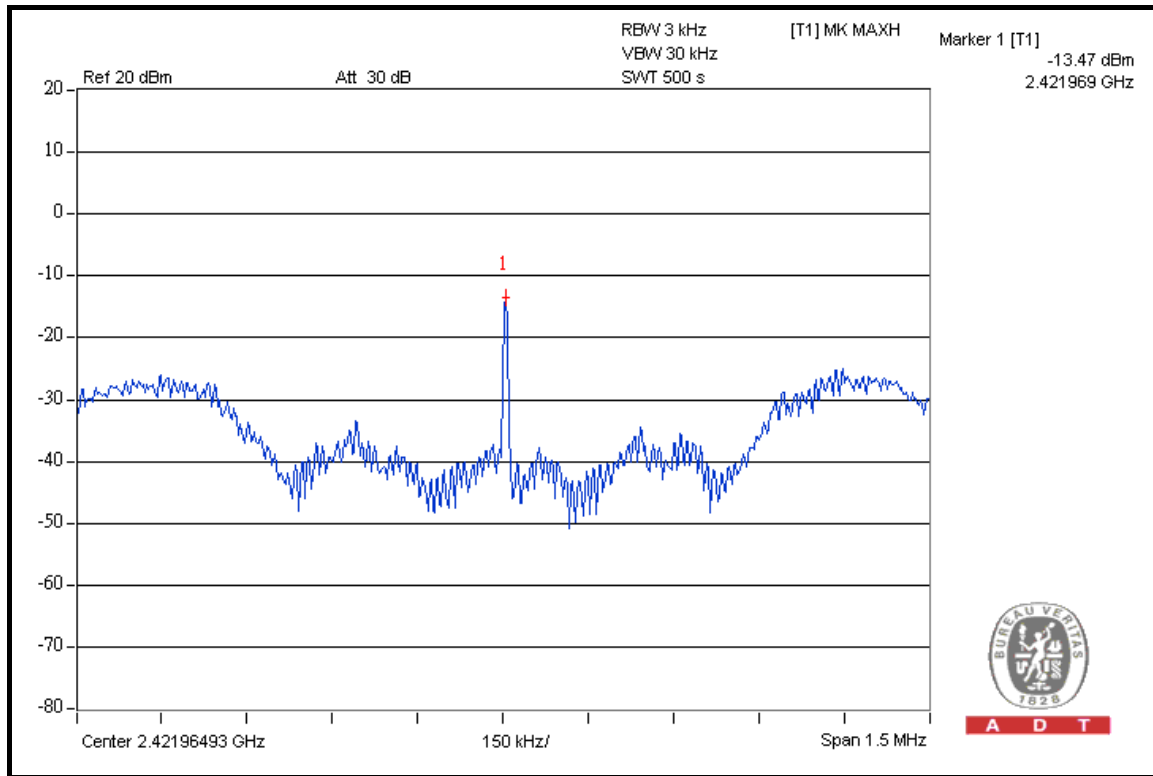

### CH 4

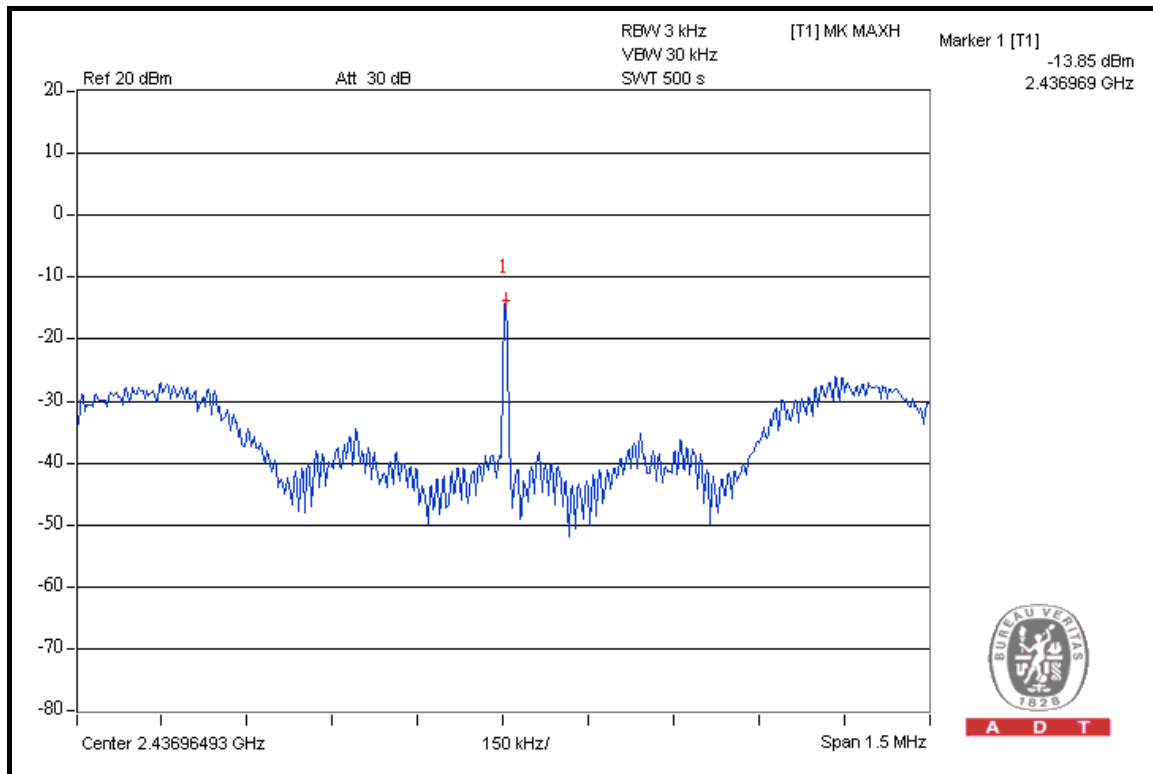



A D T

### CH 7

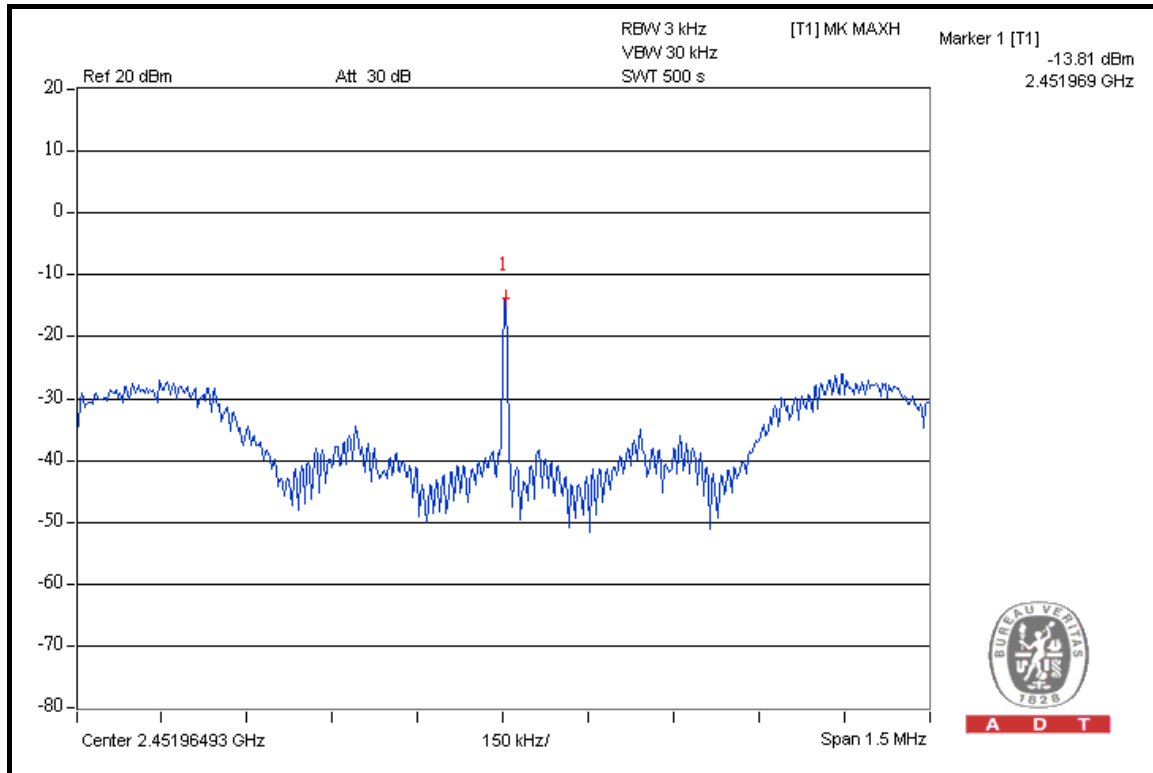

### FOR CHAIN 1: CH 1

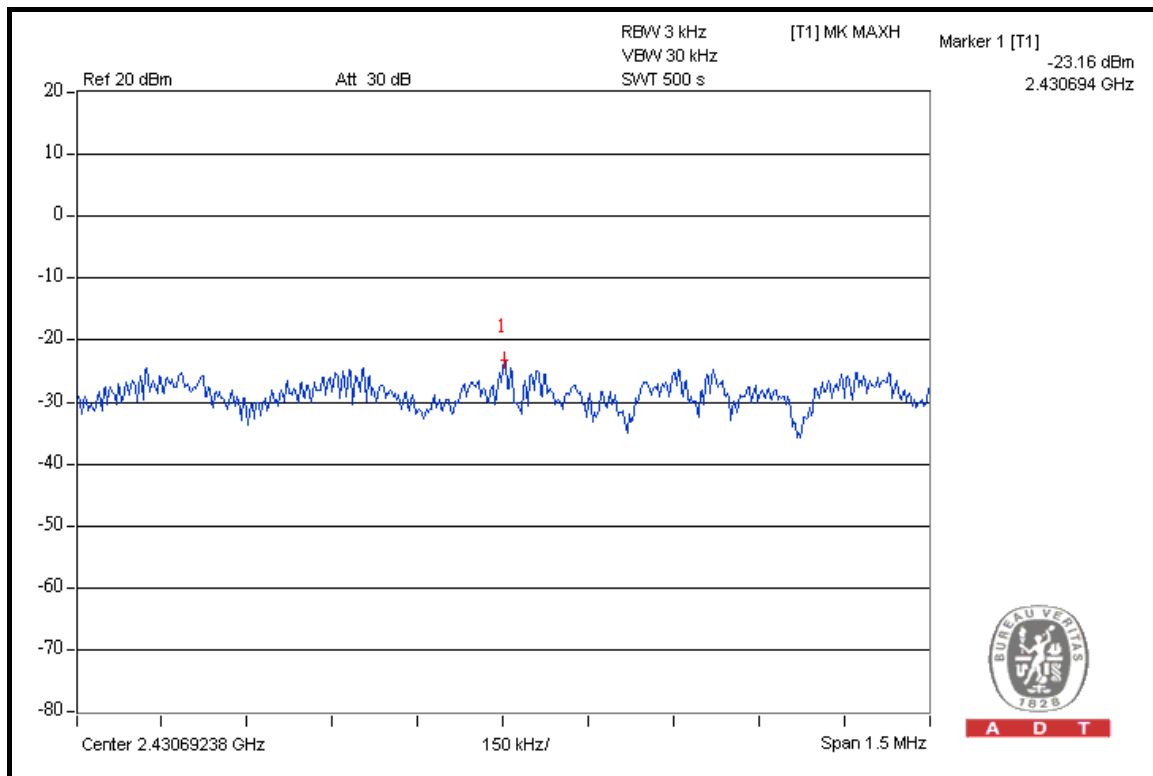



A D T

### CH 4

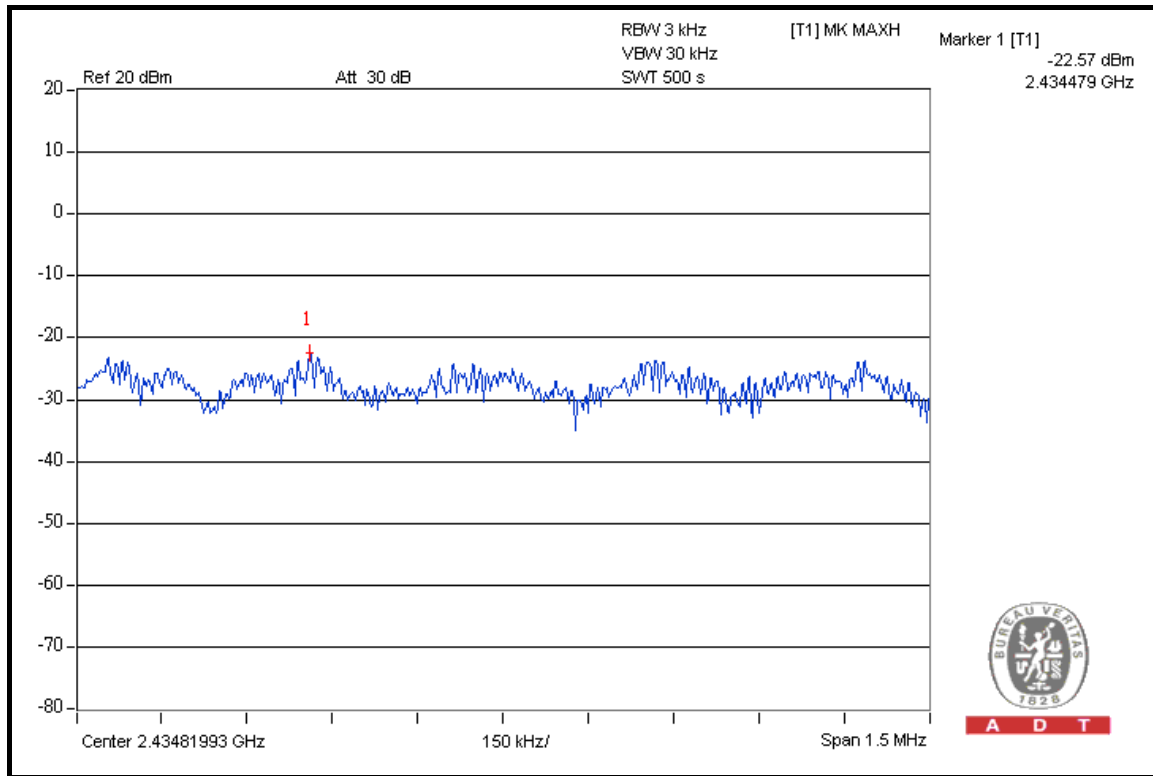

### CH 7

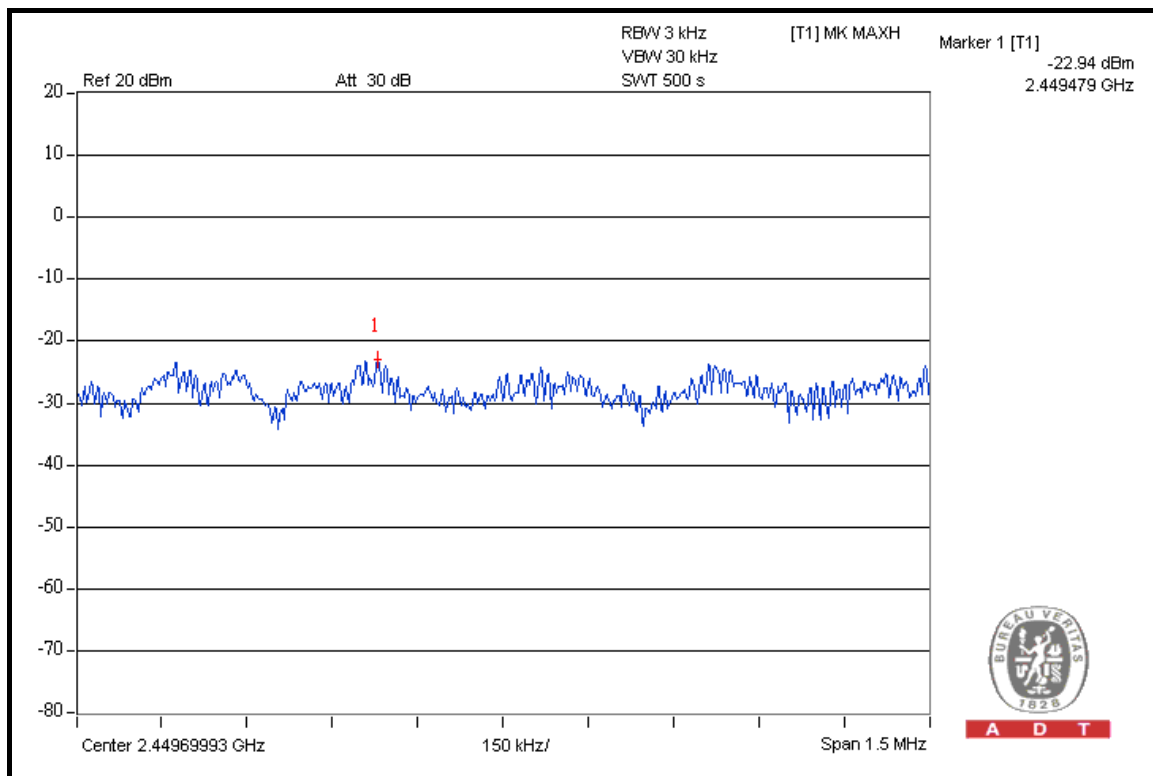

## 4.6 BAND EDGES MEASUREMENT

### 4.6.1 LIMITS OF BAND EDGES MEASUREMENT

Below –20dB of the highest emission level of operating band (in 100kHz Resolution Bandwidth).

### 4.6.2 TEST INSTRUMENTS

DESCRIPTION & MANUFACTURER	MODEL NO.	SERIAL NO.	DATE OF CALIBRATION	DUE DATE OF CALIBRATION
<b>FOR CONDUCTED MEASUREMENT</b>				
SPECTRUM ANALYZER	FSP40	100040	Jul. 04, 2008	Jul. 03, 2009
<b>FOR RADIATED MEASUREMENT</b>				
Test Receiver ROHDE & SCHWARZ	ESIB7	100212	May 28, 2008	May 27, 2009
Spectrum Analyzer ROHDE & SCHWARZ	FSP40	100269	Aug. 08, 2008	Aug. 07, 2009
BILOG Antenna SCHWARZBECK	VULB9168	9168-155	Apr. 30, 2008	Apr. 28, 2010
HORN Antenna SCHWARZBECK	BBHA 9170	BBHA9170242	Jan. 06, 2009	Jan. 05, 2010
Preamplifier Agilent	8449B	3008A01911	Sep. 10, 2008	Sep. 09, 2009
Preamplifier Agilent	8447D	2944A10638	Dec. 26, 2008	Dec. 25, 2009
RF signal cable HUBER+SUHNNER	SUCOFLEX 104	218190/4 231241/4	Aug. 21, 2008	Aug. 20, 2009
RF signal cable Worken	8D-FB	Cable-HYCH9-01	Aug. 09, 2008	Aug. 08, 2009
Software	ADT_Radiated_ V7.6.15.9.2	NA	NA	NA
Antenna Tower EMCO	2070/2080	512.835.4684	NA	NA
Turn Table EMCO	2087-2.03	NA	NA	NA
Antenna Tower & Turn Table Controller EMCO	2090	NA	NA	NA

**NOTE:** The calibration interval of the above test instruments is 12 months and the calibrations are traceable to NML/ROC and NIST/USA.

### 4.6.3 TEST PROCEDURE

#### FOR CONDUCTED MEASUREMENT

The transmitter output was connected to the spectrum analyzer via a low lose cable. Set both RBW and VBW of spectrum analyzer to 100kHz and 300kHz with suitable frequency span including 100MHz bandwidth from band edge. The band edges was measured and recorded.

The spectrum plots (Peak RBW = 100kHz, VBW = 300kHz; Average RBW = 1MHz, VBW = 10Hz) are attached on the following pages.

#### FOR RADIATED MEASUREMENT

- a. The EUT was placed on the top of a rotating table 0.8 meters above the ground at a 3 meter semi-anechoic chamber. The table was rotated 360 degrees to determine the position of the highest radiation.
- b. The EUT was set 3 meters away from the interference-receiving antenna, which was mounted on the top of a variable-height antenna tower.
- c. The antenna is a broadband antenna, and its height is varied from one meter to four meters above the ground to determine the maximum value of the field strength. Both horizontal and vertical polarizations of the antenna are set to make the measurement.
- d. For each suspected emission, the EUT was arranged to its worst case and then the antenna was tuned to heights from 1 meter to 4 meters and the rotatable table was turned from 0 degrees to 360 degrees to find the maximum reading.
- e. Set both RBW and VBW of spectrum analyzer to 100kHz with suitable frequency span including 100MHz bandwidth from band edge. The band edges was measured and recorded.

The spectrum plots (Peak RBW = 100kHz, VBW = 300kHz; Average RBW = 1MHz, VBW = 10Hz)

### 4.6.4 DEVIATION FROM TEST STANDARD

No deviation



#### 4.6.5 EUT OPERATING CONDITION

Same as Item 4.3.6

#### 4.6.6 TEST RESULTS

The spectrum plots are attached on the following 24 images. D1 line indicates the highest level, and D2 line indicates the 20dB offset below D1. It shows compliance with the requirement in part 15.247(d).

##### 802.11b DSSS MODULATION: 1TX

**NOTE 1:** The band edge emission plot on the next page shows 54.79dBc between carrier maximum power and local maximum emission in restrict band (2.387130GHz). The emission of carrier strength list in the test result of channel 1 at the item 4.1.7 is 112.88dBuV/m (Peak), so the maximum field strength in restrict band is  $112.88 - 54.79 = 58.09$ dBuV/m which is under 74dBuV/m limit.

The band edge emission plot on the next page shows 57.01dBc between carrier maximum power and local maximum emission in restrict band (2.386930GHz). The emission of carrier strength list in the test result of channel 1 at the item 4.1.7 is 108.06dBuV/m (Average), so the maximum field strength in restrict band is  $108.06 - 57.01 = 51.05$ dBuV/m which is under 54dBuV/m limit.

**NOTE 2:** The band edge emission plot on the next second page shows 53.89dBc between carrier maximum power and local maximum emission in restrict band (2.483864GHz). The emission of carrier strength list in the test result of channel 11 at the item 4.1.7 is 112.85dBuV/m (Peak), so the maximum field strength in restrict band is  $112.85 - 53.89 = 58.96$ dBuV/m which is under 74dBuV/m limit.

The band edge emission plot on the next third page shows 57.06dBc between carrier maximum power and local maximum emission in restrict band (2.483500GHz). The emission of carrier strength list in the test result of channel 11 at the item 4.1.7 is 108.24dBuV/m (Average), so the maximum field strength in restrict band is  $108.24 - 57.06 = 51.18$ dBuV/m which is under 54dBuV/m limit.



A D T

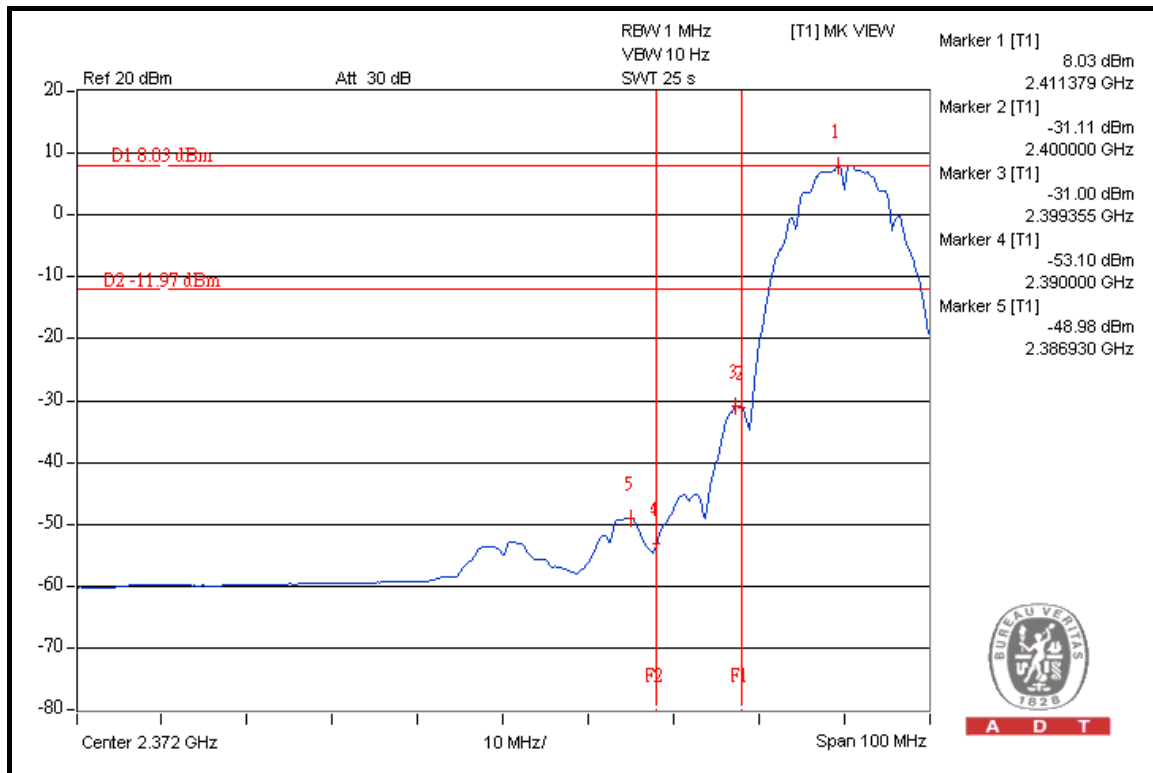
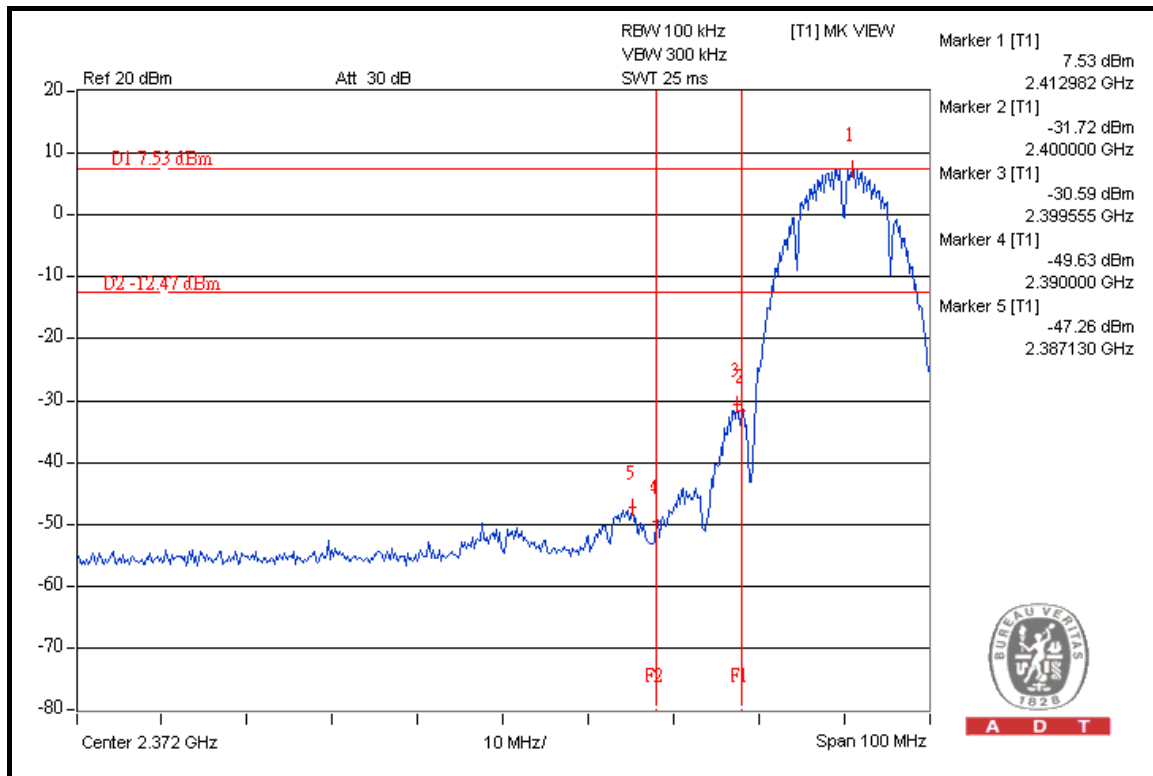



A D T

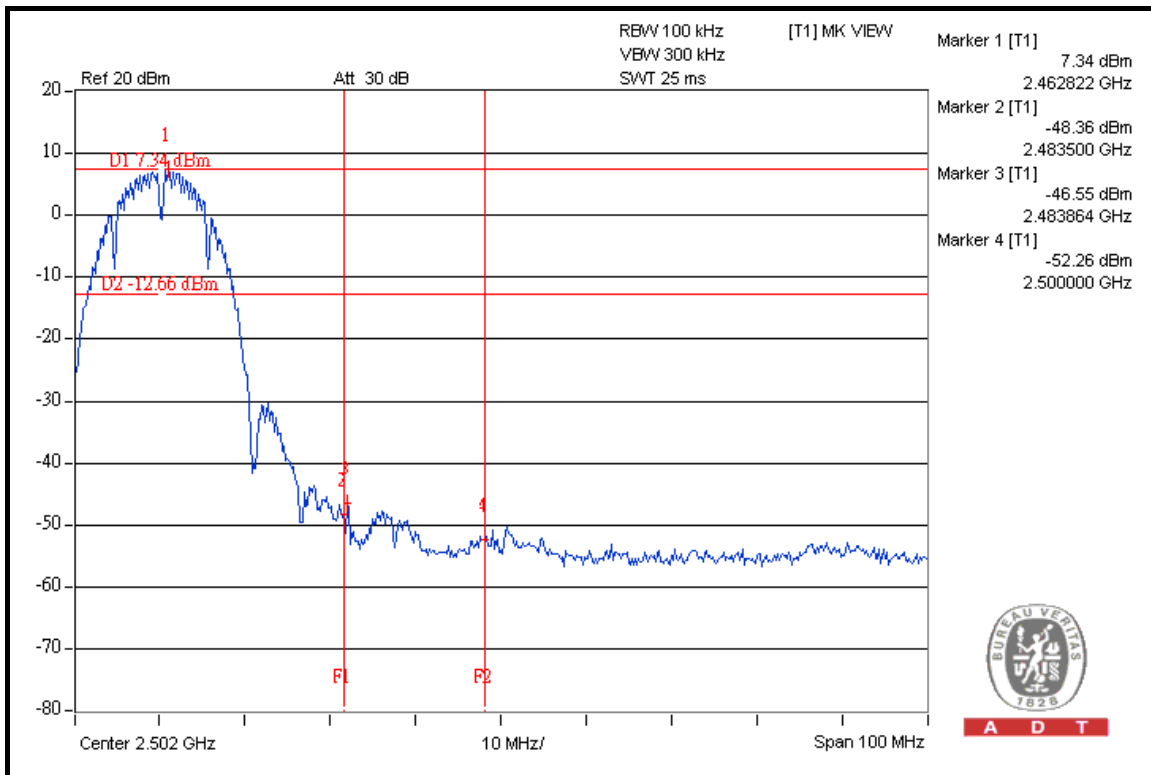
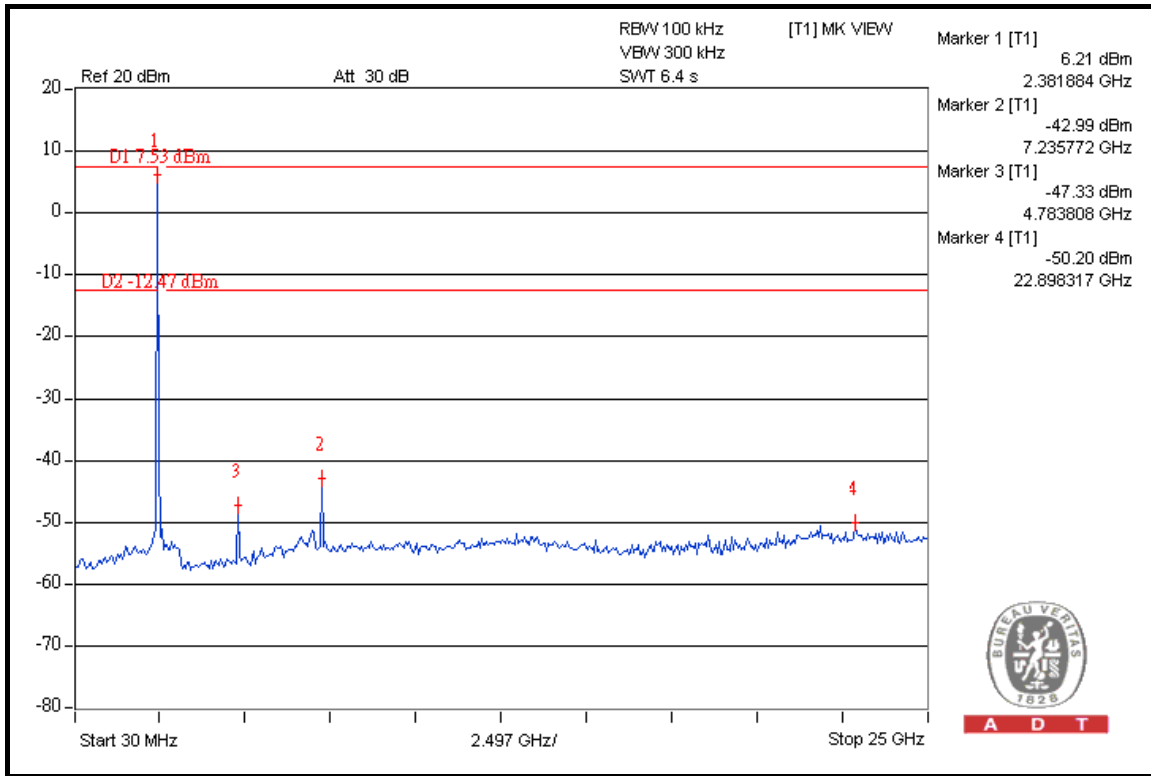



A D T

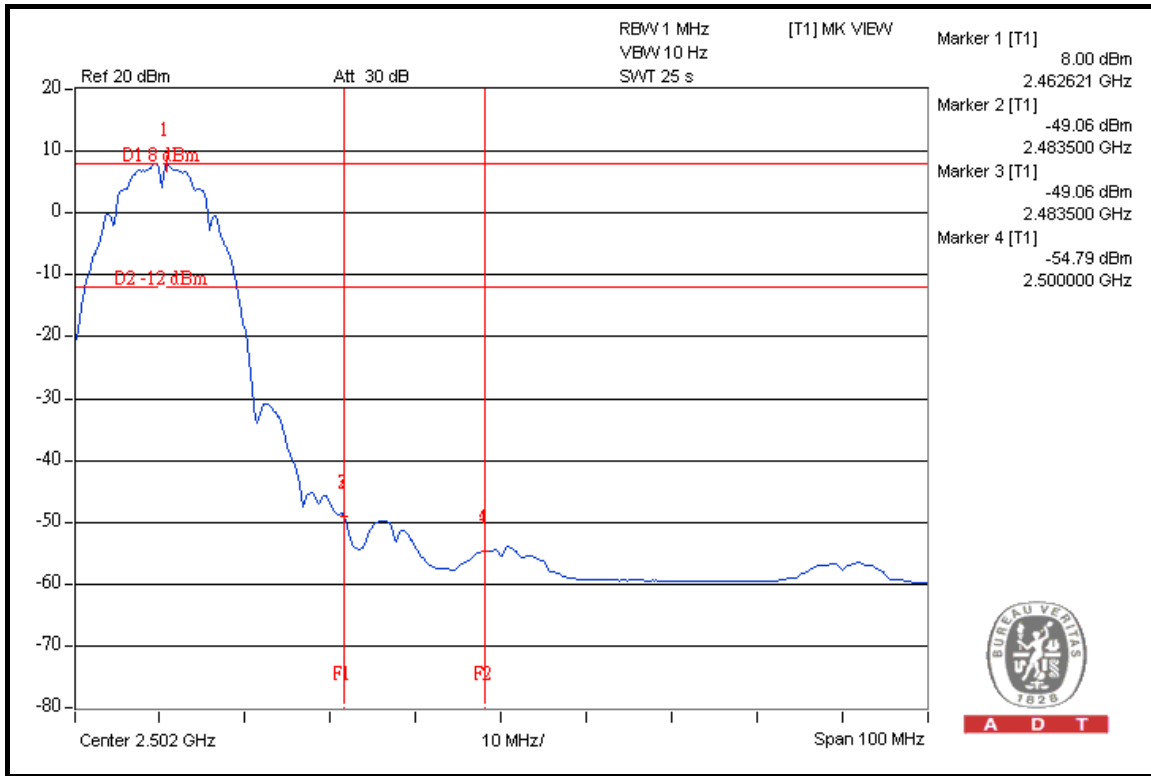

A D T

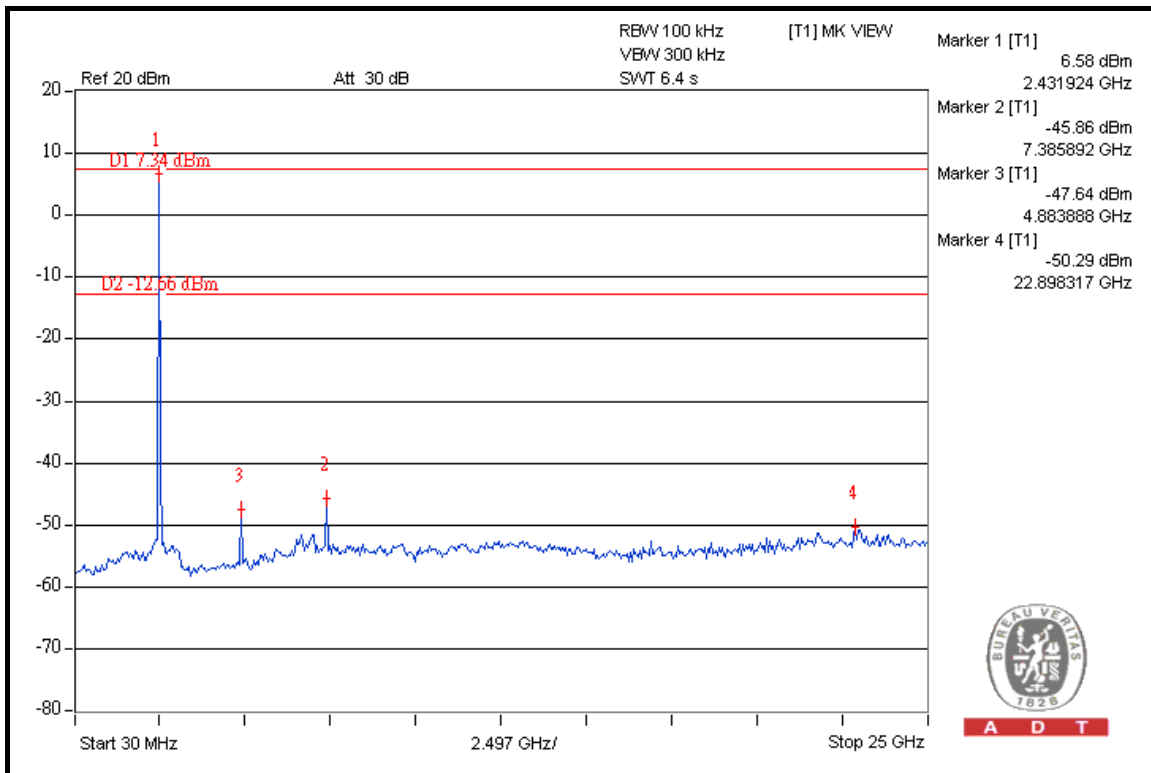

A D T

### 802.11g OFDM MODULATION: 1TX

**NOTE 1:** The band edge emission plot on the next page shows 44.95dBc between carrier maximum power and local maximum emission in restrict band (2.390000GHz). The emission of carrier strength list in the test result of channel 1 at the item 4.1.7 is 111.48dBuV/m (Peak), so the maximum field strength in restrict band is  $111.48 - 44.95 = 66.53$ dBuV/m which is under 74dBuV/m limit.

The band edge emission plot on the next page shows 50.56dBc between carrier maximum power and local maximum emission in restrict band (2.390000GHz). The emission of carrier strength list in the test result of channel 1 at the item 4.1.7 is 101.62dBuV/m (Average), so the maximum field strength in restrict band is  $101.62 - 50.56 = 51.06$ dBuV/m which is under 54dBuV/m limit.

**NOTE 2:** The band edge emission plot on the next second page shows 44.01dBc between carrier maximum power and local maximum emission in restrict band (2.483663GHz). The emission of carrier strength list in the test result of channel 11 at the item 4.1.7 is 110.48dBuV/m (Peak), so the maximum field strength in restrict band is  $110.48 - 44.01 = 66.47$ dBuV/m which is under 74dBuV/m limit.

The band edge emission plot on the next third page shows 49.67dBc between carrier maximum power and local maximum emission in restrict band (2.483500GHz). The emission of carrier strength list in the test result of channel 11 at the item 4.1.7 is 100.41dBuV/m (Average), so the maximum field strength in restrict band is  $100.41 - 49.67 = 50.74$ dBuV/m which is under 54dBuV/m limit.



A D T

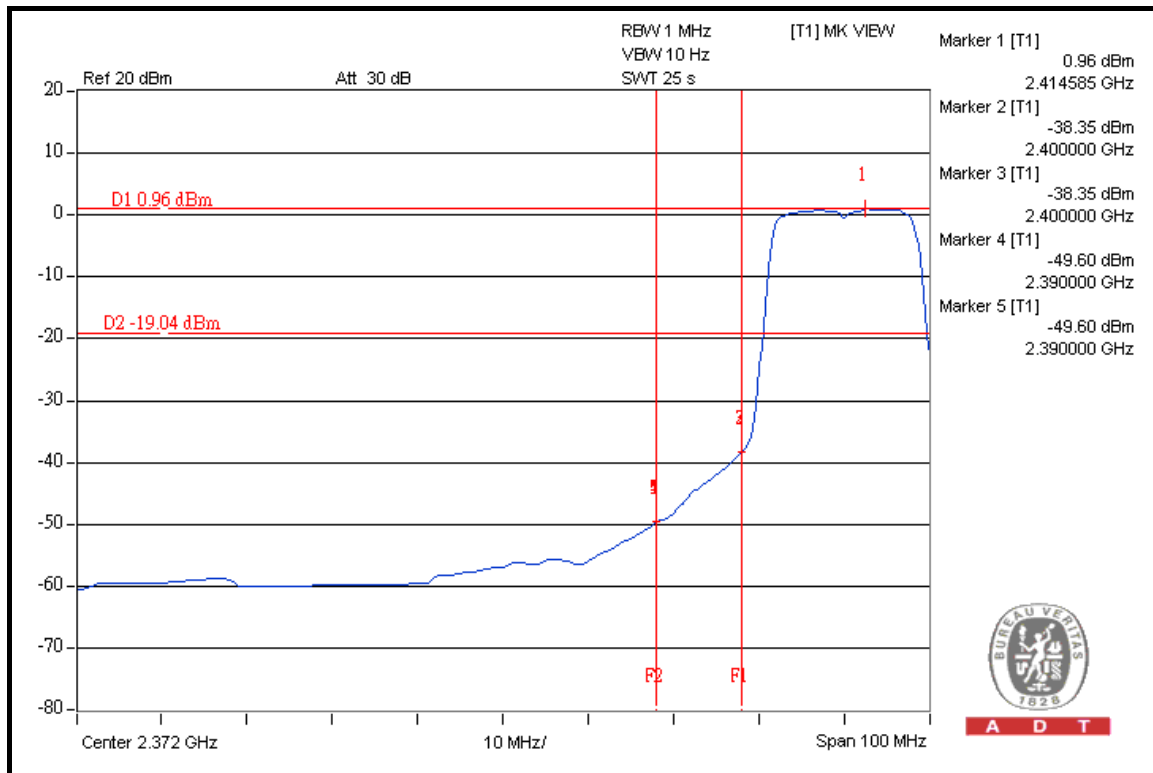
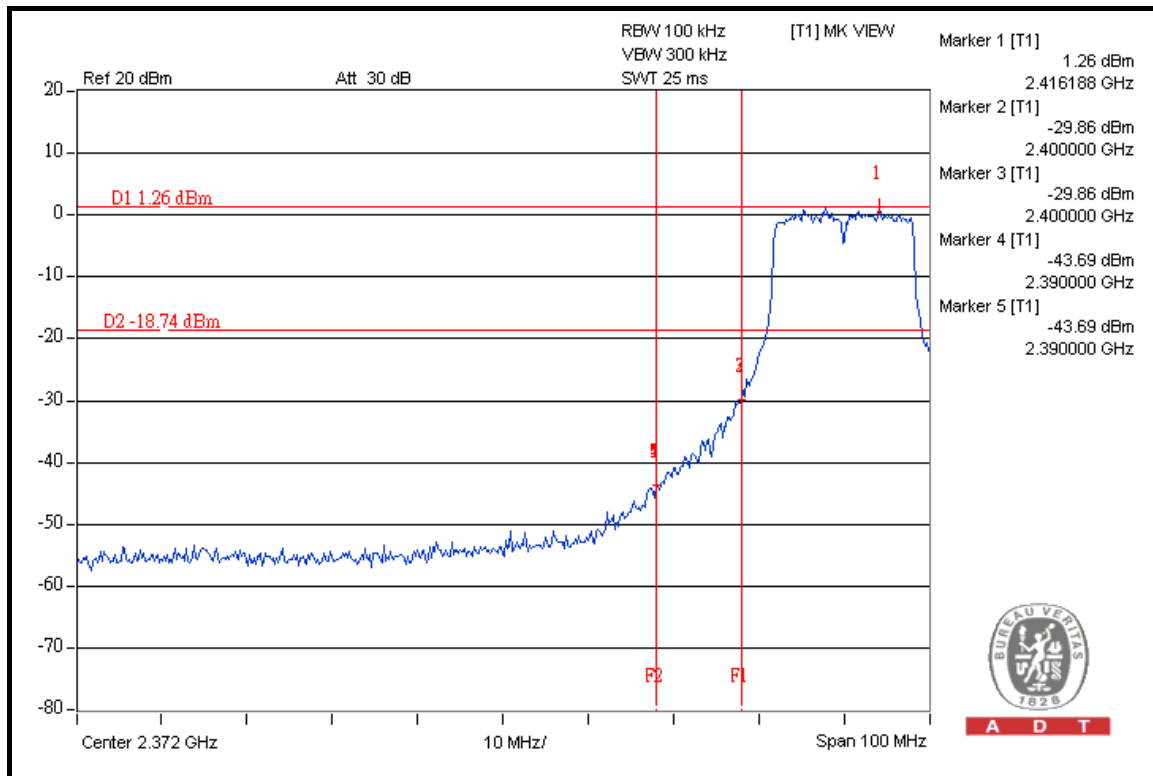



A D T

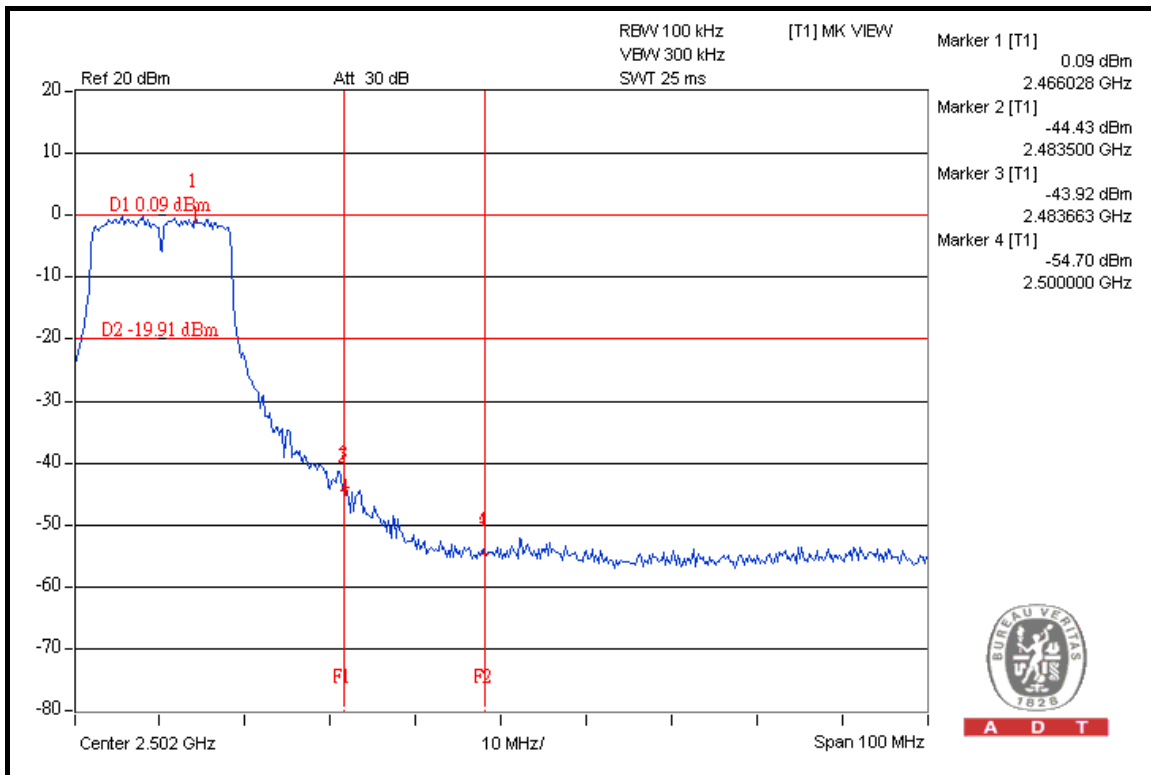
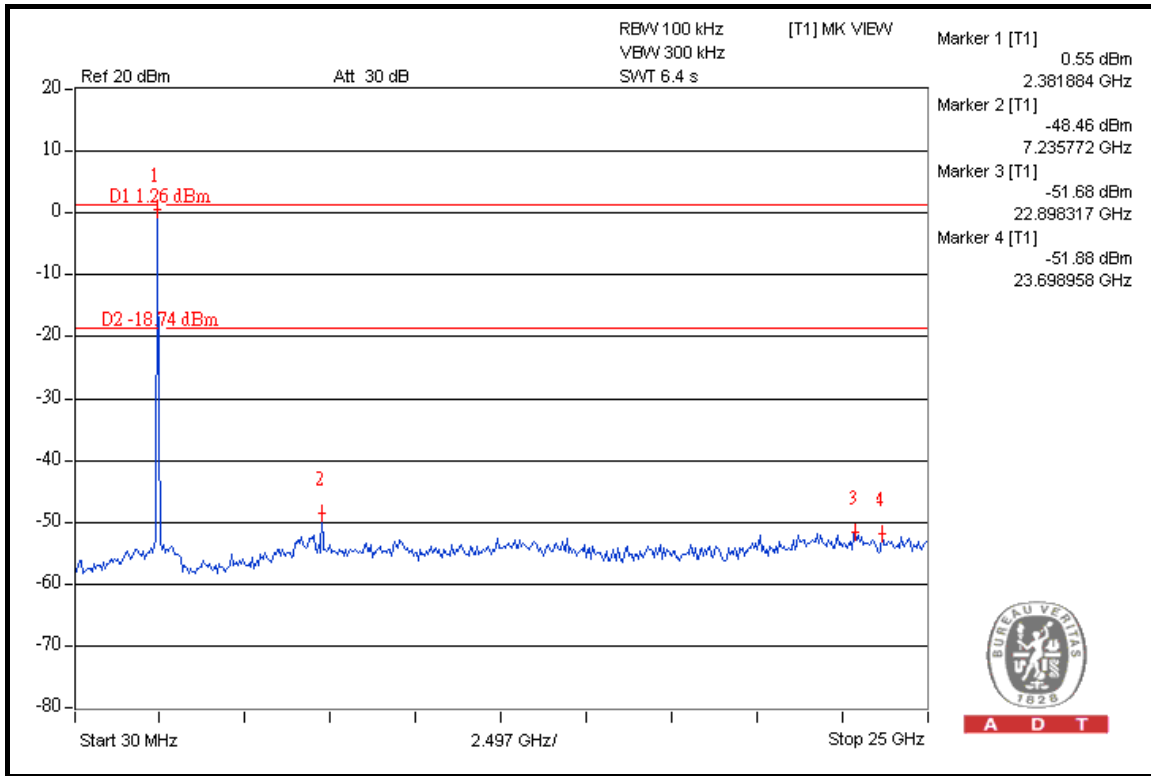



A D T

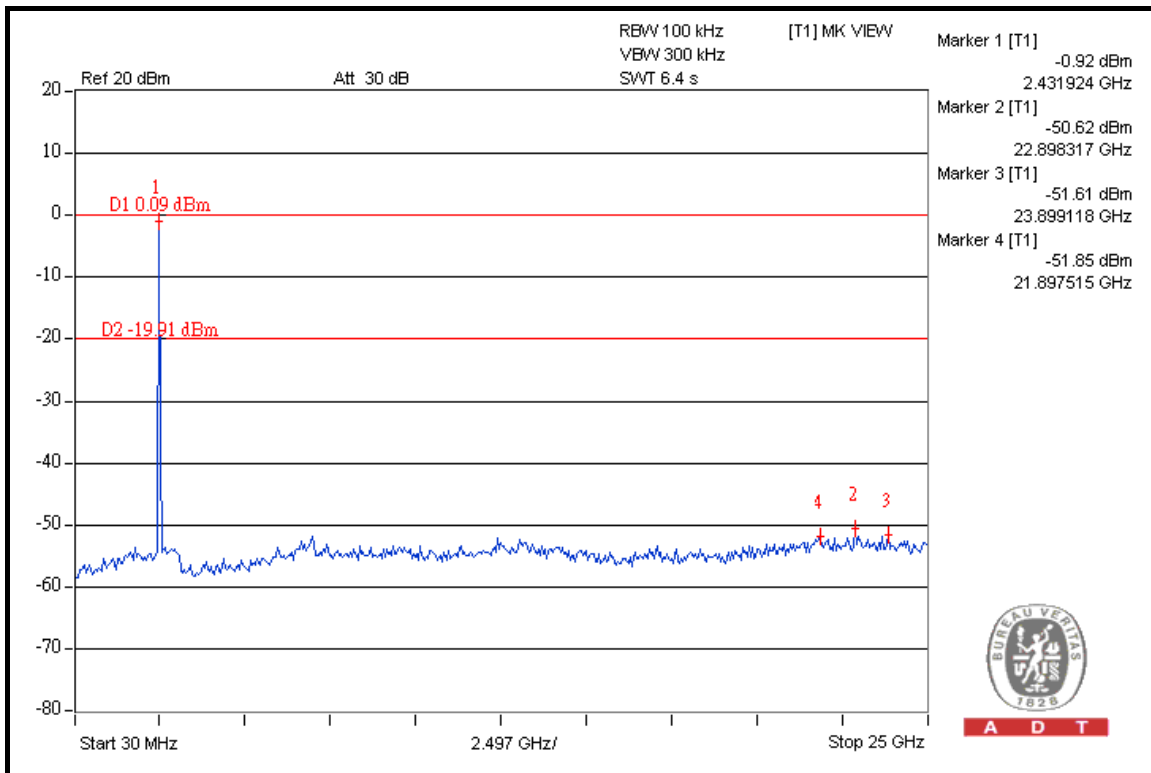
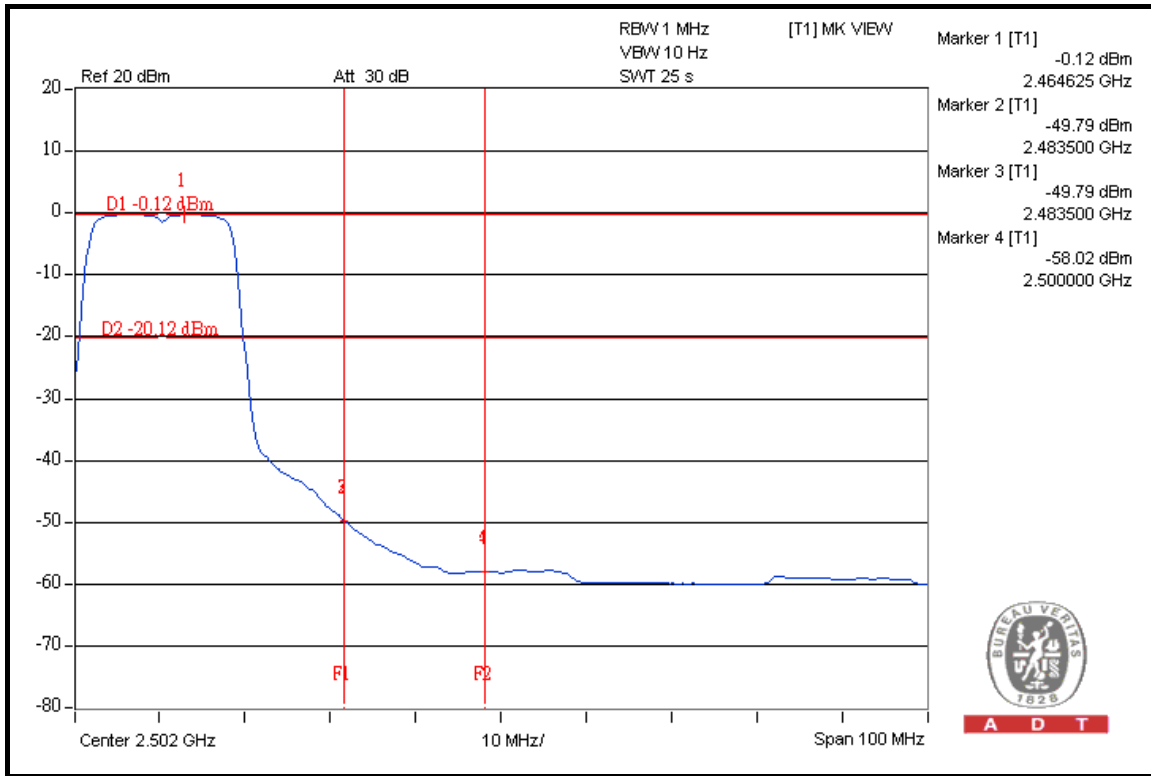



### **DRAFT 802.11n (20MHz) OFDM MODULATION: 1TX**

**NOTE 1:** The band edge emission plot on the next page shows 43.40dBc between carrier maximum power and local maximum emission in restrict band (2.390000GHz). The emission of carrier strength list in the test result of channel 1 at the item 4.1.7 is 110.91dBuV/m (Peak), so the maximum field strength in restrict band is  $110.91 - 43.40 = 67.51$ dBuV/m which is under 74dBuV/m limit.

The band edge emission plot on the next page shows 50.73dBc between carrier maximum power and local maximum emission in restrict band (2.390000GHz). The emission of carrier strength list in the test result of channel 1 at the item 4.1.7 is 100.44dBuV/m (Average), so the maximum field strength in restrict band is  $100.44 - 50.73 = 49.71$ dBuV/m which is under 54dBuV/m limit.

**NOTE 2:** The band edge emission plot on the next second page shows 41.20dBc between carrier maximum power and local maximum emission in restrict band (2.483500GHz). The emission of carrier strength list in the test result of channel 11 at the item 4.1.7 is 110.90dBuV/m (Peak), so the maximum field strength in restrict band is  $110.90 - 41.20 = 69.70$ dBuV/m which is under 74dBuV/m limit.

The band edge emission plot on the next third page shows 47.67dBc between carrier maximum power and local maximum emission in restrict band (2.483500GHz). The emission of carrier strength list in the test result of channel 11 at the item 4.1.7 is 100.40dBuV/m (Average), so the maximum field strength in restrict band is  $100.40 - 47.67 = 52.73$ dBuV/m which is under 54dBuV/m limit.



A D T

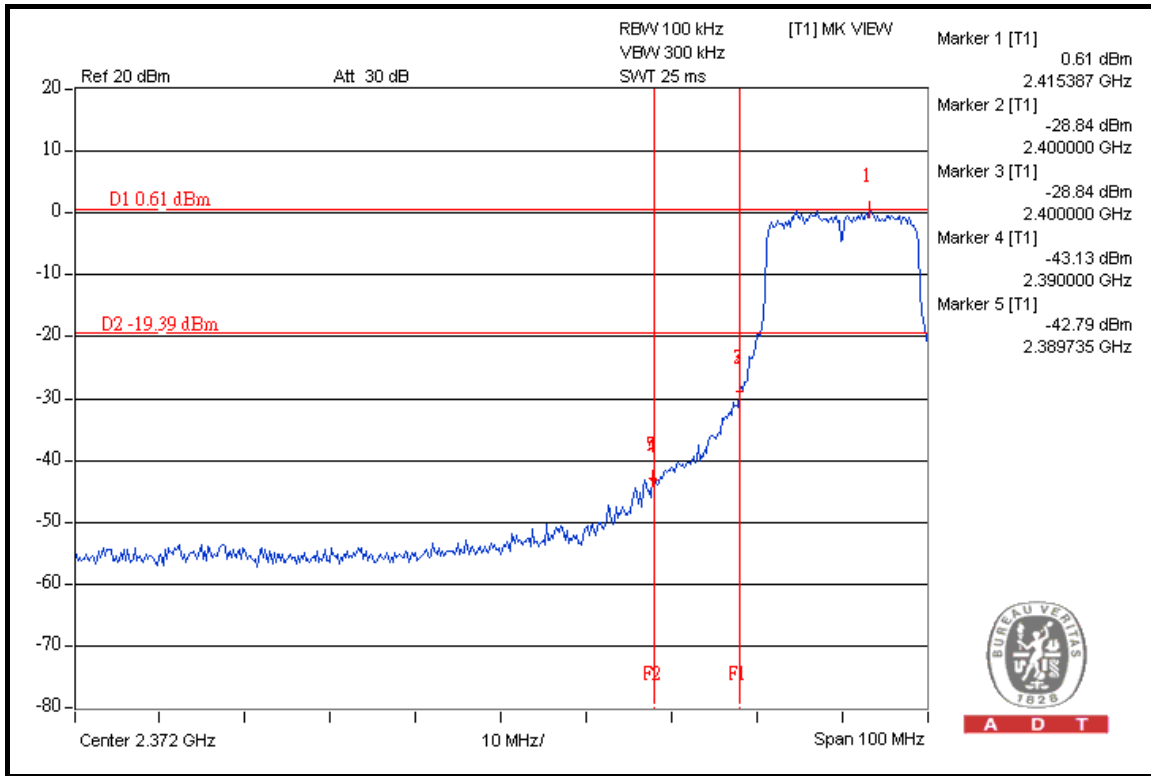

A D T

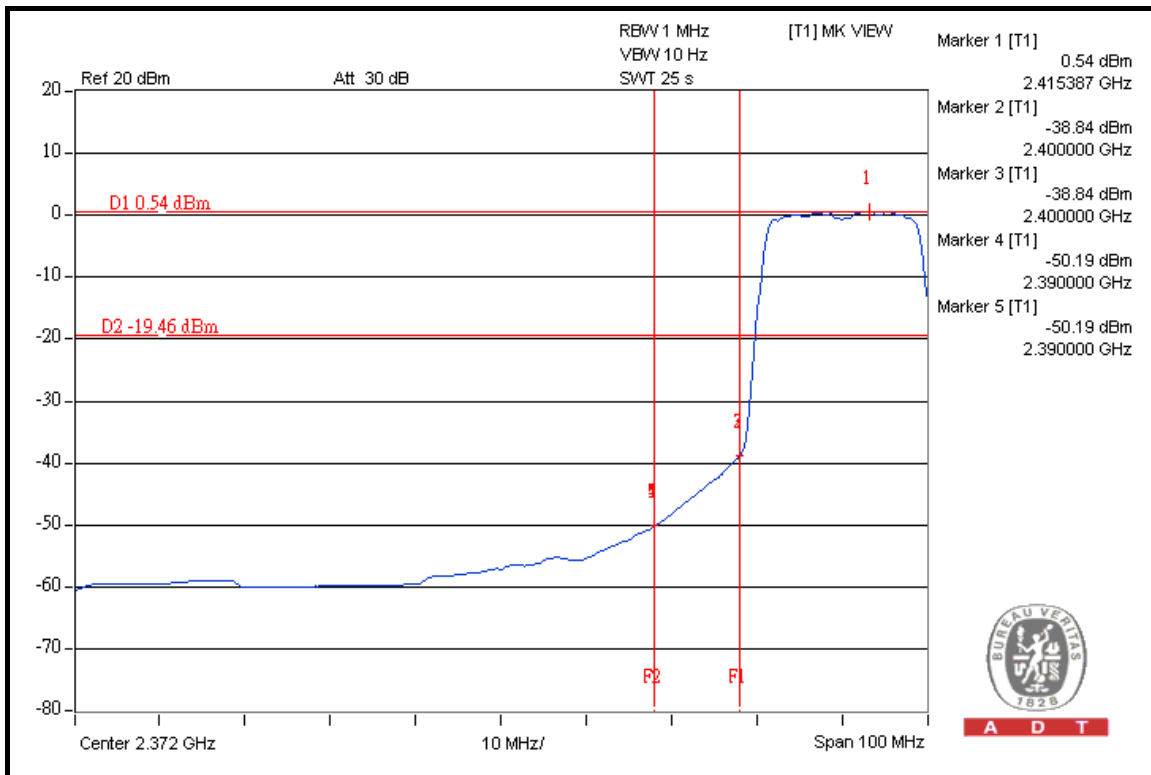

A D T



A D T

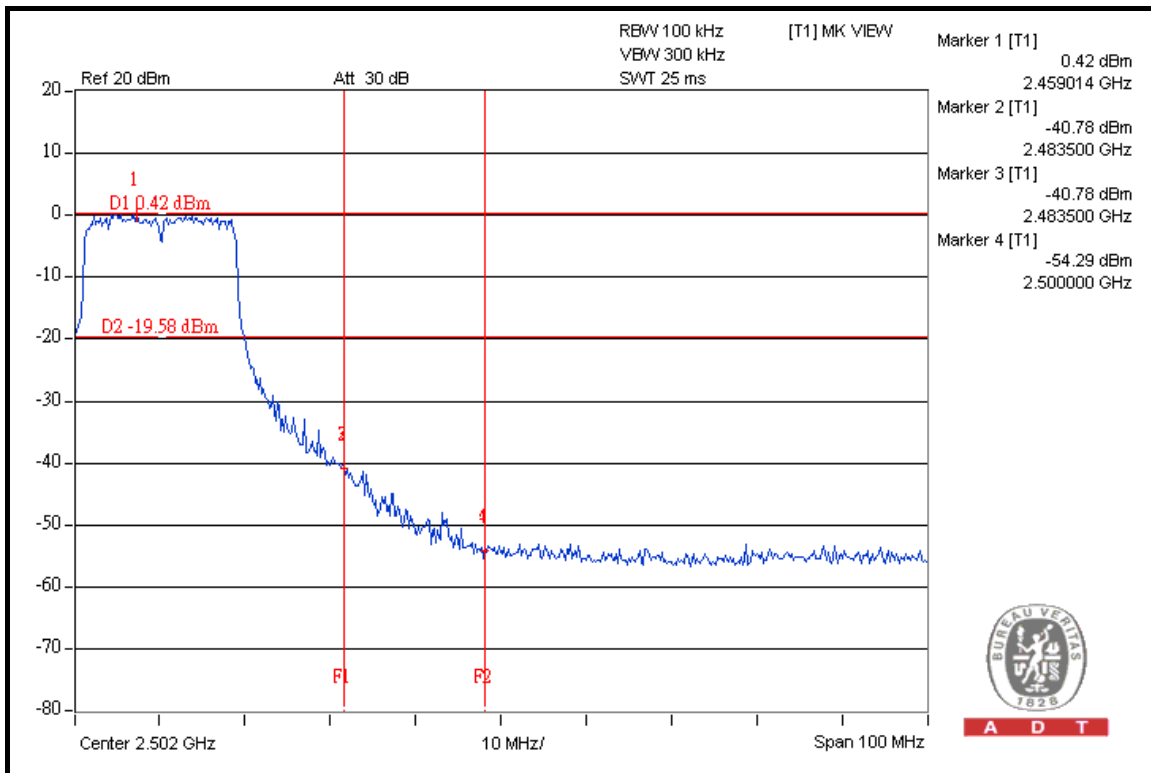
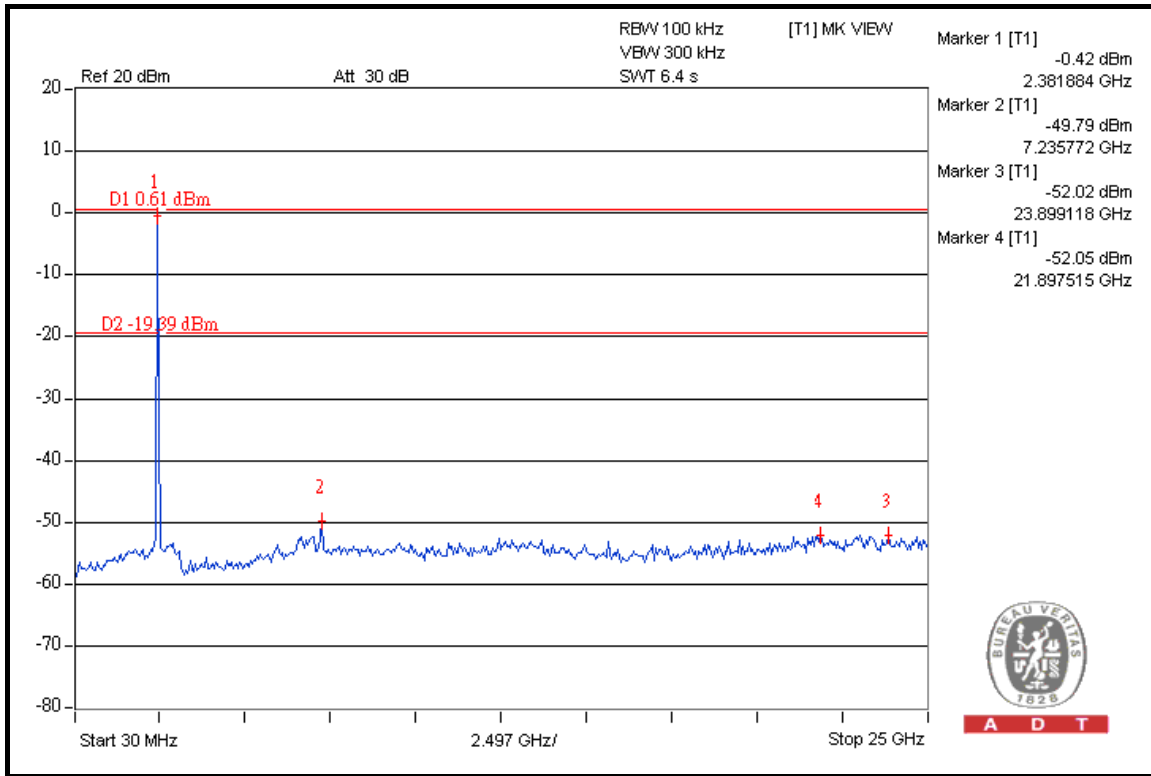



A D T

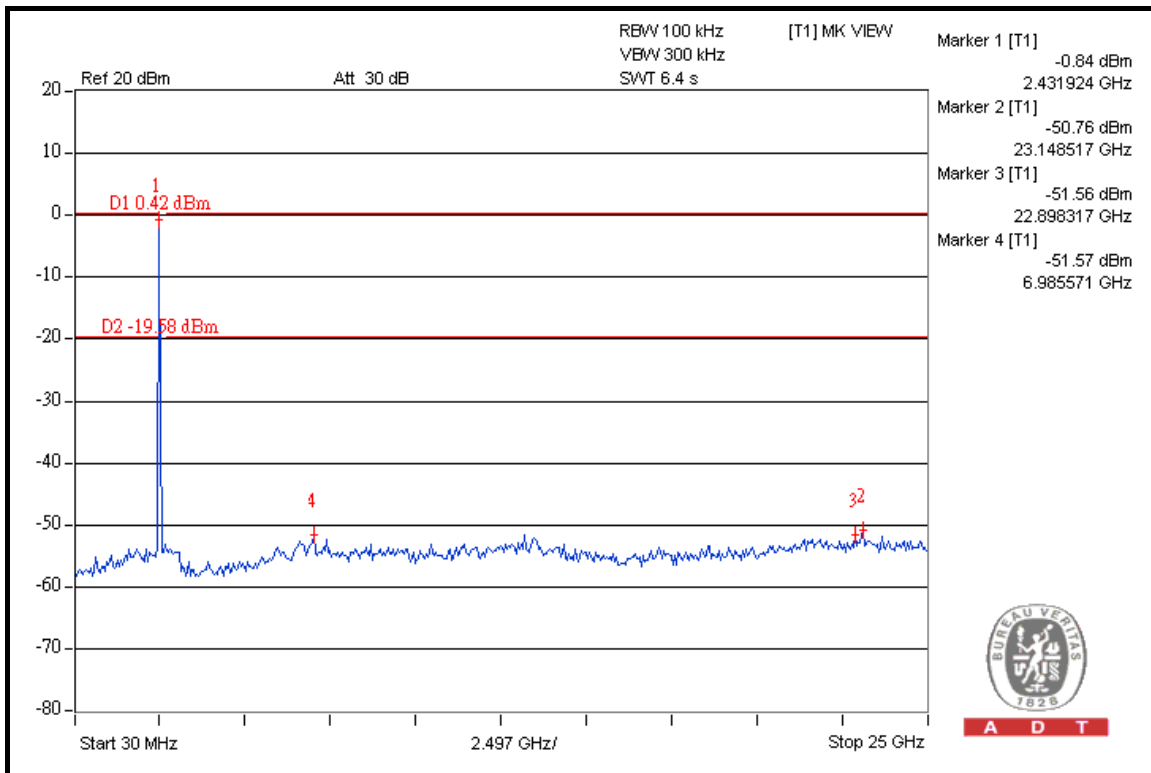
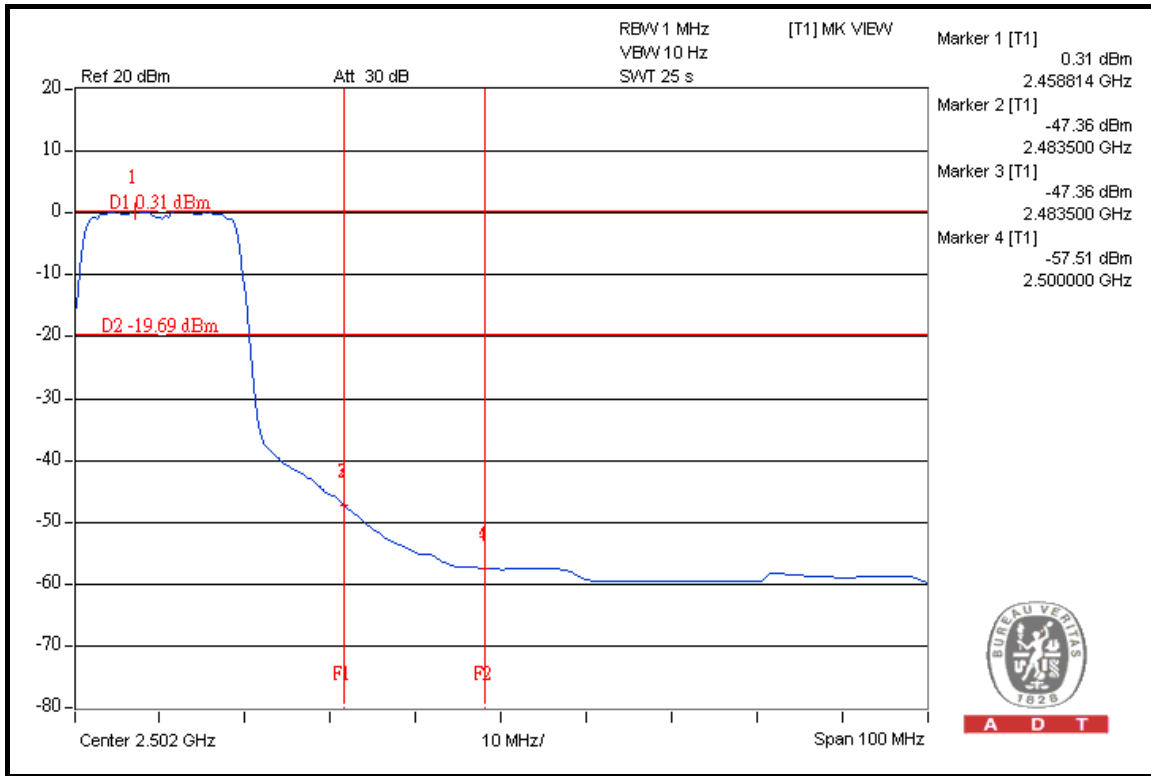

### DRAFT 802.11n (20MHz) OFDM MODULATION: 2TX

**NOTE 1:** The band edge emission plot on the next page shows 46.09dBc between carrier maximum power and local maximum emission in restrict band (2.332020GHz). The emission of carrier strength list in the test result of channel 1 at the item 4.1.7 is 105.58dBuV/m (Peak), so the maximum field strength in restrict band is  $105.58 - 46.09 = 59.49$ dBuV/m which is under 74dBuV/m limit.

The band edge emission plot on the next page shows 49.25dBc between carrier maximum power and local maximum emission in restrict band (2.372100GHz). The emission of carrier strength list in the test result of channel 1 at the item 4.1.7 is 93.85dBuV/m (Average), so the maximum field strength in restrict band is  $93.85 - 49.25 = 44.60$ dBuV/m which is under 54dBuV/m limit.

**NOTE 2:** The band edge emission plot on the next second page shows 47.27dBc between carrier maximum power and local maximum emission in restrict band (2.487070GHz). The emission of carrier strength list in the test result of channel 11 at the item 4.1.7 is 106.22dBuV/m (Peak), so the maximum field strength in restrict band is  $106.22 - 47.27 = 58.95$ dBuV/m which is under 74dBuV/m limit.

The band edge emission plot on the next third page shows 50.05dBc between carrier maximum power and local maximum emission in restrict band (2.483500GHz). The emission of carrier strength list in the test result of channel 11 at the item 4.1.7 is 94.48dBuV/m (Average), so the maximum field strength in restrict band is  $94.48 - 50.05 = 44.43$ dBuV/m which is under 54dBuV/m limit.



A D T

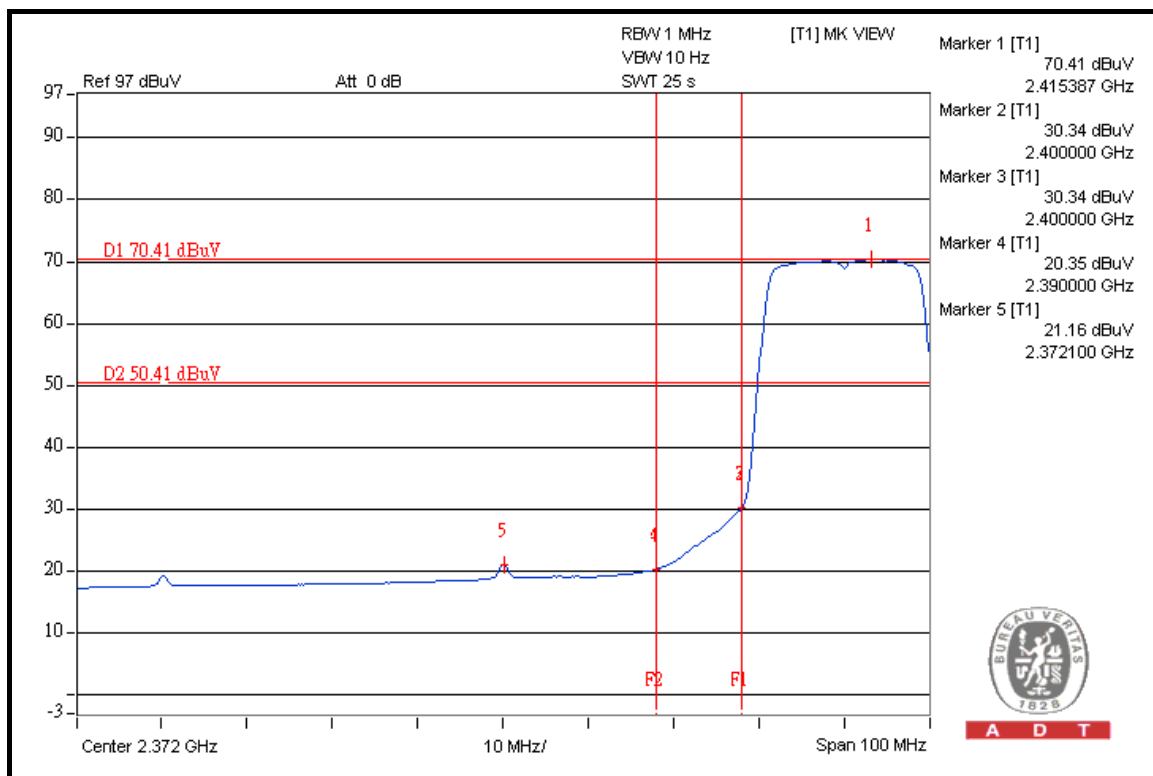
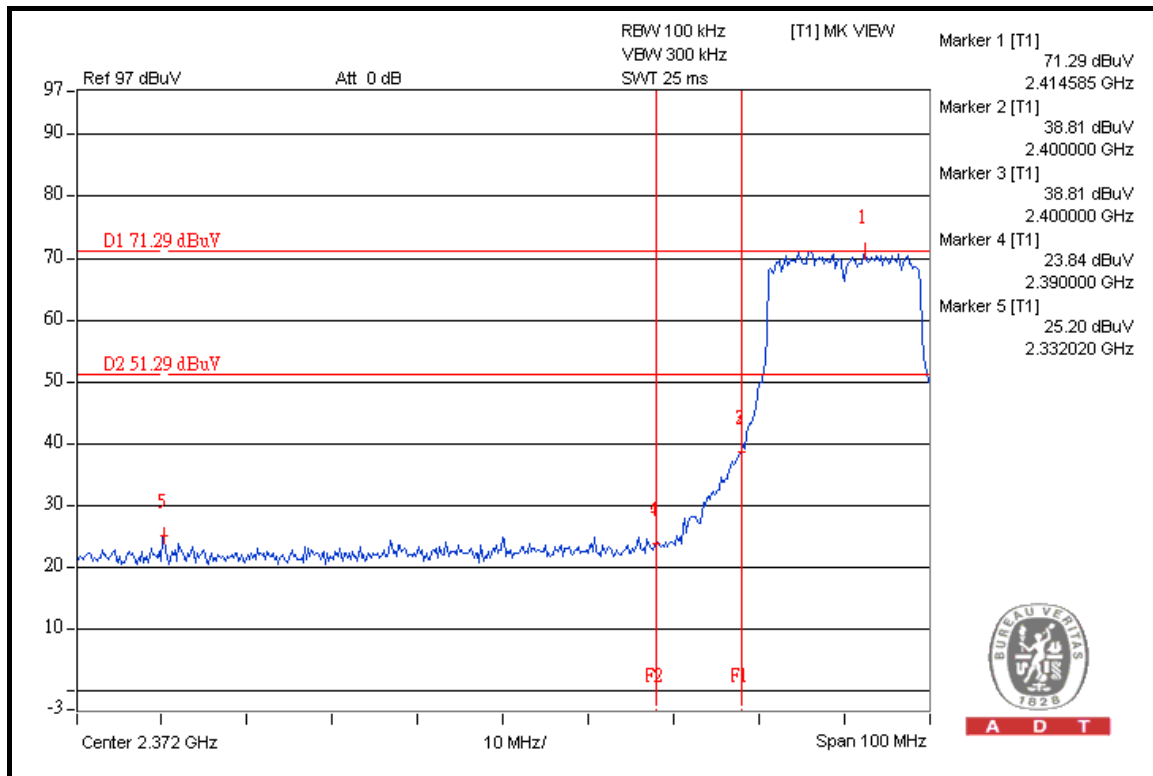



A D T

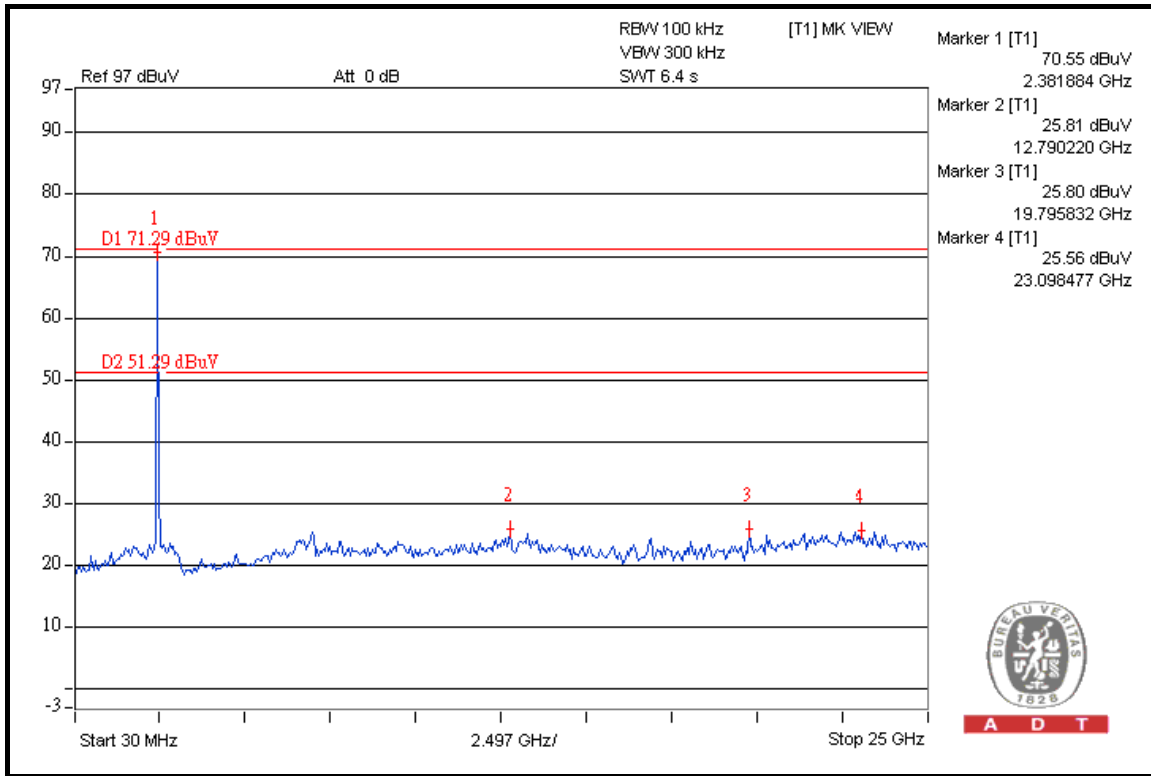

A D T

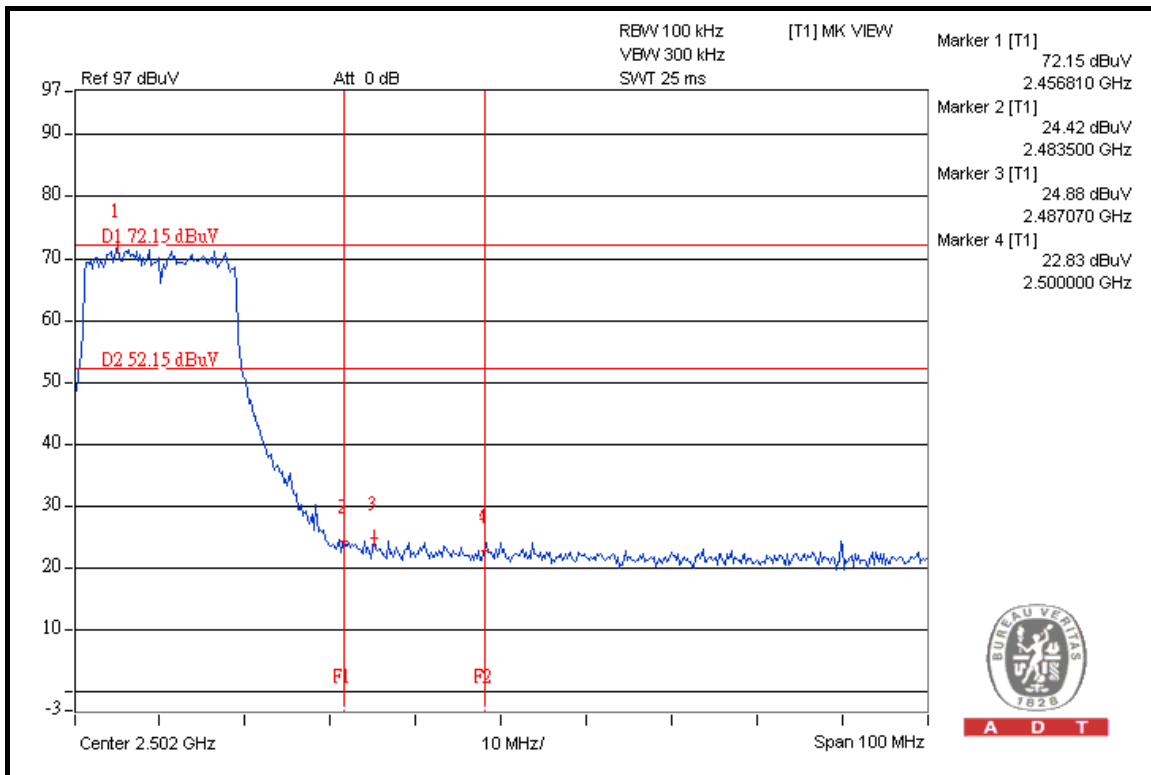

A D T



A D T

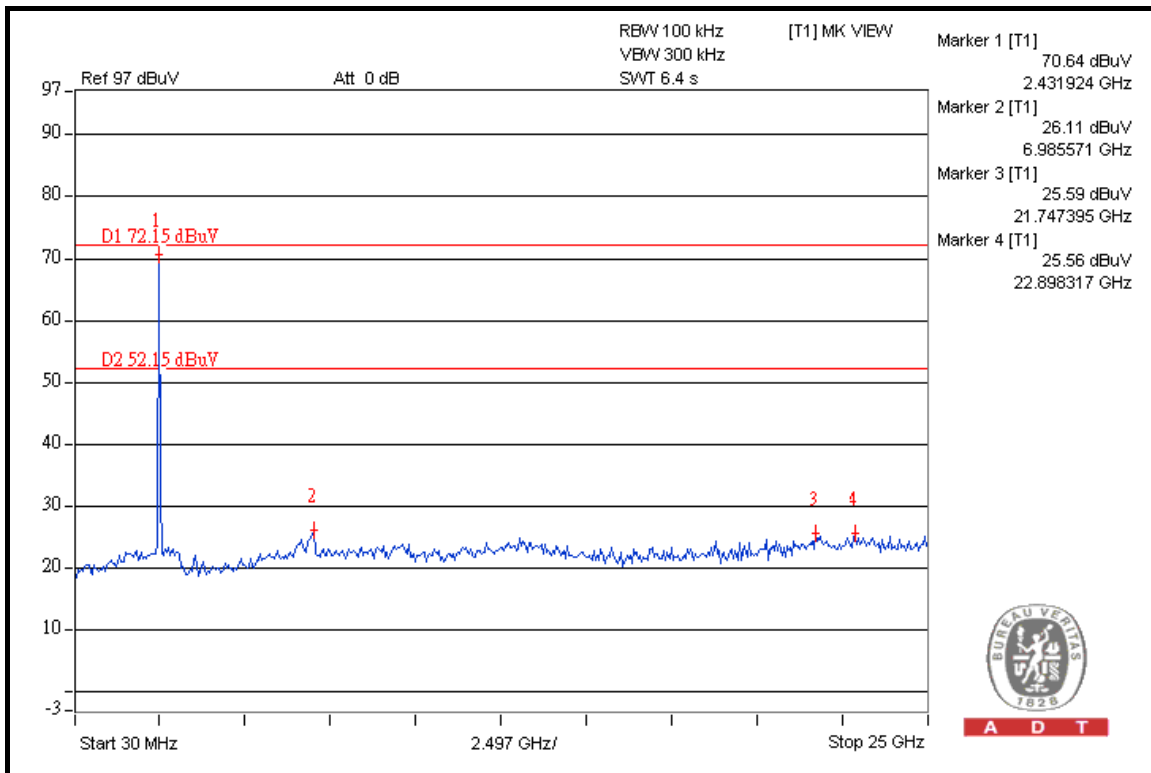
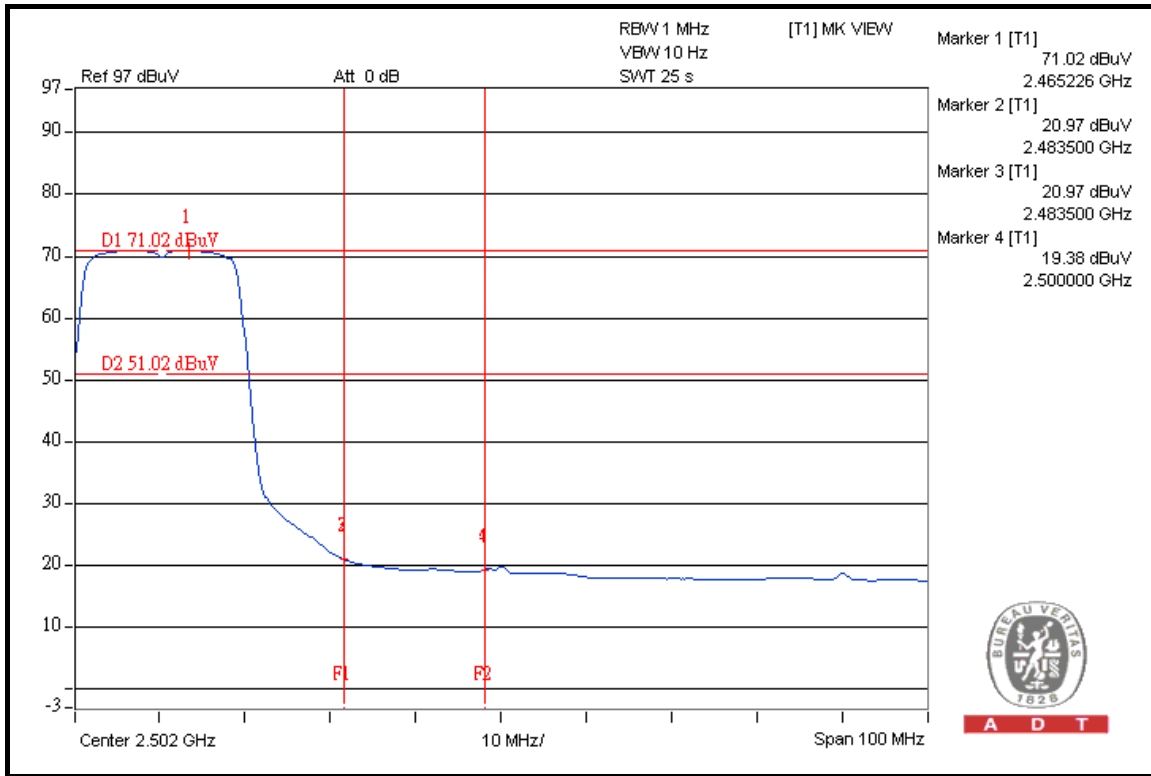



### DRAFT 802.11n (40MHz) OFDM MODULATION: 1TX

**NOTE 1:** The band edge emission plot on the next page shows 39.67dBc between carrier maximum power and local maximum emission in restrict band (2.389487GHz). The emission of carrier strength list in the test result of channel 1 at the item 4.1.7 is 107.59dBuV/m (Peak), so the maximum field strength in restrict band is  $107.59 - 39.67 = 67.92$ dBuV/m which is under 74dBuV/m limit.

The band edge emission plot on the next page shows 44.44dBc between carrier maximum power and local maximum emission in restrict band (2.390000GHz). The emission of carrier strength list in the test result of channel 1 at the item 4.1.7 is 97.13dBuV/m (Average), so the maximum field strength in restrict band is  $97.13 - 44.44 = 52.69$ dBuV/m which is under 54dBuV/m limit.

**NOTE 2:** The band edge emission plot on the next second page shows 40.23dBc between carrier maximum power and local maximum emission in restrict band (2.484914GHz). The emission of carrier strength list in the test result of channel 7 at the item 4.1.7 is 106.48dBuV/m (Peak), so the maximum field strength in restrict band is  $106.48 - 40.23 = 66.25$ dBuV/m which is under 74dBuV/m limit.

The band edge emission plot on the next third page shows 44.83dBc between carrier maximum power and local maximum emission in restrict band (2.483500GHz). The emission of carrier strength list in the test result of channel 7 at the item 4.1.7 is 96.03dBuV/m (Average), so the maximum field strength in restrict band is  $96.03 - 44.83 = 51.20$ dBuV/m which is under 54dBuV/m limit.



A D T

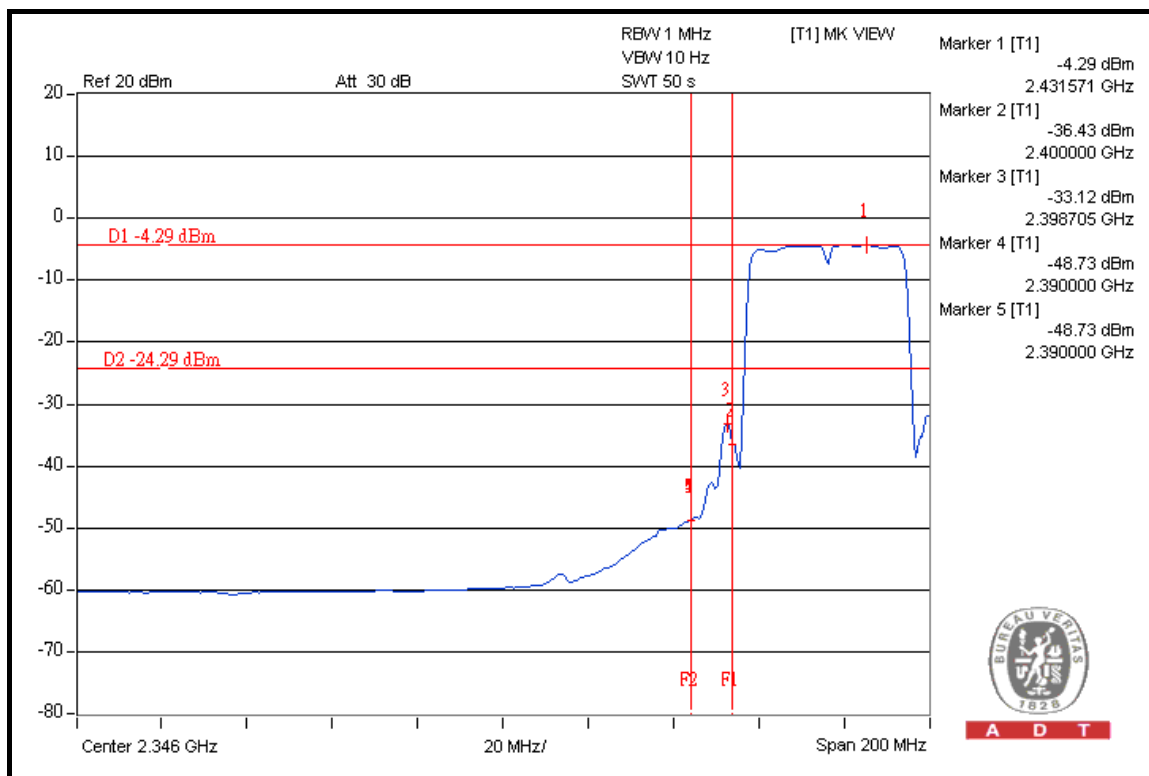
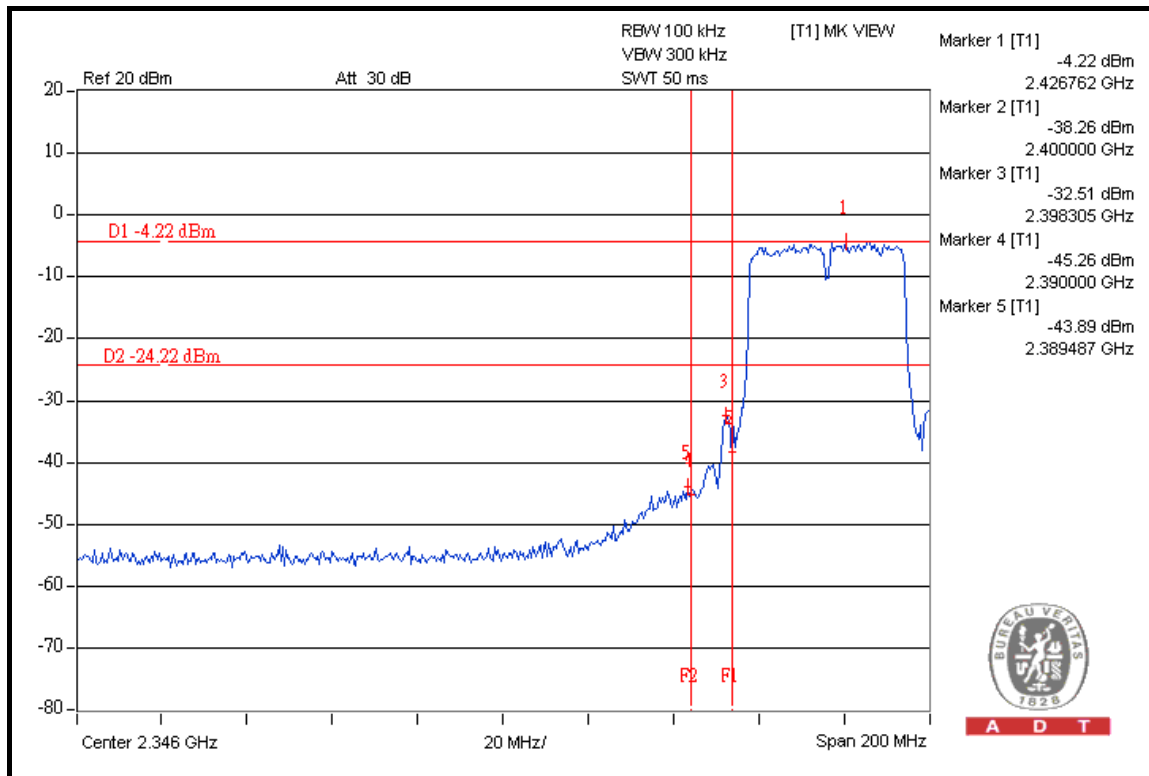



A D T

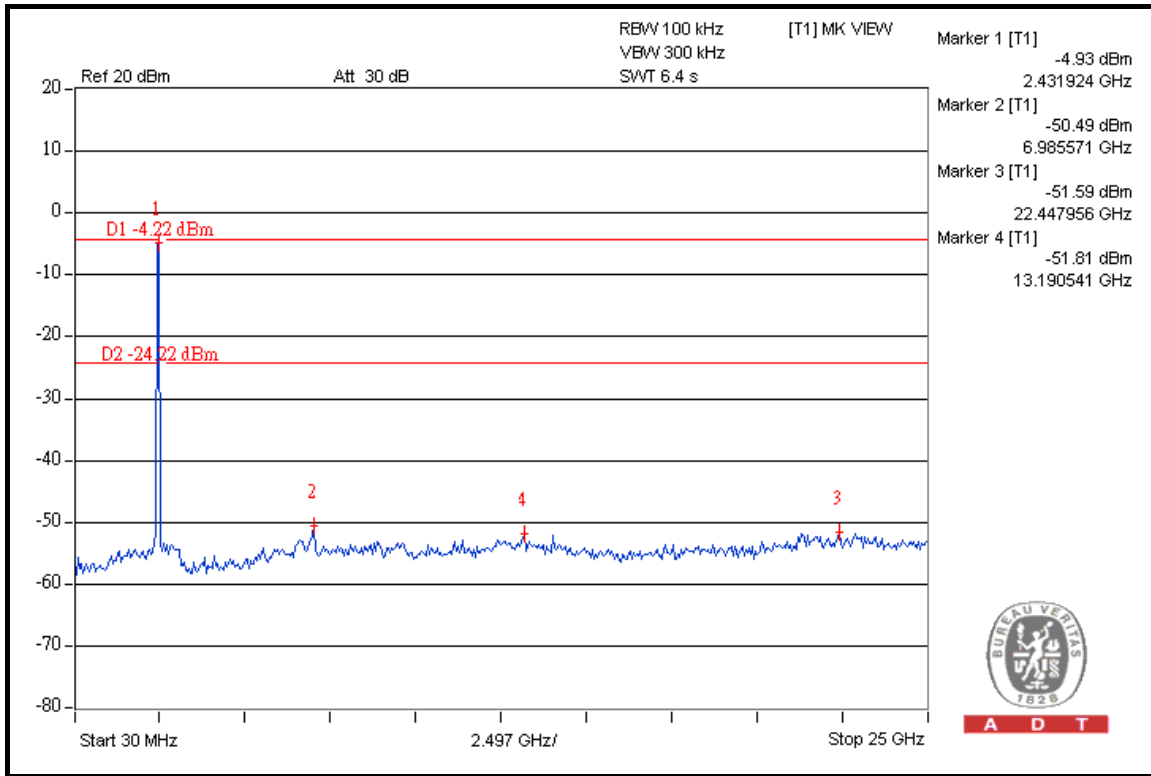

A D T

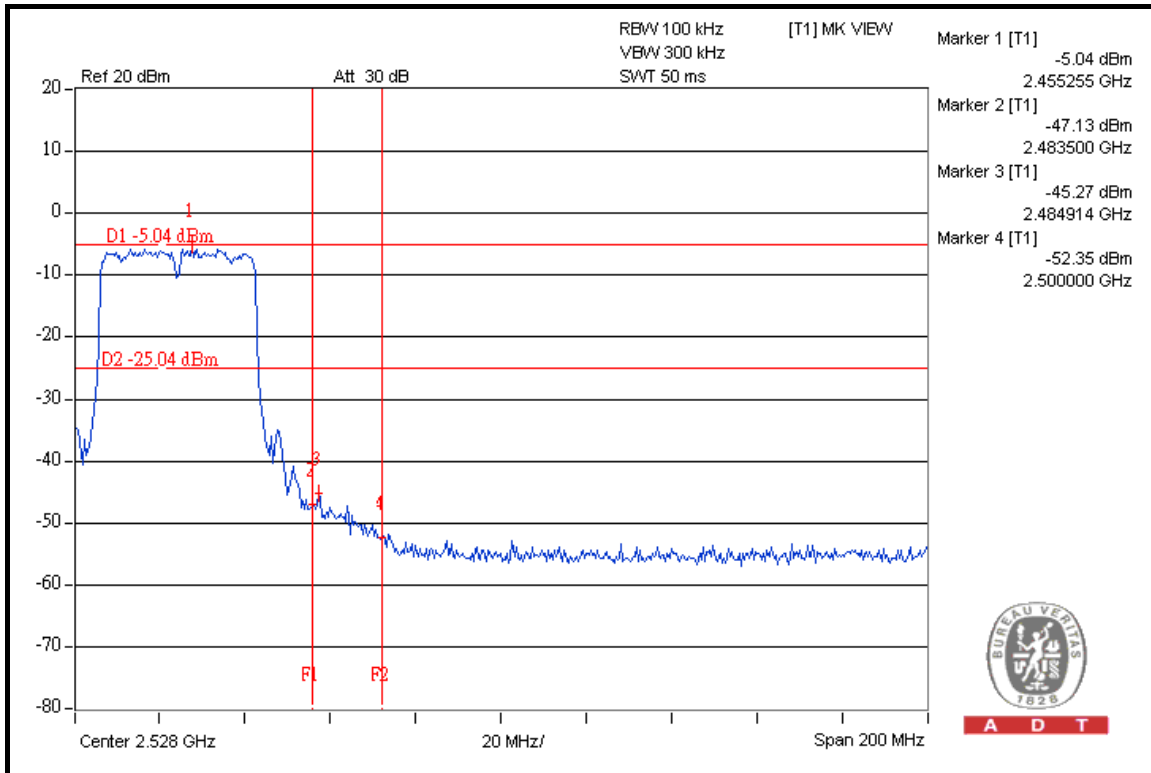

A D T



A D T

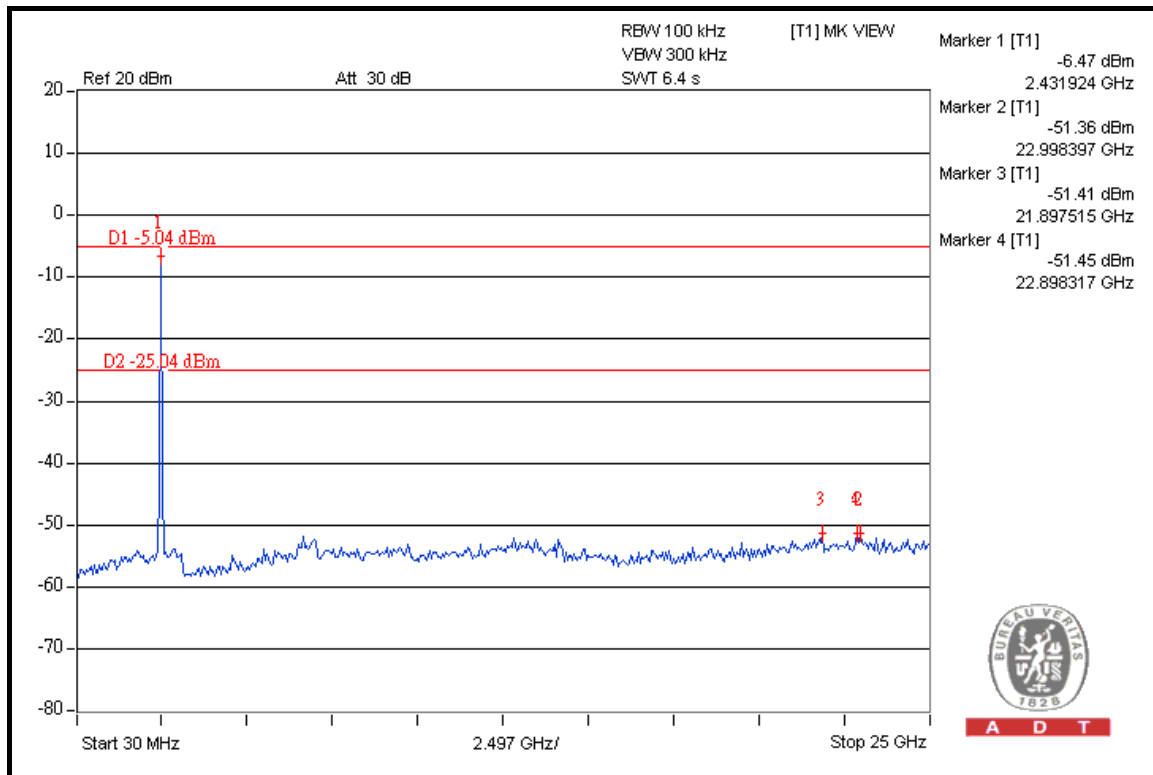
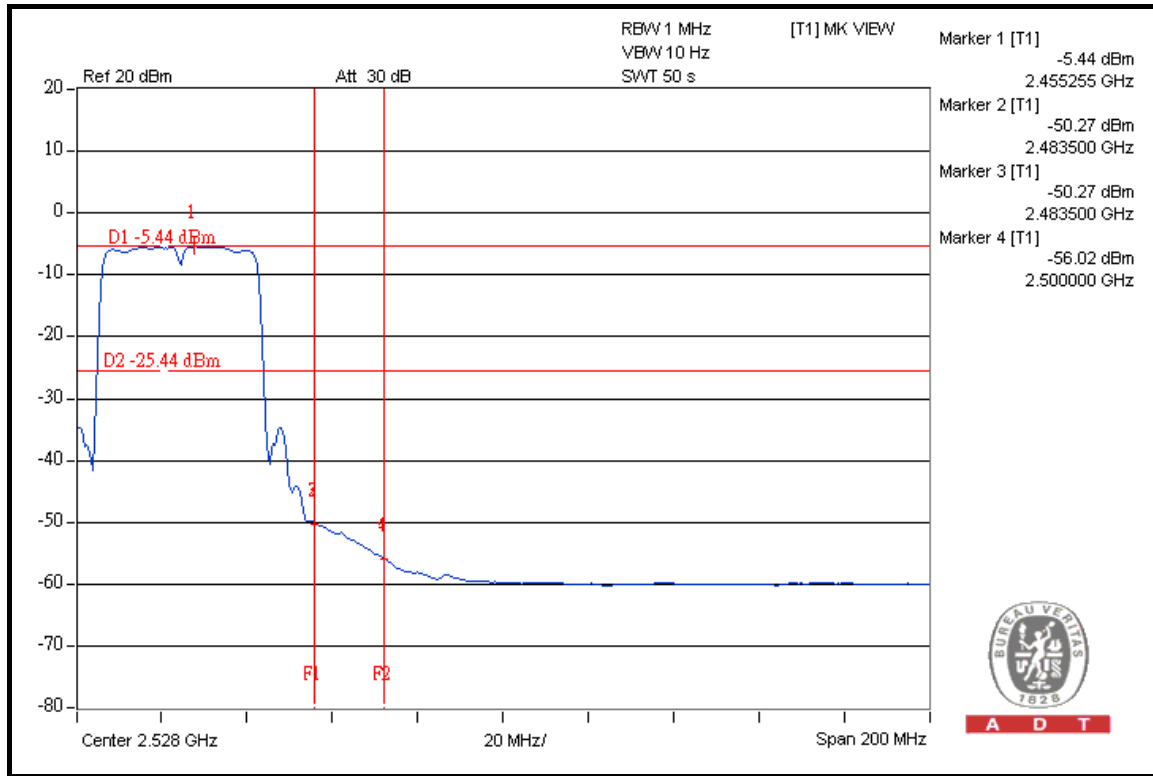

### DRAFT 802.11n (40MHz) OFDM MODULATION: 2TX

**NOTE 1:** The band edge emission plot on the next page shows 43.18dBc between carrier maximum power and local maximum emission in restrict band (2.382273GHz). The emission of carrier strength list in the test result of channel 1 at the item 4.1.7 is 102.56dBuV/m (Peak), so the maximum field strength in restrict band is  $102.56 - 43.18 = 59.38$ dBuV/m which is under 74dBuV/m limit.

The band edge emission plot on the next page shows 46.14dBc between carrier maximum power and local maximum emission in restrict band (2.382273GHz). The emission of carrier strength list in the test result of channel 1 at the item 4.1.7 is 90.87dBuV/m (Average), so the maximum field strength in restrict band is  $90.87 - 46.14 = 44.73$ dBuV/m which is under 54dBuV/m limit.

**NOTE 2:** The band edge emission plot on the next second page shows 43.32dBc between carrier maximum power and local maximum emission in restrict band (2.494533GHz). The emission of carrier strength list in the test result of channel 7 at the item 4.1.7 is 102.09dBuV/m (Peak), so the maximum field strength in restrict band is  $102.09 - 43.32 = 58.77$ dBuV/m which is under 74dBuV/m limit.

The band edge emission plot on the next third page shows 46.31dBc between carrier maximum power and local maximum emission in restrict band (2.485315GHz). The emission of carrier strength list in the test result of channel 7 at the item 4.1.7 is 90.83dBuV/m (Average), so the maximum field strength in restrict band is  $90.83 - 46.31 = 44.07$ dBuV/m which is under 54dBuV/m limit.



A D T

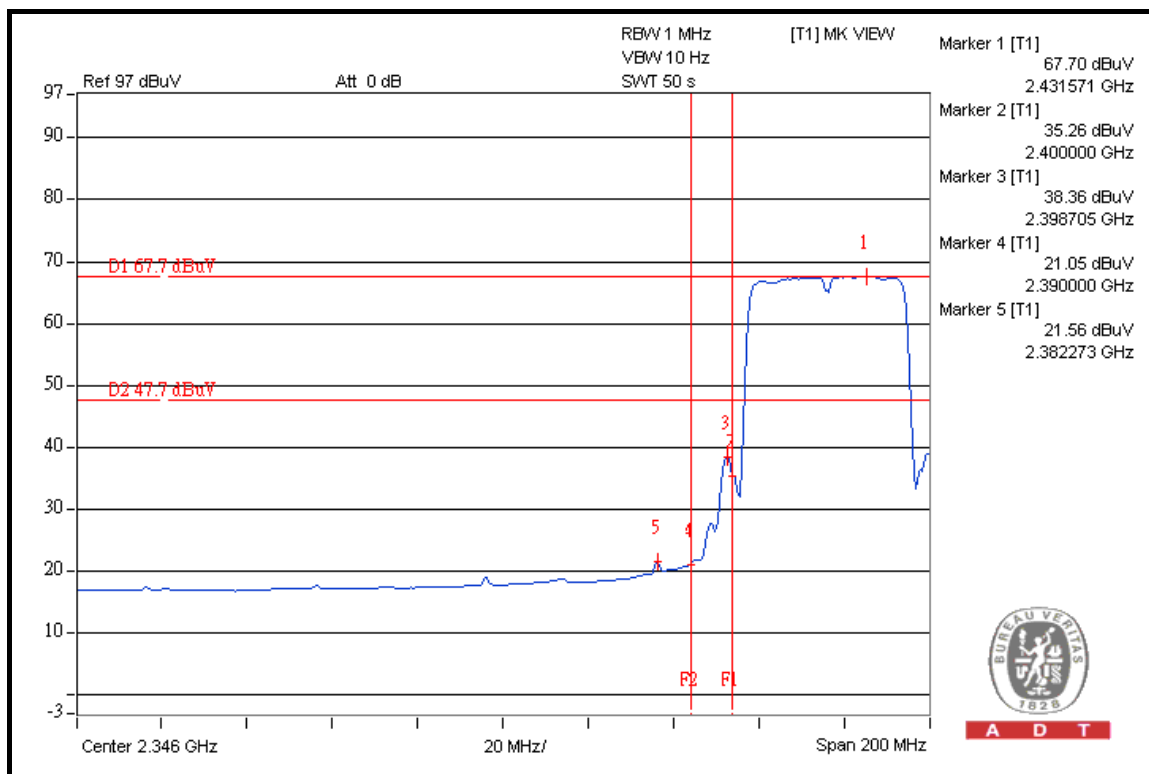
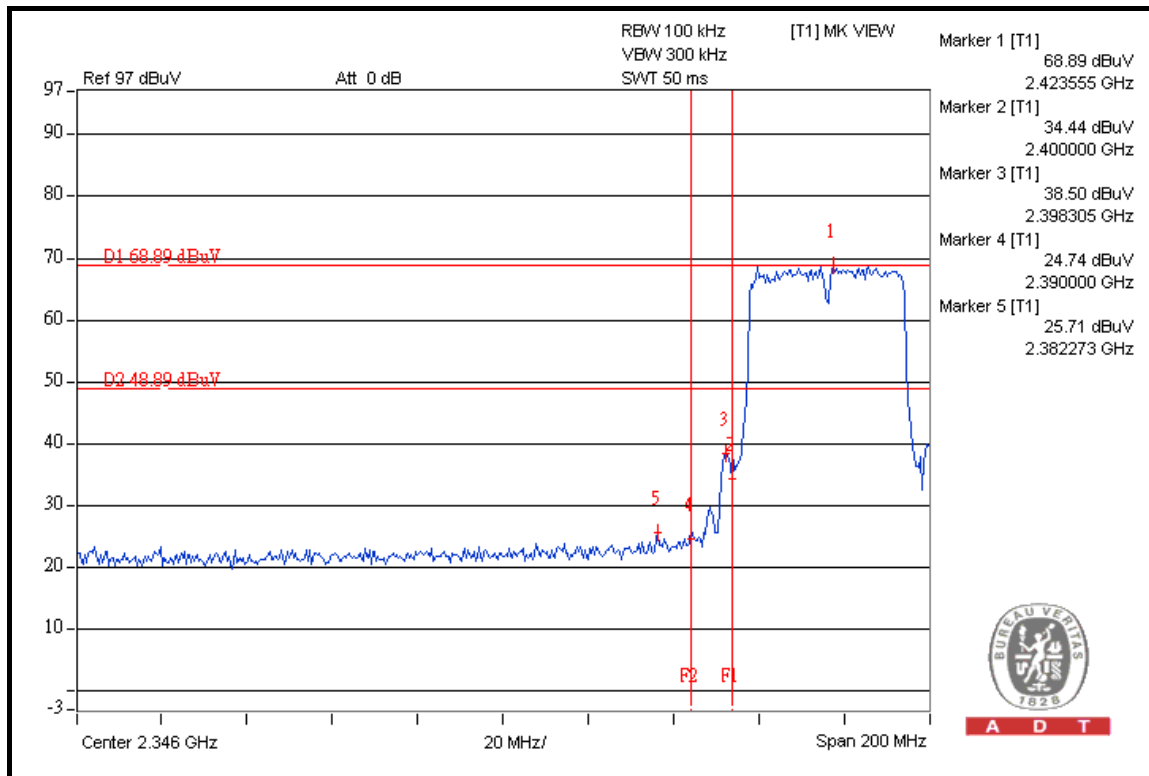



A D T

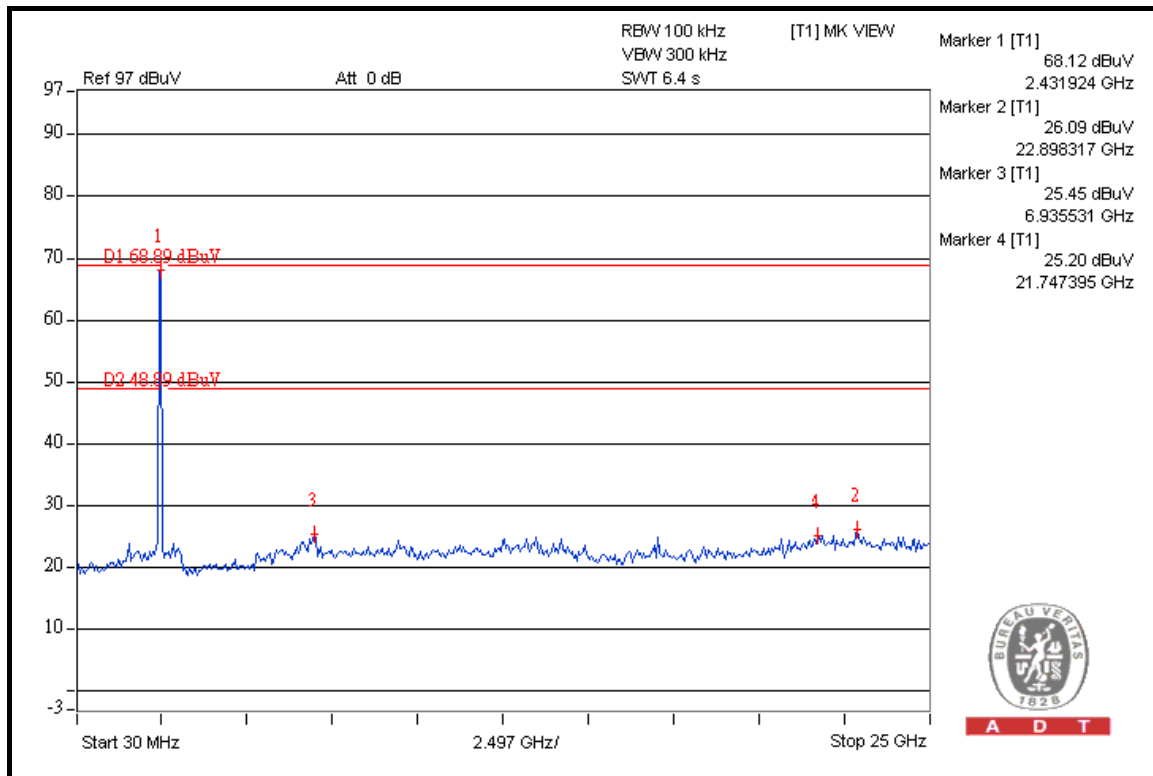

A D T

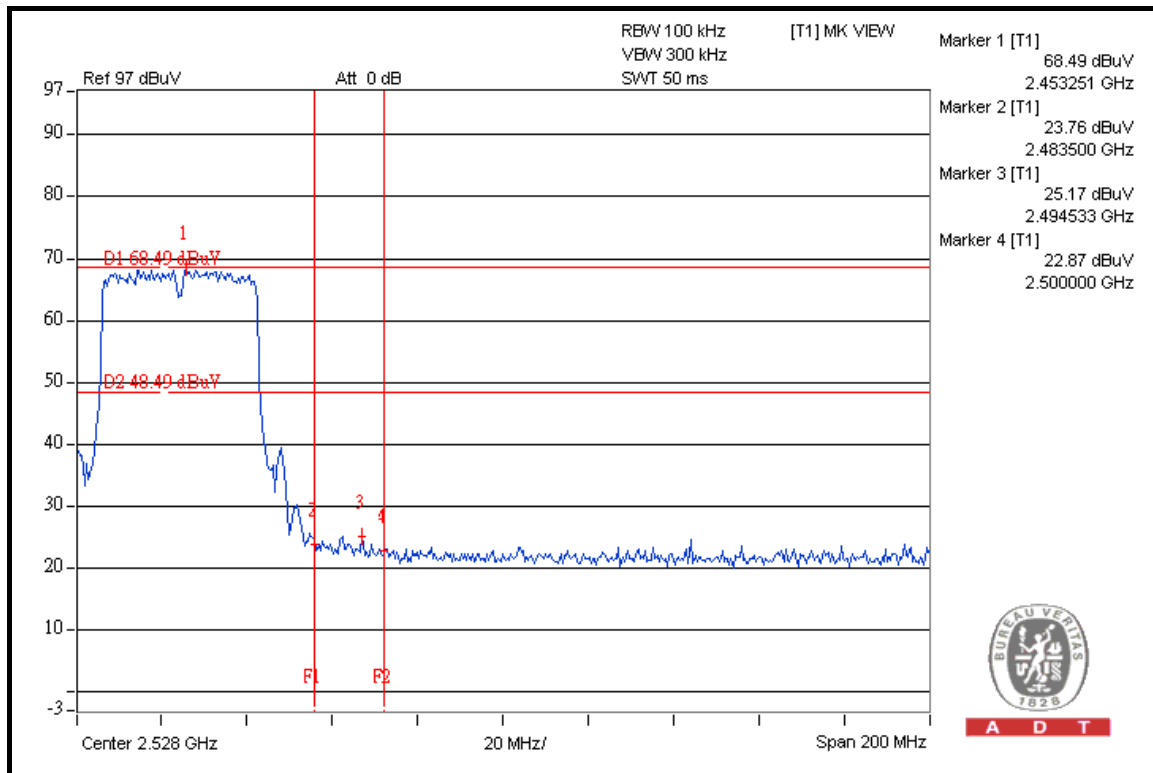

A D T



A D T

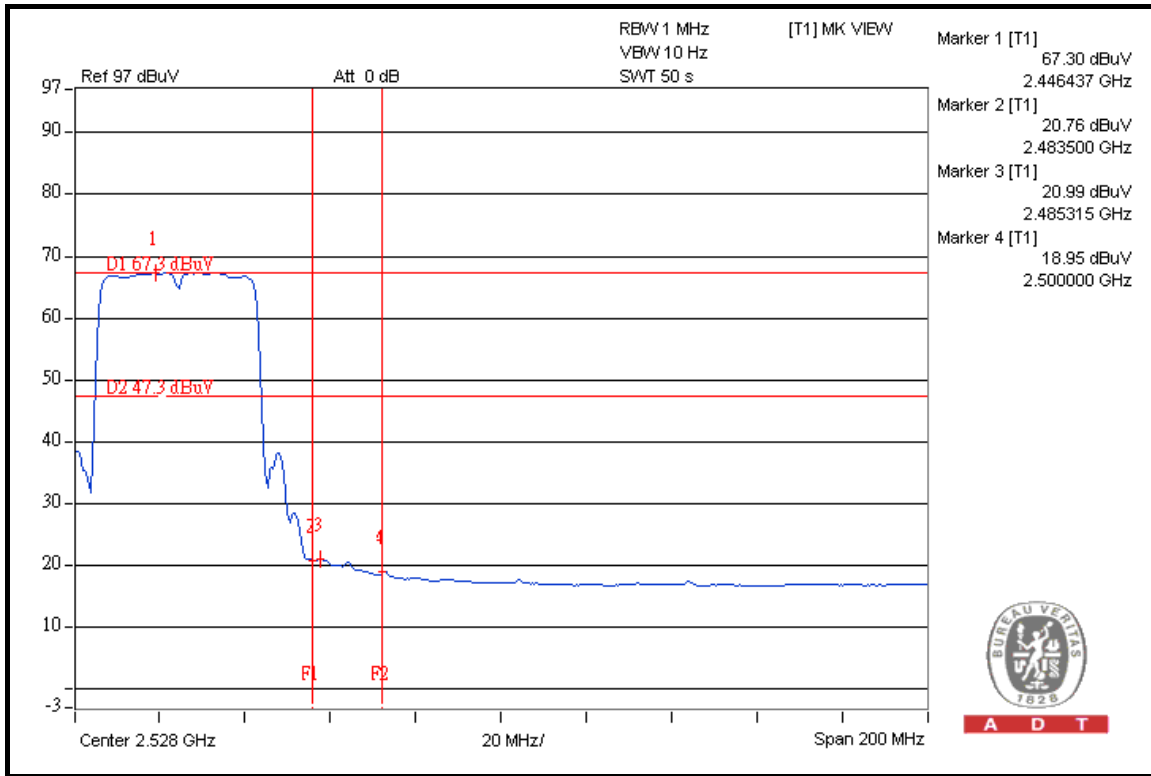

A D T

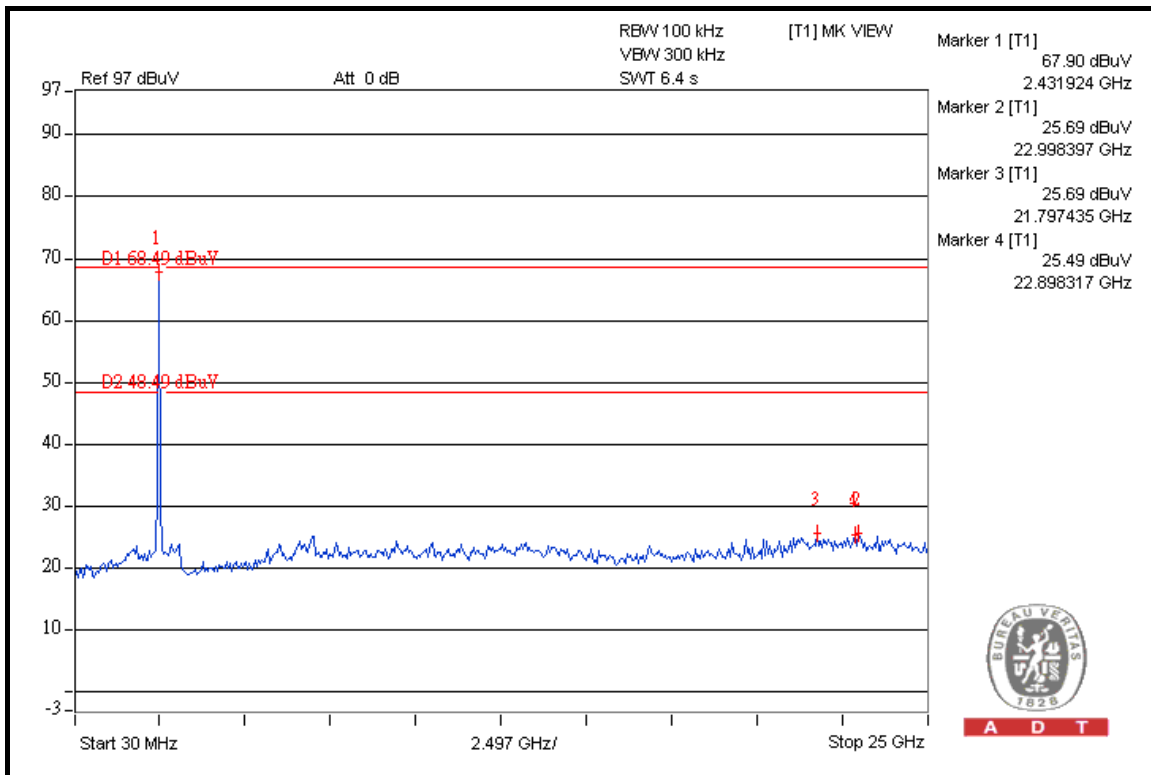

A D T



## 4.7 ANTENNA REQUIREMENT

### 4.7.1 STANDARD APPLICABLE

For intentional device, according to FCC 47 CFR Section 15.203, an intentional radiator shall be designed to ensure that no antenna other than that furnished by the responsible party shall be used with the device. And according to FCC 47 CFR Section 15.247 (b), if transmitting antennas of directional gain greater than 6dBi are used, the power shall be reduced by the amount in dB that the directional gain of the antenna exceeds 6dBi.

### 4.7.2 ANTENNA CONNECTED CONSTRUCTION

The antenna used in this product is Dipole antenna with R-SMA antenna connector. The maximum Gain of the antenna is 2dBi.



A D T

## 5. PHOTOGRAPHS OF THE TEST CONFIGURATION

Please refer to the attached file (Test Setup Photo).

## 6. INFORMATION ON THE TESTING LABORATORIES

We, Bureau Veritas Consumer Products Services (H.K.) Ltd., Taoyuan Branch, were founded in 1988 to provide our best service in EMC, Radio, Telecom and Safety consultation. Our laboratories are accredited and approved by the following approval agencies according to ISO/IEC 17025.

<b>USA</b>	FCC, NVLAP
<b>Germany</b>	TUV Rheinland
<b>Japan</b>	VCCI
<b>Norway</b>	NEMKO
<b>Canada</b>	INDUSTRY CANADA, CSA
<b>R.O.C.</b>	TAF, BSMI, NCC
<b>Netherlands</b>	Telefication
<b>Singapore</b>	GOST-ASIA (MOU)
<b>Russia</b>	CERTIS (MOU)

Copies of accreditation certificates of our laboratories obtained from approval agencies can be downloaded from our web site:

[www.adt.com.tw/index.5/phtml](http://www.adt.com.tw/index.5/phtml). If you have any comments, please feel free to contact us at the following:

**Linko EMC/RF Lab:**

Tel: 886-2-26052180

Fax: 886-2-26051924

**Hsin Chu EMC/RF Lab:**

Tel: 886-3-5935343

Fax: 886-3-5935342

**Hwa Ya EMC/RF/Safety Telecom Lab:**

Tel: 886-3-3183232

Fax: 886-3-3185050

**Web Site:** [www.adt.com.tw](http://www.adt.com.tw)

The address and road map of all our labs can be found in our web site also.

## **7. APPENDIX A - MODIFICATIONS RECORDERS FOR ENGINEERING CHANGES TO THE EUT BY THE LAB**

No any modifications are made to the EUT by the lab during the test.

**--- END ---**