

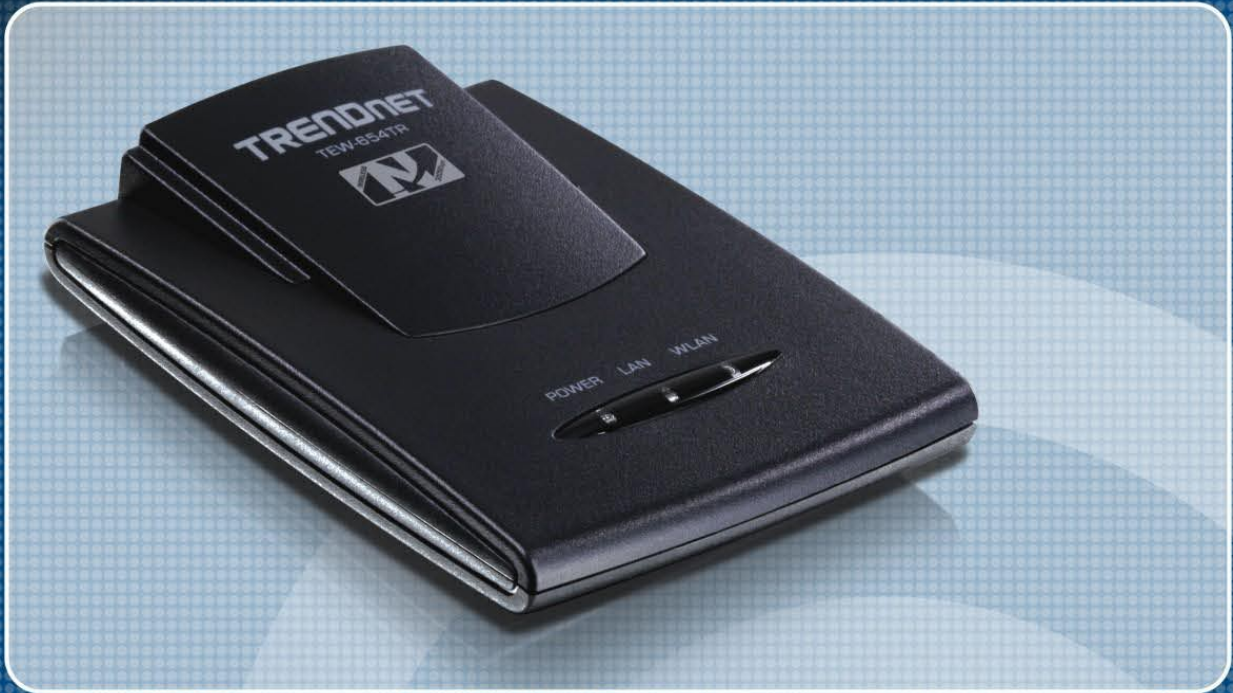

TRENDNET®



User's Guide

TEW-654TR

1.01

Table of Contents

CHAPTER 1: PRODUCT OVERVIEW

1.1 Features	5
1.2 Package Contents	6
1.3 Hardware Overview	7
1.3.1 LED Indicators	7
1.3.2 Connectors.....	8
1.4 Travel Router Modes	9
1.4.1 Switching Modes.....	10
1.5 Making Connections	11
1.5.1 Connecting the Power Adapter	11
1.5.2 Connecting the Dual Head USB Cable	11
1.5.3 Connecting the Ethernet Cable	12
1.6 System Requirements	12
1.6.1 Configuring Connections.....	12

CHAPTER 2: AP MODE

2.1 Installation	14
2.2 Web-Based Configuration	15
2.2.1 Wizard.....	16
2.2.2 Setup.....	18
Wireless Network Settings	18
Local Area Network (LAN) Settings	21
Dynamic IP (DHCP)	21
Static IP	21
Wi-Fi Protected Setup (WPS) Settings	22
2.2.3 Advanced	23
Advanced Wireless Network Settings	23
Access Control.....	24
2.2.4 System.....	25
Admin.....	25
Settings	25
Firmware	26
Time	26

2.2.5 Status	27
Device Info	27
Logs	27
Statistics.....	27
Wireless	27
 CHAPTER 3: CLIENT MODE	
3.1 Installation	29
3.1.1 Infrastructure Mode	29
3.1.2 Ad-Hoc Mode	30
3.2 Web-Based Configuration	31
3.2.1 Wizard	32
3.2.2 Setup.....	34
Wireless AP/ AP Client Settings.....	34
Local Area Network (LAN) Settings	39
Dynamic IP (DHCP)	39
Static IP.....	39
Wi-Fi Protected Setup (WPS) Settings	40
3.2.3 Advanced	40
Advanced Wireless Network Settings	40
3.2.4 System.....	41
Admin.....	41
Settings	41
Firmware	42
Time	42
3.2.5 Status.....	43
Device Info	43
Logs	43
Statistics.....	43
 CHAPTER 4: ROUTER MODE	
4.1 Installation	45
4.2 Web-Based Configuration	46
4.2.1 Wizard.....	47
4.2.2 Setup.....	50
Wireless Network Settings	50

Local Area Network (LAN) Settings	53
Wide Area Network (WAN) Settings.....	54
Dynamic IP (DHCP)	54
Static IP.....	54
PPPoE	55
PPTP.....	56
L2TP	57
Wi-Fi Protected Setup (WPS) Settings	58
Dynamic DNS Settings	59
4.2.3 Advanced	60
Access Control.....	60
IP Filter.....	61
Parental Control	62
Virtual Server	63
Special AP.....	64
DMZ	65
Firewall Settings.....	66
Advanced Network Settings.....	67
Advanced Wireless Network Settings	68
4.2.4 System.....	69
Admin.....	69
Settings	69
Firmware	70
Time	70
Ping Test	71
4.2.5 Status.....	71
Device Info.....	71
Statistics.....	72
Wireless	72
Logs	72
Appendix A: Regulatory & Safety Information	73
Appendix B: Specifications	77
Appendix C: Limited Warranty	78

Product Overview

Congratulations on your purchase of the 3-in-1 Travel Router. The Travel Router functions as an Access Point for wireless connections, an Access Point Client for wired devices to have wireless connections, and a Router to share resources such as computers, printers, files and other devices.

This User Manual will guide you on how to install and set up the Travel Router. Read it carefully and keep it for future reference.



1.1 Features

- 3-in-1 Operation Mode: Supports AP, Router, and AP Client modes
- Smallest Networking Device
- Fast Wireless Networking: Provides fast data rate connection up to 300Mbps for 802.11n devices
- Full range compatibility: Compatible with IEEE 802.11n, 802.11g, 802.11b and 802.3u devices
- Low Power Consumption: Consumes less than 2.5 watts
- USB Bus Powered: Provides better mobility.
- Quick and Easy Setup with Web-based Management Utility
- Strong Network Security - Supports the following features:
 - WPA, WPA-PSK, WPA2, and WPA2-PSK security standards
 - WPS button for Wi-Fi WPS configuration
 - PPPoE/PPTP/L2TP protocol for DSL connections
 - Firewall protection

1. PRODUCT OVERVIEW

1.2 Package Contents

Check if your package comes with the following items. If any of them is missing or appears damaged, please contact your retailer.

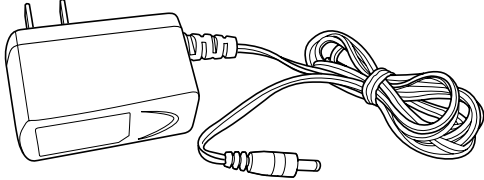
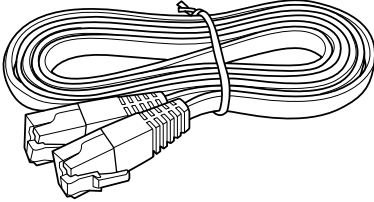
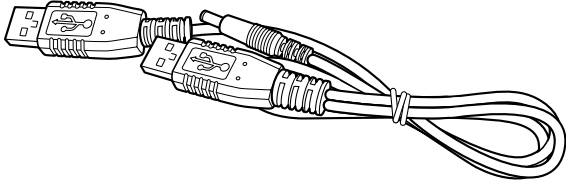
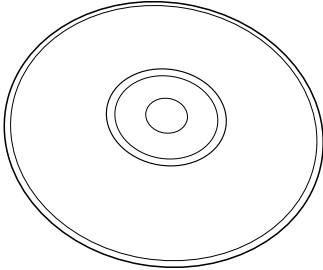
	
Travel Router	Pouch
	
Power Adapter	Ethernet Cable
	
Dual Head USB Cable	CD-ROM

1.3 Hardware Overview

1.3.1 LED Indicators

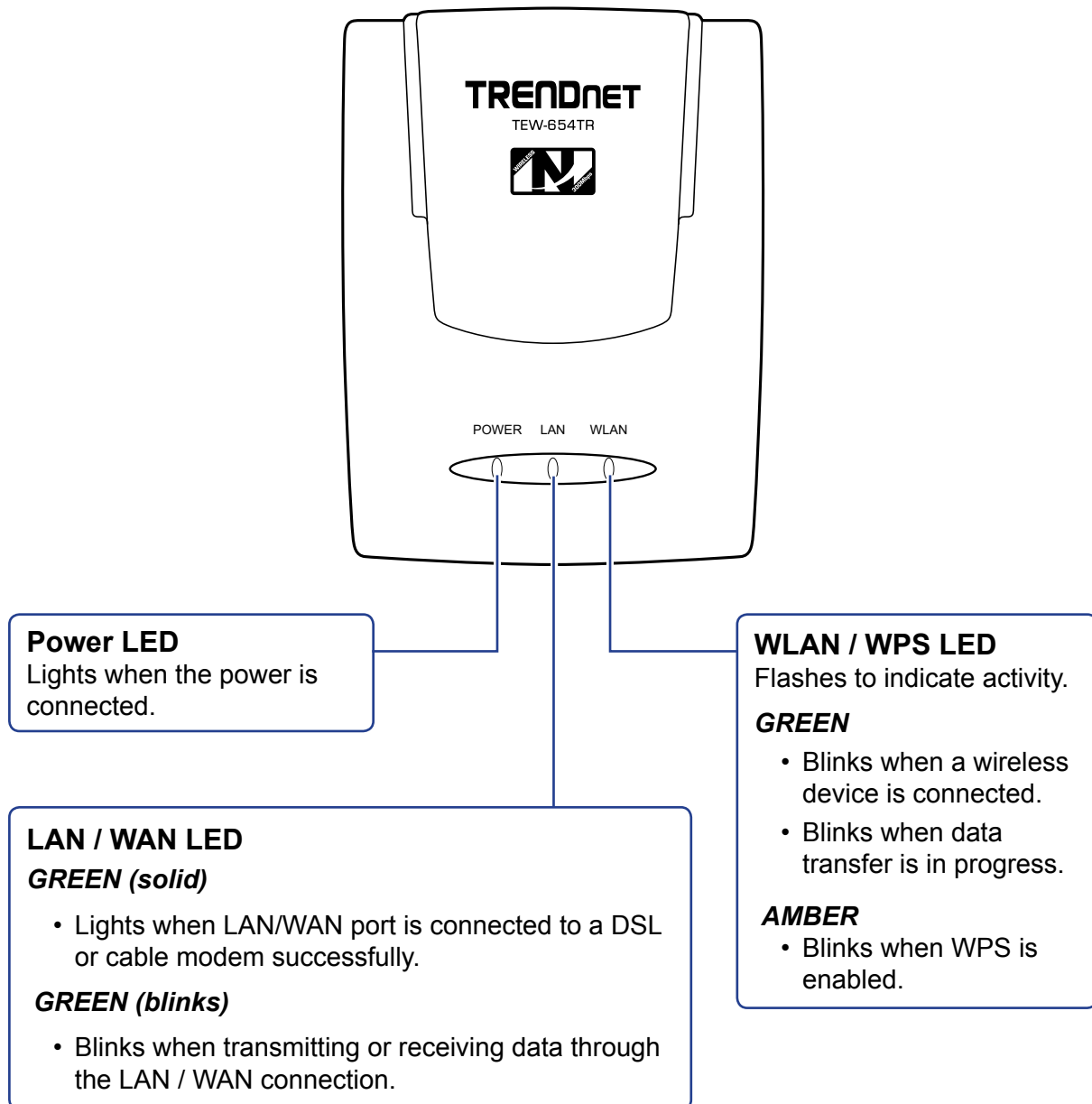

1. PRODUCT OVERVIEW

1.3.2 Connectors

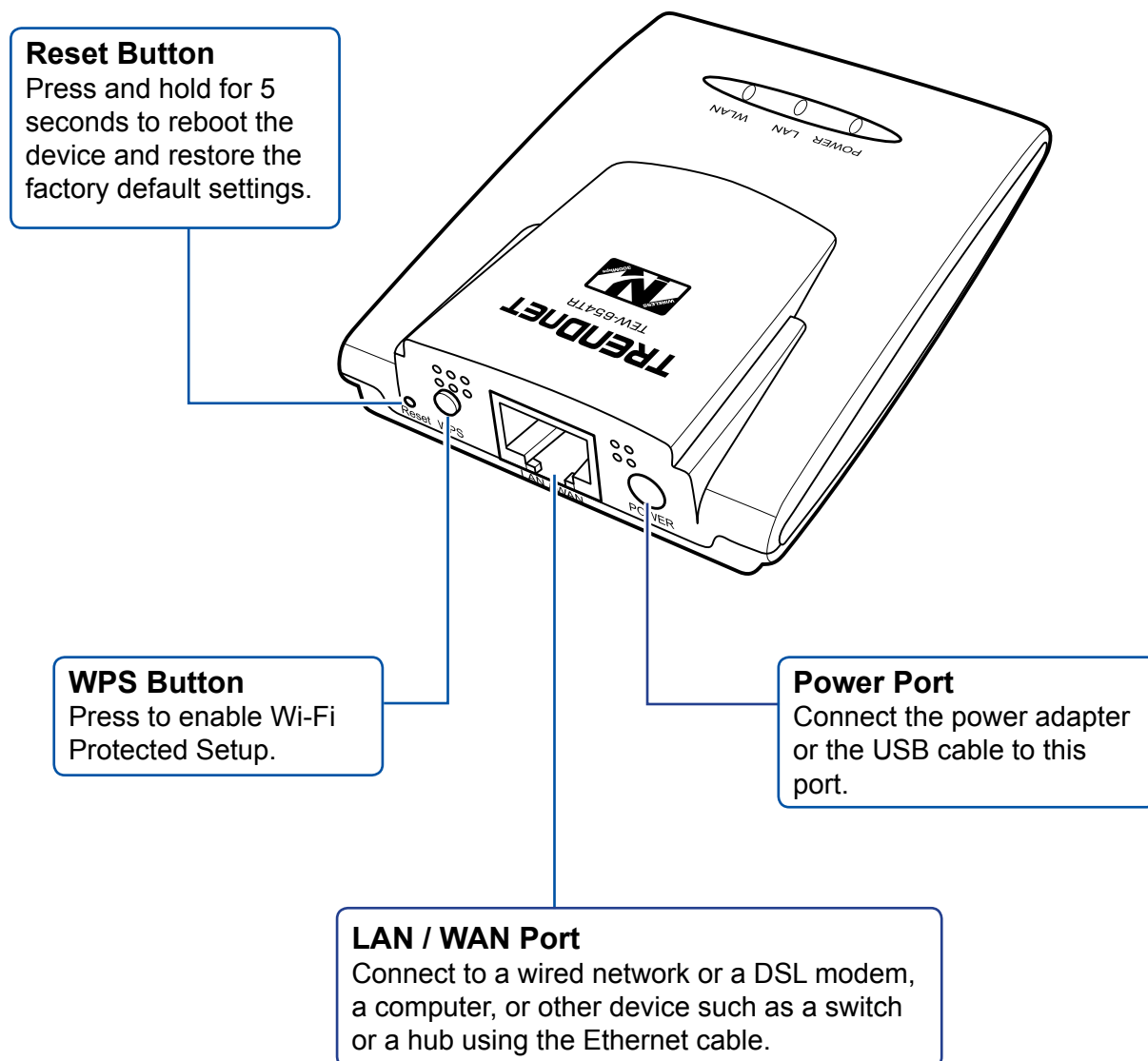

Note:

A wireless network normally requires a network name (SSID) and WPA security key to prevent unwanted access to the network. This process requires users to have knowledge of WiFi devices and their configurations. But with WPS enabled, the network name (SSID) and WPA security key of the devices are automatically configured.

1.4 Travel Router Modes

Before using the travel router, determine the type of mode you want to use:

- **Access Point (AP) Mode**

With AP mode, you can use the travel router as an access point for wireless clients to connect to the local area network (LAN) and to other wireless clients.

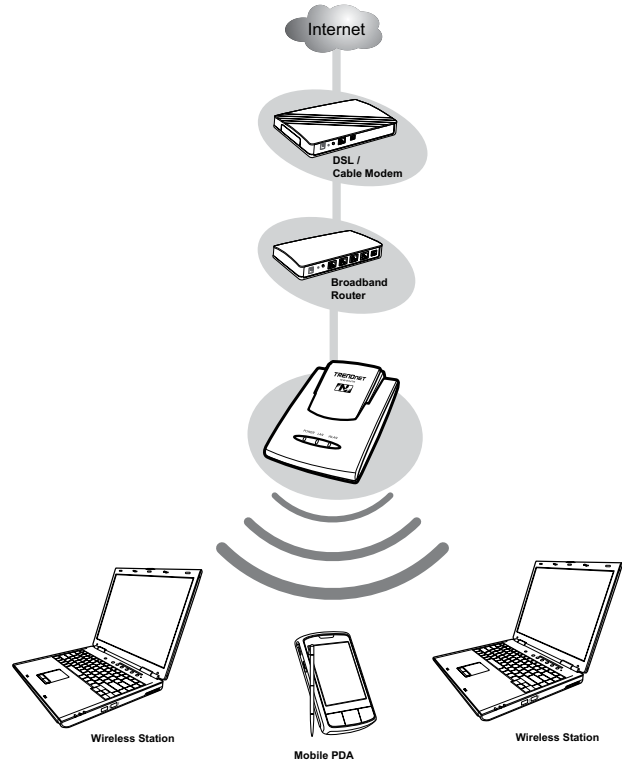

- **Client Mode**

Switch to this AP-Client mode to connect a device to the travel router using an RJ-45 cable and use the travel router as a wireless adapter. This mode enables the Ethernet-connected device to have wireless function over a network.

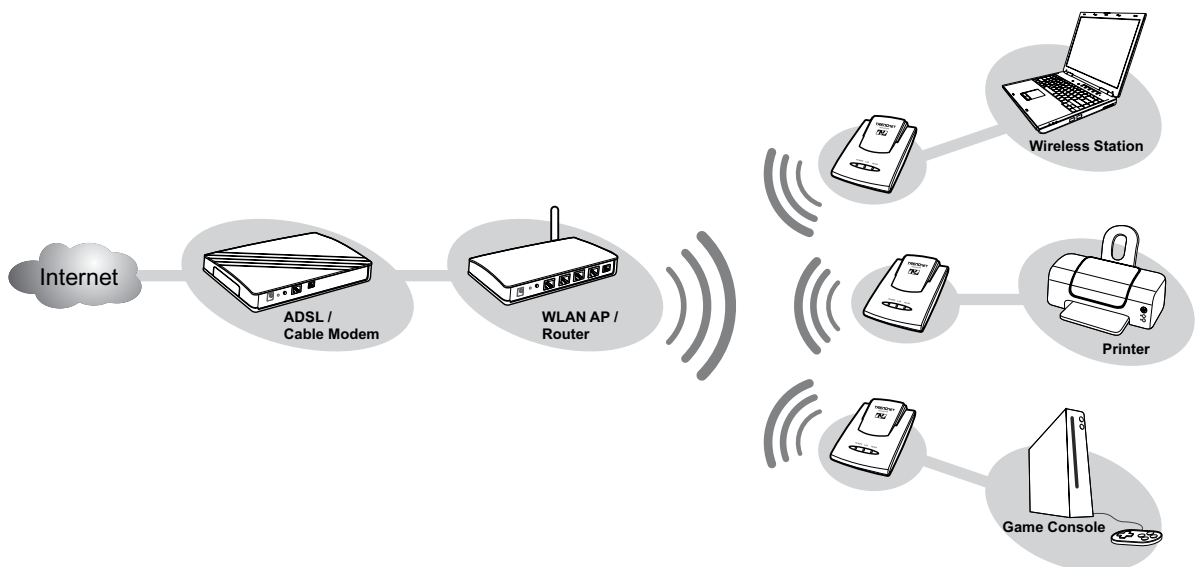

1. PRODUCT OVERVIEW

- **Router Mode**

Use this mode to connect the travel router to a DSL or cable modem. With this mode, wireless clients connect to the Internet through the travel router using one account and one IP address.

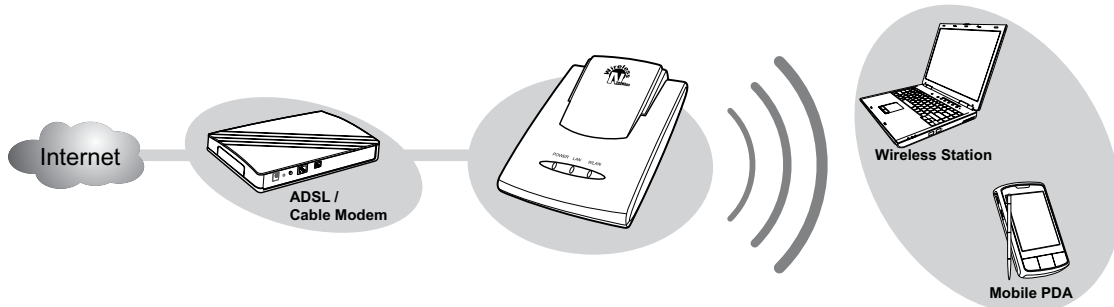

1.4.1 Switching Modes

Use the mode switch at the bottom of the travel router to change modes.

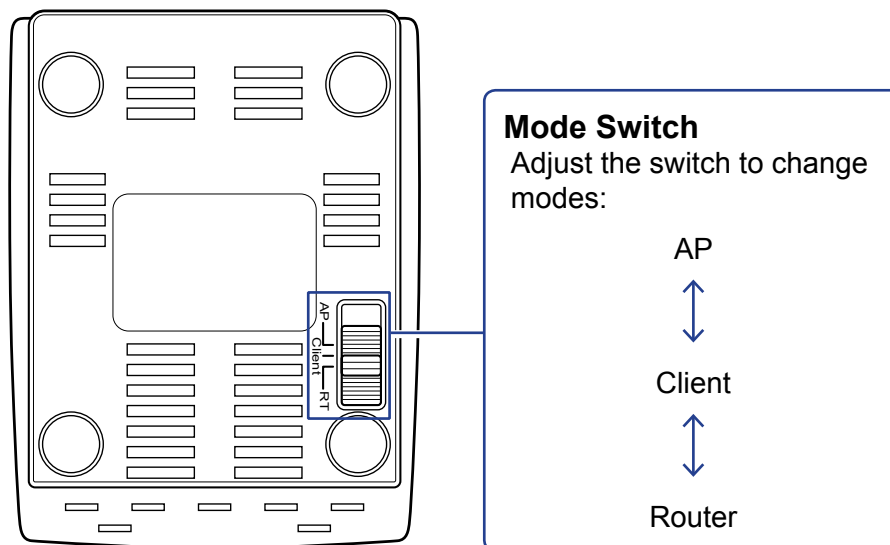

- 1 Unplug the power source (power adapter or USB cable) if it is connected.
- 2 Adjust the switch to desired mode.
- 3 Re-connect the power source to the power port.

Note:

Make sure to unplug the power source from the power port first before switching modes.

1.5 Making Connections

1.5.1 Connecting the Power Adapter

Use the power adapter to directly connect to a power outlet.

- 1 Connect the power adapter to the power port of the travel router.
- 2 Plug the power adapter to an outlet or power strip.

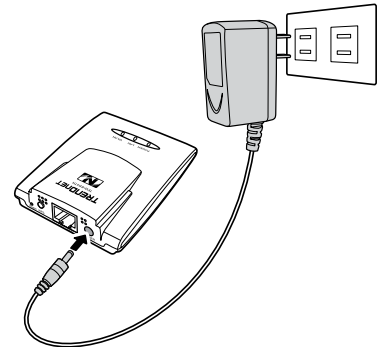

1.5.2 Connecting the Dual Head USB Cable

Some computers have over-current protection capability. This means that when the current of a USB port goes over 500mA, the connected device will not be accessed by the computer. To avoid this risk, use the dual head USB cable supplied with your travel router.

To connect, follow the steps below:

- 1 Connect the two heads of the USB cable to your computer.
- 2 Plug the other end to the power port of the travel router.

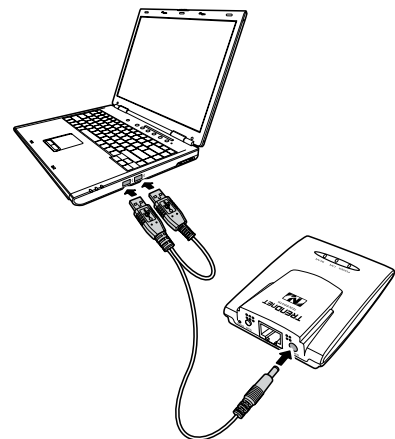

Note:

Make sure you connect the dual head USB cable to the computer first before connecting the travel router.

1. PRODUCT OVERVIEW

1.5.3 Connecting the Ethernet Cable

Use the Ethernet (RJ-45) cable to connect to a computer for wired connection or connect to a DSL or cable modem for internet connection.

- 1 Connect one end of the Ethernet cable to your computer or a DSL or cable modem.
- 2 Plug the other end to the LAN port of the travel router.

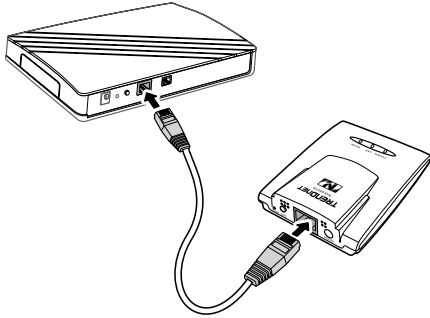

Cable modem connection

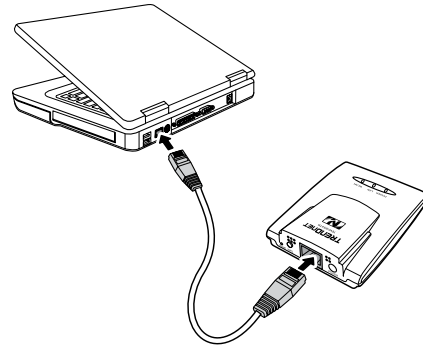

Wired computer connection

1.6 System Requirements

- Operating systems: Windows XP, Vista
- Microsoft Internet Explorer 5.5 or higher
- At least one RJ-45 Ethernet network

1.6.1 Configuring Connections

To properly detect the connections, configure your computer's network settings first. The following instructions are based on Windows XP. Non-Windows XP users will see similar screens.

- 1 For Windows XP, click **Start > Control Panel > Network Connections**. Right click on a connection, then select **Properties**.
- 2 Highlight **Internet Protocol (TCP/IP)**, then click **Properties**.
- 3 Click **Obtain an IP address automatically** and **Obtain DNS server address automatically**.
- 4 Click **OK** and **OK** again.

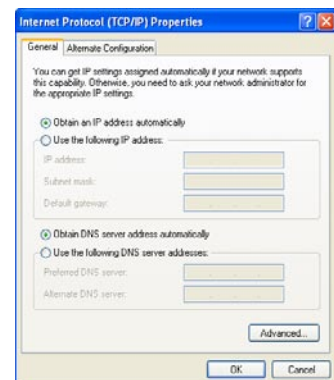
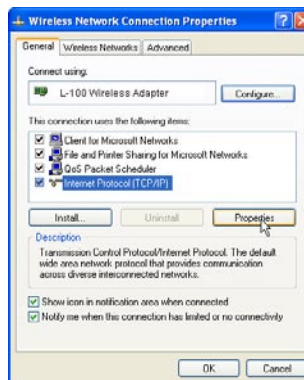

AP Mode

With AP mode, you can use the travel router as an access point of your wireless device.

Before You Begin

Checklist

- √ A valid network or Internet connection.
- √ A DSL / cable modem provided by the ISP as part of the broadband connection installation.
- √ A broadband router that connects to the DSL / cable modem for internet connection sharing.

You need to connect...

- Connect the travel router to your router or network that has a DHCP server. The travel router will obtain an IP address from the network automatically.
- Connect the LAN port of the travel router to the LAN port on your network then plug in the power adapter.
- Use wireless adapters to connect to the travel router (default SSID TRENDnet654).

2. AP MODE

2.1 Installation

Network Diagram

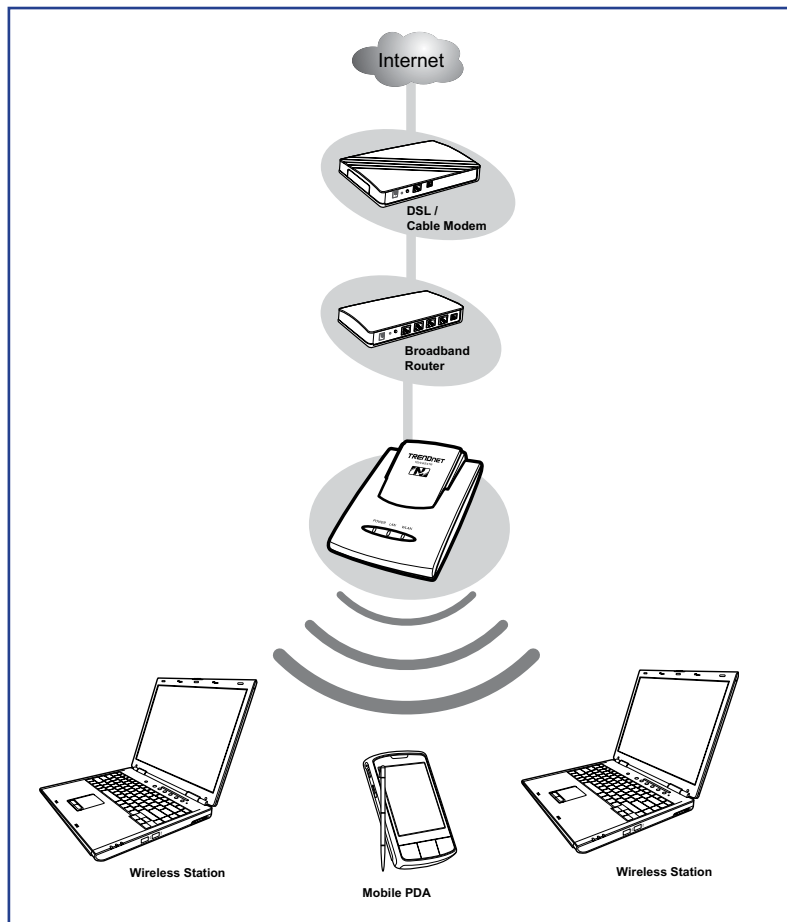

- 1 Adjust the switch to AP mode.
- 2 Connect one end of the RJ-45 cable to the travel router and the other end to the DSL or cable modem.
- 3 Turn on or plug in the DSL / cable modem and the broadband router.
- 4 Connect the power adapter to the travel router and plug to an outlet or power strip. Wait for the travel router to boot.
- 5 Check the LED indicators to verify connection.
- 6 Enable the wireless function of the wireless clients or devices.

The following LED indicators should be lit...

- ✓ Power LED (solid)
- ✓ LAN LED (solid)

Note:

Make sure you remove the power source from the travel router first before adjusting the mode switch.

2.2 Web-Based Configuration

After making all the required connections, configure the travel router using the web-based configuration utility.

How to Access the Configuration Utility

- 1 Open a web-browser and enter the default address: <http://tew-654tr/>.

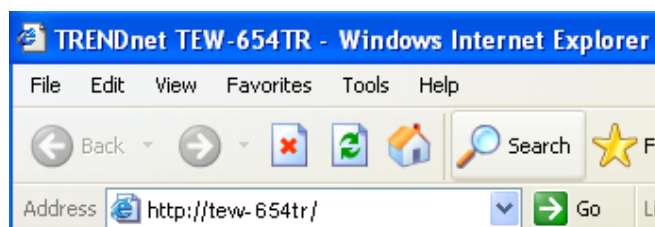

Notes:

You can also access the web-based configuration by any of the following ways:

1. If your LAN connection uses DHCP, the travel router can obtain an IP address from the DHCP server. You can either enter that IP address or the default address <http://tew-654tr/> on the browser's address field to open the web-based configuration utility.
2. If your LAN connection uses Static IP, You can either enter <http://tew-654tr/> or that static IP address on the browser's address field. The default IP address is **192.168.10.1**.

If you cannot access the configuration utility:

- Disable the Internet security software on the computer. The firewall may block access to the configuration page. Check the software firewall documentation for help.

- 2 Enter the default **User Name** and **Password**: **admin**.

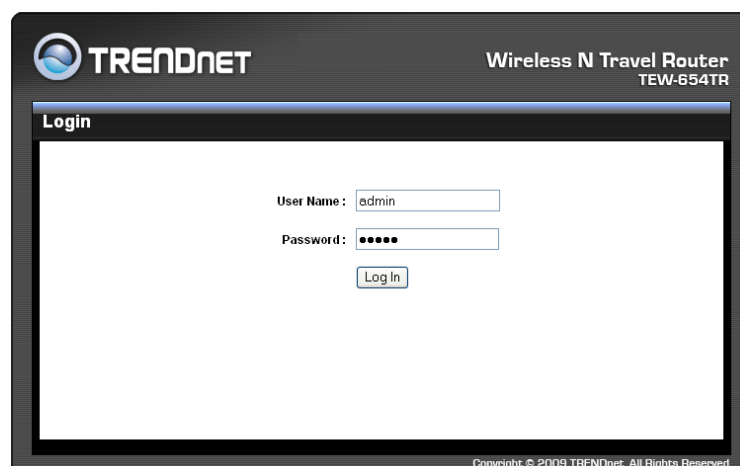

2. AP MODE

After login, the **Status > Device Info** page is displayed.

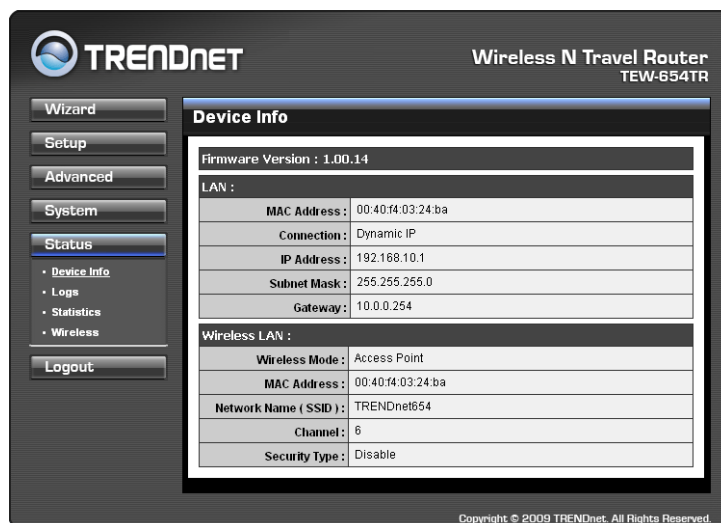

To access a page, click the buttons on the right.
To logout, click **Logout**.

Note:

For novice users, it is recommended to use the Setup Wizard to configure the travel router.

2.2.1 Wizard

Click the **Wizard** button to configure the travel router using the setup wizard.

- 1 Click **Next** to continue.



- 2 Create a new **Password**, then click **Next** to continue.

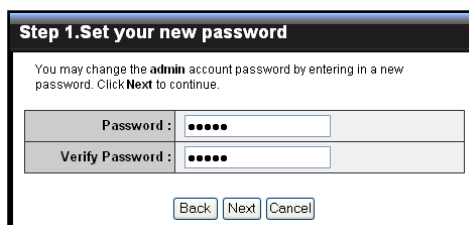

- 3 Create a new **Wireless Network Name** and select the **Channel** (6 by default). Click **Next** to continue.

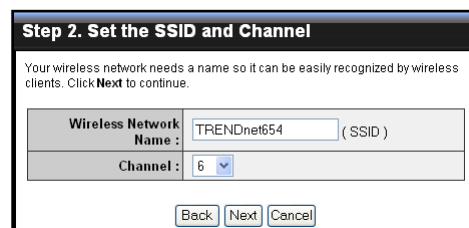

2. AP MODE

- 4 Select the type of security, then click **Next** to continue.

If you select **None**, skip to step 5.

If you select **Best...**

Enter the **Passphrase**, then click **Next** to continue.

Skip to step 5.

Step 3. Secure your Wireless Network

In order to protect your network from hackers and unauthorized users, it is highly recommended you choose one of the following wireless network security settings.

There are three levels of wireless security - Good Security, Better Security, or Best Security. The level you choose depends on the security features your wireless adapters support. (Advanced setting is in "Wireless Setup" page.)

Best :	<input type="radio"/> Select this option if your wireless adapters SUPPORT WPA2-Personal
Better :	<input type="radio"/> Select this option if your wireless adapters SUPPORT WPA-Personal
Good :	<input type="radio"/> Select this option if your wireless adapters SUPPORT WEP
None :	<input checked="" type="radio"/> Select this option if you do not want to activate any security features

Back Next Cancel

Step 3. Set your WPA2 Personal Passphrase

Once you have selected your security level - you will need to set a WPA2 Personal Passphrase.

Passphrase :

Note : You will need to enter your WPA2 Personal Passphrase into your wireless client to establish proper wireless communication.

Back Next Cancel

Note:

The Passphrase must be 8-63 ASCII characters or 64 hexadecimal characters.

If you select **Better...**

Enter the **Passphrase**, then click **Next** to continue.

Skip to step 5.

Step 3. Set your WPA Personal Passphrase

Once you have selected your security level - you will need to set a WPA Personal Passphrase.

Passphrase :

Note : You will need to enter your WPA Personal Passphrase into your wireless client to establish proper wireless communication.

Back Next Cancel

If you select **Good...**

Select the **Key Format** and **Key Length**.

Enter the **WEP Key**, then click **Next** to continue.

Step 3. Set your Wireless Security Password

Once you have selected your security level - enter the security Key Value.

Key Format :	HEX
Key Length :	64Bit
WEP Key :	mypassword

Note : You will need to enter your Wireless Security password into your wireless client to establish proper wireless communication.

Back Next Cancel

- 5 The wireless security setting is displayed. Take note of the information then click **Save**.

The information shown varies depending on the selected security level.

Step 4. Save and Restart

Below is a detailed summary of your wireless security settings. Please print this page out, or write the information on a piece of paper, so you can configure the correct settings on your wireless client adapters.

SSID :	TRENDnet654
Channel :	6

Back Save Cancel

- 6 Click **Restart** to reboot the access point and the device.

Please click the **Restart** button to reboot the device...

Restart

2. AP MODE

2.2.2 Setup

The Setup menu allows you to configure basic router settings. Click the **Setup** button then the submenu to view page.

Wireless Network Settings

Enable Wireless

Check the box to enable wireless function. Uncheck to disable it.

Wireless Network Name

The name of your wireless network, also called Service Set Identifier (SSID).

Enter up to 32 characters.

Enable Auto Channel Scan

Auto channel scan selects the channel with the least amount of interference. Check to enable auto channel scan.

Wireless Channel

Manually select the channel from the list. By default, the channel is set to 6. If Enable Auto Channel Scan is checked, this box is grayed out.

802.11 Mode

Limit the type of wireless clients to allow connection with. Select any of the following modes if your clients are:

- **2.4Ghz 802.11b/g mixed mode:** a mix of 802.11b and 11g wireless devices.
- **2.4Ghz 802.11b/g/n mixed mode:** a mix of 802.11b, 11g, 11n wireless devices.
- **2.4Ghz 802.11n only mode:** all 802.11n wireless devices.

Channel Width

Select the appropriate channel width:

- **20 MHz (Default):** Select if your wireless clients are not 802.11n.
- **Auto 20/40 MHz:** Select if your wireless clients are a mix of 802.11b, 11g, 11n wireless clients. If you are not sure which wireless clients you are using, select **Auto**.

Enable Hidden Wireless

Check to hide the SSID of your wireless network to be broadcasted when wireless clients scan for wireless networks. To display the router's SSID, keep the box unchecked (default).

WMM Enable

Wi-Fi Multimedia (WMM) improves the quality of video and voice applications

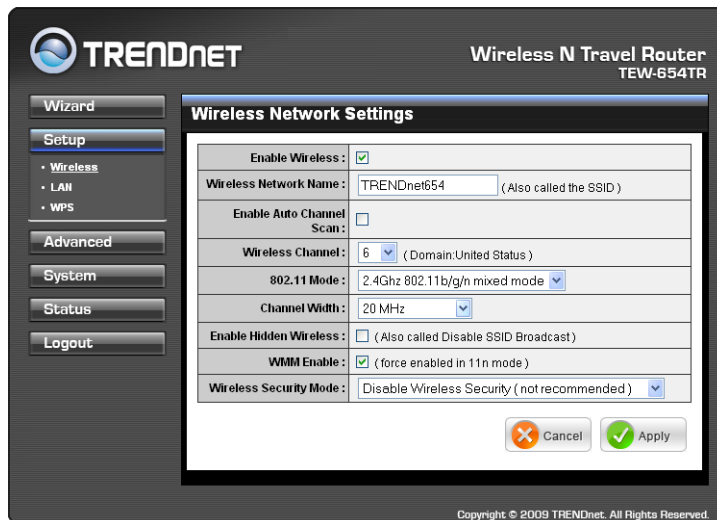

transmitted over a wireless network. This function is commonly used with multimedia applications such as a game console. Check the box to enable WMM.

Wireless Security Mode

Select the security level for your wireless network. Select the wireless security mode from the list:

- **Disable Wireless Security:** (Default) Select if you do not want to use any wireless security.
- **Enable WEP Wireless Security (basic)**
- **Enable WPA Wireless Security (enhanced)**
- **Enable WPA-2 Wireless Security (enhanced)**
- **Enable WPA-Auto Wireless Security (enhanced):** Select if you are unsure which WPA wireless security to use.

The required settings vary depending on the selected mode.

WEP

WEP (Wired Equivalent Privacy) is the basic encryption method. With WEP encryption, all wireless clients must enter the same key to connect to the access point.

Authentication

Select the type of authentication:

- **Open system:** Allows public access to the travel router via wireless communications.
- **Shared Key:** Requires users to enter the same WEP key to exchange data with other wireless devices.
- **Auto:** Select **Auto** if you are unsure which authentication suits best for your wireless clients.

Authentication :	Open System ▾
Key Length :	64Bit ▾
Key Format :	HEX ▾
Default WEP Key :	WEP Key 1 ▾
WEP Key 1 :	2994153900
WEP Key 2 :	
WEP Key 3 :	
WEP Key 4 :	

Key Length

Select the key length or the level of encryption:

- **64Bit:** Select to enter 10 hexadecimal characters with any combination of 0-9 or A-F
- **128Bit:** Select to enter 26 hexadecimal characters with any combination of 0-9 or A-F

Key Format

Select the key format:

- **ASCII:** Select to enter ASCII characters.
- **HEX:** Select to enter hexadecimal characters.

Default WEP Key

The travel router supports up to 4 sets of WEP keys. Select which WEP Key is used as the default key from the list.

2. AP MODE

WEP KEY 1-4

Manually enter a set of WEP key for each box. Select the default WEP key from the **Default WEP Key** list.

WPA / WPA-2 / WPA-Auto

WPA (Wi-Fi Protected Access) uses high grade encryption and authentication which is designed to improve WEP encryption. WPA / WPA-2 / WPA-Auto uses a passphrase to authenticate wireless connections.

Cipher Type

Select the encryption method:

- **TKIP:** Temporal Key Integrity Protocol.
- **AES:** Advanced Encryption Standard.
- **Auto:** Select **Auto** if you are unsure which method is suitable for your wireless clients.

Cipher Type:	Auto
PSK / EAP:	PSK
Passphrase:	<input type="text"/>
Confirmed Passphrase:	<input type="text"/>

PSK/EAP

Select the authentication method:

- **PSK:** Select to use a passphrase for authentication.

Passphrase

Create a passphrase. The passphrase must be 64 hexadecimal or 8-63 ASCII characters.

Confirm Passphrase

Re-enter passphrase.

- **EAP:** Select to use Extensible Authentication Protocol (EAP). This should only be used when a Radius server is connected to the travel router. You can have up to 2 Radius server settings.

IP

Enter the IP address of the Radius server.

Port

Enter the port number of the Radius server. The default value is 1812.

Shared Secret

Enter the secret key shared between the travel router and the Radius server.

Cipher Type:	Auto	
PSK / EAP:	EAP	
802.1X		
RADIUS Server 1:	IP	<input type="text" value="0.0.0.0"/>
	Port	<input type="text" value="1812"/>
	Shared Secret	<input type="text"/>
RADIUS Server 2:	IP	<input type="text" value="0.0.0.0"/>
	Port	<input type="text" value="1812"/>
	Shared Secret	<input type="text"/>

Once configuration is complete, click **Apply** to save and apply settings, or click **Cancel** to cancel changes. The travel router will restart for new settings to take effect.

Local Area Network (LAN) Settings

Dynamic IP (DHCP)

My LAN Connection is

Select **Dynamic IP (DHCP)** to obtain the IP address information automatically from your ISP. The **IP Address**, **Subnet Mask**, and **Gateway Address** are shown on the page.

Device Name

Displays the default device name.

Static IP

My LAN Connection is

Select **Static IP** if you are required to use a permanent IP address to connect to the Internet. You need to manually enter the information provided by your ISP.

IP Address

Enter the IP address provided by your ISP.

Subnet Mask

Enter the subnet mask provided by your ISP.

Gateway Address

Enter the gateway address provided by you ISP.

Primary / Secondary DNS Server

Enter the DNS server addresses provided by your ISP.

Enable DHCP Server

Check the box to use the travel router as a DHCP server for your network. A DHCP server automatically assigns an IP address to each client on your network. This function is disabled by default.

DHCP IP Address Range

Enter the starting and ending range of IP addresses that can be assigned to clients on your network.

DHCP Lease Time

Select the length of time to “lease” the dynamic IP address from the list. The default time is **1 Week**.

TRENDNET Wireless N Travel Router
TEW-654TR

Wizard
Setup
• Wireless
• LAN
• WPS
Advanced
System
Status
Logout

LAN Connection Type

Choose the mode to be used by the device.

My LAN Connection is:

Device Name:

DYNAMIC IP (DHCP) LAN CONNECTION TYPE :

IP Address Information.

IP Address:

Subnet Mask:

Gateway Address:

Copyright © 2009 TRENDnet. All Rights Reserved.

TRENDNET Wireless N Travel Router
TEW-654TR

Wizard
Setup
• Wireless
• LAN
• WPS
Advanced
System
Status
Logout

LAN Connection Type

Choose the mode to be used by the device.

My LAN Connection is:

Device Name:

STATIC IP ADDRESS LAN CONNECTION TYPE

Enter the static address information.

IP Address:

Subnet Mask:

Gateway Address:

Primary DNS Server:

Secondary DNS Server: (Optional)

DHCP SERVER SETTINGS

Use this section to configure the built-in DHCP Server to assign IP addresses to the computers on your network.

Enable DHCP Server:

DHCP IP Address Range: to
(addresses within the LAN subnet)

DHCP Lease Time:

Domain Name:

DYNAMIC DHCP CLIENT LIST

Host Name	IP Address	MAC Address	Expired Time
dell188-en	192.168.10.101	00:1b:77:67:d2:95	Tue Jan 8 00:01:04 2008
karan196	192.168.10.102	00:11:95:c8:11:d3	Tue Jan 8 00:01:14 2008

Copyright © 2009 TRENDnet. All Rights Reserved.

2. AP MODE

Domain Name

Enter the domain name (optional).

Dynamic DHCP Client List window

Displays the list of DHCP clients.

Once configuration is complete, click **Apply** to save and apply settings, or click **Cancel** to cancel changes. The travel router will restart for new settings to take effect.

Wi-Fi Protected Setup (WPS) Settings

Wi-Fi Protected Setup (WPS) is an optional certification program from the Wi-Fi Alliance that is designed to ease the task of setting up and configuring security on a wireless network.

Enable

Check the box to enable WPS function.

Status

Displays WPS status:
UnConfigured or **Configured**.

The screenshot shows the 'Wi-Fi Protected Settings' configuration window on a Trendnet router. The interface includes a sidebar with navigation options: Wizard, Setup (selected), Wireless, LAN, WPS, Advanced, System, Status, and Logout. The main content area is titled 'Wi-Fi Protected Settings' and contains the following fields and controls:

- Enable:** A checked checkbox.
- Status:** Radio buttons for 'UnConfigured' (selected) and 'Configured'.
- PIN Settings:**
 - Self-PIN Number:** 02060101
 - Client PIN Number:** 02060101, with a 'Start PIN' button next to it.
- Push Button Configuration:** A 'Start PBC' button.
- Authentication, Encryption, Key:** Three empty input fields.
- Buttons:** 'Cancel' (with a red X icon) and 'Apply' (with a green checkmark icon).

There are 2 methods used in WPS configuration:

- **Push Button:** If the client device has a WPS button.
- **PIN Number:** If the client device has a WPS PIN number.

Self-PIN Number

Displays the default PIN number of the travel router.

Client PIN Number

Enter the client's PIN number. This PIN number will be used to communicate with the travel router to connect to the network.

Start PIN

Click this button to start WPS configuration process if the client device has a WPS PIN number.

Push Button Configuration

Click the **Start PBC** button to start WPS configuration process if the client device has a WPS button.

Once configuration is complete, click **Apply** to save and apply settings, or click **Cancel** to cancel changes. The travel router will restart for new settings to take effect.

2.2.3 Advanced

The Advanced menu configurations greatly affect the operating performance of the travel router. This menu is intended for advanced users. It is recommended to retain the default settings. Do not change any of configurations if you are unsure about it.

Advanced Wireless Network Settings

Beacon Period

Enter the interval period of time for the access point to send out beacons to synchronize the wireless network. The default value is 100 milliseconds.

RTS Threshold

The default and the recommended value is 2346. Should you encounter inconsistent data flow, only minor adjustments should be made.

Fragmentation Threshold

Fragmentation threshold refers to the amount of packets that will be fragmented before transmission. The default and recommended value is 2346 bytes.

DTIM Interval

This value indicates the interval of Delivery Traffic Indication Message (DTIM). A DTIM is a countdown field informing clients of the next window for listening to broadcast and multicast messages. The default value is 1.

Preamble Type

Preamble is use to limit the packets of data for transmission. When the connection is bad, it is recommended to use the **Short Preamble**.

Enable IGMP Snooping

Check the box to enable Internet Group Management Protocol (IGMP) snooping. This function restrains multicast traffic in a switched network.

Once configuration is complete, click **Apply** to save and apply settings, or click **Cancel** to cancel changes. The travel router will restart for new settings to take effect.

The screenshot shows the 'Advance Wireless Settings' interface for a TRENDNET Wireless N Travel Router (TEW-654TR). The interface includes a sidebar with navigation buttons: Wizard, Setup, Advanced (highlighted), Advance Wireless Settings, and Access Control. The main content area is titled 'Advance Wireless Settings' and contains the following configuration options:

- Beacon Period:** 100 (msec, range: 20~1024, default:100)
- RTS Threshold:** 2346 (range: 1~2347, default:2346)
- Fragmentation Threshold:** 2346 (range: 256~2346, default:2346, even number only)
- DTIM Interval:** 1 (range: 1~255, default:1)
- Preamble Type:** Long Preamble (selected), Short Preamble
- Enable IGMP Snooping:**

At the bottom right, there are 'Cancel' and 'Apply' buttons. The copyright notice at the bottom reads: Copyright © 2009 TRENDnet. All Rights Reserved.

2. AP MODE

Access Control

The Access Control menu allows you deny or only allow access to certain wireless clients by filtering their MAC addresses.

Access Control

Select the type of access from the list:

- **Disable:** Disable access control.
- **Reject:** Deny the MAC addresses shown on the list to access the wireless network.
- **Accept:** Only allow the MAC addresses shown on the list to access to wireless network.

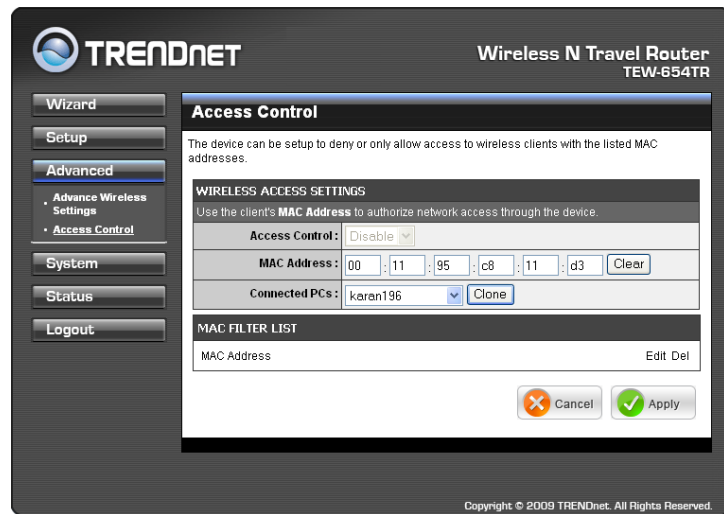

MAC Address

Displays the cloned MAC address. To clear the MAC address, click **Clear**.

Connected PCs

Select the name of the connected client that you want to clone. Click **Clone** to clone its MAC address.

To grant or block access:

- 1 Select the client from the **Connected PCs** list, then click **Clone**. The cloned MAC address is displayed in the **MAC Address** field.
- 2 Click **Apply** to add MAC address in the **MAC Filter List**. The system will reboot.
- 3 After rebooting, select the **Access Control** option: **Disable, Reject** or **Accept**.
- 4 Click **Apply** to save setting. The system will reboot for changes to take effect.
- 5 To add more MAC addresses, repeat steps 1-4.

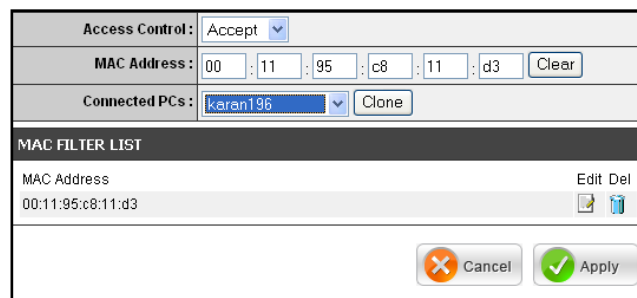

To edit the access control of a MAC address, click its corresponding  icon.

To delete the MAC address from the list, click its corresponding  icon.

2.2.4 System

The System menu provides password configuration, backup and restore settings, firmware update and date and time settings.

Admin

The Admin submenu allows you to change the default user name and password which are use to login.

New User Name

Enter the new user name here.

New / Confirm Password

Enter the password.

Click **Apply** to save and apply settings, or click **Cancel** to cancel changes. The travel router will restart for new settings to take effect.

Settings

The Settings submenu provides backup and restore setting functions.

Save and Restore	
Save Settings To Local Hard Drive :	<input type="button" value="Save"/>
Load Settings From Local Hard Drive :	<input type="text"/> <input type="button" value="Browse..."/> <input type="button" value="Upload Settings"/>
Restore To Factory Default Settings :	<input type="button" value="Restore Device"/>
Restart Device :	<input type="button" value="Restart"/>

Save Settings to Local Hard Drive

Use this function to save the current configuration settings to your local hard drive. Click **Save**, then select the folder where you want to save the file.

Load Settings From Local Hard Drive

Use this function to retrieve saved configuration settings from the local hard drive.

- 1 Click **Browse** to locate the file.
- 2 Click **Upload Settings** to transfer and apply the settings to the travel router.

Restore to Factory Default Settings

Click **Restore Device** to restore all configurations to the factory default settings. All changes in configuration will be deleted.

Restart Device

Click **Restart** to reboot the travel router.

2. AP MODE

Firmware

The Firmware submenu allows you to upgrade the firmware to the latest version.

Current Firmware Version

Displays the current firmware version.

Firmware Date

Displays the date when the firmware was last updated.

Current Firmware info	
Current Firmware Version:	1.00.14
Firmware Date:	Tue, 05 May 2009
	<input type="text"/> Browse...

Cancel Apply

- 1 Download the latest firmware from the manufacturer's website, and save it to a disk.
- 2 Click Browse to locate the file.
- 3 Click **Apply** to start firmware update. The system will reboot to complete update.

Time

The Time submenu allows you to manually adjust the system time settings or synchronize it with a server.

Current Time

Displays the current date and time settings.

Time Zone

Select the time zone in your area.

Synchronize the clock with

Select:

- **Manual:** To manually adjust the date and time.
- **Automatic:** To synchronize date and time with the server.

System Time Settings	
Current Time:	Jan/01/2008 00:24:55
Time Zone:	(GMT-08:00) Pacific Time (US/Canada), Tijuana
Synchronize the clock with:	Manual
Default NTP server:	<input type="text"/>
Set the time:	Year 2008 Month Jan Day 01 Hour 00 Minute 00 second 00 <input type="button" value="Set Time"/>
Enable Daylight Saving:	<input type="checkbox"/> Start Mar 3rd Sun End Nov 2nd Sun

Cancel Apply

Default NTP Server

Enter the NTP server address to synchronize the date and time with.

Set the Time

Use this option to manually set the date and time. This option is only available when **Synchronize the clock with** is set to **Automatic**.

Enable Daylight Saving

Check the box to enable daylight saving time. Use the Start and End field boxes to specify the starting and ending dates.

Click **Apply** to save and apply settings, or click **Cancel** to cancel changes. The travel router will restart for new settings to take effect.

2.2.5 Status

The Status menu displays device, logs, traffic, and connection information.

Device Info

This page displays the Firmware Version, LAN and Wireless LAN information.

Device Info	
Firmware Version : 1.00.14	
LAN :	
MAC Address :	00:40:f4:03:24:ba
Connection :	Dynamic IP
IP Address :	192.168.10.1
Subnet Mask :	255.255.255.0
Gateway :	10.0.0.254
Wireless LAN :	
Wireless Mode :	Access Point
MAC Address :	00:40:f4:03:24:ba
Network Name (SSID) :	TRENDnet654
Channel :	6
Security Type :	Disable

Logs

This page displays the recorded events that occur within the wireless network.

Click the following buttons to view the **First Page**, **Last Page**, **Previous Page**, and **Next Page**.

To delete log data, click **Clear Log**.

To change log settings, click **Log Settings**.

To refresh list, click **Refresh**.

View Log	
View Log displays the activities occurring on the device.	
Log Files :	
<input type="button" value="First Page"/> <input type="button" value="Last Page"/> <input type="button" value="Previous Page"/> <input type="button" value="Next Page"/>	
<input type="button" value="Clear Log"/> <input type="button" value="Log Settings"/> <input type="button" value="Refresh"/>	
Page 1 of 8	
Time	Message
May 14 18:21:56	UDHCPD sending OFFER of 192.168.10.105
May 14 18:21:56	UDHCPD sendOffer : device_lan_ip=192.168.10.1 , device_lan_subnet_mask=255.255.255.0
May 14 18:21:55	UDHCPD sending OFFER of 192.168.10.105
May 14 18:21:55	UDHCPD sendOffer : device_lan_ip=192.168.10.1 , device_lan_subnet_mask=255.255.255.0
May 14 18:21:54	UDHCPD sending OFFER of 192.168.10.105
May 14 18:21:54	UDHCPD sendOffer : device_lan_ip=192.168.10.1 , device_lan_subnet_mask=255.255.255.0
May 14 18:21:53	UDHCPD sending OFFER of 192.168.10.105
May 14 18:21:53	UDHCPD sendOffer : device_lan_ip=192.168.10.1 , device_lan_subnet_mask=255.255.255.0
May 14 18:21:52	UDHCPD sending OFFER of 192.168.10.105
May 14 18:21:52	UDHCPD sendOffer : device_lan_ip=192.168.10.1 , device_lan_subnet_mask=255.255.255.0

Statistics

This page displays the traffic statistics of received and transmitted packets that passed through the travel router.

Click **Refresh** to refresh table.

Traffic Statistics		
Traffic Statistics display Receive and Transmit packets passing through the device.		
	Receive	Transmit
LAN	10026 Packets	728 Packets
Wireless	11414 Packets	9922 Packets
<input type="button" value="Refresh"/>		

Wireless

This page displays the information of connected wireless clients such as the time of connection and their MAC addresses.

Connected Wireless Client List	
Connected Time	MAC Address
00:15:23	00:11:95:C8:11:D3
00:04:17	00:1B:77:67:D2:95

3

Client Mode

With Client mode, you can transform Ethernet-enabled devices to have wireless function using the travel router.

Before You Begin

Checklist

- ✓ A valid network or Internet connection.
- ✓ A DSL / cable modem provided by the ISP as part of the broadband connection installation.
- ✓ A broadband router that connects to the DSL / cable modem for internet connection sharing.

You need to connect...

- Connect the travel router to your router or network that has a DHCP server. The travel router will obtain an IP address from the network automatically.
- Connect the LAN port of the travel router to the LAN port on your network then plug in the power adapter.
- Use wireless adapters to connect to the travel router (default SSID TRENDnet654).

3.1 Installation

3.1.1 Infrastructure Mode

With infrastructure mode, all clients connect to a central access point (AP), all data pass through this access point.

Network Diagram

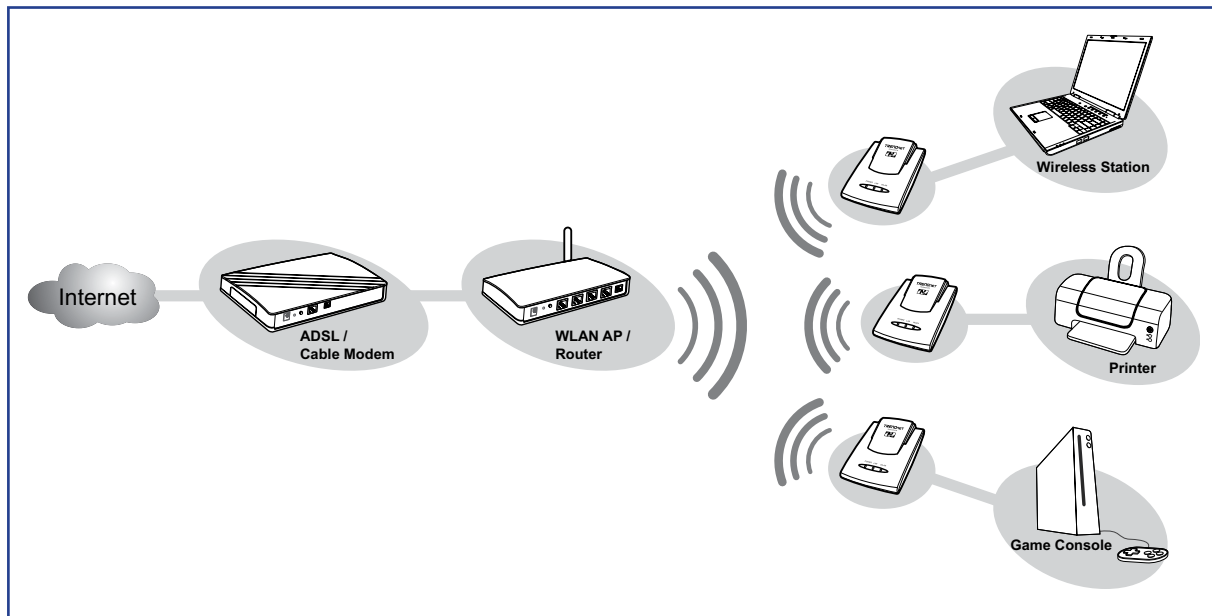

- 1 Adjust the switch to Client mode.
- 2 Connect one end of the RJ-45 cable to the travel router and the other end to the LAN port of the computer or other device.
- 3 Turn on or plug in the DSL / cable modem and the wireless router.
- 4 Connect the power adapter to the travel router and plug to an outlet or power strip. Wait for the travel router to boot.
- 5 Check the LED indicators to verify connection.

The following LED indicators should be lit...

- ✓ Power LED (solid)
- ✓ LAN LED (solid)
- ✓ WLAN LED (flashing green)

3. CLIENT MODE

3.1.2 Ad-Hoc Mode

Ad-Hoc is a client setting that provides independent peer-to-peer connectivity in a wireless LAN. With this mode, devices communicate directly with each other. A good example is the communication between two game consoles. See diagram below.

Network Diagram



- 1 Adjust the switch to Client mode.
- 2 Connect one end of the RJ-45 cable to the travel router and the other end to the game console or other devices.
- 3 Connect the power adapter to the travel router and plug to an outlet or power strip. Wait for the travel router to boot.

The following LED indicators should be lit...

- ✓ Power LED (solid)
- ✓ LAN LED (solid)
- ✓ WLAN LED (flashing green)

3.2 Web-Based Configuration

After making all the required connections, configure the travel router using the web-based configuration utility.

How to Access the Configuration Utility

- 1 Open a web-browser and enter default address: <http://client-654tr/>.

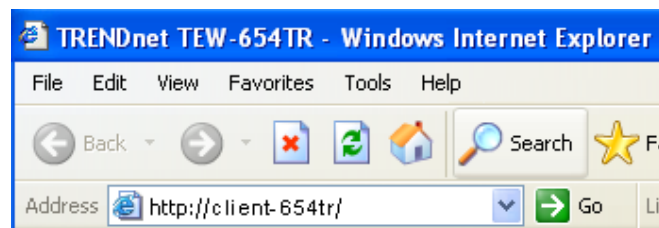

Notes:

You can also access the web-based configuration by any of the following ways:

1. If your LAN connection uses DHCP, the travel router can obtain an IP address from the DHCP server. You can either enter that IP address or the default address <http://client-654tr/> on the browser's address field to open the web-based configuration utility.
2. If your LAN connection uses Static IP, You can either enter <http://client-654tr/> or that static IP address on the browser's address field. The default IP address is **192.168.10.1**.

If you cannot access the configuration utility:

- Disable the Internet security software on the computer. The firewall may block access to the configuration page. Check the software firewall documentation for help.

- 2 Enter the default **User Name** and **Password**: **admin**.

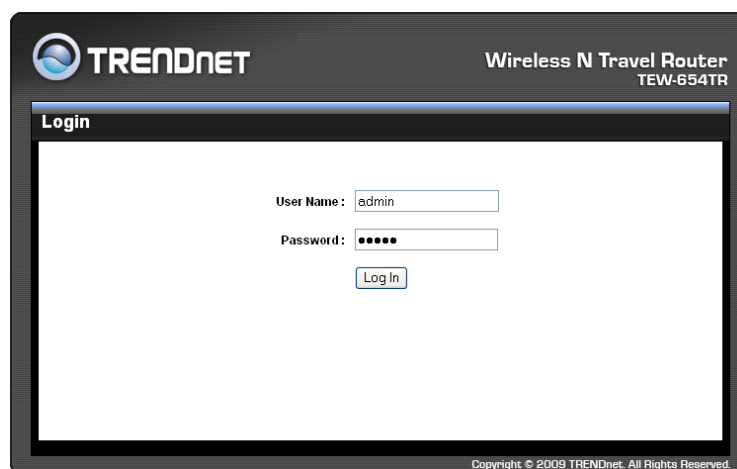

3. CLIENT MODE

After login, the **Status > Device Info** page is displayed.

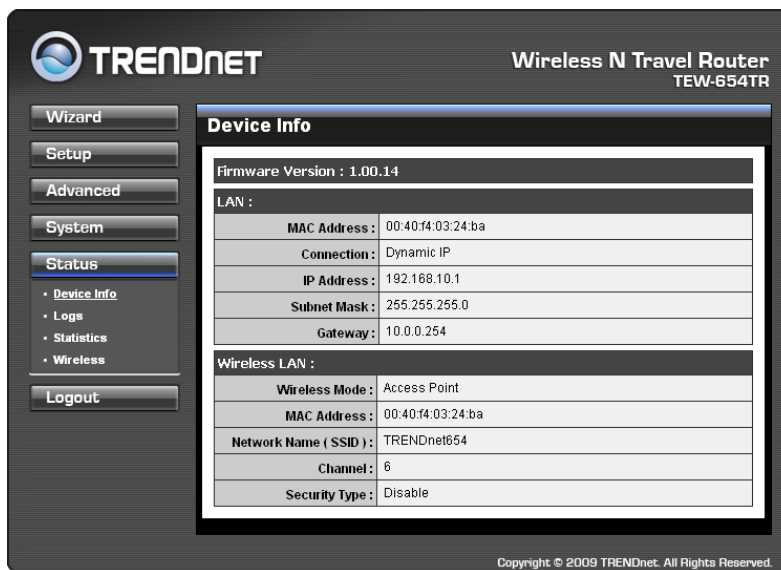

To access a page, click the buttons on the right.

To logout, click **Logout**.

Note:

For novice users, it is recommended to use the Setup Wizard to configure the travel router.

3.2.1 Wizard

Click the **Wizard** button to configure the travel router using the setup wizard.

1 Click **Next** to continue.



2 Create a new **Password**, then click **Next** to continue.

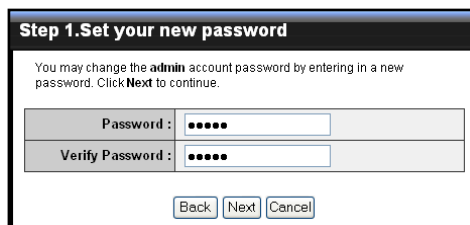

3 Create a new **Wireless Network Name** and select the **Channel** (6 by default). Click **Next** to continue.

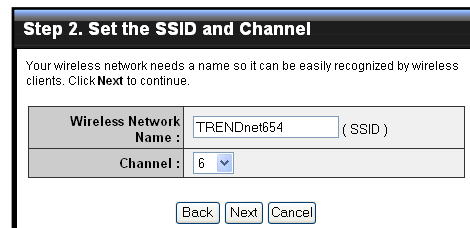

3. CLIENT MODE

- 4 Select the type of security, then click **Next** to continue.

If you select **None**, skip to step 5.

If you select **Best...**

Enter the **Passphrase**, then click **Next** to continue.

Skip to step 5.

Step 3. Secure your Wireless Network

In order to protect your network from hackers and unauthorized users, it is highly recommended you choose one of the following wireless network security settings.

There are three levels of wireless security - Good Security, Better Security, or Best Security. The level you choose depends on the security features your wireless adapters support. (Advanced setting is in "Wireless Setup" page.)

Best :	<input type="radio"/> Select this option if your wireless adapters SUPPORT WPA2-Personal
Better :	<input type="radio"/> Select this option if your wireless adapters SUPPORT WPA-Personal
Good :	<input type="radio"/> Select this option if your wireless adapters SUPPORT WEP
None :	<input checked="" type="radio"/> Select this option if you do not want to activate any security features

Back Next Cancel

Step 3. Set your WPA2 Personal Passphrase

Once you have selected your security level - you will need to set a WPA2 Personal Passphrase.

Passphrase :

Note : You will need to enter your WPA2 Personal Passphrase into your wireless client to establish proper wireless communication.

Back Next Cancel

Note:

The Passphrase must be 8-63 ASCII characters or 64 hexadecimal characters.

If you select **Better...**

Enter the **Passphrase**, then click **Next** to continue.

Skip to step 5.

Step 3. Set your WPA Personal Passphrase

Once you have selected your security level - you will need to set a WPA Personal Passphrase.

Passphrase :

Note : You will need to enter your WPA Personal Passphrase into your wireless client to establish proper wireless communication.

Back Next Cancel

If you select **Good...**

Select the **Key Format** and **Key Length**.

Enter the **WEP Key**, then click **Next** to continue.

Step 3. Set your Wireless Security Password

Once you have selected your security level - enter the security Key Value.

Key Format :	HEX
Key Length :	64Bit
WEP Key :	<input type="text" value="mypassword"/>

Note : You will need to enter your Wireless Security password into your wireless client to establish proper wireless communication.

Back Next Cancel

- 5 The wireless security setting is displayed. Take note of the information then click **Save**.

The information shown varies depending on the selected security level.

Step 4. Save and Restart

Below is a detailed summary of your wireless security settings. Please print this page out, or write the information on a piece of paper, so you can configure the correct settings on your wireless client adapters.

SSID :	TRENDnet654
Channel :	6

Back Save Cancel

- 6 Click **Restart** to reboot the access point and the device.

Please click the **Restart** button to reboot the device...

Restart

3. CLIENT MODE

3.2.2 Setup

The Setup menu allows you to configure basic router settings. Click the **Setup** button then the submenu to view page.

Wireless AP/ AP Client Settings

Enable Access Point

Click this button to access Wireless Network Settings page. See page 36.

Site Survey

Click this button to scan for available networks. Available networks are listed on the table. To select a network, click on the network's radio button.

Wireless Network Name

Displays the name of the selected wireless network, also called Service Set Identifier (SSID).

Wireless Channel

Displays the wireless channel of the selected network.

Wireless Security Mode

Displays the security mode of the selected network.

- **Disable Wireless Security:** No wireless security is set.
- **Enable WEP Wireless Security (basic)**
- **Enable WPA Wireless Security (enhanced)**
- **Enable WPA-2 Wireless Security (enhanced)**

The required settings vary depending on the wireless security mode.

WEP

WEP (Wired Equivalent Privacy) is the basic encryption method. With WEP encryption, all wireless clients must enter the same key to connect to the access point.

Authentication

Select the type of authentication:

- **Open system:** Allows public access to the travel router via wireless communications.
- **Shared Key:** Requires users to enter the same WEP key to exchange data with other wireless devices.

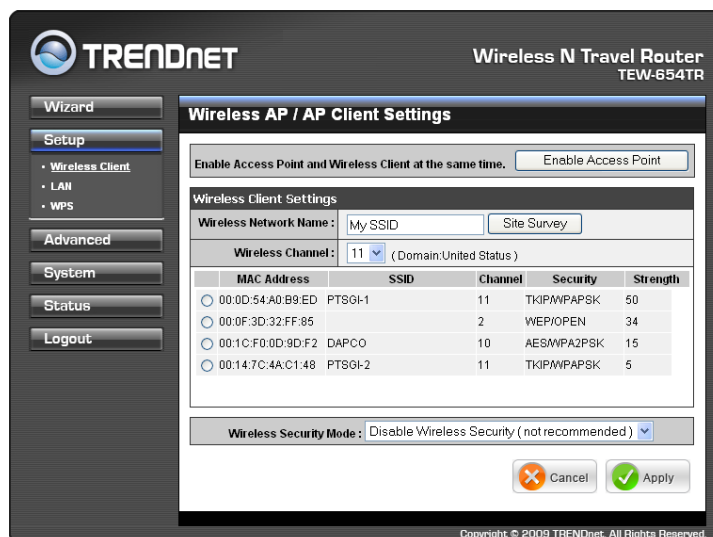

Authentication :	Open System
Key Length :	64Bit
Key Format :	HEX
Default WEP Key :	WEP Key 1
WEP Key 1 :	2994153900
WEP Key 2 :	
WEP Key 3 :	
WEP Key 4 :	

3. CLIENT MODE

- **Auto:** Select **Auto** if you are unsure.

Key Length

Select the key length or the level of encryption:

- **64Bit:** Select to enter 10 hexadecimal characters with any combination of 0-9 or A-F
- **128Bit:** Select to enter 26 hexadecimal characters with any combination of 0-9 or A-F

Key Format

Select the key format:

- **ASCII:** Select to enter ASCII characters.
- **HEX:** Select to enter hexadecimal characters.

Default WEP Key

Select which WEP Key is used as the default key from the list.

WEP KEY 1-4

Manually enter a set of WEP key for each box. Select the default WEP key from the **Default WEP Key** list.

WPA / WPA-2

Cipher Type

Select the encryption method:

- **TKIP:** Temporal Key Integrity Protocol.
- **AES:** Advanced Encryption Standard.

Cipher Type:	TKIP ▾
Passphrase:	<input type="text"/>
Confirmed Passphrase:	<input type="text"/>

Passphrase

Enter the required passphrase to connect to the selected network. The passphrase must be 64 hexadecimal or 8-63 ASCII characters.

Confirm Passphrase

Re-enter passphrase.

Click **Apply** to save and apply settings, or click **Cancel** to cancel changes. The travel router will restart for new settings to take effect.

3. CLIENT MODE

Wireless Network Settings

Use this page to enable and setup the travel router as an access point and wireless client at the same time.

Enable Access Point

Check the box to enable access point function. Uncheck to disable it.

Wireless Network Name

The name of your wireless network, also called Service Set Identifier (SSID). Enter up to 32 characters.

Enable Auto Channel Scan

Auto channel scan selects the channel with the least amount of interference. Check to enable auto channel scan.

Wireless Channel

Manually select the channel from the list. By default, the channel is set to 6. If Enable Auto Channel Scan is checked, this box is grayed out.

802.11 Mode

Limit the type of wireless clients to allow connection with. Select any of the following modes if your clients are:

- **2.4Ghz 802.11b/g mixed mode:** a mix of 802.11b and 11g wireless devices.
- **2.4Ghz 802.11b/g/n mixed mode:** a mix of 802.11b, 11g, 11n wireless devices.
- **2.4Ghz 802.11n only mode:** all 802.11n wireless devices.

Channel Width

Select the appropriate channel width:

- **20 MHz (Default):** Select if your wireless clients are not 802.11n.
- **Auto 20/40 MHz:** Select if your wireless clients are a mix of 802.11b, 11g, 11n wireless clients. If you are not sure which wireless clients you are using, select **Auto**.

Enable Hidden Wireless

Check to hide the SSID of your wireless network to be broadcasted when wireless clients scan for wireless networks. To display the router's SSID, keep the box unchecked (default).

WMM Enable

Wi-Fi Multimedia (WMM) improves the quality of video and voice applications transmitted over a wireless network. This function is commonly used with multimedia applications such as a game console. Check the box to enable WMM.

Enable WISP Mode

Check the box to enable Wireless Internet Service Provider (WISP). WISP is commonly used in wireless hotspots, such as coffee shops, airports, etc. When the travel router is connected to a wireless hotspot, it connects with a WISP account

Wireless Network Settings	
Enable Access Point:	<input checked="" type="checkbox"/>
Wireless Network Name:	TRENDnet654 (Also called the SSID)
Wireless Channel:	6 (Domain:United States)
802.11 Mode:	2.4Ghz 802.11b/g/n mixed mode
Channel Width:	20MHz
Enable Hidden Wireless:	<input type="checkbox"/> (Also called Disable SSID Broadcast)
WMM Enable:	<input checked="" type="checkbox"/> (force enabled in 11n mode)
Enable WISP Mode:	<input checked="" type="checkbox"/> (NAT and DHCP Server enabled)
Wireless Security Mode:	Disable Wireless Security (not recommended)

3. CLIENT MODE

and is assigned a public IP address. This account and public IP address are then shared and used by all connected clients. The connected clients receive private IP addresses from the travel router. If WISP is disabled, the travel router does not share the WISP account, instead, connected clients must connect to the wireless network directly.

Wireless Security Mode

Select the security level for your wireless network. Select the wireless security mode from the list:

- **Disable Wireless Security:** (Default) Select if you do not want to use any wireless security.
- **Enable WEP Wireless Security (basic)**
- **Enable WPA Wireless Security (enhanced)**
- **Enable WPA-2 Wireless Security (enhanced)**
- **Enable WPA-Auto Wireless Security (enhanced):** Select if you are unsure which WPA wireless security to use.

The required settings vary depending on the selected mode.

WEP

WEP (Wired Equivalent Privacy) is the basic encryption method. With WEP encryption, all wireless clients must enter the same key to connect to the access point.

Authentication

Select the type of authentication:

- **Open system:** Allows public access to the travel router via wireless communications.
- **Shared Key:** Requires users to enter the same WEP key to exchange data with other wireless devices.
- **Auto:** Select **Auto** if you are unsure which authentication suits best for your wireless clients.

Authentication :	Open System ▾
Key Length :	64Bit ▾
Key Format :	HEX ▾
Default WEP Key :	WEP Key 1 ▾
WEP Key 1 :	2994153900
WEP Key 2 :	
WEP Key 3 :	
WEP Key 4 :	

Key Length

Select the key length or the level of encryption:

- **64Bit:** Select to enter 10 hexadecimal characters with any combination of 0-9 or A-F
- **128Bit:** Select to enter 26 hexadecimal characters with any combination of 0-9 or A-F

Key Format

Select the key format:

- **ASCII:** Select to enter ASCII characters.
- **HEX:** Select to enter hexadecimal characters.

Default WEP Key

The travel router supports up to 4 sets of WEP keys. Select which WEP Key is used as the default key from the list.

3. CLIENT MODE

WEP KEY 1-4

Manually enter a set of WEP key for each box. Select the default WEP key from the **Default WEP Key** list. **WPA / WPA-2 / WPA-Auto**

WPA (Wi-Fi Protected Access) uses high grade encryption and authentication which is designed to improve WEP encryption. WPA / WPA-2 / WPA-Auto uses a passphrase to authenticate wireless connections.

Cipher Type

Select the encryption method:

- **TKIP:** Temporal Key Integrity Protocol.
- **AES:** Advanced Encryption Standard.
- **Auto:** Select **Auto** if you are unsure which method is suitable for your wireless clients.

Cipher Type:	Auto
PSK / EAP:	PSK
Passphrase:	<input type="text"/>
Confirmed Passphrase:	<input type="text"/>

PSK/EAP

Select the authentication method:

- **PSK:** Select to use a passphrase for authentication.

Passphrase

Create a passphrase. The passphrase must be 64 hexadecimal or 8-63 ASCII characters.

Confirm Passphrase

Re-enter passphrase.

- **EAP:** Select to use Extensible Authentication Protocol (EAP). This should only be used when a Radius server is connected to the travel router. You can have up to 2 Radius server settings.

IP

Enter the IP address of the Radius server.

Port

Enter the port number of the Radius server. The default value is 1812.

Shared Secret

Enter the secret key shared between the travel router and the Radius server.

Cipher Type:	Auto	
PSK / EAP:	EAP	
802.1X		
RADIUS Server 1:	IP	<input type="text" value="0.0.0.0"/>
	Port	<input type="text" value="1812"/>
	Shared Secret	<input type="text"/>
RADIUS Server 2:	IP	<input type="text" value="0.0.0.0"/>
	Port	<input type="text" value="1812"/>
	Shared Secret	<input type="text"/>

Once configuration is complete, click **Apply** to save and apply settings, or click **Cancel** to cancel changes. The travel router will restart for new settings to take effect.

Local Area Network (LAN) Settings

Dynamic IP (DHCP)

My LAN Connection is

Select **Dynamic IP (DHCP)** to obtain the IP Address information automatically from your ISP. The **IP Address**, **Subnet Mask**, and **Gateway Address** are shown on the page.

Device Name

Displays the default device name.

Static IP

My LAN Connection is

Select **Static IP** if you are required to use a permanent IP Address to connect to the Internet. You need to manually enter the information provided by your ISP.

IP Address

Enter the IP address provided by your ISP.

Subnet Mask

Enter the subnet mask provided by your ISP.

Gateway Address

Enter the gateway address provided by you ISP.

Primary / Secondary DNS Server

Enter the DNS server addresses provided by your ISP.

TRENDNET Wireless N Travel Router TEW-654TR

Wizard

Setup

- Wireless Client
- LAN
- WPS

Advanced

System

Status

Logout

LAN Connection Type

Choose the mode to be used by the device.

My LAN Connection is:

Device Name:

DYNAMIC IP (DHCP) LAN CONNECTION TYPE :

IP Address Information.

IP Address:

Subnet Mask:

Gateway Address:

Copyright © 2009 TRENDnet. All Rights Reserved.

TRENDNET Wireless N Travel Router TEW-654TR

Wizard

Setup

- Wireless Client
- LAN
- WPS

Advanced

System

Status

Logout

LAN Connection Type

Choose the mode to be used by the device.

My LAN Connection is:

Device Name:

STATIC IP ADDRESS LAN CONNECTION TYPE

Enter the static address information.

IP Address:

Subnet Mask:

Gateway Address:

Primary DNS Server:

Secondary DNS Server: (Optional)

Copyright © 2009 TRENDnet. All Rights Reserved.

Once configuration is complete, click **Apply** to save and apply settings, or click **Cancel** to cancel changes. The travel router will restart for new settings to take effect.

3. CLIENT MODE

Wi-Fi Protected Setup (WPS) Settings

Wi-Fi Protected Setup (WPS) is an optional certification program from the Wi-Fi Alliance that is designed to ease the task of setting up and configuring security on a wireless network.

Wireless Network Name (SSID)

The name of the wireless network you want to PIN, also called Service Set Identifier (SSID).

Start PIN

Click this button to start WPS configuration process if the client device has a WPS PIN number.

Self-PIN Number

Displays the default PIN number of the travel router.

Push Button Configuration

Click the **Start PBC** button to start WPS configuration process if the client device has a WPS button.

Once configuration is complete, click **Apply** to save and apply settings, or click **Cancel** to cancel changes. The travel router will restart for new settings to take effect.

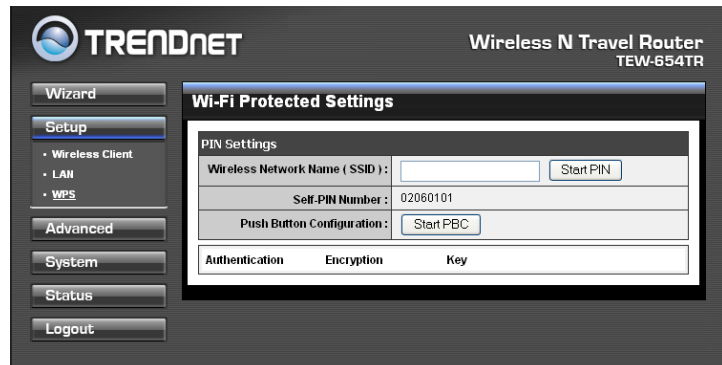

3.2.3 Advanced

The Advanced menu configurations greatly affect the operating performance of the travel router. This menu is intended for advanced users. It is recommended to retain the default settings. Do not change any of configurations if you are unsure about it.

Advanced Wireless Network Settings

RTS Threshold

The default and the recommended value is 2346. Should you encounter inconsistent data flow, only minor adjustments should be made.

Fragmentation Threshold

Fragmentation threshold refers to the amount of packets that will be fragmented before transmission. The default and recommended value is 2346 bytes.

Preamble Type

Preamble is used to limit the packets of data for transmission. When the connection is bad, it is recommended to use the **Short Preamble**.

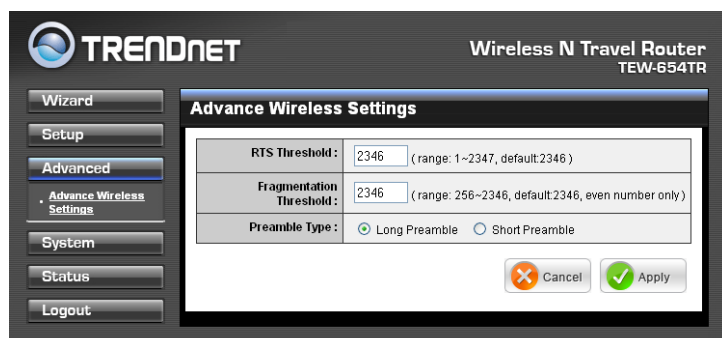

3.2.4 System

The System menu provides password configuration, backup and restore settings, firmware update and date and time settings.

Admin

The Admin submenu allows you to change the default user name and password which are use to login.

New User Name

Enter the new user name here.

New / Confirm Password

Enter the password.

Click **Apply** to save and apply settings, or click **Cancel** to cancel changes. The travel router will restart for new settings to take effect.

Settings

The Settings submenu provides backup and restore setting functions.

Save and Restore	
Save Settings To Local Hard Drive :	<input type="button" value="Save"/>
Load Settings From Local Hard Drive :	<input type="text"/> <input type="button" value="Browse..."/> <input type="button" value="Upload Settings"/>
Restore To Factory Default Settings :	<input type="button" value="Restore Device"/>
Restart Device :	<input type="button" value="Restart"/>

Save Settings to Local Hard Drive

Use this function to save the current configuration settings to your local hard drive. Click **Save**, then select the folder where you want to save the file.

Load Settings From Local Hard Drive

Use this function to retrieve saved configuration settings from the local hard drive.

- 1 Click **Browse** to locate the file.
- 2 Click **Upload Settings** to transfer and apply the settings to the travel router.

Restore to Factory Default Settings

Click **Restore Device** to restore all configurations to the factory default settings. All changes in configuration will be deleted.

Restart Device

Click **Restart** to reboot the travel router.

3. CLIENT MODE

Firmware

The Firmware submenu allows you to upgrade the firmware to the latest version.

Current Firmware Version

Displays the current firmware version.

Firmware Date

Displays the date when the firmware was last updated.

Current Firmware info	
Current Firmware Version:	1.00.14
Firmware Date:	Tue, 05 May 2009
	<input type="text"/> Browse...
<input type="button" value="Cancel"/> <input type="button" value="Apply"/>	

- 1 Download the latest firmware from the manufacturer's website, and save it to a disk.
- 2 Click **Browse** to locate the file.
- 3 Click **Apply** to start firmware update. The system will reboot to complete update.

Time

The Time submenu allows you to manually adjust the system time settings or synchronize it with a server.

Current Time

Displays the current date and time settings.

Time Zone

Select the time zone in your area.

Synchronize the clock with

Select:

- **Manual:** To manually adjust the date and time.
- **Automatic:** To synchronize date and time with the server.

System Time Settings	
Current Time:	Jan/01/2008 00:24:55
Time Zone:	(GMT-08:00) Pacific Time (US/Canada), Tijuana
Synchronize the clock with:	Manual
Default NTP server:	<input type="text"/>
Set the time:	Year 2008 Month Jan Day 01 Hour 00 Minute 00 second 00 <input type="button" value="Set Time"/>
Enable Daylight Saving:	<input type="checkbox"/> Start Mar 3rd Sun End Nov 2nd Sun
<input type="button" value="Cancel"/> <input type="button" value="Apply"/>	

Default NTP Server

Enter the NTP server address to synchronize the date and time with.

Set the Time

Use this option to manually set the date and time. This option is only available when **Synchronize the clock with** is set to **Automatic**.

Enable Daylight Saving

Check the box to enable daylight saving time. Use the Start and End field boxes to specify the starting and ending dates.

Click **Apply** to save and apply settings, or click **Cancel** to cancel changes. The travel router will restart for new settings to take effect.

3.2.5 Status

The Status menu displays device, logs, traffic, and connection information.

Device Info

This page displays the Firmware Version, LAN and Wireless Client information.

Device Info	
Firmware Version : 1.00.14	
LAN :	
MAC Address :	00:40:f4:03:24:ba
Connection :	Dynamic IP
IP Address :	192.168.10.1
Subnet Mask :	255.255.255.0
Gateway :	0.0.0.0
Wireless Client :	
MAC Address :	00:40:f4:03:24:ba
Network Name (SSID) :	TRENDnet654
Channel :	6
Security Type :	Disable

Logs

This page displays the recorded events that occur within the wireless network.

Click the following buttons to view the **First Page**, **Last Page**, **Previous Page**, and **Next Page**.

To delete log data, click **Clear Log**.

To change log settings, click **Log Settings**.

To refresh list, click **Refresh**.

View Log	
View Log displays the activities occurring on the device.	
Log Files :	
<input type="button" value="First Page"/> <input type="button" value="Last Page"/> <input type="button" value="Previous Page"/> <input type="button" value="Next Page"/>	
<input type="button" value="Clear Log"/> <input type="button" value="Log Settings"/> <input type="button" value="Refresh"/>	
Page 1 of 2	
Time	Message
Jan 1 00:03:38	UDHCPD sending OFFER of 192.168.10.101
Jan 1 00:00:28	device_lan_ip=192.168.10.1 , device_lan_subnet_mask=255.255.255.0
Jan 1 00:00:28	DHCP server start.
Jan 1 00:00:18	Sending discover...
Jan 1 00:00:16	Sending discover...
Jan 1 00:00:14	Sending discover...
Jan 1 00:00:01	Sending discover...
Jan 1 00:00:00	0x00140000-0x01000000 : "RootFS"
Jan 1 00:00:00	0x00060000-0x00140000 : "Kernel"
Jan 1 00:00:00	0x00030000-0x00040000 : "Factory"

Statistics

This page displays the traffic statistics of received and transmitted packets that passed through the travel router.

Click **Refresh** to refresh table.

Traffic Statistics		
Traffic Statistics display Receive and Transmit packets passing through the device.		
	Receive	Transmit
LAN	589 Packets	518 Packets
Wireless	1279 Packets	2139 Packets
<input type="button" value="Refresh"/>		

4

Router Mode

With Router mode, you can connect and share Internet connections, files, printers, etc. between computers on the network.

Before You Begin

Checklist

- ✓ A broadband Internet connection.
- ✓ A DSL / cable modem provided by the ISP as part of the broadband connection installation.
- ✓ A broadband router that connects to the DSL / cable modem for internet connection sharing.

You need to connect...

- Connect the DSL / cable modem to the WAN port or Internet port of the broadband router using an RJ-45 Ethernet cable.
- If you are currently connected to a network, disable that network connection before you connect and configure the travel router.
- Configure your computer's Internet protocol (TCP/IP) settings. See "1.6.1 Configuring Connections".

Note:

Although you can connect the DSL or cable modem directly to your computer's network card, it is recommend to use a broadband router as an intermediary device to delegate the handling of the Internet connection and to easily configure and share the Internet connection with other computers on a home network.

4.1 Installation

Network Diagram

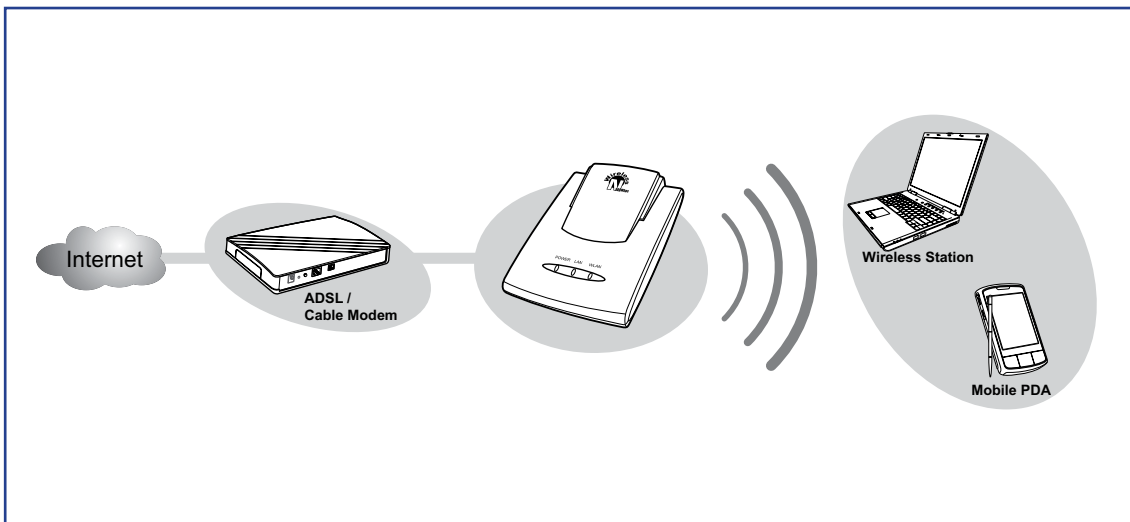

- 1 Adjust the switch to Router mode.
- 2 Connect one end of the RJ-45 Ethernet cable to the travel router and the other end to the broadband router.
- 3 Turn on or plug in the DSL / cable modem and the broadband router.
- 4 Connect the power adapter to the travel router and plug to an outlet or power strip. Wait for the travel router to boot.
- 5 Check the LED indicators to verify connection.
- 6 Enable the wireless function of the wireless clients or devices.

The following LED indicators should be lit...

- ✓ Power LED (solid)
- ✓ LAN LED (solid)
- ✓ WLAN LED (flashing green)

Note:

Make sure you remove the power source from the travel router first before adjusting the mode switch.