



A D T

FCC TEST REPORT

REPORT NO.: RF980521L04

MODEL NO.: WLN-2002
(refer to item 3.1 for more detail)

RECEIVED: May 14, 2009

TESTED: May 14 ~ Jul. 02, 2009

ISSUED: Jul. 07, 2009

APPLICANT: CAMEO COMMUNICATIONS, INC.

ADDRESS: No. 42, Sec. 6, Mincyuan E. Rd., Neihu District,
Taipei City 114, Taiwan

ISSUED BY: Bureau Veritas Consumer Products Services
(H.K.) Ltd., Taoyuan Branch

LAB ADDRESS: No. 47, 14th Ling, Chia Pau Tsuen, Lin Kou
Hsiang, Taipei Hsien 244, Taiwan, R.O.C.

TEST LOCATION: No. 19, Hwa Ya 2nd Rd, Wen Hwa Tsuen, Kwei
Shan Hsiang, Taoyuan Hsien 333, Taiwan,
R.O.C.

This test report consists of 101 pages in total. It may be duplicated completely for legal use with the approval of the applicant. It should not be reproduced except in full, without the written approval of our laboratory. The client should not use it to claim product endorsement by TAF or any government agencies. The test results in the report only apply to the tested sample.





A D T

TABLE OF CONTENTS

1.	CERTIFICATION.....	4
2.	SUMMARY OF TEST RESULTS	5
2.1	MEASUREMENT UNCERTAINTY.....	5
3.	GENERAL INFORMATION.....	6
3.1	GENERAL DESCRIPTION OF EUT	6
3.2	DESCRIPTION OF TEST MODES	7
3.2.1	CONFIGURATION OF SYSTEM UNDER TEST	8
3.2.2	TEST MODE APPLICABILITY AND TESTED CHANNEL DETAIL	9
3.3	GENERAL DESCRIPTION OF APPLIED STANDARDS	11
3.4	DESCRIPTION OF SUPPORT UNITS	11
4.	TEST TYPES AND RESULTS	12
4.1	RADIATED EMISSION MEASUREMENT	12
4.1.1	LIMITS OF RADIATED EMISSION MEASUREMENT.....	12
4.1.2	TEST INSTRUMENTS.....	13
4.1.3	TEST PROCEDURES	14
4.1.4	DEVIATION FROM TEST STANDARD.....	14
4.1.5	TEST SETUP.....	15
4.1.6	EUT OPERATING CONDITIONS	15
4.1.7	TEST RESULTS	16
4.2	CONDUCTED EMISSION MEASUREMENT	31
4.2.1	LIMITS OF CONDUCTED EMISSION MEASUREMENT	31
4.2.2	TEST INSTRUMENTS.....	31
4.2.3	TEST PROCEDURES	32
4.2.4	DEVIATION FROM TEST STANDARD.....	32
4.2.5	TEST SETUP.....	33
4.2.6	EUT OPERATING CONDITIONS	33
4.2.7	TEST RESULTS	34
4.3	6dB BANDWIDTH MEASUREMENT.....	40
4.3.1	LIMITS OF 6dB BANDWIDTH MEASUREMENT	40
4.3.2	TEST INSTRUMENTS.....	40
4.3.3	TEST PROCEDURE.....	40
4.3.4	DEVIATION FROM TEST STANDARD.....	40
4.3.5	TEST SETUP.....	41
4.3.6	EUT OPERATING CONDITIONS	41
4.3.7	TEST RESULTS	42
4.4	MAXIMUM PEAK OUTPUT POWER.....	58
4.4.1	LIMITS OF MAXIMUM PEAK OUTPUT POWER MEASUREMENT	58
4.4.2	INSTRUMENTS.....	58
4.4.3	TEST PROCEDURES	58
4.4.4	DEVIATION FROM TEST STANDARD.....	59
4.4.5	TEST SETUP.....	59
4.4.6	EUT OPERATING CONDITIONS	59
4.4.7	TEST RESULTS	60
4.5	POWER SPECTRAL DENSITY MEASUREMENT	62
4.5.1	LIMITS OF POWER SPECTRAL DENSITY MEASUREMENT	62
4.5.2	TEST INSTRUMENTS.....	62
4.5.3	TEST PROCEDURE.....	62
4.5.4	DEVIATION FROM TEST STANDARD.....	63



A D T

4.5.5	TEST SETUP	63
4.5.6	EUT OPERATING CONDITION.....	63
4.5.7	TEST RESULTS	64
4.6	BAND EDGES MEASUREMENT	80
4.6.1	LIMITS OF BAND EDGES MEASUREMENT	80
4.6.2	TEST INSTRUMENTS.....	80
4.6.3	TEST PROCEDURE.....	81
4.6.4	DEVIATION FROM TEST STANDARD.....	81
4.6.5	EUT OPERATING CONDITION.....	81
4.6.6	TEST RESULTS	82
4.7	ANTENNA REQUIREMENT	98
4.7.1	STANDARD APPLICABLE	98
4.7.2	ANTENNA CONNECTED CONSTRUCTION	98
5.	PHOTOGRAPHS OF THE TEST CONFIGURATION.....	99
6.	INFORMATION ON THE TESTING LABORATORIES	100
7.	APPENDIX A - MODIFICATIONS RECORDERS FOR ENGINEERING CHANGES TO THE EUT BY THE LAB.....	101



A D T

1. CERTIFICATION

PRODUCT: IEEE802.11n Draft 2.0 Three Mode Wireless Pocket AP
MODEL: WLN-2002 (refer to item 3.1 for more detail)
BRAND: CAMEO (refer to item 3.1 for more detail)
APPLICANT: CAMEO COMMUNICATIONS, INC.
TEST SAMPLE: ENGINEERING SAMPLE
TESTED: May 14 ~ Jul. 02, 2009
STANDARDS: **FCC Part 15, Subpart C (Section 15.247)**
ANSI C63.4-2003

The above equipment (Model: WLN-2002) has been tested by **Bureau Veritas Consumer Products Services (H.K.) Ltd., Taoyuan Branch**, and found compliance with the requirement of the above standards. The test record, data evaluation & Equipment Under Test (EUT) configurations represented herein are true and accurate accounts of the measurements of the sample's EMC characteristics under the conditions specified in this report.

PREPARED BY : Andrea Hsia , **DATE** : Jul. 07, 2009
Andrea Hsia / Specialist

TECHNICAL ACCEPTANCE : Long Chen , **DATE** : Jul. 07, 2009
Responsible for RF Long Chen / Senior Engineer

APPROVED BY : Gary Chang , **DATE** : Jul. 07, 2009
Gary Chang / Assistant Manager



2. SUMMARY OF TEST RESULTS

The EUT has been tested according to the following specifications:

APPLIED STANDARD: FCC PART 15, SUBPART C (SECTION 15.247)			
STANDARD SECTION	TEST TYPE AND LIMIT	RESULT	REMARK
15.207	AC Power Conducted Emission	PASS	Meet the requirement of limit. Minimum passing margin is -4.09dB at 3.488MHz.
15.247(a)(2)	Spectrum Bandwidth of a Direct Sequence Spread Spectrum System Limit: min. 500kHz	PASS	Meet the requirement of limit.
15.247(b)	Maximum Peak Output Power Limit: max. 30dBm	PASS	Meet the requirement of limit.
15.247(d)	Radiated Emissions Limit: Table 15.209	PASS	Meet the requirement of limit. Minimum passing margin is -1.03dB at 250.00MHz.
15.247(e)	Power Spectral Density Limit: max. 8dBm	PASS	Meet the requirement of limit.
15.247(d)	Band Edge Measurement Limit: 20dB less than the peak value of fundamental frequency	PASS	Meet the requirement of limit.

2.1 MEASUREMENT UNCERTAINTY

Where relevant, the following measurement uncertainty levels have been estimated for tests performed on the EUT as specified in CISPR 16-4-2:

MEASUREMENT	FREQUENCY	UNCERTAINTY
Conducted emissions	150kHz~30MHz	2.44dB
Radiated emissions	30MHz ~ 200MHz	2.93 dB
	200MHz ~1000MHz	2.95 dB
	1GHz ~ 18GHz	2.26 dB
	18GHz ~ 40GHz	1.94 dB

This uncertainty represents an expanded uncertainty expressed at approximately the 95% confidence level using a coverage factor of $k = 2$.



3. GENERAL INFORMATION

3.1 GENERAL DESCRIPTION OF EUT

EUT	IEEE802.11n Draft 2.0 Three Mode Wireless Pocket AP
MODEL NO.	WLN-2002 (refer to note as below)
FCC ID	NHPWLN2002
POWER SUPPLY	5Vdc from adapter 5Vdc from host equipment
MODULATION TYPE	CCK, DQPSK, DBPSK for DSSS 64QAM, 16QAM, QPSK, BPSK for OFDM
MODULATION TECHNOLOGY	DSSS, OFDM
TRANSFER RATE	802.11b:11.0/ 5.5/ 2.0/ 1.0Mbps 802.11g: 54.0/ 48.0/ 36.0/ 24.0/ 18.0/ 12.0/ 9.0/ 6.0Mbps Draft 802.11n: up to 300.0Mbps
OPERATING FREQUENCY	2412.0 ~ 2462.0MHz
NUMBER OF CHANNEL	11 for 802.11b, 802.11g, draft 802.11n (20MHz) 7 for draft 802.11n (40MHz)
OUTPUT POWER	322.130mW
ANTENNA TYPE	PIFA antenna with 2dBi gain
DATA CABLE	0.45m non-shielded USB cable without core
I/O PORTS	RJ45
ACCESSORY DEVICES	Adapter

NOTE:

1. The EUT incorporates a MIMO function. Physically, the EUT provides two completed transmitters and two receivers.

MODULATION MODE	TX FUNCTION
802.11b	2TX
802.11g	2TX
Draft 802.11n (20MHz)	2TX
Draft 802.11n (40MHz)	2TX

2. All models are electrically identical, different model names are for marketing purpose.

BRAND	MODEL	DIFFERENCE
CAEMO	WLN-2002	Marketing different
TRENDnet	TEW-654TR	
ENCORE	ENTRWI-N	
Atlantisland	A02-AP-W300N	

3. The EUT were operated with following power adapters:

ADAPTER 1	
BRAND	JENTEC TECHNOLOGY CO., LTD.
MODEL	CF0605-B IW
INPUT POWER	100-120Vac, 50-60Hz, 0.18A
OUTPUT POWER	5Vdc, 1.2A
POWER LINE	1.5m non-shielded cable without core

ADAPTER 2	
BRAND	AMIGO
MODEL	AMS1-0501200FU
INPUT POWER	100-240Vac, 50-60Hz, 0.2A
OUTPUT POWER	5Vdc, 1.2A
POWER LINE	1.5m non-shielded cable without core

4. The above EUT information was declared by manufacturer and for more detailed features description, please refer to the manufacturer's specifications or user's manual.

3.2 DESCRIPTION OF TEST MODES

11 channels are provided for 802.11b, 802.11g and draft 802.11n (20MHz):

CHANNEL	FREQUENCY	CHANNEL	FREQUENCY
1	2412MHz	7	2442MHz
2	2417MHz	8	2447MHz
3	2422MHz	9	2452MHz
4	2427MHz	10	2457MHz
5	2432MHz	11	2462MHz
6	2437MHz		

7 channels are provided for draft 802.11n (40MHz):

CHANNEL	FREQUENCY	CHANNEL	FREQUENCY
1	2422MHz	5	2442MHz
2	2427MHz	6	2447MHz
3	2432MHz	7	2452MHz
4	2437MHz		

3.2.1 CONFIGURATION OF SYSTEM UNDER TEST

TEST MODE A & B

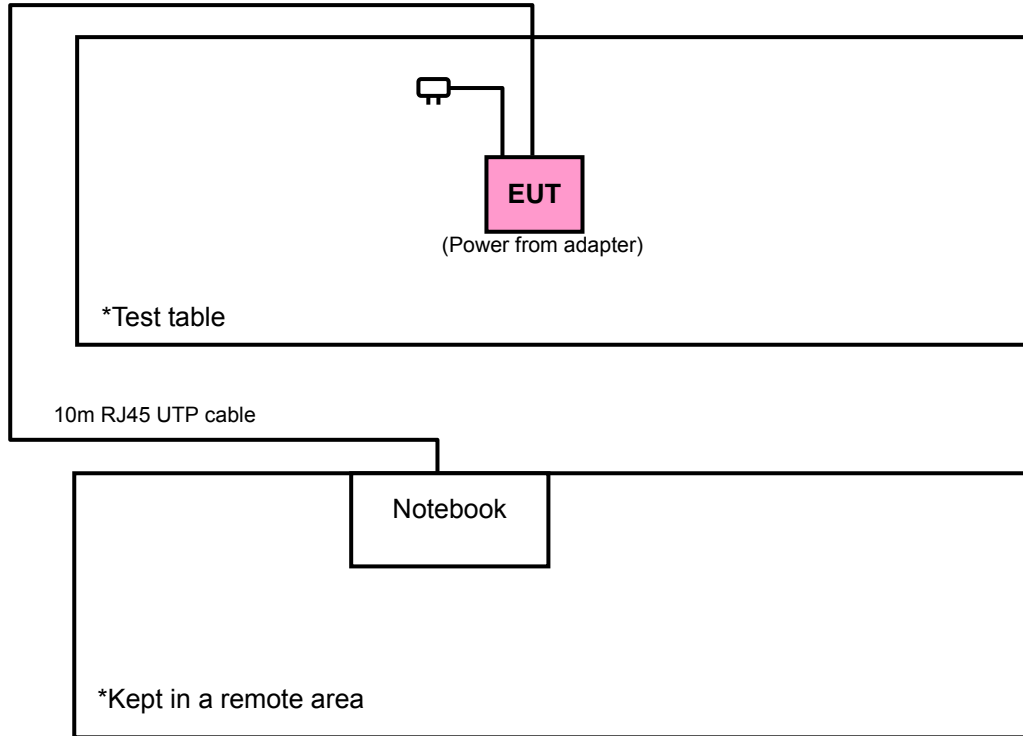

TEST MODE C

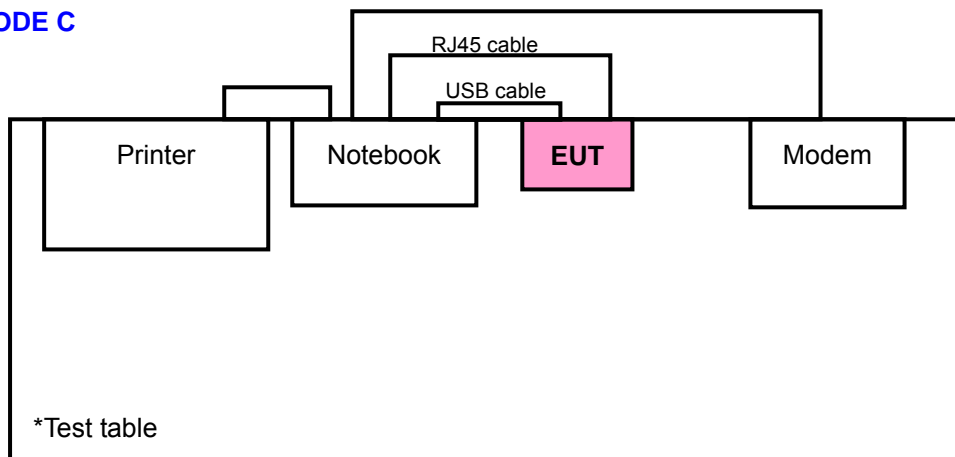

3.2.2 TEST MODE APPLICABILITY AND TESTED CHANNEL DETAIL

EUT CONFIGURE MODE	APPLICABLE TO				DESCRIPTION
	RE \geq 1G	RE<1G	PLC	APCM	
A	-	√	√	-	For Adapter 1
B	√	√	√	√	For Adapter 2
C	-	√	√	-	Power from host equipment

Where **RE \geq 1G**: Radiated Emission above 1GHz **RE<1G**: Radiated Emission below 1GHz
PLC: Power Line Conducted Emission **APCM**: Antenna Port Conducted Measurement
NOTE: "-" means no effect.

RADIATED EMISSION TEST (ABOVE 1GHz):

- Pre-Scan has been conducted to determine the worst-case mode from all possible combinations between available modulations, data rates and antenna ports (if EUT with antenna diversity architecture).
- Following channel(s) was (were) selected for the final test as listed below.

EUT CONFIGURE MODE	MODE	AVAILABLE CHANNEL	TESTED CHANNEL	MODULATION TECHNOLOGY	MODULATION TYPE	DATA RATE (Mbps)
B	802.11b	1 to 11	1, 6, 11	DSSS	DBPSK	1.0
B	802.11g	1 to 11	1, 6, 11	OFDM	BPSK	6.0
B	Draft 802.11n (20MHz)	1 to 11	1, 6, 11	OFDM	BPSK	7.2
B	Draft 802.11n (40MHz)	1 to 7	1, 4, 7	OFDM	BPSK	15.0

RADIATED EMISSION TEST (BELOW 1GHz):

- Pre-Scan has been conducted to determine the worst-case mode from all possible combinations between available modulations, data rates and antenna ports (if EUT with antenna diversity architecture).
- Following channel(s) was (were) selected for the final test as listed below.

EUT CONFIGURE MODE	MODE	AVAILABLE CHANNEL	TESTED CHANNEL	MODULATION TECHNOLOGY	MODULATION TYPE	DATA RATE (Mbps)
A	802.11g	1 to 11	6	OFDM	BPSK	6.0
B	802.11g	1 to 11	6	OFDM	BPSK	6.0
C	802.11g	1 to 11	6	OFDM	BPSK	6.0



A D T

POWER LINE CONDUCTED EMISSION TEST:

- Pre-Scan has been conducted to determine the worst-case mode from all possible combinations between available modulations, data rates and antenna ports (if EUT with antenna diversity architecture).
- Following channel(s) was (were) selected for the final test as listed below.

EUT CONFIGURE MODE	MODE	AVAILABLE CHANNEL	TESTED CHANNEL	MODULATION TECHNOLOGY	MODULATION TYPE	DATA RATE (Mbps)
A	802.11g	1 to 11	6	OFDM	BPSK	6.0
B	802.11g	1 to 11	6	OFDM	BPSK	6.0
C	802.11g	1 to 11	6	OFDM	BPSK	6.0

BANDEDGE MEASUREMENT:

- Pre-Scan has been conducted to determine the worst-case mode from all possible combinations between available modulations, data rates and antenna ports (if EUT with antenna diversity architecture).
- Following channel(s) was (were) selected for the final test as listed below.

EUT CONFIGURE MODE	MODE	AVAILABLE CHANNEL	TESTED CHANNEL	MODULATION TECHNOLOGY	MODULATION TYPE	DATA RATE (Mbps)
B	802.11b	1 to 11	1, 11	DSSS	DBPSK	1.0
B	802.11g	1 to 11	1, 11	OFDM	BPSK	6.0
B	Draft 802.11n (20MHz)	1 to 11	1, 11	OFDM	BPSK	7.2
B	Draft 802.11n (40MHz)	1 to 7	1, 7	OFDM	BPSK	15.0

ANTENNA PORT CONDUCTED MEASUREMENT:

- Pre-Scan has been conducted to determine the worst-case mode from all possible combinations between available modulations, data rates and antenna ports (if EUT with antenna diversity architecture).
- Following channel(s) was (were) selected for the final test as listed below.

EUT CONFIGURE MODE	MODE	AVAILABLE CHANNEL	TESTED CHANNEL	MODULATION TECHNOLOGY	MODULATION TYPE	DATA RATE (Mbps)
B	802.11b	1 to 11	1, 6, 11	DSSS	DBPSK	1.0
B	802.11g	1 to 11	1, 6, 11	OFDM	BPSK	6.0
B	Draft 802.11n (20MHz)	1 to 11	1, 6, 11	OFDM	BPSK	7.2
B	Draft 802.11n (40MHz)	1 to 7	1, 4, 7	OFDM	BPSK	15.0



A D T

3.3 GENERAL DESCRIPTION OF APPLIED STANDARDS

The EUT is a RF Product. According to the specifications of the manufacturer, it must comply with the requirements of the following standards:

FCC Part 15, Subpart C (15.247)

ANSI C63.4-2003

All test items have been performed and recorded as per the above standards.

NOTE: The EUT is also considered as a kind of computer peripheral, because the connection to computer is necessary for typical use. It has been verified to comply with the requirements of FCC Part 15, Subpart B, Class B (DoC). The test report has been issued separately.

3.4 DESCRIPTION OF SUPPORT UNITS

The EUT has been tested as an independent unit together with other necessary accessories or support units. The following support units or accessories were used to form a representative test configuration during the tests.

NO.	PRODUCT	BRAND	MODEL NO.	SERIAL NO.	FCC ID
1	NOTEBOOK	DELL	PP05L	12130898320	E2K24CLNS
2	NOTEBOOK	DELL	PP05L	12130898320	E2K24CLNS
3	PRINTER	EPSON	LQ-300+	DCGY054146	FCC DoC Approved
4	MODEM	ACEEX	1414V/3	0401008260	IFAXDM1414

NO.	SIGNAL CABLE DESCRIPTION OF THE ABOVE SUPPORT UNITS
1	10m RJ45 UTP cable.
2	NA
3	1.2m braid shielded wire, DB25 & DB9 connector, w/o core.
4	1.8m braid shielded wire, DB25 connector, w/o core.

NOTE:

1. All power cords of the above support units are non shielded (1.8m).
2. Item 1 acted as communication partners to transfer data.



A D T

4. TEST TYPES AND RESULTS

4.1 RADIATED EMISSION MEASUREMENT

4.1.1 LIMITS OF RADIATED EMISSION MEASUREMENT

Emissions radiated outside of the specified bands, shall be according to the general radiated limits in 15.209 as following:

FREQUENCIES (MHz)	FIELD STRENGTH (microvolts/meter)	MEASUREMENT DISTANCE (meters)
0.009 ~ 0.490	2400/F(kHz)	300
0.490 ~ 1.705	24000/F(kHz)	30
1.705 ~ 30.0	30	30
30 ~ 88	100	3
88 ~ 216	150	3
216 ~ 960	200	3
Above 960	500	3

NOTE:

1. The lower limit shall apply at the transition frequencies.
2. Emission level (dBuV/m) = 20 log Emission level (uV/m).
3. As shown in 15.35(b), for frequencies above 1000MHz, the field strength limits are based on average detector, however, the peak field strength of any emission shall not exceed the maximum permitted average limits, specified above by more than 20dB under any condition of modulation.



A D T

4.1.2 TEST INSTRUMENTS

DESCRIPTION & MANUFACTURER	MODEL NO.	SERIAL NO.	DATE OF CALIBRATION	DUE DATE OF CALIBRATION
Test Receiver ROHDE & SCHWARZ	ESIB7	100212	May 25, 2009	May 24, 2010
Spectrum Analyzer ROHDE & SCHWARZ	FSP40	100269	Aug. 08, 2008	Aug. 07, 2009
BILOG Antenna SCHWARZBECK	VULB9168	9168-156	Apr. 30, 2009	Apr. 29, 2010
HORN Antenna SCHWARZBECK	BBHA 9120 D	9120D-563	Aug. 06, 2008	Aug. 05, 2009
HORN Antenna SCHWARZBECK	BBHA 9170	BBHA9170242	Jan. 06, 2009	Jan. 05, 2010
Preamplifier Agilent	8449B	3008A01911	Sep. 10, 2008	Sep. 09, 2009
Preamplifier Agilent	8447D	2944A10638	Dec. 26, 2008	Dec. 25, 2009
RF signal cable HUBER+SUHNNER	SUCOFLEX 104	218190/4 231241/4	May 13, 2009	May 12, 2010
RF signal cable Worken	8D-FB	Cable-HYCH9-01	Aug. 09, 2008	Aug. 08, 2009
Software	ADT_Radiated_ V7.6.15.9.2	NA	NA	NA
Antenna Tower EMCO	2070/2080	512.835.4684	NA	NA
Turn Table EMCO	2087-2.03	NA	NA	NA
Antenna Tower & Turn Table Controller EMCO	2090	NA	NA	NA

- NOTE:**
1. The calibration interval of the above test instruments is 12 months and the calibrations are traceable to NML/ROC and NIST/USA.
 2. The test was performed in HwaYa Chamber 9.
 3. The horn antenna and HP preamplifier (model: 8449B) are used only for the measurement of emission frequency above 1GHz if tested.
 4. The FCC Site Registration No. is 460141.
 5. The IC Site Registration No. is IC 7450F-4.



4.1.3 TEST PROCEDURES

- a. The EUT was placed on the top of a rotating table 0.8 meters above the ground at a 3 meters semi-anechoic chamber. The table was rotated 360 degrees to determine the position of the highest radiation.
- b. The EUT was set 3 meters away from the interference-receiving antenna, which was mounted on the top of a variable-height antenna tower.
- c. The antenna is a broadband antenna, and its height is varied from one meter to four meters above the ground to determine the maximum value of the field strength. Both horizontal and vertical polarizations of the antenna are set to make the measurement.
- d. For each suspected emission, the EUT was arranged to its worst case and then the antenna was tuned to heights from 1 meter to 4 meters and the rotatable table was turned from 0 degrees to 360 degrees to find the maximum reading.
- e. The test-receiver system was set to Peak Detect Function and Specified Bandwidth with Maximum Hold Mode.
- f. If the emission level of the EUT in peak mode was lower than the limit specified, then testing could be stopped and the peak values of the EUT would be reported. Otherwise the emissions would be re-tested one by one using peak, quasi-peak or average method as specified and then reported in a data sheet.

NOTE:

1. The resolution bandwidth and video bandwidth of test receiver/spectrum analyzer is 120kHz for Quasi-peak detection at frequency below 1GHz.
2. The resolution bandwidth of test receiver/spectrum analyzer is 1MHz and video bandwidth is 3MHz for Peak detection at frequency above 1GHz.
3. The resolution bandwidth of test receiver/spectrum analyzer is 1MHz and the video bandwidth is 10Hz for Average detection (AV) at frequency above 1GHz.
4. All modes of operation were investigated and the worst-case emissions are reported.

4.1.4 DEVIATION FROM TEST STANDARD

No deviation.

4.1.5 TEST SETUP

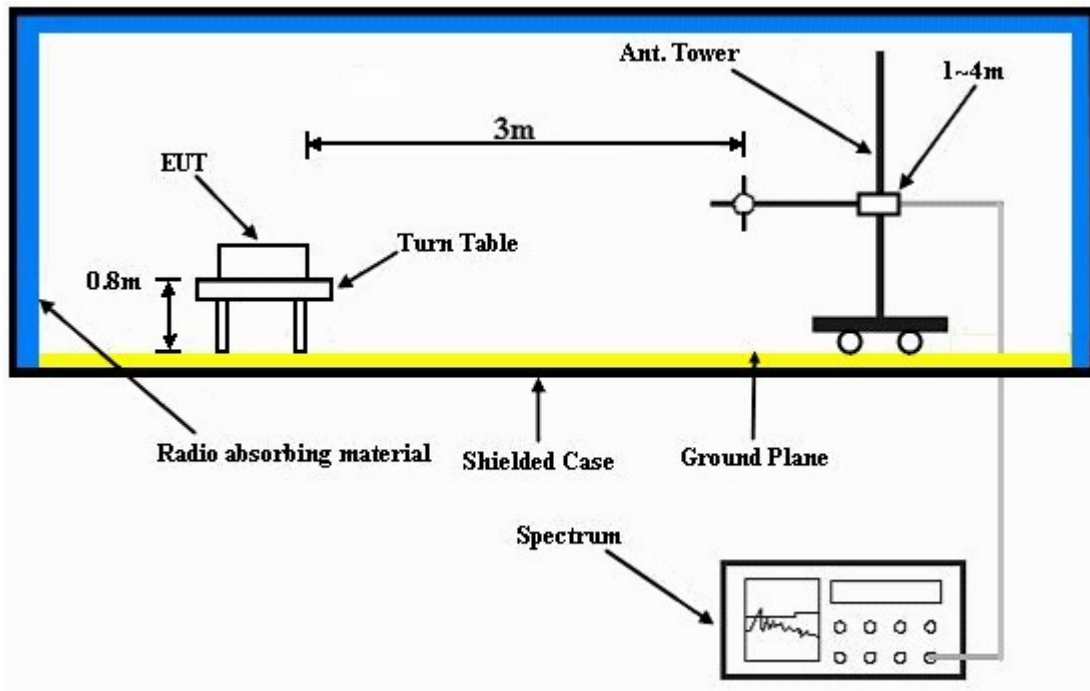

For the actual test configuration, please refer to the attached file (Test Setup Photo).

4.1.6 EUT OPERATING CONDITIONS

TEST MODE A & B

- Placed the EUT on the testing table.
- Prepared one notebook system outside of testing area to act as communication partner.
- The communication partners connected with EUT via a RJ45 cable and run a test program (provided by manufacturer) to enable EUT under transmission condition continuously at specific channel frequency.
- The necessary accessories enable the system in full functions.

TEST MODE C

- Connected the EUT via USB cable into a notebook system and placed on a testing table.
- The notebook system ran a test program (provided by manufacturer) to enable EUT under transmission condition continuously at specific channel frequency.
- The necessary accessories enable the system in full functions.



A D T

4.1.7 TEST RESULTS

802.11b DSSS MODULATION

EUT TEST CONDITION		MEASUREMENT DETAIL	
CHANNEL	Channel 1	FREQUENCY RANGE	1 ~ 25GHz
INPUT POWER (SYSTEM)	120Vac, 60 Hz	DETECTOR FUNCTION	Peak (PK) Average (AV)
ENVIRONMENTAL CONDITIONS	24.0deg. C, 64.0%RH 1000hPa	TESTED BY	Match Tsui

ANTENNA POLARITY & TEST DISTANCE: HORIZONTAL AT 3 M								
NO.	FREQ. (MHz)	EMISSION LEVEL (dBuV/m)	LIMIT (dBuV/m)	MARGIN (dB)	ANTENNA HEIGHT (m)	TABLE ANGLE (Degree)	RAW VALUE (dBuV)	CORRECTION FACTOR (dB/m)
1	2390.00	58.85 PK	74.00	-15.15	1.33 H	26	25.77	33.08
2	2390.00	47.56 AV	54.00	-6.44	1.33 H	26	14.48	33.08
3	*2412.00	109.70 PK			1.33 H	22	76.52	33.18
4	*2412.00	105.51 AV			1.33 H	22	72.33	33.18
5	2494.50	62.04 PK	74.00	-11.96	1.03 H	28	28.53	33.51
6	2494.50	52.46 AV	54.00	-1.54	1.03 H	28	18.95	33.51
7	4824.00	50.12 PK	74.00	-23.88	1.17 H	148	10.97	39.15
8	4824.00	41.75 AV	54.00	-12.25	1.17 H	148	2.60	39.15
ANTENNA POLARITY & TEST DISTANCE: VERTICAL AT 3 M								
NO.	FREQ. (MHz)	EMISSION LEVEL (dBuV/m)	LIMIT (dBuV/m)	MARGIN (dB)	ANTENNA HEIGHT (m)	TABLE ANGLE (Degree)	RAW VALUE (dBuV)	CORRECTION FACTOR (dB/m)
1	2390.00	55.70 PK	74.00	-18.30	1.05 V	360	22.62	33.08
2	2390.00	46.95 AV	54.00	-7.05	1.05 V	360	13.87	33.08
3	*2412.00	101.47 PK			1.44 V	358	68.29	33.18
4	*2412.00	97.48 AV			1.44 V	358	64.30	33.18
5	4824.00	51.91 PK	74.00	-22.09	1.00 V	105	12.76	39.15
6	4824.00	46.13 AV	54.00	-7.87	1.00 V	105	6.98	39.15

- REMARKS:**
1. Emission level (dBuV/m) = Raw Value (dBuV) + Correction Factor (dB/m).
 2. Correction Factor (dB/m) = Antenna Factor (dB/m) + Cable Factor (dB).
 3. The other emission levels were very low against the limit.
 4. Margin value = Emission level – Limit value.
 5. “ * “: Fundamental frequency.



A D T

EUT TEST CONDITION		MEASUREMENT DETAIL	
CHANNEL	Channel 6	FREQUENCY RANGE	1 ~ 25GHz
INPUT POWER (SYSTEM)	120Vac, 60 Hz	DETECTOR FUNCTION	Peak (PK) Average (AV)
ENVIRONMENTAL CONDITIONS	24.0deg. C, 64.0%RH 1000hPa	TESTED BY	Match Tsui

ANTENNA POLARITY & TEST DISTANCE: HORIZONTAL AT 3 M								
NO.	FREQ. (MHz)	EMISSION LEVEL (dBuV/m)	LIMIT (dBuV/m)	MARGIN (dB)	ANTENNA HEIGHT (m)	TABLE ANGLE (Degree)	RAW VALUE (dBuV)	CORRECTION FACTOR (dB/m)
1	*2437.00	109.72 PK			1.30 H	283	76.44	33.28
2	*2437.00	105.58 AV			1.30 H	283	72.30	33.28
3	4874.00	49.52 PK	74.00	-24.48	1.25 H	151	10.37	39.14
4	4874.00	37.97 AV	54.00	-16.03	1.25 H	151	-1.18	39.14
ANTENNA POLARITY & TEST DISTANCE: VERTICAL AT 3 M								
NO.	FREQ. (MHz)	EMISSION LEVEL (dBuV/m)	LIMIT (dBuV/m)	MARGIN (dB)	ANTENNA HEIGHT (m)	TABLE ANGLE (Degree)	RAW VALUE (dBuV)	CORRECTION FACTOR (dB/m)
1	*2437.00	101.59 PK			1.42 V	359	68.31	33.28
2	*2437.00	97.51 AV			1.42 V	359	64.23	33.28
3	4874.00	51.32 PK	74.00	-22.68	1.10 V	164	12.17	39.14
4	4874.00	42.75 AV	54.00	-11.25	1.10 V	164	3.60	39.14

- REMARKS:**
1. Emission level (dBuV/m) = Raw Value (dBuV) + Correction Factor (dB/m).
 2. Correction Factor (dB/m) = Antenna Factor (dB/m) + Cable Factor (dB).
 3. The other emission levels were very low against the limit.
 4. Margin value = Emission level – Limit value.
 5. “ * “: Fundamental frequency.



A D T

EUT TEST CONDITION		MEASUREMENT DETAIL	
CHANNEL	Channel 11	FREQUENCY RANGE	1 ~ 25GHz
INPUT POWER (SYSTEM)	120Vac, 60 Hz	DETECTOR FUNCTION	Peak (PK) Average (AV)
ENVIRONMENTAL CONDITIONS	24.0deg. C, 64.0%RH 1000hPa	TESTED BY	Match Tsui

ANTENNA POLARITY & TEST DISTANCE: HORIZONTAL AT 3 M								
NO.	FREQ. (MHz)	EMISSION LEVEL (dBuV/m)	LIMIT (dBuV/m)	MARGIN (dB)	ANTENNA HEIGHT (m)	TABLE ANGLE (Degree)	RAW VALUE (dBuV)	CORRECTION FACTOR (dB/m)
1	*2462.00	109.85 PK			1.03 H	24	76.47	33.38
2	*2462.00	105.80 AV			1.03 H	24	72.42	33.38
3	2483.50	58.82 PK	74.00	-15.18	1.10 H	26	25.36	33.46
4	2483.50	48.14 AV	54.00	-5.86	1.10 H	26	14.68	33.46
5	4924.00	49.68 PK	74.00	-24.32	1.02 H	171	10.32	39.35
6	4924.00	38.72 AV	54.00	-15.28	1.02 H	171	-0.64	39.35
ANTENNA POLARITY & TEST DISTANCE: VERTICAL AT 3 M								
NO.	FREQ. (MHz)	EMISSION LEVEL (dBuV/m)	LIMIT (dBuV/m)	MARGIN (dB)	ANTENNA HEIGHT (m)	TABLE ANGLE (Degree)	RAW VALUE (dBuV)	CORRECTION FACTOR (dB/m)
1	*2462.00	101.79 PK			1.00 V	360	68.41	33.38
2	*2462.00	97.76 AV			1.00 V	360	64.38	33.38
3	2483.50	57.83 PK	74.00	-16.17	1.00 V	360	24.37	33.46
4	2483.50	47.36 AV	54.00	-6.64	1.00 V	360	13.90	33.46
5	4924.00	50.55 PK	74.00	-23.45	1.25 V	106	11.19	39.35
6	4924.00	42.68 AV	54.00	-11.32	1.25 V	106	3.32	39.35

- REMARKS:**
1. Emission level (dBuV/m) = Raw Value (dBuV) + Correction Factor (dB/m).
 2. Correction Factor (dB/m) = Antenna Factor (dB/m) + Cable Factor (dB).
 3. The other emission levels were very low against the limit.
 4. Margin value = Emission level – Limit value.
 5. “ * “: Fundamental frequency.



A D T

802.11g OFDM MODULATION

EUT TEST CONDITION		MEASUREMENT DETAIL	
CHANNEL	Channel 1	FREQUENCY RANGE	1 ~ 25GHz
INPUT POWER (SYSTEM)	120Vac, 60 Hz	DETECTOR FUNCTION	Peak (PK) Average (AV)
ENVIRONMENTAL CONDITIONS	24.0deg. C, 64.0%RH 1000hPa	TESTED BY	Match Tsui

ANTENNA POLARITY & TEST DISTANCE: HORIZONTAL AT 3 M								
NO.	FREQ. (MHz)	EMISSION LEVEL (dBuV/m)	LIMIT (dBuV/m)	MARGIN (dB)	ANTENNA HEIGHT (m)	TABLE ANGLE (Degree)	RAW VALUE (dBuV)	CORRECTION FACTOR (dB/m)
1	2360.00	59.85 PK	74.00	-14.15	1.10 H	29	26.93	32.92
2	2360.00	49.64 AV	54.00	-4.36	1.10 H	29	16.72	32.92
3	2390.00	62.19 PK	74.00	-11.81	1.08 H	28	29.11	33.08
4	2390.00	48.33 AV	54.00	-5.67	1.08 H	28	15.25	33.08
5	*2412.00	110.63 PK			1.33 H	26	77.45	33.18
6	*2412.00	100.66 AV			1.33 H	26	67.48	33.18
7	2486.00	61.16 PK	74.00	-12.84	1.06 H	28	27.69	33.47
8	2486.00	49.71 AV	54.00	-4.29	1.06 H	28	16.24	33.47
9	4824.00	48.96 PK	74.00	-25.04	1.00 H	360	9.81	39.15
10	4824.00	35.94 AV	54.00	-18.06	1.00 H	360	-3.21	39.15
ANTENNA POLARITY & TEST DISTANCE: VERTICAL AT 3 M								
NO.	FREQ. (MHz)	EMISSION LEVEL (dBuV/m)	LIMIT (dBuV/m)	MARGIN (dB)	ANTENNA HEIGHT (m)	TABLE ANGLE (Degree)	RAW VALUE (dBuV)	CORRECTION FACTOR (dB/m)
1	2390.00	57.85 PK	74.00	-16.15	1.51 V	360	24.77	33.08
2	2390.00	46.99 AV	54.00	-7.01	1.51 V	360	13.91	33.08
3	*2412.00	102.50 PK			1.51 V	360	69.32	33.18
4	*2412.00	92.57 AV			1.51 V	360	59.39	33.18
5	4824.00	49.92 PK	74.00	-24.08	1.00 V	0	10.77	39.15
6	4824.00	36.57 AV	54.00	-17.43	1.00 V	0	-2.58	39.15

- REMARKS:**
1. Emission level (dBuV/m) = Raw Value (dBuV) + Correction Factor (dB/m).
 2. Correction Factor (dB/m) = Antenna Factor (dB/m) + Cable Factor (dB).
 3. The other emission levels were very low against the limit.
 4. Margin value = Emission level – Limit value.
 5. “ * “: Fundamental frequency.



A D T

EUT TEST CONDITION		MEASUREMENT DETAIL	
CHANNEL	Channel 6	FREQUENCY RANGE	1 ~ 25GHz
INPUT POWER (SYSTEM)	120Vac, 60 Hz	DETECTOR FUNCTION	Peak (PK) Average (AV)
ENVIRONMENTAL CONDITIONS	24.0deg. C, 64.0%RH 1000hPa	TESTED BY	Match Tsui

ANTENNA POLARITY & TEST DISTANCE: HORIZONTAL AT 3 M								
NO.	FREQ. (MHz)	EMISSION LEVEL (dBuV/m)	LIMIT (dBuV/m)	MARGIN (dB)	ANTENNA HEIGHT (m)	TABLE ANGLE (Degree)	RAW VALUE (dBuV)	CORRECTION FACTOR (dB/m)
1	2384.00	59.31 PK	74.00	-14.69	1.15 H	33	26.26	33.05
2	2384.00	48.79 AV	54.00	-5.21	1.15 H	33	15.74	33.05
3	*2437.00	110.37 PK			1.06 H	30	77.09	33.28
4	*2437.00	100.75 AV			1.06 H	30	67.47	33.28
5	4874.00	48.49 PK	74.00	-25.51	1.15 H	360	9.34	39.14
6	4874.00	36.01 AV	54.00	-17.99	1.15 H	360	-3.14	39.14
ANTENNA POLARITY & TEST DISTANCE: VERTICAL AT 3 M								
NO.	FREQ. (MHz)	EMISSION LEVEL (dBuV/m)	LIMIT (dBuV/m)	MARGIN (dB)	ANTENNA HEIGHT (m)	TABLE ANGLE (Degree)	RAW VALUE (dBuV)	CORRECTION FACTOR (dB/m)
1	*2437.00	102.47 PK			1.76 V	360	69.19	33.28
2	*2437.00	92.54 AV			1.76 V	360	59.26	33.28
3	4874.00	49.04 PK	74.00	-24.96	1.06 V	1	9.89	39.14
4	4874.00	35.98 AV	54.00	-18.02	1.06 V	1	-3.17	39.14

- REMARKS:**
1. Emission level (dBuV/m) = Raw Value (dBuV) + Correction Factor (dB/m).
 2. Correction Factor (dB/m) = Antenna Factor (dB/m) + Cable Factor (dB).
 3. The other emission levels were very low against the limit.
 4. Margin value = Emission level – Limit value.
 5. “ * “: Fundamental frequency.



A D T

EUT TEST CONDITION		MEASUREMENT DETAIL	
CHANNEL	Channel 11	FREQUENCY RANGE	1 ~ 25GHz
INPUT POWER (SYSTEM)	120Vac, 60 Hz	DETECTOR FUNCTION	Peak (PK) Average (AV)
ENVIRONMENTAL CONDITIONS	24.0deg. C, 64.0%RH 1000hPa	TESTED BY	Match Tsui

ANTENNA POLARITY & TEST DISTANCE: HORIZONTAL AT 3 M								
NO.	FREQ. (MHz)	EMISSION LEVEL (dBuV/m)	LIMIT (dBuV/m)	MARGIN (dB)	ANTENNA HEIGHT (m)	TABLE ANGLE (Degree)	RAW VALUE (dBuV)	CORRECTION FACTOR (dB/m)
1	*2462.00	110.75 PK			1.05 H	20	77.37	33.38
2	*2462.00	100.85 AV			1.33 H	29	67.47	33.38
3	2483.50	63.25 PK	74.00	-10.75	1.05 H	22	29.79	33.46
4	2483.50	49.92 AV	54.00	-4.08	1.05 H	22	16.46	33.46
5	4924.00	49.07 PK	74.00	-24.93	1.00 H	350	9.72	39.35
6	4924.00	36.01 AV	54.00	-17.99	1.00 H	350	-3.34	39.35
ANTENNA POLARITY & TEST DISTANCE: VERTICAL AT 3 M								
NO.	FREQ. (MHz)	EMISSION LEVEL (dBuV/m)	LIMIT (dBuV/m)	MARGIN (dB)	ANTENNA HEIGHT (m)	TABLE ANGLE (Degree)	RAW VALUE (dBuV)	CORRECTION FACTOR (dB/m)
1	*2462.00	102.26 PK			1.45 V	358	68.88	33.38
2	*2462.00	92.78 AV			1.45 V	358	59.40	33.38
3	2483.50	56.87 PK	74.00	-17.13	1.45 V	358	23.41	33.46
4	2483.50	47.39 AV	54.00	-6.61	1.45 V	358	13.93	33.46
5	4924.00	49.02 PK	74.00	-24.98	1.00 V	360	9.67	39.35
6	4924.00	35.94 AV	54.00	-18.06	1.00 V	360	-3.41	39.35

- REMARKS:**
1. Emission level (dBuV/m) = Raw Value (dBuV) + Correction Factor (dB/m).
 2. Correction Factor (dB/m) = Antenna Factor (dB/m) + Cable Factor (dB).
 3. The other emission levels were very low against the limit.
 4. Margin value = Emission level – Limit value.
 5. “ * “: Fundamental frequency.



A D T

DRAFT 802.11n (20MHz) OFDM MODULATION

EUT TEST CONDITION		MEASUREMENT DETAIL	
CHANNEL	Channel 1	FREQUENCY RANGE	1 ~ 25GHz
INPUT POWER (SYSTEM)	120Vac, 60 Hz	DETECTOR FUNCTION	Peak (PK) Average (AV)
ENVIRONMENTAL CONDITIONS	24.0deg. C, 64.0%RH 1000hPa	TESTED BY	Match Tsui

ANTENNA POLARITY & TEST DISTANCE: HORIZONTAL AT 3 M								
NO.	FREQ. (MHz)	EMISSION LEVEL (dBuV/m)	LIMIT (dBuV/m)	MARGIN (dB)	ANTENNA HEIGHT (m)	TABLE ANGLE (Degree)	RAW VALUE (dBuV)	CORRECTION FACTOR (dB/m)
1	2360.00	60.13 PK	74.00	-13.87	1.12 H	24	27.21	32.92
2	2360.00	49.04 AV	54.00	-4.96	1.12 H	24	16.12	32.92
3	2390.00	58.37 PK	74.00	-15.63	1.05 H	15	25.29	33.08
4	2390.00	47.88 AV	54.00	-6.12	1.05 H	15	14.80	33.08
5	*2412.00	108.10 PK			1.34 H	26	74.92	33.18
6	*2412.00	98.02 AV			1.34 H	26	64.84	33.18
7	4824.00	48.78 PK	74.00	-25.22	1.00 H	350	9.63	39.15
8	4824.00	36.11 AV	54.00	-17.89	1.00 H	350	-3.04	39.15
ANTENNA POLARITY & TEST DISTANCE: VERTICAL AT 3 M								
NO.	FREQ. (MHz)	EMISSION LEVEL (dBuV/m)	LIMIT (dBuV/m)	MARGIN (dB)	ANTENNA HEIGHT (m)	TABLE ANGLE (Degree)	RAW VALUE (dBuV)	CORRECTION FACTOR (dB/m)
1	2390.00	56.97 PK	74.00	-17.03	1.11 V	41	23.89	33.08
2	2390.00	46.98 AV	54.00	-7.02	1.11 V	41	13.90	33.08
3	*2412.00	101.89 PK			1.11 V	41	68.71	33.18
4	*2412.00	91.52 AV			1.11 V	41	58.34	33.18
5	4824.00	49.11 PK	74.00	-24.89	1.00 V	1	9.96	39.15
6	4824.00	36.06 AV	54.00	-17.94	1.00 V	1	-3.09	39.15

- REMARKS:**
1. Emission level (dBuV/m) = Raw Value (dBuV) + Correction Factor (dB/m).
 2. Correction Factor (dB/m) = Antenna Factor (dB/m) + Cable Factor (dB).
 3. The other emission levels were very low against the limit.
 4. Margin value = Emission level – Limit value.
 5. “ * “: Fundamental frequency.



A D T

EUT TEST CONDITION		MEASUREMENT DETAIL	
CHANNEL	Channel 6	FREQUENCY RANGE	1 ~ 25GHz
INPUT POWER (SYSTEM)	120Vac, 60 Hz	DETECTOR FUNCTION	Peak (PK) Average (AV)
ENVIRONMENTAL CONDITIONS	24.0deg. C, 64.0%RH 1000hPa	TESTED BY	Match Tsui

ANTENNA POLARITY & TEST DISTANCE: HORIZONTAL AT 3 M								
NO.	FREQ. (MHz)	EMISSION LEVEL (dBuV/m)	LIMIT (dBuV/m)	MARGIN (dB)	ANTENNA HEIGHT (m)	TABLE ANGLE (Degree)	RAW VALUE (dBuV)	CORRECTION FACTOR (dB/m)
1	*2437.00	108.08 PK			1.06 H	352	74.80	33.28
2	*2437.00	98.09 AV			1.06 H	352	64.81	33.28
3	4874.00	48.69 PK	74.00	-25.31	1.00 H	360	9.55	39.14
4	4874.00	36.03 AV	54.00	-17.97	1.00 H	360	-3.11	39.14
ANTENNA POLARITY & TEST DISTANCE: VERTICAL AT 3 M								
NO.	FREQ. (MHz)	EMISSION LEVEL (dBuV/m)	LIMIT (dBuV/m)	MARGIN (dB)	ANTENNA HEIGHT (m)	TABLE ANGLE (Degree)	RAW VALUE (dBuV)	CORRECTION FACTOR (dB/m)
1	*2437.00	102.08 PK			1.42 V	0	68.80	33.28
2	*2437.00	91.76 AV			1.42 V	0	58.48	33.28
3	4874.00	49.04 PK	74.00	-24.96	1.00 V	350	9.90	39.14
4	4874.00	36.01 AV	54.00	-17.99	1.00 V	350	-3.13	39.14

- REMARKS:**
1. Emission level (dBuV/m) = Raw Value (dBuV) + Correction Factor (dB/m).
 2. Correction Factor (dB/m) = Antenna Factor (dB/m) + Cable Factor (dB).
 3. The other emission levels were very low against the limit.
 4. Margin value = Emission level – Limit value.
 5. “ * “: Fundamental frequency.



A D T

EUT TEST CONDITION		MEASUREMENT DETAIL	
CHANNEL	Channel 11	FREQUENCY RANGE	1 ~ 25GHz
INPUT POWER (SYSTEM)	120Vac, 60 Hz	DETECTOR FUNCTION	Peak (PK) Average (AV)
ENVIRONMENTAL CONDITIONS	24.0deg. C, 64.0%RH 1000hPa	TESTED BY	Match Tsui

ANTENNA POLARITY & TEST DISTANCE: HORIZONTAL AT 3 M								
NO.	FREQ. (MHz)	EMISSION LEVEL (dBuV/m)	LIMIT (dBuV/m)	MARGIN (dB)	ANTENNA HEIGHT (m)	TABLE ANGLE (Degree)	RAW VALUE (dBuV)	CORRECTION FACTOR (dB/m)
1	*2462.00	108.25 PK			1.28 H	99	74.87	33.38
2	*2462.00	98.16 AV			1.28 H	99	64.78	33.38
3	2483.50	65.44 PK	74.00	-8.56	1.30 H	100	31.98	33.46
4	2483.50	49.41 AV	54.00	-4.59	1.30 H	100	15.95	33.46
5	4924.00	48.17 PK	74.00	-25.83	1.00 H	360	8.81	39.35
6	4924.00	35.50 AV	54.00	-18.50	1.00 H	360	-3.86	39.35
ANTENNA POLARITY & TEST DISTANCE: VERTICAL AT 3 M								
NO.	FREQ. (MHz)	EMISSION LEVEL (dBuV/m)	LIMIT (dBuV/m)	MARGIN (dB)	ANTENNA HEIGHT (m)	TABLE ANGLE (Degree)	RAW VALUE (dBuV)	CORRECTION FACTOR (dB/m)
1	*2462.00	101.92 PK			1.46 V	360	68.54	33.38
2	*2462.00	91.63 AV			1.46 V	360	58.25	33.38
3	2483.50	59.17 PK	74.00	-14.83	1.46 V	360	25.71	33.46
4	2483.50	47.56 AV	54.00	-6.44	1.46 V	360	14.10	33.46
5	4924.00	48.15 PK	74.00	-25.85	1.09 V	360	8.79	39.35
6	4924.00	35.46 AV	54.00	-18.54	1.09 V	360	-3.90	39.35

- REMARKS:**
1. Emission level (dBuV/m) = Raw Value (dBuV) + Correction Factor (dB/m).
 2. Correction Factor (dB/m) = Antenna Factor (dB/m) + Cable Factor (dB).
 3. The other emission levels were very low against the limit.
 4. Margin value = Emission level – Limit value.
 5. “ * “: Fundamental frequency.



A D T

DRAFT 802.11n (40MHz) OFDM MODULATION

EUT TEST CONDITION		MEASUREMENT DETAIL	
CHANNEL	Channel 1	FREQUENCY RANGE	1 ~ 25GHz
INPUT POWER (SYSTEM)	120Vac, 60 Hz	DETECTOR FUNCTION	Peak (PK) Average (AV)
ENVIRONMENTAL CONDITIONS	24.0deg. C, 64.0%RH 1000hPa	TESTED BY	Match Tsui

ANTENNA POLARITY & TEST DISTANCE: HORIZONTAL AT 3 M								
NO.	FREQ. (MHz)	EMISSION LEVEL (dBuV/m)	LIMIT (dBuV/m)	MARGIN (dB)	ANTENNA HEIGHT (m)	TABLE ANGLE (Degree)	RAW VALUE (dBuV)	CORRECTION FACTOR (dB/m)
1	2390.00	60.30 PK	74.00	-13.70	1.40 H	33	27.22	33.08
2	2390.00	49.09 AV	54.00	-4.91	1.40 H	33	16.01	33.08
3	*2422.00	103.43 PK			1.30 H	101	70.21	33.22
4	*2422.00	93.42 AV			1.30 H	101	60.20	33.22
5	4844.00	48.79 PK	74.00	-25.21	1.00 H	300	9.65	39.15
6	4844.00	35.39 AV	54.00	-18.61	1.00 H	300	-3.75	39.15
ANTENNA POLARITY & TEST DISTANCE: VERTICAL AT 3 M								
NO.	FREQ. (MHz)	EMISSION LEVEL (dBuV/m)	LIMIT (dBuV/m)	MARGIN (dB)	ANTENNA HEIGHT (m)	TABLE ANGLE (Degree)	RAW VALUE (dBuV)	CORRECTION FACTOR (dB/m)
1	2390.00	56.63 PK	74.00	-17.37	1.48 V	360	23.55	33.08
2	2390.00	46.84 AV	54.00	-7.16	1.48 V	360	13.76	33.08
3	*2422.00	96.55 PK			1.48 V	360	63.33	33.22
4	*2422.00	86.44 AV			1.48 V	360	53.22	33.22
5	4844.00	48.62 PK	74.00	-25.38	1.00 V	360	9.47	39.15
6	4844.00	35.24 AV	54.00	-18.76	1.00 V	360	-3.91	39.15

- REMARKS:**
1. Emission level (dBuV/m) = Raw Value (dBuV) + Correction Factor (dB/m).
 2. Correction Factor (dB/m) = Antenna Factor (dB/m) + Cable Factor (dB).
 3. The other emission levels were very low against the limit.
 4. Margin value = Emission level – Limit value.
 5. “ * “: Fundamental frequency.



A D T

EUT TEST CONDITION		MEASUREMENT DETAIL	
CHANNEL	Channel 4	FREQUENCY RANGE	1 ~ 25GHz
INPUT POWER (SYSTEM)	120Vac, 60 Hz	DETECTOR FUNCTION	Peak (PK) Average (AV)
ENVIRONMENTAL CONDITIONS	24.0deg. C, 64.0%RH 1000hPa	TESTED BY	Match Tsui

ANTENNA POLARITY & TEST DISTANCE: HORIZONTAL AT 3 M								
NO.	FREQ. (MHz)	EMISSION LEVEL (dBuV/m)	LIMIT (dBuV/m)	MARGIN (dB)	ANTENNA HEIGHT (m)	TABLE ANGLE (Degree)	RAW VALUE (dBuV)	CORRECTION FACTOR (dB/m)
1	2390.00	58.34 PK	74.00	-15.66	1.34 H	25	25.26	33.08
2	2390.00	47.22 AV	54.00	-6.78	1.34 H	25	14.14	33.08
3	*2437.00	103.66 PK			1.34 H	25	70.38	33.28
4	*2437.00	93.61 AV			1.34 H	25	60.33	33.28
5	2483.50	57.58 PK	74.00	-16.42	1.34 H	25	24.12	33.46
6	2483.50	47.75 AV	54.00	-6.25	1.34 H	25	14.29	33.46
7	4874.00	48.89 PK	74.00	-25.11	1.04 H	180	9.75	39.14
8	4874.00	35.52 AV	54.00	-18.48	1.04 H	180	-3.62	39.14
ANTENNA POLARITY & TEST DISTANCE: VERTICAL AT 3 M								
NO.	FREQ. (MHz)	EMISSION LEVEL (dBuV/m)	LIMIT (dBuV/m)	MARGIN (dB)	ANTENNA HEIGHT (m)	TABLE ANGLE (Degree)	RAW VALUE (dBuV)	CORRECTION FACTOR (dB/m)
1	*2437.00	96.63 PK			1.06 V	330	63.35	33.28
2	*2437.00	86.57 AV			1.06 V	330	53.29	33.28
3	4874.00	48.66 PK	74.00	-25.34	1.06 V	360	9.52	39.14
4	4874.00	35.47 AV	54.00	-18.53	1.06 V	360	-3.67	39.14

- REMARKS:**
1. Emission level (dBuV/m) = Raw Value (dBuV) + Correction Factor (dB/m).
 2. Correction Factor (dB/m) = Antenna Factor (dB/m) + Cable Factor (dB).
 3. The other emission levels were very low against the limit.
 4. Margin value = Emission level – Limit value.
 5. “ * “: Fundamental frequency.



A D T

EUT TEST CONDITION		MEASUREMENT DETAIL	
CHANNEL	Channel 7	FREQUENCY RANGE	1 ~ 25GHz
INPUT POWER (SYSTEM)	120Vac, 60 Hz	DETECTOR FUNCTION	Peak (PK) Average (AV)
ENVIRONMENTAL CONDITIONS	24.0deg. C, 64.0%RH 1000hPa	TESTED BY	Match Tsui

ANTENNA POLARITY & TEST DISTANCE: HORIZONTAL AT 3 M								
NO.	FREQ. (MHz)	EMISSION LEVEL (dBuV/m)	LIMIT (dBuV/m)	MARGIN (dB)	ANTENNA HEIGHT (m)	TABLE ANGLE (Degree)	RAW VALUE (dBuV)	CORRECTION FACTOR (dB/m)
1	*2452.00	103.78 PK			1.34 H	27	70.44	33.34
2	*2452.00	93.72 AV			1.34 H	27	60.38	33.34
3	2483.50	63.23 PK	74.00	-10.77	1.28 H	101	29.77	33.46
4	2483.50	51.42 AV	54.00	-2.58	1.28 H	101	17.96	33.46
5	4904.00	48.67 PK	74.00	-25.33	1.28 H	100	9.49	39.18
6	4904.00	35.21 AV	54.00	-18.79	1.28 H	100	-3.97	39.18
ANTENNA POLARITY & TEST DISTANCE: VERTICAL AT 3 M								
NO.	FREQ. (MHz)	EMISSION LEVEL (dBuV/m)	LIMIT (dBuV/m)	MARGIN (dB)	ANTENNA HEIGHT (m)	TABLE ANGLE (Degree)	RAW VALUE (dBuV)	CORRECTION FACTOR (dB/m)
1	*2452.00	96.79 PK			1.27 V	360	63.45	33.34
2	*2452.00	86.49 AV			1.27 V	360	53.15	33.34
3	2483.50	58.84 PK	74.00	-15.16	1.00 V	360	25.38	33.46
4	2483.50	48.92 AV	54.00	-5.08	1.00 V	360	15.46	33.46
5	4904.00	48.78 PK	74.00	-25.22	1.04 V	360	9.60	39.18
6	4904.00	35.31 AV	54.00	-18.69	1.04 V	360	-3.87	39.18

- REMARKS:**
1. Emission level (dBuV/m) = Raw Value (dBuV) + Correction Factor (dB/m).
 2. Correction Factor (dB/m) = Antenna Factor (dB/m) + Cable Factor (dB).
 3. The other emission levels were very low against the limit.
 4. Margin value = Emission level – Limit value.
 5. “ * “: Fundamental frequency.



A D T

BELOW 1GHz WORST-CASE DATA : 802.11g OFDM MODULATION

EUT TEST CONDITION		MEASUREMENT DETAIL	
CHANNEL	Channel 6	FREQUENCY RANGE	Below 1000MHz
INPUT POWER (SYSTEM)	120Vac, 60 Hz	DETECTOR FUNCTION	Quasi-Peak
ENVIRONMENTAL CONDITIONS	24.0deg. C, 64.0%RH 999hPa	TEST MODE	A
TESTED BY	Match Tsui		

ANTENNA POLARITY & TEST DISTANCE: HORIZONTAL AT 3 M								
NO.	FREQ. (MHz)	EMISSION LEVEL (dBuV/m)	LIMIT (dBuV/m)	MARGIN (dB)	ANTENNA HEIGHT (m)	TABLE ANGLE (Degree)	RAW VALUE (dBuV)	CORRECTION FACTOR (dB/m)
1	127.11	32.56 QP	43.50	-10.94	1.50 H	265	20.53	12.03
2	144.61	31.88 QP	43.50	-11.62	1.25 H	88	18.72	13.16
3	173.78	30.54 QP	43.50	-12.96	1.50 H	283	17.88	12.66
4	208.77	34.26 QP	43.50	-9.24	1.50 H	106	23.28	10.98
5	249.60	43.76 QP	46.00	-2.24	1.00 H	283	30.95	12.81
6	374.04	39.58 QP	46.00	-6.42	1.00 H	340	24.15	15.43
7	500.42	33.15 QP	46.00	-12.85	1.50 H	334	13.89	19.25
8	640.41	40.53 QP	46.00	-5.47	1.25 H	55	18.29	22.24
9	897.05	37.74 QP	46.00	-8.26	1.00 H	37	11.66	26.08
ANTENNA POLARITY & TEST DISTANCE: VERTICAL AT 3 M								
NO.	FREQ. (MHz)	EMISSION LEVEL (dBuV/m)	LIMIT (dBuV/m)	MARGIN (dB)	ANTENNA HEIGHT (m)	TABLE ANGLE (Degree)	RAW VALUE (dBuV)	CORRECTION FACTOR (dB/m)
1	43.51	35.76 QP	40.00	-4.24	1.00 V	226	23.29	12.47
2	125.17	36.57 QP	43.50	-6.93	1.00 V	166	24.62	11.95
3	144.61	30.70 QP	43.50	-12.80	1.25 V	235	17.54	13.16
4	249.60	38.17 QP	46.00	-7.83	1.00 V	76	25.35	12.81
5	440.14	33.39 QP	46.00	-12.61	2.00 V	298	15.99	17.39
6	500.42	33.81 QP	46.00	-12.19	1.00 V	316	14.56	19.25
7	640.41	41.79 QP	46.00	-4.21	1.50 V	241	19.55	22.24
8	897.05	43.58 QP	46.00	-2.42	1.00 V	349	17.50	26.08

- REMARKS:**
1. Emission level (dBuV/m) = Raw Value (dBuV) + Correction Factor (dB/m).
 2. Correction Factor (dB/m) = Antenna Factor (dB/m) + Cable Factor (dB).
 3. The other emission levels were very low against the limit.
 4. Margin value = Emission level – Limit value.



A D T

EUT TEST CONDITION		MEASUREMENT DETAIL	
CHANNEL	Channel 6	FREQUENCY RANGE	Below 1000MHz
INPUT POWER (SYSTEM)	120Vac, 60 Hz	DETECTOR FUNCTION	Quasi-Peak
ENVIRONMENTAL CONDITIONS	24.0deg. C, 64.0%RH 999hPa	TEST MODE	B
TESTED BY	Match Tsui		

ANTENNA POLARITY & TEST DISTANCE: HORIZONTAL AT 3 M								
NO.	FREQ. (MHz)	EMISSION LEVEL (dBuV/m)	LIMIT (dBuV/m)	MARGIN (dB)	ANTENNA HEIGHT (m)	TABLE ANGLE (Degree)	RAW VALUE (dBuV)	CORRECTION FACTOR (dB/m)
1	127.11	37.38 QP	43.50	-6.12	1.50 H	103	25.36	12.03
2	250.00	44.97 QP	46.00	-1.03	1.00 H	120	32.14	12.83
3	375.44	44.93 QP	46.00	-1.07	1.00 H	127	29.47	15.46
4	500.42	37.76 QP	46.00	-8.24	1.25 H	205	18.50	19.25
5	642.35	40.10 QP	46.00	-5.90	1.25 H	145	17.85	22.25
6	899.00	41.44 QP	46.00	-4.56	1.00 H	247	15.34	26.10
ANTENNA POLARITY & TEST DISTANCE: VERTICAL AT 3 M								
NO.	FREQ. (MHz)	EMISSION LEVEL (dBuV/m)	LIMIT (dBuV/m)	MARGIN (dB)	ANTENNA HEIGHT (m)	TABLE ANGLE (Degree)	RAW VALUE (dBuV)	CORRECTION FACTOR (dB/m)
1	43.51	35.99 QP	40.00	-4.01	1.25 V	274	23.52	12.47
2	103.78	37.03 QP	43.50	-6.47	1.50 V	310	27.24	9.79
3	144.61	34.81 QP	43.50	-8.69	1.00 V	172	21.64	13.16
4	249.60	37.84 QP	46.00	-8.16	1.00 V	355	25.02	12.81
5	375.98	36.30 QP	46.00	-9.70	1.00 V	193	20.82	15.48
6	500.42	37.07 QP	46.00	-8.93	1.00 V	175	17.81	19.25
7	642.35	40.26 QP	46.00	-5.74	1.00 V	214	18.01	22.25
8	899.00	41.79 QP	46.00	-4.21	1.00 V	187	15.69	26.10

- REMARKS:**
1. Emission level (dBuV/m) = Raw Value (dBuV) + Correction Factor (dB/m).
 2. Correction Factor (dB/m) = Antenna Factor (dB/m) + Cable Factor (dB).
 3. The other emission levels were very low against the limit.
 4. Margin value = Emission level – Limit value.



A D T

EUT TEST CONDITION		MEASUREMENT DETAIL	
CHANNEL	Channel 6	FREQUENCY RANGE	Below 1000MHz
INPUT POWER (SYSTEM)	120Vac, 60 Hz	DETECTOR FUNCTION	Quasi-Peak
ENVIRONMENTAL CONDITIONS	24.0deg. C, 64.0%RH 999hPa	TEST MODE	C
TESTED BY	Match Tsui		

ANTENNA POLARITY & TEST DISTANCE: HORIZONTAL AT 3 M								
NO.	FREQ. (MHz)	EMISSION LEVEL (dBuV/m)	LIMIT (dBuV/m)	MARGIN (dB)	ANTENNA HEIGHT (m)	TABLE ANGLE (Degree)	RAW VALUE (dBuV)	CORRECTION FACTOR (dB/m)
1	94.06	34.79 QP	43.50	-8.71	1.75 H	64	25.53	9.26
2	103.78	37.27 QP	43.50	-6.23	1.75 H	67	27.48	9.79
3	250.01	42.85 QP	46.00	-3.15	1.00 H	105	30.02	12.83
4	374.04	38.85 QP	46.00	-7.15	1.00 H	112	23.42	15.43
5	397.37	36.41 QP	46.00	-9.59	1.75 H	124	20.42	16.00
6	467.36	37.73 QP	46.00	-8.27	1.75 H	112	19.48	18.25
7	500.42	36.29 QP	46.00	-9.71	1.75 H	337	17.04	19.25
8	640.41	42.55 QP	46.00	-3.45	1.25 H	1	20.31	22.24
9	731.79	40.29 QP	46.00	-5.71	1.00 H	115	16.79	23.50
10	865.94	38.28 QP	46.00	-7.72	1.50 H	139	12.49	25.78
11	897.05	42.60 QP	46.00	-3.40	1.75 H	124	16.52	26.08
ANTENNA POLARITY & TEST DISTANCE: VERTICAL AT 3 M								
NO.	FREQ. (MHz)	EMISSION LEVEL (dBuV/m)	LIMIT (dBuV/m)	MARGIN (dB)	ANTENNA HEIGHT (m)	TABLE ANGLE (Degree)	RAW VALUE (dBuV)	CORRECTION FACTOR (dB/m)
1	31.84	31.99 QP	40.00	-8.01	1.75 V	82	19.77	12.22
2	64.90	31.50 QP	40.00	-8.50	1.00 V	238	19.01	12.49
3	249.60	38.25 QP	46.00	-7.75	1.50 V	142	25.44	12.81
4	465.42	38.79 QP	46.00	-7.21	1.00 V	157	20.60	18.19
5	640.41	39.65 QP	46.00	-6.35	1.50 V	58	17.41	22.24
6	897.05	40.24 QP	46.00	-5.76	1.25 V	79	14.15	26.08

- REMARKS:**
1. Emission level (dBuV/m) = Raw Value (dBuV) + Correction Factor (dB/m).
 2. Correction Factor (dB/m) = Antenna Factor (dB/m) + Cable Factor (dB).
 3. The other emission levels were very low against the limit.
 4. Margin value = Emission level – Limit value.



4.2 CONDUCTED EMISSION MEASUREMENT

4.2.1 LIMITS OF CONDUCTED EMISSION MEASUREMENT

FREQUENCY OF EMISSION (MHz)	CONDUCTED LIMIT (dBµV)	
	Quasi-peak	Average
0.15 ~ 0.5	66 to 56	56 to 46
0.5 ~ 5	56	46
5 ~ 30	60	50

- NOTE:** 1. The lower limit shall apply at the transition frequencies.
2. The limit decreases in line with the logarithm of the frequency in the range of 0.15 to 0.50MHz.
3. All emanations from a class A/B digital device or system, including any network of conductors and apparatus connected thereto, shall not exceed the level of field strengths specified above.

4.2.2 TEST INSTRUMENTS

DESCRIPTION & MANUFACTURER	MODEL NO.	SERIAL NO.	DATE OF CALIBRATION	DUE DATE OF CALIBRATION
Test Receiver ROHDE & SCHWARZ	ESCS30	100291	Nov. 19, 2008	Nov. 18, 2009
RF signal cable Woken	5D-FB	Cable-HYC01-01	Dec. 31, 2008	Dec. 30, 2009
LISN SCHWARZBECK	NNBL 8226-2	8226-142	Jun. 03, 2009	Jun. 02, 2010
LISN ROHDE & SCHWARZ	ESH2-Z5	100104	Dec. 04, 2008	Dec. 03, 2009
Software ADT	ADT_Cond_ V7.3.7	NA	NA	NA

- NOTE:** 1. The calibration interval of the above test instruments is 12 months and the calibrations are traceable to NML/ROC and NIST/USA.
2. The test was performed in HwaYa Shielded Room 1.
3. The VCCI Site Registration No. is C-2040.



A D T

4.2.3 TEST PROCEDURES

- a. The EUT was placed 0.4 meters from the conducting wall of the shielded room with EUT being connected to the power mains through a line impedance stabilization network (LISN). Other support units were connected to the power mains through another LISN. The two LISNs provide 50 ohm/ 50uH of coupling impedance for the measuring instrument.
- b. Both lines of the power mains connected to the EUT were checked for maximum conducted interference.
- c. The frequency range from 150kHz to 30MHz was searched. Emission levels under (Limit - 20dB) was not recorded.

NOTE: All modes of operation were investigated and the worst-case emissions are reported.

4.2.4 DEVIATION FROM TEST STANDARD

No deviation.

4.2.5 TEST SETUP

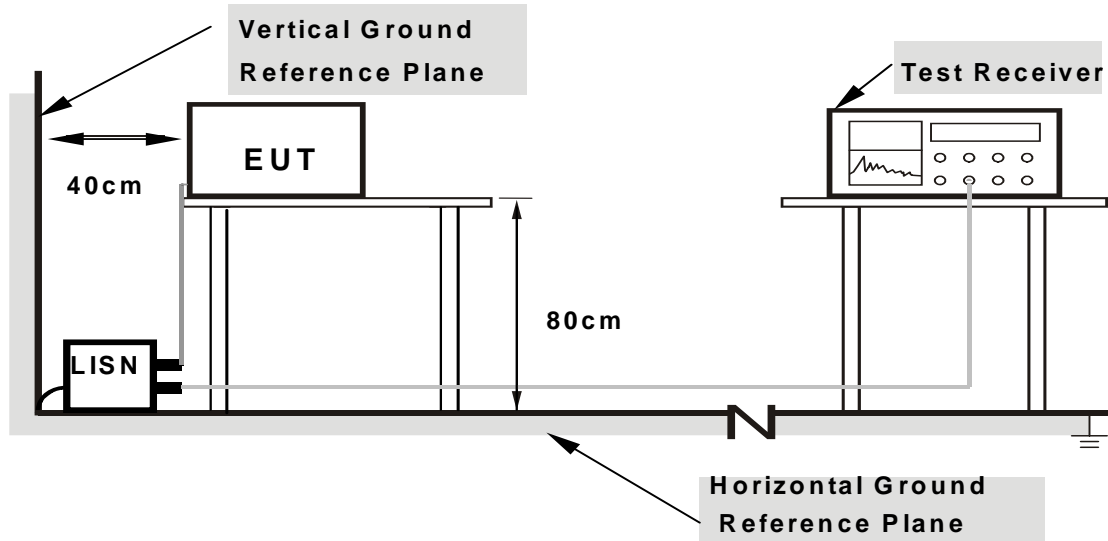

- Note:**
1. Support units were connected to second LISN.
 2. Both of LISNs (AMN) are 80 cm from EUT and at least 80 from other units and other metal planes

For the actual test configuration, please refer to the attached file (Test Setup Photo).

4.2.6 EUT OPERATING CONDITIONS

Same as 4.1.6.

4.2.7 TEST RESULTS

CONDUCTED WORST-CASE DATA : 802.11g OFDM MODULATION

EUT TEST CONDITION		MEASUREMENT DETAIL	
CHANNEL	Channel 6	PHASE	Line 1
MODULATION TYPE	BPSK	INPUT POWER	120Vac, 60Hz
TRANSFER RATE	6.0Mbps	6dB BANDWIDTH	9kHz
ENVIRONMENTAL CONDITIONS	25deg. C, 65%RH, 1011hPa	TEST MODE	A
TESTED BY	Mark Liao		

No	Freq. [MHz]	Corr. Factor [dB]	Reading Value [dB (uV)]		Emission Level [dB (uV)]		Limit [dB (uV)]		Margin [dB]	
			Q.P.	AV.	Q.P.	AV.	Q.P.	AV.	Q.P.	AV.
			1	0.162	0.13	51.64	-	51.77	-	65.38
2	0.177	0.13	49.03	-	49.16	-	64.61	54.61	-15.45	-
3	0.220	0.13	48.50	-	48.63	-	62.81	52.81	-14.18	-
4	2.082	0.24	26.73	-	26.97	-	56.00	46.00	-29.03	-
5	7.988	0.56	29.68	-	30.24	-	60.00	50.00	-29.76	-
6	26.609	1.23	33.01	-	34.24	-	60.00	50.00	-25.76	-

- REMARKS:**
1. Q.P. and AV. are abbreviations of quasi-peak and average individually.
 2. "-": The Quasi-peak reading value also meets average limit and measurement with the average detector is unnecessary.
 3. The emission levels of other frequencies were very low against the limit.
 4. Margin value = Emission level - Limit value
 5. Correction factor = Insertion loss + Cable loss
 6. Emission Level = Correction Factor + Reading Value.

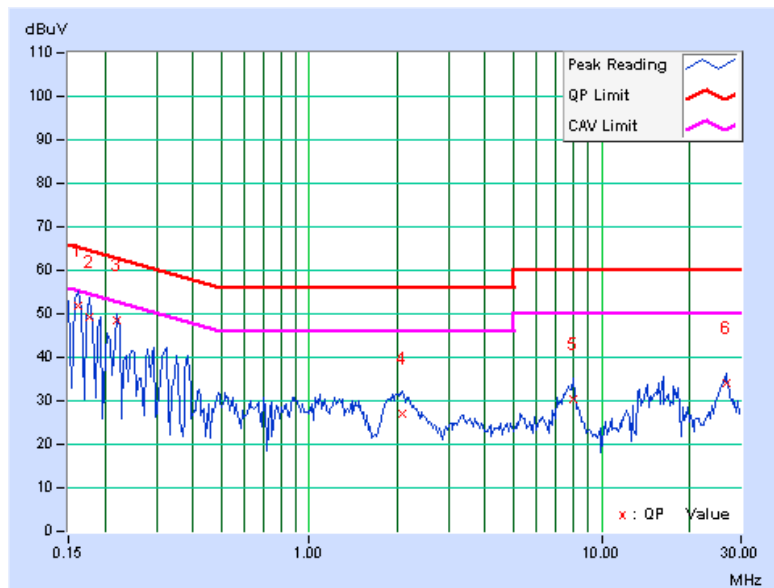

EUT TEST CONDITION		MEASUREMENT DETAIL	
CHANNEL	Channel 6	PHASE	Line 2
MODULATION TYPE	BPSK	INPUT POWER	120Vac, 60Hz
TRANSFER RATE	6.0Mbps	6dB BANDWIDTH	9kHz
ENVIRONMENTAL CONDITIONS	25deg. C, 65%RH, 1011hPa	TEST MODE	A
TESTED BY	Mark Liao		

No	Freq. [MHz]	Corr. Factor (dB)	Reading Value [dB (uV)]		Emission Level [dB (uV)]		Limit [dB (uV)]		Margin (dB)	
			Q.P.	AV.	Q.P.	AV.	Q.P.	AV.	Q.P.	AV.
1	0.158	0.14	49.85	-	49.99	-	65.58	55.58	-15.59	-
2	0.173	0.14	47.87	-	48.01	-	64.79	54.79	-16.78	-
3	0.267	0.15	32.42	-	32.57	-	61.20	51.20	-28.63	-
4	1.160	0.21	27.96	-	28.17	-	56.00	46.00	-27.83	-
5	7.895	0.57	25.79	-	26.36	-	60.00	50.00	-33.64	-
6	16.230	0.86	30.38	-	31.24	-	60.00	50.00	-28.76	-

- REMARKS:**
1. Q.P. and AV. are abbreviations of quasi-peak and average individually.
 2. "-": The Quasi-peak reading value also meets average limit and measurement with the average detector is unnecessary.
 3. The emission levels of other frequencies were very low against the limit.
 4. Margin value = Emission level - Limit value
 5. Correction factor = Insertion loss + Cable loss
 6. Emission Level = Correction Factor + Reading Value.

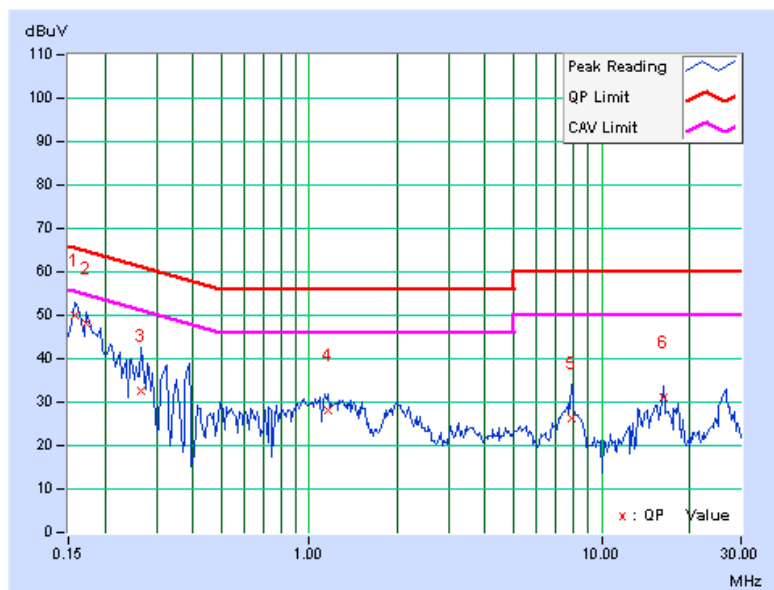



A D T

EUT TEST CONDITION		MEASUREMENT DETAIL	
CHANNEL	Channel 6	PHASE	Line 1
MODULATION TYPE	BPSK	INPUT POWER	120Vac, 60Hz
TRANSFER RATE	6.0Mbps	6dB BANDWIDTH	9kHz
ENVIRONMENTAL CONDITIONS	25deg. C, 65%RH, 1011hPa	TEST MODE	B
TESTED BY	Mark Liao		

No	Freq. [MHz]	Corr. Factor (dB)	Reading Value [dB (uV)]		Emission Level [dB (uV)]		Limit [dB (uV)]		Margin (dB)	
			Q.P.	AV.	Q.P.	AV.	Q.P.	AV.	Q.P.	AV.
1	0.466	0.14	46.74	42.08	46.88	42.22	56.58	46.58	-9.69	-4.35
2	0.580	0.15	44.02	-	44.17	-	56.00	46.00	-11.83	-
3	0.755	0.16	44.99	-	45.15	-	56.00	46.00	-10.85	-
4	1.047	0.18	45.14	-	45.32	-	56.00	46.00	-10.68	-
5	1.221	0.19	44.07	-	44.26	-	56.00	46.00	-11.74	-
6	3.488	0.33	46.48	41.58	46.81	41.91	56.00	46.00	-9.19	-4.09

- REMARKS:**
1. Q.P. and AV. are abbreviations of quasi-peak and average individually.
 2. "-": The Quasi-peak reading value also meets average limit and measurement with the average detector is unnecessary.
 3. The emission levels of other frequencies were very low against the limit.
 4. Margin value = Emission level - Limit value
 5. Correction factor = Insertion loss + Cable loss
 6. Emission Level = Correction Factor + Reading Value.

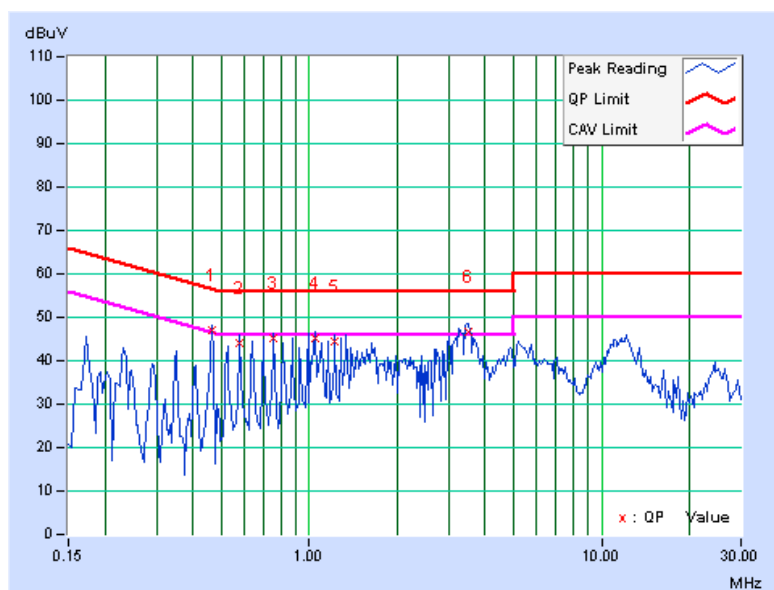



A D T

EUT TEST CONDITION		MEASUREMENT DETAIL	
CHANNEL	Channel 6	PHASE	Line 2
MODULATION TYPE	BPSK	INPUT POWER	120Vac, 60Hz
TRANSFER RATE	6.0Mbps	6dB BANDWIDTH	9kHz
ENVIRONMENTAL CONDITIONS	25deg. C, 65%RH, 1011hPa	TEST MODE	B
TESTED BY	Mark Liao		

No	Freq. [MHz]	Corr. Factor (dB)	Reading Value [dB (uV)]		Emission Level [dB (uV)]		Limit [dB (uV)]		Margin (dB)	
			Q.P.	AV.	Q.P.	AV.	Q.P.	AV.	Q.P.	AV.
1	0.464	0.16	38.86	-	39.02	-	56.62	46.62	-17.60	-
2	0.581	0.17	39.90	-	40.07	-	56.00	46.00	-15.93	-
3	0.814	0.19	40.43	-	40.62	-	56.00	46.00	-15.38	-
4	1.223	0.21	40.03	-	40.24	-	56.00	46.00	-15.76	-
5	3.375	0.35	42.10	-	42.45	-	56.00	46.00	-13.55	-
6	5.234	0.45	36.43	-	36.88	-	60.00	50.00	-23.12	-

- REMARKS:**
1. Q.P. and AV. are abbreviations of quasi-peak and average individually.
 2. "-": The Quasi-peak reading value also meets average limit and measurement with the average detector is unnecessary.
 3. The emission levels of other frequencies were very low against the limit.
 4. Margin value = Emission level - Limit value
 5. Correction factor = Insertion loss + Cable loss
 6. Emission Level = Correction Factor + Reading Value.

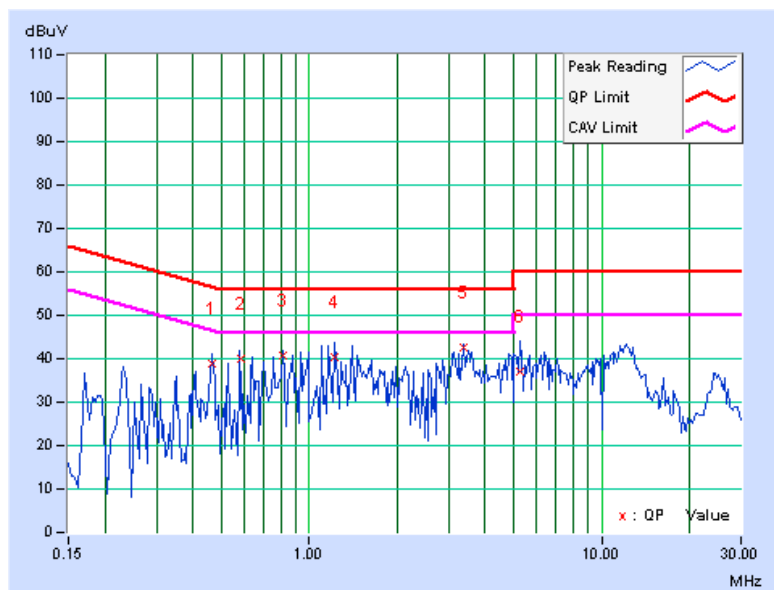



A D T

EUT TEST CONDITION		MEASUREMENT DETAIL	
CHANNEL	Channel 6	PHASE	Line 1
MODULATION TYPE	BPSK	INPUT POWER	120Vac, 60Hz
TRANSFER RATE	6.0Mbps	6dB BANDWIDTH	9kHz
ENVIRONMENTAL CONDITIONS	25deg. C, 65%RH, 1011hPa	TEST MODE	C
TESTED BY	Mark Liao		

No	Freq. [MHz]	Corr. Factor (dB)	Reading Value [dB (uV)]		Emission Level [dB (uV)]		Limit [dB (uV)]		Margin (dB)	
			Q.P.	AV.	Q.P.	AV.	Q.P.	AV.	Q.P.	AV.
1	0.173	0.13	49.67	-	49.80	-	64.79	54.79	-14.99	-
2	0.232	0.13	42.13	-	42.26	-	62.39	52.39	-20.13	-
3	0.289	0.13	38.09	-	38.22	-	60.54	50.54	-22.32	-
4	2.024	0.23	39.57	-	39.80	-	56.00	46.00	-16.20	-
5	3.701	0.35	42.98	-	43.33	-	56.00	46.00	-12.67	-
6	10.631	0.69	35.44	-	36.13	-	60.00	50.00	-23.87	-

- REMARKS:**
1. Q.P. and AV. are abbreviations of quasi-peak and average individually.
 2. "-": The Quasi-peak reading value also meets average limit and measurement with the average detector is unnecessary.
 3. The emission levels of other frequencies were very low against the limit.
 4. Margin value = Emission level - Limit value
 5. Correction factor = Insertion loss + Cable loss
 6. Emission Level = Correction Factor + Reading Value.

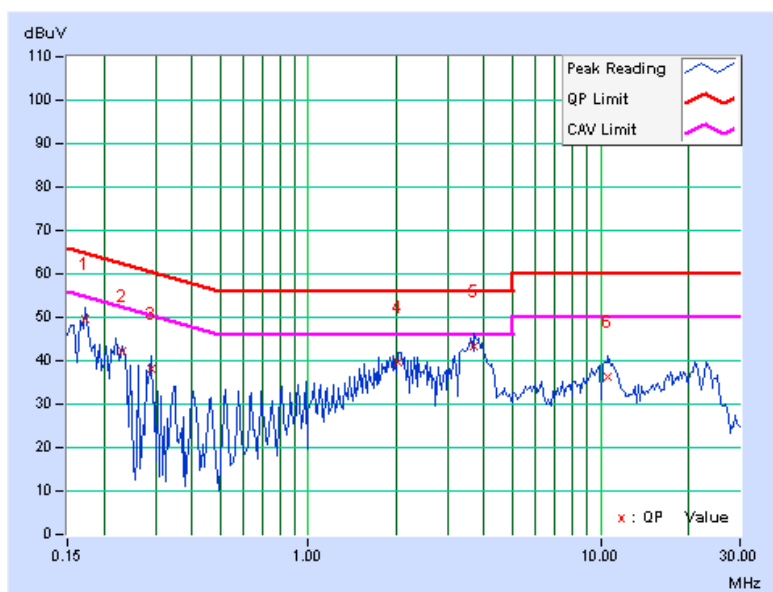



A D T

EUT TEST CONDITION		MEASUREMENT DETAIL	
CHANNEL	Channel 6	PHASE	Line 2
MODULATION TYPE	BPSK	INPUT POWER	120Vac, 60Hz
TRANSFER RATE	6.0Mbps	6dB BANDWIDTH	9kHz
ENVIRONMENTAL CONDITIONS	25deg. C, 65%RH, 1011hPa	TEST MODE	C
TESTED BY	Mark Liao		

No	Freq. [MHz]	Corr. Factor (dB)	Reading Value [dB (uV)]		Emission Level [dB (uV)]		Limit [dB (uV)]		Margin (dB)	
			Q.P.	AV.	Q.P.	AV.	Q.P.	AV.	Q.P.	AV.
1	0.174	0.14	50.10	-	50.24	-	64.79	54.79	-14.55	-
2	0.231	0.15	41.08	-	41.23	-	62.42	52.42	-21.19	-
3	0.289	0.15	37.33	-	37.48	-	60.56	50.56	-23.07	-
4	2.137	0.26	39.11	-	39.37	-	56.00	46.00	-16.63	-
5	3.694	0.37	42.78	-	43.15	-	56.00	46.00	-12.85	-
6	10.735	0.68	36.39	-	37.07	-	60.00	50.00	-22.93	-

- REMARKS:**
1. Q.P. and AV. are abbreviations of quasi-peak and average individually.
 2. "-": The Quasi-peak reading value also meets average limit and measurement with the average detector is unnecessary.
 3. The emission levels of other frequencies were very low against the limit.
 4. Margin value = Emission level - Limit value
 5. Correction factor = Insertion loss + Cable loss
 6. Emission Level = Correction Factor + Reading Value.

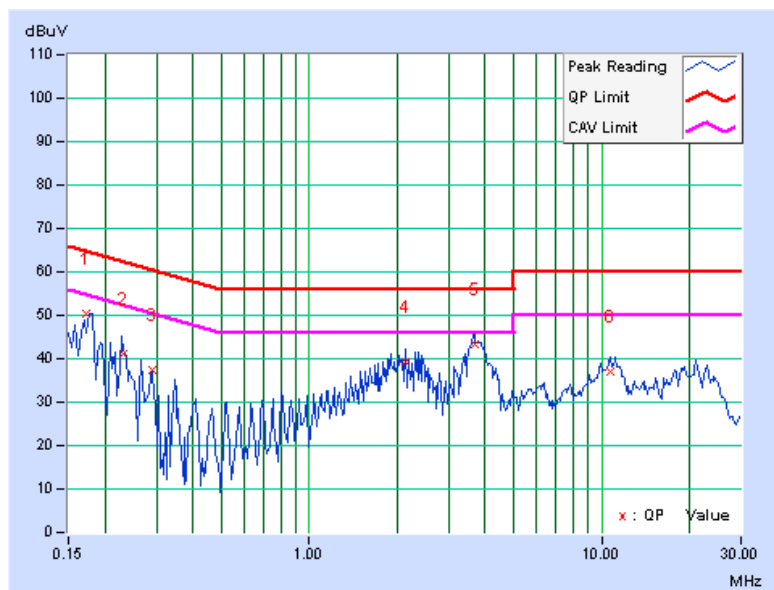

4.3 6dB BANDWIDTH MEASUREMENT

4.3.1 LIMITS OF 6dB BANDWIDTH MEASUREMENT

The minimum of 6dB Bandwidth Measurement is 0.5 MHz.

4.3.2 TEST INSTRUMENTS

DESCRIPTION & MANUFACTURER	MODEL NO.	SERIAL NO.	DATE OF CALIBRATION	DUE DATE OF CALIBRATION
R&S SPECTRUM ANALYZER	FSP40	100040	Jul. 04, 2008	Jul. 03, 2009

NOTE: The calibration interval of the above test instruments is 12 months and the calibrations are traceable to NML/ROC and NIST/USA.

4.3.3 TEST PROCEDURE

The transmitter output was connected to the spectrum analyzer through an attenuator. The bandwidth of the fundamental frequency was measured by spectrum analyzer with 100kHz RBW and 300kHz VBW. The 6dB bandwidth is defined as the total spectrum the power of which is higher than peak power minus 6dB.

4.3.4 DEVIATION FROM TEST STANDARD

No deviation.

4.3.5 TEST SETUP

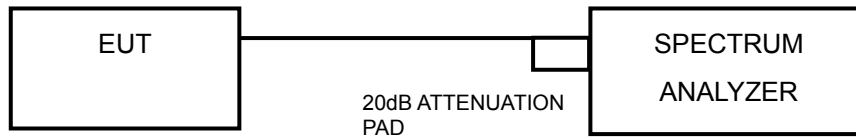

4.3.6 EUT OPERATING CONDITIONS

The software provided by client to enable the EUT under transmission condition continuously at lowest, middle and highest channel frequencies individually.



A D T

4.3.7 TEST RESULTS

802.11b DSSS MODULATION

MODULATION TYPE	DBPSK	TRANSFER RATE	1.0Mbps
INPUT POWER	120Vac, 60Hz	ENVIRONMENTAL CONDITIONS	25 deg.C, 65%RH, 1009hPa
TESTED BY	Match Tsui		

CHANNEL	CHANNEL FREQUENCY (MHz)	6dB BANDWIDTH (MHz)		MINIMUM LIMIT (MHz)	PASS / FAIL
		CHAIN 0	CHAIN 1		
1	2412	11.14	11.17	0.5	PASS
6	2437	12.14	12.16	0.5	PASS
11	2462	12.14	11.18	0.5	PASS



A D T

FOR CHAIN 0: CH 1

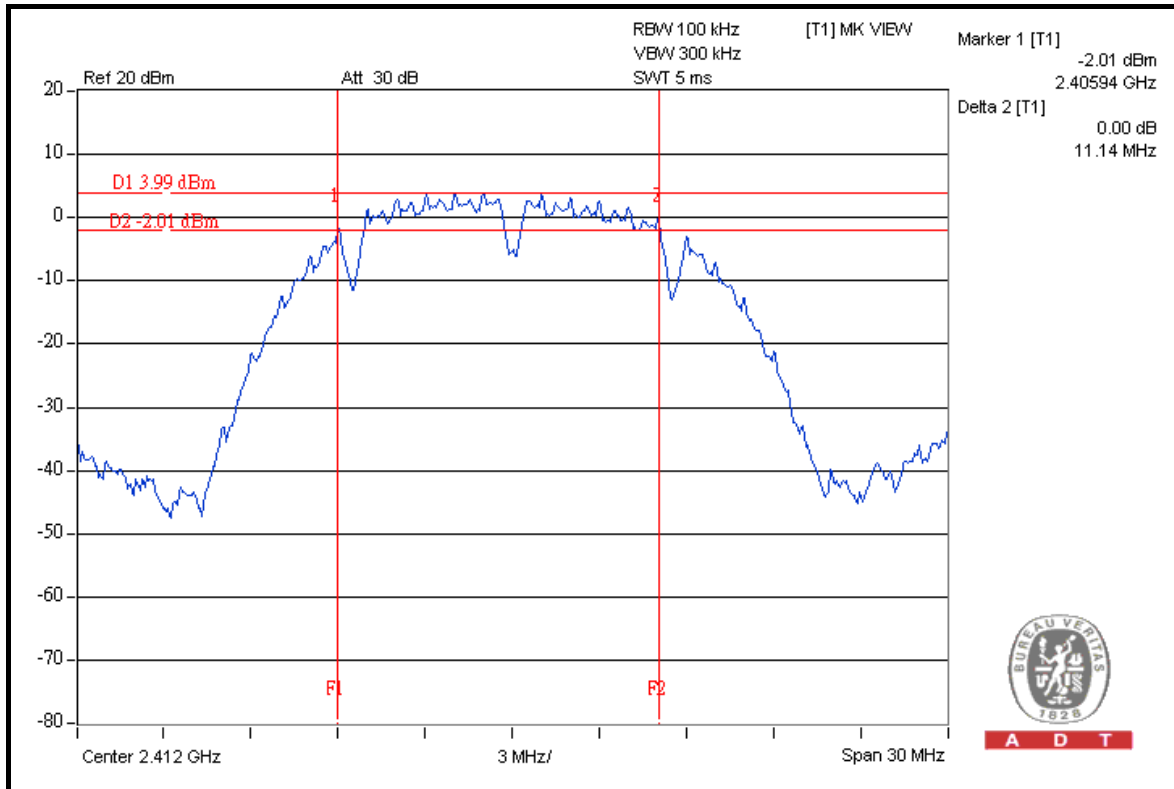

CH 6

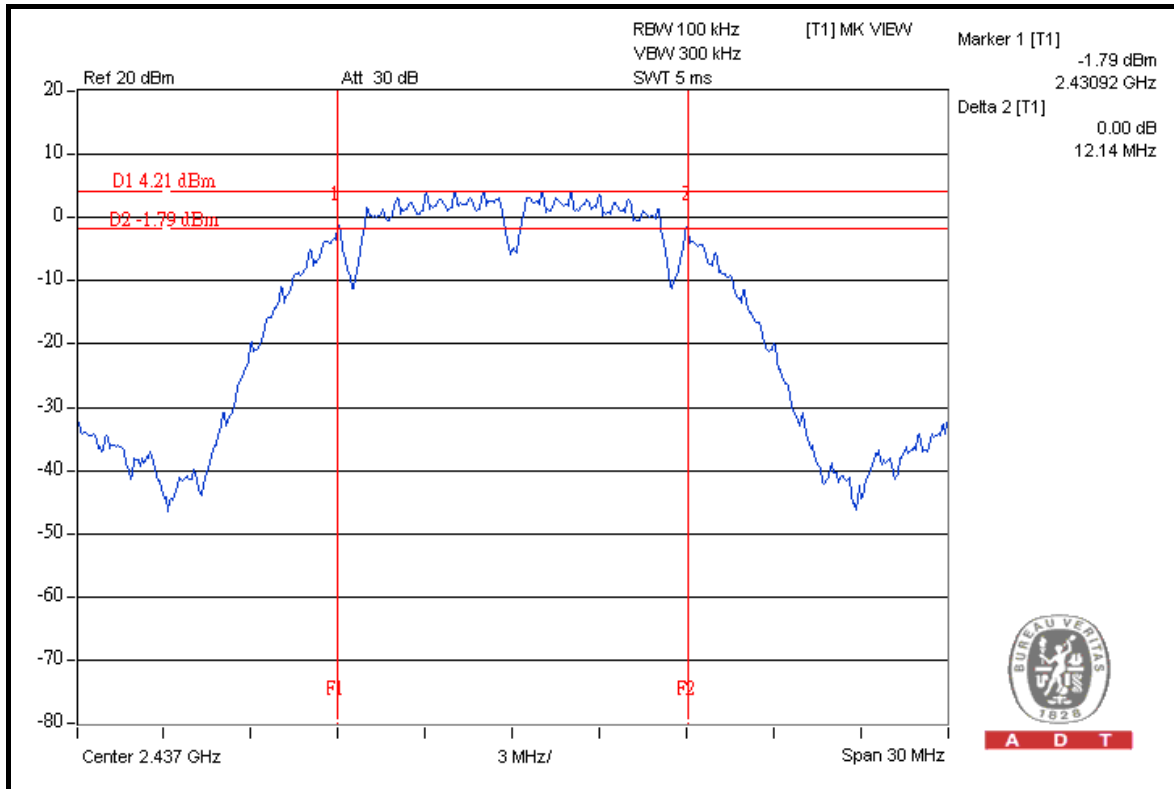



A D T

CH 11

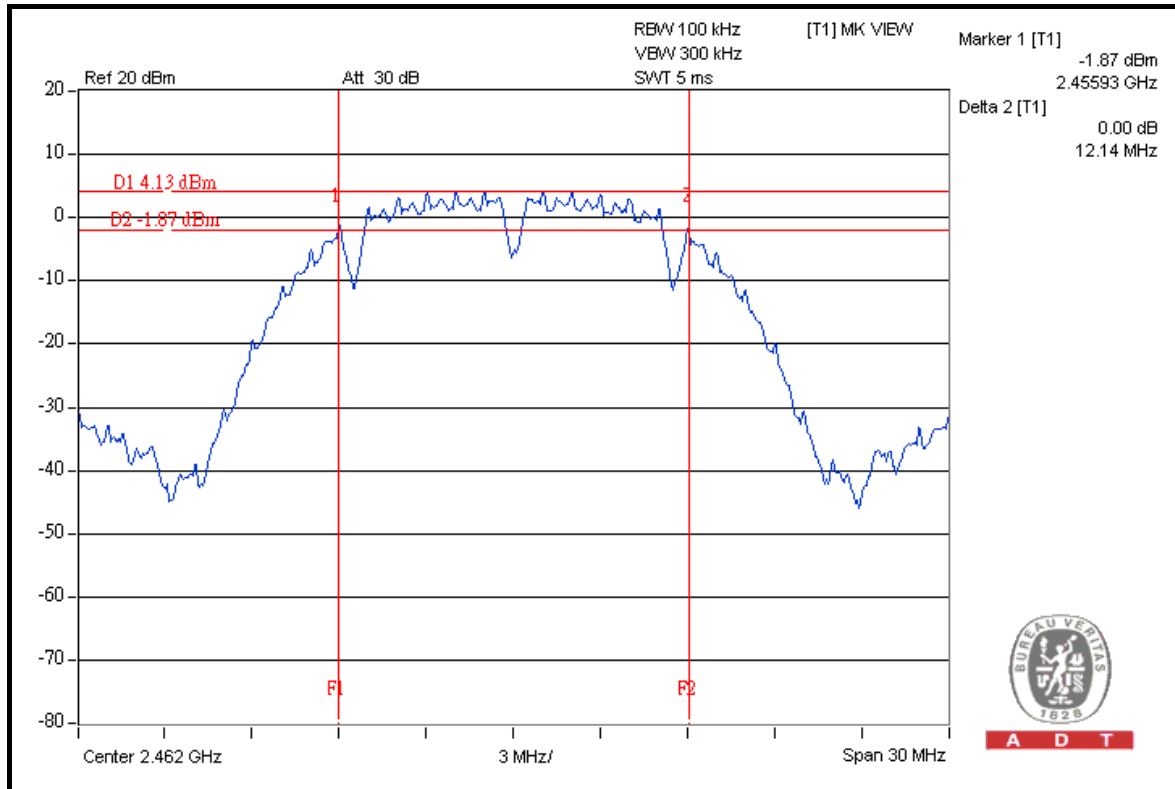

FOR CHAIN 1: CH 1

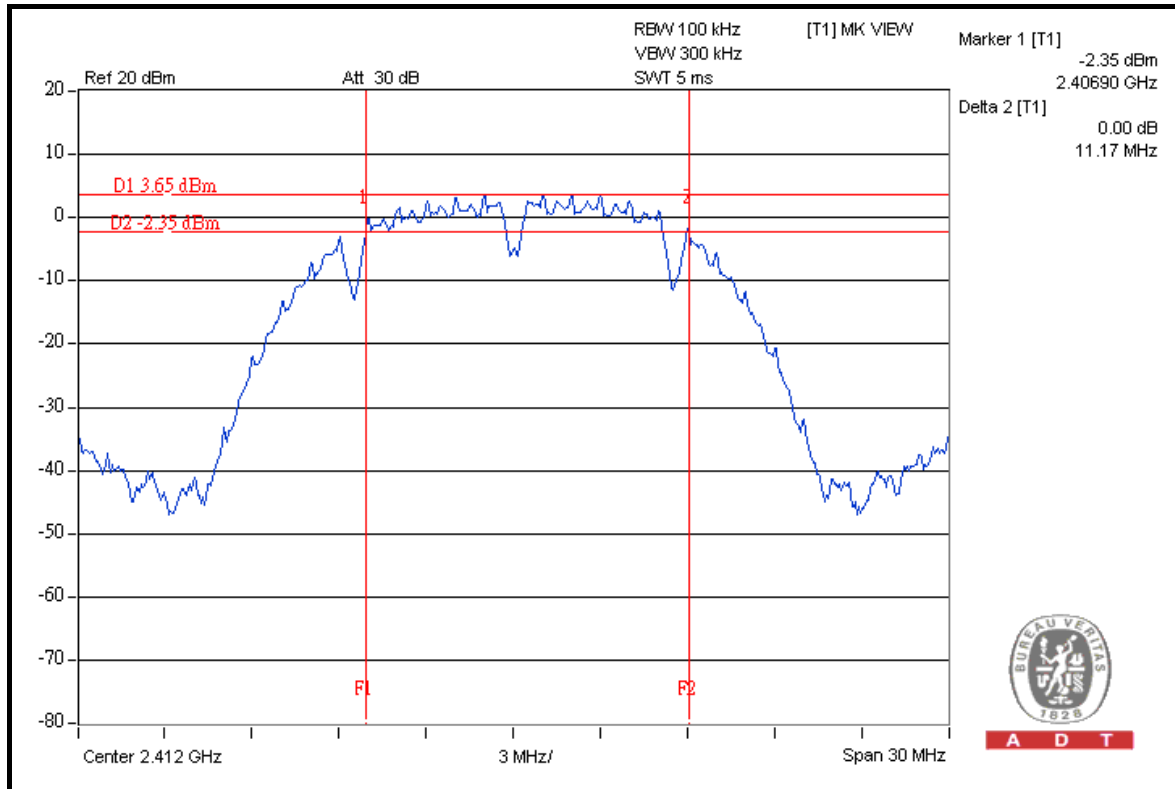



A D T

CH 6

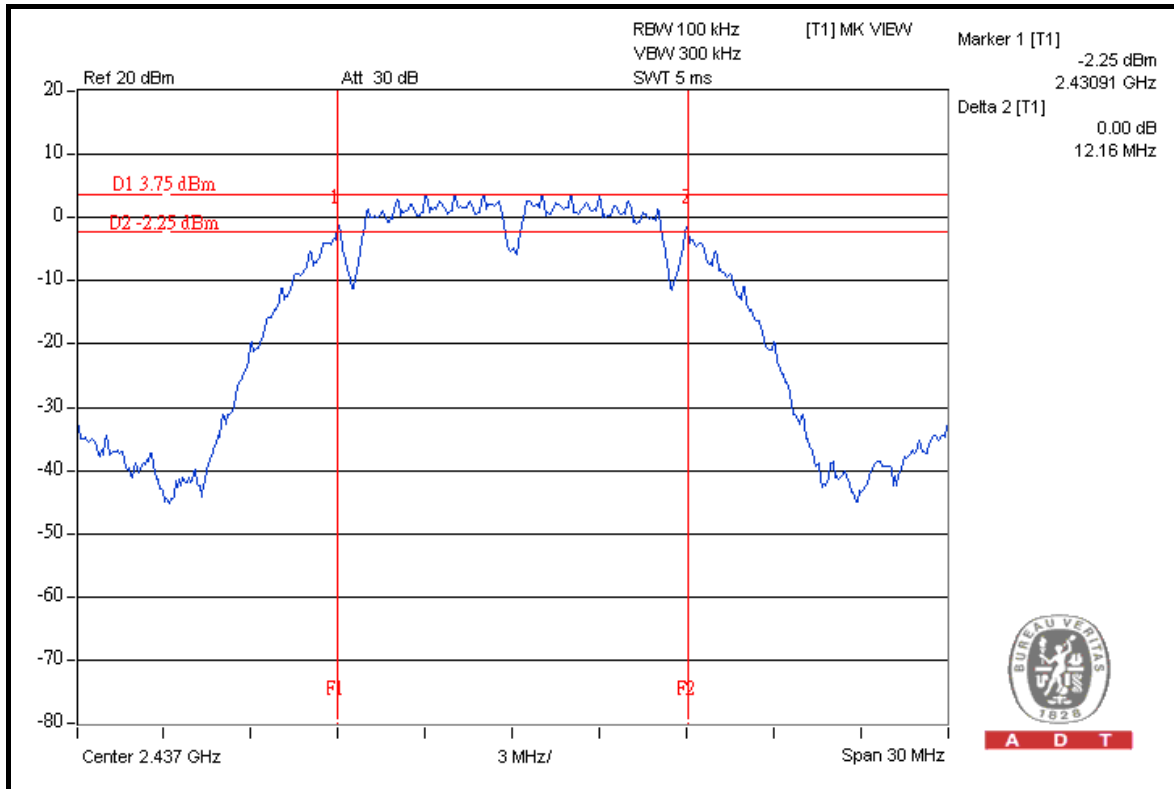

CH 11

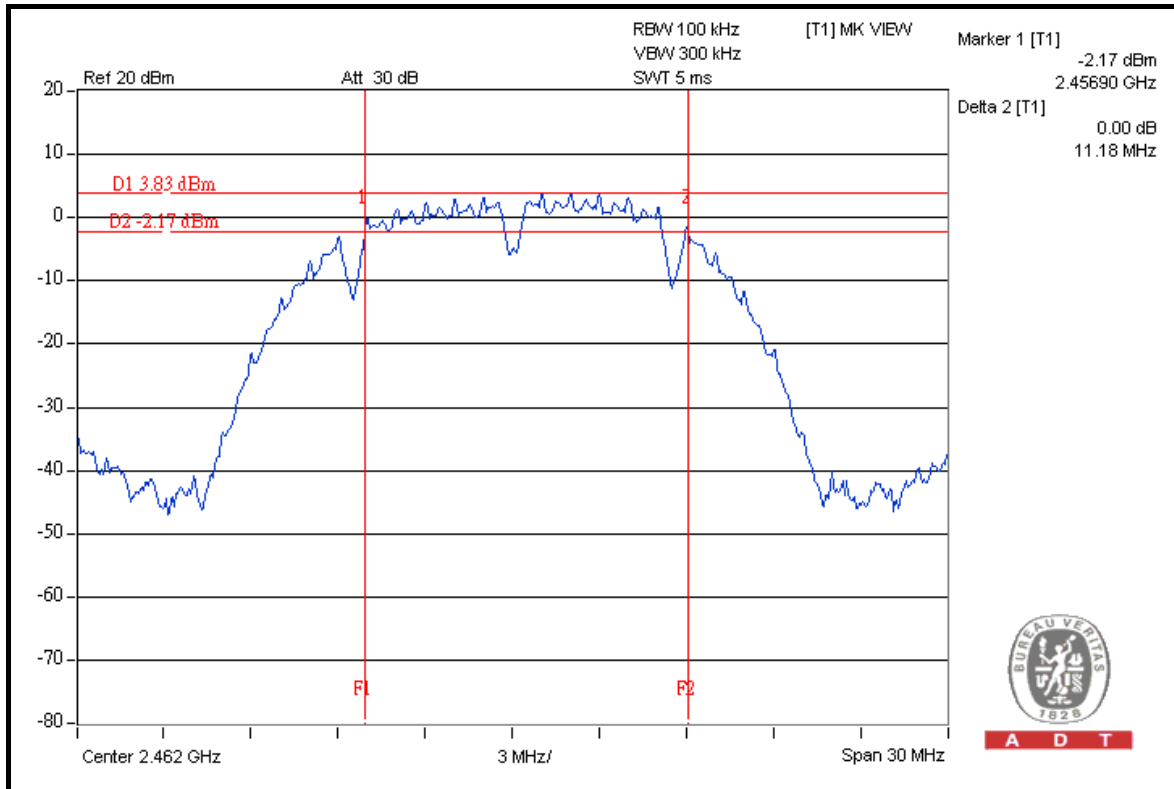



A D T

802.11g OFDM MODULATION

MODULATION TYPE	BPSK	TRANSFER RATE	6.0Mbps
INPUT POWER	120Vac, 60Hz	ENVIRONMENTAL CONDITIONS	25 deg.C, 65%RH, 1009hPa
TESTED BY	Match Tsui		

CHANNEL	CHANNEL FREQUENCY (MHz)	6dB BANDWIDTH (MHz)		MINIMUM LIMIT (MHz)	PASS / FAIL
		CHAIN 0	CHAIN 1		
1	2412	16.49	16.45	0.5	PASS
6	2437	16.53	16.49	0.5	PASS
11	2462	16.43	16.44	0.5	PASS



A D T

FOR CHAIN 0: CH 1

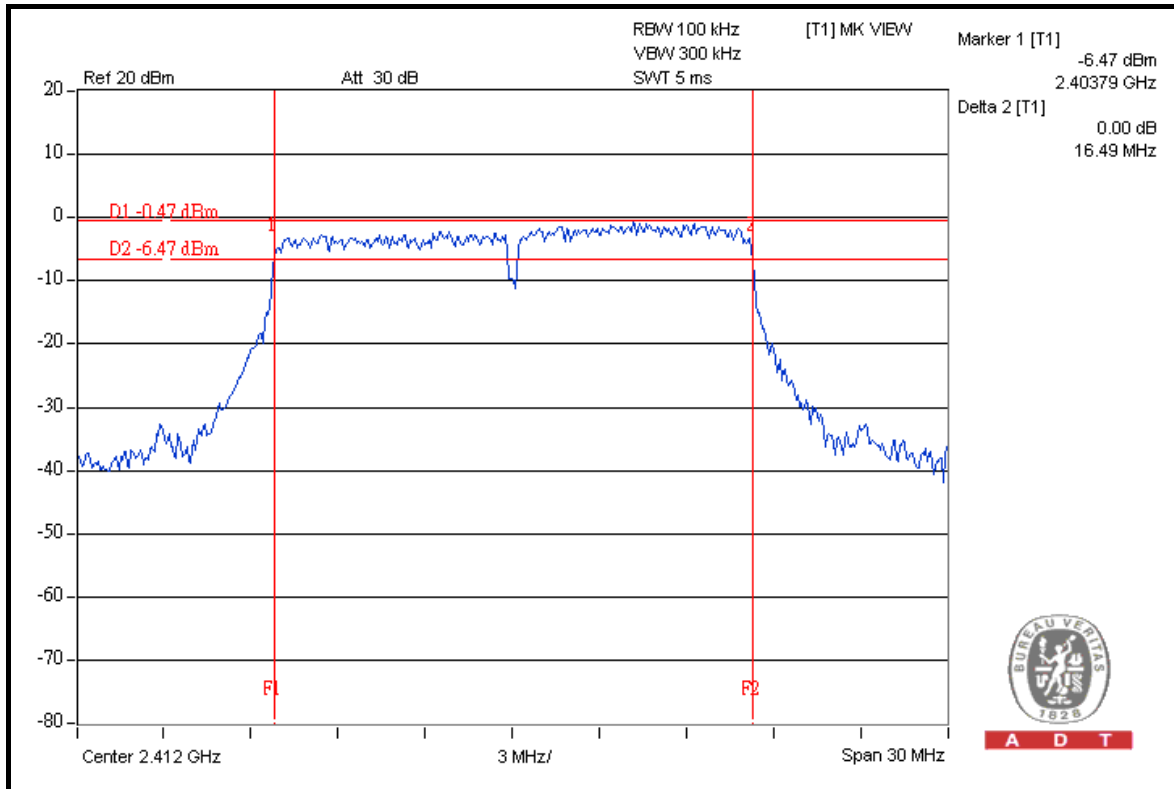

CH 6

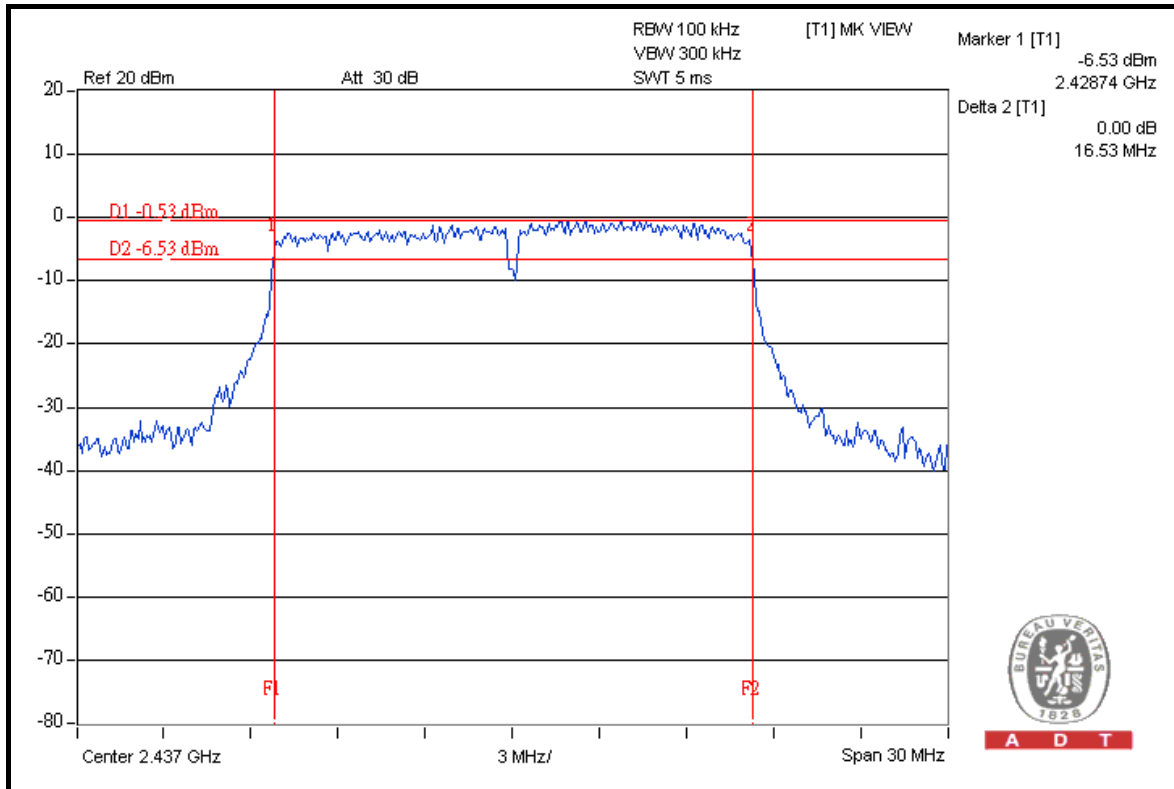



A D T

CH 11

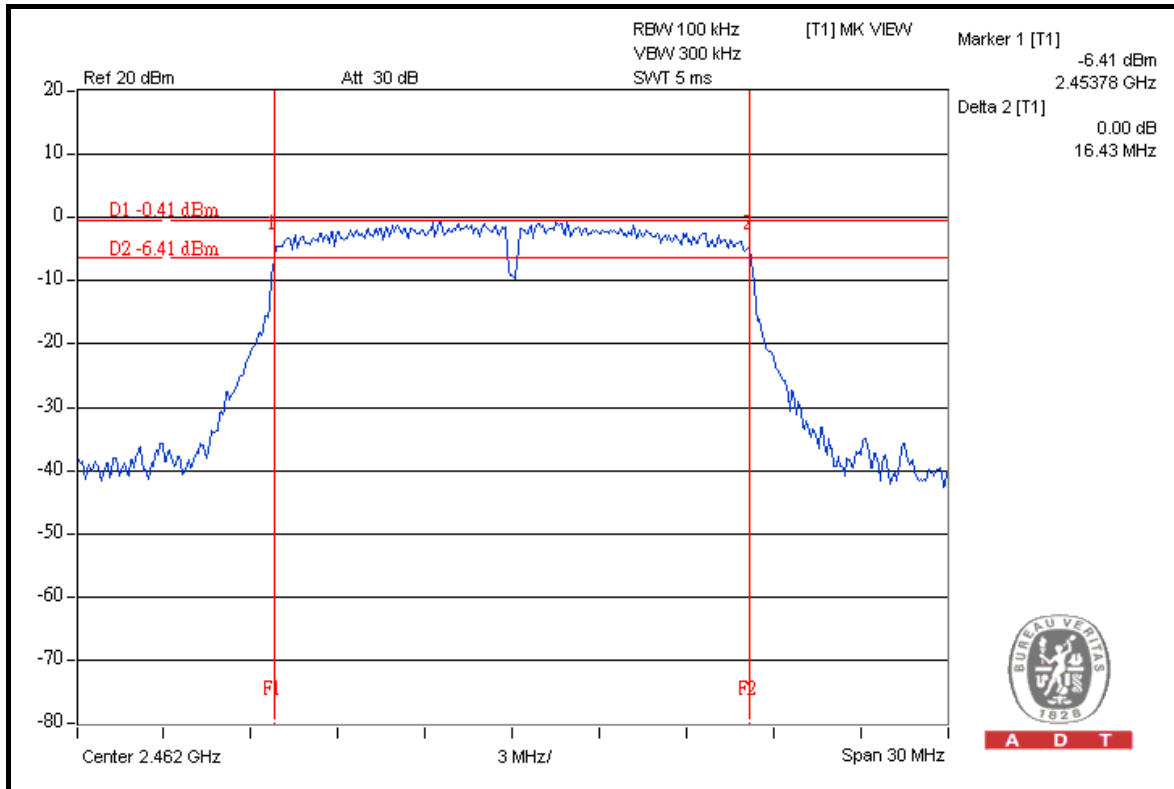

FOR CHAIN 1: CH 1

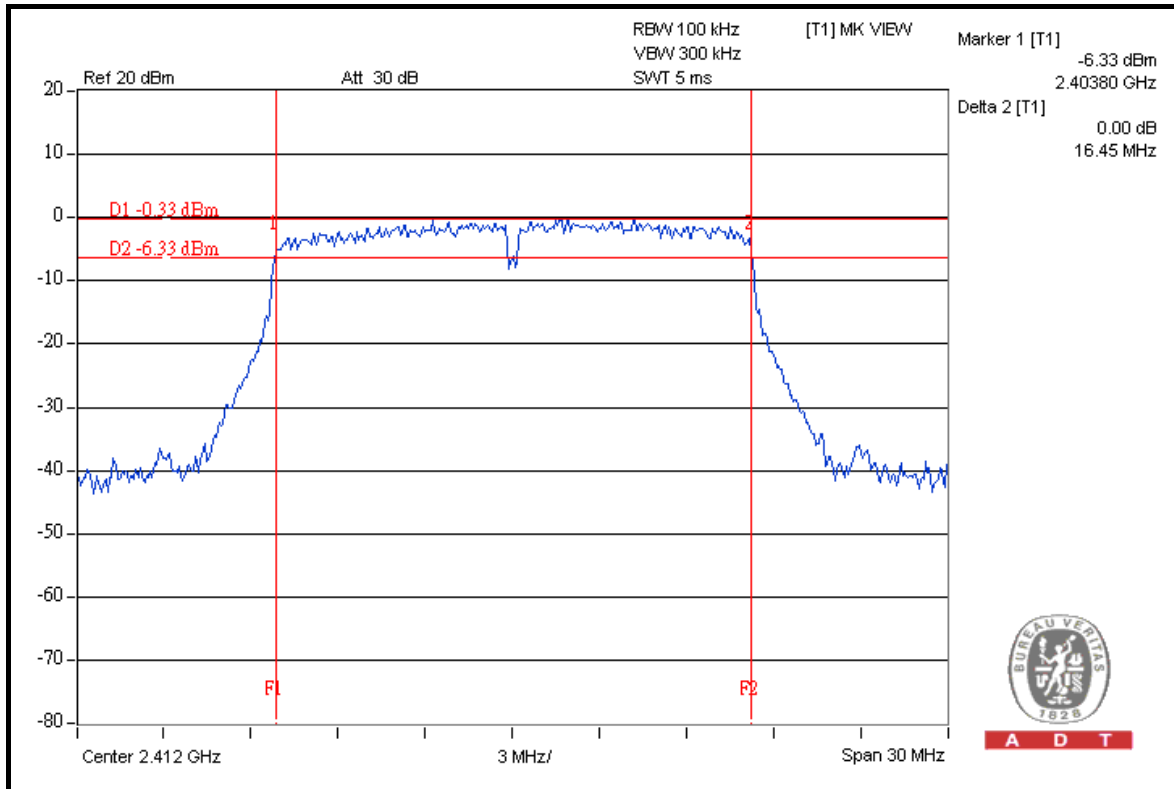



A D T

CH 6

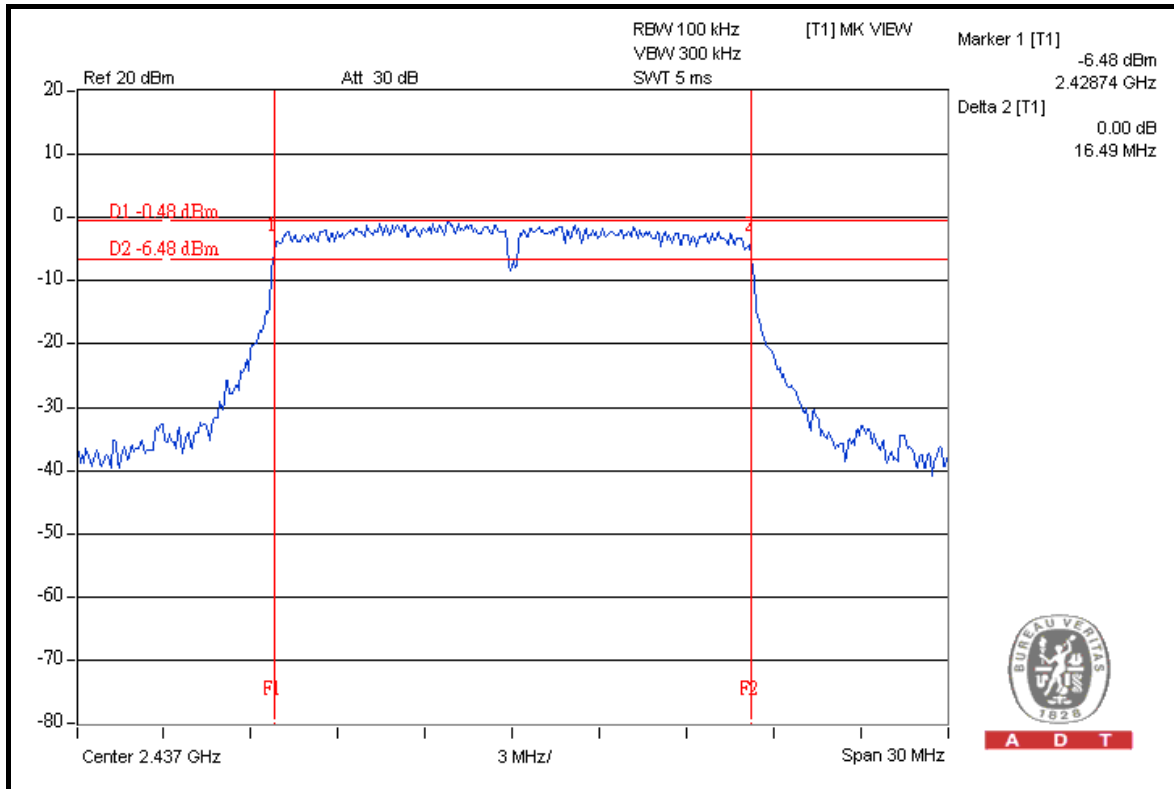

CH 11

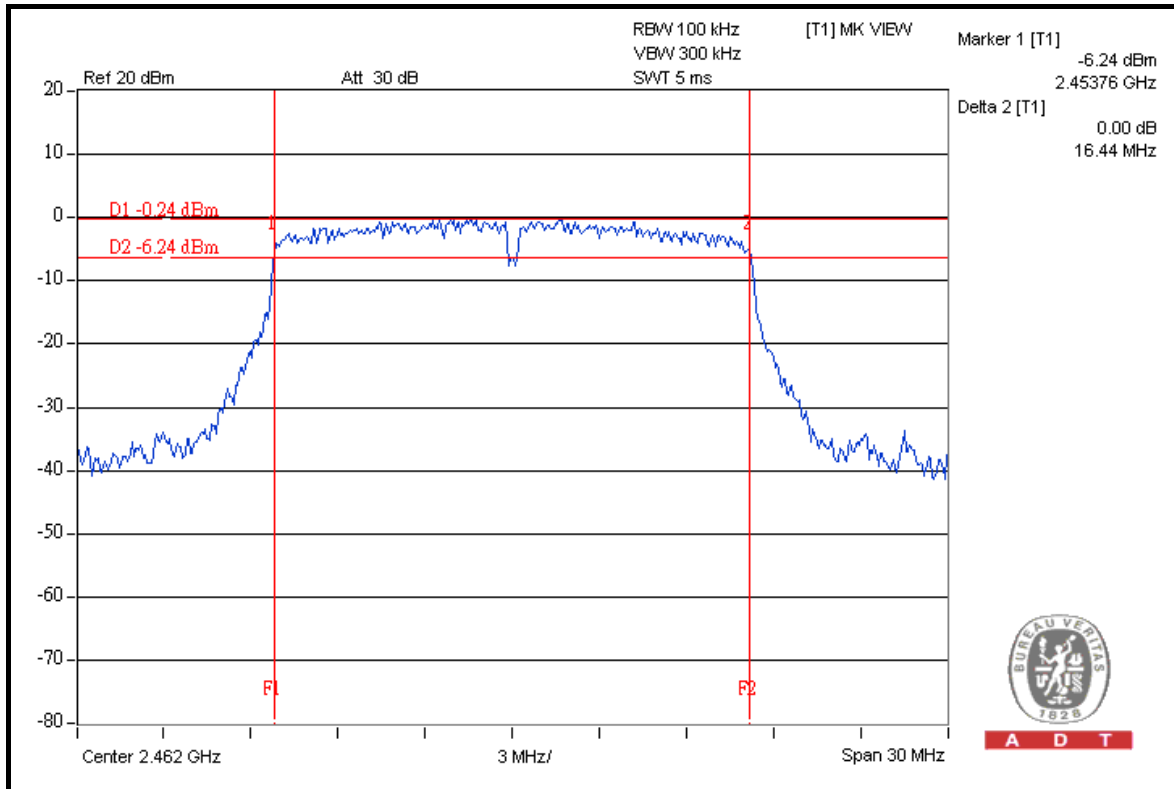



A D T

DRAFT 802.11n (20MHz) OFDM MODULATION

MODULATION TYPE	BPSK	TRANSFER RATE	7.2Mbps
INPUT POWER	120Vac, 60Hz	ENVIRONMENTAL CONDITIONS	25 deg.C, 65%RH, 1009hPa
TESTED BY	Match Tsui		

CHANNEL	CHANNEL FREQUENCY (MHz)	6dB BANDWIDTH (MHz)		MINIMUM LIMIT (MHz)	PASS / FAIL
		CHAIN 0	CHAIN 1		
1	2412	17.01	17.43	0.5	PASS
6	2437	17.07	17.63	0.5	PASS
11	2462	17.24	17.67	0.5	PASS



A D T

FOR CHAIN 0: CH 1

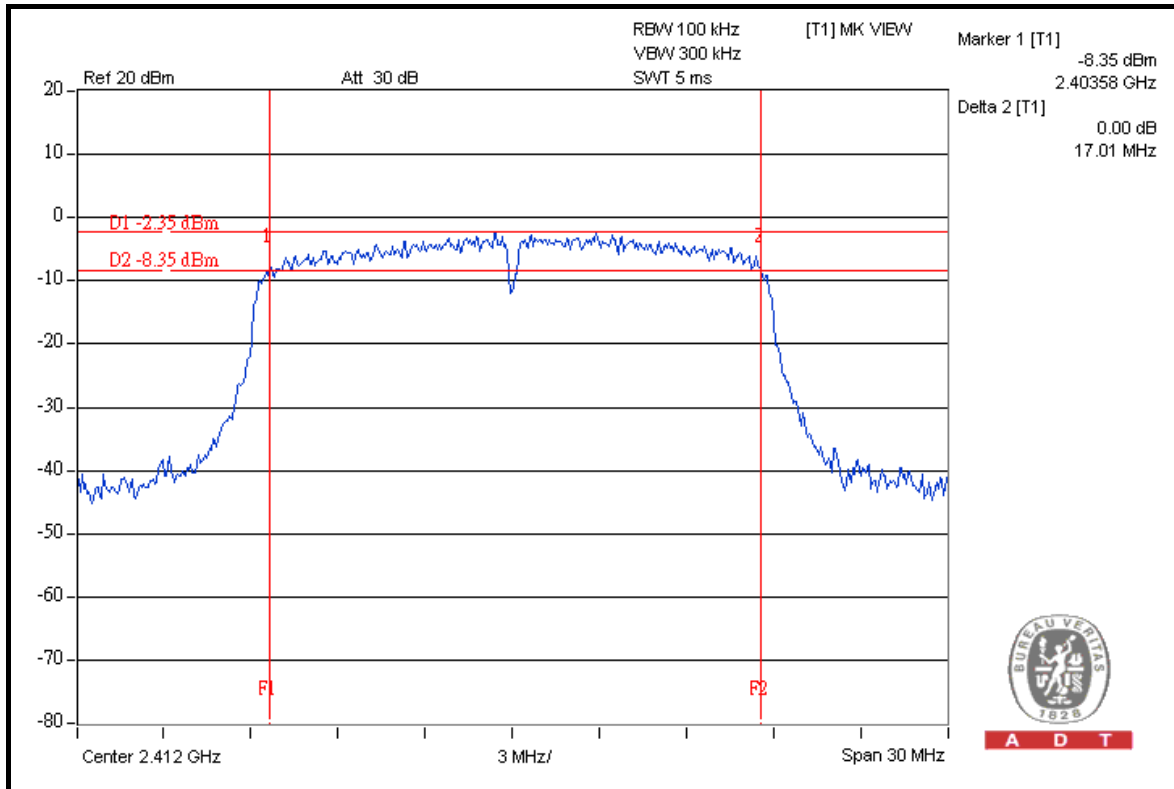

CH 6

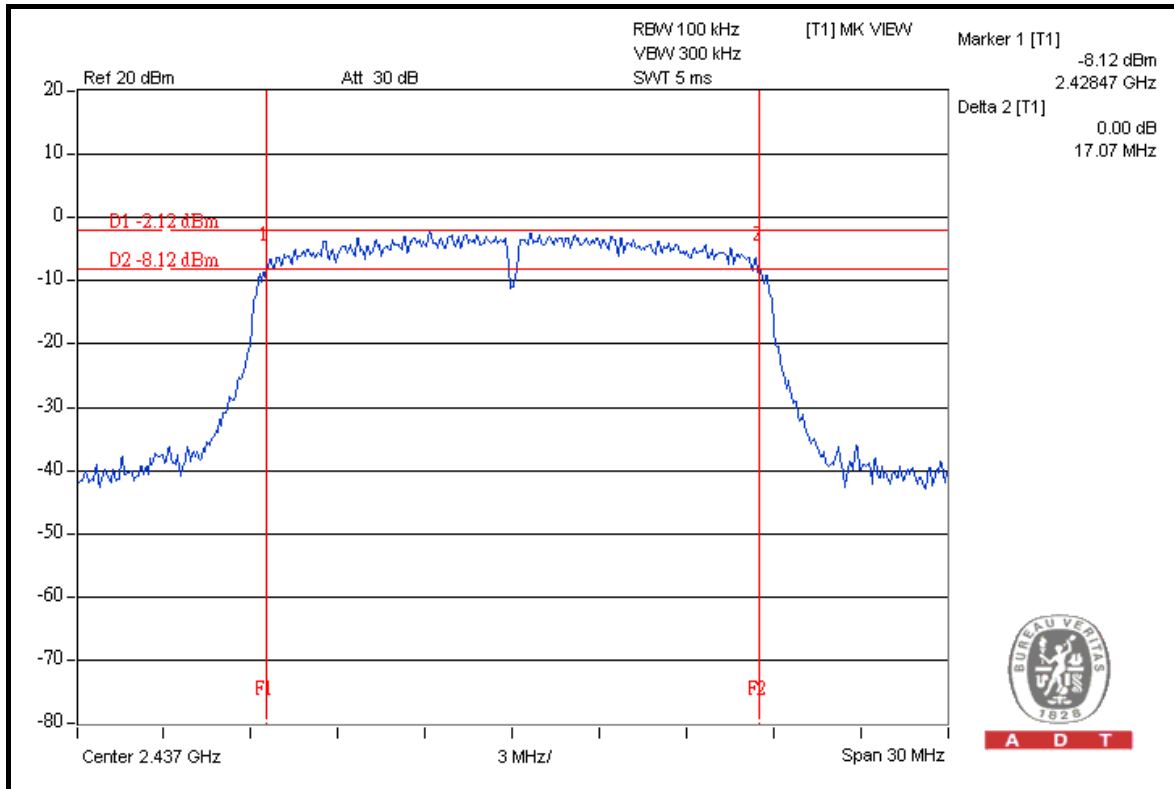



A D T

CH 11

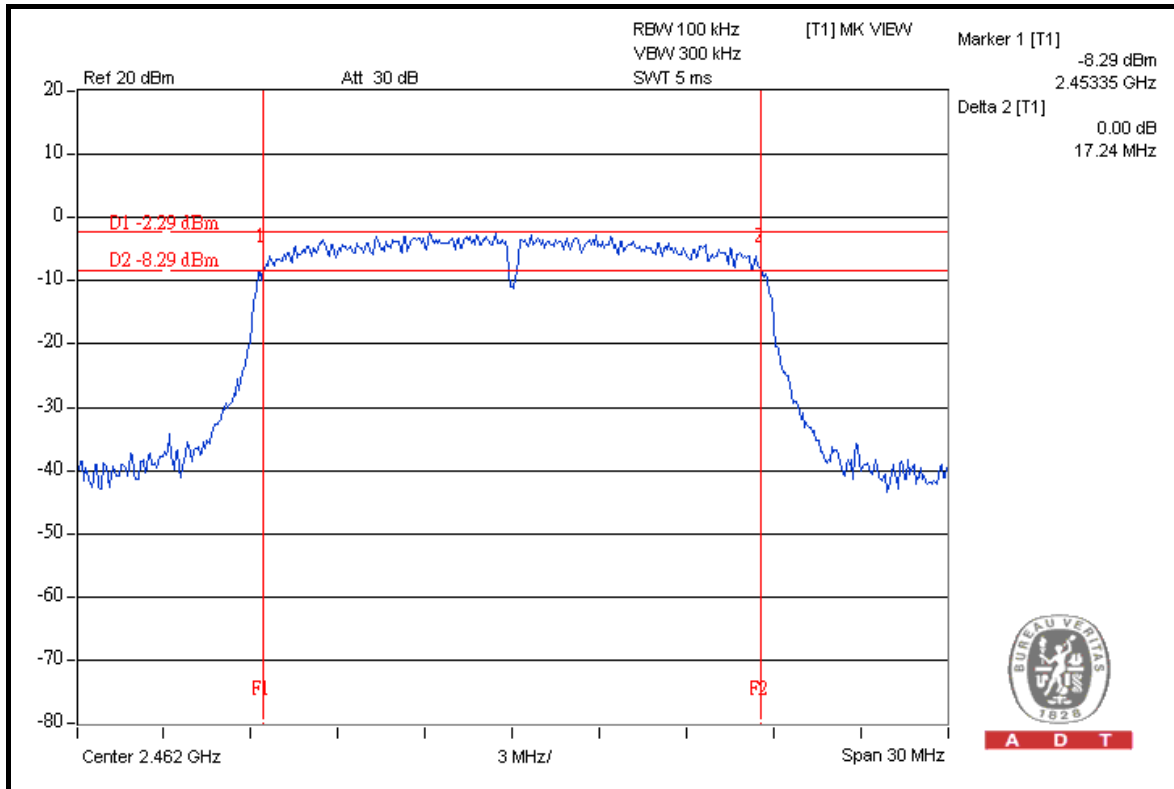

FOR CHAIN 1: CH 1

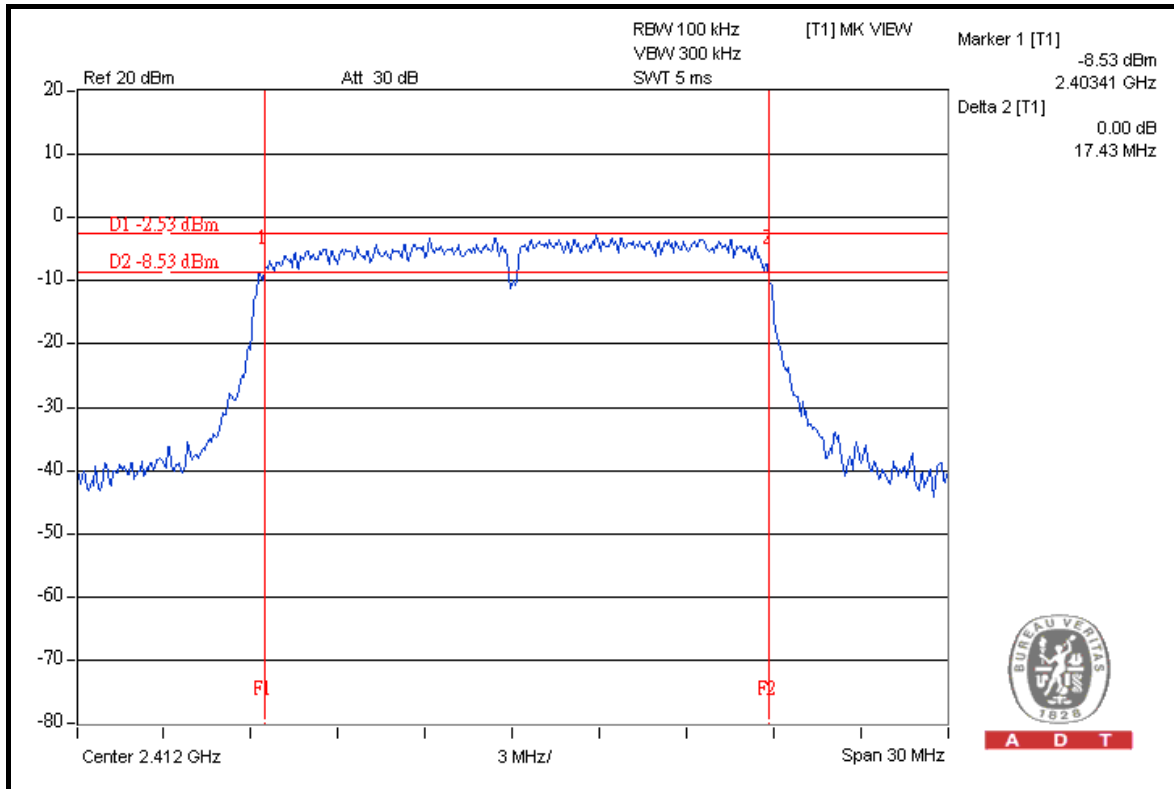



A D T

CH 6

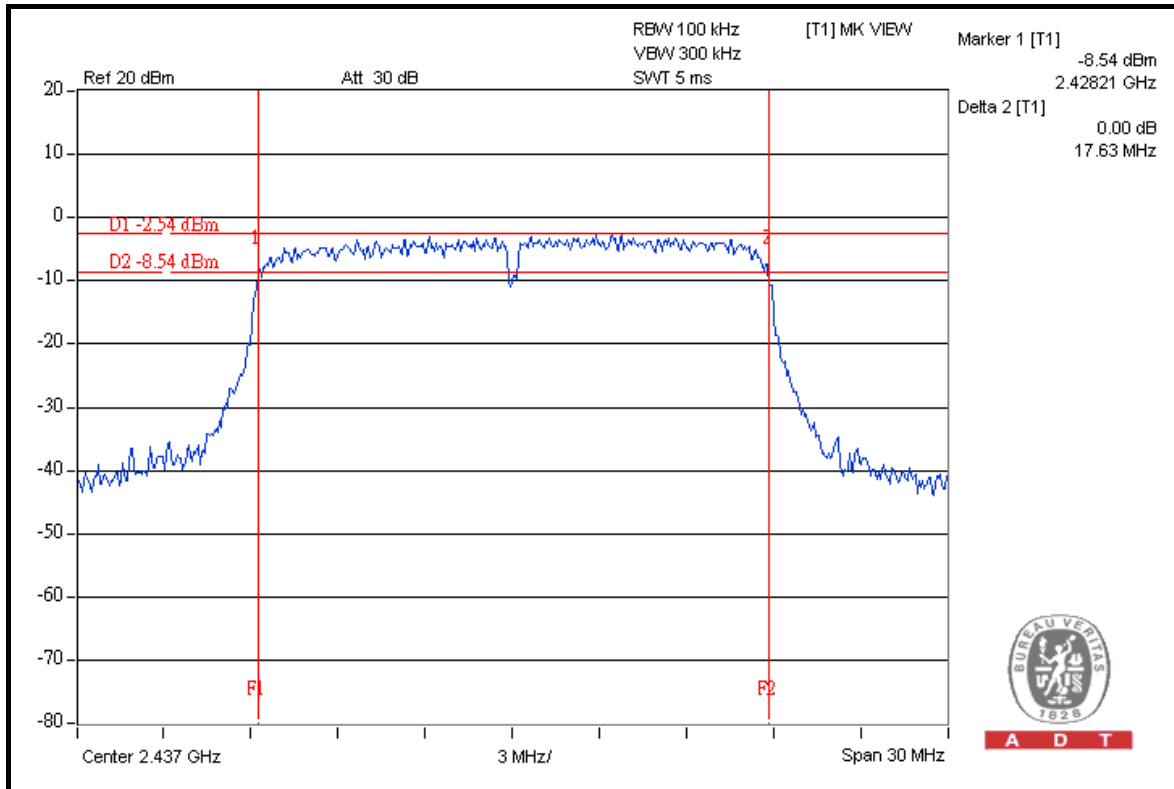

CH 11

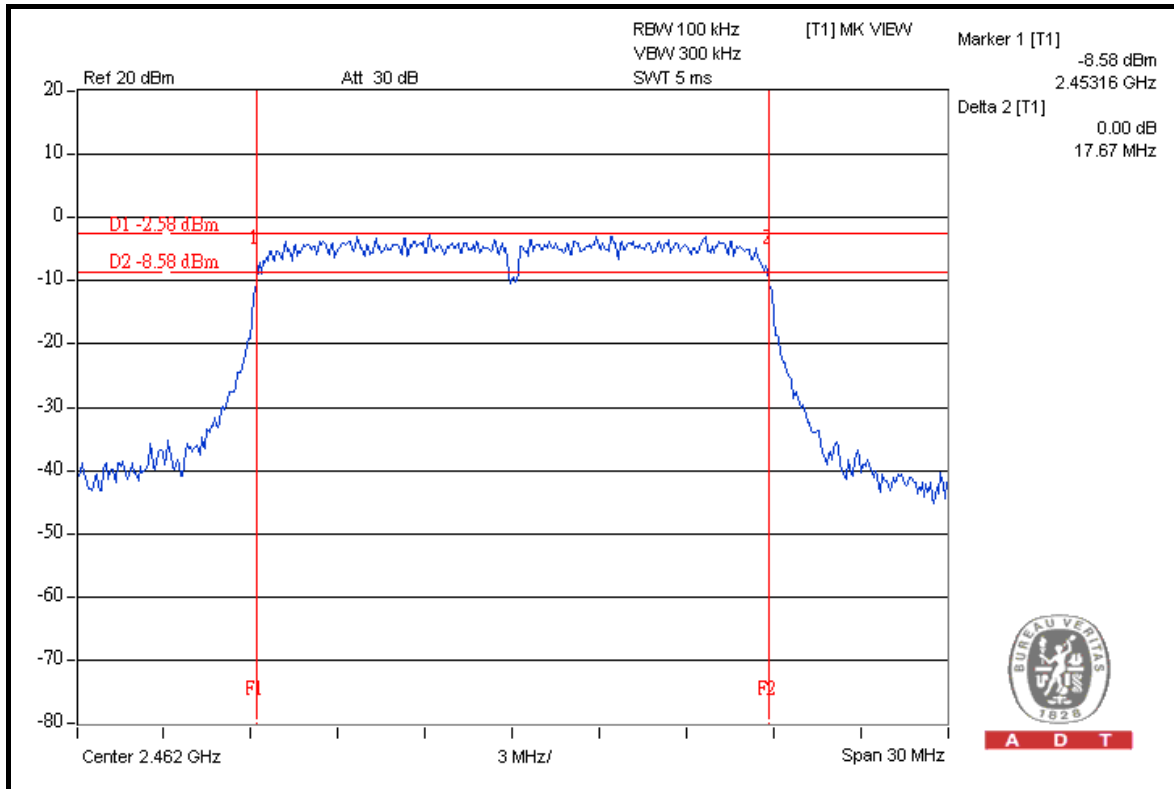



A D T

DRAFT 802.11n (40MHz) OFDM MODULATION

MODULATION TYPE	BPSK	TRANSFER RATE	15.0Mbps
INPUT POWER	120Vac, 60Hz	ENVIRONMENTAL CONDITIONS	25 deg.C, 65%RH, 1009hPa
TESTED BY	Match Tsui		

CHANNEL	CHANNEL FREQUENCY (MHz)	6dB BANDWIDTH (MHz)		MINIMUM LIMIT (MHz)	PASS / FAIL
		CHAIN 0	CHAIN 1		
1	2422	36.41	36.19	0.5	PASS
4	2437	36.43	36.40	0.5	PASS
7	2452	36.41	35.87	0.5	PASS



A D T

FOR CHAIN 0: CH 1

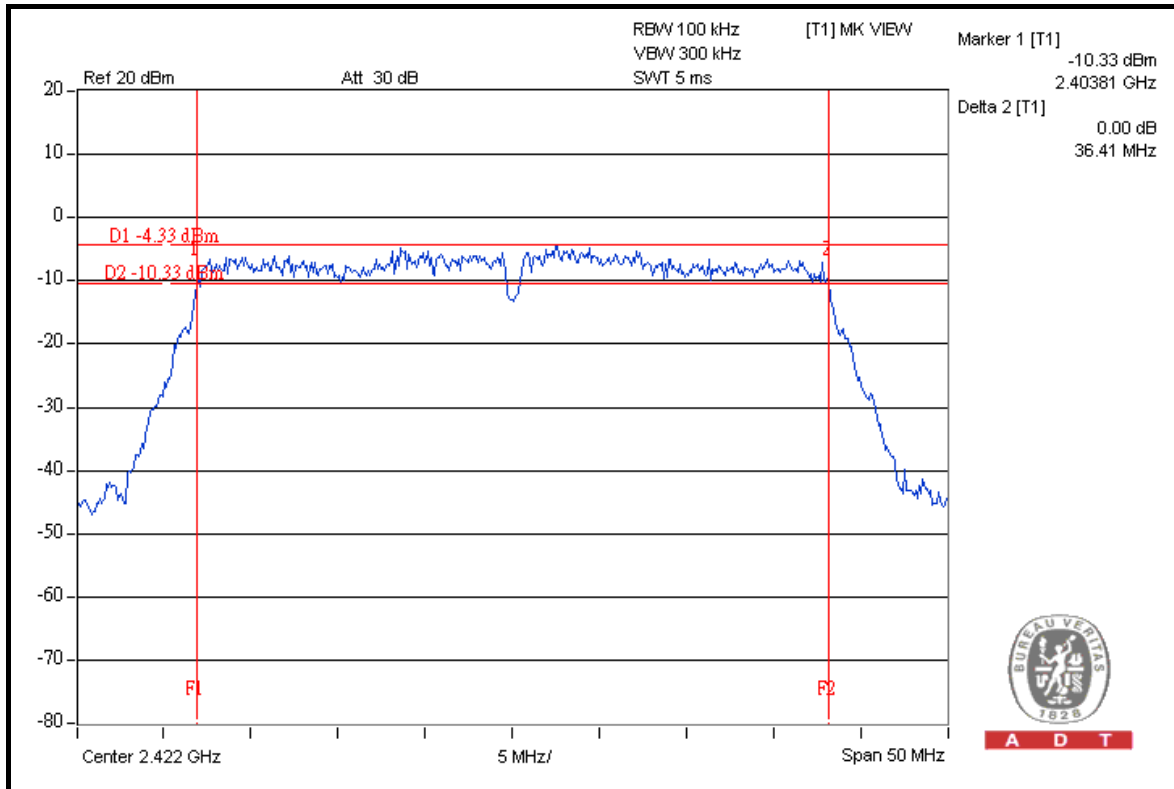

CH 4

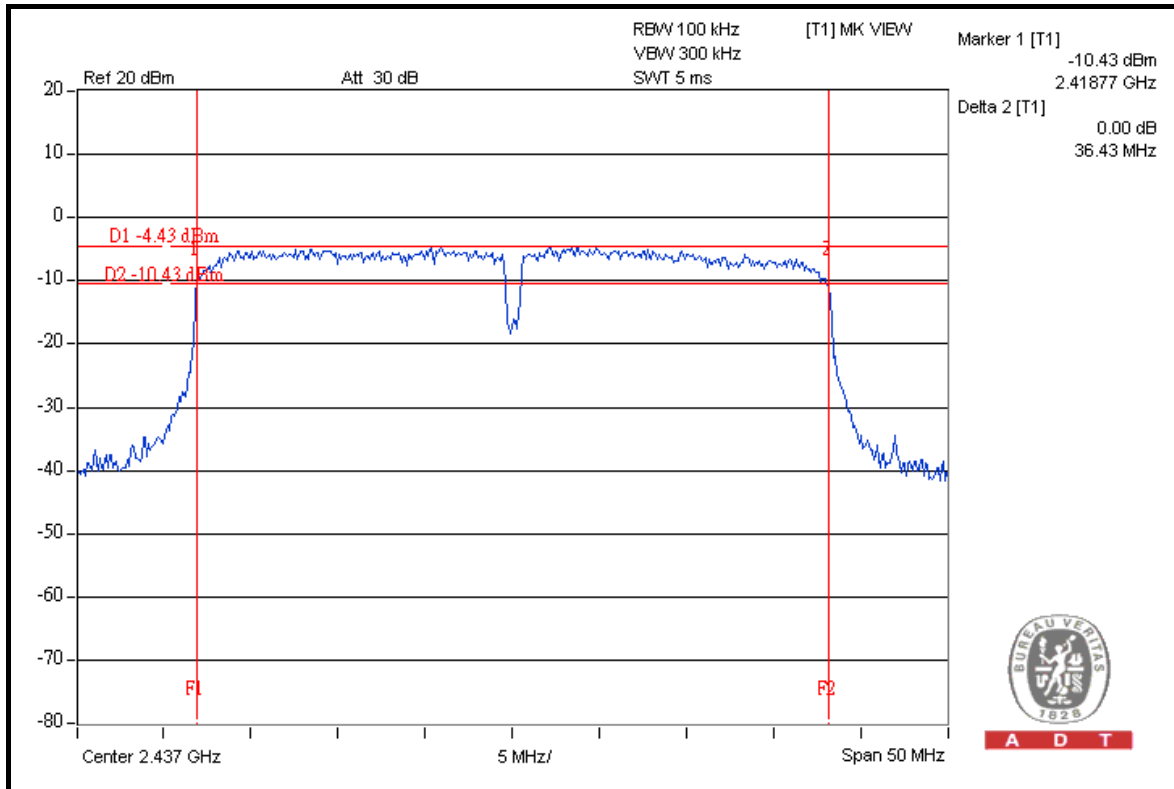



A D T

CH 7

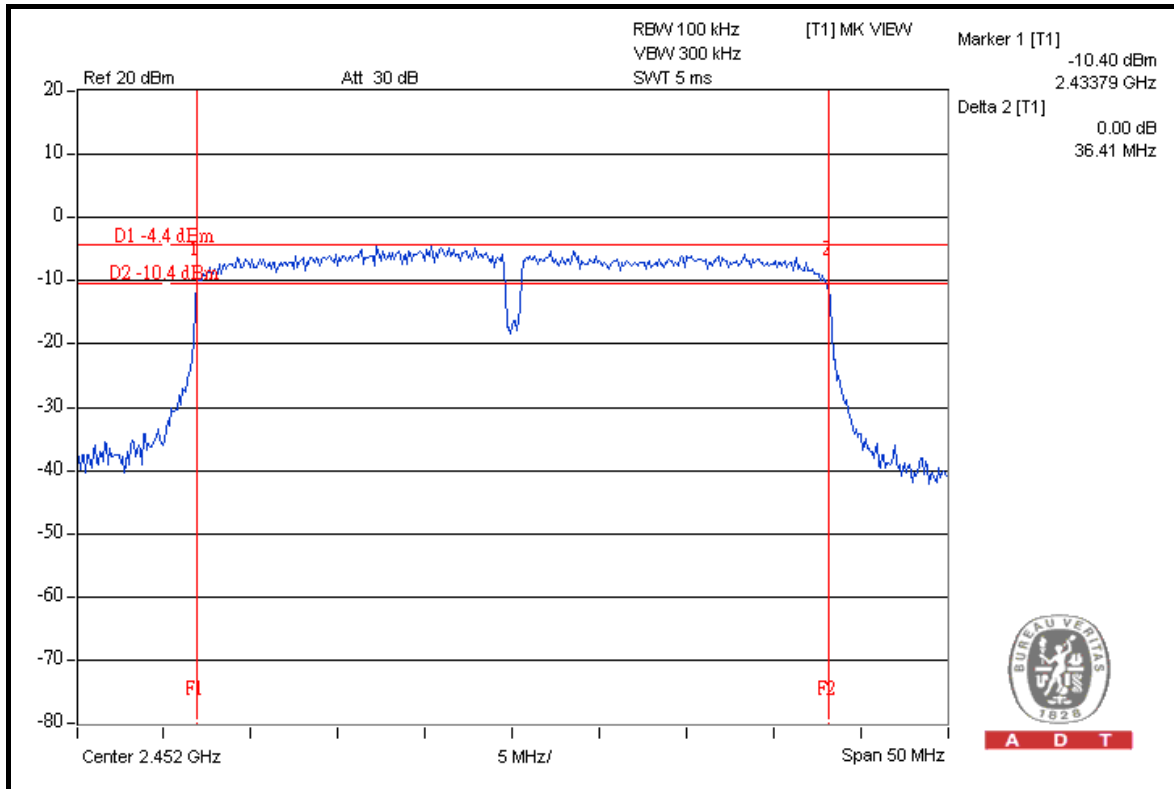

FOR CHAIN 1: CH 1

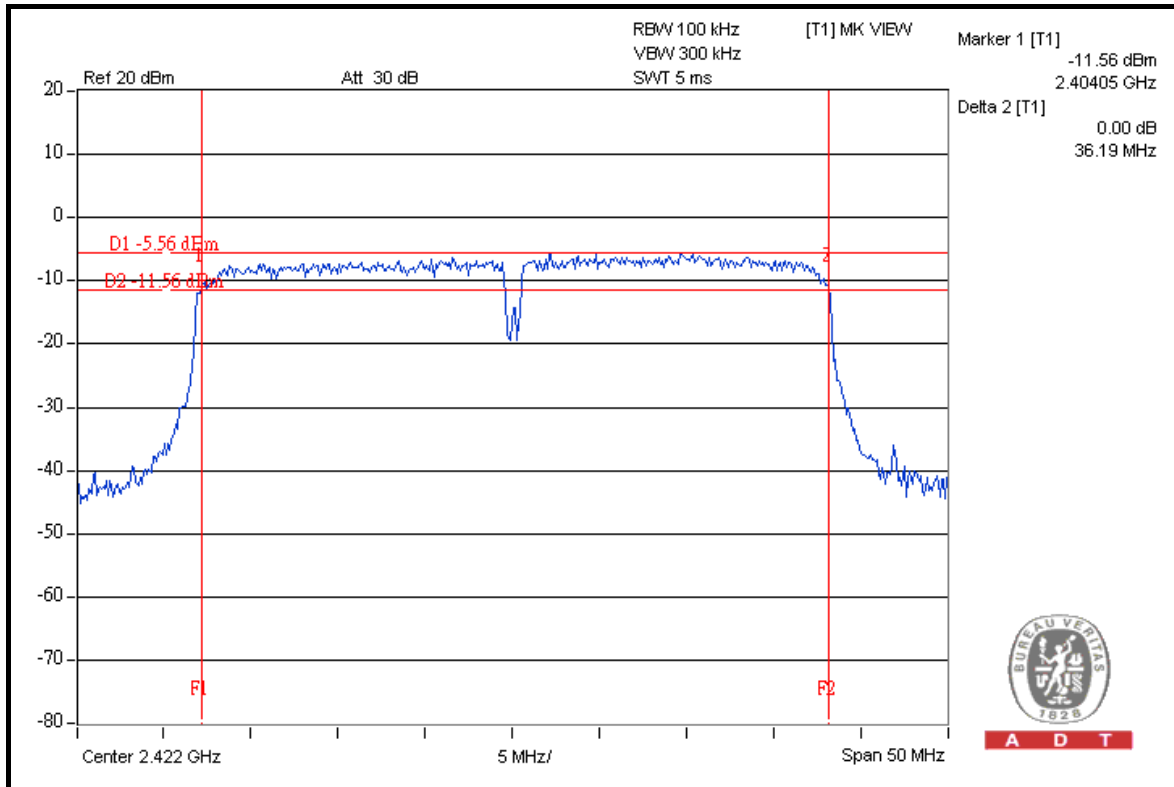



A D T

CH 4

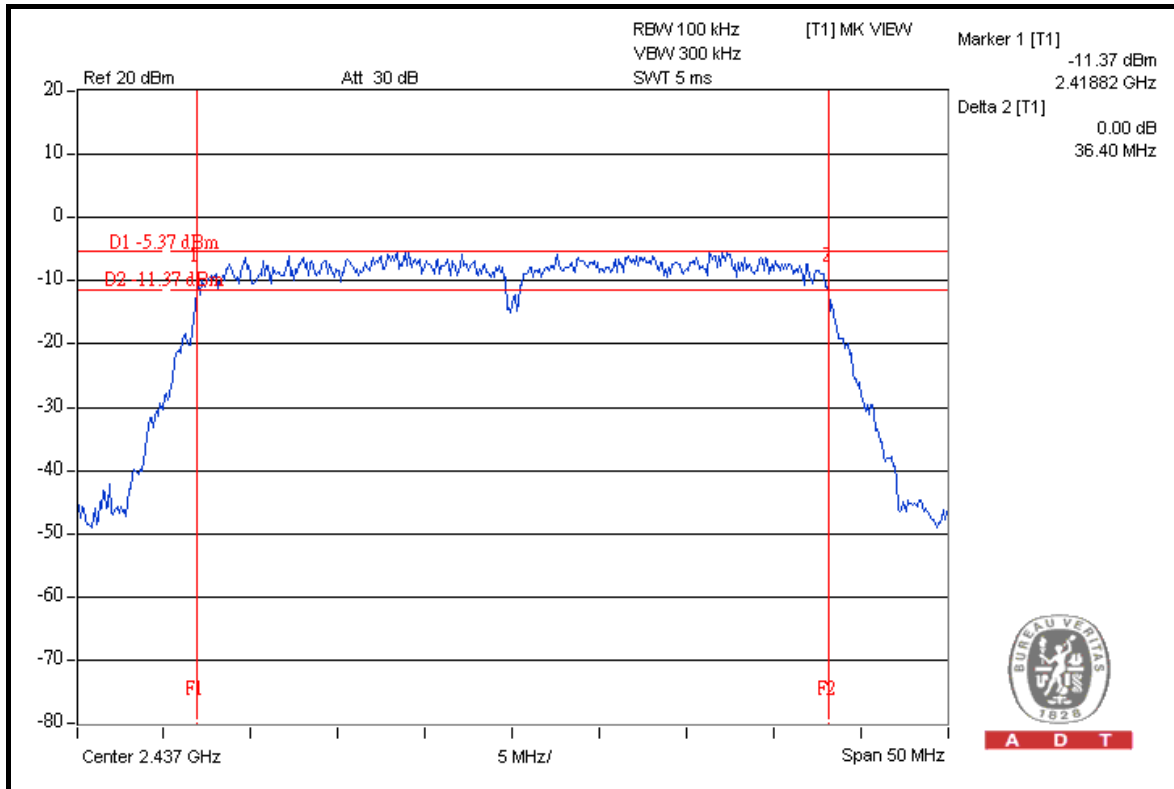

CH 7

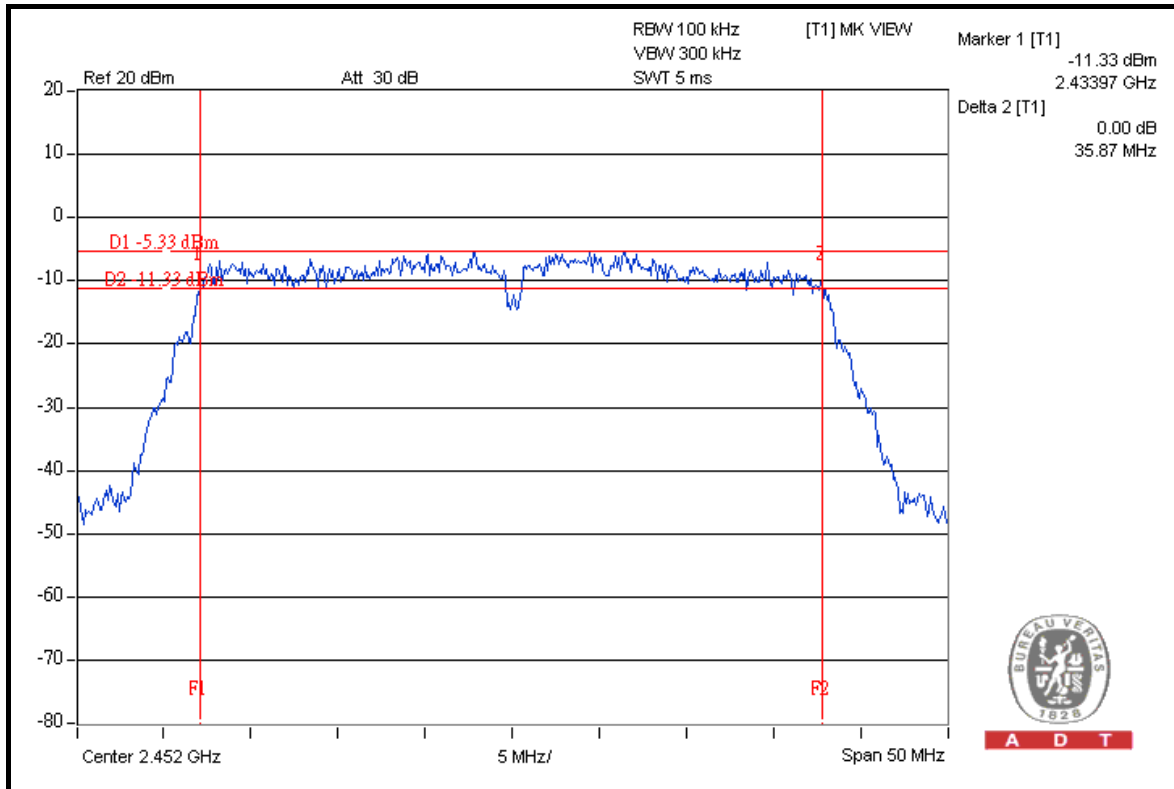



A D T

4.4 MAXIMUM PEAK OUTPUT POWER

4.4.1 LIMITS OF MAXIMUM PEAK OUTPUT POWER MEASUREMENT

The Maximum Peak Output Power Measurement is 30dBm.

4.4.2 INSTRUMENTS

DESCRIPTION & MANUFACTURER	MODEL NO.	SERIAL NO.	DATE OF CALIBRATION	DUE DATE OF CALIBRATION
High Speed Peak Power Meter	ML2495A	0824012	Aug. 04, 2008	Aug. 03, 2009
Power Sensor	MA2411B	0738138	Aug. 04, 2008	Aug. 03, 2009

NOTE:

1. The calibration interval of the above test instruments is 12 months and the calibrations are traceable to NML/ROC and NIST/USA.
2. Measurement Bandwidth of ML2495A is 65MHz greater than 6dB bandwidth of emission.

4.4.3 TEST PROCEDURES

A power sensor was used on the output port of the EUT. A power meter was used to read the response of the power sensor. Record the power level.

4.4.4 DEVIATION FROM TEST STANDARD

No deviation.

4.4.5 TEST SETUP

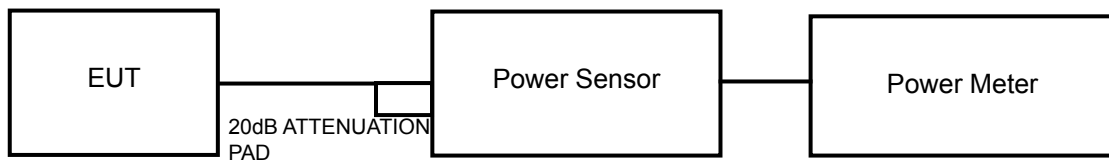

4.4.6 EUT OPERATING CONDITIONS

Same as Item 4.3.6.



A D T

4.4.7 TEST RESULTS

802.11b DSSS MODULATION

MODULATION TYPE	DBPSK	TRANSFER RATE	1.0Mbps
INPUT POWER	120Vac, 60Hz	ENVIRONMENTAL CONDITIONS	25 deg.C, 65%RH, 1009hPa
TESTED BY	Match Tsui		

CHAN.	CHAN. FREQ. (MHz)	PEAK POWER OUTPUT (dBm)		TOTAL PEAK POWER (mW)	TOTAL PEAK POWER (dBm)	PEAK POWER LIMIT (dBm)	PASS / FAIL
		CHAIN 0	CHAIN 1				
1	2412	16.03	16.04	80.266	19.05	30	PASS
6	2437	16.09	16.11	81.476	19.11	30	PASS
11	2462	16.05	16.09	80.916	19.08	30	PASS

802.11g OFDM MODULATION

MODULATION TYPE	BPSK	TRANSFER RATE	6.0Mbps
INPUT POWER	120Vac, 60Hz	ENVIRONMENTAL CONDITIONS	25 deg.C, 65%RH, 1009hPa
TESTED BY	Match Tsui		

CHAN.	CHAN. FREQ. (MHz)	PEAK POWER OUTPUT (dBm)		TOTAL PEAK POWER (mW)	TOTAL PEAK POWER (dBm)	PEAK POWER LIMIT (dBm)	PASS / FAIL
		CHAIN 0	CHAIN 1				
1	2412	22.02	22.05	319.545	25.05	30	PASS
6	2437	22.08	22.06	322.130	25.08	30	PASS
11	2462	22.04	22.03	319.544	25.05	30	PASS



A D T

DRAFT 802.11n (20MHz) OFDM MODULATION

MODULATION TYPE	BPSK	TRANSFER RATE	7.2Mbps
INPUT POWER	120Vac, 60Hz	ENVIRONMENTAL CONDITIONS	25 deg.C, 65%RH, 1009hPa
TESTED BY	Match Tsui		

CHAN.	CHAN. FREQ. (MHz)	PEAK POWER OUTPUT (dBm)		TOTAL PEAK POWER (mW)	TOTAL PEAK POWER (dBm)	PEAK POWER LIMIT (dBm)	PASS / FAIL
		CHAIN 0	CHAIN 1				
1	2412	20.05	20.06	202.549	23.07	30	PASS
6	2437	20.13	20.08	204.898	23.12	30	PASS
11	2462	20.04	20.02	201.387	23.04	30	PASS

DRAFT 802.11n (40MHz) OFDM MODULATION

MODULATION TYPE	BPSK	TRANSFER RATE	15.0Mbps
INPUT POWER	120Vac, 60Hz	ENVIRONMENTAL CONDITIONS	25 deg.C, 65%RH, 1009hPa
TESTED BY	Match Tsui		

CHAN.	CHAN. FREQ. (MHz)	PEAK POWER OUTPUT (dBm)		TOTAL PEAK POWER (mW)	TOTAL PEAK POWER (dBm)	PEAK POWER LIMIT (dBm)	PASS / FAIL
		CHAIN 0	CHAIN 1				
1	2422	18.08	18.05	128.095	21.08	30	PASS
4	2437	18.11	18.09	129.131	21.11	30	PASS
7	2452	18.05	18.03	127.359	21.05	30	PASS

4.5 POWER SPECTRAL DENSITY MEASUREMENT

4.5.1 LIMITS OF POWER SPECTRAL DENSITY MEASUREMENT

The Maximum of Power Spectral Density Measurement is 8dBm.

4.5.2 TEST INSTRUMENTS

DESCRIPTION & MANUFACTURER	MODEL NO.	SERIAL NO.	DATE OF CALIBRATION	DUE DATE OF CALIBRATION
R&S SPECTRUM ANALYZER	FSP40	100040	Jul. 04, 2008	Jul. 03, 2009

NOTE: The calibration interval of the above test instruments is 12 months and the calibrations are traceable to NML/ROC and NIST/USA.

4.5.3 TEST PROCEDURE

The transmitter output was connected to the spectrum analyzer through an attenuator, the bandwidth of the fundamental frequency was measured with the spectrum analyzer using 3kHz RBW and 30kHz VBW, set sweep time = span/3kHz. The power spectral density was measured and recorded.

The sweep time is allowed to be longer than span/3kHz for a full response of the mixer in the spectrum analyzer.

4.5.4 DEVIATION FROM TEST STANDARD

No deviation.

4.5.5 TEST SETUP

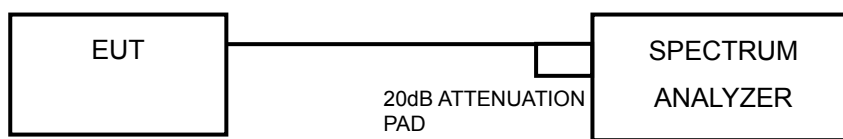

4.5.6 EUT OPERATING CONDITION

Same as Item 4.3.6



A D T

4.5.7 TEST RESULTS

802.11b DSSS MODULATION

MODULATION TYPE	DBPSK	TRANSFER RATE	1.0Mbps
INPUT POWER	120Vac, 60Hz	ENVIRONMENTAL CONDITIONS	25 deg.C, 65%RH, 1009hPa
TESTED BY	Match Tsui		

CHAN.	CHAN. FREQ. (MHz)	RF POWER LEVEL IN 3kHz BW (dBm)		TOTAL POWER DENSITY (mW)	TOTAL POWER DENSITY (dBm)	MAX. LIMIT (dBm)	PASS / FAIL
		CHAIN 0	CHAIN 1				
1	2412	-14.01	-14.48	0.075	-11.23	8	PASS
6	2437	-13.97	-14.35	0.077	-11.15	8	PASS
11	2462	-13.94	-14.31	0.077	-11.11	8	PASS



A D T

FOR CHAIN 0: CH 1

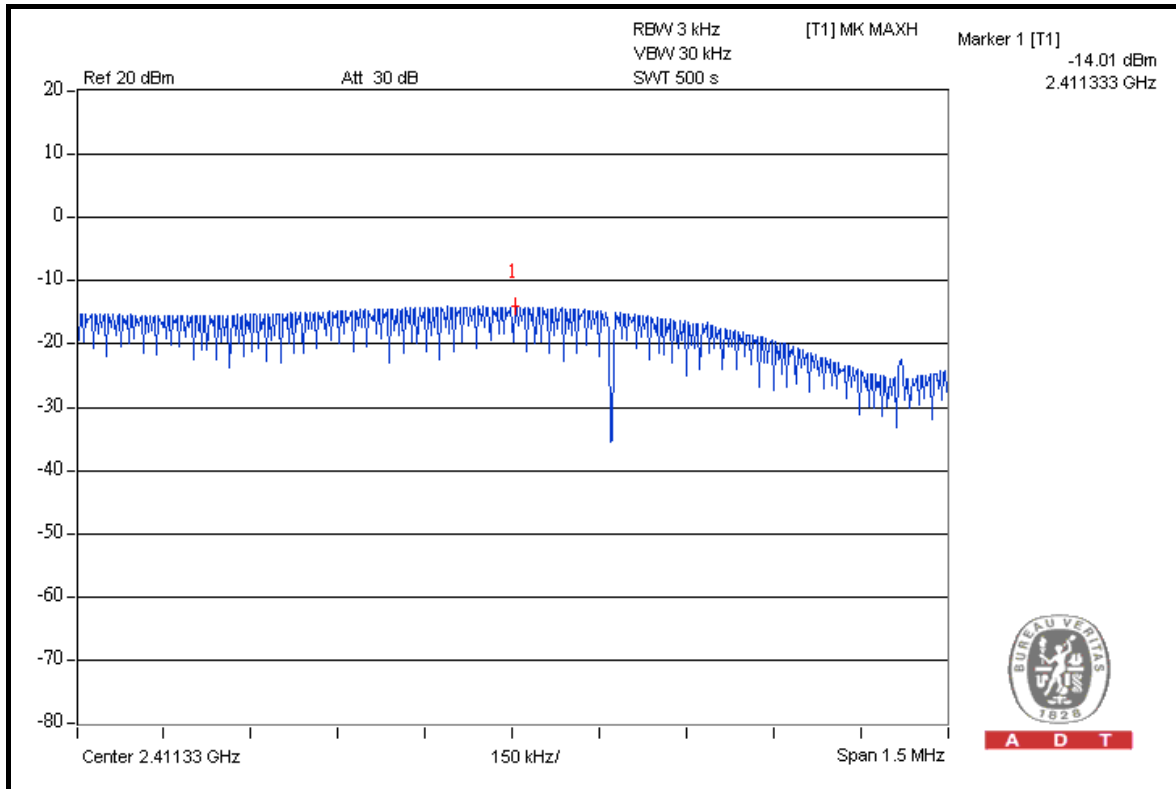

CH 6

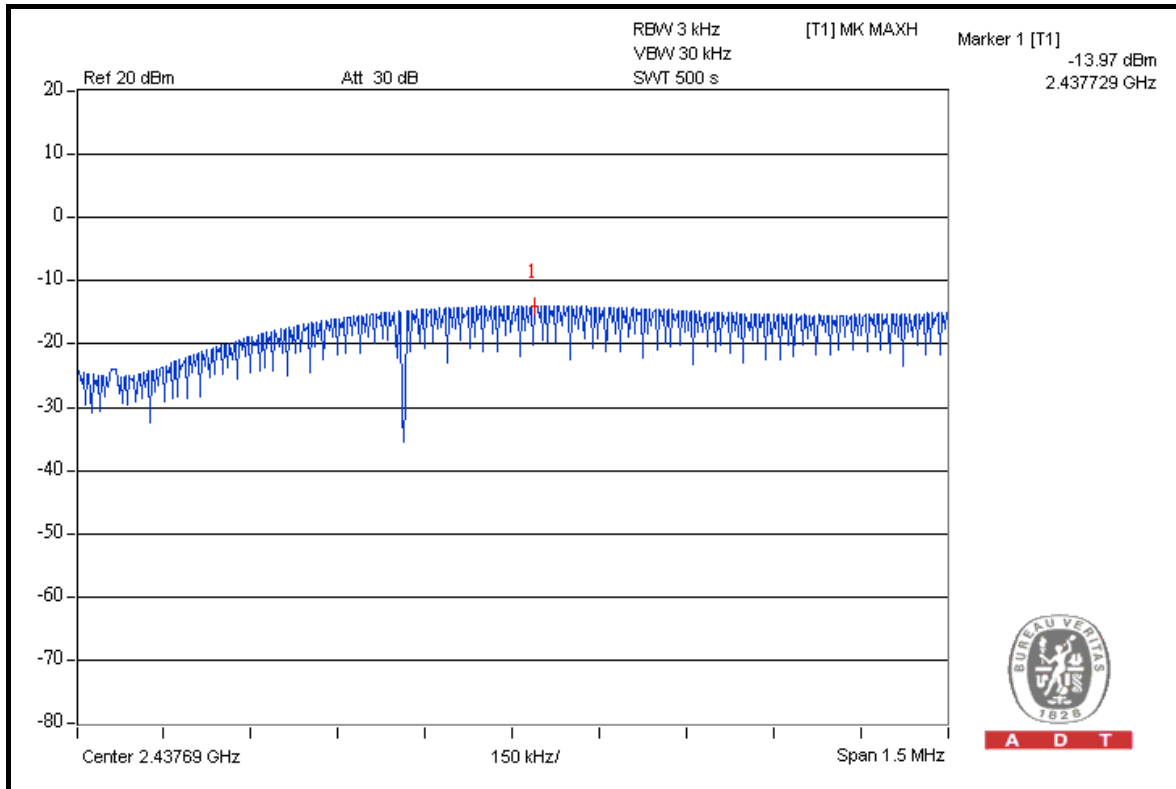



A D T

CH 11

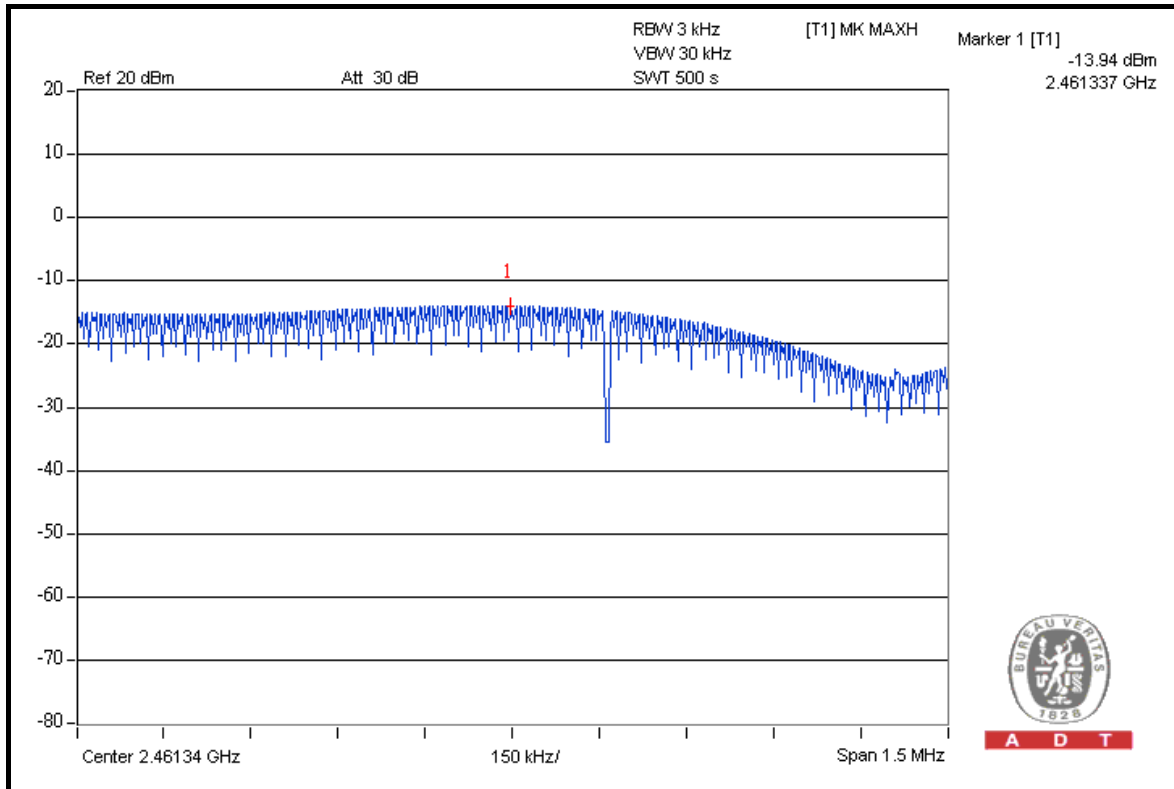

A D T

FOR CHAIN 1: CH 1

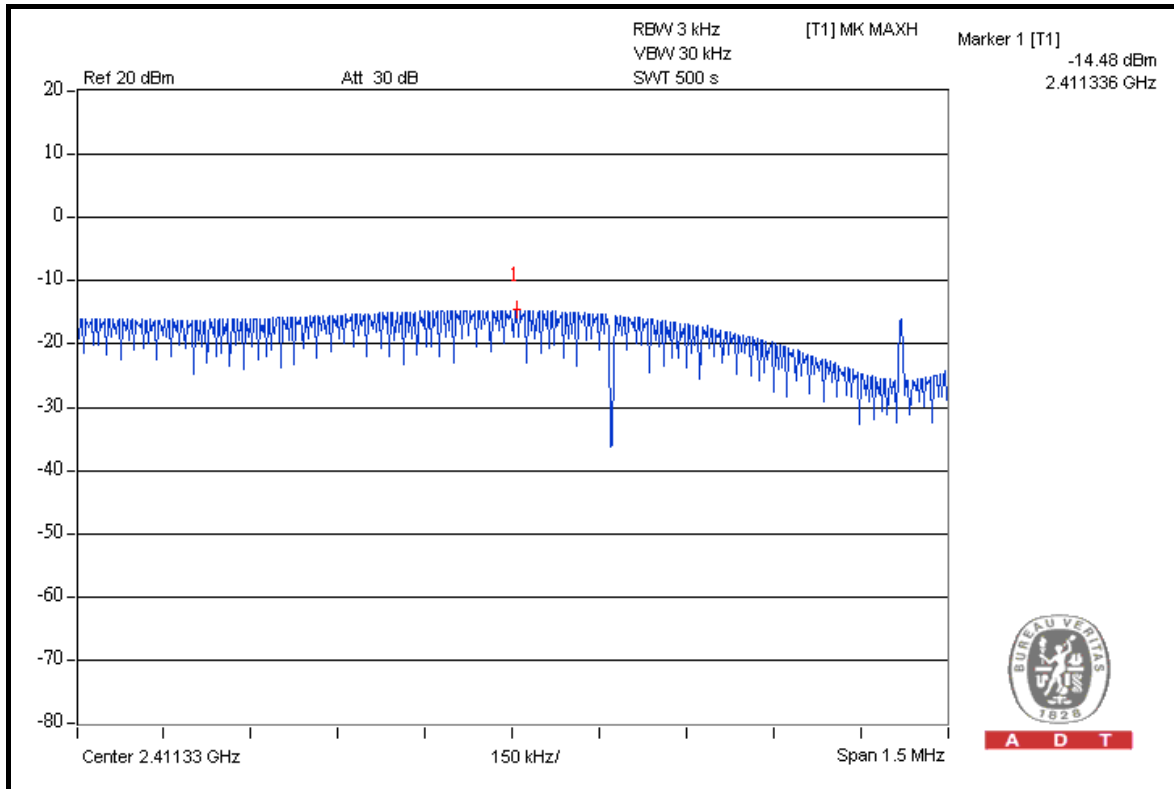

A D T



A D T

CH 6

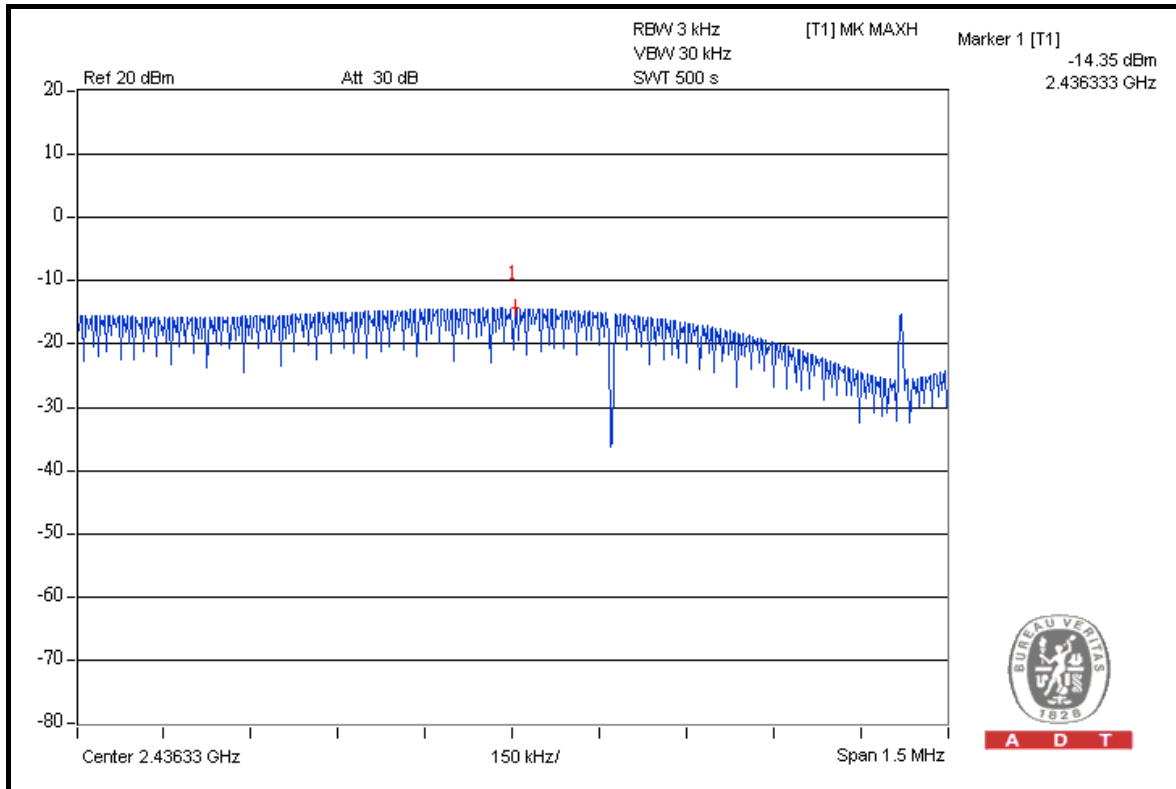

A D T

CH 11

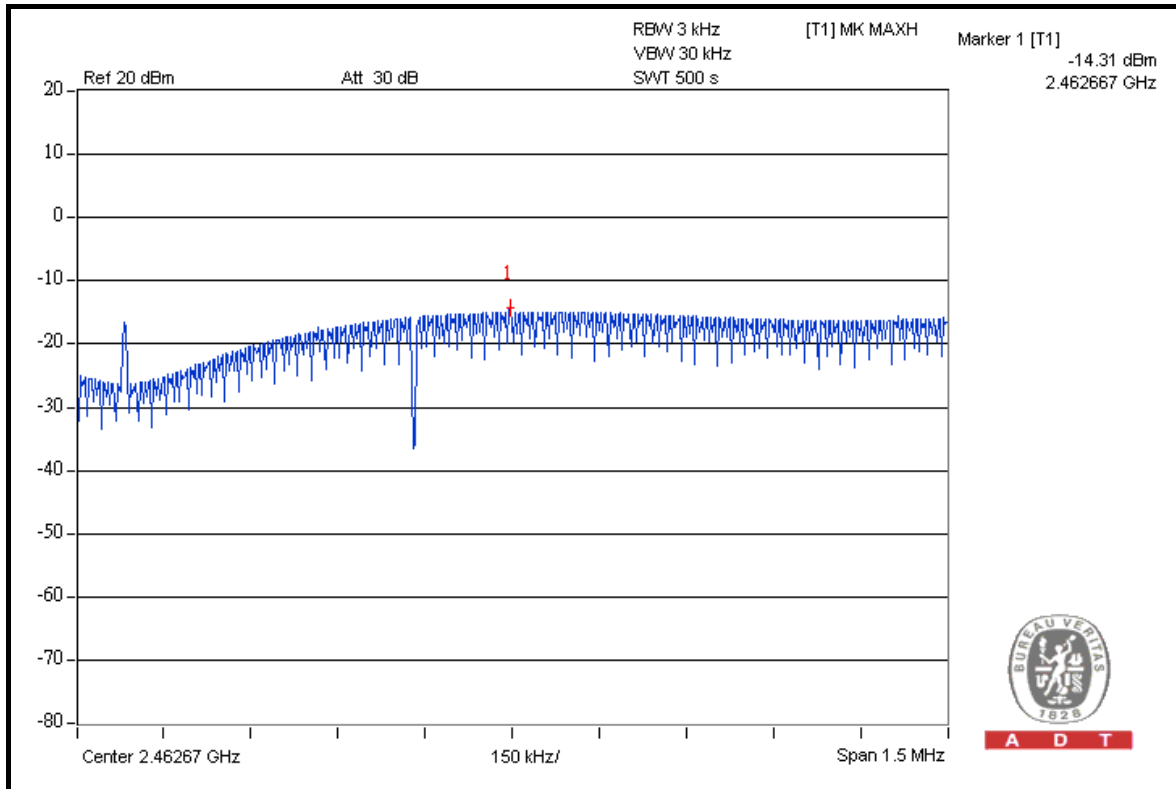

A D T



A D T

802.11g OFDM MODULATION

MODULATION TYPE	BPSK	TRANSFER RATE	6.0Mbps
INPUT POWER	120Vac, 60Hz	ENVIRONMENTAL CONDITIONS	25 deg.C, 65%RH, 1009hPa
TESTED BY	Match Tsui		

CHAN.	CHAN. FREQ. (MHz)	RF POWER LEVEL IN 3kHz BW (dBm)		TOTAL POWER DENSITY (mW)	TOTAL POWER DENSITY (dBm)	MAX. LIMIT (dBm)	PASS / FAIL
		CHAIN 0	CHAIN 1				
1	2412	-14.84	-13.97	0.073	-11.37	8	PASS
6	2437	-14.69	-13.83	0.075	-11.23	8	PASS
11	2462	-14.63	-14.18	0.073	-11.39	8	PASS



A D T

FOR CHAIN 0: CH 1

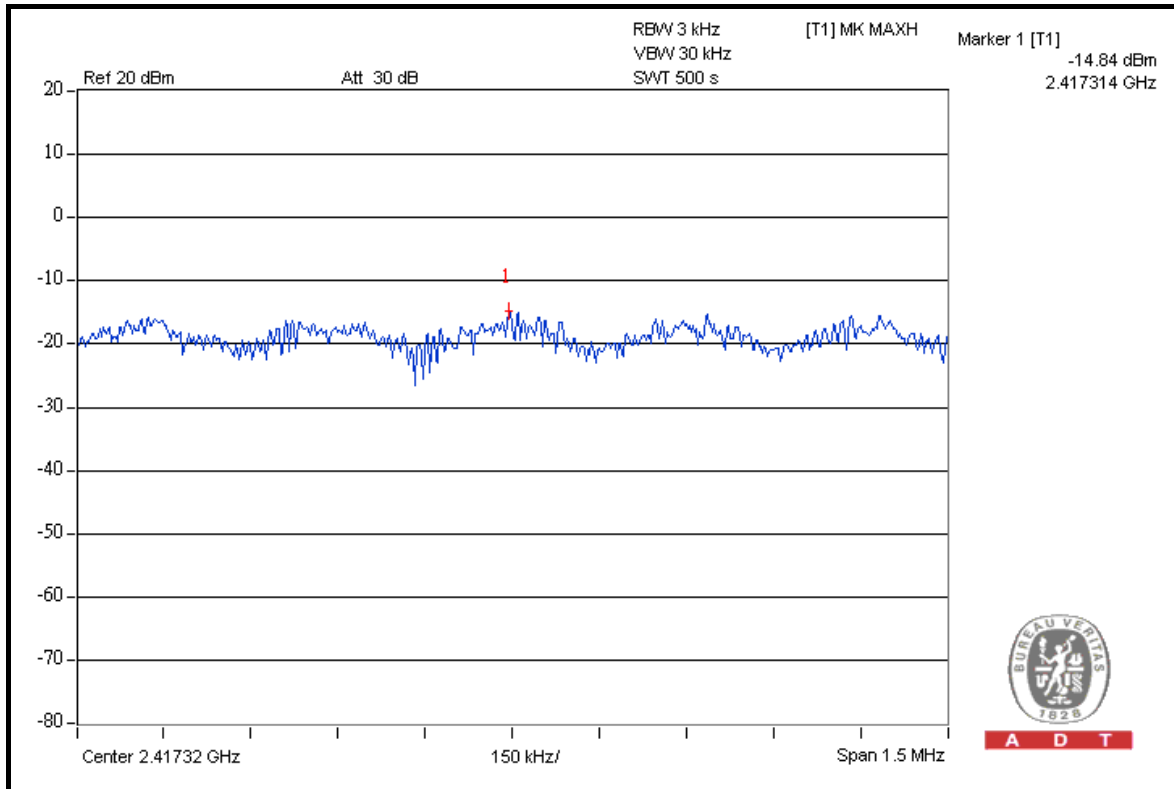

A D T

CH 6

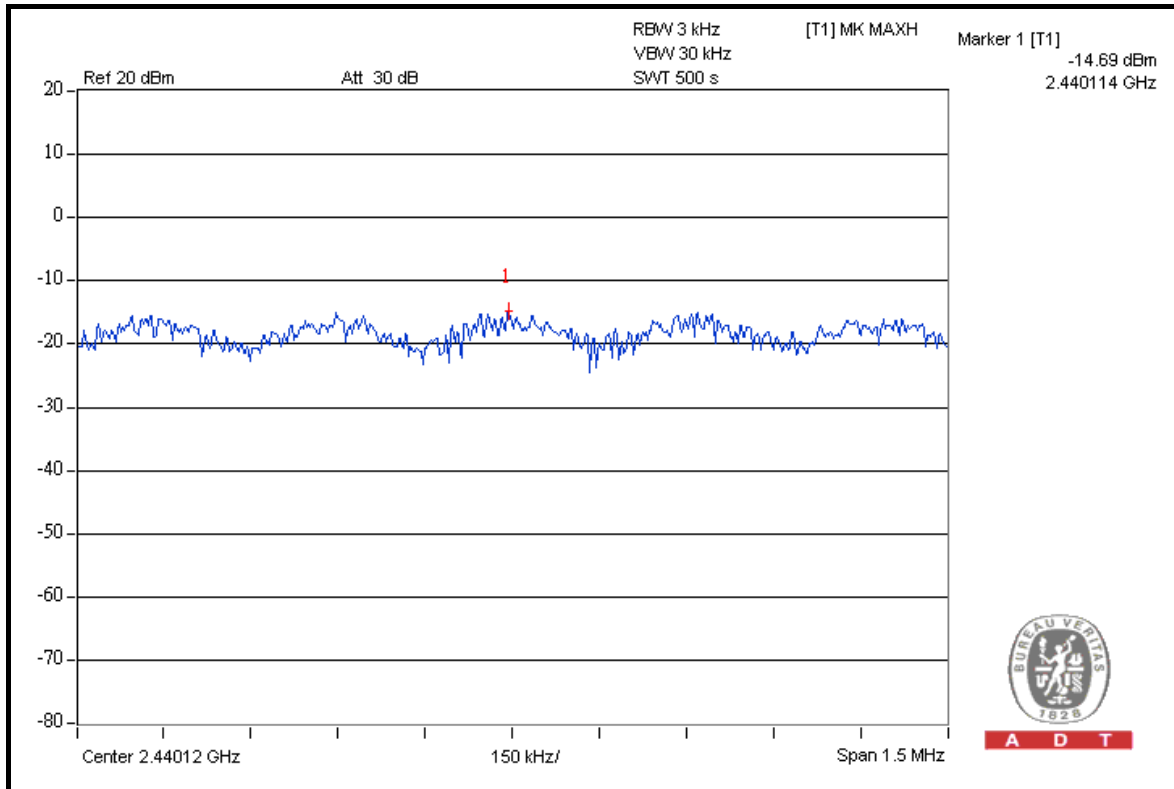

A D T



A D T

CH 11

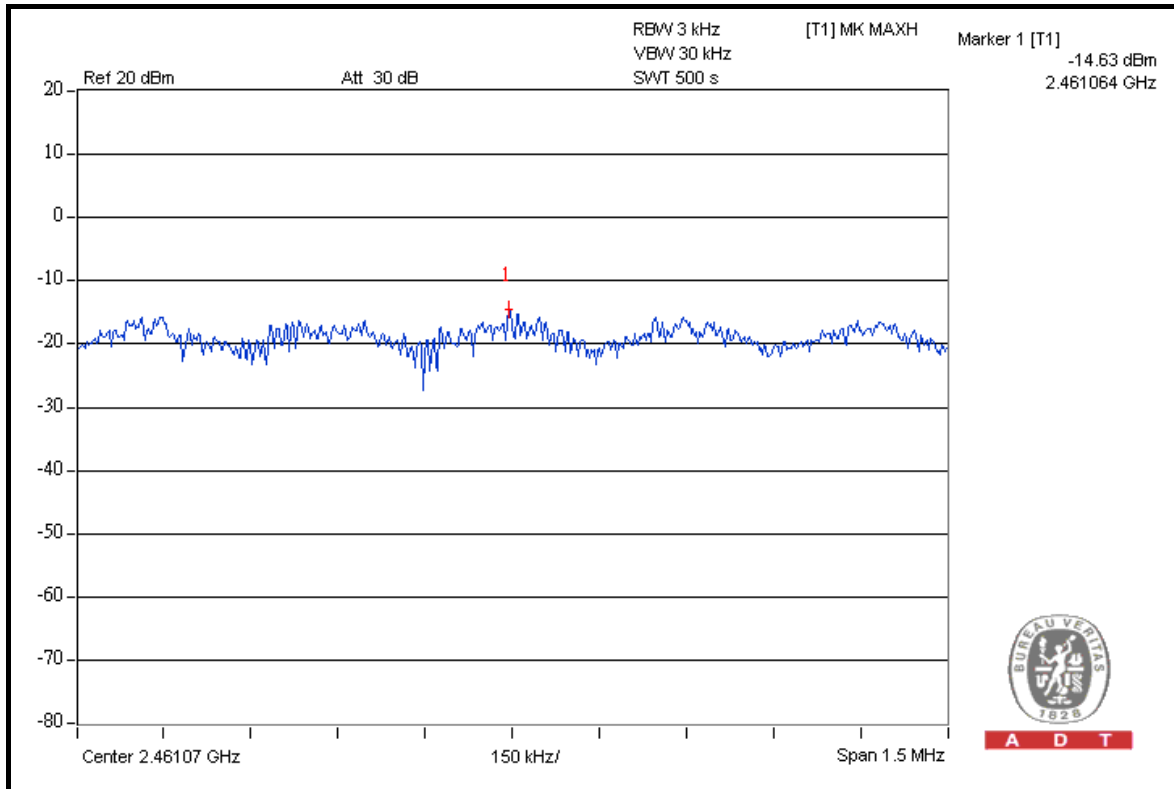

FOR CHAIN 1: CH 1

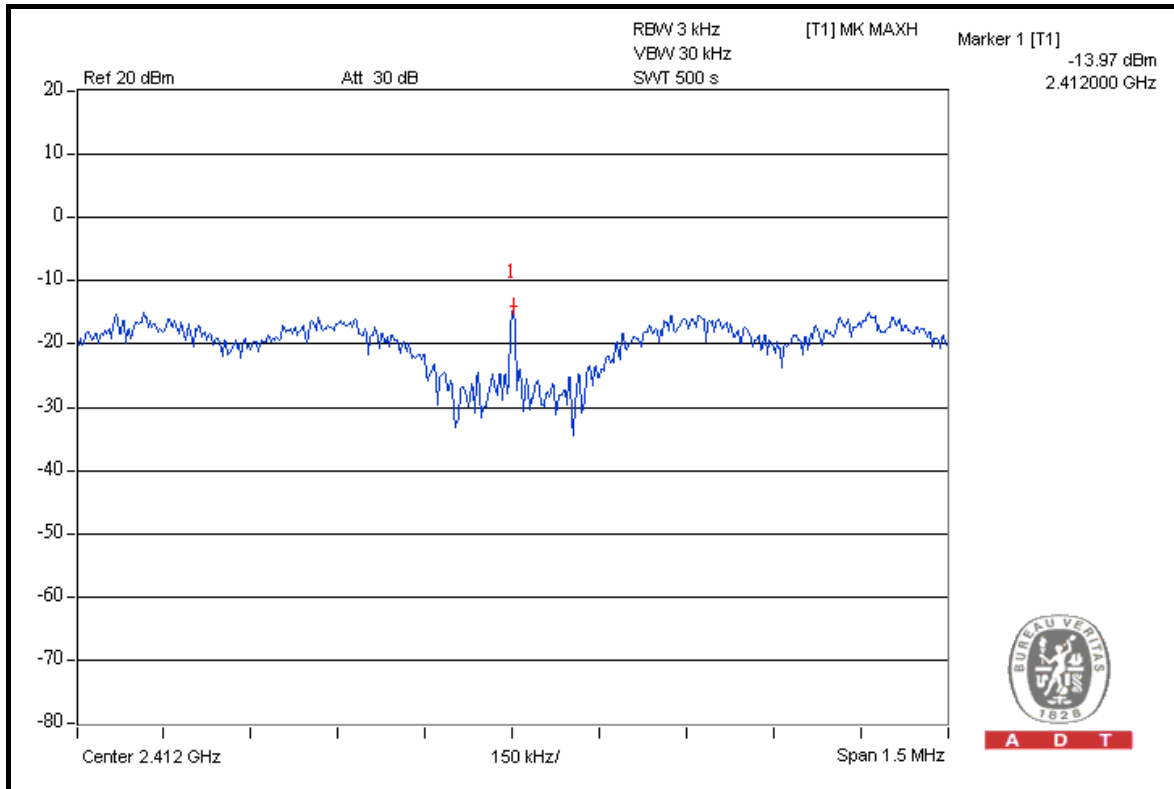



A D T

CH 6

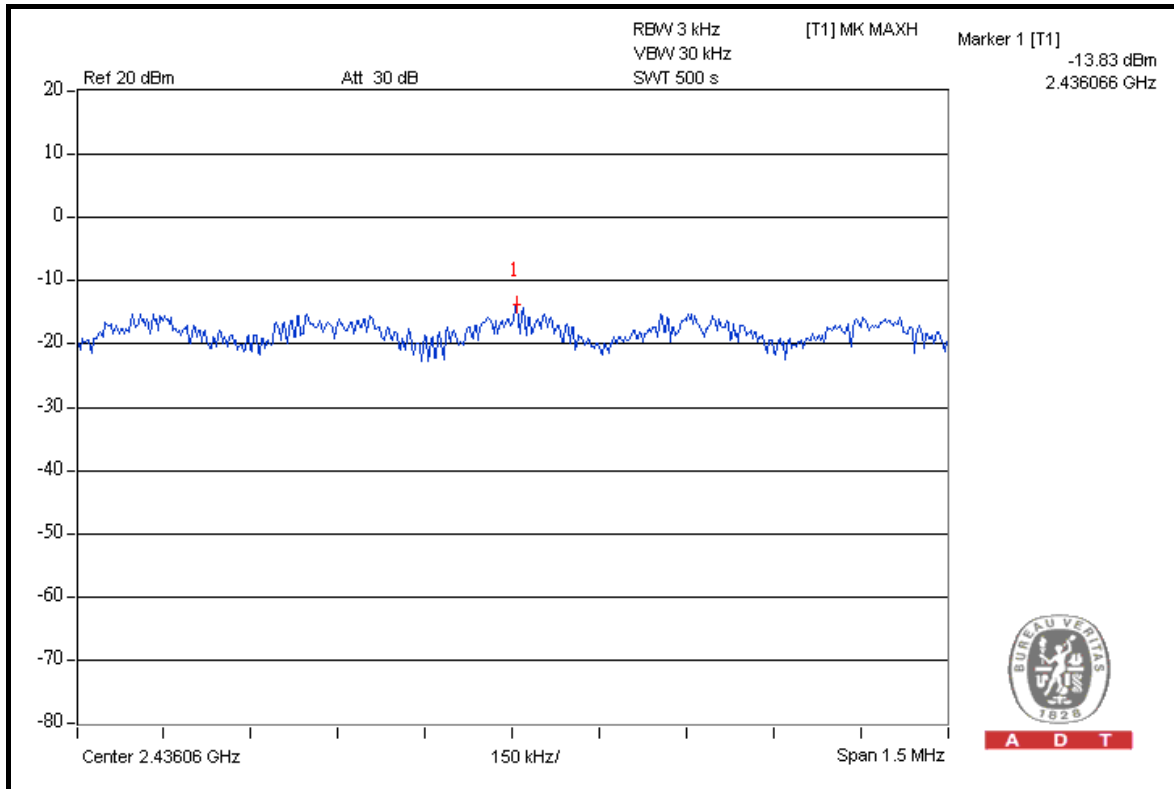

CH 11

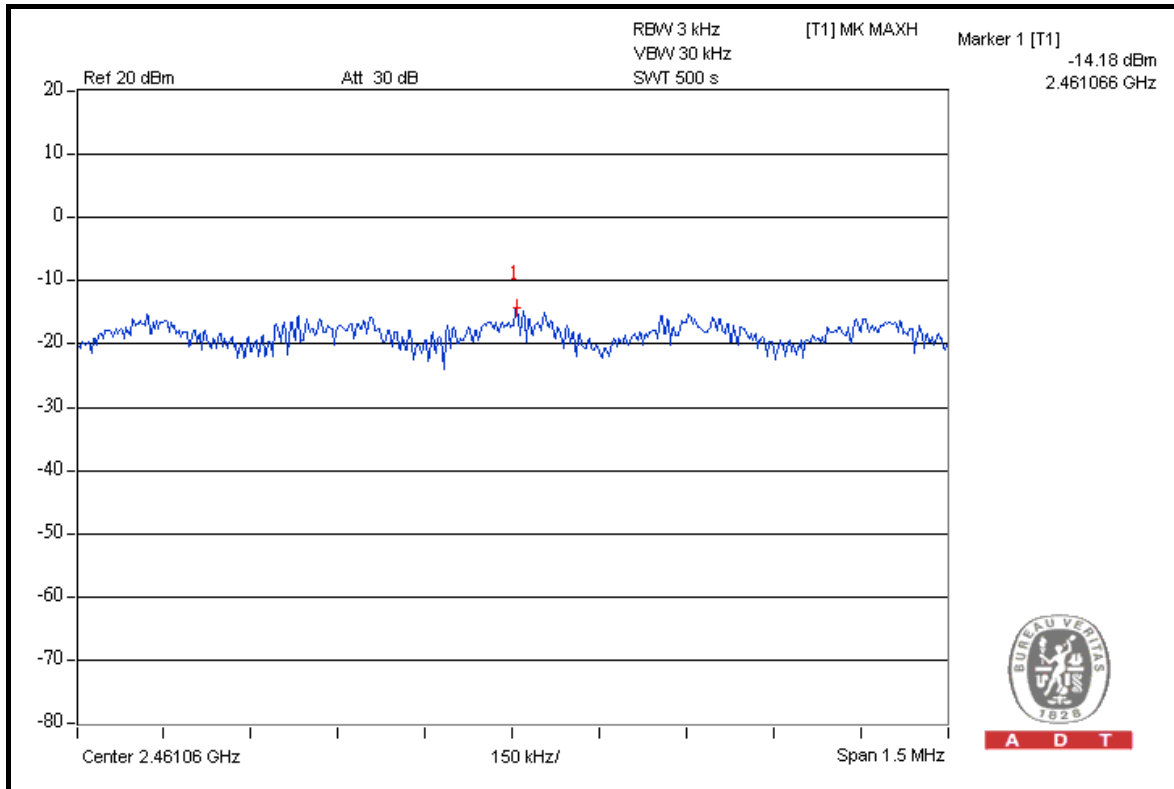



A D T

DRAFT 802.11n (20MHz) OFDM MODULATION

MODULATION TYPE	BPSK	TRANSFER RATE	7.2Mbps
INPUT POWER	120Vac, 60Hz	ENVIRONMENTAL CONDITIONS	25 deg.C, 65%RH, 1009hPa
TESTED BY	Match Tsui		

CHAN.	CHAN. FREQ. (MHz)	RF POWER LEVEL IN 3kHz BW (dBm)		TOTAL POWER DENSITY (mW)	TOTAL POWER DENSITY (dBm)	MAX. LIMIT (dBm)	PASS / FAIL
		CHAIN 0	CHAIN 1				
1	2412	-16.48	-16.48	0.045	-13.47	8	PASS
6	2437	-16.41	-16.34	0.046	-13.36	8	PASS
11	2462	-16.34	-16.25	0.047	-13.28	8	PASS



A D T

FOR CHAIN 0: CH 1

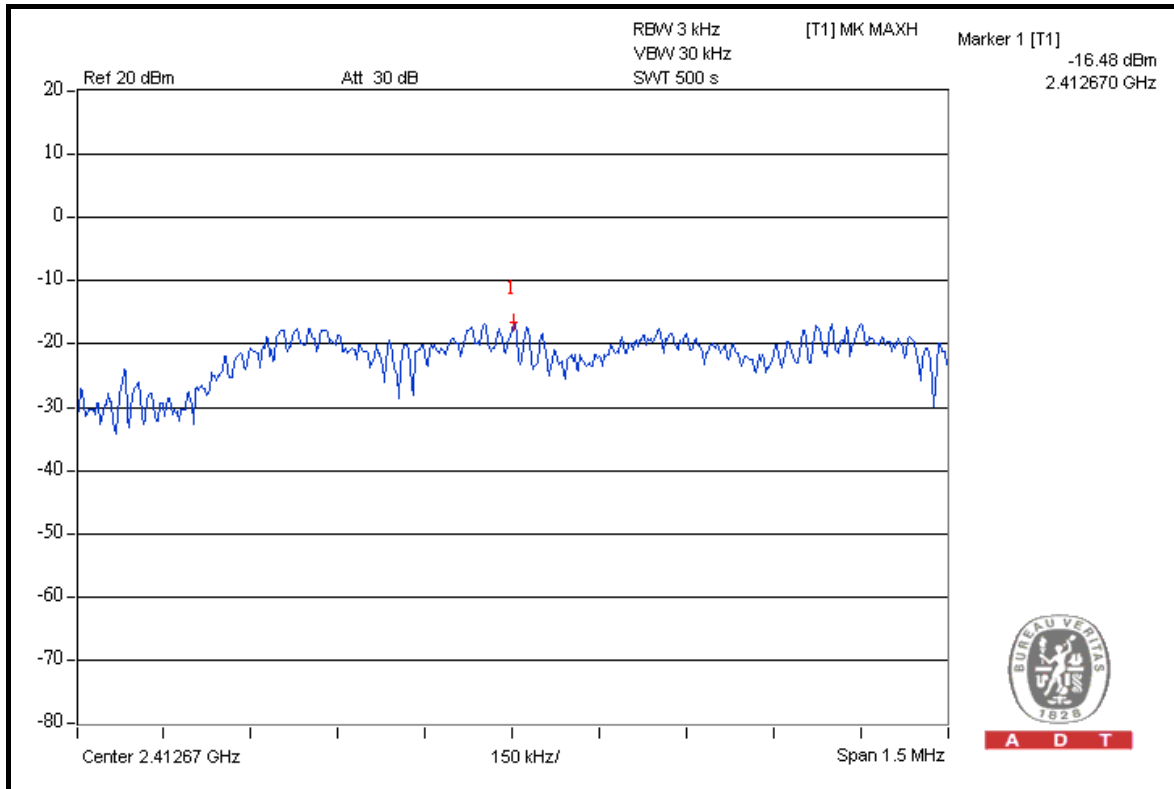

CH 6

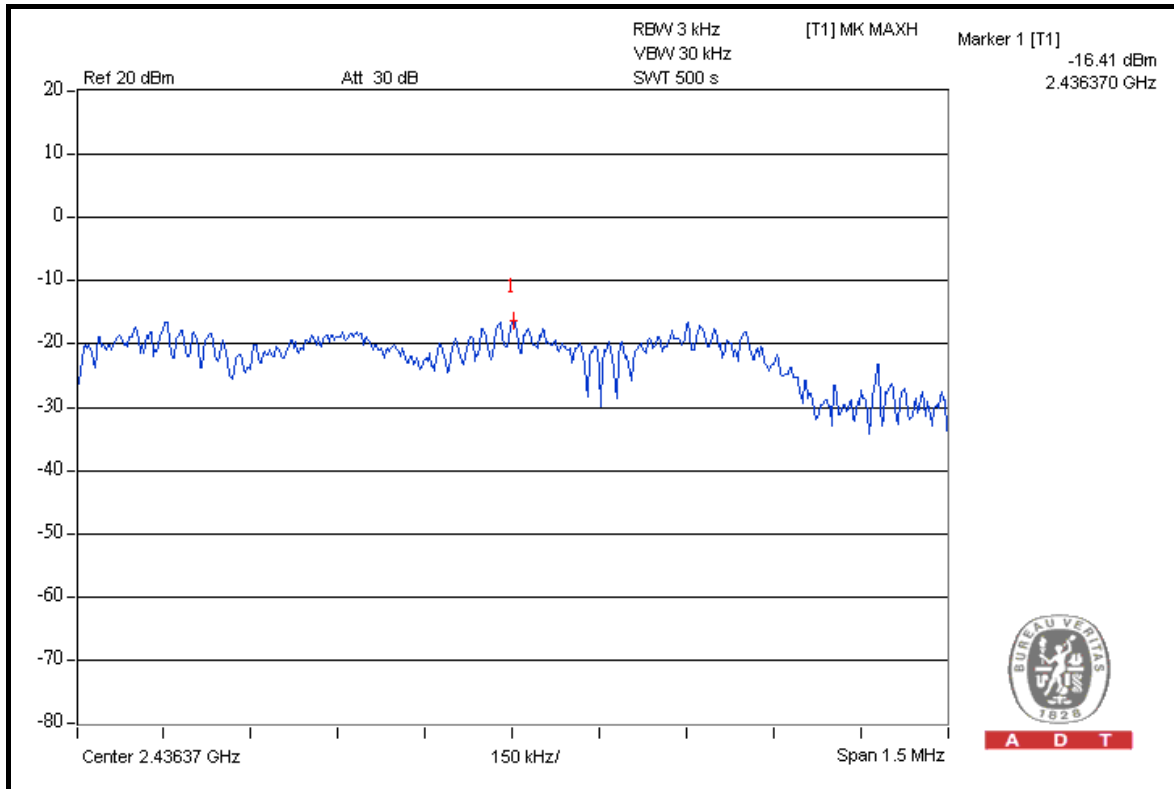



A D T

CH 11

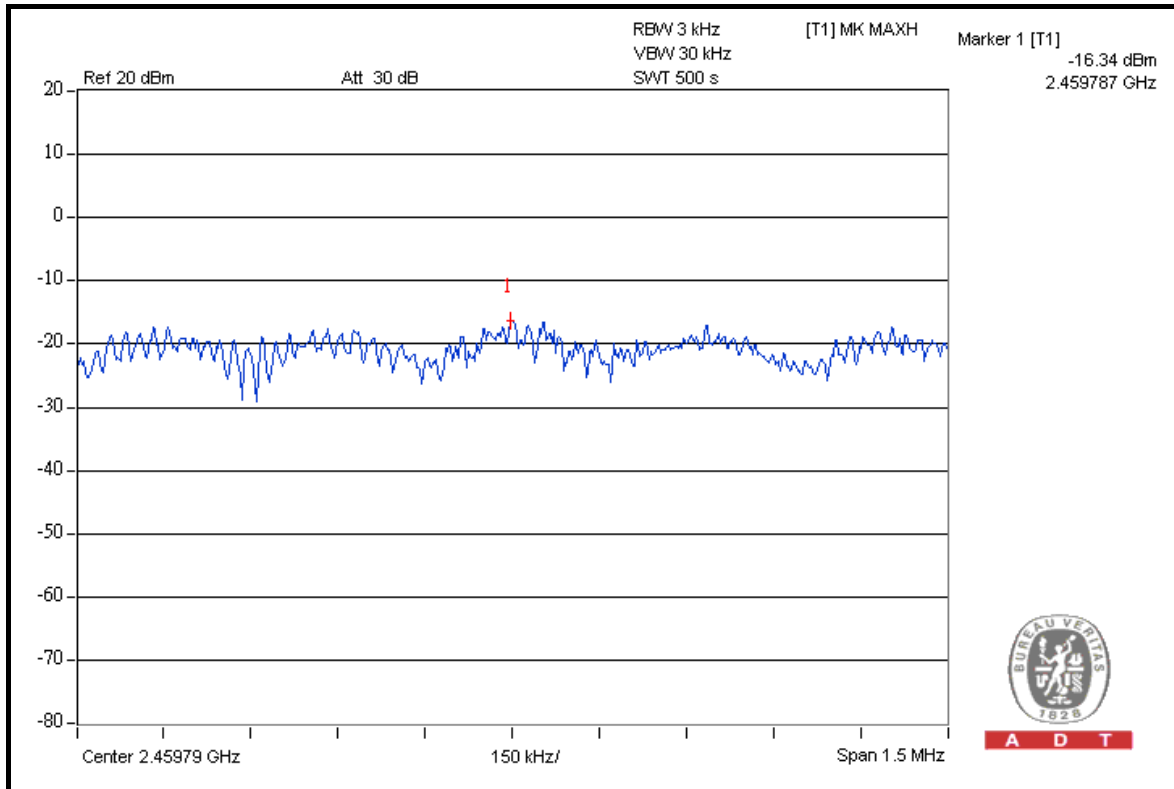

FOR CHAIN 1: CH 1

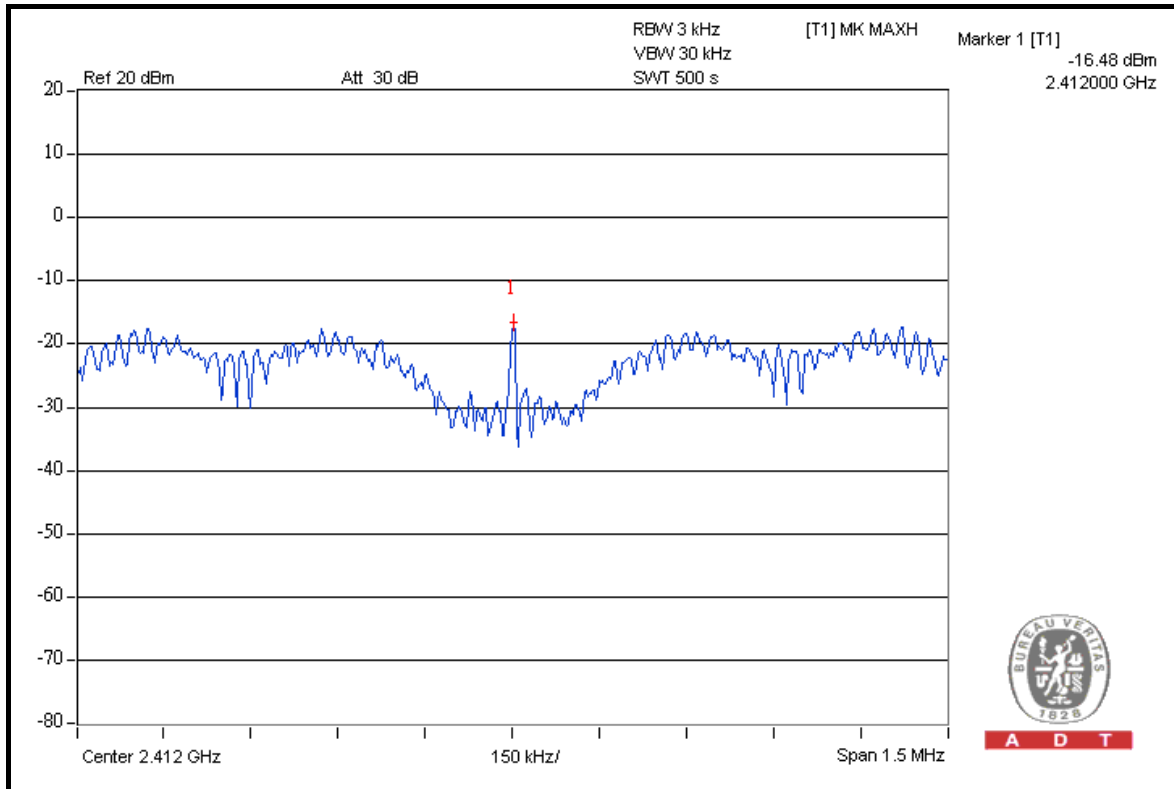



A D T

CH 6

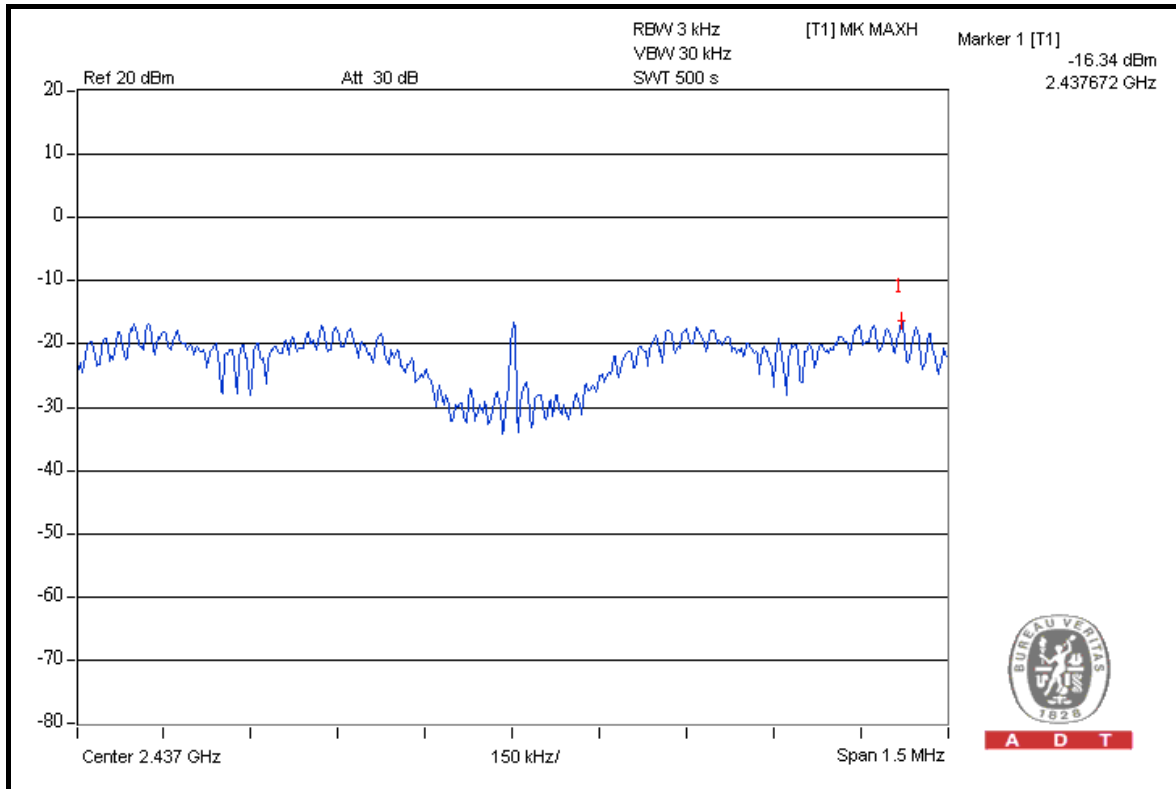

A D T

CH 11

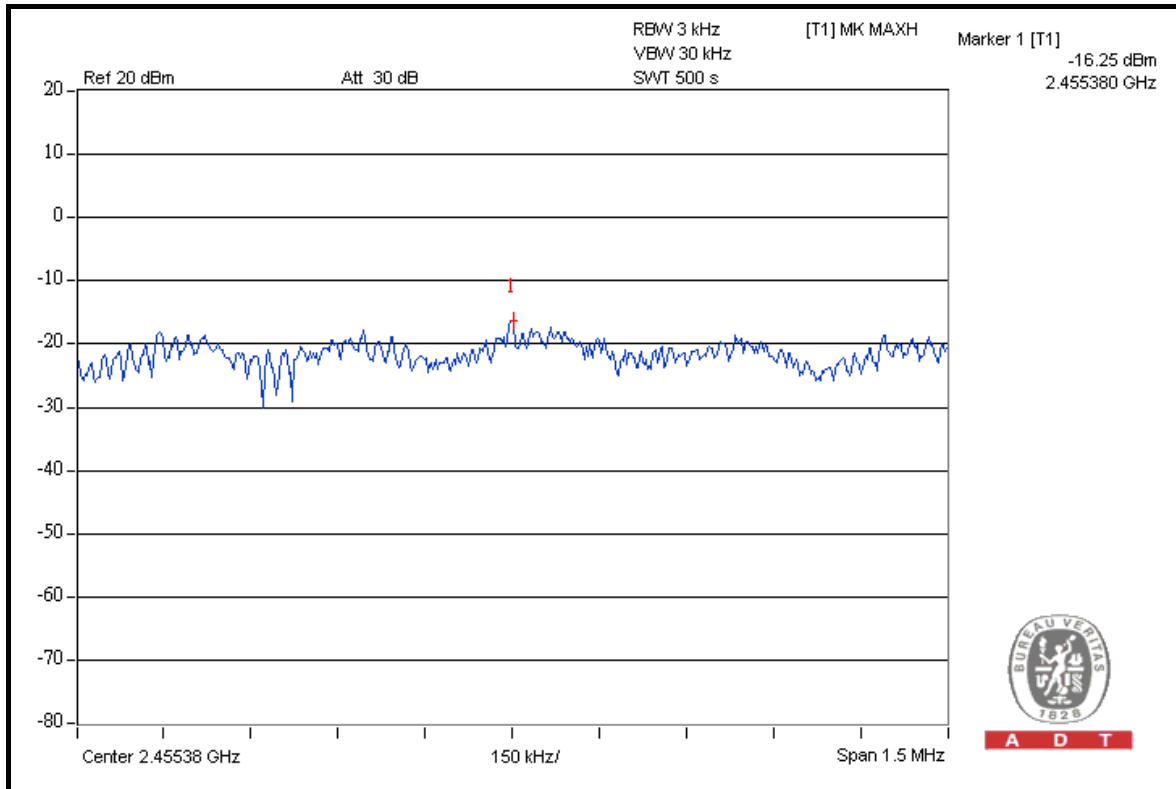

A D T



A D T

DRAFT 802.11n (40MHz) OFDM MODULATION

MODULATION TYPE	BPSK	TRANSFER RATE	15.0Mbps
INPUT POWER	120Vac, 60Hz	ENVIRONMENTAL CONDITIONS	25 deg.C, 65%RH, 1009hPa
TESTED BY	Match Tsui		

CHAN.	CHAN. FREQ. (MHz)	RF POWER LEVEL IN 3kHz BW (dBm)		TOTAL POWER DENSITY (mW)	TOTAL POWER DENSITY (dBm)	MAX. LIMIT (dBm)	PASS / FAIL
		CHAIN 0	CHAIN 1				
1	2422	-18.13	-18.86	0.028	-15.47	8	PASS
4	2437	-17.92	-18.72	0.030	-15.29	8	PASS
7	2452	-17.99	-18.66	0.029	-15.30	8	PASS



A D T

FOR CHAIN 0: CH 1

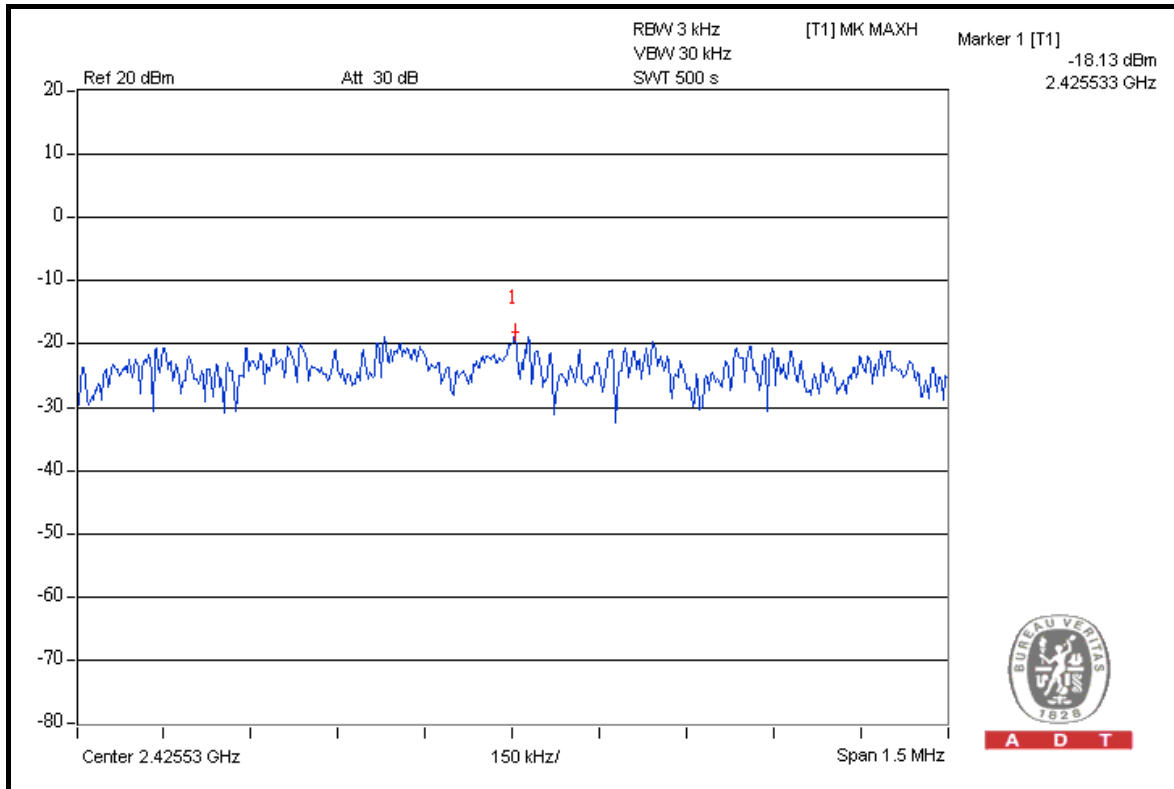

A D T

CH 4

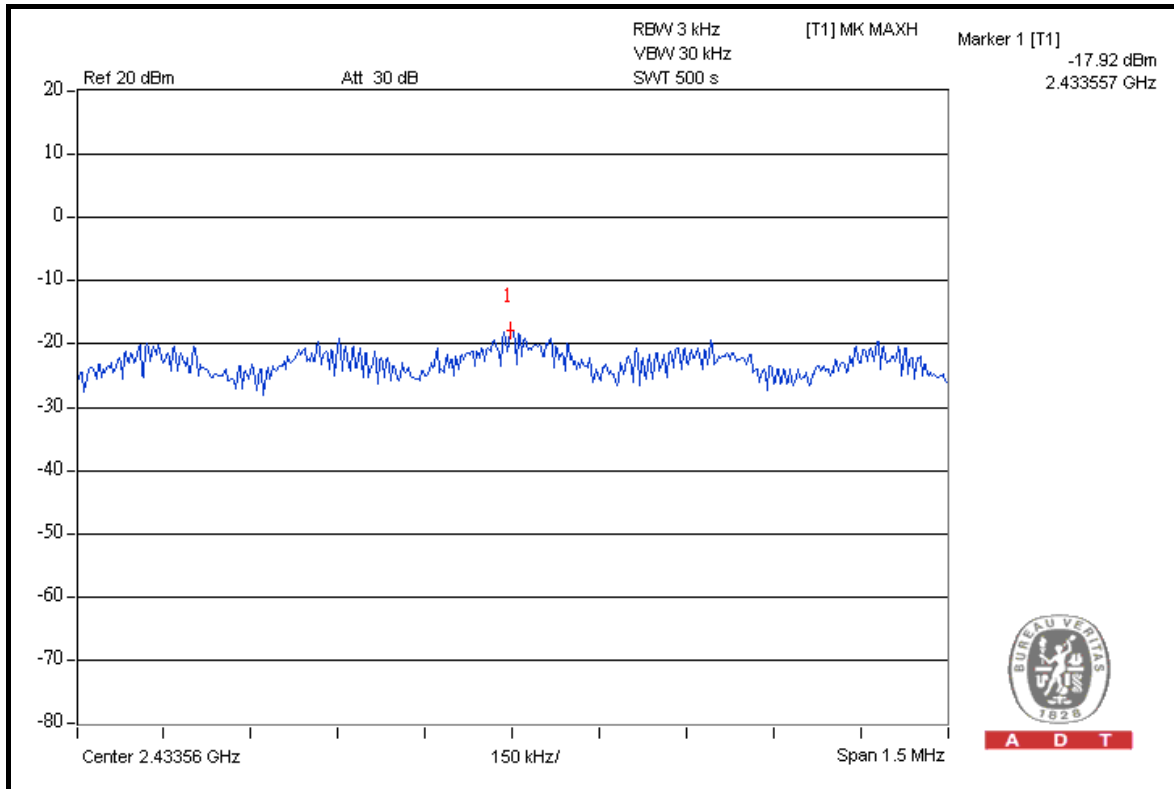

A D T



A D T

CH 7

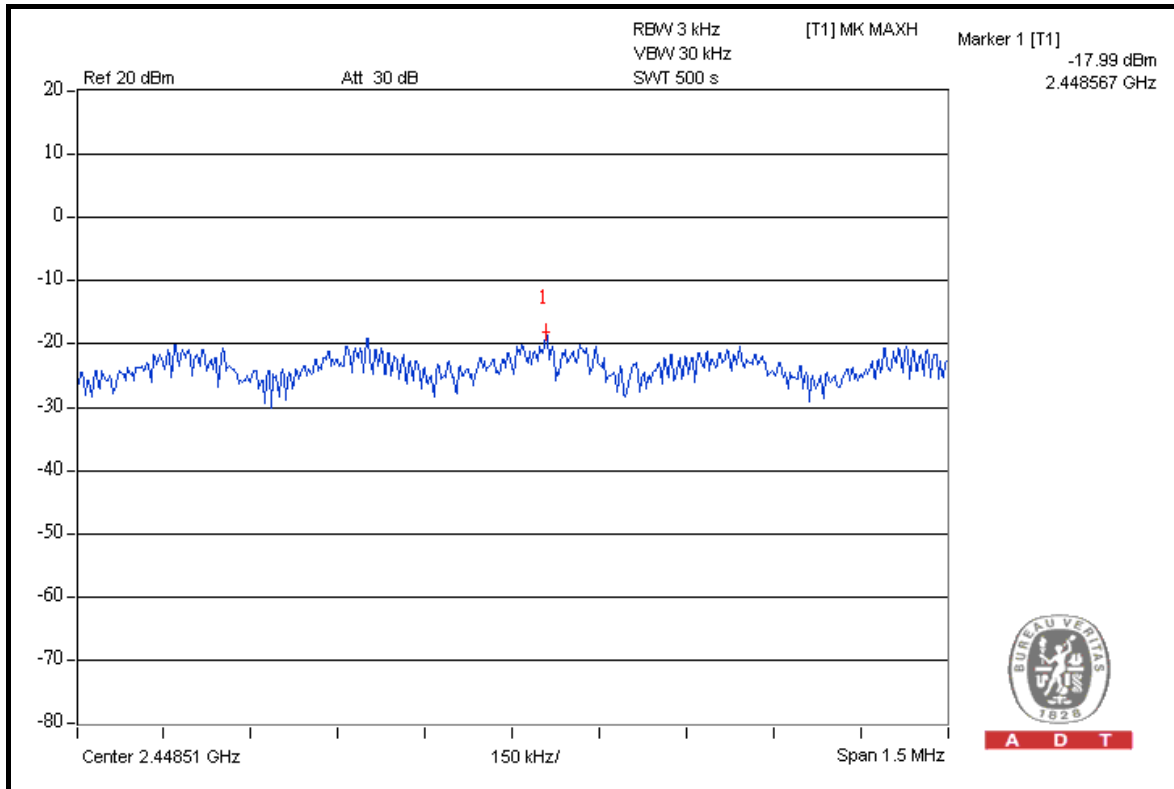

FOR CHAIN 1: CH 1

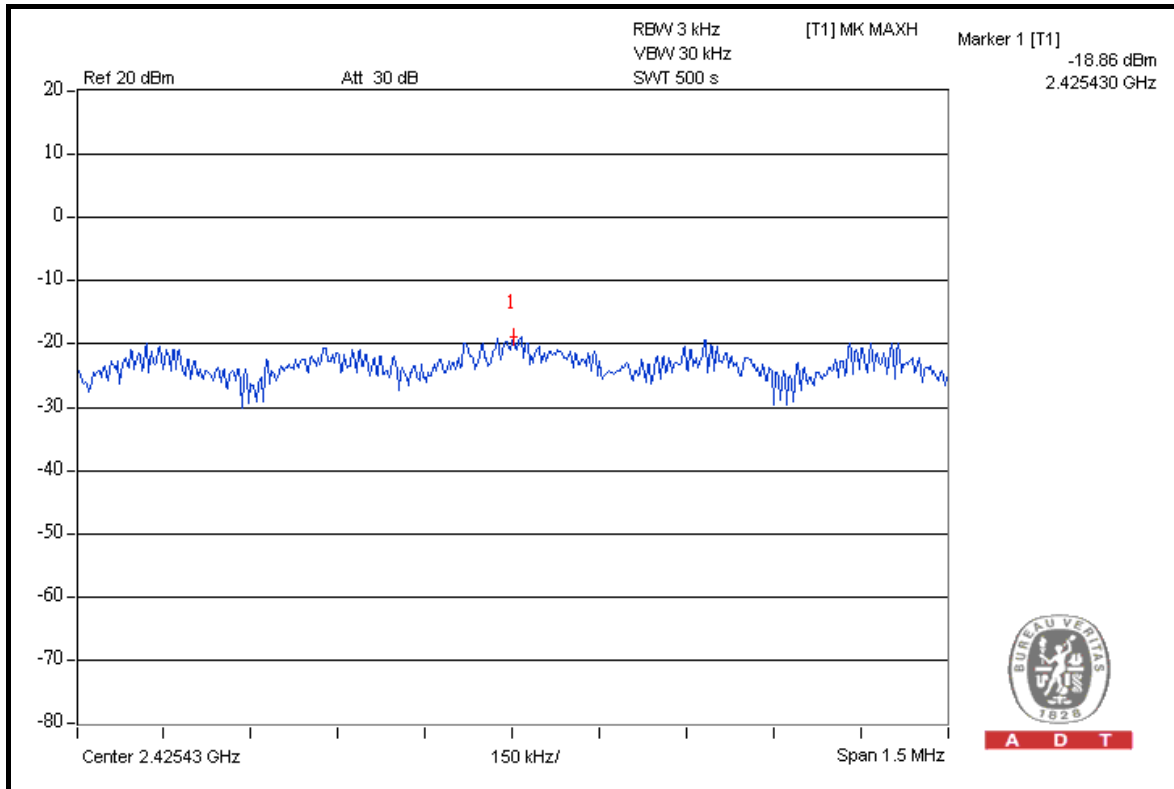



A D T

CH 4

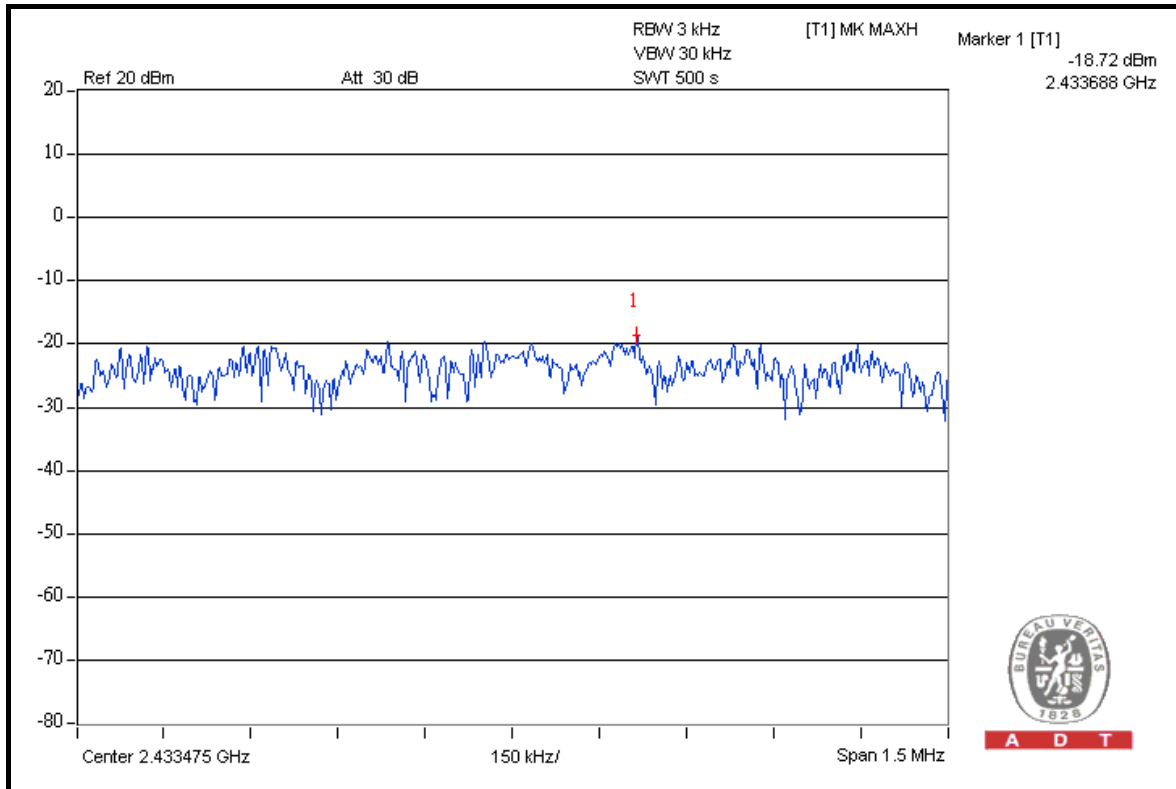

A D T

CH 7

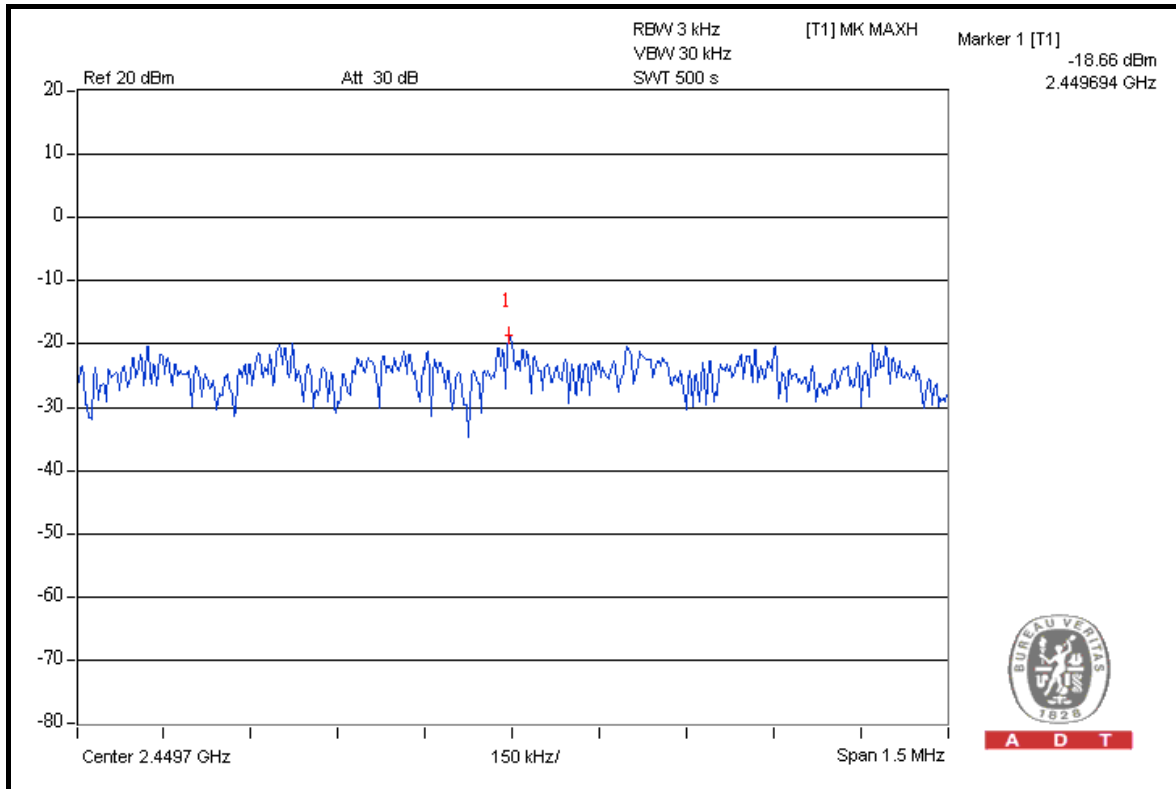

A D T



A D T

4.6 BAND EDGES MEASUREMENT

4.6.1 LIMITS OF BAND EDGES MEASUREMENT

Below -20dB of the highest emission level of operating band (in 100kHz Resolution Bandwidth).

4.6.2 TEST INSTRUMENTS

DESCRIPTION & MANUFACTURER	MODEL NO.	SERIAL NO.	DATE OF CALIBRATION	DUE DATE OF CALIBRATION
Test Receiver ROHDE & SCHWARZ	ESIB7	100212	May 25, 2009	May 24, 2010
Spectrum Analyzer ROHDE & SCHWARZ	FSP40	100269	Aug. 08, 2008	Aug. 07, 2009
BILOG Antenna SCHWARZBECK	VULB9168	9168-156	Apr. 30, 2009	Apr. 29, 2010
HORN Antenna SCHWARZBECK	BBHA 9120 D	9120D-563	Aug. 06, 2008	Aug. 05, 2009
HORN Antenna SCHWARZBECK	BBHA 9170	BBHA9170242	Jan. 06, 2009	Jan. 05, 2010
Preamplifier Agilent	8449B	3008A01911	Sep. 10, 2008	Sep. 09, 2009
Preamplifier Agilent	8447D	2944A10638	Dec. 26, 2008	Dec. 25, 2009
RF signal cable HUBER+SUHNNER	SUCOFLEX 104	218190/4 231241/4	May 13, 2009	May 12, 2010
RF signal cable Worken	8D-FB	Cable-HYCH9-01	Aug. 09, 2008	Aug. 08, 2009
Software	ADT_Radiated_ V7.6.15.9.2	NA	NA	NA
Antenna Tower EMCO	2070/2080	512.835.4684	NA	NA
Turn Table EMCO	2087-2.03	NA	NA	NA
Antenna Tower & Turn Table Controller EMCO	2090	NA	NA	NA

NOTE: The calibration interval of the above test instruments is 12 months and the calibrations are traceable to NML/ROC and NIST/USA.



4.6.3 TEST PROCEDURE

- a. The EUT was placed on the top of a rotating table 0.8 meters above the ground at a 3 meter semi-anechoic chamber. The table was rotated 360 degrees to determine the position of the highest radiation.
- b. The EUT was set 3 meters away from the interference-receiving antenna, which was mounted on the top of a variable-height antenna tower.
- c. The antenna is a broadband antenna, and its height is varied from one meter to four meters above the ground to determine the maximum value of the field strength. Both horizontal and vertical polarizations of the antenna are set to make the measurement.
- d. For each suspected emission, the EUT was arranged to its worst case and then the antenna was tuned to heights from 1 meter to 4 meters and the rotatable table was turned from 0 degrees to 360 degrees to find the maximum reading.
- e. Set both RBW and VBW of spectrum analyzer to 100kHz and 300kHz with suitable frequency span including 100MHz bandwidth from band edge. The band edges was measured and recorded.

The spectrum plots (Peak RBW = 100kHz, VBW = 300kHz) are attached on the following pages.

NOTE: The resolution bandwidth of test receiver/spectrum analyzer is 1MHz and the video bandwidth is 10Hz for Average detection (AV) at frequency above 1GHz.

4.6.4 DEVIATION FROM TEST STANDARD

No deviation.

4.6.5 EUT OPERATING CONDITION

Same as Item 4.3.6.

4.6.6 TEST RESULTS

The spectrum plots are attached on the following pages. D1 line indicates the highest level, and D2 line indicates the 20dB offset below D1. It shows compliance with the requirement in part 15.247(d).

802.11b DSSS MODULATION

NOTE 1: The band edge emission plot on the next page shows 50.53dBuV between carrier maximum power and local maximum emission in restrict band (2.3900GHz). The emission of carrier strength list in the test result of channel 1 at the item 4.1.7 is 109.70dBuV/m (Peak), so the maximum field strength in restrict band is $109.70 - 50.53 = 59.17$ dBuV/m which is under 74dBuV/m limit.

The band edge emission plot of on the next page shows 53.69dBuV between carrier maximum power and local maximum emission in restrict band (2.3900GHz). The emission of carrier strength list in the test result of channel 1 at the item 4.1.7 is 105.51dBuV/m (Average), so the maximum field strength in restrict band is $105.51 - 53.69 = 51.82$ dBuV/m which is under 54dBuV/m limit.

NOTE 2: The band edge emission plot on the next second page shows 53.24dBuV between carrier maximum power and local maximum emission in restrict band (2.4882GHz). The emission of carrier strength list in the test result of channel 11 at the item 4.1.7 is 109.85dBuV/m (Peak), so the maximum field strength in restrict band is $109.85 - 53.24 = 56.61$ dBuV/m which is under 74dBuV/m limit.

The band edge emission plot on the next third page shows 58.71dBuV between carrier maximum power and local maximum emission in restrict band (2.4876GHz). The emission of carrier strength list in the test result of channel 11 at the item 4.1.7 is 105.80dBuV/m (Average), so the maximum field strength in restrict band is $105.80 - 58.71 = 47.09$ dBuV/m which is under 54dBuV/m limit.



A D T

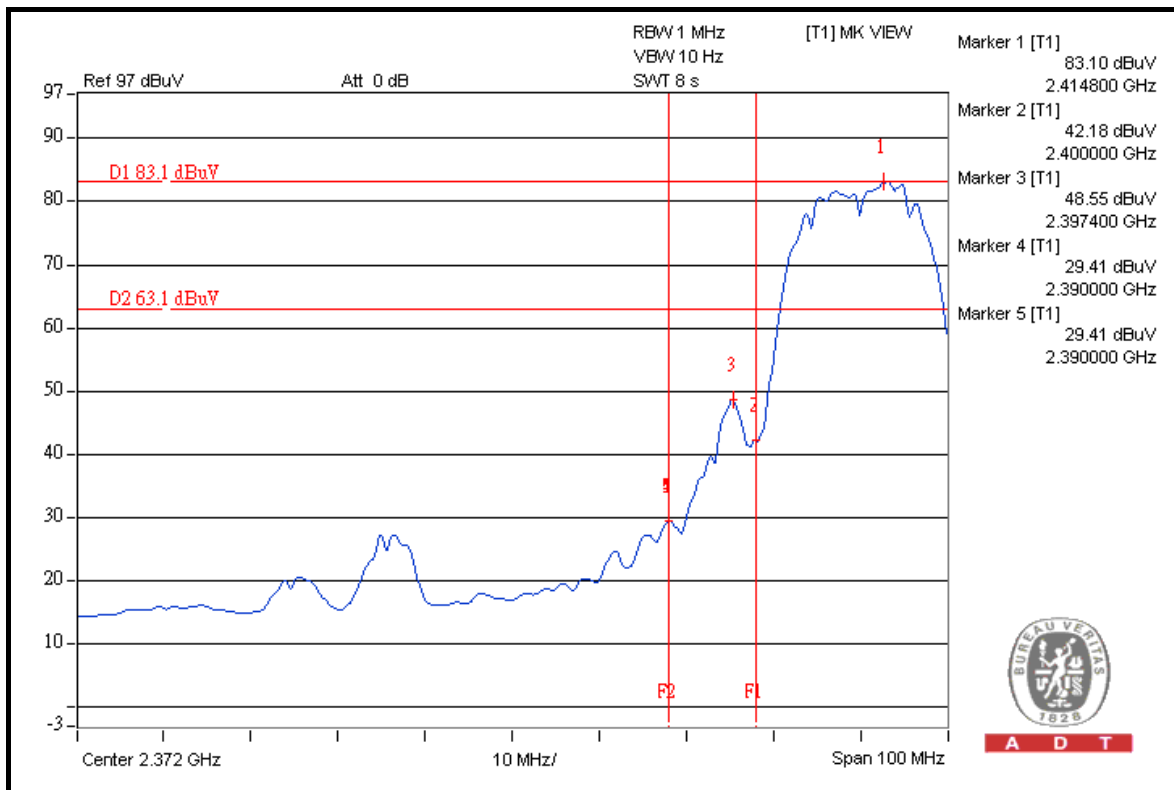
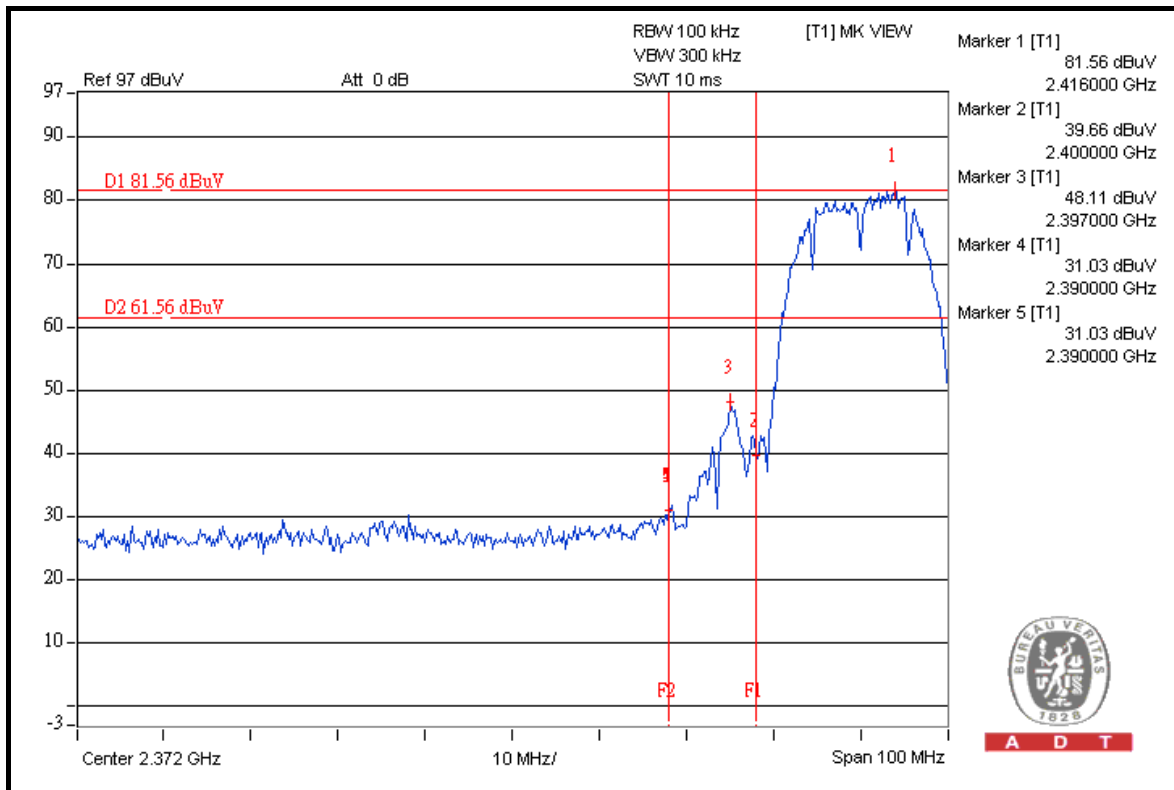



A D T

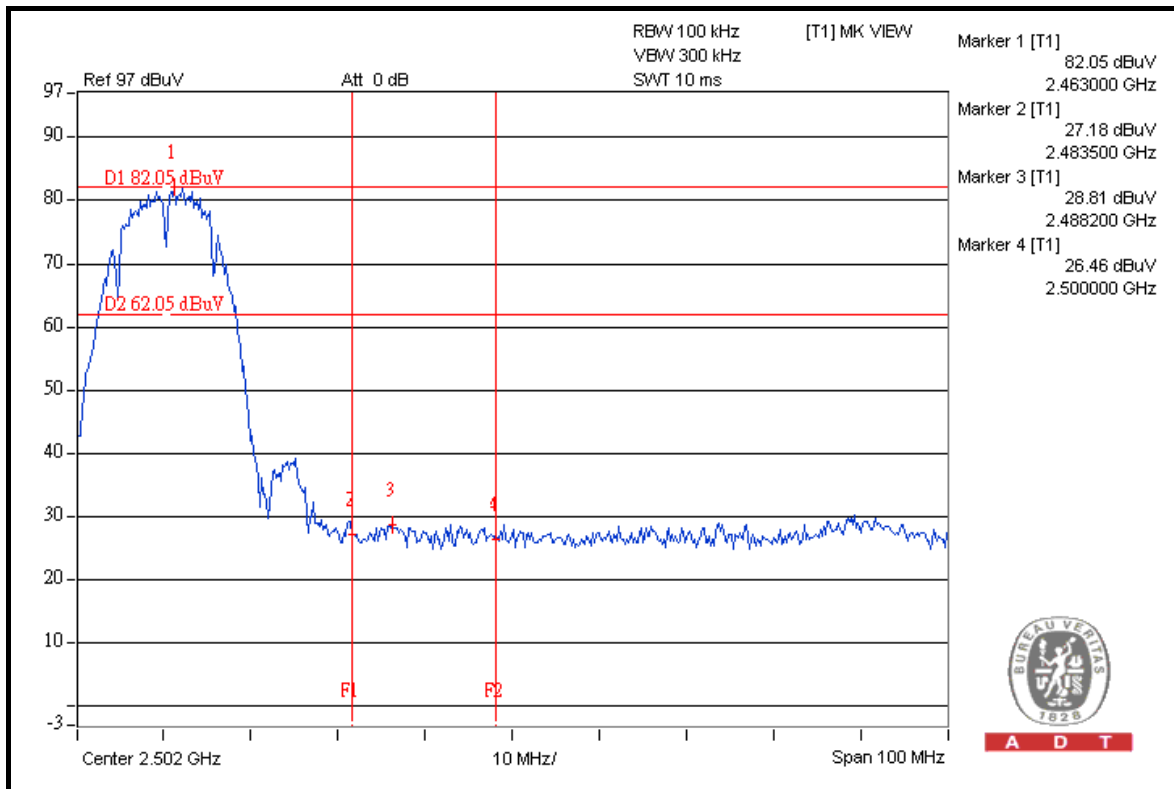
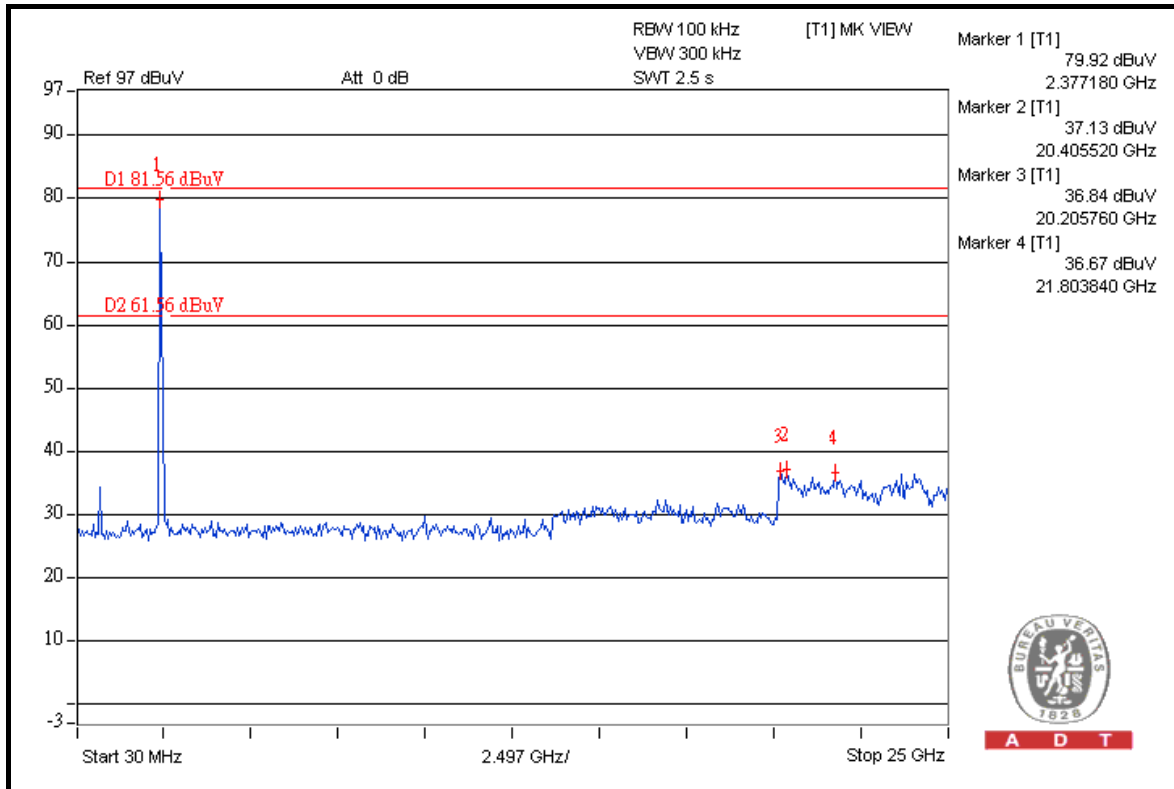



A D T

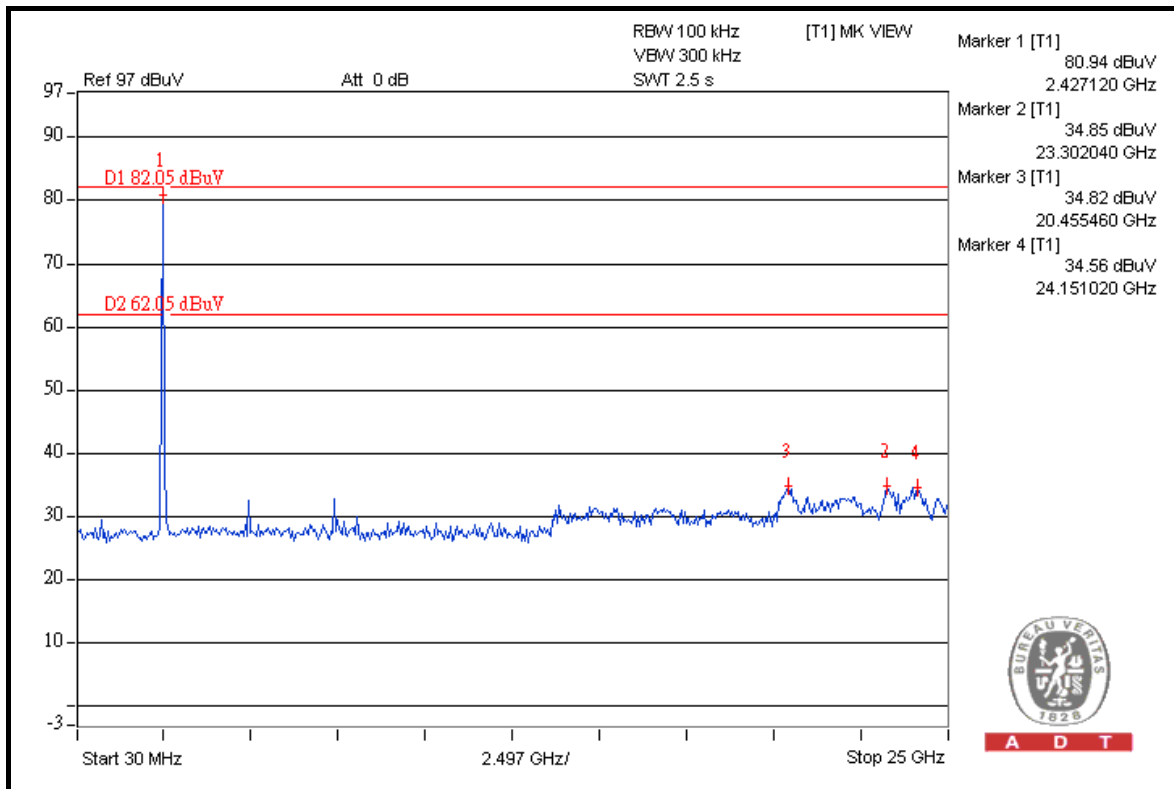
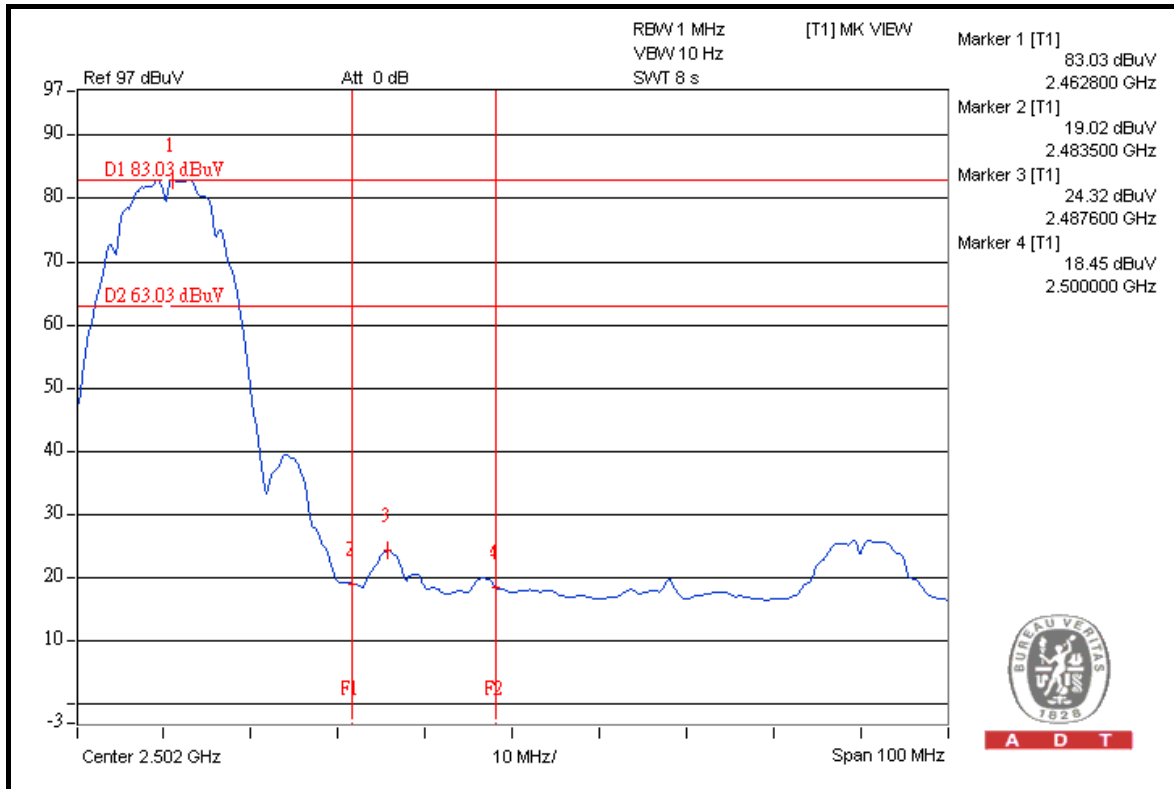



802.11g OFDM MODULATION

NOTE 1: The band edge emission plot on the next page shows 46.85dBuV between carrier maximum power and local maximum emission in restrict band (2.3562GHz). The emission of carrier strength list in the test result of channel 1 at the item 4.1.7 is 110.63dBuV/m (Peak), so the maximum field strength in restrict band is $110.63 - 46.85 = 63.78$ dBuV/m which is under 74dBuV/m limit.

The band edge emission plot of on the next page shows 54.28dBuV between carrier maximum power and local maximum emission in restrict band (2.3900GHz). The emission of carrier strength list in the test result of channel 1 at the item 4.1.7 is 100.66dBuV/m (Average), so the maximum field strength in restrict band is $100.66 - 54.28 = 46.38$ dBuV/m which is under 54dBuV/m limit.

NOTE 2: The band edge emission plot on the next second page shows 46.15dBuV between carrier maximum power and local maximum emission in restrict band (2.4838GHz). The emission of carrier strength list in the test result of channel 11 at the item 4.1.7 is 110.75dBuV/m (Peak), so the maximum field strength in restrict band is $110.75 - 46.15 = 64.60$ dBuV/m which is under 74dBuV/m limit.

The band edge emission plot on the next third page shows 51.87dBuV between carrier maximum power and local maximum emission in restrict band (2.4835GHz). The emission of carrier strength list in the test result of channel 11 at the item 4.1.7 is 100.85dBuV/m (Average), so the maximum field strength in restrict band is $100.85 - 51.87 = 48.98$ dBuV/m which is under 54dBuV/m limit.



A D T

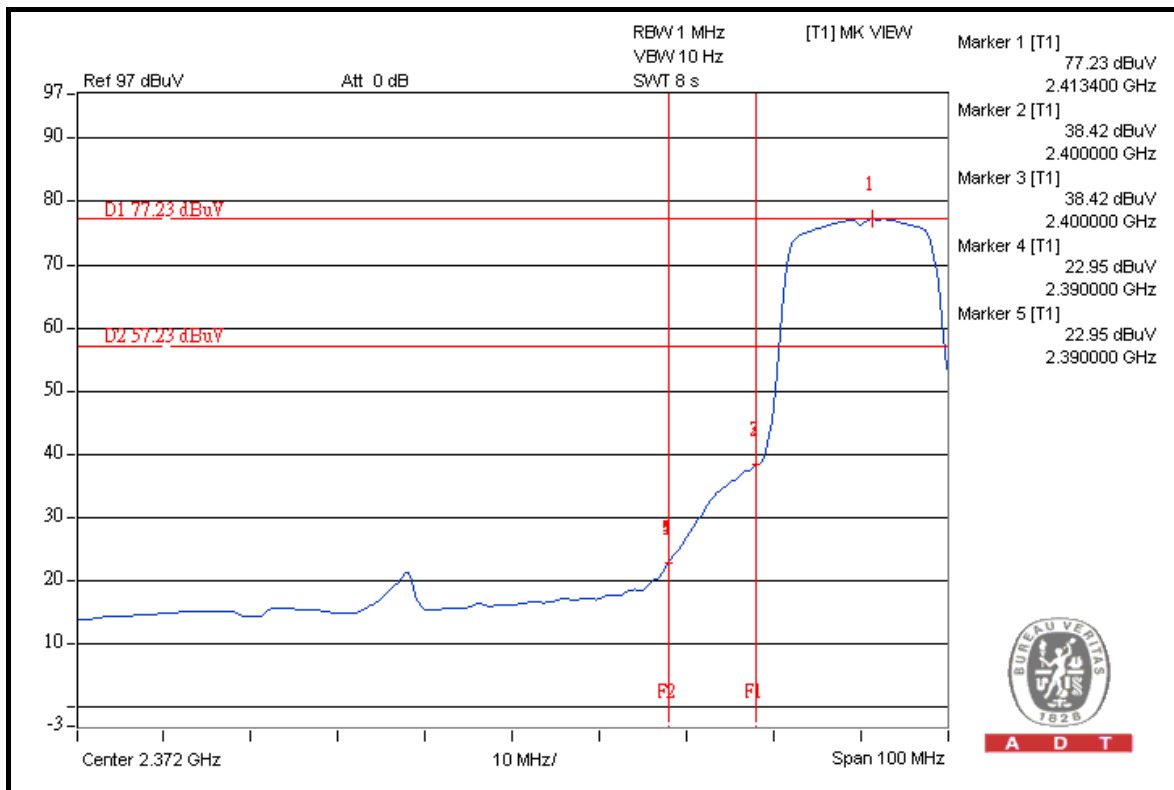
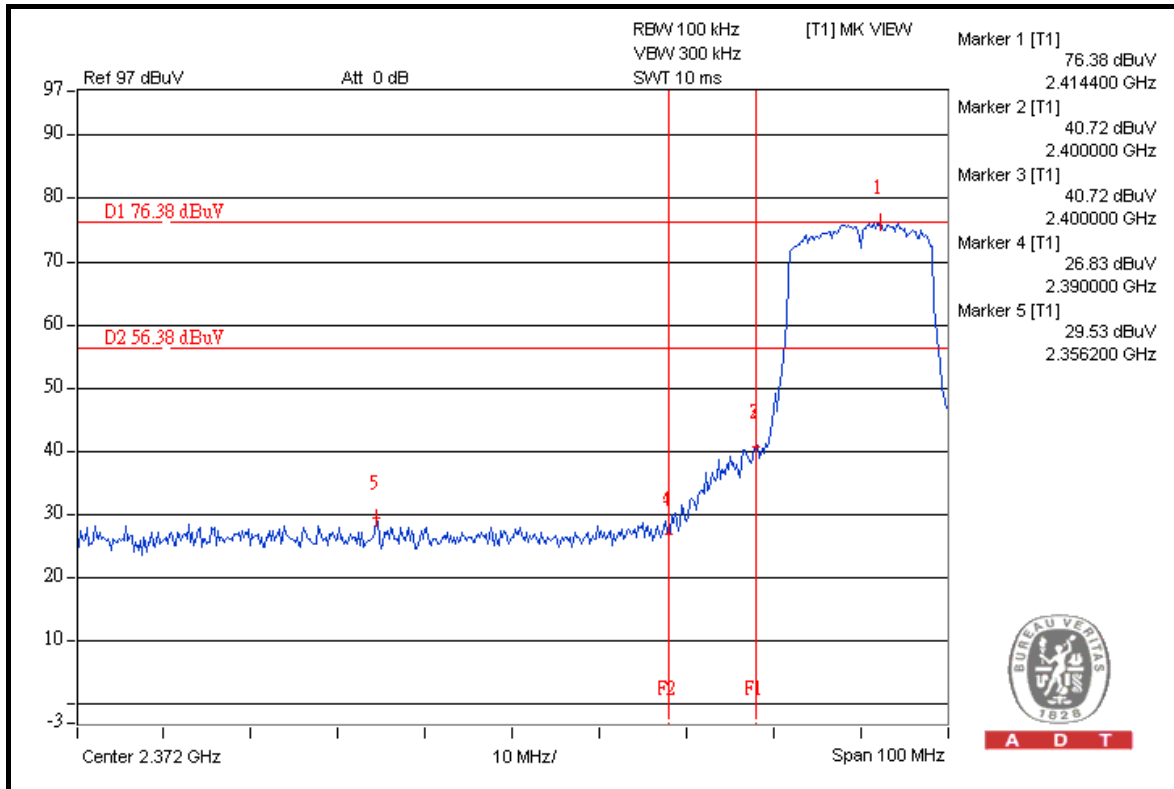



A D T

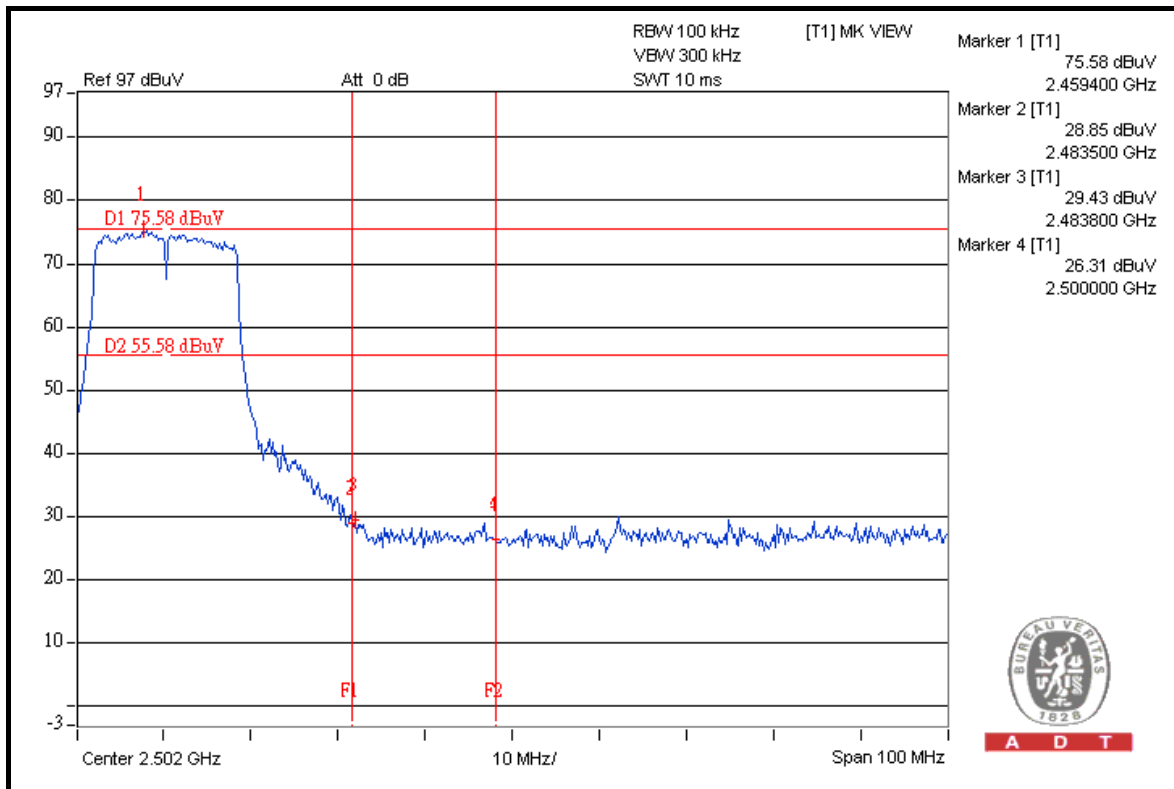
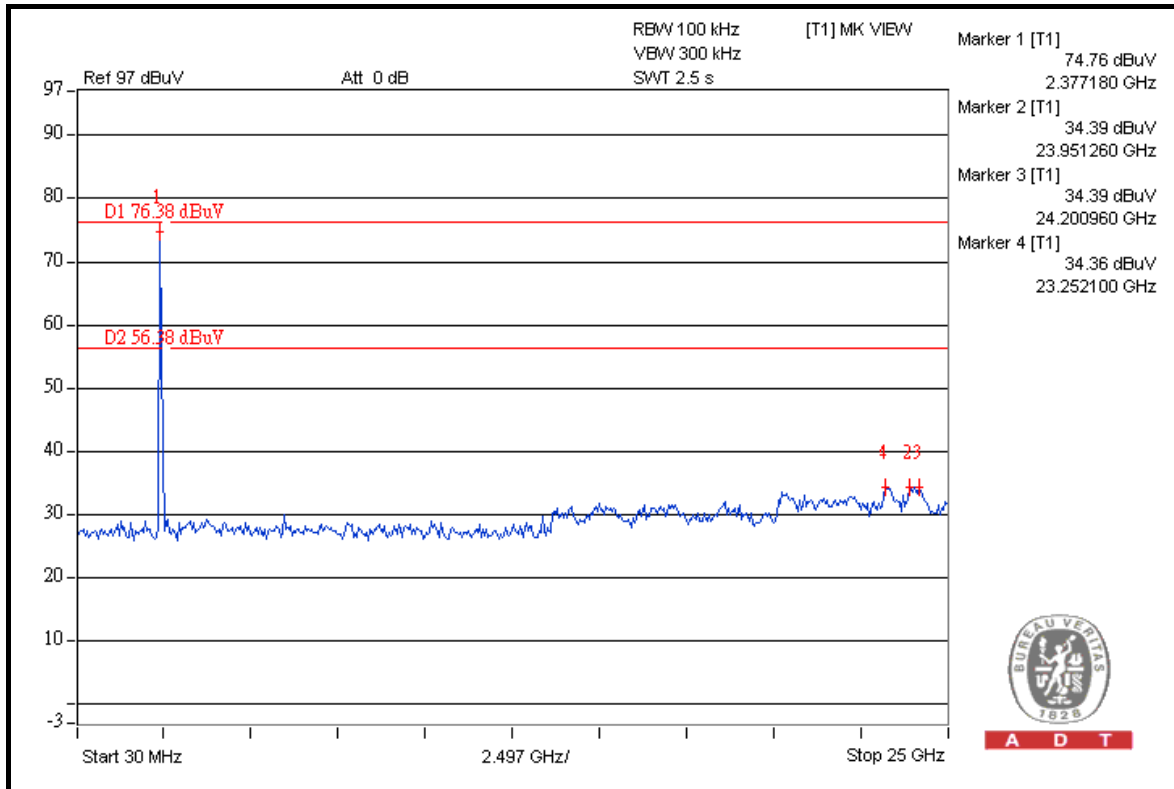



A D T

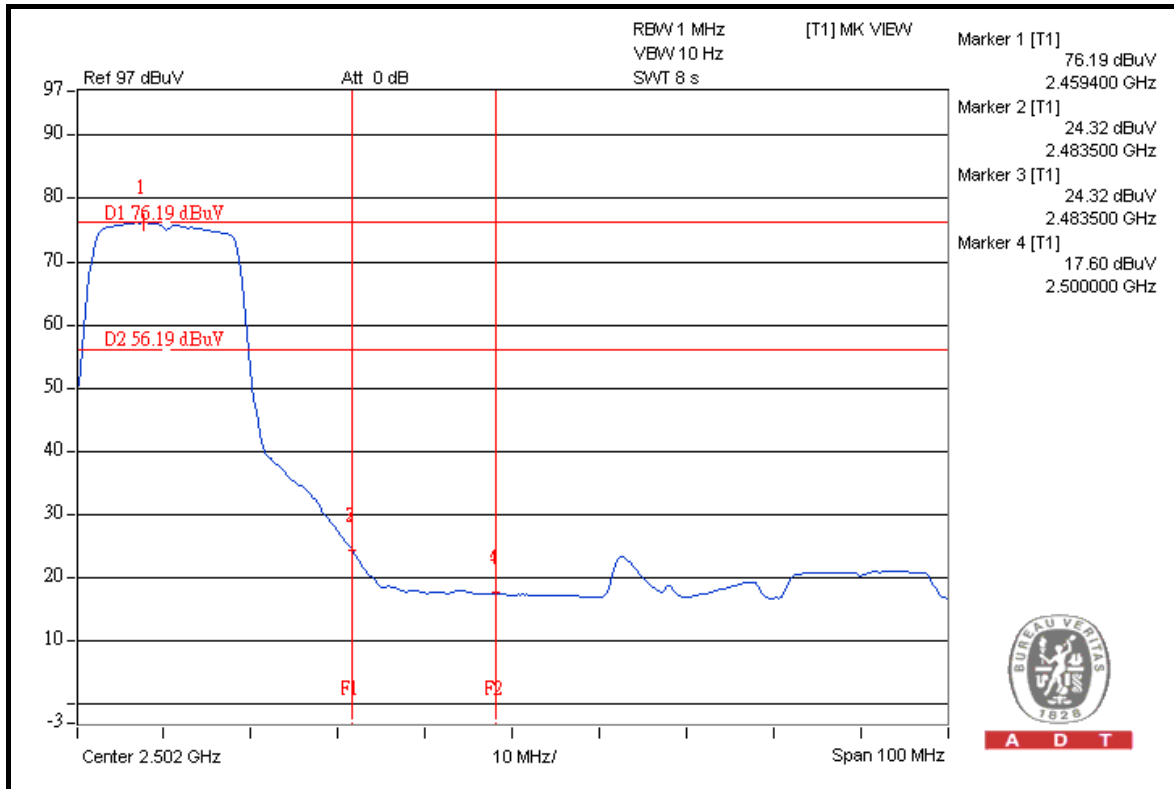

A D T

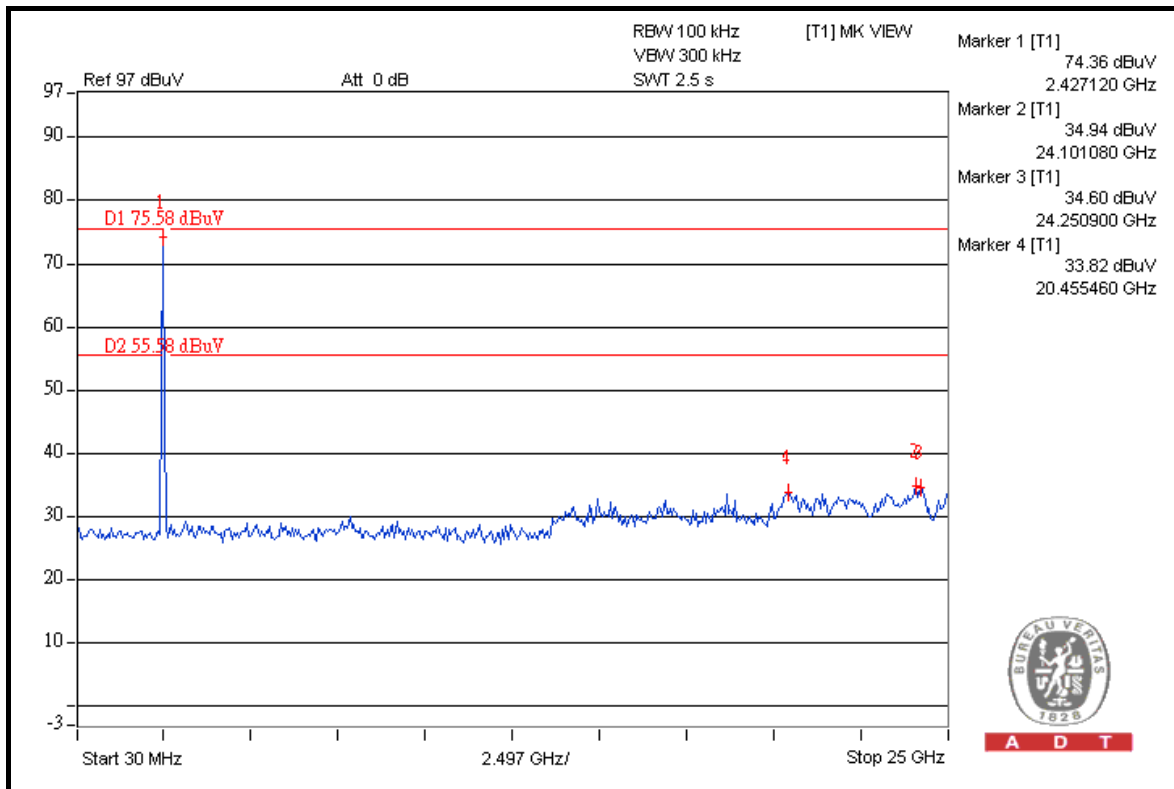

A D T



DRAFT 802.11n (20MHz) OFDM MODULATION

NOTE 1: The band edge emission plot on the next page shows 46.05dBuV between carrier maximum power and local maximum emission in restrict band (2.3600GHz). The emission of carrier strength list in the test result of channel 1 at the item 4.1.7 is 108.10dBuV/m (Peak), so the maximum field strength in restrict band is $108.10 - 46.05 = 62.05$ dBuV/m which is under 74dBuV/m limit.

The band edge emission plot of on the next page shows 52.34dBuV between carrier maximum power and local maximum emission in restrict band (2.3600GHz). The emission of carrier strength list in the test result of channel 1 at the item 4.1.7 is 98.02dBuV/m (Average), so the maximum field strength in restrict band is $98.02 - 52.34 = 45.68$ dBuV/m which is under 54dBuV/m limit.

NOTE 2: The band edge emission plot on the next second page shows 46.58dBuV between carrier maximum power and local maximum emission in restrict band (2.4940GHz). The emission of carrier strength list in the test result of channel 11 at the item 4.1.7 is 108.25dBuV/m (Peak), so the maximum field strength in restrict band is $108.25 - 46.58 = 61.67$ dBuV/m which is under 74dBuV/m limit.

The band edge emission plot on the next third page shows 51.14dBuV between carrier maximum power and local maximum emission in restrict band (2.4835GHz). The emission of carrier strength list in the test result of channel 11 at the item 4.1.7 is 98.16dBuV/m (Average), so the maximum field strength in restrict band is $98.16 - 51.14 = 47.02$ dBuV/m which is under 54dBuV/m limit.



A D T

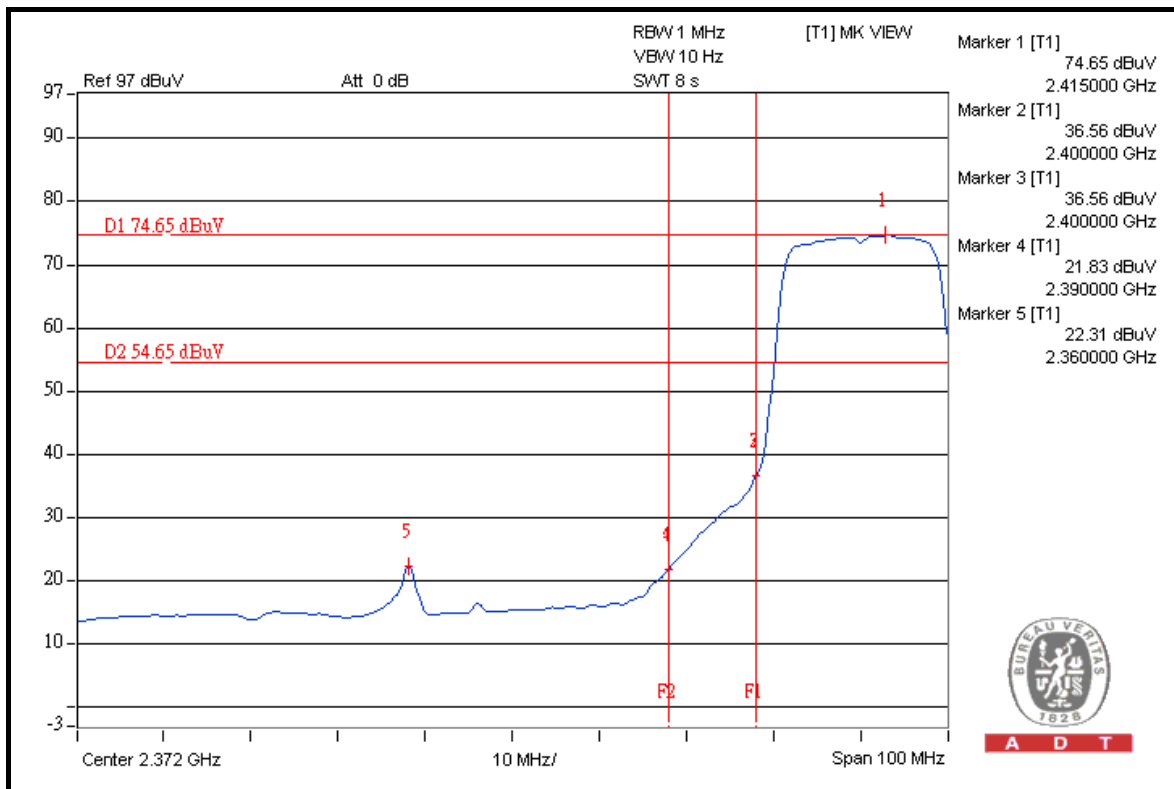
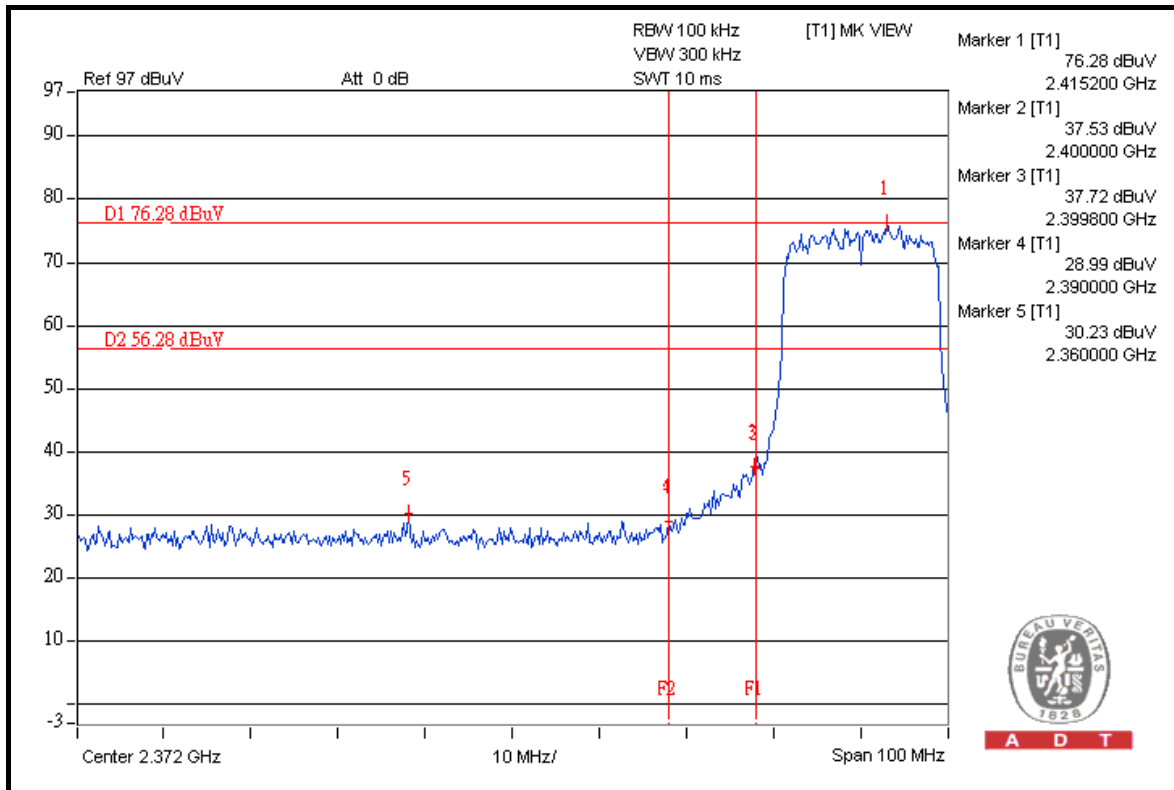



A D T

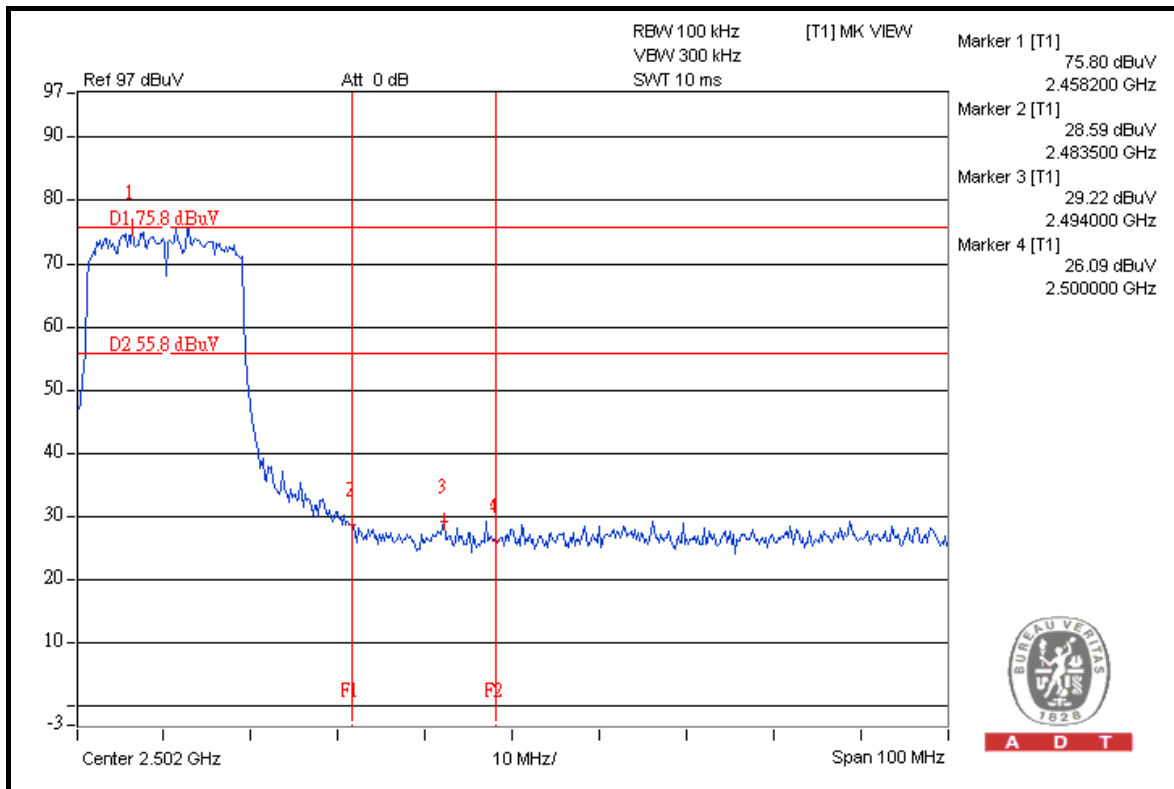
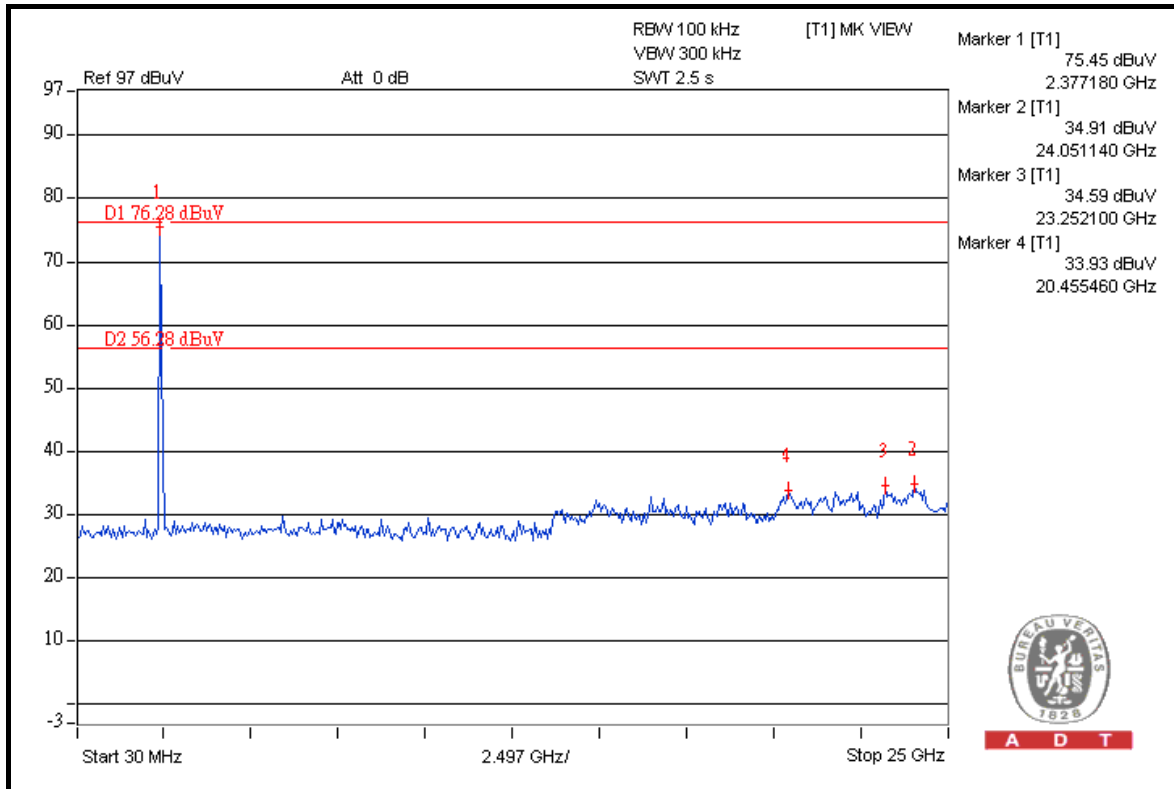



A D T

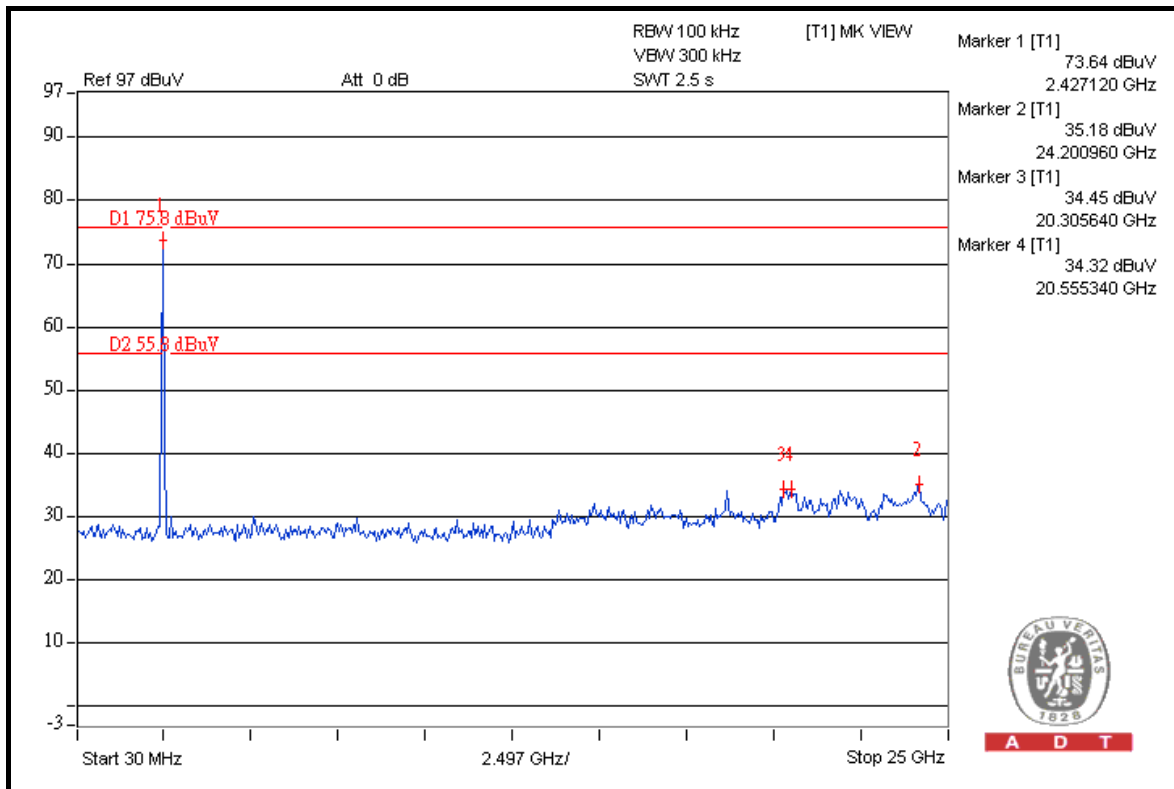
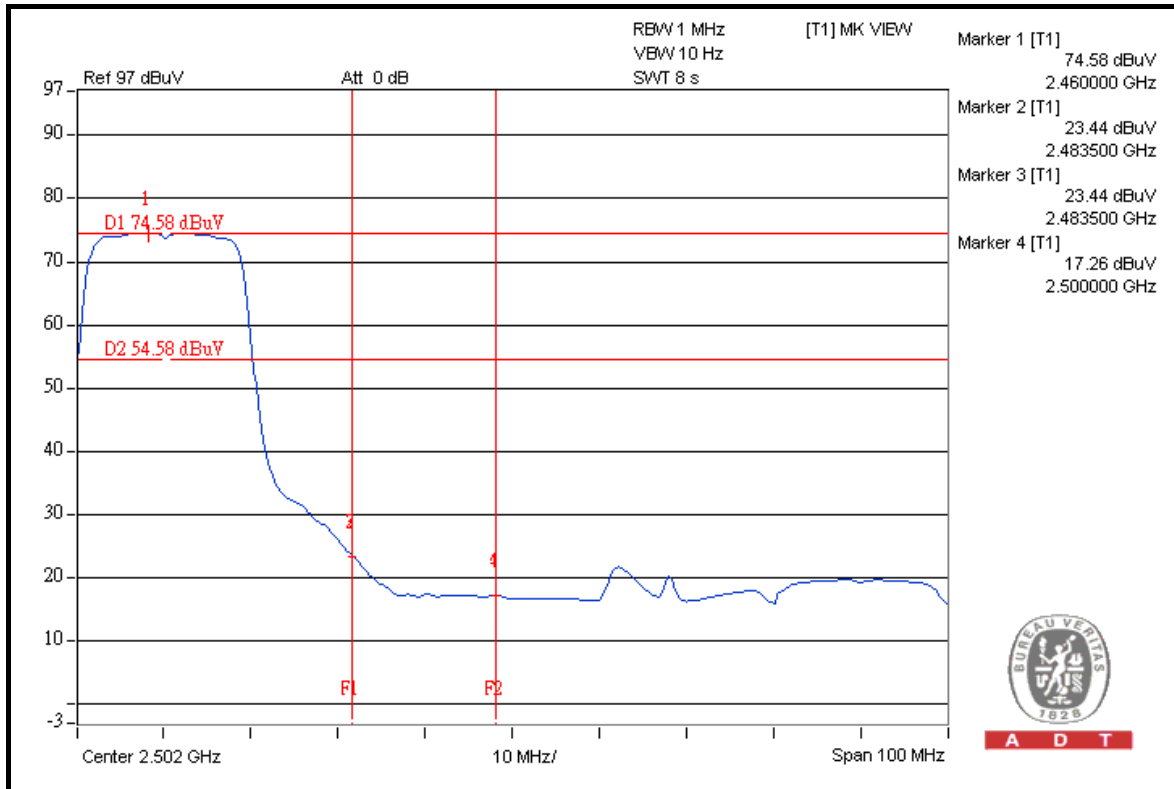



A D T

DRAFT 802.11n (40MHz) OFDM MODULATION

NOTE 1: The band edge emission plot on the next page shows 41.71dBuV between carrier maximum power and local maximum emission in restrict band (2.3896GHz). The emission of carrier strength list in the test result of channel 1 at the item 4.1.7 is 103.43dBuV/m (Peak), so the maximum field strength in restrict band is $103.43 - 41.71 = 61.72$ dBuV/m which is under 74dBuV/m limit.

The band edge emission plot of on the next page shows 45.45dBuV between carrier maximum power and local maximum emission in restrict band (2.3900GHz). The emission of carrier strength list in the test result of channel 1 at the item 4.1.7 is 93.42dBuV/m (Average), so the maximum field strength in restrict band is $93.42 - 45.45 = 47.97$ dBuV/m which is under 54dBuV/m limit.

NOTE 2: The band edge emission plot on the next second page shows 42.09dBuV between carrier maximum power and local maximum emission in restrict band (2.4835GHz). The emission of carrier strength list in the test result of channel 7 at the item 4.1.7 is 103.78dBuV/m (Peak), so the maximum field strength in restrict band is $103.78 - 42.09 = 61.69$ dBuV/m which is under 74dBuV/m limit.

The band edge emission plot on the next third page shows 44.64dBuV between carrier maximum power and local maximum emission in restrict band (2.4835GHz). The emission of carrier strength list in the test result of channel 7 at the item 4.1.7 is 93.72dBuV/m (Average), so the maximum field strength in restrict band is $93.72 - 44.64 = 49.08$ dBuV/m which is under 54dBuV/m limit.



A D T

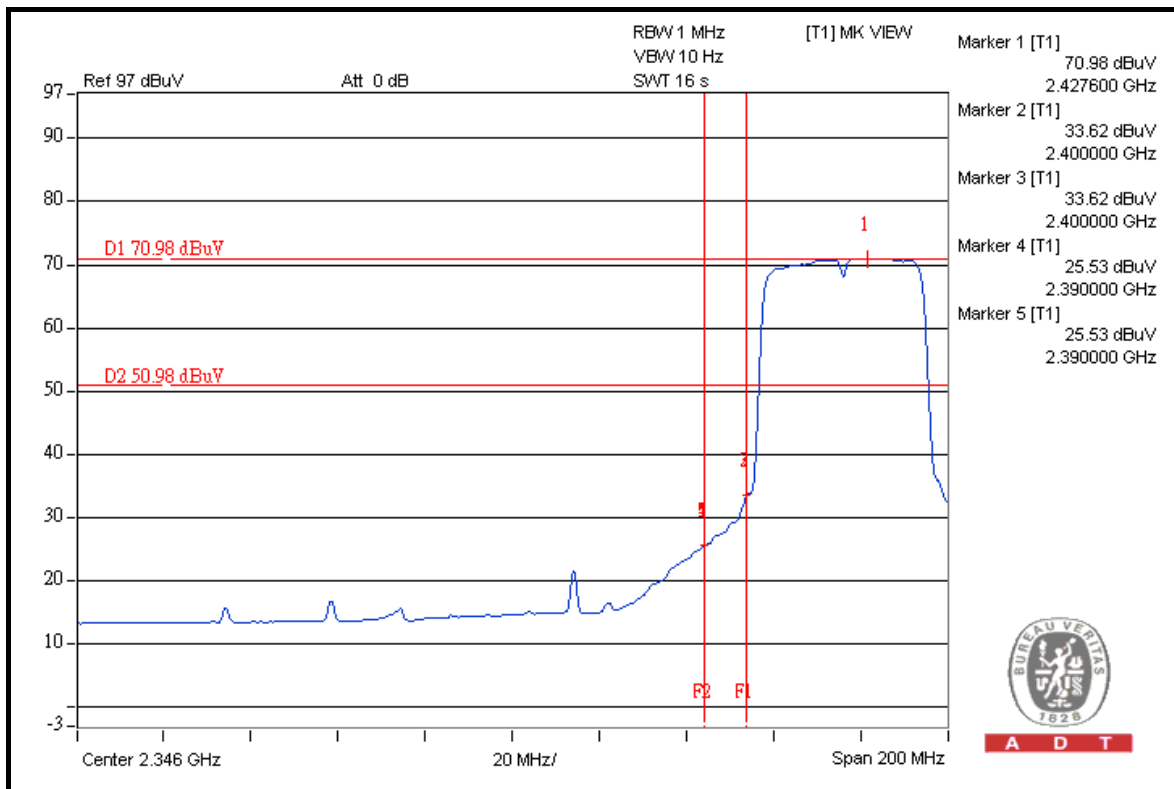
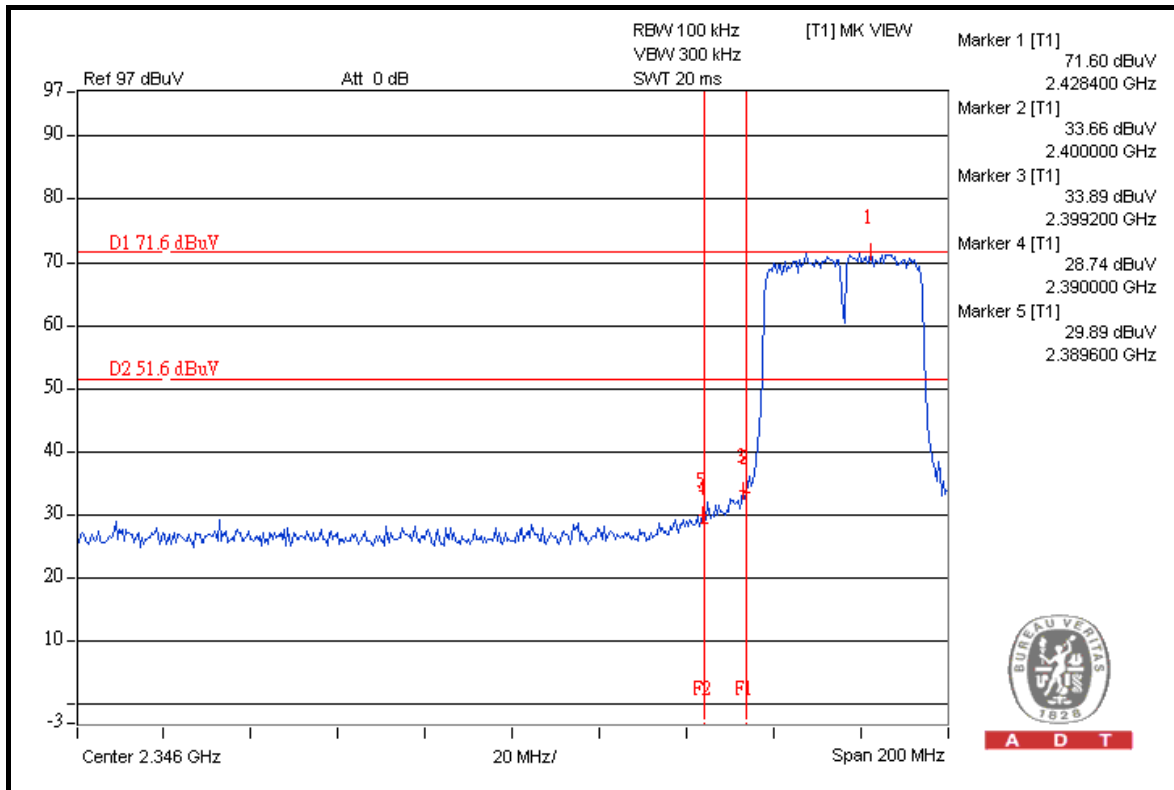



A D T

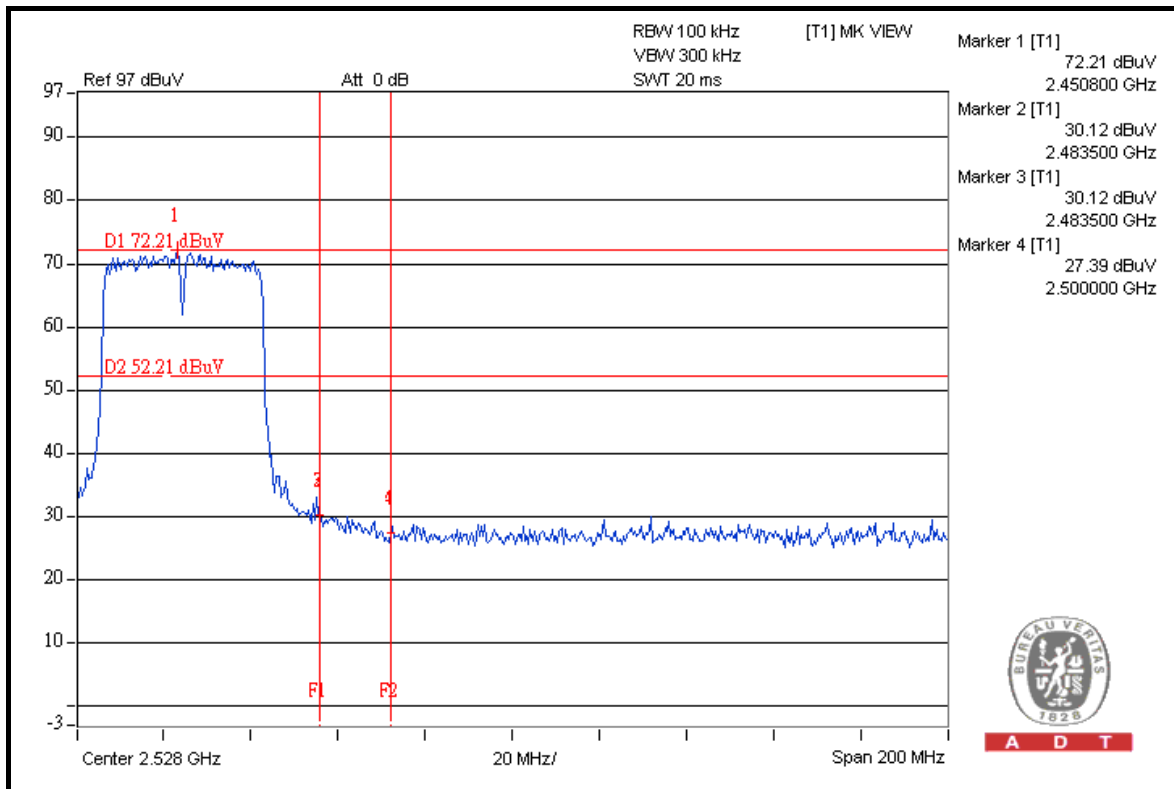
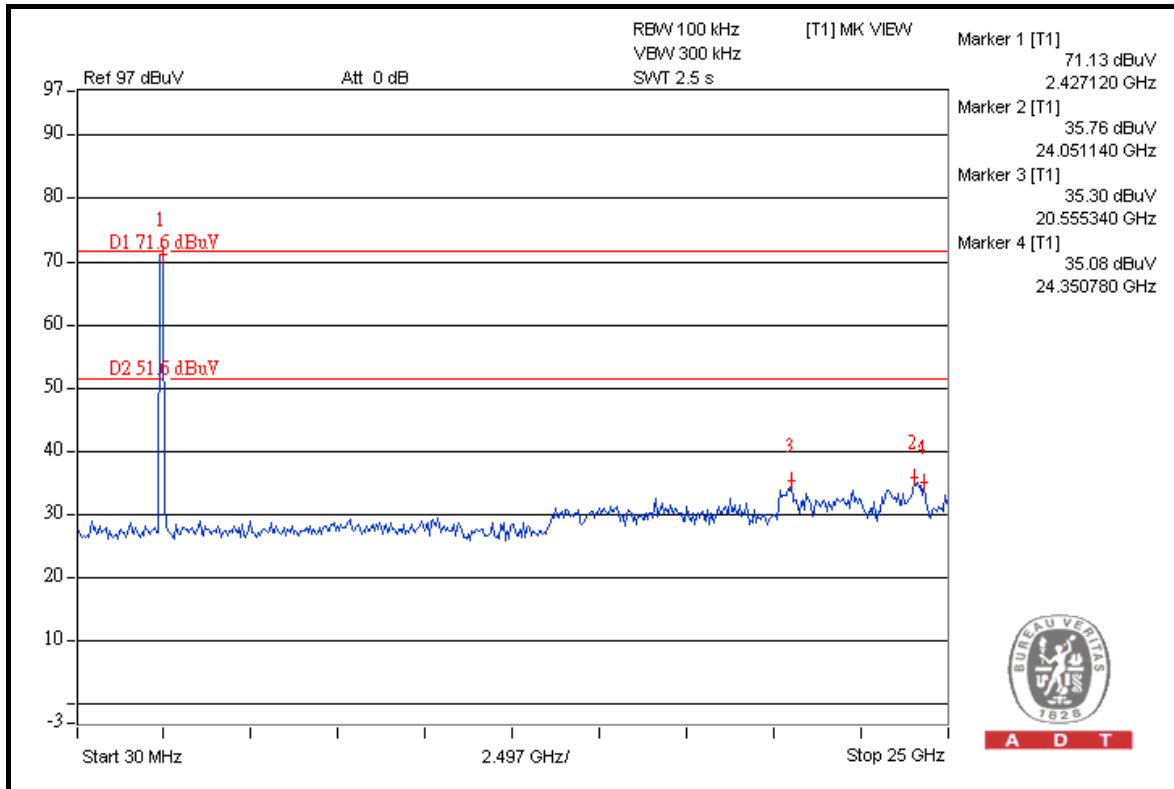



A D T

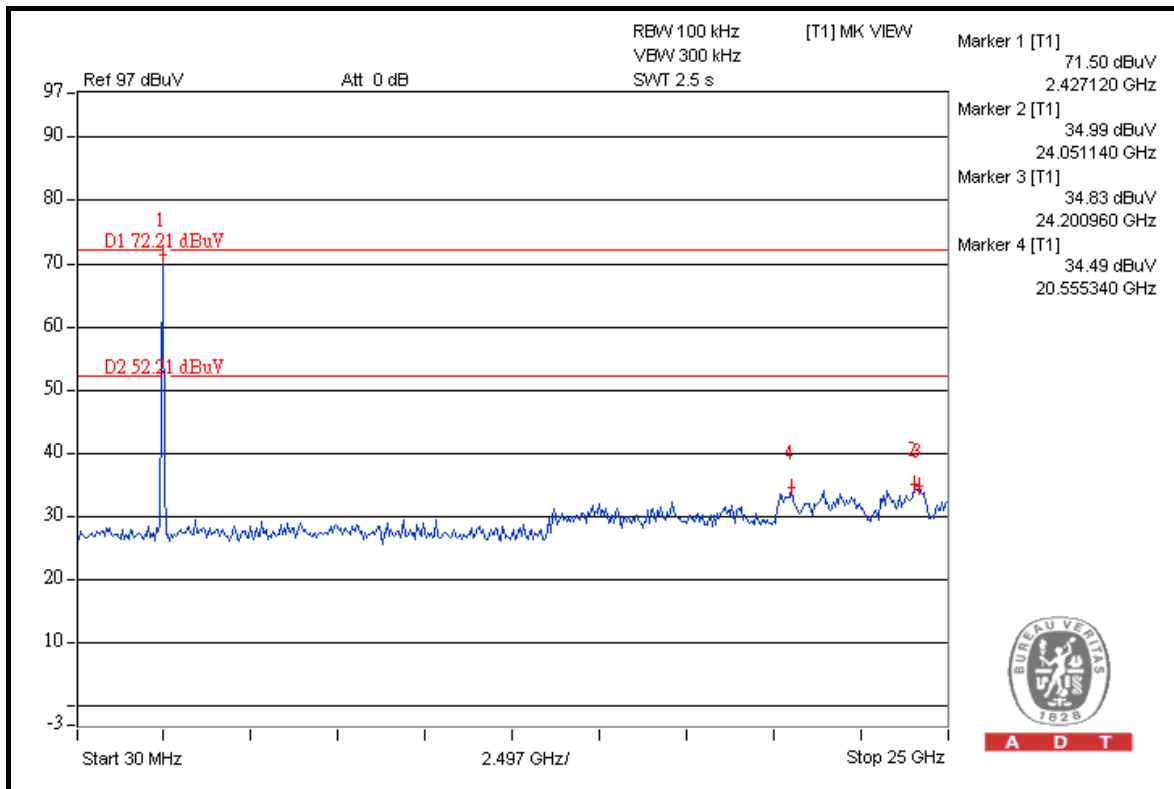
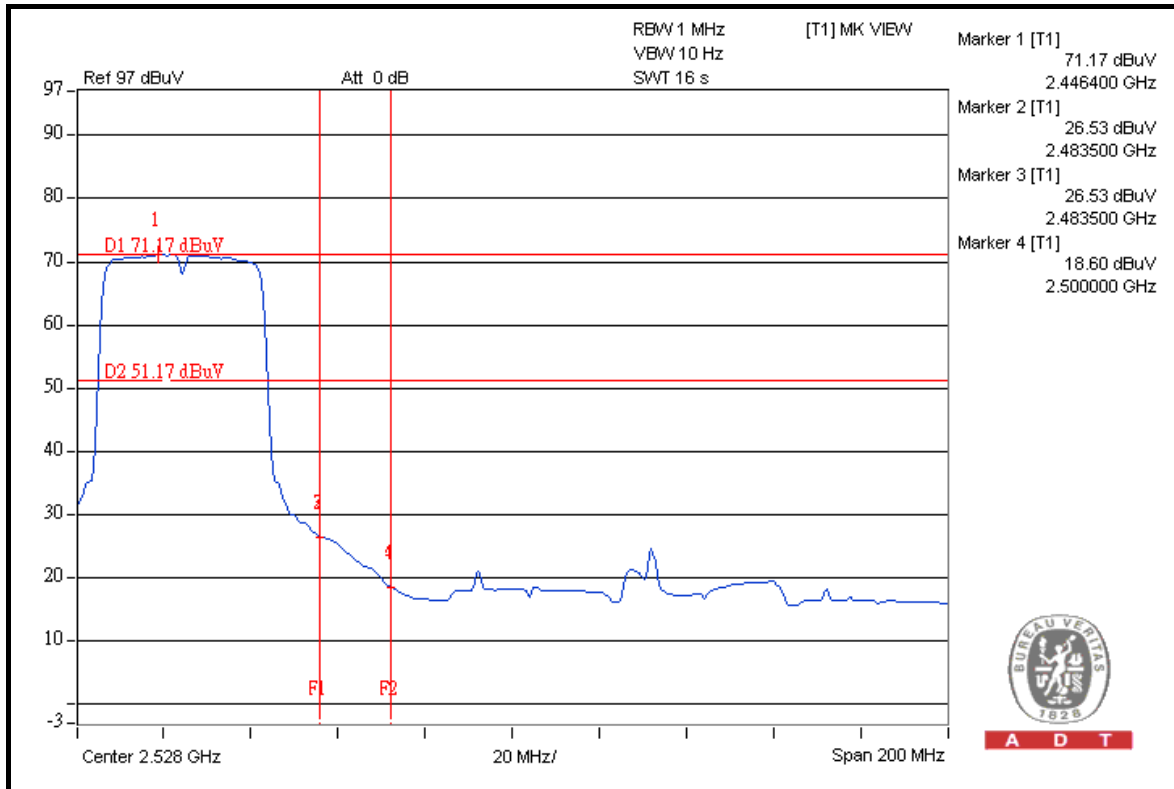



A D T

4.7 ANTENNA REQUIREMENT

4.7.1 STANDARD APPLICABLE

For intentional device, according to FCC 47 CFR Section 15.203, an intentional radiator shall be designed to ensure that no antenna other than that furnished by the responsible party shall be used with the device.

And according to FCC 47 CFR Section 15.247 (b), if transmitting antennas of directional gain greater than 6dBi are used, the power shall be reduced by the amount in dB that the directional gain of the antenna exceeds 6dBi.

4.7.2 ANTENNA CONNECTED CONSTRUCTION

The antenna used in this product is PIFA antenna without connector. The maximum gain of the antenna is 2dBi.



A D T

5. PHOTOGRAPHS OF THE TEST CONFIGURATION

Please refer to the attached file (Test Setup Photo).



A D T

6. INFORMATION ON THE TESTING LABORATORIES

We, Bureau Veritas Consumer Products Services (H.K.) Ltd., Taoyuan Branch, were founded in 1988 to provide our best service in EMC, Radio, Telecom and Safety consultation. Our laboratories are accredited and approved by the following approval agencies according to ISO/IEC 17025.

USA	FCC, NVLAP
Germany	TUV Rheinland
Japan	VCCI
Norway	NEMKO
Canada	INDUSTRY CANADA, CSA
R.O.C.	TAF, BSMI, NCC
Netherlands	Telefication
Singapore	GOST-ASIA(MOU)
Russia	CERTIS(MOU)

Copies of accreditation certificates of our laboratories obtained from approval agencies can be downloaded from our web site:

www.adt.com.tw/index.5/phtml. If you have any comments, please feel free to contact us at the following:

Linko EMC/RF Lab:
Tel: 886-2-26052180
Fax: 886-2-26051924

Hsin Chu EMC/RF Lab:
Tel: 886-3-5935343
Fax: 886-3-5935342

Hwa Ya EMC/RF/Safety Telecom Lab:
Tel: 886-3-3183232
Fax: 886-3-3185050

Web Site: www.adt.com.tw

The address and road map of all our labs can be found in our web site also.



A D T

7. APPENDIX A - MODIFICATIONS RECORDERS FOR ENGINEERING CHANGES TO THE EUT BY THE LAB

No any modifications are made to the EUT by the lab during the test.

---END---