



# FCC TEST REPORT

**REPORT NO.:** RF960716L02

**MODEL NO.:** WLN-1108 (refer to item 3.1 for more details)

**RECEIVED:** Jul. 16, 2007

**TESTED:** Jul. 17 ~ Jul. 19, 2007

**ISSUED:** Oct. 02, 2007

**APPLICANT:** CAMEO COMMUNICATIONS, INC.

**ADDRESS:** 5F, No. 42, Sec. 6, Mincyuan E. Rd., Neihu District, Taipei City 114, Taiwan

**ISSUED BY:** Advance Data Technology Corporation

**LAB ADDRESS:** 47 14<sup>th</sup> Lin, Chiapau Tsun, Linko, Taipei, Taiwan, R.O.C.

**TEST LOCATION:** No. 19, Hwa Ya 2<sup>nd</sup> Rd., Kueishan, Taoyuan, Taiwan, R.O.C.

This test report consists of 105 pages in total. It may be duplicated completely for legal use with the approval of the applicant. It should not be reproduced except in full, without the written approval of our laboratory. The client should not use it to claim product endorsement by TAF, A2LA or any government agencies. The test results in the report only apply to the tested sample.





## TABLE OF CONTENTS

1.	CERTIFICATION .....	4
2.	SUMMARY OF TEST RESULTS.....	5
2.1	MEASUREMENT UNCERTAINTY .....	5
3.	GENERAL INFORMATION .....	6
3.1	GENERAL DESCRIPTION OF EUT .....	6
3.2	DESCRIPTION OF TEST MODES .....	7
3.2.1	CONFIGURATION OF SYSTEM UNDER TEST.....	8
3.2.2	TEST MODE APPLICABILITY AND TESTED CHANNEL DETAIL .....	9
3.3	GENERAL DESCRIPTION OF APPLIED STANDARDS.....	11
3.4	DESCRIPTION OF SUPPORT UNITS.....	11
4.	TEST TYPES AND RESULTS.....	12
4.1	CONDUCTED EMISSION MEASUREMENT .....	12
4.1.1	LIMITS OF CONDUCTED EMISSION MEASUREMENT .....	12
4.1.2	TEST INSTRUMENTS .....	12
4.1.3	TEST PROCEDURES.....	13
4.1.4	DEVIATION FROM TEST STANDARD .....	13
4.1.5	TEST SETUP .....	14
4.1.6	EUT OPERATING CONDITIONS.....	14
4.1.7	TEST RESULTS.....	15
4.2	RADIATED EMISSION MEASUREMENT .....	33
4.2.1	LIMITS OF RADIATED EMISSION MEASUREMENT .....	33
4.2.2	TEST INSTRUMENTS .....	34
4.2.3	TEST PROCEDURES.....	35
4.2.4	DEVIATION FROM TEST STANDARD .....	35
4.2.5	TEST SETUP .....	36
4.2.6	EUT OPERATING CONDITIONS.....	36
4.2.7	TEST RESULTS.....	37
4.3	6dB BANDWIDTH MEASUREMENT .....	52
4.3.1	LIMITS OF 6dB BANDWIDTH MEASUREMENT .....	52
4.3.2	TEST INSTRUMENTS .....	52
4.3.3	TEST PROCEDURE .....	52
4.3.4	DEVIATION FROM TEST STANDARD .....	52
4.3.5	TEST SETUP .....	53
4.3.6	EUT OPERATING CONDITIONS.....	53
4.3.7	TEST RESULTS.....	54
4.4	MAXIMUM PEAK OUTPUT POWER.....	66
4.4.1	LIMITS OF MAXIMUM PEAK OUTPUT POWER MEASUREMENT .....	66
4.4.2	INSTRUMENTS .....	66
4.4.3	TEST PROCEDURES.....	66
4.4.4	DEVIATION FROM TEST STANDARD .....	66
4.4.5	TEST SETUP .....	67
4.4.6	EUT OPERATING CONDITIONS.....	67



4.4.7	TEST RESULTS.....	68
4.5	POWER SPECTRAL DENSITY MEASUREMENT .....	70
4.5.1	LIMITS OF POWER SPECTRAL DENSITY MEASUREMENT.....	70
4.5.2	TEST INSTRUMENTS.....	70
4.5.3	TEST PROCEDURE .....	70
4.5.4	DEVIATION FROM TEST STANDARD.....	70
4.5.5	TEST SETUP .....	71
4.5.6	EUT OPERATING CONDITION.....	71
4.5.7	TEST RESULTS.....	72
4.6	BAND EDGES MEASUREMENT.....	84
4.6.1	LIMITS OF BAND EDGES MEASUREMENT .....	84
4.6.2	TEST INSTRUMENTS.....	84
4.6.3	TEST PROCEDURE .....	85
4.6.4	DEVIATION FROM TEST STANDARD.....	86
4.6.5	EUT OPERATING CONDITION.....	86
4.6.6	TEST RESULTS.....	86
4.7	ANTENNA REQUIREMENT.....	102
4.7.1	STANDARD APPLICABLE.....	102
4.7.2	ANTENNA CONNECTED CONSTRUCTION .....	102
5.	PHOTOGRAPHS OF THE TEST CONFIGURATION .....	103
6.	INFORMATION ON THE TESTING LABORATORIES.....	104
7.	APPENDIX A - MODIFICATIONS RECORDERS FOR ENGINEERING CHANGES TO THE EUT BY THE LAB.....	105



# 1. CERTIFICATION

**PRODUCT:** 802.11n 1.0 Draft WLAN CardBus Adapter  
**MODEL:** WLN-1108 (refer to item 3.1 for more details)  
**BRAND:** CAMEO  
**APPLICANT:** CAMEO COMMUNICATIONS, INC.  
**TESTED:** Jul. 17 ~ Jul. 19, 2007  
**TEST SAMPLE:** ENGINEERING SAMPLE  
**STANDARDS: FCC Part 15, Subpart C (Section 15.247)**  
ANSI C63.4-2003

The above equipment (model: WLN-1108) has been tested by **Advance Data Technology Corporation**, and found compliance with the requirement of the above standards. The test record, data evaluation & Equipment Under Test (EUT) configurations represented herein are true and accurate accounts of the measurements of the sample's EMC characteristics under the conditions specified in this report.

**PREPARED BY** : Rennie Wang , **DATE:** Oct. 02, 2007  
Rennie Wang / Senior Specialist

**TECHNICAL ACCEPTANCE** : Long Chen , **DATE:** Oct. 02, 2007  
Responsible for RF Long Chen / Senior Engineer

**APPROVED BY** : Gary Chang , **DATE:** Oct. 02, 2007  
Gary Chang / Assistant Manager

## 2. SUMMARY OF TEST RESULTS

The EUT has been tested according to the following specifications:

APPLIED STANDARD: FCC Part 15, Subpart C			
STANDARD SECTION	TEST TYPE AND LIMIT	RESULT	REMARK
15.207	AC Power Conducted Emission	PASS	Meet the requirement of limit. Minimum passing margin is -10.14dB at 0.173MHz.
15.247(a)(2)	Spectrum Bandwidth of a Direct Sequence Spread Spectrum System Limit : min. 500kHz	PASS	Meet the requirement of limit.
15.247(b)	Maximum Peak Output Power Limit: max. 30dBm	PASS	Meet the requirement of limit.
15.247(d)	Transmitter Radiated Emissions Limit: Table 15.209	PASS	Meet the requirement of limit. Minimum passing margin is -1.12dB at 2390.00MHz.
15.247(e)	Power Spectral Density Limit: max. 8dBm	PASS	Meet the requirement of limit.
15.247(d)	Band Edge Measurement Limit: 20dB less than the peak value of fundamental frequency	PASS	Meet the requirement of limit.

### 2.1 MEASUREMENT UNCERTAINTY

Where relevant, the following measurement uncertainty levels have been estimated for tests performed on the EUT as specified in CISPR 16-4-2:

MEASUREMENT	FREQUENCY	UNCERTAINTY
Conducted emissions	9kHz ~ 30MHz	2.44 dB
Radiated emissions	30MHz ~ 200MHz	3.34 dB
	200MHz ~1000MHz	3.35 dB
	1GHz ~ 18GHz	2.26 dB
	18GHz ~ 40GHz	1.94 dB

This uncertainty represents an expanded uncertainty expressed at approximately the 95% confidence level using a coverage factor of  $k = 2$ .

### 3. GENERAL INFORMATION

#### 3.1 GENERAL DESCRIPTION OF EUT

<b>PRODUCT</b>	802.11n 1.0 Draft WLAN CardBus Adapter
<b>MODEL NO.</b>	WLN-1108 (refer to NOTE below for more details)
<b>FCC ID</b>	NHPWLN1108
<b>POWER SUPPLY</b>	3.3Vdc from host equipment
<b>MODULATION TYPE</b>	CCK, DQPSK, DBPSK for DSSS 64QAM, 16QAM, QPSK, BPSK for OFDM
<b>MODULATION TECHNOLOGY</b>	DSSS, OFDM
<b>TRANSFER RATE</b>	802.11b: 11.0/ 5.5/ 2.0/ 1.0Mbps 802.11g: 54.0/ 48.0/ 36.0/ 24.0/ 18.0/ 12.0/ 9.0/ 6.0Mbps Draft 802.11n: 6.5 / 13.0 / 13.5 / 19.5 / 26.0 / 27.0 / 39.0 / 40.5 / 52.0 / 54.0 / 58.5 / 65.0 / 78.0 / 81.0 / 104.0 / 108.0 / 117.0 / 121.5 / 130.0 / 135.0 / 162.0 / 216.0 / 243.0 / 270.0 / 300.0
<b>FREQUENCY RANGE</b>	2412MHz ~ 2462MHz
<b>NUMBER OF CHANNEL</b>	11 for 802.11b, 802.11g, Draft 802.11n (20MHz) 7 for Draft 802.11n (40MHz)
<b>MAXIMUM OUTPUT POWER</b>	205.604mW
<b>ANTENNA TYPE</b>	PIFA antenna with 2dBi gain
<b>DATA CABLE</b>	NA
<b>I/O PORTS</b>	NA
<b>ACCESSORY DEVICES</b>	NA

#### NOTE:

1. The models as below are identical to each other except for their model and brand name due to marketing requirement.

BRAND NAME	MODEL NAME
CAMEO	WLN-1108
ENCORE	ENPWI-N

2. The EUT incorporates a MIMO function with 802.11b, 802.11g, draft 802.11n. Physically, the card provides two completed transmitters and three receivers.
3. The EUT is 2 \* 3 spatial MIMO (2Tx & 3Rx) without beam forming function.
4. When the EUT operating in 802.11b/g, the software operation, which is defined by manufacturer, only set single Tx.
5. When the EUT operating in draft 802.11n, the software operation, which is defined by manufacturer, only set 0 ~ 15 of "MCS" (MCS: Modulation and Coding Schemes) for dual Tx.
6. The EUT complies with draft 802.11n standards and backwards compatible with 802.11b, 802.11g products.
7. The EUT operates in the 2.4GHz frequency spectrum with throughput of up to 300Mbps.
8. The above EUT information was declared by manufacturer and for more detailed features description, please refer to the manufacturer's specifications or user's manual.

### 3.2 DESCRIPTION OF TEST MODES

Eleven channels are provided for 802.11b, 802.11g and draft 802.11n (20MHz):

CHANNEL	FREQUENCY	CHANNEL	FREQUENCY
1	2412MHz	7	2442MHz
2	2417MHz	8	2447MHz
3	2422MHz	9	2452MHz
4	2427MHz	10	2457MHz
5	2432MHz	11	2462MHz
6	2437MHz		

Seven channels are provided for draft 802.11n (40MHz):

CHANNEL	FREQUENCY	CHANNEL	FREQUENCY
1	2422MHz	5	2442MHz
2	2427MHz	6	2447MHz
3	2432MHz	7	2452MHz
4	2437MHz		

### 3.2.1 CONFIGURATION OF SYSTEM UNDER TEST

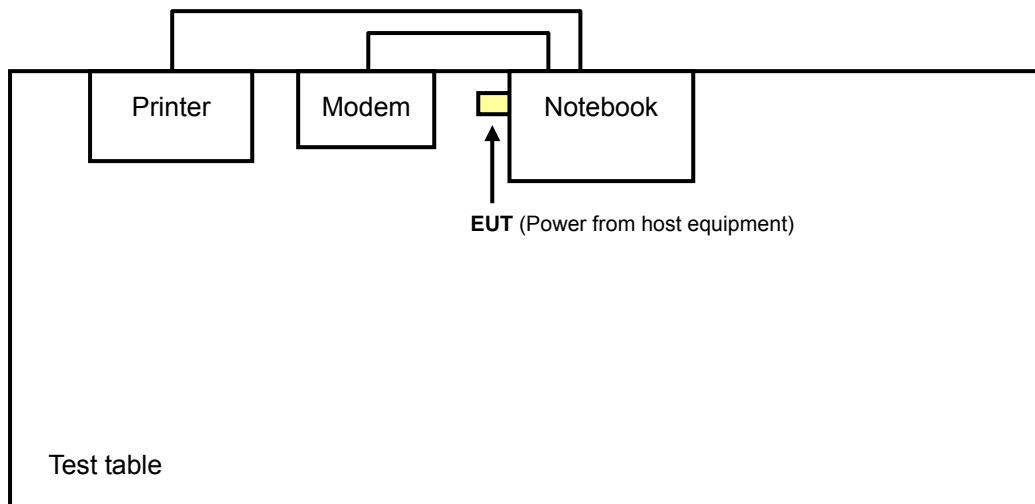



### 3.2.2 TEST MODE APPLICABILITY AND TESTED CHANNEL DETAIL

EUT CONFIGURE MODE	APPLICABLE TO				DESCRIPTION
	PLC	RE < 1G	RE ≥ 1G	APCM	
-	√	√	√	√	-

Where **PLC**: Power Line Conducted Emission      **RE < 1G**: Radiated Emission below 1GHz  
**RE ≥ 1G**: Radiated Emission above 1GHz      **APCM**: Antenna Port Conducted Measurement

#### **POWER LINE CONDUCTED EMISSION TEST:**

- Pre-Scan has been conducted to determine the worst-case mode from all possible combinations between available modulations, data rates and antenna ports (if EUT with antenna diversity architecture).
- Following channel(s) was (were) selected for the final test as listed below.

MODE	AVAILABLE CHANNEL	TESTED CHANNEL	MODULATION TECHNOLOGY	MODULATION TYPE	DATA RATE (Mbps)
802.11g	1 to 11	1, 6, 11	OFDM	BPSK	6.0
Draft 802.11n (20MHz)	1 to 11	1, 6, 11	OFDM	BPSK	6.5
Draft 802.11n (40MHz)	1 to 7	1, 4, 7	OFDM	BPSK	13.5

#### **RADIATED EMISSION TEST (BELOW 1 GHz):**

- Pre-Scan has been conducted to determine the worst-case mode from all possible combinations between available modulations, data rates and antenna ports (if EUT with antenna diversity architecture).
- Following channel(s) was (were) selected for the final test as listed below.

MODE	AVAILABLE CHANNEL	TESTED CHANNEL	MODULATION TECHNOLOGY	MODULATION TYPE	DATA RATE (Mbps)
802.11g	1 to 11	1	OFDM	BPSK	6.0
Draft 802.11n (20MHz)	1 to 11	1	OFDM	BPSK	6.5
Draft 802.11n (40MHz)	1 to 7	1	OFDM	BPSK	13.5

**RADIATED EMISSION TEST (ABOVE 1 GHz):**

- Pre-Scan has been conducted to determine the worst-case mode from all possible combinations between available modulations, data rates and antenna ports (if EUT with antenna diversity architecture).
- Following channel(s) was (were) selected for the final test as listed below.

MODE	AVAILABLE CHANNEL	TESTED CHANNEL	MODULATION TECHNOLOGY	MODULATION TYPE	DATA RATE (Mbps)
802.11b	1 to 11	1, 6, 11	DSSS	DBPSK	1.0
802.11g	1 to 11	1, 6, 11	OFDM	BPSK	6.0
Draft 802.11n (20MHz)	1 to 11	1, 6, 11	OFDM	BPSK	6.5
Draft 802.11n (40MHz)	1 to 7	1, 4, 7	OFDM	BPSK	13.5

**BANDEDGE MEASUREMENT:**

- Pre-Scan has been conducted to determine the worst-case mode from all possible combinations between available modulations, data rates and antenna ports (if EUT with antenna diversity architecture).
- Following channel(s) was (were) selected for the final test as listed below.

MODE	AVAILABLE CHANNEL	TESTED CHANNEL	MODULATION TECHNOLOGY	MODULATION TYPE	DATA RATE (Mbps)
802.11b	1 to 11	1, 11	DSSS	DBPSK	1.0
802.11g	1 to 11	1, 11	OFDM	BPSK	6.0
Draft 802.11n (20MHz)	1 to 11	1, 11	OFDM	BPSK	6.5
Draft 802.11n (40MHz)	1 to 7	1, 7	OFDM	BPSK	13.5

**ANTENNA PORT CONDUCTED MEASUREMENT:**

- Pre-Scan has been conducted to determine the worst-case mode from all possible combinations between available modulations, data rates and antenna ports (if EUT with antenna diversity architecture).
- Following channel(s) was (were) selected for the final test as listed below.

MODE	AVAILABLE CHANNEL	TESTED CHANNEL	MODULATION TECHNOLOGY	MODULATION TYPE	DATA RATE (Mbps)
802.11b	1 to 11	1, 6, 11	DSSS	DBPSK	1.0
802.11g	1 to 11	1, 6, 11	OFDM	BPSK	6.0
Draft 802.11n (20MHz)	1 to 11	1, 6, 11	OFDM	BPSK	6.5
Draft 802.11n (40MHz)	1 to 7	1, 4, 7	OFDM	BPSK	13.5



### 3.3 GENERAL DESCRIPTION OF APPLIED STANDARDS

The EUT is a RF product. According to the specifications of the manufacturer, it must comply with the requirements of the following standards:

**FCC Part 15, Subpart C. (15.247)**

**ANSI C63.4-2003**

All test items have been performed and recorded as per the above standards.

**NOTE:** The EUT is also considered as a kind of computer peripheral, because the connection to computer is necessary for typical use. It has been verified to comply with the requirements of FCC Part 15, Subpart B, Class B (DoC). The test report has been issued separately.

### 3.4 DESCRIPTION OF SUPPORT UNITS

The EUT has been tested as an independent unit together with other necessary accessories or support units. The following support units or accessories were used to form a representative test configuration during the tests.

NO.	PRODUCT	BRAND	MODEL NO.	SERIAL NO.	FCC ID
1	NOTEBOOK COMPUTER	DELL	PP05L	12130898320	E2K24CLNS
2	PRINTER	EPSON	LQ-300+	DCGY047265	FCC DoC Approved
3	MODEM	ACEEX	1414V/3	0401008248	IFAXDM1414

NO.	SIGNAL CABLE DESCRIPTION OF THE ABOVE SUPPORT UNITS
1	NA
2	1.8m braid shielded wire , DB25 connector , w/o core.
3	1.2m braid shielded wire , DB25 & DB9 connector , w/o core.

**NOTE:** All power cords of the above support units are non shielded (1.8m).



## 4. TEST TYPES AND RESULTS

### 4.1 CONDUCTED EMISSION MEASUREMENT

#### 4.1.1 LIMITS OF CONDUCTED EMISSION MEASUREMENT

FREQUENCY OF EMISSION (MHz)	CONDUCTED LIMIT (dB $\mu$ V)	
	Quasi-peak	Average
0.15-0.5	66 to 56	56 to 46
0.5-5	56	46
5-30	60	50

- NOTE:**
1. The lower limit shall apply at the transition frequencies.
  2. The limit decreases in line with the logarithm of the frequency in the range of 0.15 to 0.50 MHz.
  3. All emanations from a class A/B digital device or system, including any network of conductors and apparatus connected thereto, shall not exceed the level of field strengths specified above.

#### 4.1.2 TEST INSTRUMENTS

DESCRIPTION & MANUFACTURER	MODEL NO.	SERIAL NO.	CALIBRATED UNTIL
Test Receiver ROHDE & SCHWARZ	ESCS30	100288	Sep. 25, 2007
RF signal cable Woken	5D-FB	Cable-HYCO3-01	Jan. 06, 2008
LISN ROHDE & SCHWARZ	ESH2-Z5	100100	Jan. 08, 2008
LISN ROHDE & SCHWARZ	ESH3-Z5	100311	Jan. 16, 2008
Software ADT	ADT_Cond_V3	NA	NA

- NOTE:**
1. The calibration interval of the above test instruments is 12 months and the calibrations are traceable to NML/ROC and NIST/USA.
  2. The test was performed in HwaYa Shielded Room 2.
  3. The VCCI Site Registration No. is C-2047.

#### 4.1.3 TEST PROCEDURES

- a. The EUT was placed 0.4 meters from the conducting wall of the shielded room with EUT being connected to the power mains through a line impedance stabilization network (LISN). Other support units were connected to the power mains through another LISN. The two LISNs provide 50 ohm/ 50uH of coupling impedance for the measuring instrument.
- b. Both lines of the power mains connected to the EUT were checked for maximum conducted interference.
- c. The frequency range from 150kHz to 30MHz was searched. Emission levels under (Limit - 20dB) was not recorded.

#### 4.1.4 DEVIATION FROM TEST STANDARD

No deviation

#### 4.1.5 TEST SETUP

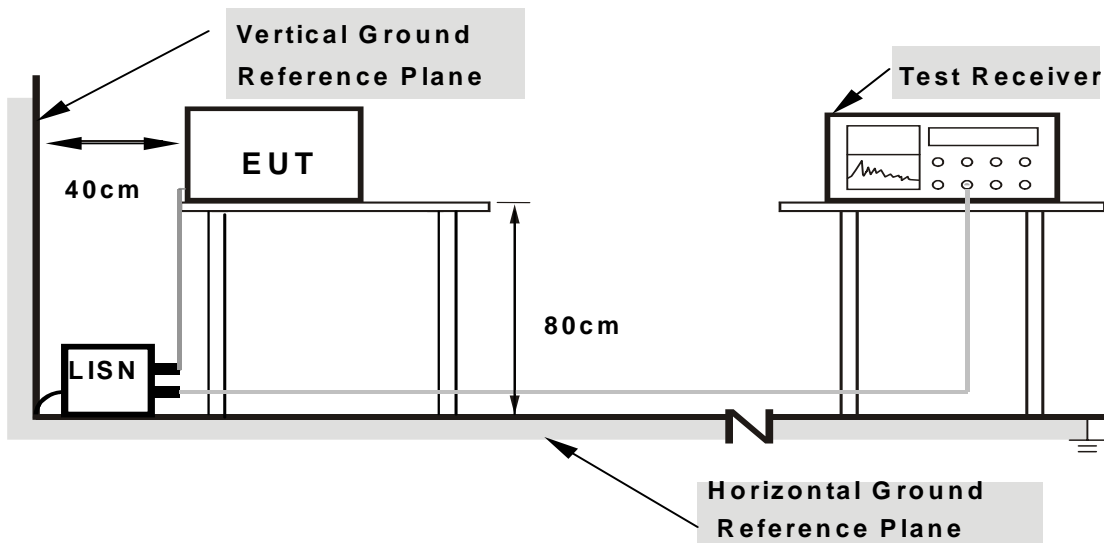

- Note:**
1. Support units were connected to second LISN.
  2. Both of LISNs (AMN) are 80 cm from EUT and at least 80 from other units and other metal planes

For the actual test configuration, please refer to the attached file (Test Setup Photo).

#### 4.1.6 EUT OPERATING CONDITIONS

- a. Connected EUT to notebook and placed on a testing table.
- b. The notebook system ran a test program (provided by manufacturer) to enable EUT under transmission condition continuously at specific channel frequency.
- c. The necessary accessories enable the system in full functions.

#### 4.1.7 TEST RESULTS

##### CONDUCTED WORST-CASE DATA 802.11g OFDM MODULATION

EUT TEST CONDITION		MEASUREMENT DETAIL	
CHANNEL	Channel 1	PHASE	Line 1
MODULATION TYPE	BPSK	6dB BANDWIDTH	9 kHz
TRANSFER RATE	6.0Mbps	INPUT POWER (SYSTEM)	120Vac, 60 Hz
ENVIRONMENTAL CONDITIONS	20deg. C, 60% RH, 991hPa	TESTED BY	Match Tsui

No	Freq. [MHz]	Corr.	Reading Value		Emission Level		Limit		Margin	
		Factor	[dB (uV)]		[dB (uV)]		[dB (uV)]		(dB)	
		(dB)	Q.P.	AV.	Q.P.	AV.	Q.P.	AV.	Q.P.	AV.
1	0.173	0.10	53.63	-	53.73	-	64.79	54.79	-11.06	-
2	0.292	0.10	39.44	-	39.54	-	60.47	50.47	-20.93	-
3	0.580	0.10	31.29	-	31.39	-	56.00	46.00	-24.61	-
4	2.152	0.22	38.61	-	38.83	-	56.00	46.00	-17.17	-
5	3.898	0.28	40.20	-	40.48	-	56.00	46.00	-15.52	-
6	17.215	0.52	36.11	-	36.63	-	60.00	50.00	-23.37	-

- REMARKS:**
1. Q.P. and AV. are abbreviations of quasi-peak and average individually.
  2. "-": The Quasi-peak reading value also meets average limit and measurement with the average detector is unnecessary.
  3. The emission levels of other frequencies were very low against the limit.
  4. Margin value = Emission level - Limit value
  5. Correction factor = Insertion loss + Cable loss
  6. Emission Level = Correction Factor + Reading Value.

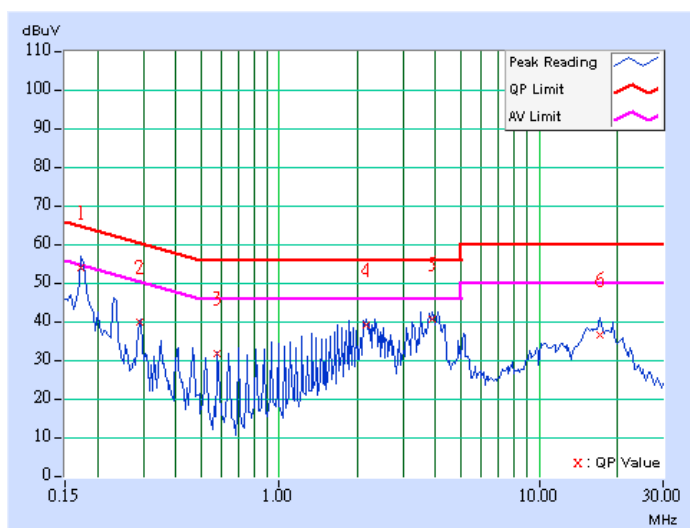

EUT TEST CONDITION		MEASUREMENT DETAIL	
CHANNEL	Channel 1	PHASE	Line 2
MODULATION TYPE	BPSK	6dB BANDWIDTH	9 kHz
TRANSFER RATE	6.0Mbps	INPUT POWER (SYSTEM)	120Vac, 60 Hz
ENVIRONMENTAL CONDITIONS	20deg. C, 60% RH, 991hPa	TESTED BY	Match Tsui

No	Freq. [MHz]	Corr.	Reading Value		Emission Level		Limit		Margin	
		Factor	[dB (uV)]		[dB (uV)]		[dB (uV)]		(dB)	
		(dB)	Q.P.	AV.	Q.P.	AV.	Q.P.	AV.	Q.P.	AV.
1	0.173	0.10	53.91	-	54.01	-	64.79	54.79	-10.78	-
2	0.291	0.10	41.95	-	42.05	-	60.51	50.51	-18.46	-
3	0.638	0.14	26.33	-	26.47	-	56.00	46.00	-29.53	-
4	2.094	0.22	37.85	-	38.07	-	56.00	46.00	-17.93	-
5	4.125	0.28	42.33	-	42.61	-	56.00	46.00	-13.39	-
6	17.070	0.52	35.84	-	36.36	-	60.00	50.00	-23.64	-

- REMARKS:**
1. Q.P. and AV. are abbreviations of quasi-peak and average individually.
  2. "-": The Quasi-peak reading value also meets average limit and measurement with the average detector is unnecessary.
  3. The emission levels of other frequencies were very low against the limit.
  4. Margin value = Emission level - Limit value
  5. Correction factor = Insertion loss + Cable loss
  6. Emission Level = Correction Factor + Reading Value.

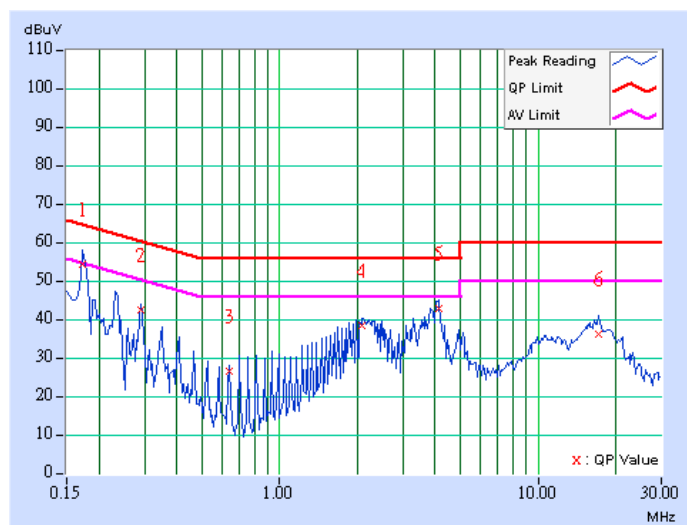



EUT TEST CONDITION		MEASUREMENT DETAIL	
CHANNEL	Channel 6	PHASE	Line 1
MODULATION TYPE	BPSK	6dB BANDWIDTH	9 kHz
TRANSFER RATE	6.0Mbps	INPUT POWER (SYSTEM)	120Vac, 60 Hz
ENVIRONMENTAL CONDITIONS	20deg. C, 60% RH, 991hPa	TESTED BY	Match Tsui

No	Freq. [MHz]	Corr. Factor (dB)	Reading Value		Emission Level		Limit		Margin	
			[dB (uV)]		[dB (uV)]		[dB (uV)]		(dB)	
			Q.P.	AV.	Q.P.	AV.	Q.P.	AV.	Q.P.	AV.
1	0.173	0.10	53.05	-	53.15	-	64.79	54.79	-11.64	-
2	0.291	0.10	39.01	-	39.11	-	60.51	50.51	-21.40	-
3	0.580	0.10	32.49	-	32.59	-	56.00	46.00	-23.41	-
4	2.148	0.22	38.11	-	38.33	-	56.00	46.00	-17.67	-
5	4.119	0.28	42.02	-	42.30	-	56.00	46.00	-13.70	-
6	17.168	0.52	36.92	-	37.44	-	60.00	50.00	-22.56	-

- REMARKS:**
1. Q.P. and AV. are abbreviations of quasi-peak and average individually.
  2. "-": The Quasi-peak reading value also meets average limit and measurement with the average detector is unnecessary.
  3. The emission levels of other frequencies were very low against the limit.
  4. Margin value = Emission level - Limit value
  5. Correction factor = Insertion loss + Cable loss
  6. Emission Level = Correction Factor + Reading Value.

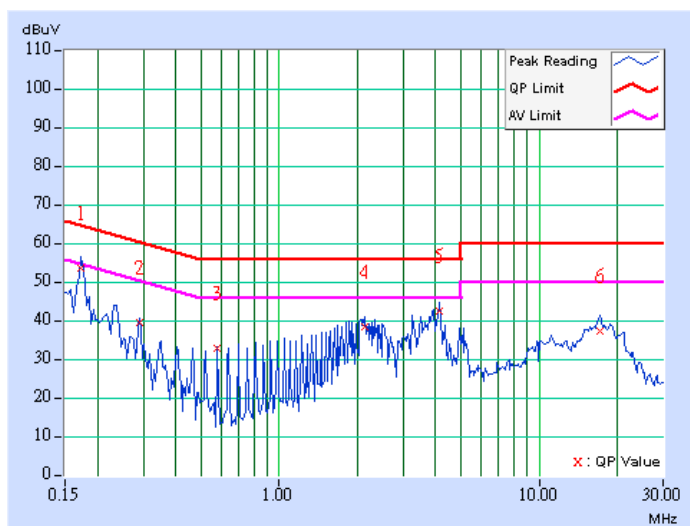

EUT TEST CONDITION		MEASUREMENT DETAIL	
CHANNEL	Channel 6	PHASE	Line 2
MODULATION TYPE	BPSK	6dB BANDWIDTH	9 kHz
TRANSFER RATE	6.0Mbps	INPUT POWER (SYSTEM)	120Vac, 60 Hz
ENVIRONMENTAL CONDITIONS	20deg. C, 60% RH, 991hPa	TESTED BY	Match Tsui

No	Freq. [MHz]	Corr. Factor (dB)	Reading Value		Emission Level		Limit		Margin	
			[dB (uV)]		[dB (uV)]		[dB (uV)]		(dB)	
			Q.P.	AV.	Q.P.	AV.	Q.P.	AV.	Q.P.	AV.
1	0.173	0.10	53.69	-	53.79	-	64.79	54.79	-11.00	-
2	0.291	0.10	41.57	-	41.67	-	60.51	50.51	-18.84	-
3	0.638	0.14	25.83	-	25.97	-	56.00	46.00	-30.03	-
4	2.086	0.22	39.35	-	39.57	-	56.00	46.00	-16.43	-
5	4.117	0.28	40.98	-	41.26	-	56.00	46.00	-14.74	-
6	17.148	0.52	36.51	-	37.03	-	60.00	50.00	-22.97	-

- REMARKS:**
1. Q.P. and AV. are abbreviations of quasi-peak and average individually.
  2. "-": The Quasi-peak reading value also meets average limit and measurement with the average detector is unnecessary.
  3. The emission levels of other frequencies were very low against the limit.
  4. Margin value = Emission level - Limit value
  5. Correction factor = Insertion loss + Cable loss
  6. Emission Level = Correction Factor + Reading Value.

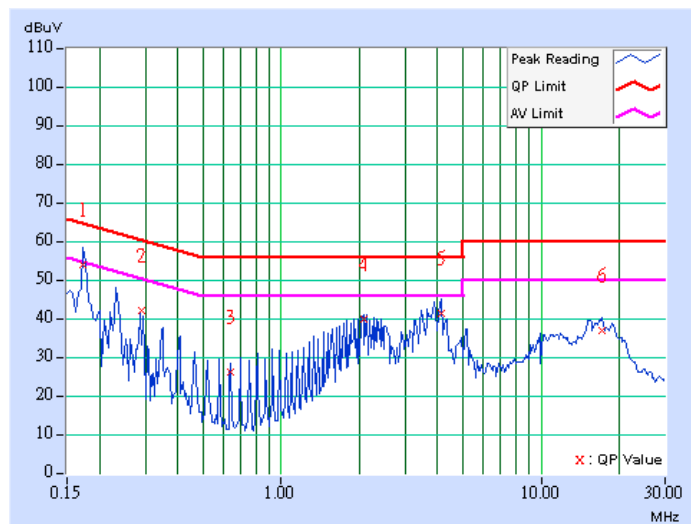

EUT TEST CONDITION		MEASUREMENT DETAIL	
CHANNEL	Channel 11	PHASE	Line 1
MODULATION TYPE	BPSK	6dB BANDWIDTH	9 kHz
TRANSFER RATE	6.0Mbps	INPUT POWER (SYSTEM)	120Vac, 60 Hz
ENVIRONMENTAL CONDITIONS	20deg. C, 60% RH, 991hPa	TESTED BY	Match Tsui

No	Freq. [MHz]	Corr. Factor (dB)	Reading Value		Emission Level		Limit		Margin	
			[dB (uV)]		[dB (uV)]		[dB (uV)]		(dB)	
			Q.P.	AV.	Q.P.	AV.	Q.P.	AV.	Q.P.	AV.
1	0.173	0.10	52.72	-	52.82	-	64.79	54.79	-11.97	-
2	0.291	0.10	38.56	-	38.66	-	60.51	50.51	-21.85	-
3	0.580	0.10	32.49	-	32.59	-	56.00	46.00	-23.41	-
4	1.969	0.22	39.35	-	39.57	-	56.00	46.00	-16.43	-
5	3.996	0.28	41.43	-	41.71	-	56.00	46.00	-14.29	-
6	17.075	0.52	37.28	-	37.80	-	60.00	50.00	-22.20	-

- REMARKS:**
1. Q.P. and AV. are abbreviations of quasi-peak and average individually.
  2. "-": The Quasi-peak reading value also meets average limit and measurement with the average detector is unnecessary.
  3. The emission levels of other frequencies were very low against the limit.
  4. Margin value = Emission level - Limit value
  5. Correction factor = Insertion loss + Cable loss
  6. Emission Level = Correction Factor + Reading Value.

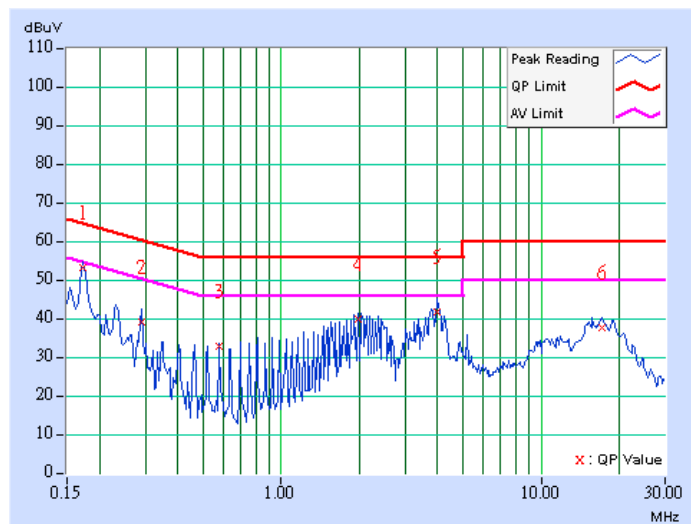

EUT TEST CONDITION		MEASUREMENT DETAIL	
CHANNEL	Channel 11	PHASE	Line 2
MODULATION TYPE	BPSK	6dB BANDWIDTH	9 kHz
TRANSFER RATE	6.0Mbps	INPUT POWER (SYSTEM)	120Vac, 60 Hz
ENVIRONMENTAL CONDITIONS	20deg. C, 60% RH, 991hPa	TESTED BY	Match Tsui

No	Freq. [MHz]	Corr. Factor (dB)	Reading Value		Emission Level		Limit		Margin	
			[dB (uV)]		[dB (uV)]		[dB (uV)]		(dB)	
			Q.P.	AV.	Q.P.	AV.	Q.P.	AV.	Q.P.	AV.
1	0.173	0.10	53.49	-	53.59	-	64.79	54.79	-11.20	-
2	0.291	0.10	41.10	-	41.20	-	60.51	50.51	-19.31	-
3	0.693	0.15	28.40	-	28.55	-	56.00	46.00	-27.45	-
4	2.199	0.23	38.93	-	39.16	-	56.00	46.00	-16.84	-
5	4.047	0.28	42.18	-	42.46	-	56.00	46.00	-13.54	-
6	16.825	0.51	37.03	-	37.54	-	60.00	50.00	-22.46	-

- REMARKS:**
1. Q.P. and AV. are abbreviations of quasi-peak and average individually.
  2. "-": The Quasi-peak reading value also meets average limit and measurement with the average detector is unnecessary.
  3. The emission levels of other frequencies were very low against the limit.
  4. Margin value = Emission level - Limit value
  5. Correction factor = Insertion loss + Cable loss
  6. Emission Level = Correction Factor + Reading Value.

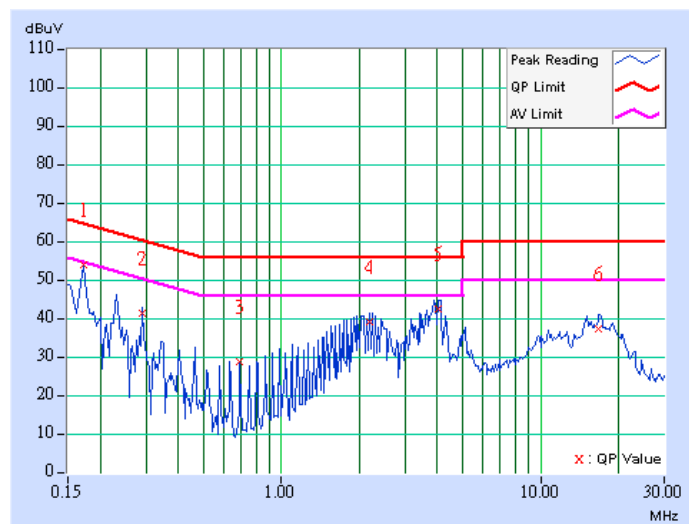

### DRAFT 802.11n (20MHz) OFDM MODULATION

EUT TEST CONDITION		MEASUREMENT DETAIL	
CHANNEL	Channel 1	PHASE	Line 1
MODULATION TYPE	BPSK	6dB BANDWIDTH	9 kHz
TRANSFER RATE	6.5Mbps	INPUT POWER (SYSTEM)	120Vac, 60 Hz
ENVIRONMENTAL CONDITIONS	20deg. C, 60% RH, 991hPa	TESTED BY	Match Tsui

No	Freq. [MHz]	Corr. Factor (dB)	Reading Value [dB (uV)]		Emission Level [dB (uV)]		Limit [dB (uV)]		Margin (dB)	
			Q.P.	AV.	Q.P.	AV.	Q.P.	AV.	Q.P.	AV.
1	0.173	0.10	52.12	-	52.22	-	64.79	54.79	-12.57	-
2	0.291	0.10	37.81	-	37.91	-	60.51	50.51	-22.60	-
3	0.693	0.10	33.63	-	33.73	-	56.00	46.00	-22.27	-
4	2.078	0.22	40.47	-	40.69	-	56.00	46.00	-15.31	-
5	3.926	0.28	40.80	-	41.08	-	56.00	46.00	-14.92	-
6	16.910	0.51	37.10	-	37.61	-	60.00	50.00	-22.39	-

- REMARKS:**
1. Q.P. and AV. are abbreviations of quasi-peak and average individually.
  2. "-": The Quasi-peak reading value also meets average limit and measurement with the average detector is unnecessary.
  3. The emission levels of other frequencies were very low against the limit.
  4. Margin value = Emission level - Limit value
  5. Correction factor = Insertion loss + Cable loss
  6. Emission Level = Correction Factor + Reading Value.

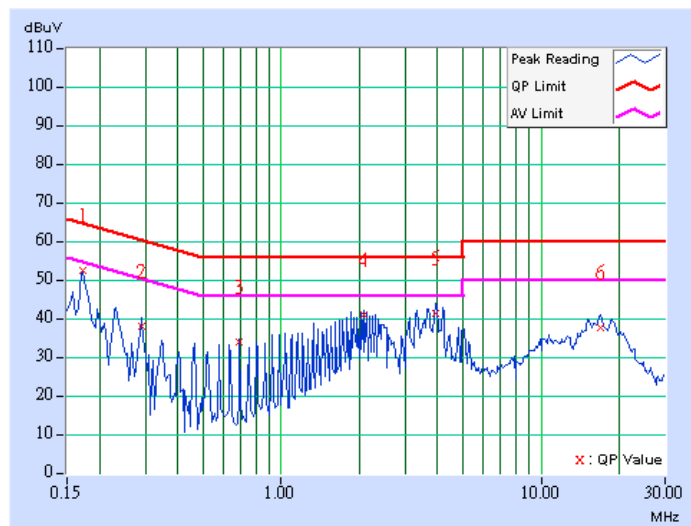

EUT TEST CONDITION		MEASUREMENT DETAIL	
CHANNEL	Channel 1	PHASE	Line 2
MODULATION TYPE	BPSK	6dB BANDWIDTH	9 kHz
TRANSFER RATE	6.5Mbps	INPUT POWER (SYSTEM)	120Vac, 60 Hz
ENVIRONMENTAL CONDITIONS	20deg. C, 60% RH, 991hPa	TESTED BY	Match Tsui

No	Freq. [MHz]	Corr. Factor (dB)	Reading Value [dB (uV)]		Emission Level [dB (uV)]		Limit [dB (uV)]		Margin (dB)	
			Q.P.	AV.	Q.P.	AV.	Q.P.	AV.	Q.P.	AV.
			1	0.174	0.10	53.13	-	53.23	-	64.79
2	0.287	0.10	41.01	-	41.11	-	60.62	50.62	-19.51	-
3	0.806	0.17	29.00	-	29.17	-	56.00	46.00	-26.83	-
4	1.961	0.22	39.97	-	40.19	-	56.00	46.00	-15.81	-
5	3.984	0.28	41.63	-	41.91	-	56.00	46.00	-14.09	-
6	16.957	0.52	35.21	-	35.73	-	60.00	50.00	-24.27	-

- REMARKS:**
1. Q.P. and AV. are abbreviations of quasi-peak and average individually.
  2. "-": The Quasi-peak reading value also meets average limit and measurement with the average detector is unnecessary.
  3. The emission levels of other frequencies were very low against the limit.
  4. Margin value = Emission level - Limit value
  5. Correction factor = Insertion loss + Cable loss
  6. Emission Level = Correction Factor + Reading Value.

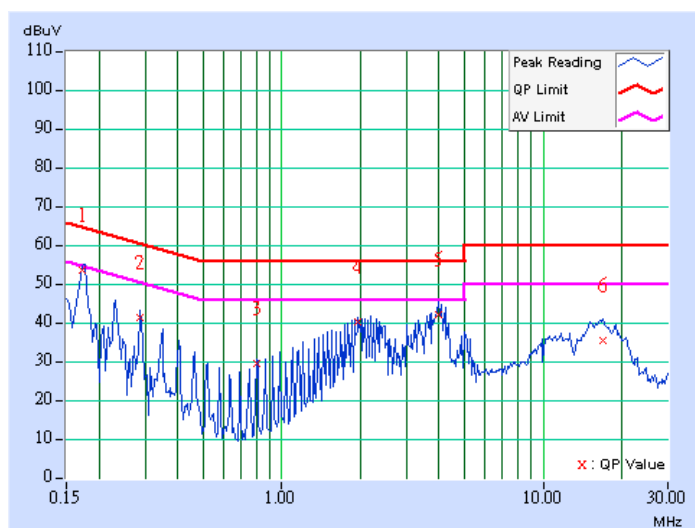

EUT TEST CONDITION		MEASUREMENT DETAIL	
CHANNEL	Channel 6	PHASE	Line 1
MODULATION TYPE	BPSK	6dB BANDWIDTH	9 kHz
TRANSFER RATE	6.5Mbps	INPUT POWER (SYSTEM)	120Vac, 60 Hz
ENVIRONMENTAL CONDITIONS	20deg. C, 60% RH, 991hPa	TESTED BY	Match Tsui

No	Freq. [MHz]	Corr. Factor (dB)	Reading Value [dB (uV)]		Emission Level [dB (uV)]		Limit [dB (uV)]		Margin (dB)	
			Q.P.	AV.	Q.P.	AV.	Q.P.	AV.	Q.P.	AV.
			1	0.173	0.10	52.06	-	52.16	-	64.79
2	0.287	0.10	38.39	-	38.49	-	60.62	50.62	-22.13	-
3	0.806	0.11	34.20	-	34.31	-	56.00	46.00	-21.69	-
4	2.078	0.22	40.25	-	40.47	-	56.00	46.00	-15.53	-
5	3.980	0.28	41.75	-	42.03	-	56.00	46.00	-13.97	-
6	16.551	0.51	37.37	-	37.88	-	60.00	50.00	-22.12	-

- REMARKS:**
1. Q.P. and AV. are abbreviations of quasi-peak and average individually.
  2. "-": The Quasi-peak reading value also meets average limit and measurement with the average detector is unnecessary.
  3. The emission levels of other frequencies were very low against the limit.
  4. Margin value = Emission level - Limit value
  5. Correction factor = Insertion loss + Cable loss
  6. Emission Level = Correction Factor + Reading Value.

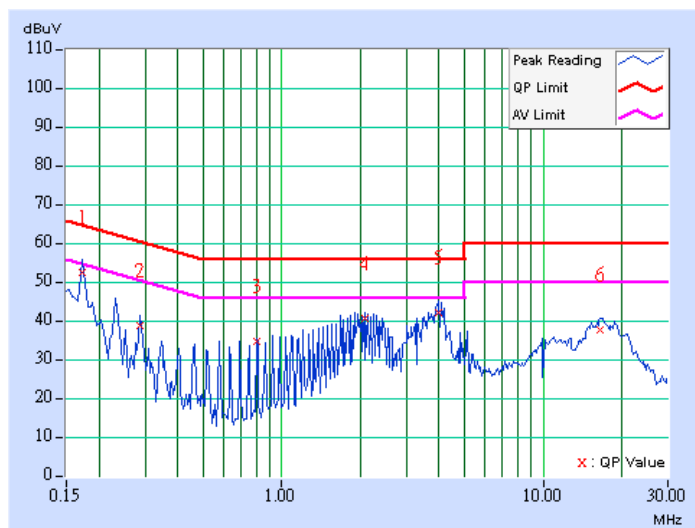

EUT TEST CONDITION		MEASUREMENT DETAIL	
CHANNEL	Channel 6	PHASE	Line 2
MODULATION TYPE	BPSK	6dB BANDWIDTH	9 kHz
TRANSFER RATE	6.5Mbps	INPUT POWER (SYSTEM)	120Vac, 60 Hz
ENVIRONMENTAL CONDITIONS	20deg. C, 60% RH, 991hPa	TESTED BY	Match Tsui

No	Freq. [MHz]	Corr. Factor (dB)	Reading Value		Emission Level		Limit		Margin	
			[dB (uV)]		[dB (uV)]		[dB (uV)]		(dB)	
			Q.P.	AV.	Q.P.	AV.	Q.P.	AV.	Q.P.	AV.
1	0.174	0.10	53.03	-	53.13	-	64.79	54.79	-11.66	-
2	0.287	0.10	41.03	-	41.13	-	60.62	50.62	-19.49	-
3	0.693	0.15	27.60	-	27.75	-	56.00	46.00	-28.25	-
4	2.019	0.22	38.73	-	38.95	-	56.00	46.00	-17.05	-
5	3.918	0.28	41.79	-	42.07	-	56.00	46.00	-13.93	-
6	16.824	0.51	36.89	-	37.40	-	60.00	50.00	-22.60	-

- REMARKS:**
1. Q.P. and AV. are abbreviations of quasi-peak and average individually.
  2. "-": The Quasi-peak reading value also meets average limit and measurement with the average detector is unnecessary.
  3. The emission levels of other frequencies were very low against the limit.
  4. Margin value = Emission level - Limit value
  5. Correction factor = Insertion loss + Cable loss
  6. Emission Level = Correction Factor + Reading Value.

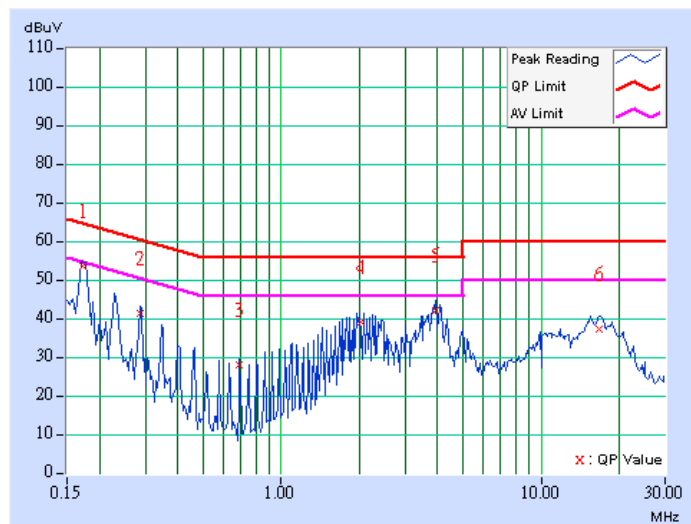



EUT TEST CONDITION		MEASUREMENT DETAIL	
CHANNEL	Channel 11	PHASE	Line 1
MODULATION TYPE	BPSK	6dB BANDWIDTH	9 kHz
TRANSFER RATE	6.5Mbps	INPUT POWER (SYSTEM)	120Vac, 60 Hz
ENVIRONMENTAL CONDITIONS	20deg. C, 60% RH, 991hPa	TESTED BY	Match Tsui

No	Freq. [MHz]	Corr. Factor (dB)	Reading Value		Emission Level		Limit		Margin	
			[dB (uV)]		[dB (uV)]		[dB (uV)]		(dB)	
			Q.P.	AV.	Q.P.	AV.	Q.P.	AV.	Q.P.	AV.
1	0.173	0.10	51.90	-	52.00	-	64.79	54.79	-12.79	-
2	0.287	0.10	38.50	-	38.60	-	60.62	50.62	-22.02	-
3	0.576	0.10	33.66	-	33.76	-	56.00	46.00	-22.24	-
4	1.902	0.21	39.50	-	39.71	-	56.00	46.00	-16.29	-
5	3.977	0.28	41.09	-	41.37	-	56.00	46.00	-14.63	-
6	17.162	0.52	37.65	-	38.17	-	60.00	50.00	-21.83	-

- REMARKS:**
1. Q.P. and AV. are abbreviations of quasi-peak and average individually.
  2. "-": The Quasi-peak reading value also meets average limit and measurement with the average detector is unnecessary.
  3. The emission levels of other frequencies were very low against the limit.
  4. Margin value = Emission level - Limit value
  5. Correction factor = Insertion loss + Cable loss
  6. Emission Level = Correction Factor + Reading Value.

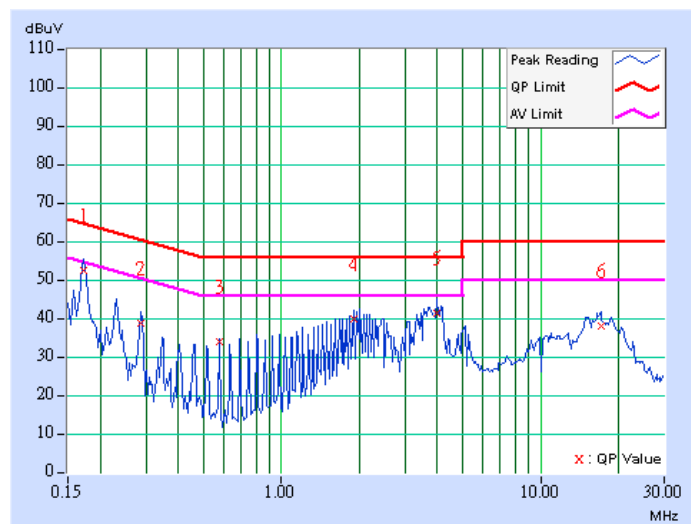

EUT TEST CONDITION		MEASUREMENT DETAIL	
CHANNEL	Channel 11	PHASE	Line 2
MODULATION TYPE	BPSK	6dB BANDWIDTH	9 kHz
TRANSFER RATE	6.5Mbps	INPUT POWER (SYSTEM)	120Vac, 60 Hz
ENVIRONMENTAL CONDITIONS	20deg. C, 60% RH, 991hPa	TESTED BY	Match Tsui

No	Freq. [MHz]	Corr. Factor (dB)	Reading Value		Emission Level		Limit		Margin	
			[dB (uV)]		[dB (uV)]		[dB (uV)]		(dB)	
			Q.P.	AV.	Q.P.	AV.	Q.P.	AV.	Q.P.	AV.
1	0.172	0.10	50.11	-	50.21	-	64.86	54.86	-14.65	-
2	0.287	0.10	39.87	-	39.97	-	60.62	50.62	-20.65	-
3	0.693	0.15	25.94	-	26.09	-	56.00	46.00	-29.91	-
4	1.957	0.22	36.12	-	36.34	-	56.00	46.00	-19.66	-
5	4.090	0.28	35.22	-	35.50	-	56.00	46.00	-20.50	-
6	16.138	0.50	32.79	-	33.29	-	60.00	50.00	-26.71	-

- REMARKS:**
1. Q.P. and AV. are abbreviations of quasi-peak and average individually.
  2. "-": The Quasi-peak reading value also meets average limit and measurement with the average detector is unnecessary.
  3. The emission levels of other frequencies were very low against the limit.
  4. Margin value = Emission level - Limit value
  5. Correction factor = Insertion loss + Cable loss
  6. Emission Level = Correction Factor + Reading Value.

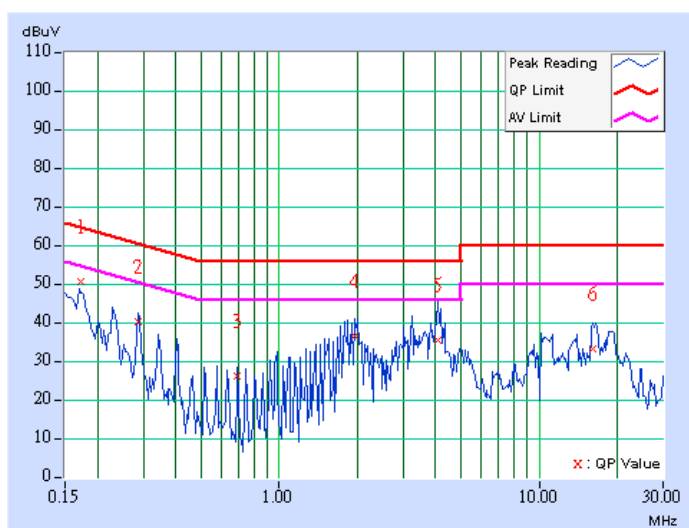

### DRAFT 802.11n (40MHz) OFDM MODULATION

EUT TEST CONDITION		MEASUREMENT DETAIL	
CHANNEL	Channel 1	PHASE	Line 1
MODULATION TYPE	BPSK	6dB BANDWIDTH	9 kHz
TRANSFER RATE	13.5Mbps	INPUT POWER (SYSTEM)	120Vac, 60 Hz
ENVIRONMENTAL CONDITIONS	20deg. C, 60% RH, 991hPa	TESTED BY	Match Tsui

No	Freq. [MHz]	Corr.	Reading Value		Emission Level		Limit		Margin	
		Factor	[dB (uV)]		[dB (uV)]		[dB (uV)]		(dB)	
		(dB)	Q.P.	AV.	Q.P.	AV.	Q.P.	AV.	Q.P.	AV.
1	0.177	0.10	54.07	-	54.17	-	64.62	54.62	-10.45	-
2	0.291	0.10	40.07	-	40.17	-	60.49	50.49	-20.32	-
3	0.584	0.10	31.57	-	31.67	-	56.00	46.00	-24.33	-
4	1.929	0.21	36.74	-	36.95	-	56.00	46.00	-19.05	-
5	4.149	0.28	40.67	-	40.95	-	56.00	46.00	-15.05	-
6	19.176	0.56	36.74	-	37.30	-	60.00	50.00	-22.70	-

- REMARKS:**
1. Q.P. and AV. are abbreviations of quasi-peak and average individually.
  2. "-": The Quasi-peak reading value also meets average limit and measurement with the average detector is unnecessary.
  3. The emission levels of other frequencies were very low against the limit.
  4. Margin value = Emission level - Limit value
  5. Correction factor = Insertion loss + Cable loss
  6. Emission Level = Correction Factor + Reading Value.

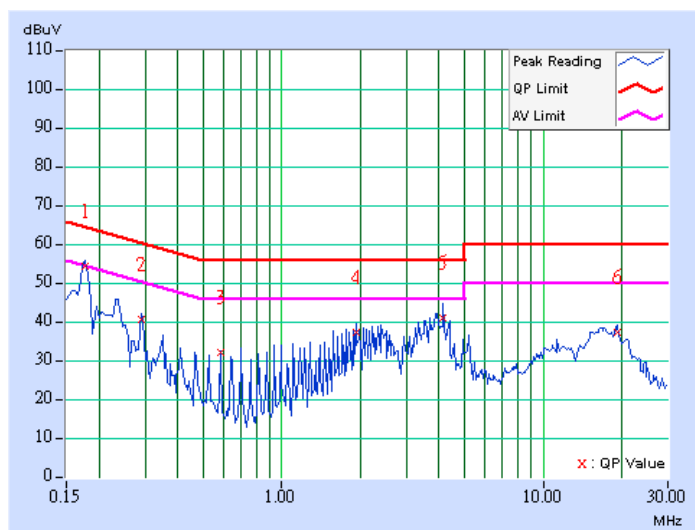

EUT TEST CONDITION		MEASUREMENT DETAIL	
CHANNEL	Channel 1	PHASE	Line 2
MODULATION TYPE	BPSK	6dB BANDWIDTH	9 kHz
TRANSFER RATE	13.5Mbps	INPUT POWER (SYSTEM)	120Vac, 60 Hz
ENVIRONMENTAL CONDITIONS	20deg. C, 60% RH, 991hPa	TESTED BY	Match Tsui

No	Freq. [MHz]	Corr. Factor (dB)	Reading Value [dB (uV)]		Emission Level [dB (uV)]		Limit [dB (uV)]		Margin (dB)	
			Q.P.	AV.	Q.P.	AV.	Q.P.	AV.	Q.P.	AV.
			1	0.173	0.10	54.57	-	54.67	-	64.81
2	0.292	0.10	42.02	-	42.12	-	60.46	50.46	-18.34	-
3	0.814	0.18	29.88	-	30.06	-	56.00	46.00	-25.94	-
4	2.274	0.23	37.57	-	37.80	-	56.00	46.00	-18.20	-
5	4.083	0.28	37.94	-	38.22	-	56.00	46.00	-17.78	-
6	17.007	0.52	36.47	-	36.99	-	60.00	50.00	-23.01	-

- REMARKS:**
1. Q.P. and AV. are abbreviations of quasi-peak and average individually.
  2. "-": The Quasi-peak reading value also meets average limit and measurement with the average detector is unnecessary.
  3. The emission levels of other frequencies were very low against the limit.
  4. Margin value = Emission level - Limit value
  5. Correction factor = Insertion loss + Cable loss
  6. Emission Level = Correction Factor + Reading Value.

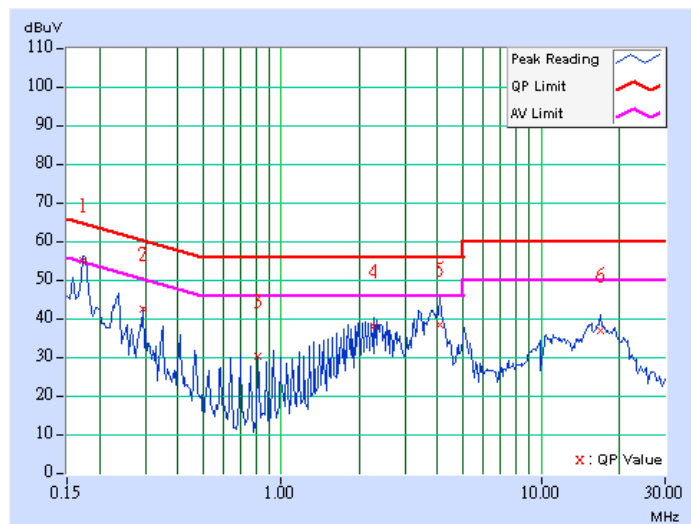

EUT TEST CONDITION		MEASUREMENT DETAIL	
CHANNEL	Channel 4	PHASE	Line 1
MODULATION TYPE	BPSK	6dB BANDWIDTH	9 kHz
TRANSFER RATE	13.5Mbps	INPUT POWER (SYSTEM)	120Vac, 60 Hz
ENVIRONMENTAL CONDITIONS	20deg. C, 60% RH, 991hPa	TESTED BY	Match Tsui

No	Freq. [MHz]	Corr.	Reading Value		Emission Level		Limit		Margin	
		Factor	[dB (uV)]		[dB (uV)]		[dB (uV)]		(dB)	
		(dB)	Q.P.	AV.	Q.P.	AV.	Q.P.	AV.	Q.P.	AV.
1	0.173	0.10	52.07	-	52.17	-	64.80	54.80	-12.63	-
2	0.291	0.10	38.56	-	38.66	-	60.49	50.49	-21.83	-
3	0.579	0.10	32.56	-	32.66	-	56.00	46.00	-23.34	-
4	1.969	0.22	40.06	-	40.28	-	56.00	46.00	-15.72	-
5	3.997	0.28	41.78	-	42.06	-	56.00	46.00	-13.94	-
6	17.076	0.52	37.28	-	37.80	-	60.00	50.00	-22.20	-

- REMARKS:**
1. Q.P. and AV. are abbreviations of quasi-peak and average individually.
  2. "-": The Quasi-peak reading value also meets average limit and measurement with the average detector is unnecessary.
  3. The emission levels of other frequencies were very low against the limit.
  4. Margin value = Emission level - Limit value
  5. Correction factor = Insertion loss + Cable loss
  6. Emission Level = Correction Factor + Reading Value.

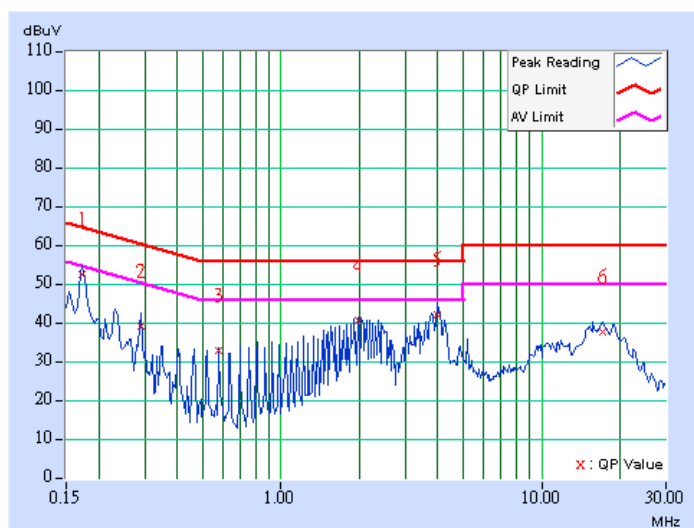

EUT TEST CONDITION		MEASUREMENT DETAIL	
CHANNEL	Channel 4	PHASE	Line 2
MODULATION TYPE	BPSK	6dB BANDWIDTH	9 kHz
TRANSFER RATE	13.5Mbps	INPUT POWER (SYSTEM)	120Vac, 60 Hz
ENVIRONMENTAL CONDITIONS	20deg. C, 60% RH, 991hPa	TESTED BY	Match Tsui

No	Freq. [MHz]	Corr. Factor (dB)	Reading Value		Emission Level		Limit		Margin	
			[dB (uV)]		[dB (uV)]		[dB (uV)]		(dB)	
			Q.P.	AV.	Q.P.	AV.	Q.P.	AV.	Q.P.	AV.
1	0.173	0.10	53.52	-	53.62	-	64.81	54.81	-11.19	-
2	0.287	0.10	41.01	-	41.11	-	60.60	50.60	-19.49	-
3	0.806	0.17	29.04	-	29.21	-	56.00	46.00	-26.79	-
4	1.961	0.22	38.36	-	38.58	-	56.00	46.00	-17.42	-
5	3.985	0.28	41.63	-	41.91	-	56.00	46.00	-14.09	-
6	16.959	0.52	35.57	-	36.09	-	60.00	50.00	-23.91	-

- REMARKS:**
1. Q.P. and AV. are abbreviations of quasi-peak and average individually.
  2. "-": The Quasi-peak reading value also meets average limit and measurement with the average detector is unnecessary.
  3. The emission levels of other frequencies were very low against the limit.
  4. Margin value = Emission level - Limit value
  5. Correction factor = Insertion loss + Cable loss
  6. Emission Level = Correction Factor + Reading Value.

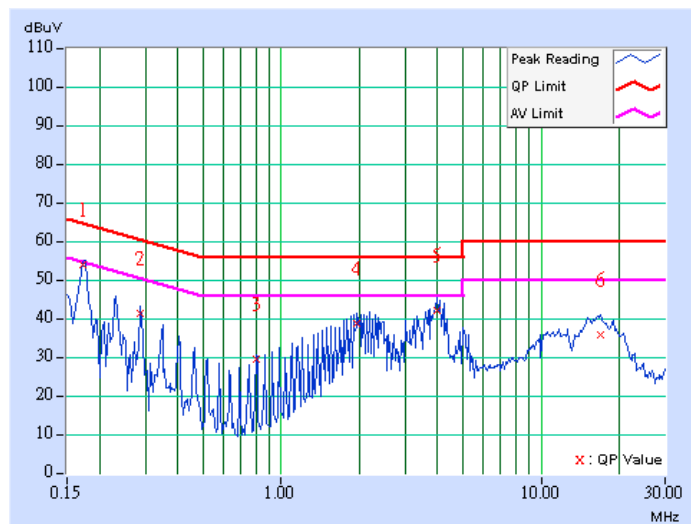

EUT TEST CONDITION		MEASUREMENT DETAIL	
CHANNEL	Channel 7	PHASE	Line 1
MODULATION TYPE	BPSK	6dB BANDWIDTH	9 kHz
TRANSFER RATE	13.5Mbps	INPUT POWER (SYSTEM)	120Vac, 60 Hz
ENVIRONMENTAL CONDITIONS	20deg. C, 60% RH, 991hPa	TESTED BY	Match Tsui

No	Freq. [MHz]	Corr. Factor (dB)	Reading Value [dB (uV)]		Emission Level [dB (uV)]		Limit [dB (uV)]		Margin (dB)	
			Q.P.	AV.	Q.P.	AV.	Q.P.	AV.	Q.P.	AV.
			1	0.173	0.10	52.57	-	52.67	-	64.80
2	0.288	0.10	38.39	-	38.49	-	60.60	50.60	-22.11	-
3	0.806	0.11	34.96	-	35.07	-	56.00	46.00	-20.93	-
4	2.079	0.22	40.25	-	40.47	-	56.00	46.00	-15.53	-
5	3.982	0.28	41.96	-	42.24	-	56.00	46.00	-13.76	-
6	16.551	0.51	38.54	-	39.05	-	60.00	50.00	-20.95	-

- REMARKS:**
1. Q.P. and AV. are abbreviations of quasi-peak and average individually.
  2. "-": The Quasi-peak reading value also meets average limit and measurement with the average detector is unnecessary.
  3. The emission levels of other frequencies were very low against the limit.
  4. Margin value = Emission level - Limit value
  5. Correction factor = Insertion loss + Cable loss
  6. Emission Level = Correction Factor + Reading Value.

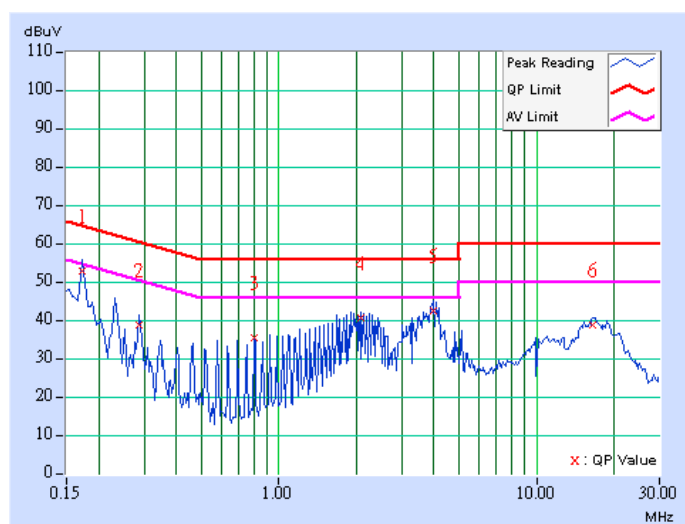

EUT TEST CONDITION		MEASUREMENT DETAIL	
CHANNEL	Channel 7	PHASE	Line 2
MODULATION TYPE	BPSK	6dB BANDWIDTH	9 kHz
TRANSFER RATE	13.5Mbps	INPUT POWER (SYSTEM)	120Vac, 60 Hz
ENVIRONMENTAL CONDITIONS	20deg. C, 60% RH, 991hPa	TESTED BY	Match Tsui

No	Freq. [MHz]	Corr. Factor (dB)	Reading Value [dB (uV)]		Emission Level [dB (uV)]		Limit [dB (uV)]		Margin (dB)	
			Q.P.	AV.	Q.P.	AV.	Q.P.	AV.	Q.P.	AV.
			1	0.174	0.10	54.36	-	54.46	-	64.79
2	0.291	0.10	41.95	-	42.05	-	60.49	50.49	-18.44	-
3	0.639	0.14	26.63	-	26.77	-	56.00	46.00	-29.23	-
4	2.094	0.22	37.85	-	38.07	-	56.00	46.00	-17.93	-
5	4.126	0.28	42.52	-	42.80	-	56.00	46.00	-13.20	-
6	17.070	0.52	35.84	-	36.36	-	60.00	50.00	-23.64	-

- REMARKS:**
1. Q.P. and AV. are abbreviations of quasi-peak and average individually.
  2. "-": The Quasi-peak reading value also meets average limit and measurement with the average detector is unnecessary.
  3. The emission levels of other frequencies were very low against the limit.
  4. Margin value = Emission level - Limit value
  5. Correction factor = Insertion loss + Cable loss
  6. Emission Level = Correction Factor + Reading Value.

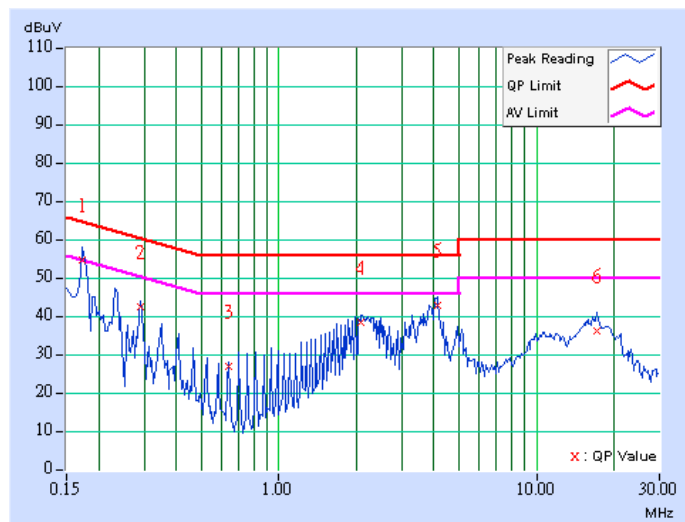



## 4.2 RADIATED EMISSION MEASUREMENT

### 4.2.1 LIMITS OF RADIATED EMISSION MEASUREMENT

Emissions radiated outside of the specified bands, shall be according to the general radiated limits in 15.209 as following:

FREQUENCIES (MHz)	FIELD STRENGTH (microvolts/meter)	MEASUREMENT DISTANCE (meters)
0.009 ~ 0.490	2400 / F(kHz)	300
0.490 ~ 1.705	24000 / F(kHz)	30
1.705 ~ 30.0	30	30
30 ~ 88	100	3
88 ~ 216	150	3
216 ~ 960	200	3
Above 960	500	3

**NOTE:**

1. The lower limit shall apply at the transition frequencies.
2. Emission level (dBuV/m) = 20 log Emission level (uV/m).
3. As shown in 15.35(b), for frequencies above 1000MHz, the field strength limits are based on average detector, however, the peak field strength of any emission shall not exceed the maximum permitted average limits, specified above by more than 20dB under any condition of modulation.



#### 4.2.2 TEST INSTRUMENTS

DESCRIPTION & MANUFACTURER	MODEL NO.	SERIAL NO.	CALIBRATED UNTIL
Test Receiver ROHDE & SCHWARZ	ESCI	100424	Aug. 04, 2007
Spectrum Analyzer ROHDE & SCHWARZ	FSP40	100025	Oct. 05, 2007
BILOG Antenna SCHWARZBECK	VULB9168	9168-160	May 31, 2008
HORN Antenna SCHWARZBECK	9120D	9120D-209	Jun. 28, 2008
HORN Antenna SCHWARZBECK	BBHA 9170	BBHA9170243	Dec. 28, 2007
Preamplifier Agilent	8447D	2944A10633	Oct. 26, 2007
Preamplifier Agilent	8449B	3008A01964	Oct. 26, 2007
RF signal cable HUBER+SUHNNER	SUCOFLEX 104	238137/4	Dec. 11, 2007
RF signal cable HUBER+SUHNNER	SUCOFLEX 104	233233/4	Nov. 14, 2007
Software ADT.	ADT_Radiated_V7.6	NA	NA
Antenna Tower inn-co GmbH	MA 4000	013303	NA
Antenna Tower Controller inn-co GmbH	CO2000	017303	NA
Turn Table ADT.	TT100.	TT93021703	NA
Turn Table Controller ADT.	SC100.	SC93021703	NA

- NOTE:**
1. The calibration interval of the above test instruments is 12 months and the calibrations are traceable to NML/ROC and NIST/USA.
  2. The test was performed in HwaYa Chamber 3.
  3. The horn antenna and HP preamplifier (model: 8449B) are used only for the measurement of emission frequency above 1GHz if tested.
  4. The VCCI Site Registration No. is R-237.
  5. The IC Site Registration No. is IC3789B-3.

#### 4.2.3 TEST PROCEDURES

- a. The EUT was placed on the top of a rotating table 0.8 meters above the ground at a 3 meters semi-anechoic chamber. The table was rotated 360 degrees to determine the position of the highest radiation.
- b. The EUT was set 3 meters away from the interference-receiving antenna, which was mounted on the top of a variable-height antenna tower.
- c. The antenna is a broadband antenna, and its height is varied from one meter to four meters above the ground to determine the maximum value of the field strength. Both horizontal and vertical polarizations of the antenna are set to make the measurement.
- d. For each suspected emission, the EUT was arranged to its worst case and then the antenna was tuned to heights from 1 meter to 4 meters and the rotatable table was turned from 0 degrees to 360 degrees to find the maximum reading.
- e. The test-receiver system was set to Peak Detect Function and Specified Bandwidth with Maximum Hold Mode.
- f. If the emission level of the EUT in peak mode was lower than the limit specified, then testing could be stopped and the peak values of the EUT would be reported. Otherwise the emissions would be re-tested one by one using peak, quasi-peak or average method as specified and then reported in a data sheet.

**NOTE:**

1. The resolution bandwidth and video bandwidth of test receiver/spectrum analyzer is 120kHz for Peak detection (PK) and Quasi-peak detection (QP) at frequency below 1GHz.
2. The resolution bandwidth of test receiver/spectrum analyzer is 1 MHz and video bandwidth is 3MHz for Peak detection at frequency above 1GHz.
3. The resolution bandwidth of test receiver/spectrum analyzer is 1MHz and the video bandwidth is 10Hz for Average detection (AV) at frequency above 1GHz.

#### 4.2.4 DEVIATION FROM TEST STANDARD

No deviation

#### 4.2.5 TEST SETUP

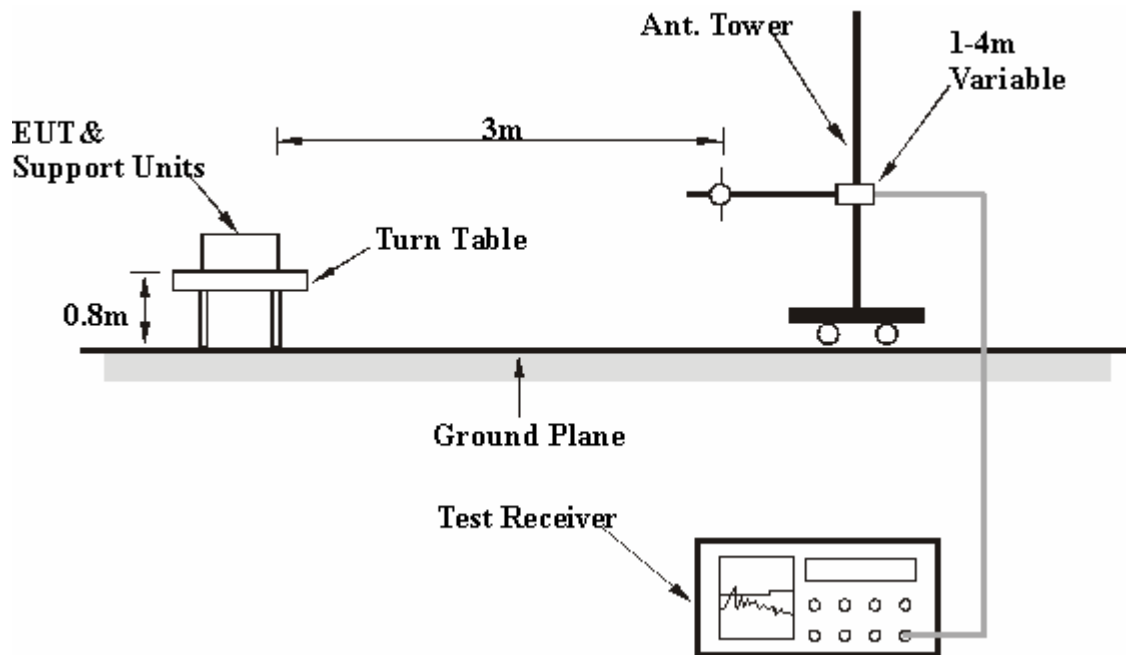

For the actual test configuration, please refer to the attached file (Test Setup Photo).

#### 4.2.6 EUT OPERATING CONDITIONS

Same as 4.1.6

#### 4.2.7 TEST RESULTS

#### BELOW 1GHz WORST-CASE DATA 802.11g OFDM MODULATION

EUT TEST CONDITION		MEASUREMENT DETAIL	
CHANNEL	Channel 1	FREQUENCY RANGE	Below 1000MHz
MODULATION TYPE	BPSK for 802.11g	INPUT POWER (SYSTEM)	120Vac, 60 Hz
TRANSFER RATE	6.0Mbps	DETECTOR FUNCTION	Quasi-Peak
ENVIRONMENTAL CONDITIONS	27deg. C, 68% RH, 985hPa	TESTED BY	Dean Wang

ANTENNA POLARITY & TEST DISTANCE: HORIZONTAL AT 3 M								
NO.	FREQ. (MHz)	EMISSION LEVEL (dBuV/m)	LIMIT (dBuV/m)	MARGIN (dB)	ANTENNA HEIGHT (m)	TABLE ANGLE (Degree)	RAW VALUE (dBuV)	CORRECTION FACTOR (dB/m)
1	107.67	31.50 QP	43.50	-12.00	1.00 H	277	20.37	11.13
2	134.89	31.01 QP	43.50	-12.49	1.00 H	280	17.55	13.47
3	166.00	30.48 QP	43.50	-13.02	1.00 H	259	16.42	14.06
4	199.05	30.06 QP	43.50	-13.44	1.50 H	70	18.72	11.34
5	249.60	33.37 QP	46.00	-12.63	1.00 H	70	19.90	13.47
6	333.21	33.52 QP	46.00	-12.48	1.00 H	223	17.49	16.02
7	467.36	27.97 QP	46.00	-18.03	2.00 H	280	8.26	19.71
8	749.29	24.58 QP	46.00	-21.42	2.00 H	181	-1.05	25.63

ANTENNA POLARITY & TEST DISTANCE: VERTICAL AT 3 M								
NO.	FREQ. (MHz)	EMISSION LEVEL (dBuV/m)	LIMIT (dBuV/m)	MARGIN (dB)	ANTENNA HEIGHT (m)	TABLE ANGLE (Degree)	RAW VALUE (dBuV)	CORRECTION FACTOR (dB/m)
1	68.79	21.16 QP	40.00	-18.84	1.00 V	100	8.31	12.85
2	113.50	25.54 QP	43.50	-17.96	1.00 V	226	13.70	11.84
3	249.60	30.67 QP	46.00	-15.33	2.00 V	166	17.20	13.47
4	333.21	27.75 QP	46.00	-18.25	1.00 V	253	11.73	16.02
5	465.42	27.68 QP	46.00	-18.32	1.00 V	322	8.00	19.67
6	576.25	30.65 QP	46.00	-15.35	1.00 V	220	8.76	21.89
7	801.78	27.20 QP	46.00	-18.80	1.00 V	19	1.28	25.92
8	893.16	27.14 QP	46.00	-18.86	1.00 V	289	-0.37	27.51

- REMARKS:**
1. Emission level(dBuV/m)=Raw Value(dBuV) + Correction Factor(dB/m)
  2. Correction Factor(dB/m) = Antenna Factor (dB/m) + Cable Factor (dB)
  3. The other emission levels were very low against the limit.
  4. Margin value = Emission level – Limit value.

### DRAFT 802.11n (20MHz) OFDM MODULATION

EUT TEST CONDITION		MEASUREMENT DETAIL	
CHANNEL	Channel 1	FREQUENCY RANGE	Below 1000MHz
MODULATION TYPE	BPSK for draft 802.11n (20MHz)	INPUT POWER (SYSTEM)	120Vac, 60 Hz
TRANSFER RATE	6.5Mbps	DETECTOR FUNCTION	Quasi-Peak
ENVIRONMENTAL CONDITIONS	27deg. C, 68% RH, 985hPa	TESTED BY	Dean Wang

ANTENNA POLARITY & TEST DISTANCE: HORIZONTAL AT 3 M								
NO.	FREQ. (MHz)	EMISSION LEVEL (dBuV/m)	LIMIT (dBuV/m)	MARGIN (dB)	ANTENNA HEIGHT (m)	TABLE ANGLE (Degree)	RAW VALUE (dBuV)	CORRECTION FACTOR (dB/m)
1	107.67	30.96 QP	43.50	-12.54	1.50 H	268	19.83	11.13
2	134.89	30.50 QP	43.50	-13.00	1.50 H	274	17.03	13.47
3	166.00	31.14 QP	43.50	-12.36	1.50 H	259	17.09	14.06
4	199.05	26.30 QP	43.50	-17.20	1.50 H	70	14.96	11.34
5	249.60	33.19 QP	46.00	-12.81	1.00 H	61	19.71	13.47
6	331.26	32.59 QP	46.00	-13.41	1.00 H	205	16.62	15.97
7	799.84	29.07 QP	46.00	-16.93	1.00 H	163	3.19	25.88
8	875.67	28.18 QP	46.00	-17.82	1.50 H	163	0.89	27.29

ANTENNA POLARITY & TEST DISTANCE: VERTICAL AT 3 M								
NO.	FREQ. (MHz)	EMISSION LEVEL (dBuV/m)	LIMIT (dBuV/m)	MARGIN (dB)	ANTENNA HEIGHT (m)	TABLE ANGLE (Degree)	RAW VALUE (dBuV)	CORRECTION FACTOR (dB/m)
1	31.84	31.95 QP	40.00	-8.05	1.00 V	289	18.41	13.54
2	68.79	28.14 QP	40.00	-11.86	1.00 V	103	15.29	12.85
3	115.45	31.12 QP	43.50	-12.38	1.00 V	217	19.04	12.08
4	129.06	26.10 QP	43.50	-17.40	1.00 V	241	12.96	13.14
5	166.00	25.79 QP	43.50	-17.71	1.50 V	16	11.73	14.06
6	249.60	29.93 QP	46.00	-16.07	1.50 V	181	16.45	13.47
7	576.25	29.40 QP	46.00	-16.60	1.00 V	226	7.51	21.89
8	932.05	28.21 QP	46.00	-17.79	1.00 V	331	0.15	28.06

- REMARKS:**
1. Emission level(dBuV/m)=Raw Value(dBuV) + Correction Factor(dB/m)
  2. Correction Factor(dB/m) = Antenna Factor (dB/m) + Cable Factor (dB)
  3. The other emission levels were very low against the limit.
  4. Margin value = Emission level – Limit value.

**DRAFT 802.11n (40MHz) OFDM MODULATION**

EUT TEST CONDITION		MEASUREMENT DETAIL	
CHANNEL	Channel 1	FREQUENCY RANGE	Below 1000MHz
MODULATION TYPE	BPSK for draft 802.11n (40MHz)	INPUT POWER (SYSTEM)	120Vac, 60 Hz
TRANSFER RATE	13.5Mbps	DETECTOR FUNCTION	Quasi-Peak
ENVIRONMENTAL CONDITIONS	27deg. C, 68% RH, 985hPa	TESTED BY	Dean Wang

ANTENNA POLARITY & TEST DISTANCE: HORIZONTAL AT 3 M								
NO.	FREQ. (MHz)	EMISSION LEVEL (dBuV/m)	LIMIT (dBuV/m)	MARGIN (dB)	ANTENNA HEIGHT (m)	TABLE ANGLE (Degree)	RAW VALUE (dBuV)	CORRECTION FACTOR (dB/m)
1	105.73	32.72 QP	43.50	-10.78	1.50 H	289	21.83	10.89
2	134.89	33.16 QP	43.50	-10.34	1.50 H	277	19.69	13.47
3	166.00	32.95 QP	43.50	-10.55	1.50 H	232	18.89	14.06
4	249.60	33.30 QP	46.00	-12.70	1.00 H	73	19.83	13.47
5	331.26	32.94 QP	46.00	-13.06	1.00 H	217	16.97	15.97
6	751.23	28.25 QP	46.00	-17.75	1.00 H	205	2.59	25.65
7	799.84	28.65 QP	46.00	-17.35	1.50 H	106	2.77	25.88
8	891.22	28.15 QP	46.00	-17.85	1.50 H	283	0.66	27.49

ANTENNA POLARITY & TEST DISTANCE: VERTICAL AT 3 M								
NO.	FREQ. (MHz)	EMISSION LEVEL (dBuV/m)	LIMIT (dBuV/m)	MARGIN (dB)	ANTENNA HEIGHT (m)	TABLE ANGLE (Degree)	RAW VALUE (dBuV)	CORRECTION FACTOR (dB/m)
1	31.84	31.35 QP	40.00	-8.65	1.00 V	127	17.81	13.54
2	70.73	29.55 QP	40.00	-10.45	1.50 V	76	17.01	12.54
3	113.50	30.65 QP	43.50	-12.85	1.00 V	220	18.80	11.84
4	129.06	27.07 QP	43.50	-16.43	1.00 V	166	13.92	13.14
5	249.60	30.50 QP	46.00	-15.50	2.00 V	163	17.03	13.47
6	576.25	29.43 QP	46.00	-16.57	1.00 V	229	7.54	21.89
7	751.23	28.31 QP	46.00	-17.69	1.50 V	304	2.66	25.65
8	933.99	28.11 QP	46.00	-17.89	2.00 V	265	0.02	28.09

- REMARKS:**
1. Emission level(dBuV/m)=Raw Value(dBuV) + Correction Factor(dB/m)
  2. Correction Factor(dB/m) = Antenna Factor (dB/m) + Cable Factor (dB)
  3. The other emission levels were very low against the limit.
  4. Margin value = Emission level – Limit value.

### 802.11b DSSS MODULATION

EUT TEST CONDITION		MEASUREMENT DETAIL	
CHANNEL	Channel 1	FREQUENCY RANGE	1 ~ 25GHz
MODULATION TYPE	DBPSK	INPUT POWER (SYSTEM)	120Vac, 60 Hz
TRANSFER RATE	1.0Mbps	DETECTOR FUNCTION	Peak(PK) Average (AV)
ENVIRONMENTAL CONDITIONS	27deg. C, 68% RH, 985hPa	TESTED BY	Dean Wang

ANTENNA POLARITY & TEST DISTANCE: HORIZONTAL AT 3 M								
NO.	FREQ. (MHz)	EMISSION LEVEL (dBuV/m)	LIMIT (dBuV/m)	MARGIN (dB)	ANTENNA HEIGHT (m)	TABLE ANGLE (Degree)	RAW VALUE (dBuV)	CORRECTION FACTOR (dB/m)
1	2386.00	60.98 PK	74.00	-13.02	1.08 H	184	28.67	32.31
2	2386.00	50.68 AV	54.00	-3.32	1.08 H	184	18.37	32.31
3	*2412.00	108.67 PK			1.08 H	186	76.24	32.43
4	*2412.00	104.26 AV			1.08 H	186	71.83	32.43
5	4824.00	53.64 PK	74.00	-20.36	1.02 H	160	15.47	38.17
6	4824.00	48.71 AV	54.00	-5.29	1.02 H	160	10.54	38.17

ANTENNA POLARITY & TEST DISTANCE: VERTICAL AT 3 M								
NO.	FREQ. (MHz)	EMISSION LEVEL (dBuV/m)	LIMIT (dBuV/m)	MARGIN (dB)	ANTENNA HEIGHT (m)	TABLE ANGLE (Degree)	RAW VALUE (dBuV)	CORRECTION FACTOR (dB/m)
1	2386.00	61.97 PK	74.00	-12.03	1.00 V	264	29.66	32.31
2	2386.00	51.14 AV	54.00	-2.86	1.00 V	264	18.83	32.31
3	*2412.00	109.40 PK			1.02 V	265	76.97	32.43
4	*2412.00	105.10 AV			1.02 V	265	72.67	32.43
5	4824.00	56.17 PK	74.00	-17.83	1.37 V	72	18.00	38.17
6	4824.00	52.64 AV	54.00	-1.36	1.37 V	72	14.47	38.17

- REMARKS:**
1. Emission level (dBuV/m) = Raw Value (dBuV) + Correction Factor (dB/m).
  2. Correction Factor (dB/m) = Antenna Factor (dB/m) + Cable Factor (dB).
  3. The other emission levels were very low against the limit.
  4. Margin value = Emission level – Limit value.
  5. The limit value is defined as per 15.247.
  6. “ \* “: Fundamental frequency.



EUT TEST CONDITION		MEASUREMENT DETAIL	
CHANNEL	Channel 6	FREQUENCY RANGE	1 ~ 25GHz
MODULATION TYPE	DBPSK	INPUT POWER (SYSTEM)	120Vac, 60 Hz
TRANSFER RATE	1.0Mbps	DETECTOR FUNCTION	Peak(PK) Average (AV)
ENVIRONMENTAL CONDITIONS	27deg. C, 68% RH, 985hPa	TESTED BY	Dean Wang

ANTENNA POLARITY & TEST DISTANCE: HORIZONTAL AT 3 M								
NO.	FREQ. (MHz)	EMISSION LEVEL (dBuV/m)	LIMIT (dBuV/m)	MARGIN (dB)	ANTENNA HEIGHT (m)	TABLE ANGLE (Degree)	RAW VALUE (dBuV)	CORRECTION FACTOR (dB/m)
1	*2437.00	108.36 PK			1.00 H	165	75.82	32.54
2	*2437.00	103.89 AV			1.00 H	165	71.35	32.54
3	4874.00	54.11 PK	74.00	-19.89	1.00 H	244	15.76	38.35
4	4874.00	50.67 AV	54.00	-3.33	1.00 H	244	12.32	38.35

ANTENNA POLARITY & TEST DISTANCE: VERTICAL AT 3 M								
NO.	FREQ. (MHz)	EMISSION LEVEL (dBuV/m)	LIMIT (dBuV/m)	MARGIN (dB)	ANTENNA HEIGHT (m)	TABLE ANGLE (Degree)	RAW VALUE (dBuV)	CORRECTION FACTOR (dB/m)
1	*2437.00	108.66 PK			1.04 V	222	76.12	32.54
2	*2437.00	104.54 AV			1.04 V	222	72.00	32.54
3	4874.00	56.09 PK	74.00	-17.91	1.11 V	70	17.74	38.35
4	4874.00	52.82 AV	54.00	-1.18	1.11 V	70	14.47	38.35

- REMARKS:**
1. Emission level (dBuV/m) = Raw Value (dBuV) + Correction Factor (dB/m).
  2. Correction Factor (dB/m) = Antenna Factor (dB/m) + Cable Factor (dB).
  3. The other emission levels were very low against the limit.
  4. Margin value = Emission level – Limit value.
  5. The limit value is defined as per 15.247.
  6. “ \* ”: Fundamental frequency.

EUT TEST CONDITION		MEASUREMENT DETAIL	
CHANNEL	Channel 11	FREQUENCY RANGE	1 ~ 25GHz
MODULATION TYPE	DBPSK	INPUT POWER (SYSTEM)	120Vac, 60 Hz
TRANSFER RATE	1.0Mbps	DETECTOR FUNCTION	Peak(PK) Average (AV)
ENVIRONMENTAL CONDITIONS	27deg. C, 68% RH, 985hPa	TESTED BY	Dean Wang

ANTENNA POLARITY & TEST DISTANCE: HORIZONTAL AT 3 M								
NO.	FREQ. (MHz)	EMISSION LEVEL (dBuV/m)	LIMIT (dBuV/m)	MARGIN (dB)	ANTENNA HEIGHT (m)	TABLE ANGLE (Degree)	RAW VALUE (dBuV)	CORRECTION FACTOR (dB/m)
1	*2462.00	108.34 PK			1.02 H	154	75.69	32.65
2	*2462.00	103.95 AV			1.02 H	154	71.30	32.65
3	2483.50	55.59 PK	74.00	-18.41	1.00 H	165	22.85	32.74
4	2483.50	52.28 AV	54.00	-1.72	1.00 H	165	19.54	32.74
5	4924.00	53.59 PK	74.00	-20.41	1.00 H	169	15.12	38.47
6	4924.00	48.84 AV	54.00	-5.16	1.00 H	169	10.37	38.47

ANTENNA POLARITY & TEST DISTANCE: VERTICAL AT 3 M								
NO.	FREQ. (MHz)	EMISSION LEVEL (dBuV/m)	LIMIT (dBuV/m)	MARGIN (dB)	ANTENNA HEIGHT (m)	TABLE ANGLE (Degree)	RAW VALUE (dBuV)	CORRECTION FACTOR (dB/m)
1	*2462.00	109.27 PK			1.00 V	263	76.62	32.65
2	*2462.00	105.08 AV			1.00 V	263	72.43	32.65
3	2483.50	63.51 PK	74.00	-10.49	1.00 V	265	30.77	32.74
4	2483.50	52.19 AV	54.00	-1.81	1.00 V	265	19.45	32.74
5	4924.00	56.08 PK	74.00	-17.92	1.04 V	114	17.61	38.47
6	4924.00	52.79 AV	54.00	-1.21	1.04 V	114	14.32	38.47

- REMARKS:**
1. Emission level (dBuV/m) = Raw Value (dBuV) + Correction Factor (dB/m).
  2. Correction Factor (dB/m) = Antenna Factor (dB/m) + Cable Factor (dB).
  3. The other emission levels were very low against the limit.
  4. Margin value = Emission level – Limit value.
  5. The limit value is defined as per 15.247.
  6. “ \* “: Fundamental frequency.

### 802.11g OFDM MODULATION

EUT TEST CONDITION		MEASUREMENT DETAIL	
CHANNEL	Channel 1	FREQUENCY RANGE	1 ~ 25GHz
MODULATION TYPE	BPSK	INPUT POWER (SYSTEM)	120Vac, 60 Hz
TRANSFER RATE	6.0Mbps	DETECTOR FUNCTION	Peak(PK) Average (AV)
ENVIRONMENTAL CONDITIONS	27deg. C, 68% RH, 985hPa	TESTED BY	Dean Wang

ANTENNA POLARITY & TEST DISTANCE: HORIZONTAL AT 3 M								
NO.	FREQ. (MHz)	EMISSION LEVEL (dBuV/m)	LIMIT (dBuV/m)	MARGIN (dB)	ANTENNA HEIGHT (m)	TABLE ANGLE (Degree)	RAW VALUE (dBuV)	CORRECTION FACTOR (dB/m)
1	2390.00	72.53 PK	74.00	-1.47	1.07 H	156	40.20	32.33
2	2390.00	50.02 AV	54.00	-3.98	1.07 H	156	17.69	32.33
3	*2412.00	107.66 PK			1.07 H	157	75.23	32.43
4	*2412.00	97.65 AV			1.07 H	157	65.22	32.43
5	4824.00	49.58 PK	74.00	-24.42	1.00 H	24	11.41	38.17
6	4824.00	37.34 AV	54.00	-16.66	1.00 H	24	-0.83	38.17

ANTENNA POLARITY & TEST DISTANCE: VERTICAL AT 3 M								
NO.	FREQ. (MHz)	EMISSION LEVEL (dBuV/m)	LIMIT (dBuV/m)	MARGIN (dB)	ANTENNA HEIGHT (m)	TABLE ANGLE (Degree)	RAW VALUE (dBuV)	CORRECTION FACTOR (dB/m)
1	2390.00	72.79 PK	74.00	-1.21	1.00 V	266	40.46	32.33
2	2390.00	50.49 AV	54.00	-3.51	1.00 V	266	18.16	32.33
3	*2412.00	107.69 PK			1.00 V	265	75.26	32.43
4	*2412.00	97.85 AV			1.00 V	265	65.42	32.43
5	4824.00	49.78 PK	74.00	-24.22	1.00 V	135	11.61	38.17
6	4824.00	37.79 AV	54.00	-16.21	1.00 V	135	-0.38	38.17

- REMARKS:**
1. Emission level (dBuV/m) = Raw Value (dBuV) + Correction Factor (dB/m).
  2. Correction Factor (dB/m) = Antenna Factor (dB/m) + Cable Factor (dB).
  3. The other emission levels were very low against the limit.
  4. Margin value = Emission level – Limit value.
  5. The limit value is defined as per 15.247.
  6. “ \* “: Fundamental frequency.

EUT TEST CONDITION		MEASUREMENT DETAIL	
CHANNEL	Channel 6	FREQUENCY RANGE	1 ~ 25GHz
MODULATION TYPE	BPSK	INPUT POWER (SYSTEM)	120Vac, 60 Hz
TRANSFER RATE	6.0Mbps	DETECTOR FUNCTION	Peak(PK) Average (AV)
ENVIRONMENTAL CONDITIONS	27deg. C, 68% RH, 985hPa	TESTED BY	Dean Wang

ANTENNA POLARITY & TEST DISTANCE: HORIZONTAL AT 3 M								
NO.	FREQ. (MHz)	EMISSION LEVEL (dBuV/m)	LIMIT (dBuV/m)	MARGIN (dB)	ANTENNA HEIGHT (m)	TABLE ANGLE (Degree)	RAW VALUE (dBuV)	CORRECTION FACTOR (dB/m)
1	*2437.00	109.70 PK			1.08 H	154	77.16	32.54
2	*2437.00	99.26 AV			1.08 H	154	66.72	32.54
3	4874.00	52.57 PK	74.00	-21.43	1.00 H	158	14.22	38.35
4	4874.00	39.06 AV	54.00	-14.94	1.00 H	158	0.71	38.35

ANTENNA POLARITY & TEST DISTANCE: VERTICAL AT 3 M								
NO.	FREQ. (MHz)	EMISSION LEVEL (dBuV/m)	LIMIT (dBuV/m)	MARGIN (dB)	ANTENNA HEIGHT (m)	TABLE ANGLE (Degree)	RAW VALUE (dBuV)	CORRECTION FACTOR (dB/m)
1	*2437.00	110.19 PK			1.00 V	261	77.65	32.54
2	*2437.00	99.93 AV			1.00 V	261	67.39	32.54
3	4874.00	55.57 PK	74.00	-18.43	1.05 V	261	17.22	38.35
4	4874.00	40.80 AV	54.00	-13.20	1.05 V	261	2.45	38.35

- REMARKS:**
1. Emission level (dBuV/m) = Raw Value (dBuV) + Correction Factor (dB/m).
  2. Correction Factor (dB/m) = Antenna Factor (dB/m) + Cable Factor (dB).
  3. The other emission levels were very low against the limit.
  4. Margin value = Emission level – Limit value.
  5. The limit value is defined as per 15.247.
  6. “ \* “: Fundamental frequency.

EUT TEST CONDITION		MEASUREMENT DETAIL	
CHANNEL	Channel 11	FREQUENCY RANGE	1 ~ 25GHz
MODULATION TYPE	BPSK	INPUT POWER (SYSTEM)	120Vac, 60 Hz
TRANSFER RATE	6.0Mbps	DETECTOR FUNCTION	Peak(PK) Average (AV)
ENVIRONMENTAL CONDITIONS	27deg. C, 68% RH, 985hPa	TESTED BY	Dean Wang

ANTENNA POLARITY & TEST DISTANCE: HORIZONTAL AT 3 M								
NO.	FREQ. (MHz)	EMISSION LEVEL (dBuV/m)	LIMIT (dBuV/m)	MARGIN (dB)	ANTENNA HEIGHT (m)	TABLE ANGLE (Degree)	RAW VALUE (dBuV)	CORRECTION FACTOR (dB/m)
1	*2462.00	105.88 PK			1.04 H	157	73.23	32.65
2	*2462.00	96.01 AV			1.04 H	157	63.36	32.65
3	2483.50	68.35 PK	74.00	-5.65	1.04 H	158	35.61	32.74
4	2483.50	51.33 AV	54.00	-2.67	1.04 H	158	18.59	32.74
5	4924.00	53.39 PK	74.00	-20.61	1.05 H	125	14.92	38.47
6	4924.00	37.87 AV	54.00	-16.13	1.05 H	125	-0.60	38.47

ANTENNA POLARITY & TEST DISTANCE: VERTICAL AT 3 M								
NO.	FREQ. (MHz)	EMISSION LEVEL (dBuV/m)	LIMIT (dBuV/m)	MARGIN (dB)	ANTENNA HEIGHT (m)	TABLE ANGLE (Degree)	RAW VALUE (dBuV)	CORRECTION FACTOR (dB/m)
1	*2462.00	106.86 PK			1.00 V	267	74.21	32.65
2	*2462.00	96.47 AV			1.00 V	267	63.82	32.65
3	2483.50	71.47 PK	74.00	-2.53	1.00 V	265	38.73	32.74
4	2483.50	52.51 AV	54.00	-1.49	1.00 V	265	19.77	32.74
5	4924.00	53.81 PK	74.00	-20.19	1.04 V	42	15.34	38.47
6	4924.00	38.12 AV	54.00	-15.88	1.04 V	42	-0.35	38.47

- REMARKS:**
1. Emission level (dBuV/m) = Raw Value (dBuV) + Correction Factor (dB/m).
  2. Correction Factor (dB/m) = Antenna Factor (dB/m) + Cable Factor (dB).
  3. The other emission levels were very low against the limit.
  4. Margin value = Emission level – Limit value.
  5. The limit value is defined as per 15.247.
  6. “ \* “: Fundamental frequency.

### DRAFT 802.11n (20MHz) OFDM MODULATION

EUT TEST CONDITION		MEASUREMENT DETAIL	
CHANNEL	Channel 1	FREQUENCY RANGE	1 ~ 25GHz
MODULATION TYPE	BPSK	INPUT POWER (SYSTEM)	120Vac, 60 Hz
TRANSFER RATE	6.5Mbps	DETECTOR FUNCTION	Peak(PK) Average (AV)
ENVIRONMENTAL CONDITIONS	27deg. C, 68% RH, 985hPa	TESTED BY	Dean Wang

ANTENNA POLARITY & TEST DISTANCE: HORIZONTAL AT 3 M								
NO.	FREQ. (MHz)	EMISSION LEVEL (dBuV/m)	LIMIT (dBuV/m)	MARGIN (dB)	ANTENNA HEIGHT (m)	TABLE ANGLE (Degree)	RAW VALUE (dBuV)	CORRECTION FACTOR (dB/m)
1	2390.00	71.68 PK	74.00	-2.32	1.00 H	21	39.35	32.33
2	2390.00	49.90 AV	54.00	-4.10	1.00 H	21	17.57	32.33
3	*2412.00	112.94 PK			1.05 H	20	80.51	32.43
4	*2412.00	103.00 AV			1.05 H	20	70.57	32.43
5	4824.00	53.57 PK	74.00	-20.43	1.00 H	46	15.40	38.17
6	4824.00	37.96 AV	54.00	-16.04	1.00 H	46	-0.21	38.17

ANTENNA POLARITY & TEST DISTANCE: VERTICAL AT 3 M								
NO.	FREQ. (MHz)	EMISSION LEVEL (dBuV/m)	LIMIT (dBuV/m)	MARGIN (dB)	ANTENNA HEIGHT (m)	TABLE ANGLE (Degree)	RAW VALUE (dBuV)	CORRECTION FACTOR (dB/m)
1	2390.00	72.30 PK	74.00	-1.70	1.03 V	260	39.97	32.33
2	2390.00	51.54 AV	54.00	-2.46	1.03 V	260	19.21	32.33
3	*2412.00	111.84 PK			1.03 V	261	79.41	32.43
4	*2412.00	101.69 AV			1.03 V	261	69.26	32.43
5	4824.00	57.47 PK	74.00	-16.53	1.04 V	17	19.30	38.17
6	4824.00	40.48 AV	54.00	-13.52	1.04 V	17	2.31	38.17

**REMARKS:** 1. Emission level (dBuV/m) = Raw Value (dBuV) + Correction Factor (dB/m).

2. Correction Factor (dB/m) = Antenna Factor (dB/m) + Cable Factor (dB).

3. The other emission levels were very low against the limit.

4. Margin value = Emission level – Limit value.

5. The limit value is defined as per 15.247.

6. “ \* “: Fundamental frequency.

EUT TEST CONDITION		MEASUREMENT DETAIL	
CHANNEL	Channel 6	FREQUENCY RANGE	1 ~ 25GHz
MODULATION TYPE	BPSK	INPUT POWER (SYSTEM)	120Vac, 60 Hz
TRANSFER RATE	6.5Mbps	DETECTOR FUNCTION	Peak(PK) Average (AV)
ENVIRONMENTAL CONDITIONS	27deg. C, 68% RH, 985hPa	TESTED BY	Dean Wang

ANTENNA POLARITY & TEST DISTANCE: HORIZONTAL AT 3 M								
NO.	FREQ. (MHz)	EMISSION LEVEL (dBuV/m)	LIMIT (dBuV/m)	MARGIN (dB)	ANTENNA HEIGHT (m)	TABLE ANGLE (Degree)	RAW VALUE (dBuV)	CORRECTION FACTOR (dB/m)
1	*2437.00	114.17 PK			1.01 H	5	81.63	32.54
2	*2437.00	104.05 AV			1.01 H	5	71.51	32.54
3	4874.00	59.60 PK	74.00	-14.40	1.00 H	10	21.25	38.35
4	4874.00	39.83 AV	54.00	-14.17	1.00 H	10	1.48	38.35

ANTENNA POLARITY & TEST DISTANCE: VERTICAL AT 3 M								
NO.	FREQ. (MHz)	EMISSION LEVEL (dBuV/m)	LIMIT (dBuV/m)	MARGIN (dB)	ANTENNA HEIGHT (m)	TABLE ANGLE (Degree)	RAW VALUE (dBuV)	CORRECTION FACTOR (dB/m)
1	*2437.00	114.87 PK			1.02 V	267	82.33	32.54
2	*2437.00	104.83 AV			1.02 V	267	72.29	32.54
3	4874.00	60.35 PK	74.00	-13.65	1.09 V	69	22.00	38.35
4	4874.00	42.32 AV	54.00	-11.68	1.09 V	69	3.97	38.35

- REMARKS:**
1. Emission level (dBuV/m) = Raw Value (dBuV) + Correction Factor (dB/m).
  2. Correction Factor (dB/m) = Antenna Factor (dB/m) + Cable Factor (dB).
  3. The other emission levels were very low against the limit.
  4. Margin value = Emission level – Limit value.
  5. The limit value is defined as per 15.247.
  6. “ \* “: Fundamental frequency.

EUT TEST CONDITION		MEASUREMENT DETAIL	
CHANNEL	Channel 11	FREQUENCY RANGE	1 ~ 25GHz
MODULATION TYPE	BPSK	INPUT POWER (SYSTEM)	120Vac, 60 Hz
TRANSFER RATE	6.5Mbps	DETECTOR FUNCTION	Peak(PK) Average (AV)
ENVIRONMENTAL CONDITIONS	27deg. C, 68% RH, 985hPa	TESTED BY	Dean Wang

ANTENNA POLARITY & TEST DISTANCE: HORIZONTAL AT 3 M								
NO.	FREQ. (MHz)	EMISSION LEVEL (dBuV/m)	LIMIT (dBuV/m)	MARGIN (dB)	ANTENNA HEIGHT (m)	TABLE ANGLE (Degree)	RAW VALUE (dBuV)	CORRECTION FACTOR (dB/m)
1	*2462.00	112.02 PK			1.04 H	14	79.37	32.65
2	*2462.00	101.79 AV			1.04 H	14	69.14	32.65
3	2483.50	68.48 PK	74.00	-5.52	1.00 H	21	35.74	32.74
4	2483.50	51.48 AV	54.00	-2.52	1.00 H	21	18.74	32.74
5	4924.00	52.40 PK	74.00	-21.60	1.05 H	36	13.93	38.47
6	4924.00	36.27 AV	54.00	-17.73	1.05 H	36	-2.20	38.47

ANTENNA POLARITY & TEST DISTANCE: VERTICAL AT 3 M								
NO.	FREQ. (MHz)	EMISSION LEVEL (dBuV/m)	LIMIT (dBuV/m)	MARGIN (dB)	ANTENNA HEIGHT (m)	TABLE ANGLE (Degree)	RAW VALUE (dBuV)	CORRECTION FACTOR (dB/m)
1	*2462.00	111.86 PK			1.00 V	259	79.21	32.65
2	*2462.00	101.87 AV			1.00 V	259	69.22	32.65
3	2483.50	69.91 PK	74.00	-4.09	1.00 V	260	37.17	32.74
4	2483.50	52.69 AV	54.00	-1.31	1.00 V	260	19.95	32.74
5	4924.00	55.96 PK	74.00	-18.04	1.00 V	29	17.49	38.47
6	4924.00	39.50 AV	54.00	-14.50	1.00 V	29	1.03	38.47

- REMARKS:**
1. Emission level (dBuV/m) = Raw Value (dBuV) + Correction Factor (dB/m).
  2. Correction Factor (dB/m) = Antenna Factor (dB/m) + Cable Factor (dB).
  3. The other emission levels were very low against the limit.
  4. Margin value = Emission level – Limit value.
  5. The limit value is defined as per 15.247.
  6. “ \* “: Fundamental frequency.



### DRAFT 802.11n (40MHz) OFDM MODULATION

EUT TEST CONDITION		MEASUREMENT DETAIL	
CHANNEL	Channel 1	FREQUENCY RANGE	1 ~ 25GHz
MODULATION TYPE	BPSK	INPUT POWER (SYSTEM)	120Vac, 60 Hz
TRANSFER RATE	13.5Mbps	DETECTOR FUNCTION	Peak(PK) Average (AV)
ENVIRONMENTAL CONDITIONS	27deg. C, 68% RH, 985hPa	TESTED BY	Dean Wang

ANTENNA POLARITY & TEST DISTANCE: HORIZONTAL AT 3 M								
NO.	FREQ. (MHz)	EMISSION LEVEL (dBuV/m)	LIMIT (dBuV/m)	MARGIN (dB)	ANTENNA HEIGHT (m)	TABLE ANGLE (Degree)	RAW VALUE (dBuV)	CORRECTION FACTOR (dB/m)
1	2390.00	65.94 PK	74.00	-8.06	1.07 H	17	33.61	32.33
2	2390.00	52.88 AV	54.00	-1.12	1.07 H	17	20.55	32.33
3	*2422.00	108.78 PK			1.06 H	18	76.31	32.47
4	*2422.00	98.31 AV			1.06 H	18	65.84	32.47
5	4844.00	49.92 PK	74.00	-24.08	1.00 H	248	11.68	38.24
6	4844.00	36.73 AV	54.00	-17.27	1.00 H	248	-1.51	38.24

ANTENNA POLARITY & TEST DISTANCE: VERTICAL AT 3 M								
NO.	FREQ. (MHz)	EMISSION LEVEL (dBuV/m)	LIMIT (dBuV/m)	MARGIN (dB)	ANTENNA HEIGHT (m)	TABLE ANGLE (Degree)	RAW VALUE (dBuV)	CORRECTION FACTOR (dB/m)
1	2390.00	62.47 PK	74.00	-11.53	1.26 V	260	30.14	32.33
2	2390.00	49.58 AV	54.00	-4.42	1.26 V	260	17.25	32.33
3	*2422.00	107.37 PK			1.28 V	263	74.90	32.47
4	*2422.00	97.13 AV			1.28 V	263	64.66	32.47
5	4844.00	52.26 PK	74.00	-21.74	1.05 V	63	14.02	38.24
6	4844.00	38.91 AV	54.00	-15.09	1.05 V	63	0.67	38.24

**REMARKS:** 1. Emission level (dBuV/m) = Raw Value (dBuV) + Correction Factor (dB/m).

2. Correction Factor (dB/m) = Antenna Factor (dB/m) + Cable Factor (dB).

3. The other emission levels were very low against the limit.

4. Margin value = Emission level – Limit value.

5. The limit value is defined as per 15.247.

6. “ \* “: Fundamental frequency.

EUT TEST CONDITION		MEASUREMENT DETAIL	
CHANNEL	Channel 4	FREQUENCY RANGE	1 ~ 25GHz
MODULATION TYPE	BPSK	INPUT POWER (SYSTEM)	120Vac, 60 Hz
TRANSFER RATE	13.5Mbps	DETECTOR FUNCTION	Peak(PK) Average (AV)
ENVIRONMENTAL CONDITIONS	27deg. C, 68% RH, 985hPa	TESTED BY	Dean Wang

ANTENNA POLARITY & TEST DISTANCE: HORIZONTAL AT 3 M								
NO.	FREQ. (MHz)	EMISSION LEVEL (dBuV/m)	LIMIT (dBuV/m)	MARGIN (dB)	ANTENNA HEIGHT (m)	TABLE ANGLE (Degree)	RAW VALUE (dBuV)	CORRECTION FACTOR (dB/m)
1	*2437.00	108.99 PK			1.03 H	15	76.45	32.54
2	*2437.00	98.63 AV			1.03 H	15	66.09	32.54
3	2483.50	71.81 PK	74.00	-2.19	1.01 H	14	39.07	32.74
4	2483.50	52.67 AV	54.00	-1.33	1.01 H	14	19.93	32.74
5	4874.00	50.64 PK	74.00	-23.36	1.00 H	267	12.29	38.35
6	4874.00	37.42 AV	54.00	-16.58	1.00 H	267	-0.93	38.35

ANTENNA POLARITY & TEST DISTANCE: VERTICAL AT 3 M								
NO.	FREQ. (MHz)	EMISSION LEVEL (dBuV/m)	LIMIT (dBuV/m)	MARGIN (dB)	ANTENNA HEIGHT (m)	TABLE ANGLE (Degree)	RAW VALUE (dBuV)	CORRECTION FACTOR (dB/m)
1	*2437.00	108.42 PK			1.02 V	351	75.88	32.54
2	*2437.00	98.27 AV			1.02 V	351	65.73	32.54
3	2483.50	70.24 PK	74.00	-3.76	1.00 V	164	37.50	32.74
4	2483.50	51.58 AV	54.00	-2.42	1.00 V	164	18.84	32.74
5	4874.00	52.97 PK	74.00	-21.03	1.00 V	56	14.62	38.35
6	4874.00	39.71 AV	54.00	-14.29	1.00 V	56	1.36	38.35

- REMARKS:**
1. Emission level (dBuV/m) = Raw Value (dBuV) + Correction Factor (dB/m).
  2. Correction Factor (dB/m) = Antenna Factor (dB/m) + Cable Factor (dB).
  3. The other emission levels were very low against the limit.
  4. Margin value = Emission level – Limit value.
  5. The limit value is defined as per 15.247.
  6. “ \* “: Fundamental frequency.

EUT TEST CONDITION		MEASUREMENT DETAIL	
CHANNEL	Channel 7	FREQUENCY RANGE	1 ~ 25GHz
MODULATION TYPE	BPSK	INPUT POWER (SYSTEM)	120Vac, 60 Hz
TRANSFER RATE	13.5Mbps	DETECTOR FUNCTION	Peak(PK) Average (AV)
ENVIRONMENTAL CONDITIONS	27deg. C, 68% RH, 985hPa	TESTED BY	Dean Wang

ANTENNA POLARITY & TEST DISTANCE: HORIZONTAL AT 3 M								
NO.	FREQ. (MHz)	EMISSION LEVEL (dBuV/m)	LIMIT (dBuV/m)	MARGIN (dB)	ANTENNA HEIGHT (m)	TABLE ANGLE (Degree)	RAW VALUE (dBuV)	CORRECTION FACTOR (dB/m)
1	*2452.00	107.07 PK			1.01 H	15	74.47	32.60
2	*2452.00	97.24 AV			1.01 H	15	64.64	32.60
3	2483.50	65.32 PK	74.00	-8.68	1.02 H	16	32.58	32.74
4	2483.50	52.86 AV	54.00	-1.14	1.02 H	16	20.12	32.74
5	4904.00	48.96 PK	74.00	-25.04	1.03 H	247	10.51	38.45
6	4904.00	36.14 AV	54.00	-17.86	1.03 H	247	-2.31	38.45

ANTENNA POLARITY & TEST DISTANCE: VERTICAL AT 3 M								
NO.	FREQ. (MHz)	EMISSION LEVEL (dBuV/m)	LIMIT (dBuV/m)	MARGIN (dB)	ANTENNA HEIGHT (m)	TABLE ANGLE (Degree)	RAW VALUE (dBuV)	CORRECTION FACTOR (dB/m)
1	*2452.00	106.31 PK			1.00 V	214	73.71	32.60
2	*2452.00	96.57 AV			1.00 V	214	63.97	32.60
3	2483.50	63.27 PK	74.00	-10.73	1.03 V	246	30.53	32.74
4	2483.50	50.73 AV	54.00	-3.27	1.03 V	246	17.99	32.74
5	4904.00	50.78 PK	74.00	-23.22	1.03 V	165	12.33	38.45
6	4904.00	38.10 AV	54.00	-15.90	1.03 V	165	-0.35	38.45

- REMARKS:**
1. Emission level (dBuV/m) = Raw Value (dBuV) + Correction Factor (dB/m).
  2. Correction Factor (dB/m) = Antenna Factor (dB/m) + Cable Factor (dB).
  3. The other emission levels were very low against the limit.
  4. Margin value = Emission level – Limit value.
  5. The limit value is defined as per 15.247.
  6. “ \* “: Fundamental frequency.



### 4.3 6dB BANDWIDTH MEASUREMENT

#### 4.3.1 LIMITS OF 6dB BANDWIDTH MEASUREMENT

The minimum of 6dB Bandwidth Measurement is 0.5 MHz.

#### 4.3.2 TEST INSTRUMENTS

DESCRIPTION & MANUFACTURER	MODEL NO.	SERIAL NO.	CALIBRATED UNTIL
SPECTRUM ANALYZER	FSP40	100040	Jun. 28, 2008

**NOTE:** The calibration interval of the above test instruments is 12 months and the calibrations are traceable to NML/ROC and NIST/USA.

#### 4.3.3 TEST PROCEDURE

The transmitter output was connected to the spectrum analyzer through an attenuator. The bandwidth of the fundamental frequency was measured by spectrum analyzer with 100kHz RBW and 300kHz VBW. The 6dB bandwidth is defined as the total spectrum the power of which is higher than peak power minus 6dB.

#### 4.3.4 DEVIATION FROM TEST STANDARD

No deviation

#### 4.3.5 TEST SETUP

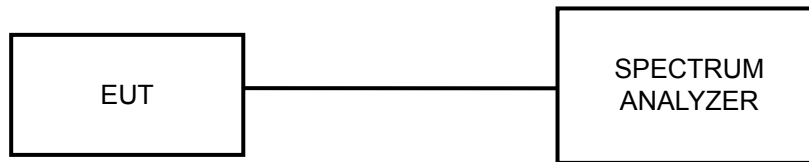

#### 4.3.6 EUT OPERATING CONDITIONS

The software provided by client to enable the EUT under transmission condition continuously at lowest, middle and highest channel frequencies individually.

### 4.3.7 TEST RESULTS

#### 802.11b DSSS MODULATION

<b>MODULATION TYPE</b>	DBPSK	<b>TRANSFER RATE</b>	1.0Mbps
<b>INPUT POWER (SYSTEM)</b>	120Vac, 60 Hz	<b>ENVIRONMENTAL CONDITIONS</b>	26deg.C, 66% RH, 991hPa
<b>TESTED BY</b>	Brad Wu		

CHANNEL	CHANNEL FREQUENCY (MHz)	6dB BANDWIDTH (MHz)	MINIMUM LIMIT (MHz)	PASS / FAIL
1	2412	12.16	0.5	PASS
6	2437	12.16	0.5	PASS
11	2462	12.16	0.5	PASS

#### CH 1

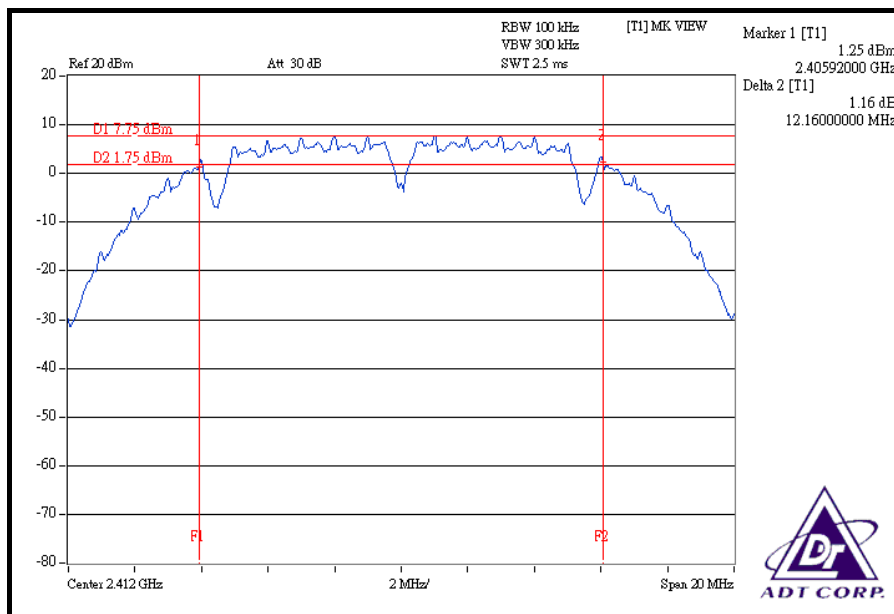

### CH 6

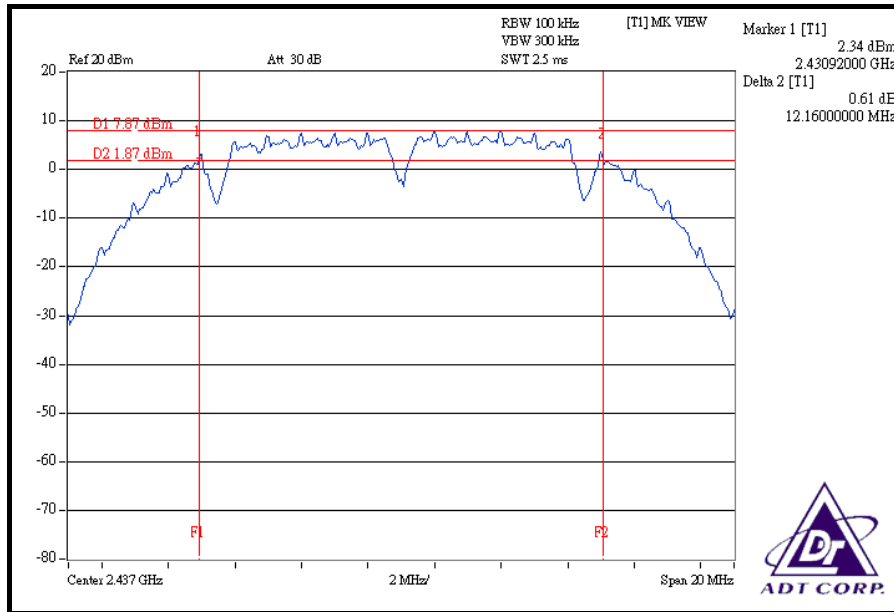

### CH 11

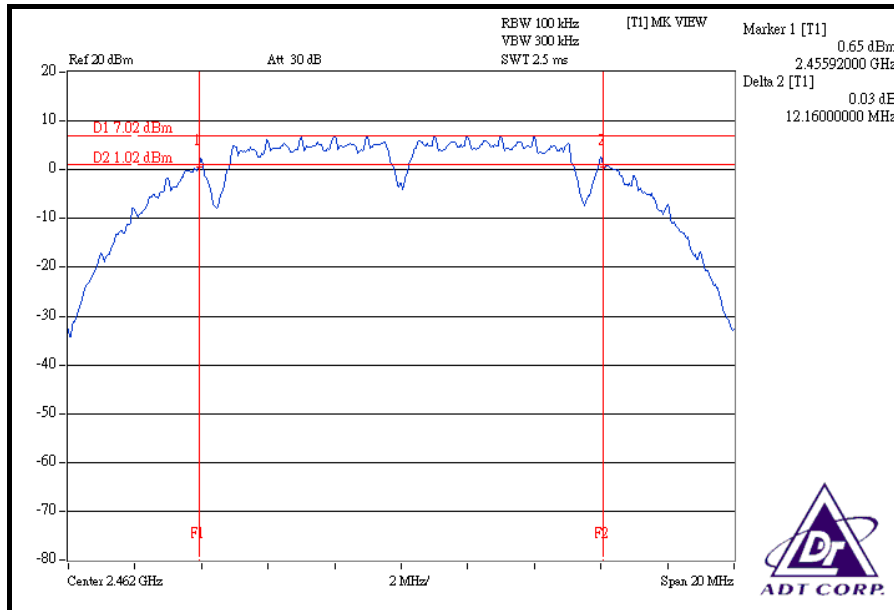



### 802.11g OFDM MODULATION

<b>MODULATION TYPE</b>	BPSK	<b>TRANSFER RATE</b>	6.0Mbps
<b>INPUT POWER (SYSTEM)</b>	120Vac, 60 Hz	<b>ENVIRONMENTAL CONDITIONS</b>	26deg.C, 66% RH, 991hPa
<b>TESTED BY</b>	Brad Wu		

CHANNEL	CHANNEL FREQUENCY (MHz)	6dB BANDWIDTH (MHz)	MINIMUM LIMIT (MHz)	PASS / FAIL
1	2412	16.60	0.5	PASS
6	2437	16.60	0.5	PASS
11	2462	16.64	0.5	PASS

### CH 1

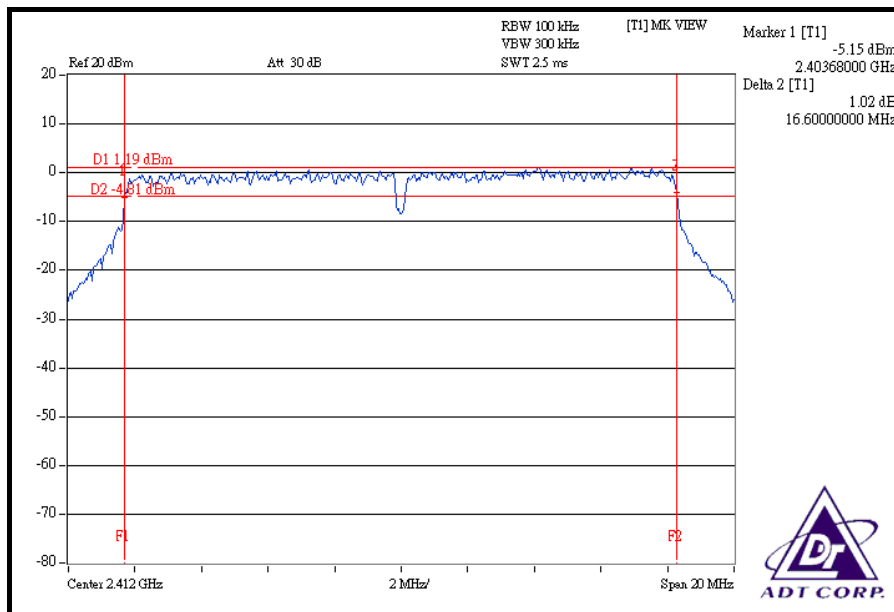



### CH 6

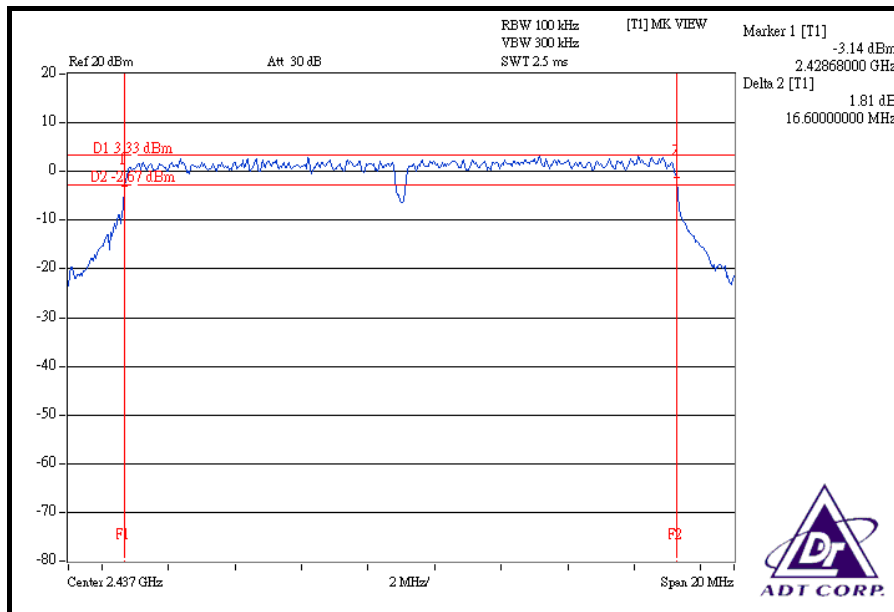

### CH 11

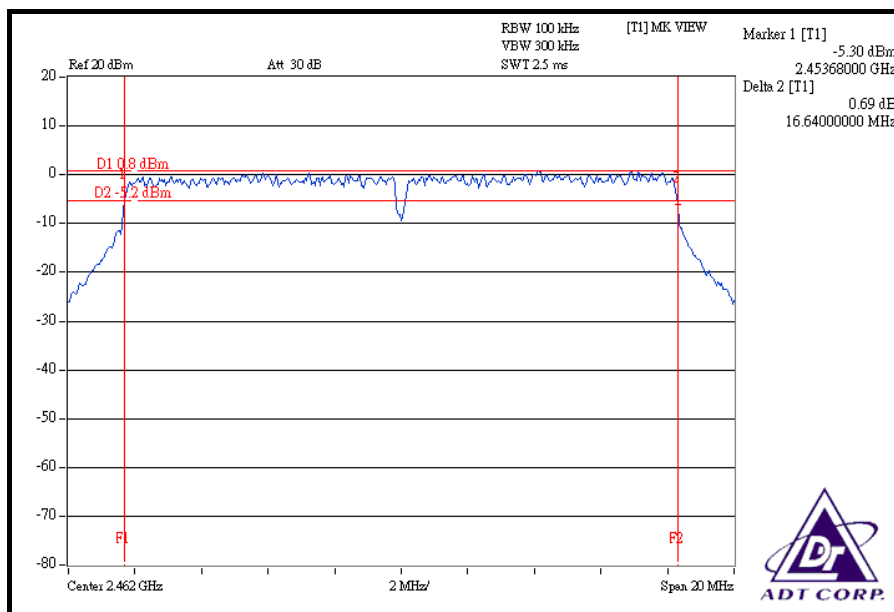



**DRAFT 802.11n (20MHz) OFDM MODULATION**

<b>MODULATION TYPE</b>	BPSK	<b>TRANSFER RATE</b>	6.5Mbps
<b>INPUT POWER (SYSTEM)</b>	120Vac, 60 Hz	<b>ENVIRONMENTAL CONDITIONS</b>	26deg.C, 66% RH, 991hPa
<b>TESTED BY</b>	Brad Wu		

CHANNEL	CHANNEL FREQUENCY (MHz)	6dB BANDWIDTH (MHz)		MINIMUM LIMIT (MHz)	PASS / FAIL
		CHAIN 0	CHAIN 1		
1	2412	17.76	17.76	0.5	PASS
6	2437	17.80	17.76	0.5	PASS
11	2462	17.76	17.76	0.5	PASS

**FOR CHAIN 0: CH 1**

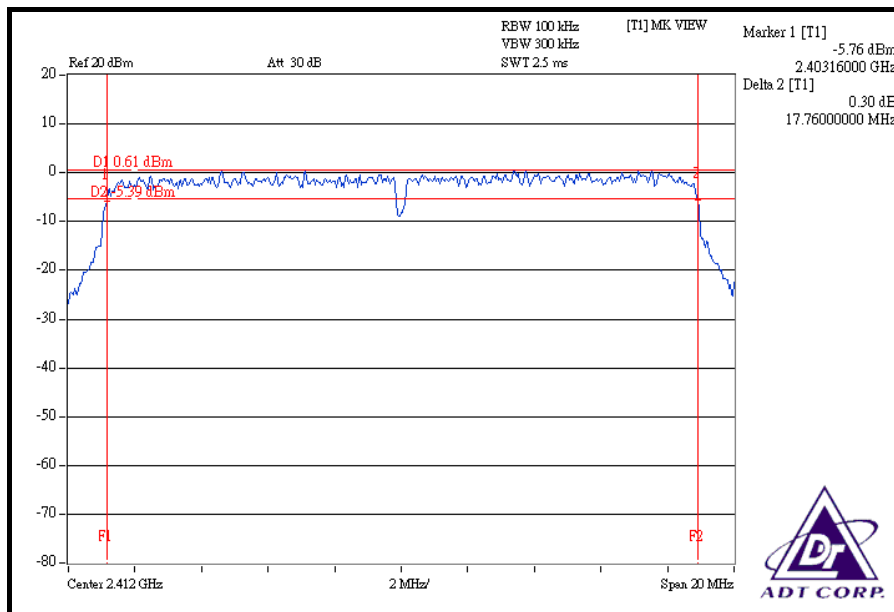

### CH 6

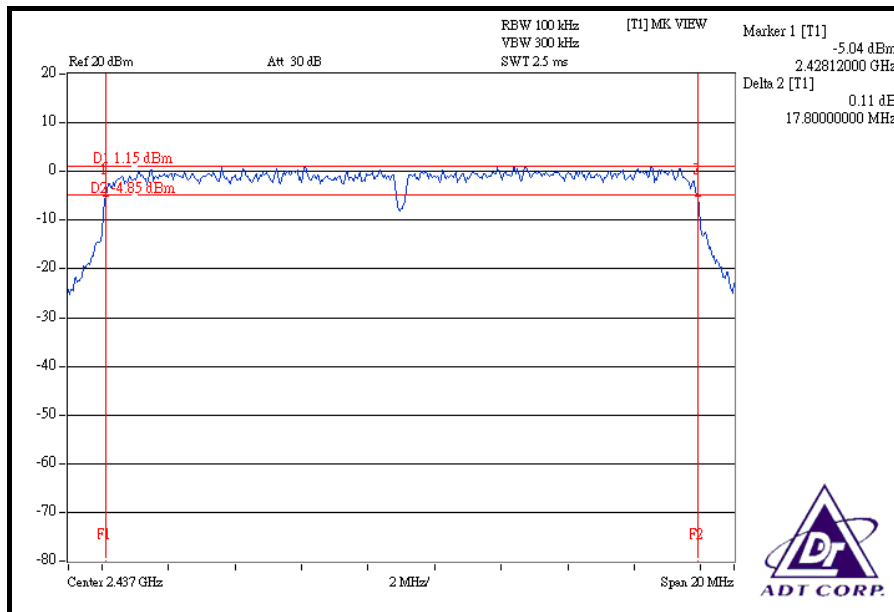

### CH 11

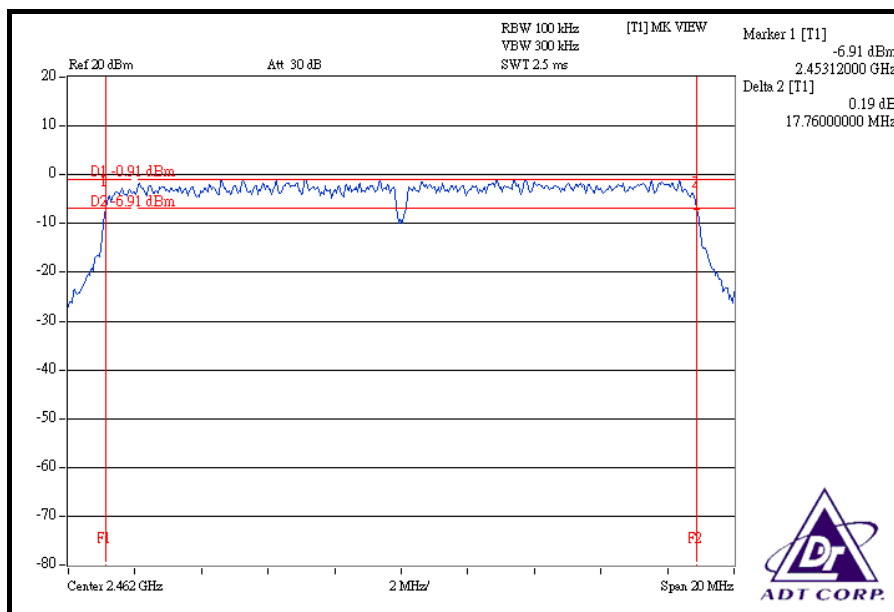

### FOR CHAIN 1: CH 1

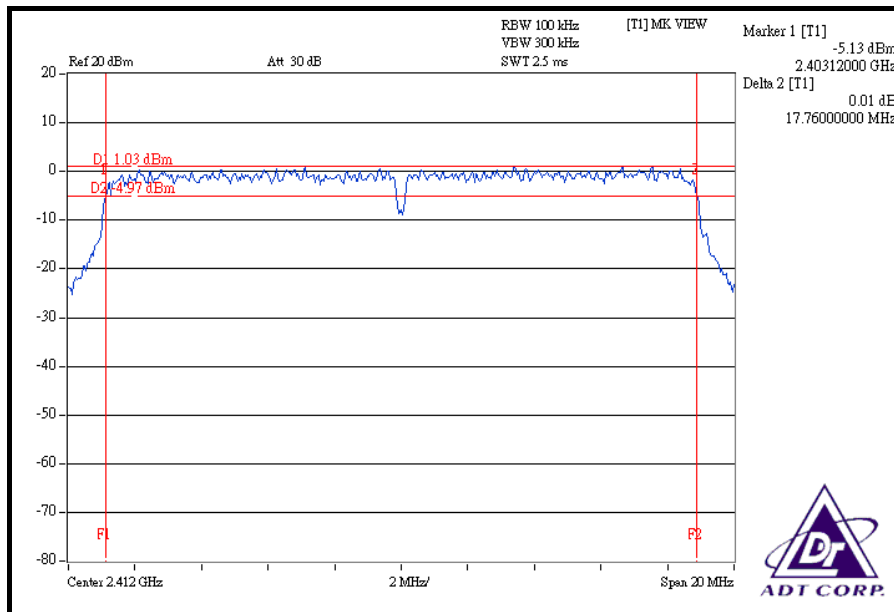

### CH 6

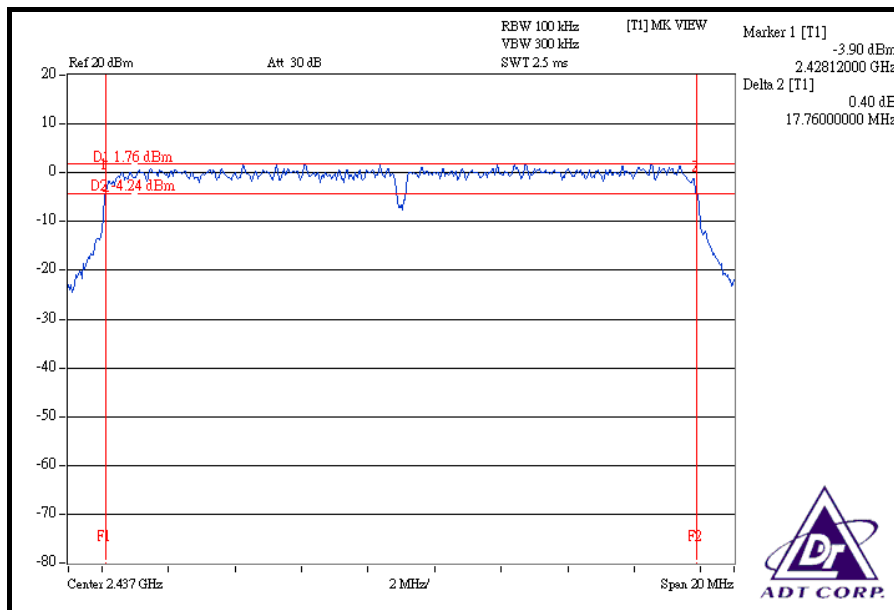

CH 11

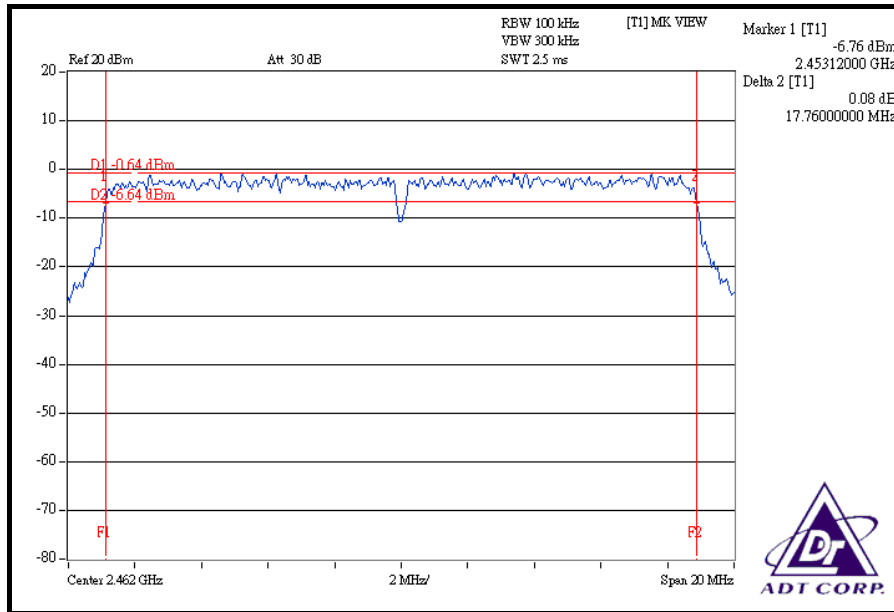



**DRAFT 802.11n (40MHz) OFDM MODULATION**

<b>MODULATION TYPE</b>	BPSK	<b>TRANSFER RATE</b>	13.5Mbps
<b>INPUT POWER (SYSTEM)</b>	120Vac, 60 Hz	<b>ENVIRONMENTAL CONDITIONS</b>	27deg.C, 65% RH, 991hPa
<b>TESTED BY</b>	Match Tsui		

CHANNEL	CHANNEL FREQUENCY (MHz)	6dB BANDWIDTH (MHz)		MINIMUM LIMIT (MHz)	PASS / FAIL
		CHAIN 0	CHAIN 1		
1	2422	36.40	36.40	0.5	PASS
4	2437	36.48	36.56	0.5	PASS
7	2452	36.56	36.56	0.5	PASS

**FOR CHAIN 0: CH 1**

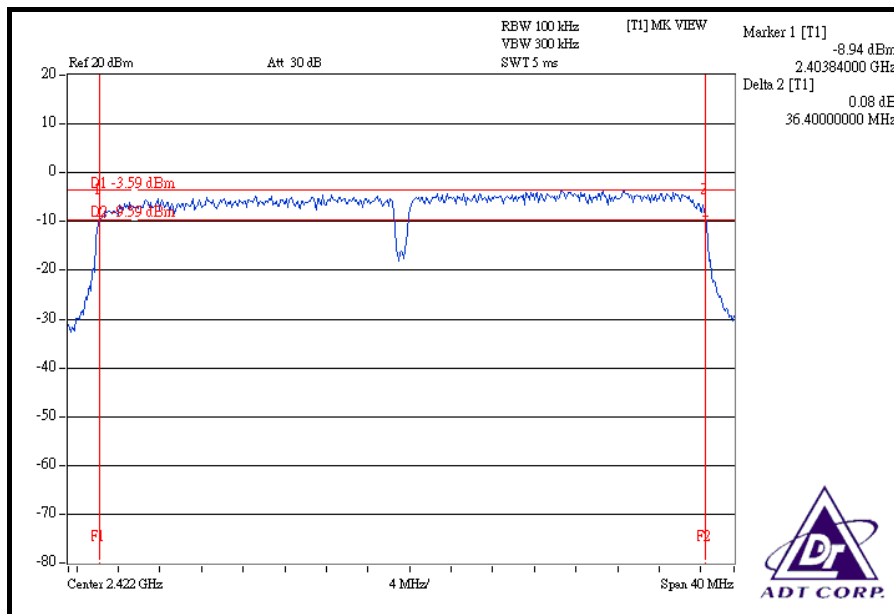

### CH 4

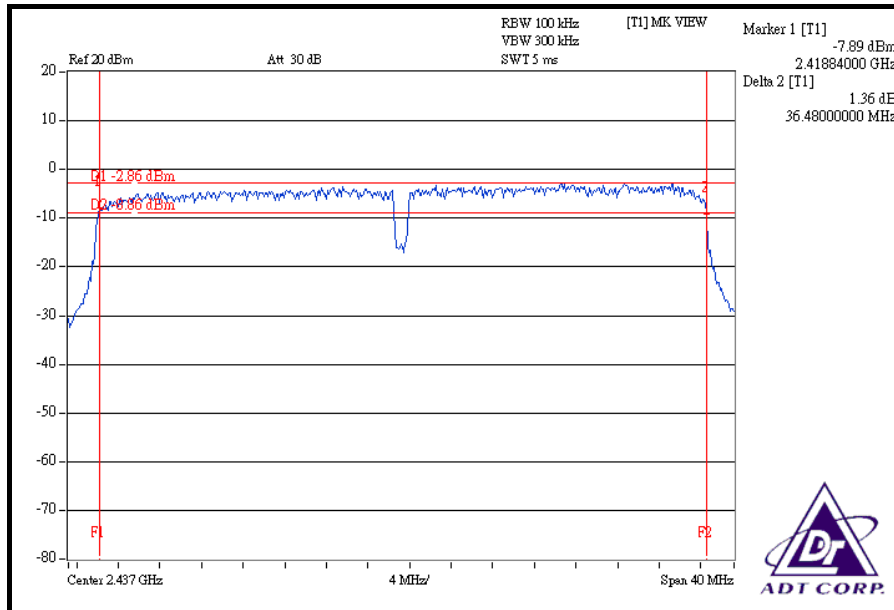

### CH 7

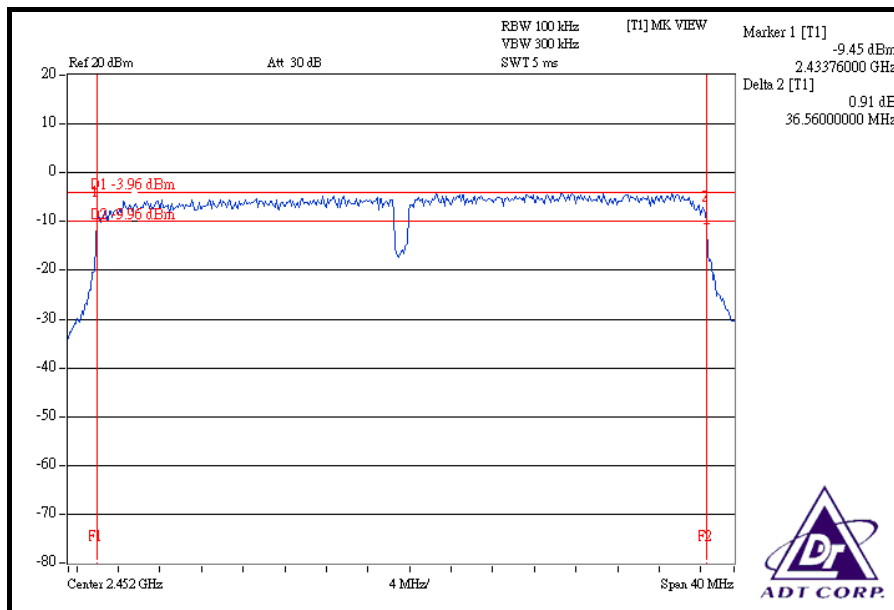

**FOR CHAIN 1: CH 1**

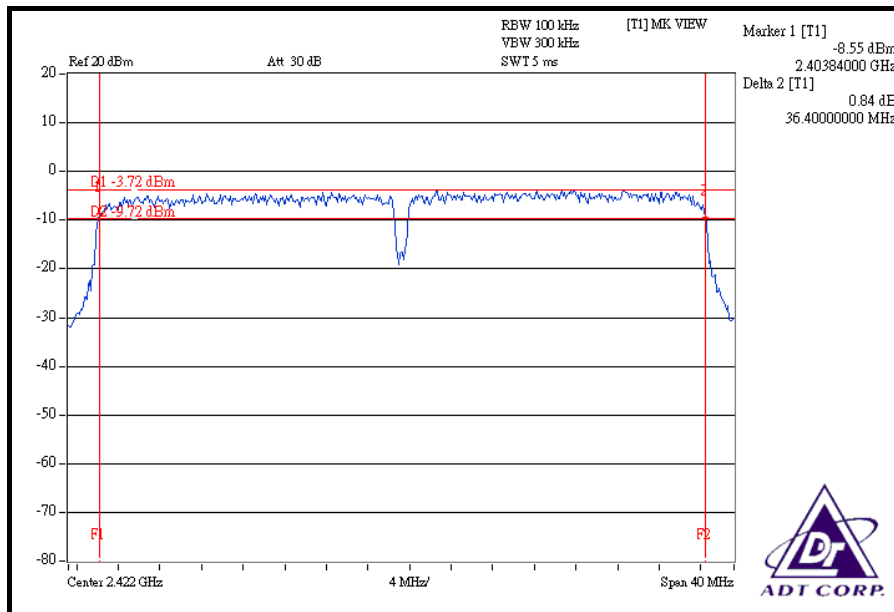

**CH 4**

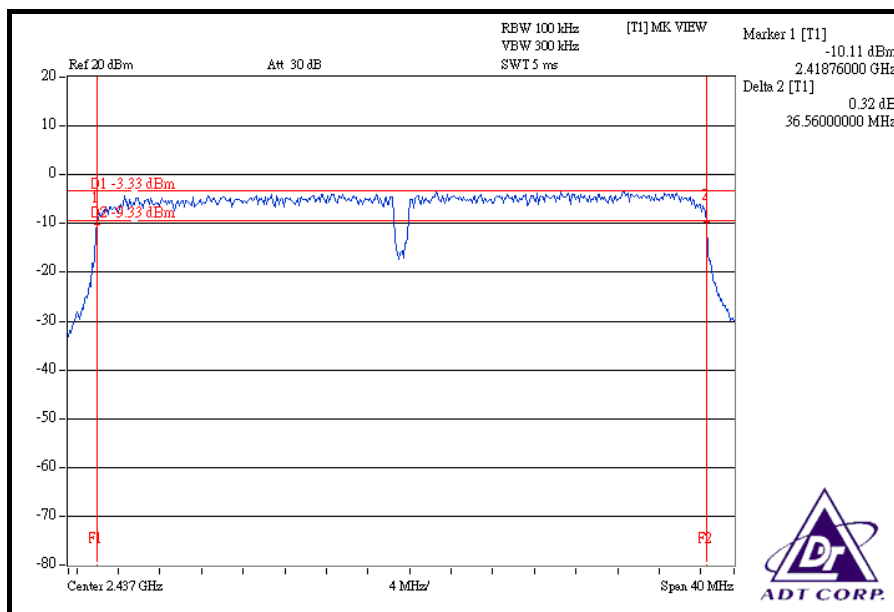



CH 7

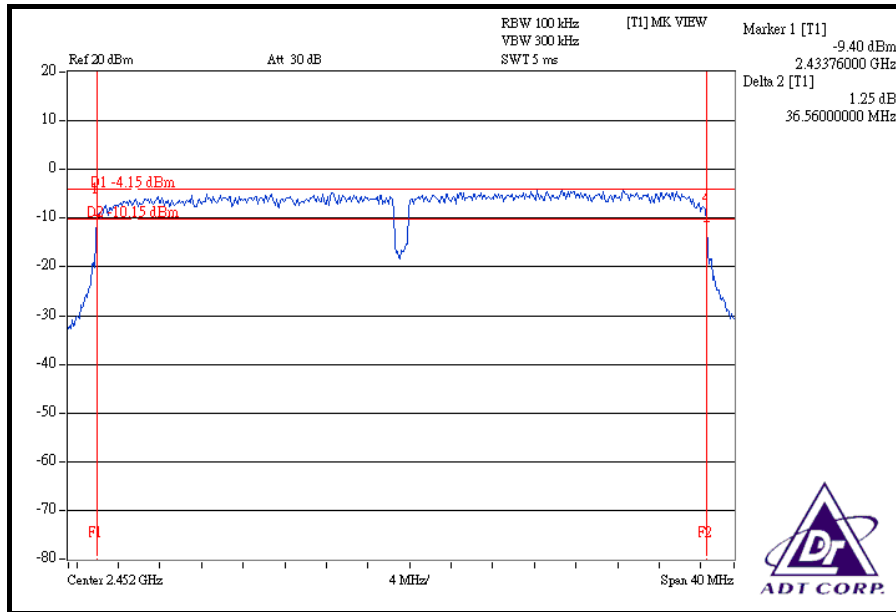



#### 4.4 MAXIMUM PEAK OUTPUT POWER

##### 4.4.1 LIMITS OF MAXIMUM PEAK OUTPUT POWER MEASUREMENT

The Maximum Peak Output Power Measurement is 30dBm.

##### 4.4.2 INSTRUMENTS

DESCRIPTION & MANUFACTURER	MODEL NO.	SERIAL NO.	CALIBRATED UNTIL
R&S SPECTRUM ANALYZER	FSP 40	100040	Jun. 28, 2008
AGILENT SYNTHESIZED SIGNAL GENERATOR	E8257C	MY43320668	Dec. 28, 2007
DIGITAL RT OSCILLOSCOPE	TDS1012	C037299	Nov. 28, 2007
NARDA DETECTOR	4503A	FSCM99899	NA

**NOTE:** The calibration interval of the above test instruments is 12 months and the calibrations are traceable to NML/ROC and NIST/USA.

##### 4.4.3 TEST PROCEDURES

- a. A detector was used on the output port of the EUT. An oscilloscope was used to read the response of the detector.
- b. Replaced the EUT by the signal generator. The center frequency of the S.G was adjusted to the center frequency of the measured channel.
- c. Adjusted the power to have the same reading on oscilloscope. Record the power level.

##### 4.4.4 DEVIATION FROM TEST STANDARD

No deviation

#### 4.4.5 TEST SETUP



#### 4.4.6 EUT OPERATING CONDITIONS

Same as Item 4.3.6

#### 4.4.7 TEST RESULTS

##### 802.11b DSSS MODULATION

<b>MODULATION TYPE</b>	DBPSK	<b>TRANSFER RATE</b>	1.0Mbps
<b>INPUT POWER (SYSTEM)</b>	120Vac, 60 Hz	<b>ENVIRONMENTAL CONDITIONS</b>	26deg.C, 66% RH, 991hPa
<b>TESTED BY</b>	Brad Wu		

CHANNEL	CHANNEL FREQUENCY (MHz)	PEAK POWER OUTPUT (mW)	PEAK POWER OUTPUT (dBm)	PEAK POWER LIMIT (dBm)	PASS / FAIL
1	2412	102.802	20.12	30	PASS
6	2437	102.802	20.12	30	PASS
11	2462	89.331	19.51	30	PASS

##### 802.11g OFDM MODULATION

<b>MODULATION TYPE</b>	BPSK	<b>TRANSFER RATE</b>	6.0Mbps
<b>INPUT POWER (SYSTEM)</b>	120Vac, 60 Hz	<b>ENVIRONMENTAL CONDITIONS</b>	26deg.C, 66% RH, 991hPa
<b>TESTED BY</b>	Brad Wu		

CHANNEL	CHANNEL FREQUENCY (MHz)	PEAK POWER OUTPUT (mW)	PEAK POWER OUTPUT (dBm)	PEAK POWER LIMIT (dBm)	PASS / FAIL
1	2412	91.201	19.60	30	PASS
6	2437	144.877	21.61	30	PASS
11	2462	81.658	19.12	30	PASS



### DRAFT 802.11n (20MHz) OFDM MODULATION

<b>MODULATION TYPE</b>	BPSK	<b>TRANSFER RATE</b>	6.5Mbps
<b>INPUT POWER (SYSTEM)</b>	120Vac, 60 Hz	<b>ENVIRONMENTAL CONDITIONS</b>	26deg.C, 66% RH, 991hPa
<b>TESTED BY</b>	Brad Wu		

CHAN.	CHANNEL FREQUENCY (MHz)	PEAK POWER OUTPUT (mW)		PEAK POWER OUTPUT (dBm)		TOTAL PEAK POWER (mW)	TOTAL PEAK POWER (dBm)	PEAK POWER LIMIT (dBm)	PASS / FAIL
		CHAIN 0	CHAIN 1	CHAIN 0	CHAIN 1				
1	2412	80.538	90.157	19.06	19.55	170.695	22.32	30	PASS
6	2437	102.565	103.039	20.11	20.13	205.604	23.13	30	PASS
11	2462	63.241	63.680	18.01	18.04	126.921	21.04	30	PASS

### DRAFT 802.11n (40MHz) OFDM MODULATION

<b>MODULATION TYPE</b>	BPSK	<b>TRANSFER RATE</b>	13.5Mbps
<b>INPUT POWER (SYSTEM)</b>	120Vac, 60 Hz	<b>ENVIRONMENTAL CONDITIONS</b>	26deg.C, 66% RH, 991hPa
<b>TESTED BY</b>	Brad Wu		

CHAN.	CHANNEL FREQUENCY (MHz)	PEAK POWER OUTPUT (mW)		PEAK POWER OUTPUT (dBm)		TOTAL PEAK POWER (mW)	TOTAL PEAK POWER (dBm)	PEAK POWER LIMIT (dBm)	PASS / FAIL
		CHAIN 0	CHAIN 1	CHAIN 0	CHAIN 1				
1	2422	57.677	57.544	17.61	17.60	115.221	20.62	30	PASS
4	2437	64.121	63.387	18.07	18.02	127.508	21.06	30	PASS
7	2452	50.234	51.050	17.01	17.08	101.284	20.06	30	PASS



## 4.5 POWER SPECTRAL DENSITY MEASUREMENT

### 4.5.1 LIMITS OF POWER SPECTRAL DENSITY MEASUREMENT

The Maximum of Power Spectral Density Measurement is 8dBm.

### 4.5.2 TEST INSTRUMENTS

DESCRIPTION & MANUFACTURER	MODEL NO.	SERIAL NO.	CALIBRATED UNTIL
R&S SPECTRUM ANALYZER	FSP 40	100040	Jun. 28, 2008

**NOTE:** The calibration interval of the above test instruments is 12 months and the calibrations are traceable to NML/ROC and NIST/USA.

### 4.5.3 TEST PROCEDURE

The transmitter output was connected to the spectrum analyzer through an attenuator, the bandwidth of the fundamental frequency was measured with the spectrum analyzer using 3kHz RBW and 30kHz VBW, set sweep time = span/3kHz. The power spectral density was measured and recorded.

The sweep time is allowed to be longer than span/3kHz for a full response of the mixer in the spectrum analyzer.

### 4.5.4 DEVIATION FROM TEST STANDARD

No deviation

#### 4.5.5 TEST SETUP

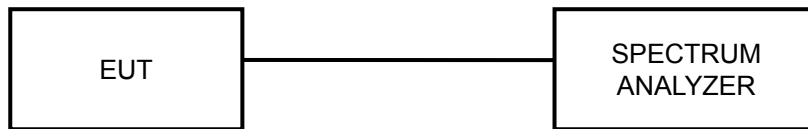

#### 4.5.6 EUT OPERATING CONDITION

Same as Item 4.3.6

## 4.5.7 TEST RESULTS

### 802.11b DSSS MODULATION

<b>MODULATION TYPE</b>	DBPSK	<b>TRANSFER RATE</b>	1.0Mbps
<b>INPUT POWER (SYSTEM)</b>	120Vac, 60 Hz	<b>ENVIRONMENTAL CONDITIONS</b>	26deg.C, 66% RH, 991hPa
<b>TESTED BY</b>	Brad Wu		

CHANNEL	CHANNEL FREQUENCY (MHz)	RF POWER LEVEL IN 3kHz BW (dBm)	MAXIMUM LIMIT (dBm)	PASS / FAIL
1	2412	-10.56	8	PASS
6	2437	-10.44	8	PASS
11	2462	-11.27	8	PASS

### CH 1

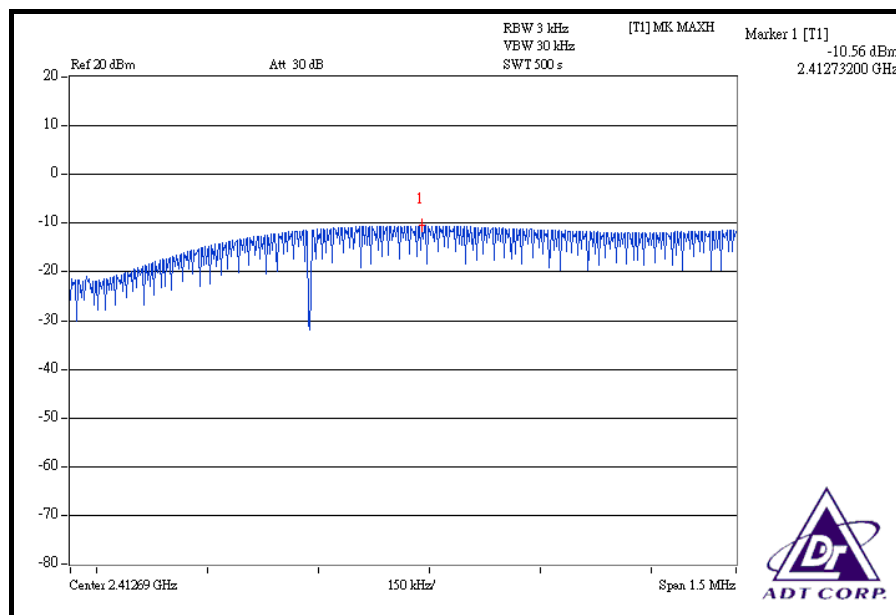





### 802.11g OFDM MODULATION

<b>MODULATION TYPE</b>	BPSK	<b>TRANSFER RATE</b>	6.0Mbps
<b>INPUT POWER (SYSTEM)</b>	120Vac, 60 Hz	<b>ENVIRONMENTAL CONDITIONS</b>	26deg.C, 66% RH, 991hPa
<b>TESTED BY</b>	Brad Wu		

CHANNEL	CHANNEL FREQUENCY (MHz)	RF POWER LEVEL IN 3kHz BW (dBm)	MAXIMUM LIMIT (dBm)	PASS / FAIL
1	2412	-13.33	8	PASS
6	2437	-11.36	8	PASS
11	2462	-13.62	8	PASS

### CH 1

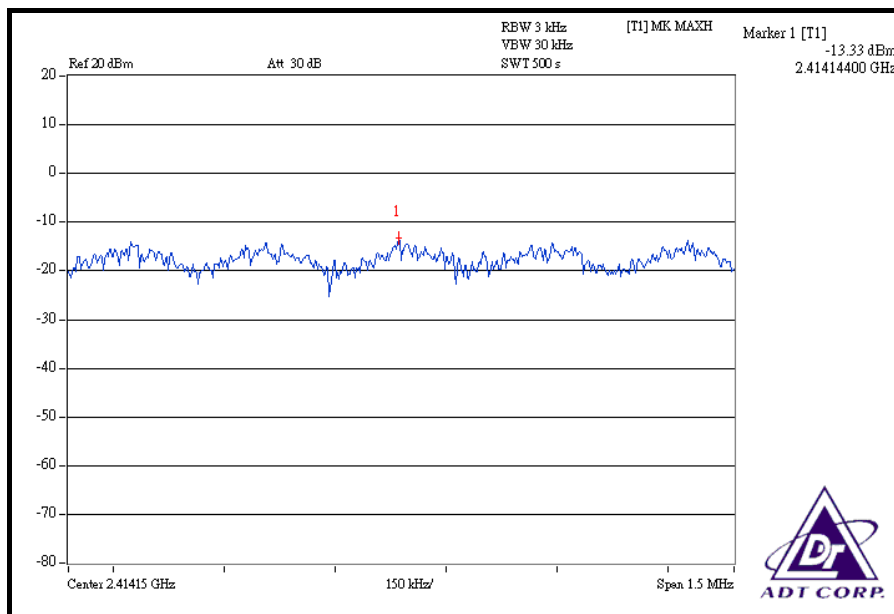

### CH 6

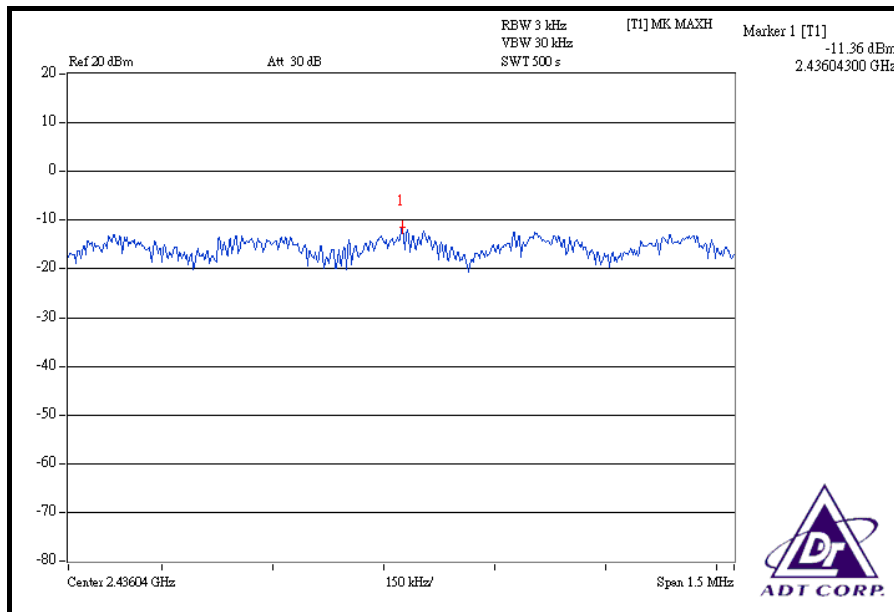

### CH 11

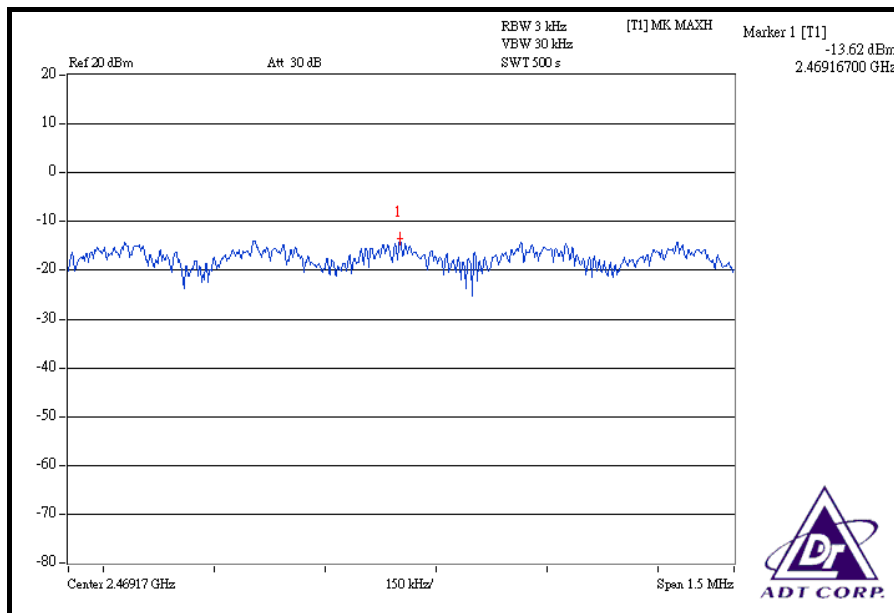



**DRAFT 802.11n (20MHz) OFDM MODULATION**

<b>MODULATION TYPE</b>	BPSK	<b>TRANSFER RATE</b>	6.5Mbps
<b>INPUT POWER (SYSTEM)</b>	120Vac, 60 Hz	<b>ENVIRONMENTAL CONDITIONS</b>	26deg.C, 66% RH, 991hPa
<b>TESTED BY</b>	Brad Wu		

CHANNEL	CHANNEL FREQUENCY (MHz)	RF POWER LEVEL IN 3kHz BW (mW)		RF POWER LEVEL IN 3kHz BW (dBm)		TOTAL POWER DENSITY (mW)	TOTAL POWER DENSITY (dBm)	MAX. LIMIT (dBm)	PASS / FAIL
		CHAIN 0	CHAIN 1	CHAIN 0	CHAIN 1				
1	2412	0.054	0.048	-12.67	-13.17	0.102	-9.90	8	PASS
6	2437	0.061	0.057	-12.16	-12.45	0.118	-9.29	8	PASS
11	2462	0.040	0.035	-14.03	-14.57	0.075	-11.28	8	PASS

**FOR CHAIN 0: CH 1**

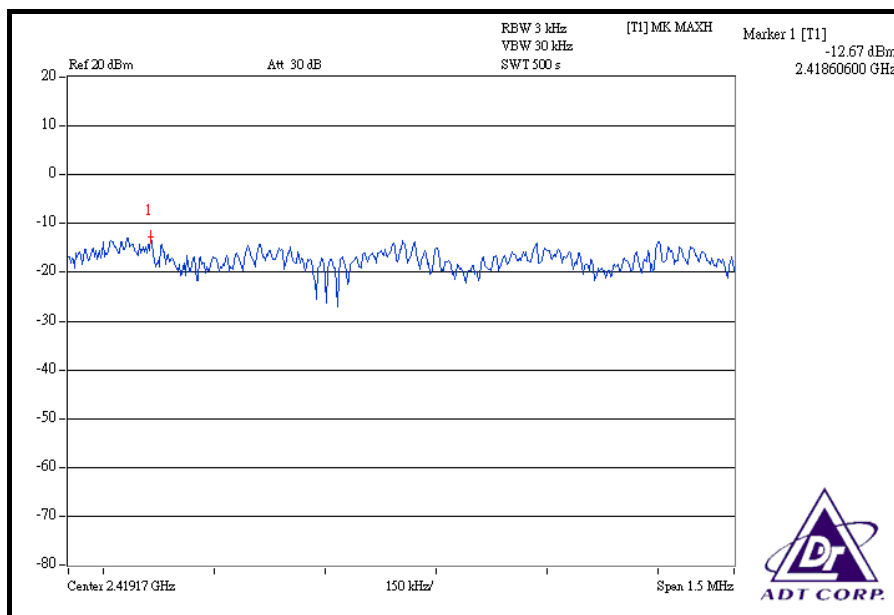

### CH 6

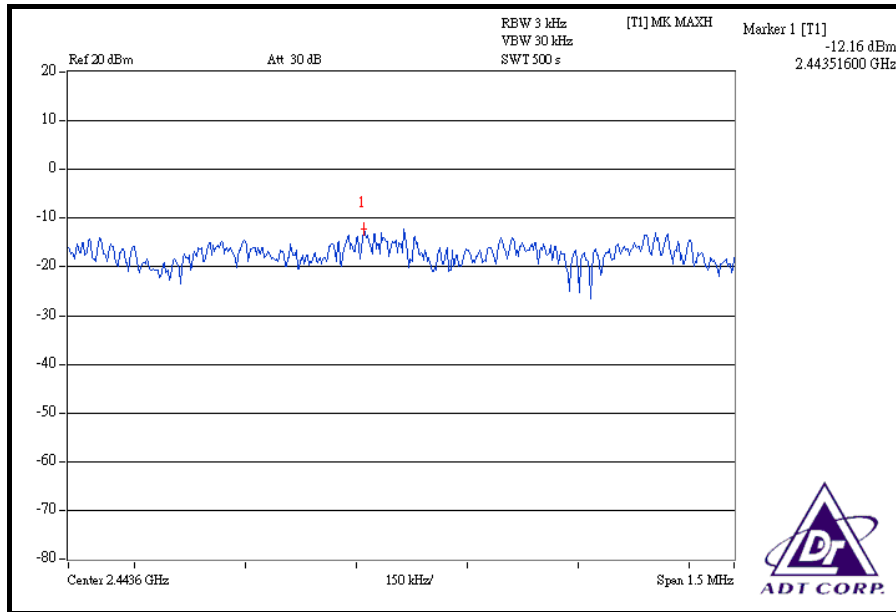

### CH 11

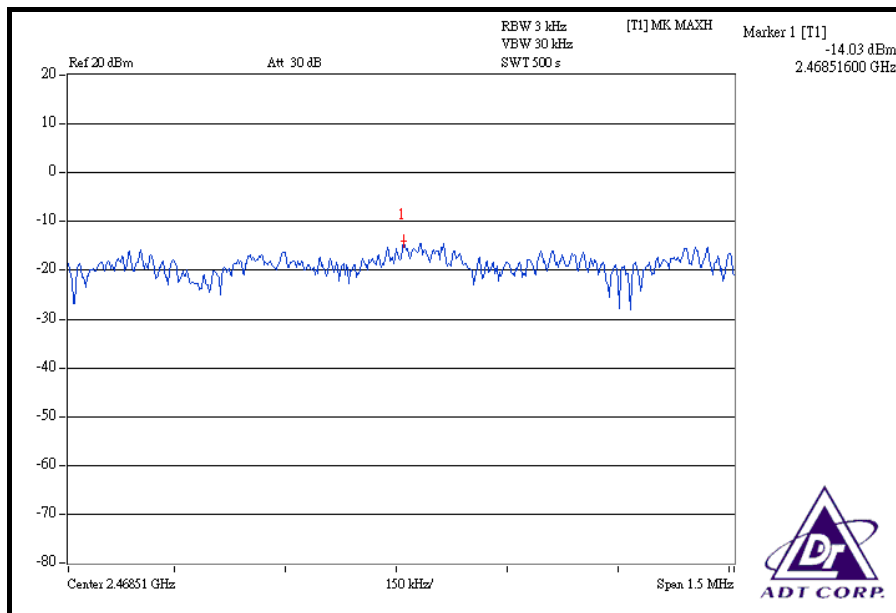

**FOR CHAIN 1: CH 1**

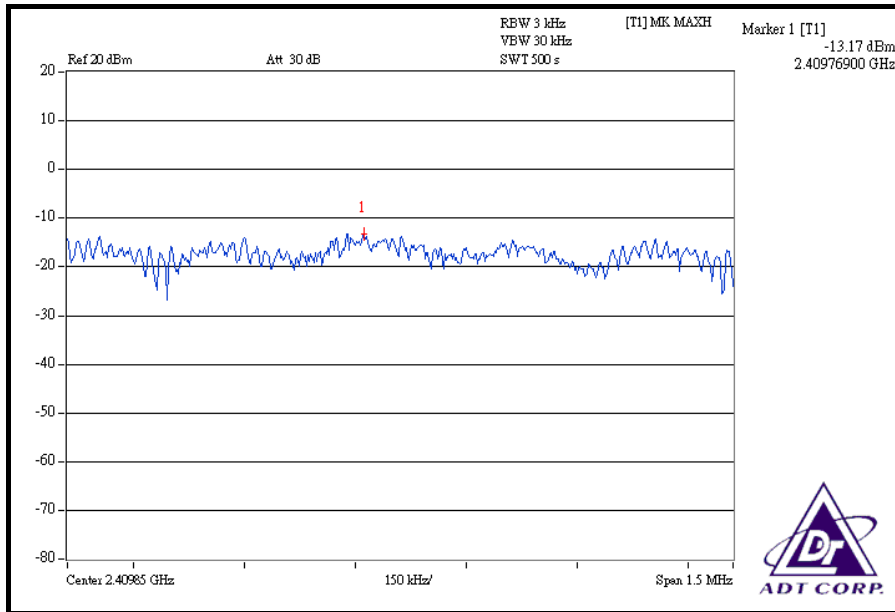

**CH 6**

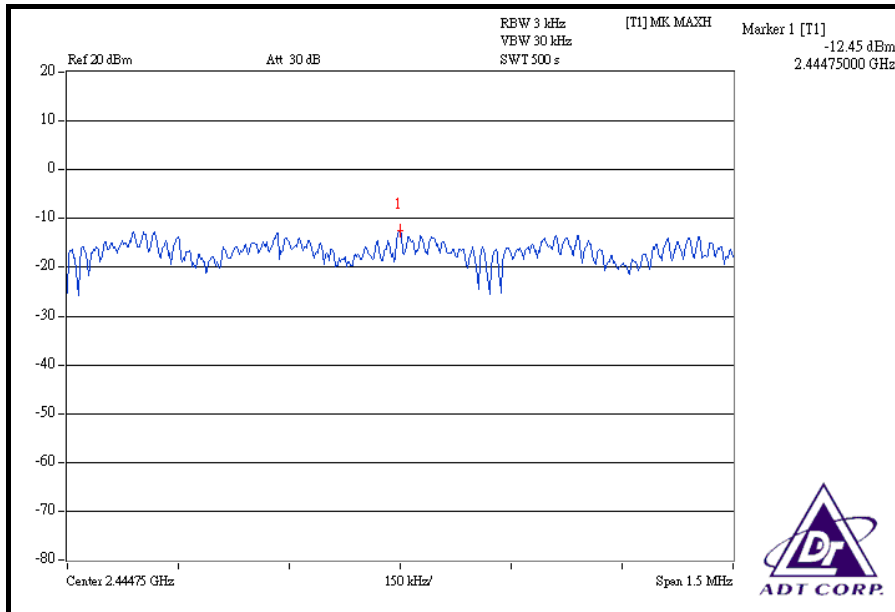

CH 11

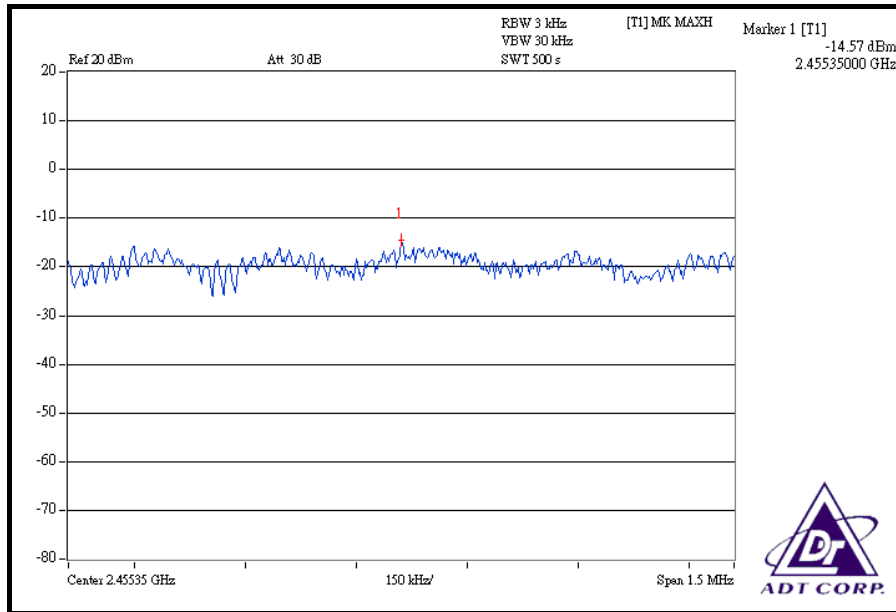



**DRAFT 802.11n (40MHz) OFDM MODULATION**

<b>MODULATION TYPE</b>	BPSK	<b>TRANSFER RATE</b>	13.5Mbps
<b>INPUT POWER (SYSTEM)</b>	120Vac, 60 Hz	<b>ENVIRONMENTAL CONDITIONS</b>	26deg.C, 66% RH, 991hPa
<b>TESTED BY</b>	Brad Wu		

CHANNEL	CHANNEL FREQUENCY (MHz)	RF POWER LEVEL IN 3kHz BW (mW)		RF POWER LEVEL IN 3kHz BW (dBm)		TOTAL POWER DENSITY (mW)	TOTAL POWER DENSITY (dBm)	MAX. LIMIT (dBm)	PASS / FAIL
		CHAIN 0	CHAIN 1	CHAIN 0	CHAIN 1				
1	2422	0.029	0.029	-15.43	-15.44	0.058	-12.42	8	PASS
4	2437	0.034	0.034	-14.71	-14.71	0.068	-11.70	8	PASS
7	2452	0.025	0.025	-16.01	-15.95	0.050	-12.97	8	PASS

**FOR CHAIN 0: CH 1**

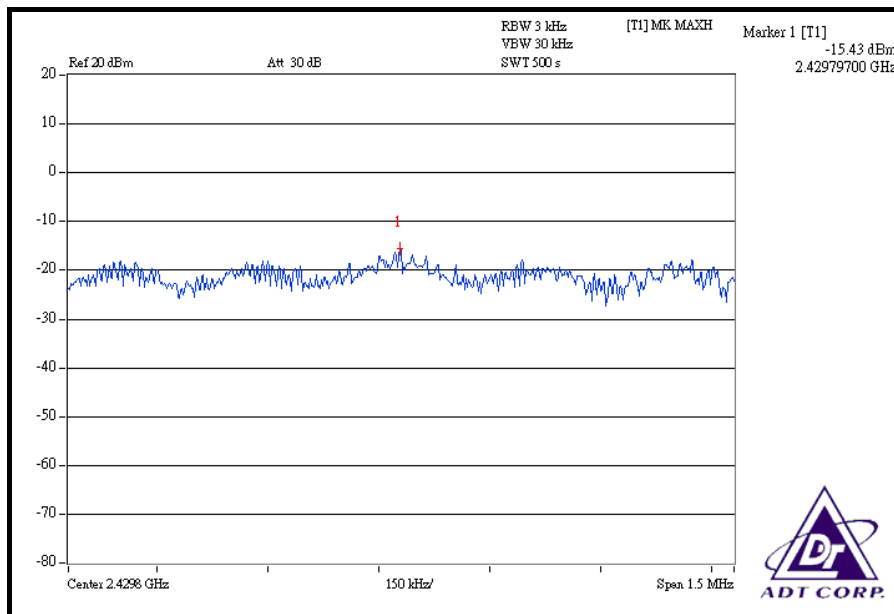





**FOR CHAIN 1: CH 1**

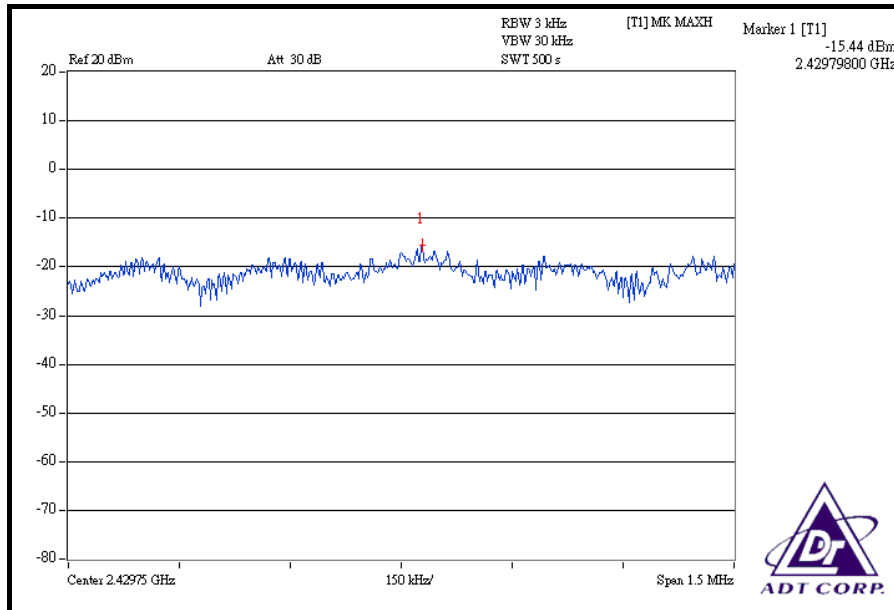

**CH 4**

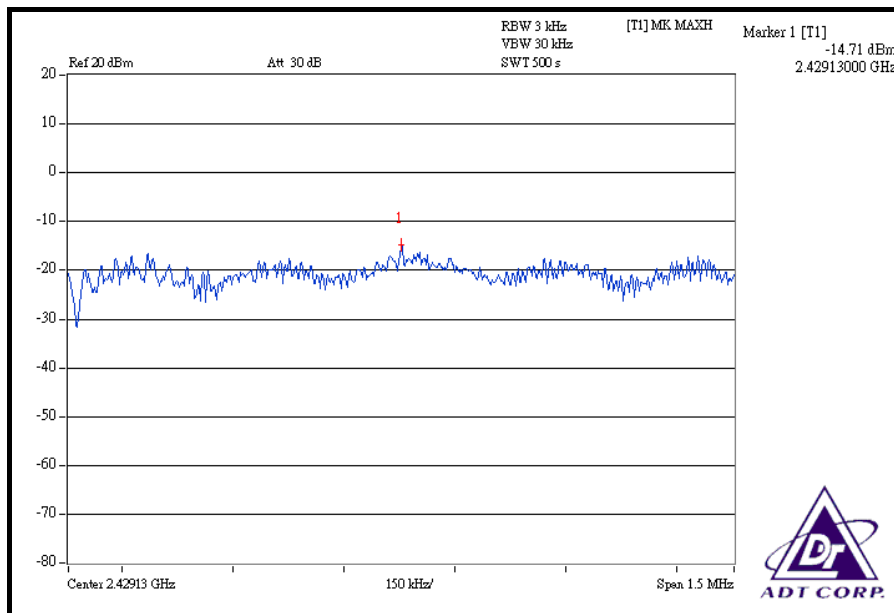

CH 7

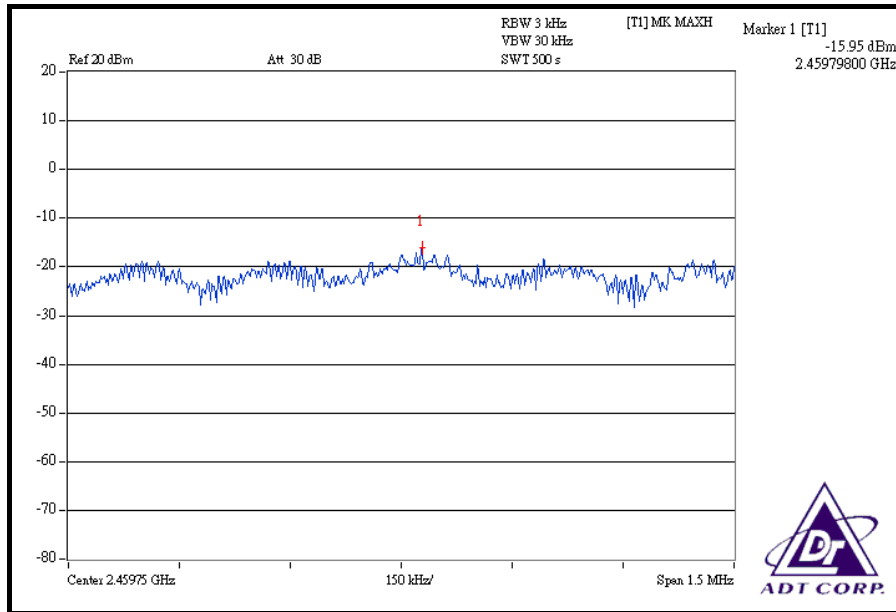



## 4.6 BAND EDGES MEASUREMENT

### 4.6.1 LIMITS OF BAND EDGES MEASUREMENT

Below -20dB of the highest emission level of operating band (in 100kHz Resolution Bandwidth).

### 4.6.2 TEST INSTRUMENTS

DESCRIPTION & MANUFACTURER	MODEL NO.	SERIAL NO.	CALIBRATED UNTIL
<b>FOR CONDUCTED MEASUREMENT</b>			
R&S SPECTRUM ANALYZER	FSP40	100040	Jun. 28, 2008
<b>FOR RADIATED MEASUREMENT</b>			
Test Receiver ROHDE & SCHWARZ	ESCI	100424	Aug. 04, 2007
Spectrum Analyzer ROHDE & SCHWARZ	FSP40	100025	Oct. 05, 2007
BILOG Antenna SCHWARZBECK	VULB9168	9168-160	May 31, 2008
HORN Antenna SCHWARZBECK	9120D	9120D-209	Jun. 28, 2008
HORN Antenna SCHWARZBECK	BBHA 9170	BBHA9170243	Dec. 28, 2007
Preamplifier Agilent	8447D	2944A10633	Oct. 26, 2007
Preamplifier Agilent	8449B	3008A01964	Oct. 26, 2007
RF signal cable HUBER+SUHNNER	SUCOFLEX 104	238137/4	Dec. 11, 2007
RF signal cable HUBER+SUHNNER	SUCOFLEX 104	233233/4	Nov. 14, 2007
Software ADT.	ADT_Radiated_V7.6	NA	NA
Antenna Tower inn-co GmbH	MA 4000	013303	NA
Antenna Tower Controller inn-co GmbH	CO2000	017303	NA
Turn Table ADT.	TT100.	TT93021703	NA
Turn Table Controller ADT.	SC100.	SC93021703	NA

**NOTE:** The calibration interval of the above test instruments is 12 months and the calibrations are traceable to NML/ROC and NIST/USA.

### 4.6.3 TEST PROCEDURE

#### **FOR CONDUCTED MEASUREMENT:**

The transmitter output was connected to the spectrum analyzer via a low loss cable. Set both RBW and VBW of spectrum analyzer to 100kHz with suitable frequency span including 10Hz bandwidth from band edge. The band edges was measured and recorded.

The spectrum plots (Peak RBW = VBW = 100kHz; Average RBW = 1MHz, VBW = 10Hz) are attached on the following pages.

#### **FOR RADIATED MEASUREMENT:**

- a. The EUT was placed on the top of a rotating table 0.8 meters above the ground at a 3 meter semi-anechoic chamber. The table was rotated 360 degrees to determine the position of the highest radiation.
- b. The EUT was set 3 meters away from the interference-receiving antenna, which was mounted on the top of a variable-height antenna tower.
- c. The antenna is a broadband antenna, and its height is varied from one meter to four meters above the ground to determine the maximum value of the field strength. Both horizontal and vertical polarizations of the antenna are set to make the measurement.
- d. For each suspected emission, the EUT was arranged to its worst case and then the antenna was tuned to heights from 1 meter to 4 meters and the rotatable table was turned from 0 degrees to 360 degrees to find the maximum reading.
- e. Set both RBW and VBW of spectrum analyzer to 100kHz with suitable frequency span including 100MHz bandwidth from band edge. The band edges was measured and recorded.

The spectrum plots (Peak RBW = VBW = 100kHz; Average RBW = 1MHz, VBW = 10Hz)

**NOTE:** The resolution bandwidth of test receiver/spectrum analyzer is 1 MHz and the video bandwidth is 10Hz for Average detection (AV) at frequency above 1GHz.

#### 4.6.4 DEVIATION FROM TEST STANDARD

No deviation

#### 4.6.5 EUT OPERATING CONDITION

Same as Item 4.3.6

#### 4.6.6 TEST RESULTS

The spectrum plots are attached on the following 24 images. D1 line indicates the highest level, and D2 line indicates the 20dB offset below D1. It shows compliance with the requirement in part 15.247(d).

#### **802.11b DSSS MODULATION**

##### **NOTE 1:**

The band edge emission plot on the next page shows 51.13dBc between carrier maximum power and local maximum emission in restrict band (2.38600GHz). The emission of carrier strength list in the test result of channel 1 at the item 4.2.7 is 109.40dBuV/m (Peak), so the maximum field strength in restrict band is  $109.40 - 51.13 = 58.27$ dBuV/m which is under 74dBuV/m limit.

The band edge emission plot on the next page shows 54.67dBc between carrier maximum power and local maximum emission in restrict band (2.38620GHz). The emission of carrier strength list in the test result of channel 1 at the item 4.2.7 is 105.10dBuV/m (Average), so the maximum field strength in restrict band is  $105.10 - 54.67 = 50.43$ dBuV/m which is under 54dBuV/m limit.

##### **NOTE 2:**

The band edge emission plot on the next second page shows 50.08dBc between carrier maximum power and local maximum emission in restrict band (2.48360GHz). The emission of carrier strength list in the test result of channel 11 at the item 4.2.7 is 109.27dBuV/m (Peak), so the maximum field strength in restrict band is  $109.27 - 50.08 = 59.19$ dBuV/m which is under 74dBuV/m limit.

The band edge emission plot on the next third page shows 55.10dBc between carrier maximum power and local maximum emission in restrict band (2.48350GHz). The emission of carrier strength list in the test result of channel 11 at the item 4.2.7 is 105.08dBuV/m (Average), so the maximum field strength in restrict band is  $105.08 - 55.10 = 49.98$ dBuV/m which is under 54dBuV/m limit.

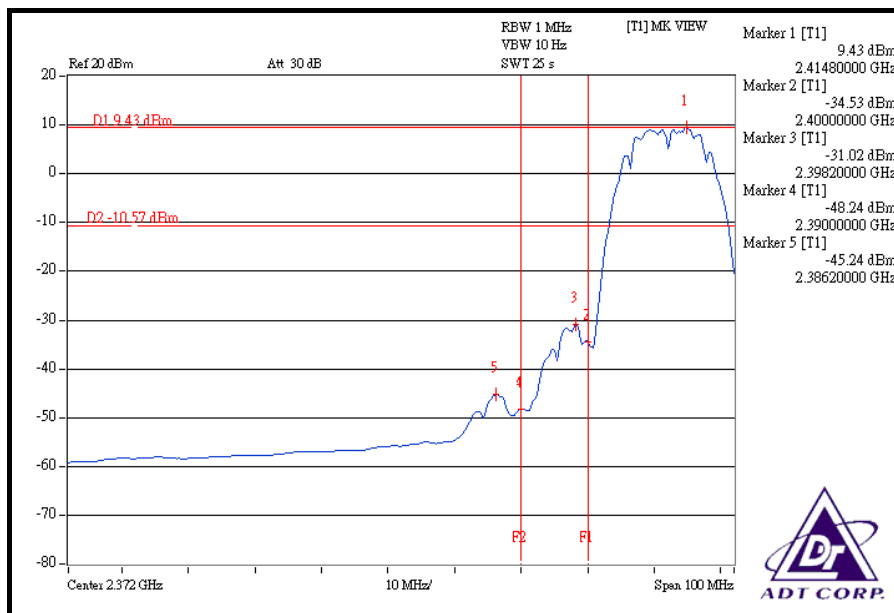
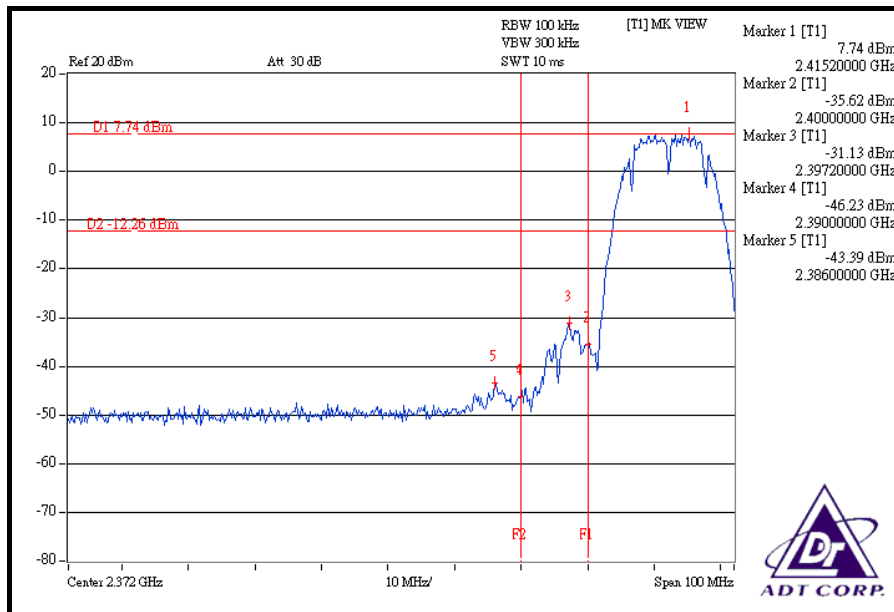

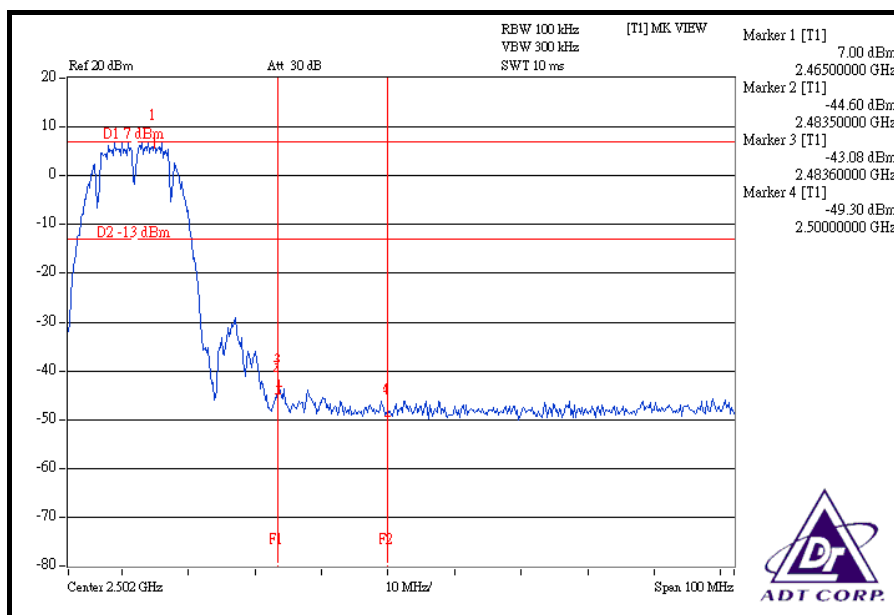
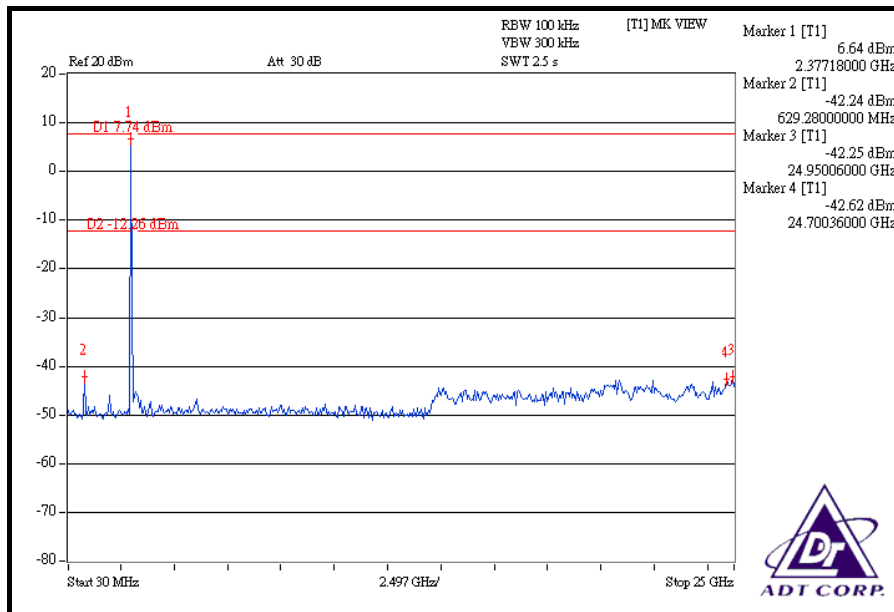



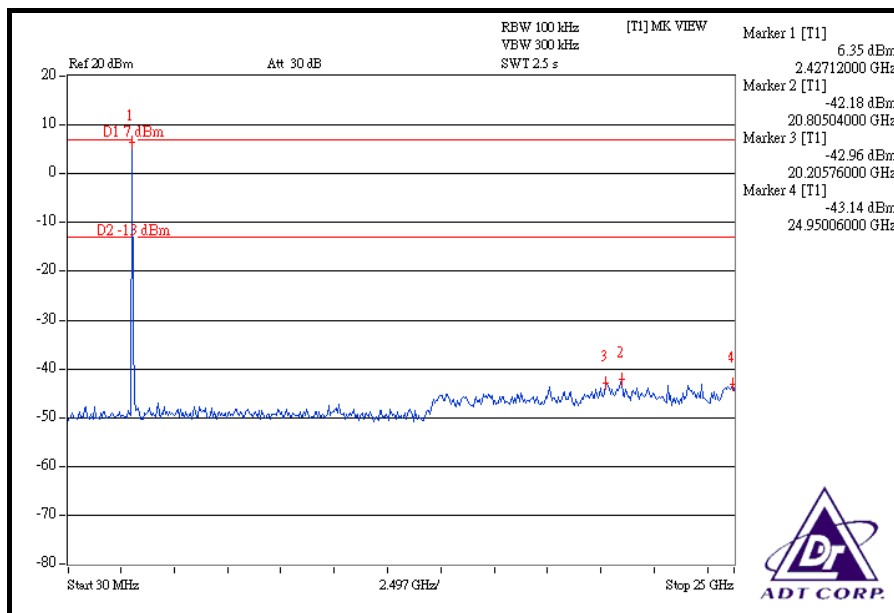
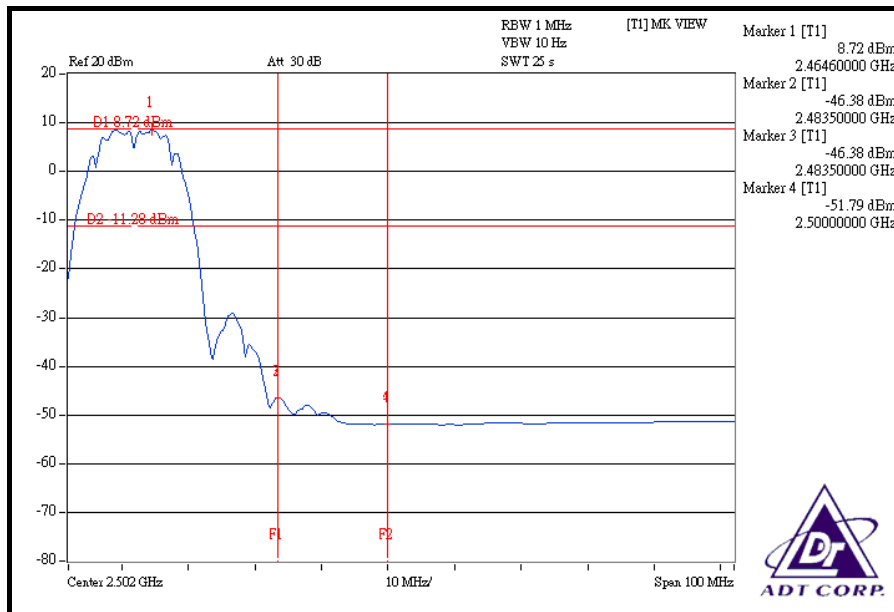

## 802.11g OFDM MODULATION

### NOTE 1:

The band edge emission plot on the next page shows 41.13dBc between carrier maximum power and local maximum emission in restrict band (2.38900GHz). The emission of carrier strength list in the test result of channel 1 at the item 4.2.7 is 107.69dBuV/m (Peak), so the maximum field strength in restrict band is  $107.69 - 41.13 = 66.56$ dBuV/m which is under 74dBuV/m limit.

The band edge emission plot on the next page shows 51.78dBc between carrier maximum power and local maximum emission in restrict band (2.39000GHz). The emission of carrier strength list in the test result of channel 1 at the item 4.2.7 is 97.85dBuV/m (Average), so the maximum field strength in restrict band is  $97.85 - 51.78 = 46.07$ dBuV/m which is under 54dBuV/m limit.

### NOTE 2:

The band edge emission plot on the next second page shows 40.03dBc between carrier maximum power and local maximum emission in restrict band (2.48380GHz). The emission of carrier strength list in the test result of channel 11 at the item 4.2.7 is 106.86dBuV/m (Peak), so the maximum field strength in restrict band is  $106.86 - 40.03 = 66.83$ dBuV/m which is under 74dBuV/m limit.

The band edge emission plot on the next third page shows 47.69dBc between carrier maximum power and local maximum emission in restrict band (2.48350GHz). The emission of carrier strength list in the test result of channel 11 at the item 4.2.7 is 96.47dBuV/m (Average), so the maximum field strength in restrict band is  $96.47 - 47.69 = 48.78$ dBuV/m which is under 54dBuV/m limit.

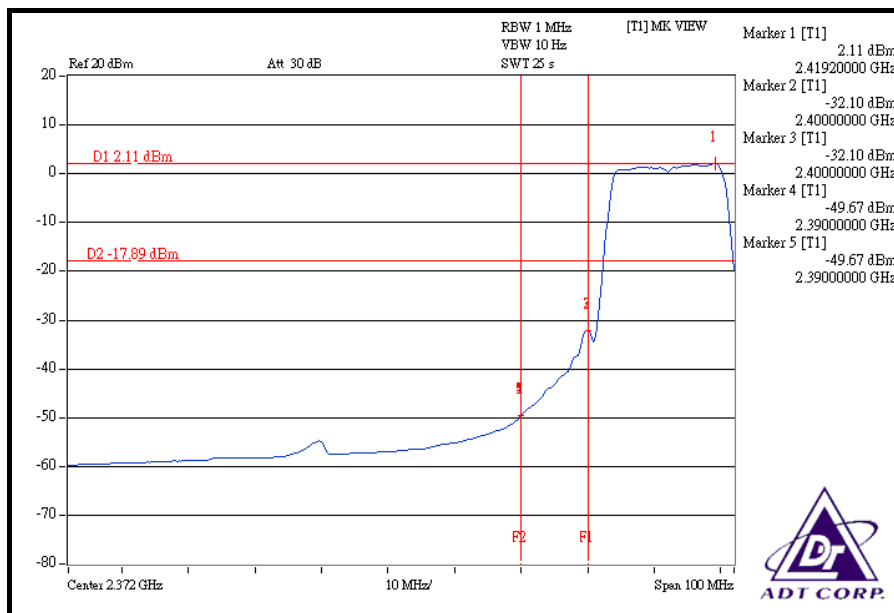
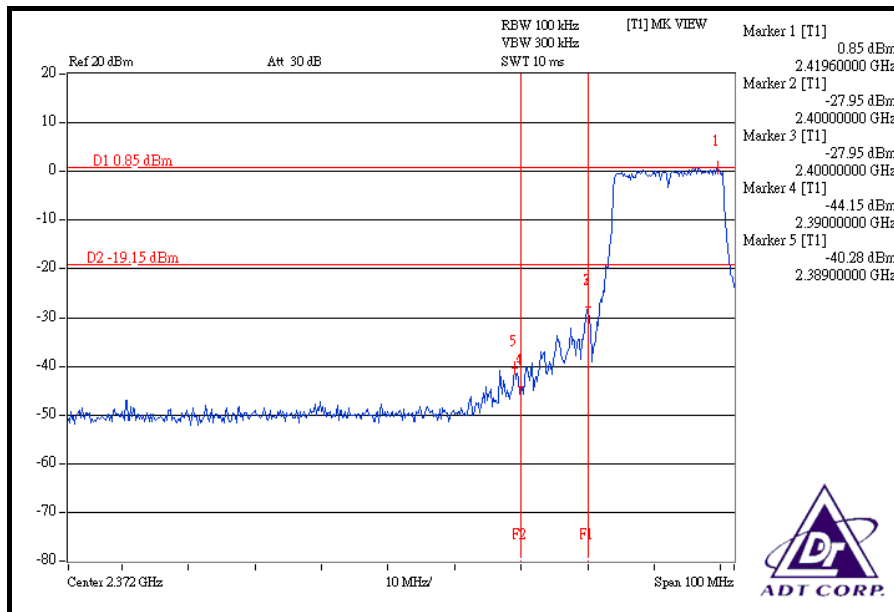

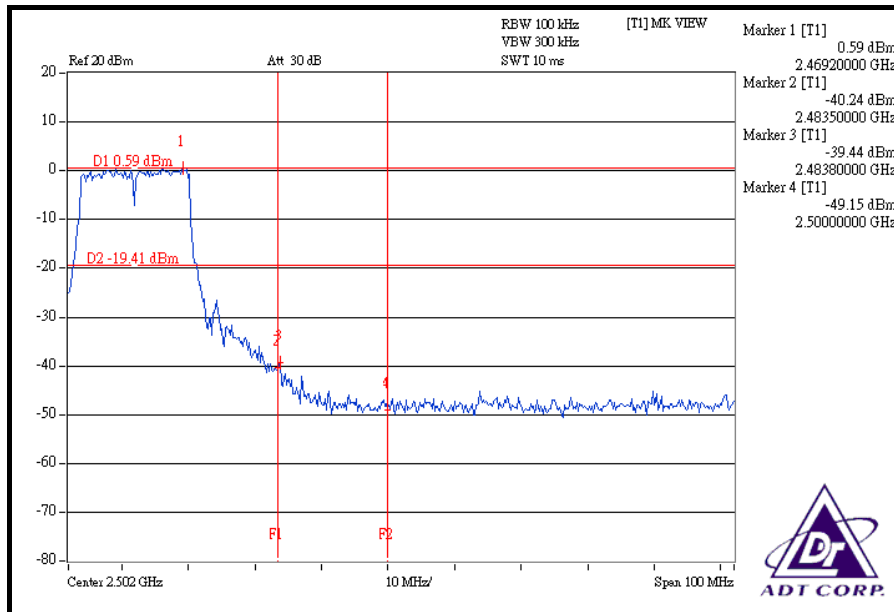
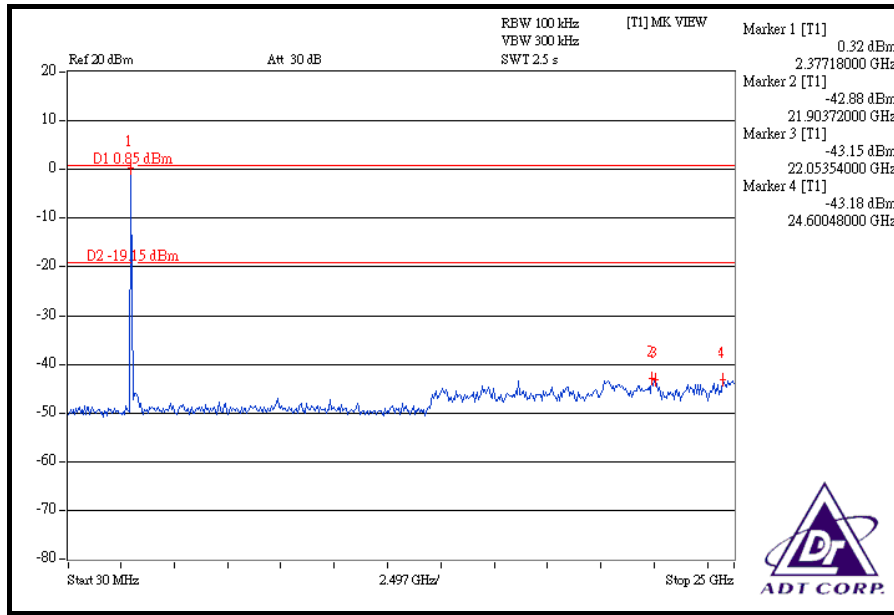

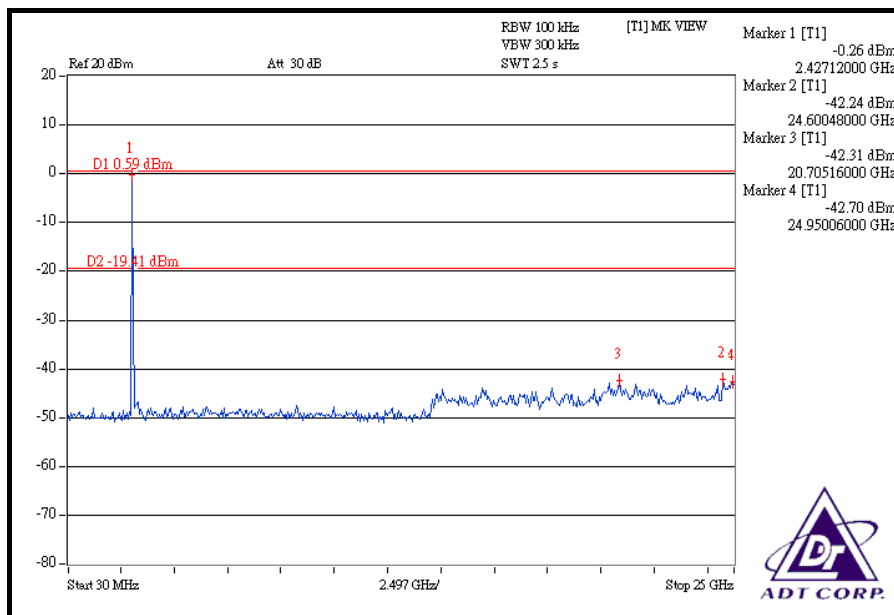
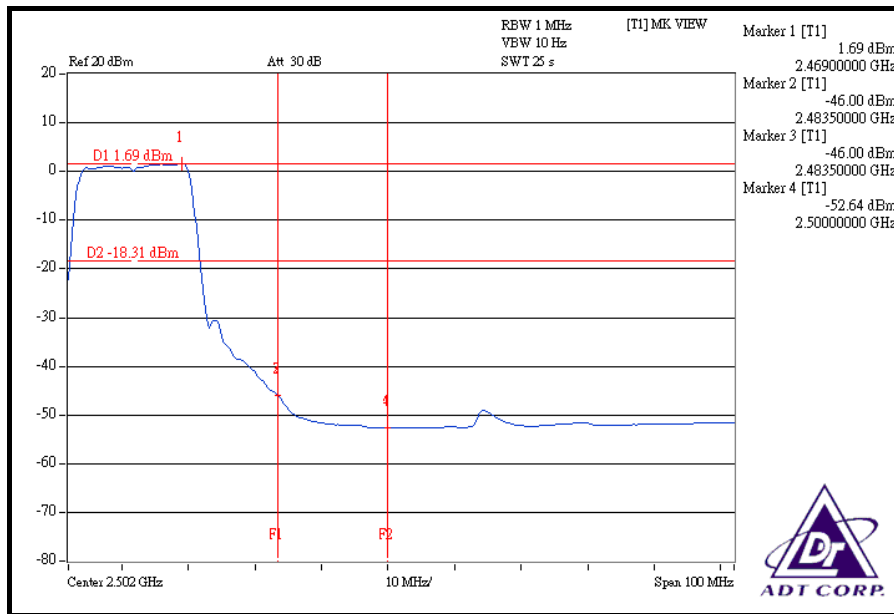

## **DRAFT 802.11n (20MHz) OFDM MODULATION**

### **NOTE 1:**

The band edge emission plot on the next page shows 48.75dBc between carrier maximum power and local maximum emission in restrict band (2.35360GHz). The emission of carrier strength list in the test result of channel 1 at the item 4.2.7 is 112.94dBuV/m (Peak), so the maximum field strength in restrict band is  $112.94 - 48.75 = 64.19$ dBuV/m which is under 74dBuV/m limit.

The band edge emission plot on the next page shows 53.33dBc between carrier maximum power and local maximum emission in restrict band (2.39000GHz). The emission of carrier strength list in the test result of channel 1 at the item 4.2.7 is 103.00dBuV/m (Average), so the maximum field strength in restrict band is  $103.00 - 53.33 = 49.67$ dBuV/m which is under 54dBuV/m limit.

### **NOTE 2:**

The band edge emission plot on the next second page shows 45.10dBc between carrier maximum power and local maximum emission in restrict band (2.49860GHz). The emission of carrier strength list in the test result of channel 11 at the item 4.2.7 is 112.02dBuV/m (Peak), so the maximum field strength in restrict band is  $112.02 - 45.10 = 66.92$ dBuV/m which is under 74dBuV/m limit.

The band edge emission plot on the next third page shows 48.70dBc between carrier maximum power and local maximum emission in restrict band (2.48350GHz). The emission of carrier strength list in the test result of channel 11 at the item 4.2.7 is 101.79dBuV/m (Average), so the maximum field strength in restrict band is  $101.79 - 48.70 = 53.09$ dBuV/m which is under 54dBuV/m limit.

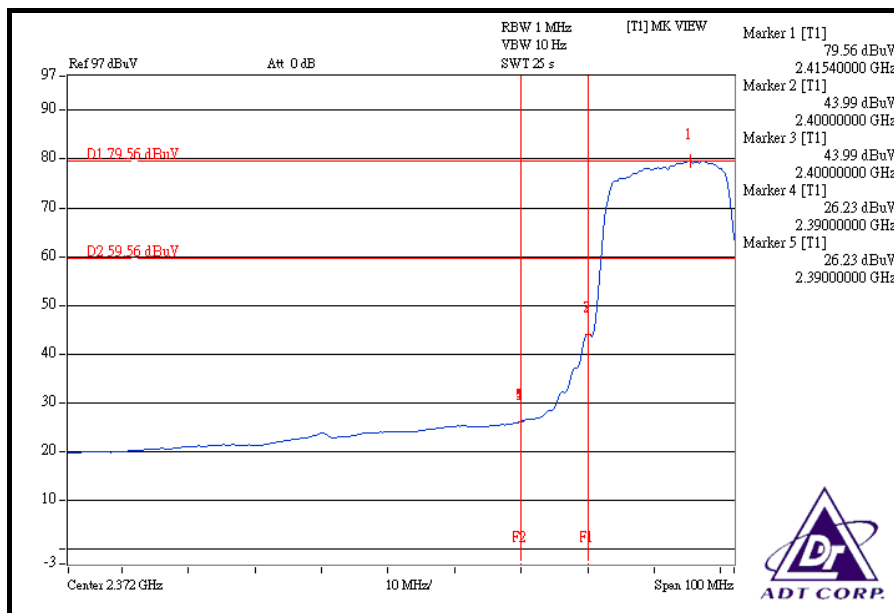
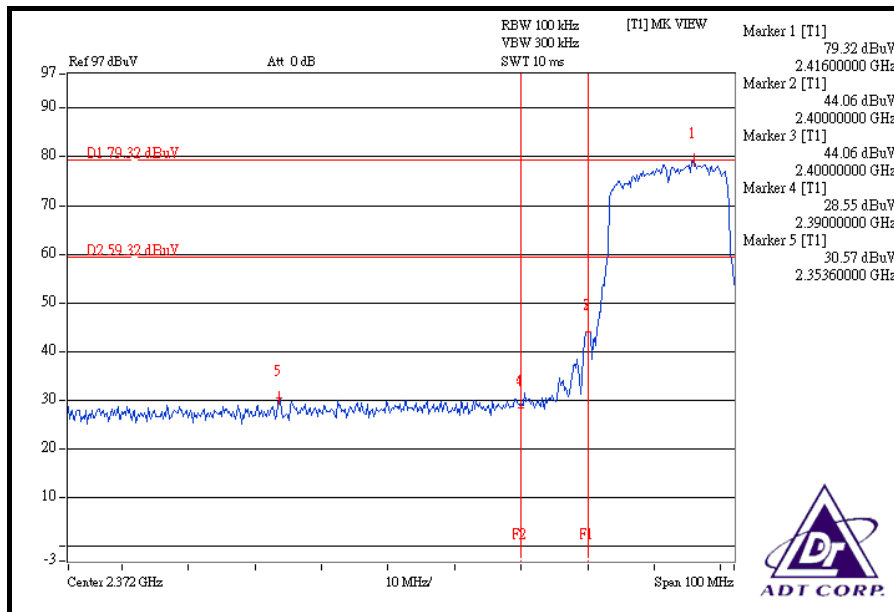

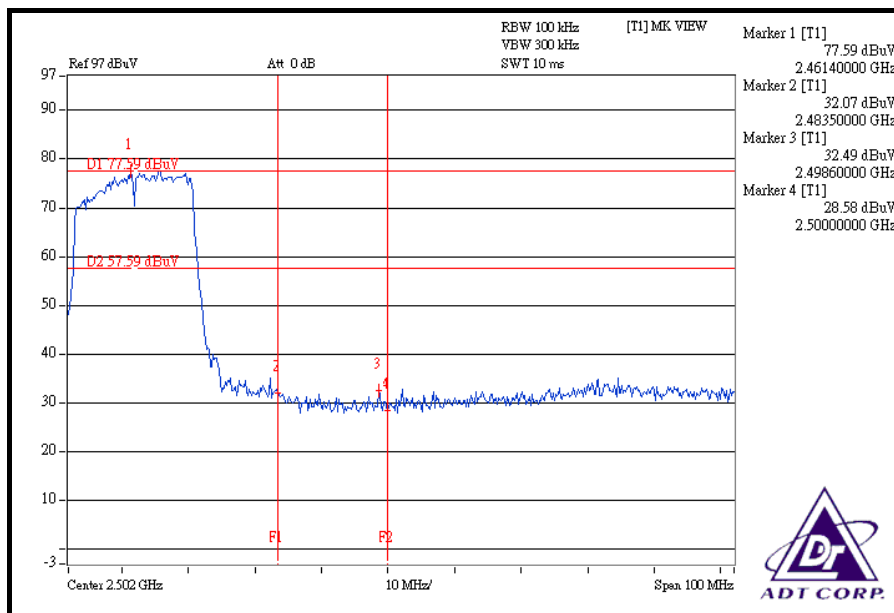
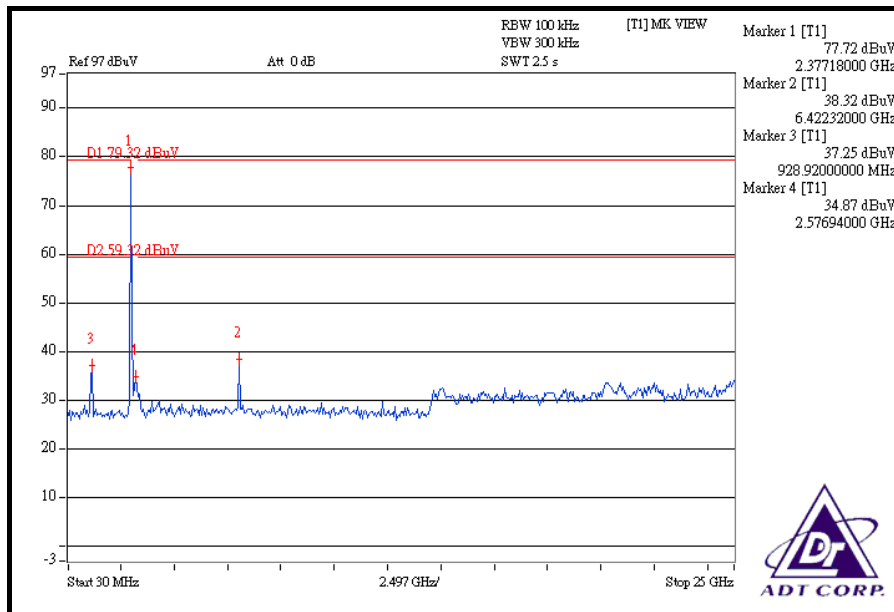



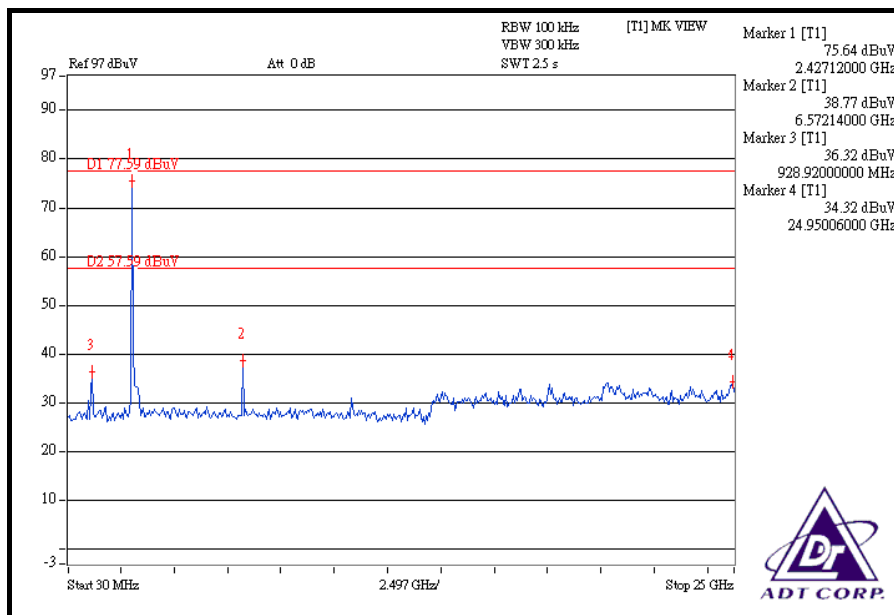
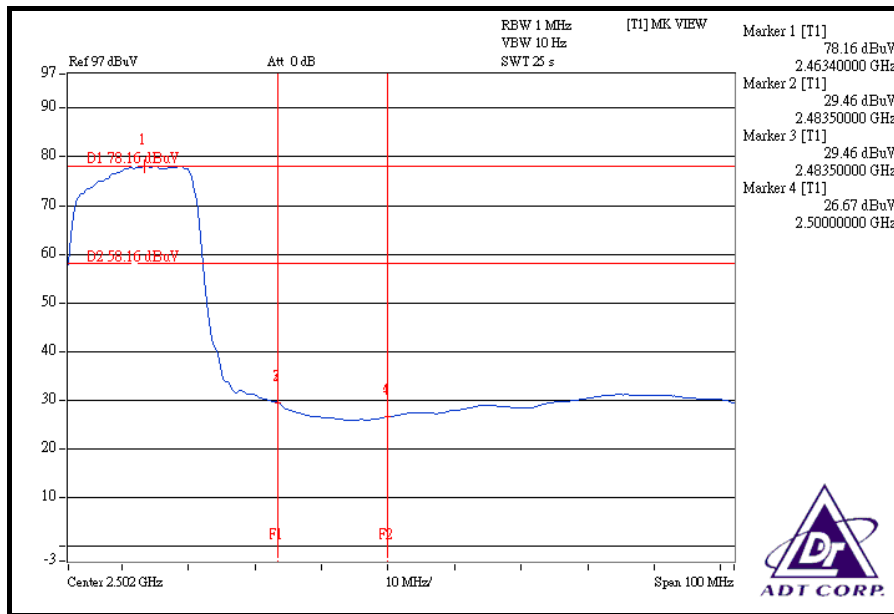

## **DRAFT 802.11n (40MHz) OFDM MODULATION**

### **NOTE 1:**

The band edge emission plot on the next page shows 45.40dBc between carrier maximum power and local maximum emission in restrict band (2.37960GHz). The emission of carrier strength list in the test result of channel 1 at the item 4.2.7 is 108.78dBuV/m (Peak), so the maximum field strength in restrict band is  $108.78 - 45.40 = 63.38$ dBuV/m which is under 74dBuV/m limit.

The band edge emission plot on the next page shows 50.97dBc between carrier maximum power and local maximum emission in restrict band (2.38680GHz). The emission of carrier strength list in the test result of channel 1 at the item 4.2.7 is 98.31dBuV/m (Average), so the maximum field strength in restrict band is  $98.31 - 50.97 = 47.34$ dBuV/m which is under 54dBuV/m limit.

### **NOTE 2:**

The band edge emission plot on the next second page shows 42.01dBc between carrier maximum power and local maximum emission in restrict band (2.48360GHz). The emission of carrier strength list in the test result of channel 7 at the item 4.2.7 is 107.07dBuV/m (Peak), so the maximum field strength in restrict band is  $107.07 - 42.01 = 65.06$ dBuV/m which is under 74dBuV/m limit.

The band edge emission plot on the next third page shows 45.94dBc between carrier maximum power and local maximum emission in restrict band (2.48360GHz). The emission of carrier strength list in the test result of channel 7 at the item 4.2.7 is 97.24dBuV/m (Average), so the maximum field strength in restrict band is  $97.24 - 45.94 = 51.30$ dBuV/m which is under 54dBuV/m limit.

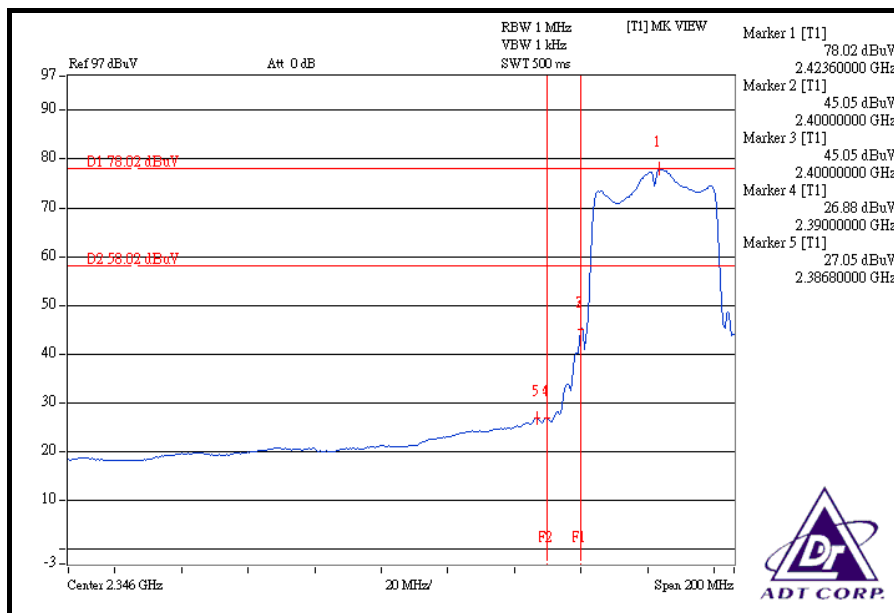
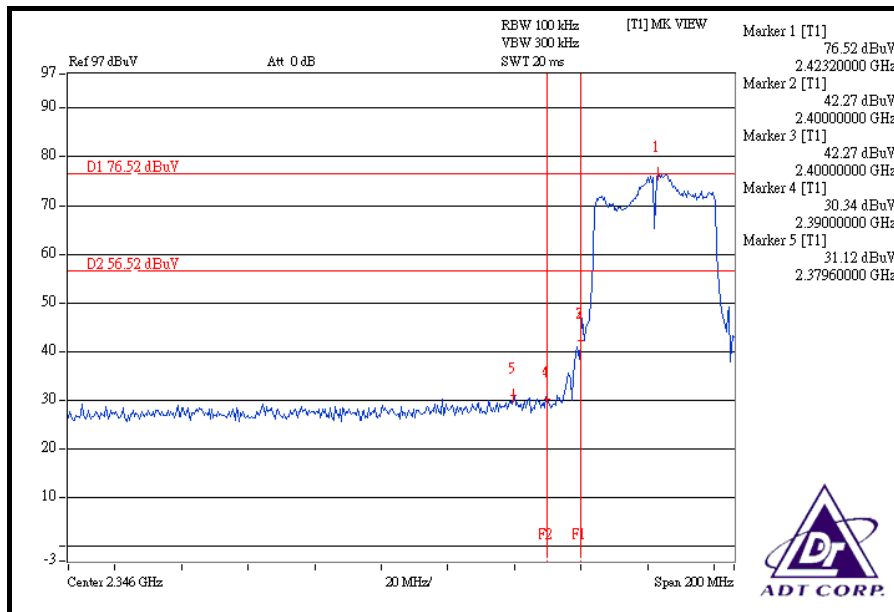

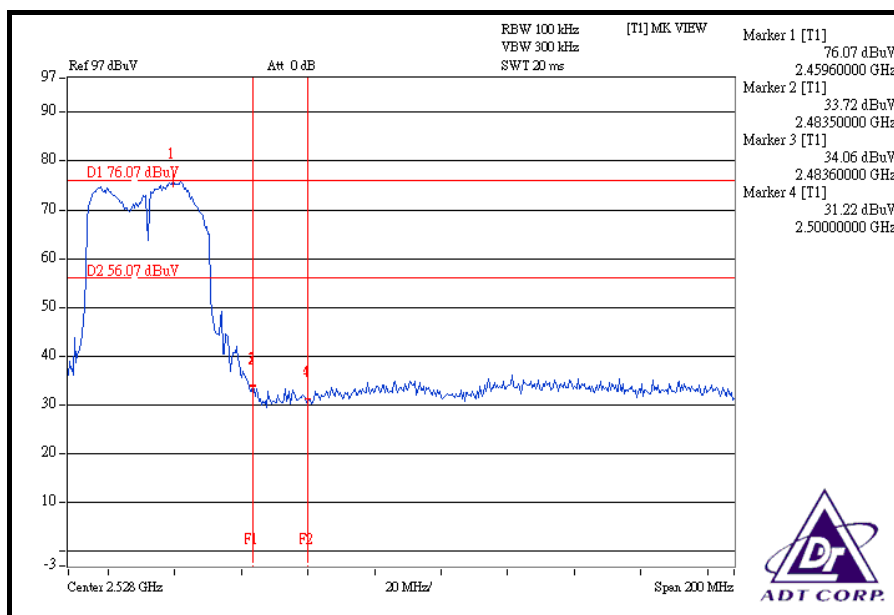
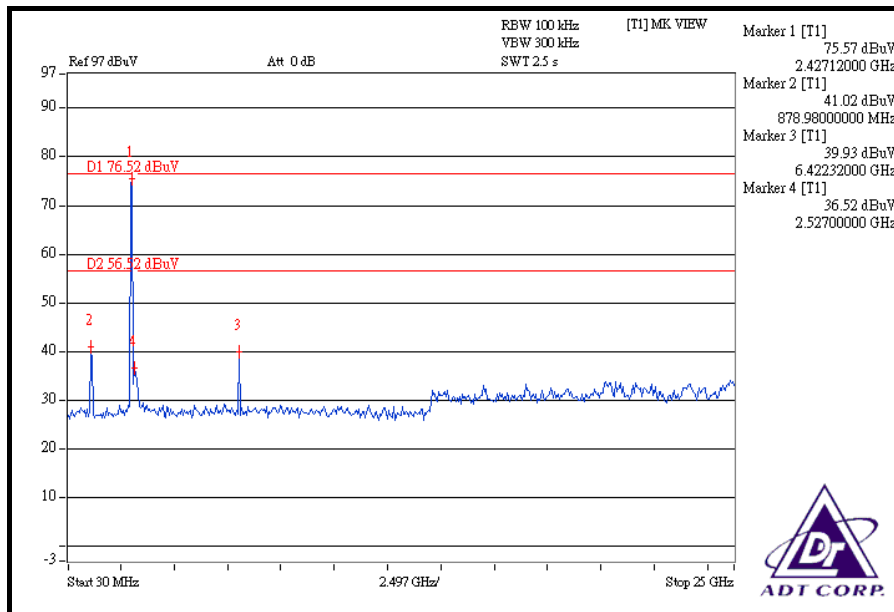

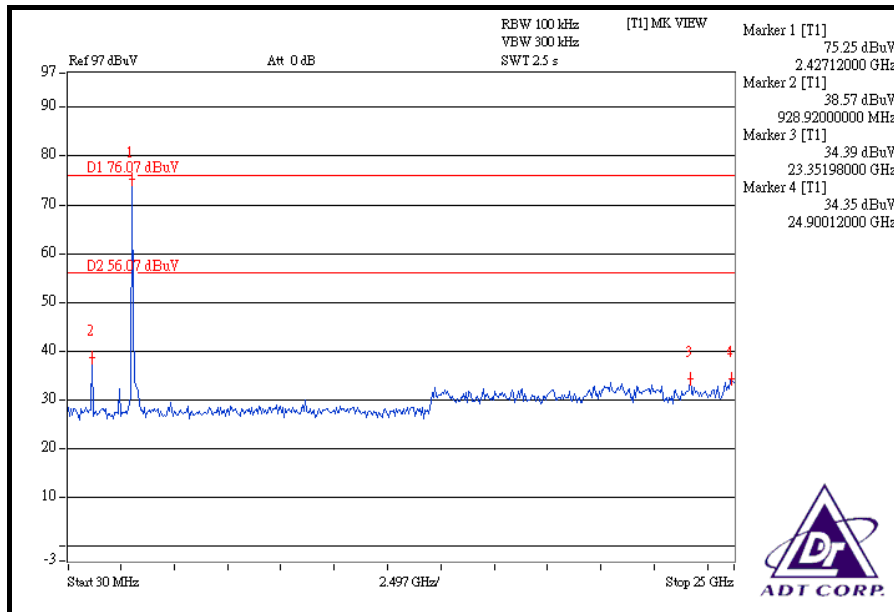
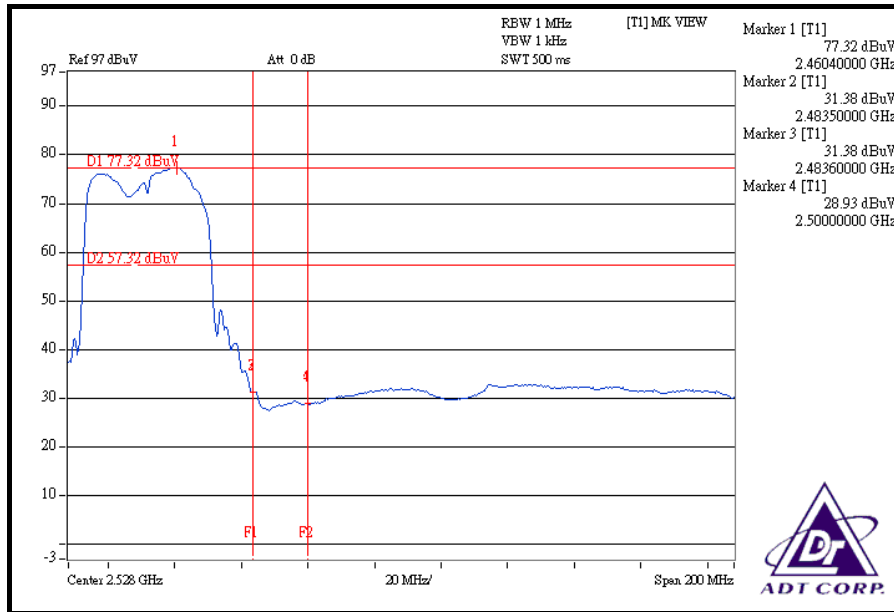



## **4.7 ANTENNA REQUIREMENT**

### **4.7.1 STANDARD APPLICABLE**

For intentional device, according to FCC 47 CFR Section 15.203, an intentional radiator shall be designed to ensure that no antenna other than that furnished by the responsible party shall be used with the device. And according to FCC 47 CFR Section 15.247 (b), if transmitting antennas of directional gain greater than 6dBi are used, the power shall be reduced by the amount in dB that the directional gain of the antenna exceeds 6dBi.

### **4.7.2 ANTENNA CONNECTED CONSTRUCTION**

The antenna used in this product is PIFA antenna without connector. The maximum Gain of the antenna is 2dBi.



## 5. PHOTOGRAPHS OF THE TEST CONFIGURATION

Please refer to the attached file (Test Setup Photo).



## 6. INFORMATION ON THE TESTING LABORATORIES

We, ADT Corp., were founded in 1988 to provide our best service in EMC, Radio, Telecom and Safety consultation. Our laboratories are accredited and approved by the following approval agencies according to ISO/IEC 17025.

<b>USA</b>	FCC, UL, A2LA
<b>Germany</b>	TUV Rheinland
<b>Japan</b>	VCCI
<b>Norway</b>	NEMKO
<b>Canada</b>	INDUSTRY CANADA , CSA
<b>R.O.C.</b>	TAF, BSMI, NCC
<b>Netherlands</b>	Telefication
<b>Singapore</b>	GOST-ASIA(MOU)
<b>Russia</b>	CERTIS(MOU)

Copies of accreditation certificates of our laboratories obtained from approval agencies can be downloaded from our web site:

[www.adt.com.tw/index.5/phtml](http://www.adt.com.tw/index.5/phtml). If you have any comments, please feel free to contact us at the following:

**Linko EMC/RF Lab:**

Tel: 886-2-26052180

Fax: 886-2-26051924

**Hsin Chu EMC/RF Lab:**

Tel: 886-3-5935343

Fax: 886-3-5935342

**Hwa Ya EMC/RF/Safety Telecom Lab:**

Tel: 886-3-3183232

Fax: 886-3-3185050

**Web Site:** [www.adt.com.tw](http://www.adt.com.tw)

The address and road map of all our labs can be found in our web site also.





## **7. APPENDIX A - MODIFICATIONS RECORDERS FOR ENGINEERING CHANGES TO THE EUT BY THE LAB**

No any modifications are made to the EUT by the lab during the test.