



# FCC TEST REPORT

**REPORT NO.:** RF921011R03H

**MODEL NO.:** WLG-2207

Refer to page 6 for other models

**RECEIVED:** NA

**TESTED:** Oct. 9, 2003 ~ Oct. 13, 2003

**ISSUED:** Aug. 02, 2005

**APPLICANT:** CAMEO COMMUNICATIONS, INC.

**ADDRESS:** 5F, No.42, Sec. 6, Mincyuan E. Rd., Neihu District,  
Taipei City 114, Taiwan, R.O.C.

**ISSUED BY:** Advance Data Technology Corporation

**LAB ADDRESS:** No. 47, 14<sup>th</sup> Ling, Chia Pau Tsuen, Lin Kou Hsiang  
244, Taipei Hsien, Taiwan, R.O.C.

**TEST LOCATION:** No. 19, Hwa Ya 2<sup>nd</sup> Rd., Wen Hwa Tsuen, Kwei  
Shan Hsiang, Taoyuan Hsien 333, Taiwan, R.O.C.

This test report consists of 63 pages in total. It may be duplicated completely for legal use with the approval of the applicant. It should not be reproduced except in full, without the written approval of our laboratory. The client should not use it to claim product endorsement by CNLA, A2LA or any government agencies. The test results in the report only apply to the tested sample.



0528  
ILAC MRA



No. 2177-01



## TABLE OF CONTENTS

1.	CERTIFICATION.....	4
2.	SUMMARY OF TEST RESULTS.....	5
2.1	MEASUREMENT UNCERTAINTY .....	5
3.	GENERAL INFORMATION .....	6
3.1	GENERAL DESCRIPTION OF EUT .....	6
3.2	DESCRIPTION OF TEST MODES .....	7
3.2.1	CONFIGURATION OF SYSTEM UNDER TEST .....	7
3.2.2	TEST MODE APPLICABILITY AND TESTED CHANNEL DETAIL .....	8
3.2.3	GENERAL DESCRIPTION OF APPLIED STANDARDS .....	10
3.2.4	DESCRIPTION OF SUPPORT UNITS.....	10
4.	TEST TYPES AND RESULTS.....	11
4.1	CONDUCTED EMISSION MEASUREMENT .....	11
4.1.1	LIMITS OF CONDUCTED EMISSION MEASUREMENT .....	11
4.1.2	TEST INSTRUMENTS.....	11
4.1.3	TEST PROCEDURES .....	12
4.1.4	DEVIATION FROM TEST STANDARD .....	12
4.1.5	TEST SETUP .....	13
4.1.6	EUT OPERATING CONDITIONS.....	13
4.1.7	TEST RESULTS .....	13
4.2	RADIATED EMISSION MEASUREMENT .....	20
4.2.1	LIMITS OF RADIATED EMISSION MEASUREMENT .....	20
4.2.2	TEST INSTRUMENTS.....	21
4.2.3	TEST PROCEDURES .....	22
4.2.4	DEVIATION FROM TEST STANDARD .....	23
4.2.5	TEST SETUP .....	23
4.2.6	EUT OPERATING CONDITIONS.....	23
4.2.7	TEST RESULTS .....	24
4.3	6dB BANDWIDTH MEASUREMENT .....	32
4.3.1	LIMITS OF 6dB BANDWIDTH MEASUREMENT .....	32
4.3.2	TEST INSTRUMENTS.....	32
4.3.3	TEST PROCEDURE.....	33
4.3.4	DEVIATION FROM TEST STANDARD .....	33
4.3.5	TEST SETUP .....	33
4.3.6	EUT OPERATING CONDITIONS.....	33
4.3.7	TEST RESULTS .....	34
4.4	MAXIMUM PEAK OUTPUT POWER.....	40



4.4.1 LIMITS OF MAXIMUM PEAK OUTPUT POWER MEASUREMENT .....40

4.4.2 INSTRUMENTS .....40

4.4.3 TEST PROCEDURES .....41

4.4.4 DEVIATION FROM TEST STANDARD .....41

4.4.5 TEST SETUP .....41

4.4.6 EUT OPERATING CONDITIONS .....41

4.4.7 TEST RESULTS .....42

4.5 POWER SPECTRAL DENSITY MEASUREMENT .....43

4.5.1 LIMITS OF POWER SPECTRAL DENSITY MEASUREMENT .....43

4.5.2 TEST INSTRUMENTS .....43

4.5.3 TEST PROCEDURE .....44

4.5.4 DEVIATION FROM TEST STANDARD .....44

4.5.5 TEST SETUP .....44

4.5.6 EUT OPERATING CONDITION .....44

4.5.7 TEST RESULTS .....45

4.6 BAND EDGES MEASUREMENT .....51

4.6.1 LIMITS OF BAND EDGES MEASUREMENT .....51

4.6.2 TEST INSTRUMENTS .....51

4.6.3 TEST PROCEDURE .....51

4.6.4 DEVIATION FROM TEST STANDARD .....51

4.6.5 EUT OPERATING CONDITION .....51

4.6.6 TEST RESULTS .....52

4.7 ANTENNA REQUIREMENT .....60

4.7.1 STANDARD APPLICABLE .....60

4.7.2 ANTENNA CONNECTED CONSTRUCTION .....60

5. PHOTOGRAPHS OF THE TEST CONFIGURATION .....61

6. INFORMATION ON THE TESTING LABORATORIES .....63



## 1. CERTIFICATION

**PRODUCT:** 2.4GHz Wireless Broadband Router

**MODEL:** WLG-2207

Refer to page 6 for other models

**BRAND:** Cameo

Refer to page 6 for other brand names

**APPLICANT:** CAMEO COMMUNICATIONS, INC.

**TESTED:** Oct. 9, 2003 ~ Oct. 13, 2003

**TEST SAMPLE:** ENGINEERING SAMPLE

**STANDARDS:** FCC Part 15, Subpart C (Section 15.247),  
ANSI C63.4-2003

The above equipment (model no.: WLG-2207) is identical to model no. GL2454RT-QA0 which has been tested by **Advance Data Technology Corporation** from Oct. 9, 2003 ~ Oct. 13, 2003, and found compliance with the requirement of the above standards. The test record, data evaluation & Equipment Under Test (EUT) configurations represented herein are true and accurate accounts of the measurements of the sample's EMC characteristics under the conditions specified in this report.

**PREPARED BY** : Wendy Liao , **DATE:** Aug. 02, 2005  
Wendy Liao

**TECHNICAL**  
**ACCEPTANCE** : Gary Chang , **DATE:** Aug. 02, 2005  
Responsible for RF Gary Chang

**APPROVED BY** : Cody Chang , **DATE:** Aug. 02, 2005  
Cody Chang / Deputy Manager

## 2. SUMMARY OF TEST RESULTS

The EUT has been tested according to the following specifications:

APPLIED STANDARD: FCC Part 15, Subpart C			
STANDARD SECTION	TEST TYPE AND LIMIT	RESULT	REMARK
15.207	AC Power Conducted Emission	PASS	Meet the requirement of limit. Minimum passing margin is -11.56dB at 0.224MHz
15.247(a)(2)	Spectrum Bandwidth of a Direct Sequence Spread Spectrum System Limit: min. 500kHz	PASS	Meet the requirement of limit.
15.247(b)	Maximum Peak Output Power Limit: max. 30dBm	PASS	Meet the requirement of limit.
15.247(d)	Radiated Emissions Limit: Table 15.209	PASS	Meet the requirement of limit. Minimum passing margin is -3.27dB at 250.94MHz
15.247(e)	Power Spectral Density Limit: max. 8dBm	PASS	Meet the requirement of limit.
15.247(d)	Band Edge Measurement Limit: 20dB less than the peak value of fundamental frequency	PASS	Meet the requirement of limit.

### 2.1 MEASUREMENT UNCERTAINTY

Where relevant, the following measurement uncertainty levels have been estimated for tests performed on the EUT as specified in CISPR 16-4:

MEASUREMENT	FREQUENCY	UNCERTAINTY
Conducted emissions	9kHz ~ 30MHz	2.44 dB
Radiated emissions	30MHz ~ 200MHz	3.73 dB
	200MHz ~ 1000MHz	3.74 dB
	1GHz ~ 18GHz	2.20 dB
	18GHz ~ 40GHz	1.88 dB

This uncertainty represents an expanded uncertainty expressed at approximately the 95% confidence level using a coverage factor of k=2.



### 3. GENERAL INFORMATION

#### 3.1 GENERAL DESCRIPTION OF EUT

<b>EUT</b>	2.4GHz Wireless Broadband Router
<b>MODEL NO.</b>	WLG-2207 Refer to Note1 for other models
<b>POWER SUPPLY</b>	5Vdc from AC adapter
<b>MODULATION TYPE</b>	CCK, DQPSK, DBPSK for DSSS 64QAM, 16QAM, QPSK, BPSK for OFDM
<b>RADIO TECHNOLOGY</b>	DSSS, OFDM
<b>TRANSFER RATE</b>	802.11b: 11/5.5/2/1Mbps 802.11g: 54/48/36/24/18/12/9/6Mbps
<b>FREQUENCY RANGE</b>	2412MHz ~ 2462MHz
<b>NUMBER OF CHANNEL</b>	11
<b>OUTPUT POWER</b>	51.761mW
<b>ANTENNA TYPE</b>	Dipole antenna with 2.0dBi gain
<b>DATA CABLE</b>	NA
<b>I/O PORTS</b>	RJ45
<b>ASSOCIATED DEVICES</b>	NA

#### NOTE:

- This report is issued as a duplicated report of ADT report no. RF921011R03A except for its different model, brand names and applicant:

Brand	Model	Remarks
Cameo	WLG-2207	
Allnet GmbH	ALL0286	OEM model
TRENDware	TEW-451BRP	OEM model

- The EUT was operated with following power adapter:

<b>BRAND:</b> D-Link
<b>MODEL:</b> SMP-T1178
<b>INPUT:</b> 100-120Vac, 50-60Hz, 0.5A
<b>OUTPUT:</b> 5Vdc, 2.5A
<b>POWER LINE:</b> DC1.8m non-shielded cable without core

- The EUT, operates in the 2.4GHz frequency range, lets you connect IEEE 802.11g or IEEE 802.11b devices to the network. With its high-speed data transmissions of up to 54Mbps.
- The above EUT information was declared by the manufacturer and for more detailed features description, please refer to the manufacturer's specifications or User's Manual.



### 3.2 DESCRIPTION OF TEST MODES

Eleven channels are provided to this EUT.

CHANNEL	FREQUENCY	CHANNEL	FREQUENCY
1	2412 MHz	7	2442 MHz
2	2417 MHz	8	2447 MHz
3	2422 MHz	9	2452 MHz
4	2427 MHz	10	2457 MHz
5	2432 MHz	11	2462 MHz
6	2437 MHz		

#### 3.2.1 CONFIGURATION OF SYSTEM UNDER TEST

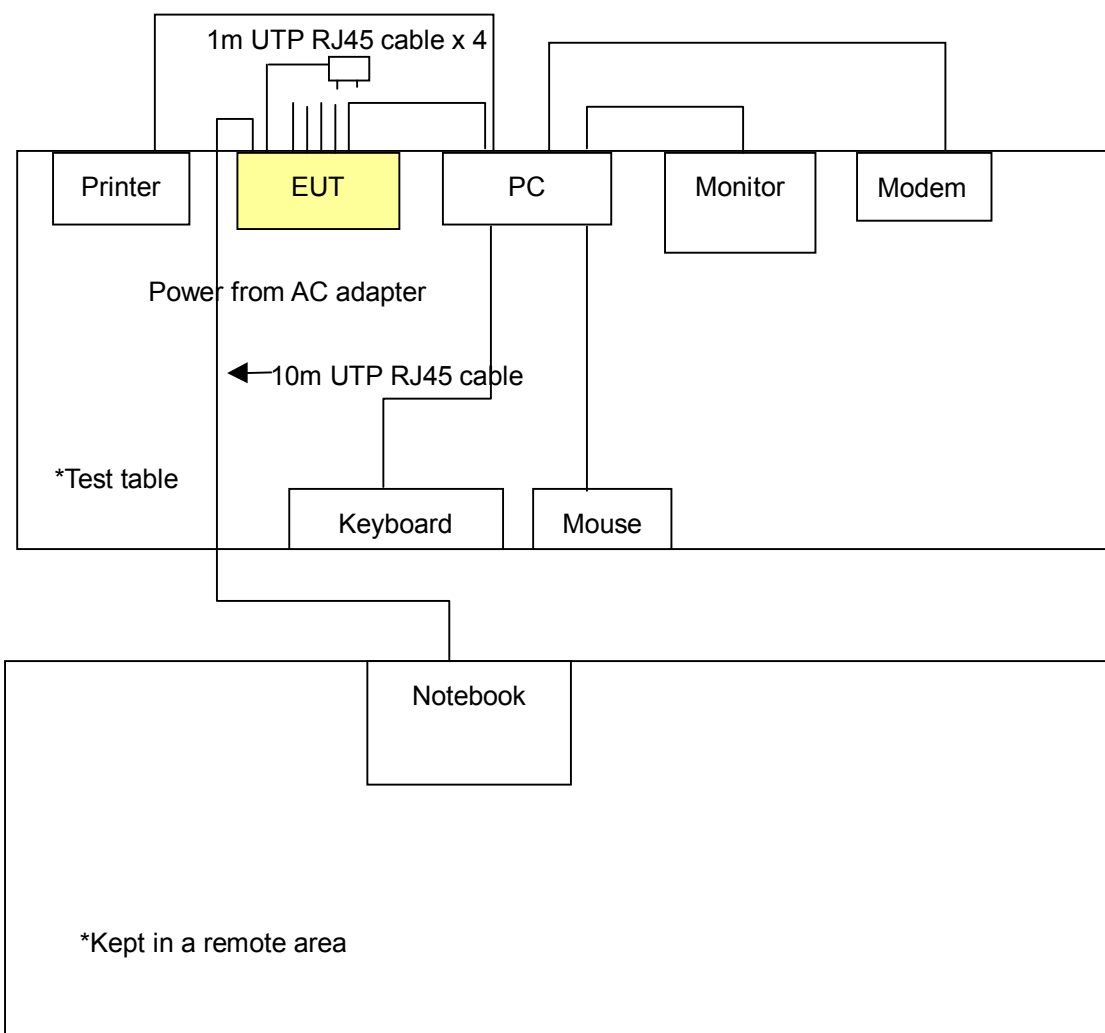



### 3.2.2 TEST MODE APPLICABILITY AND TESTED CHANNEL DETAIL

EUT CONFIGURE MODE	APPLICABLE TO				DESCRIPTION
	PLC	RE<1G	RE≥1G	APCM	
-	√	√	√	√	NA

Where **PLC**: Power Line Conducted Emission                      **RE<1G**: Radiated Emission below 1GHz  
**RE≥1G**: Radiated Emission above 1GHz                      **APCM**: Antenna Port Conducted Measurement

#### **POWER LINE CONDUCTED EMISSION TEST:**

- Pre-Scan has been conducted to determine the worst-case mode from all possible combinations between available modulations, data rates and antenna ports (if EUT with antenna diversity architecture).
- Following channel(s) was (were) selected for the final test as listed below.

MODE	AVAILABLE CHANNEL	TESTED CHANNEL	MODULATION TECHNOLOGY	MODULATION TYPE	DATA RATE (Mbps)
802.11g	1 to 11	1, 6, 11	OFDM	BPSK	6

#### **RADIATED EMISSION TEST (BELOW 1 GHz):**

- Pre-Scan has been conducted to determine the worst-case mode from all possible combinations between available modulations, data rates and antenna ports (if EUT with antenna diversity architecture).
- Following channel(s) was (were) selected for the final test as listed below.

MODE	AVAILABLE CHANNEL	TESTED CHANNEL	MODULATION TECHNOLOGY	MODULATION TYPE	DATA RATE (Mbps)
802.11g	1 to 11	11	OFDM	BPSK	6





### **RADIATED EMISSION TEST (ABOVE 1 GHz):**

- Pre-Scan has been conducted to determine the worst-case mode from all possible combinations between available modulations, data rates and antenna ports (if EUT with antenna diversity architecture).
- Following channel(s) was (were) selected for the final test as listed below.

MODE	AVAILABLE CHANNEL	TESTED CHANNEL	MODULATION TECHNOLOGY	MODULATION TYPE	DATA RATE (Mbps)
802.11b	1 to 11	1, 6, 11	DSSS	CCK	11
802.11g	1 to 11	1, 6, 11	OFDM	BPSK	6

### **BANDEDGE MEASUREMENT:**

- Pre-Scan has been conducted to determine the worst-case mode from all possible combinations between available modulations, data rates and antenna ports (if EUT with antenna diversity architecture).
- Following channel(s) was (were) selected for the final test as listed below.

MODE	AVAILABLE CHANNEL	TESTED CHANNEL	MODULATION TECHNOLOGY	MODULATION TYPE	DATA RATE (Mbps)
802.11b	1 to 11	1, 11	DSSS	CCK	11
802.11g	1 to 11	1, 11	OFDM	BPSK	6

### **ANTENNA PORT CONDUCTED MEASUREMENT:**

- Pre-Scan has been conducted to determine the worst-case mode from all possible combinations between available modulations, data rates and antenna ports (if EUT with antenna diversity architecture).
- Following channel(s) was (were) selected for the final test as listed below.

MODE	AVAILABLE CHANNEL	TESTED CHANNEL	MODULATION TECHNOLOGY	MODULATION TYPE	DATA RATE (Mbps)
802.11b	1 to 11	1, 6, 11	DSSS	CCK	11
802.11g	1 to 11	1, 6, 11	OFDM	BPSK	6

### 3.2.3 GENERAL DESCRIPTION OF APPLIED STANDARDS

The EUT is an 2.4GHz Wireless Broadband Router. According to the specifications of the manufacturer, it must comply with the requirements of the following standards:

#### **FCC Part 15, Subpart C. (15.247)**

#### **ANSI C63.4- 2003**

All test items have been performed and recorded as per the above standards.

**NOTE:** The EUT is also considered as a kind of computer peripheral, because the connection to computer is necessary for typical use. It has been verified to comply with the requirements of FCC Part 15, Subpart B, Class B (DoC). The test report has been issued separately.

### 3.2.4 DESCRIPTION OF SUPPORT UNITS

The EUT has been tested as an independent unit together with other necessary accessories or support units. The following support units or accessories were used to form a representative test configuration during the tests.

NO.	PRODUCT	BRAND	MODEL NO.	SERIAL NO.	FCC ID
1	MONITOR	HP	D2842A	KR93473113	BEJCB910
2	PERSONAL COMPUTER	HP	DTPC 27	SG21103587	FCC DoC
3	PS/2 KEYBOARD	BTC	5200T	F24800221	E5XKB5122WTH01 10
4	PS/2 MOUSE	BTC	M851	N/A	E5XMSM860
5	MODEM	ACEEX	1414	980020514	IFAXDM1414
6	PRINTER	EPSON	LQ-300+	DCGY017054	FCC DoC Approved
7	Notebook	Compaq	N800C	470048-515	FCC DoC Approved

NO.	SIGNAL CABLE DESCRIPTION OF THE ABOVE SUPPORT UNITS
1	1.8 m braid shielded wire, terminated with VGA connector via metallic frame, w/o core.
2	NA
3	1.6 m foil shielded wire, terminated with PS/2 connector via metallic frame, w/o core.
4	1.5 m Non shielded wire, terminated with PS/2 connector via drain wire, w/o core.
5	1.2 m braid shielded wire, terminated with DB25 and DB9 connector via metallic frame, w/o core.
6	1.2m braid shielded wire, terminated with DB25 and Centronics connector via metallic frame, w/o core
7	NA

**NOTE:** All power cords of the above support units are non shielded (1.8m).



## 4. TEST TYPES AND RESULTS

### 4.1 CONDUCTED EMISSION MEASUREMENT

#### 4.1.1 LIMITS OF CONDUCTED EMISSION MEASUREMENT

FREQUENCY OF EMISSION (MHz)	CONDUCTED LIMIT (dB $\mu$ V)	
	Quasi-peak	Average
0.15-0.5	66 to 56	56 to 46
0.5-5	56	46
5-30	60	50

- NOTE:**
1. The lower limit shall apply at the transition frequencies.
  2. The limit decreases in line with the logarithm of the frequency in the range of 0.15 to 0.50 MHz.
  3. All emanations from a class A/B digital device or system, including any network of conductors and apparatus connected thereto, shall not exceed the level of field strengths specified above.

#### 4.1.2 TEST INSTRUMENTS

DESCRIPTION & MANUFACTURER	MODEL NO.	SERIAL NO.	CALIBRATED UNTIL
ROHDE & SCHWARZ Test Receiver	ESCS 30	838251/021	Jan. 20, 2004
ROHDE & SCHWARZ Artificial Mains Network (for EUT)	ESH3-Z5	100218	Dec. 18, 2003
ROHDE & SCHWARZ Artificial Mains Network (for peripherals)	ESH3-Z5	100219	Dec. 18, 2003
ROHDE & SCHWARZ Artificial Mains Network (for peripherals)	ESH3-Z5	100220	Dec. 18, 2003
*ROHDE & SCHWARZ 4-wire ISN	ENY41	837032/016	Nov. 29, 2003
*ROHDE & SCHWARZ 2-wire ISN	ENY22	837497/016	Nov. 29, 2003
Software	Cond-V2M3	NA	NA
RF cable (JYEBAO)	5D-FB	Cable-C10.01	May 01, 2004
SUHNER Terminator (For ROHDE & SCHWARZ LISN)	65BNC-5001	E1-010770	Mar. 24, 2004
SUHNER Terminator (For ROHDE & SCHWARZ LISN)	65BNC-5001	E1-010773	Apr. 06, 2004

- NOTE:**
1. The calibration interval of the above test instruments is 12 months and the calibrations are traceable to NML/ROC and NIST/USA.
  2. "\*": These equipment are used for conducted telecom port test only (if tested).
  3. The test was performed in ADT Shielded Room No. 10.
  4. The VCCI Site Registration No. is C-1312.



#### 4.1.3 TEST PROCEDURES

- a. The EUT was placed 0.4 meters from the conducting wall of the shielded room with EUT being connected to the power mains through a line impedance stabilization network (LISN). Other support units were connected to the power mains through another LISN. The two LISNs provide 50 ohm/ 50uH of coupling impedance for the measuring instrument.
- b. Both lines of the power mains connected to the EUT were checked for maximum conducted interference.
- c. The frequency range from 150kHz to 30MHz was searched. Emission levels under (Limit - 20dB) was not recorded.

#### 4.1.4 DEVIATION FROM TEST STANDARD

No deviation

#### 4.1.5 TEST SETUP

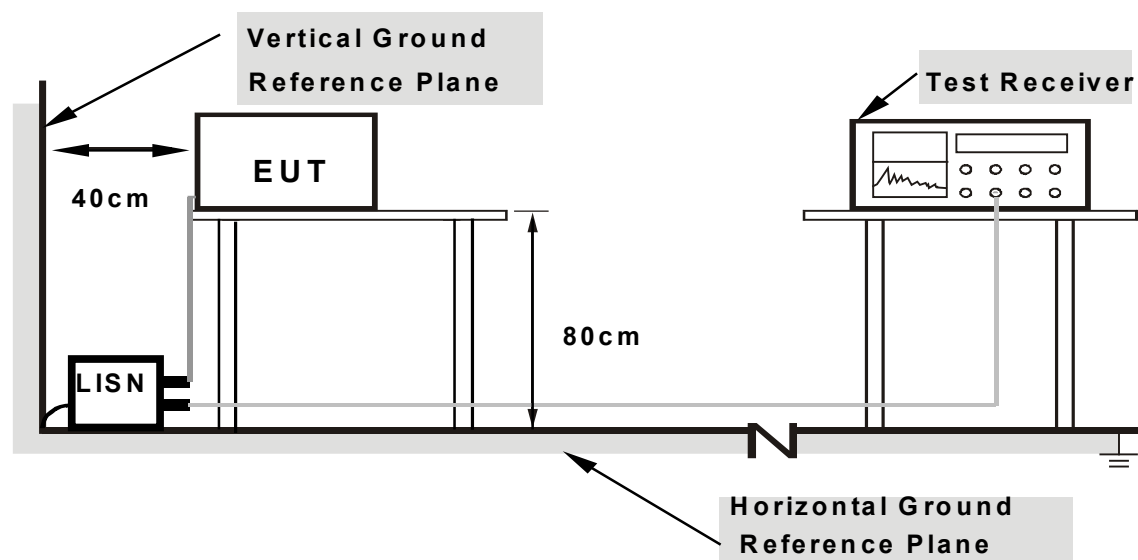

- Note:**
1. Support units were connected to second LISN.
  2. Both of LISNs (AMN) are 80 cm from EUT and at least 80 cm from other units and other metal planes

For the actual test configuration, please refer to the related item – Photographs of the Test Configuration.

#### 4.1.6 EUT OPERATING CONDITIONS

- a. Placed the EUT on the testing table.
- b. The computer system sent data to EUT by command "PING" via RJ45 cable.
- c. The computer system sent "H" messages to Color Monitor and Monitor displayed "H" patterns on its screen.
- d. The computer system sent "H" messages to modem.
- e. The computer system sent "H" messages to the printer, and the printer prints them on paper.
- f. Prepared another notebook PC to act as a communication partner and placed it outside of testing area.
- g. The communication partner ran a test program to enable EUT under transmission/receiving condition continuously at specific channel frequency via RJ45 cable.
- h. The communication partner sent data to EUT by command "PING".



### 4.1.7 TEST RESULTS

#### CONDUCTED WORST-CASE DATA

<b>EUT</b>	2.4GHz Wireless Broadband Router	<b>MEASUREMENT DETAIL</b>	
<b>MODEL</b>	WLG-2207	<b>PHASE</b>	Line 1
<b>CHANNEL</b>	Channel 1	<b>6dB BANDWIDTH</b>	9 kHz
<b>MODULATION TYPE</b>	BPSK	<b>ENVIRONMENTAL CONDITIONS</b>	30deg.C, 60%RH, 991hPa
<b>TRANSFER RATE</b>	6Mbps	<b>INPUT POWER (SYSTEM)</b>	120Vac, 60 Hz
<b>TESTED BY</b>	Hardaway Lee		

No	Freq. [MHz]	Corr. Factor (dB)	Reading Value		Emission Level		Limit		Margin	
			[dB (uV)]		[dB (uV)]		[dB (uV)]		(dB)	
			Q.P.	AV.	Q.P.	AV.	Q.P.	AV.	Q.P.	AV.
1	0.150	0.05	54.12	-	54.17	-	66.00	56.00	-11.83	-
2	0.225	0.06	50.96	-	51.02	-	62.64	52.64	-11.62	-
3	0.377	0.06	40.35	-	40.41	-	58.35	48.35	-17.94	-
4	2.480	0.19	36.33	-	36.52	-	56.00	46.00	-19.48	-
5	4.289	0.23	34.32	-	34.55	-	56.00	46.00	-21.45	-
6	21.512	0.72	41.55	-	42.27	-	60.00	50.00	-17.73	-

\*(The test data is in accordance with ADT Report No.: 921011R03A.)

- REMARKS:**
1. Q.P. and AV. are abbreviations of quasi-peak and average individually.
  2. "-": The Quasi-peak reading value also meets average limit and measurement with the average detector is unnecessary.
  3. The emission levels of other frequencies were very low against the limit.
  4. Margin value = Emission level - Limit value
  5. Correction factor = Insertion loss + Cable loss
  6. Emission Level = Correction Factor + Reading Value.

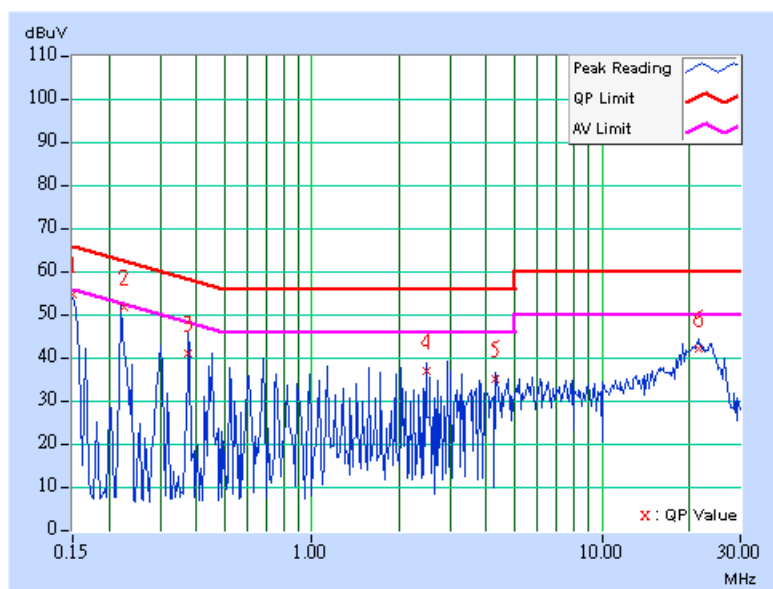



<b>EUT</b>	2.4GHz Wireless Broadband Router	<b>MEASUREMENT DETAIL</b>	
<b>MODEL</b>	WLG-2207	<b>PHASE</b>	Line 2
<b>CHANNEL</b>	Channel 1	<b>6dB BANDWIDTH</b>	9 kHz
<b>MODULATION TYPE</b>	BPSK	<b>ENVIRONMENTAL CONDITIONS</b>	30deg.C, 60%RH, 991hPa
<b>TRANSFER RATE</b>	6Mbps	<b>INPUT POWER (SYSTEM)</b>	120Vac, 60 Hz
<b>TESTED BY</b>	Hardaway Lee		

No	Freq. [MHz]	Corr. Factor (dB)	Reading Value [dB (uV)]		Emission Level [dB (uV)]		Limit [dB (uV)]		Margin (dB)	
			Q.P.	AV.	Q.P.	AV.	Q.P.	AV.	Q.P.	AV.
	1	0.154	0.05	51.88	-	51.93	-	65.79	55.79	-13.86
2	<b>0.224</b>	<b>0.05</b>	<b>51.05</b>	-	<b>51.10</b>	-	<b>62.66</b>	<b>52.66</b>	<b>-11.56</b>	-
3	0.300	0.05	43.41	-	43.46	-	60.25	50.25	-16.79	-
4	0.455	0.06	41.40	-	41.46	-	56.79	46.79	-15.33	-
5	1.582	0.17	34.45	-	34.62	-	56.00	46.00	-21.38	-
6	22.266	0.61	38.65	-	39.26	-	60.00	50.00	-20.74	-

\*(The test data is in accordance with ADT Report No.: 921011R03A.)

- REMARKS:**
1. Q.P. and AV. are abbreviations of quasi-peak and average individually.
  2. "-": The Quasi-peak reading value also meets average limit and measurement with the average detector is unnecessary.
  3. The emission levels of other frequencies were very low against the limit.
  4. Margin value = Emission level - Limit value
  5. Correction factor = Insertion loss + Cable loss
  6. Emission Level = Correction Factor + Reading Value.

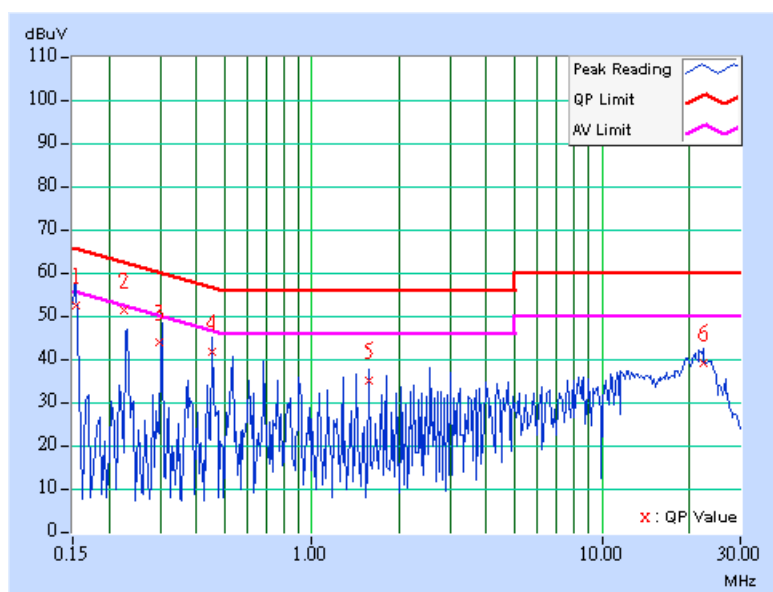



<b>EUT</b>	2.4GHz Wireless Broadband Router	<b>MEASUREMENT DETAIL</b>	
<b>MODEL</b>	WLG-2207	<b>PHASE</b>	Line 1
<b>CHANNEL</b>	Channel 6	<b>6dB BANDWIDTH</b>	9 kHz
<b>MODULATION TYPE</b>	BPSK	<b>ENVIRONMENTAL CONDITIONS</b>	30deg.C, 60%RH, 991hPa
<b>TRANSFER RATE</b>	6Mbps	<b>INPUT POWER (SYSTEM)</b>	120Vac, 60 Hz
<b>TESTED BY</b>	Hardaway Lee		

No	Freq. [MHz]	Corr. Factor (dB)	Reading Value [dB (uV)]		Emission Level [dB (uV)]		Limit [dB (uV)]		Margin (dB)	
			Q.P.	AV.	Q.P.	AV.	Q.P.	AV.	Q.P.	AV.
			1	0.158	0.06	47.66	-	47.72	-	65.58
2	0.220	0.06	40.79	-	40.85	-	62.81	52.81	-21.96	-
3	0.455	0.07	41.91	-	41.98	-	56.79	46.79	-14.81	-
4	1.656	0.17	36.79	-	36.96	-	56.00	46.00	-19.04	-
5	7.820	0.34	32.89	-	33.23	-	60.00	50.00	-26.77	-
6	21.664	0.72	40.97	-	41.69	-	60.00	50.00	-18.31	-

\*(The test data is in accordance with ADT Report No.: 921011R03A.)

- REMARKS:**
1. Q.P. and AV. are abbreviations of quasi-peak and average individually.
  2. "-": The Quasi-peak reading value also meets average limit and measurement with the average detector is unnecessary.
  3. The emission levels of other frequencies were very low against the limit.
  4. Margin value = Emission level - Limit value
  5. Correction factor = Insertion loss + Cable loss
  6. Emission Level = Correction Factor + Reading Value.

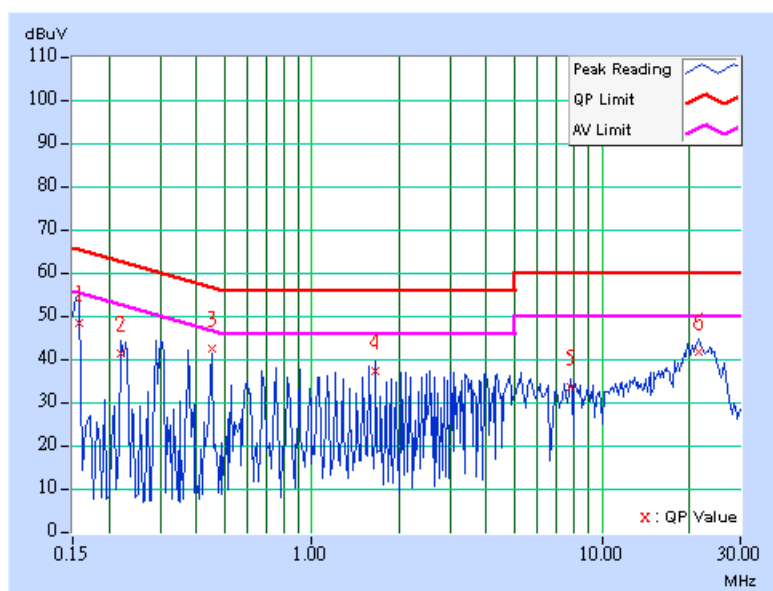





<b>EUT</b>	2.4GHz Wireless Broadband Router	<b>MEASUREMENT DETAIL</b>	
<b>MODEL</b>	WLG-2207	<b>PHASE</b>	Line 2
<b>CHANNEL</b>	Channel 6	<b>6dB BANDWIDTH</b>	9 kHz
<b>MODULATION TYPE</b>	BPSK	<b>ENVIRONMENTAL CONDITIONS</b>	30deg.C, 60%RH, 991hPa
<b>TRANSFER RATE</b>	6Mbps	<b>INPUT POWER (SYSTEM)</b>	120Vac, 60 Hz
<b>TESTED BY</b>	Hardaway Lee		

No	Freq. [MHz]	Corr. Factor (dB)	Reading Value [dB (uV)]		Emission Level [dB (uV)]		Limit [dB (uV)]		Margin (dB)	
			Q.P.	AV.	Q.P.	AV.	Q.P.	AV.	Q.P.	AV.
			1	0.162	0.05	37.58	-	37.63	-	65.38
2	0.224	0.05	48.98	-	49.03	-	62.66	52.66	-13.63	-
3	0.298	0.05	42.01	-	42.06	-	60.29	50.29	-18.23	-
4	1.125	0.16	33.72	-	33.88	-	56.00	46.00	-22.12	-
5	2.930	0.19	33.32	-	33.51	-	56.00	46.00	-22.49	-
6	21.738	0.59	37.69	-	38.28	-	60.00	50.00	-21.72	-

\*(The test data is in accordance with ADT Report No.: 921011R03A.)

- REMARKS:**
1. Q.P. and AV. are abbreviations of quasi-peak and average individually.
  2. "-": The Quasi-peak reading value also meets average limit and measurement with the average detector is unnecessary.
  3. The emission levels of other frequencies were very low against the limit.
  4. Margin value = Emission level - Limit value
  5. Correction factor = Insertion loss + Cable loss
  6. Emission Level = Correction Factor + Reading Value.

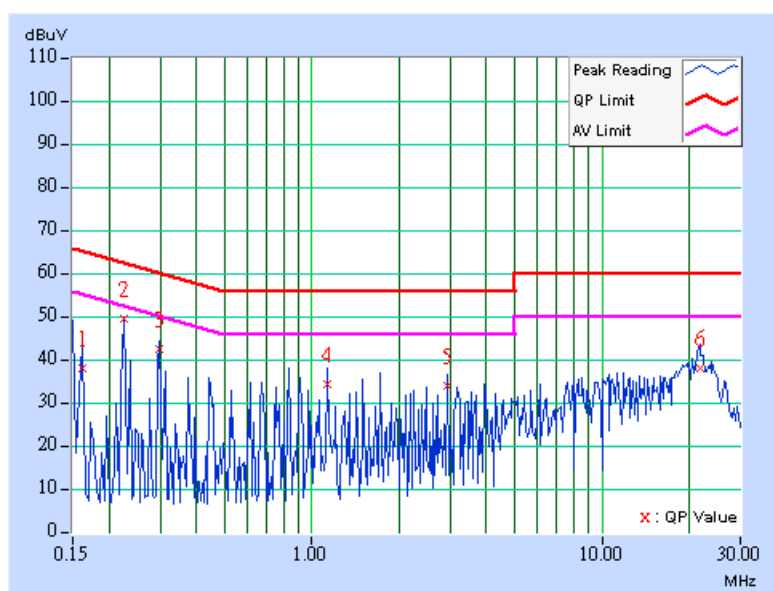



<b>EUT</b>	2.4GHz Wireless Broadband Router	<b>MEASUREMENT DETAIL</b>	
<b>MODEL</b>	WLG-2207	<b>PHASE</b>	Line 1
<b>CHANNEL</b>	Channel 11	<b>6dB BANDWIDTH</b>	9 kHz
<b>MODULATION TYPE</b>	BPSK	<b>ENVIRONMENTAL CONDITIONS</b>	30deg.C, 60%RH, 991hPa
<b>TRANSFER RATE</b>	6Mbps	<b>INPUT POWER (SYSTEM)</b>	120Vac, 60 Hz
<b>TESTED BY</b>	Hardaway Lee		

No	Freq. [MHz]	Corr. Factor (dB)	Reading Value [dB (uV)]		Emission Level [dB (uV)]		Limit [dB (uV)]		Margin (dB)	
			Q.P.	AV.	Q.P.	AV.	Q.P.	AV.	Q.P.	AV.
			1	0.154	0.06	52.91	-	52.97	-	65.79
2	0.302	0.06	46.55	-	46.61	-	60.18	50.18	-13.57	-
3	0.451	0.07	42.87	-	42.94	-	56.86	46.86	-13.92	-
4	3.836	0.22	35.92	-	36.14	-	56.00	46.00	-19.86	-
5	16.844	0.59	35.68	-	36.27	-	60.00	50.00	-23.73	-
6	21.883	0.73	40.98	-	41.71	-	60.00	50.00	-18.29	-

\*(The test data is in accordance with ADT Report No.: 921011R03A.)

- REMARKS:**
1. Q.P. and AV. are abbreviations of quasi-peak and average individually.
  2. "-": The Quasi-peak reading value also meets average limit and measurement with the average detector is unnecessary.
  3. The emission levels of other frequencies were very low against the limit.
  4. Margin value = Emission level - Limit value
  5. Correction factor = Insertion loss + Cable loss
  6. Emission Level = Correction Factor + Reading Value.

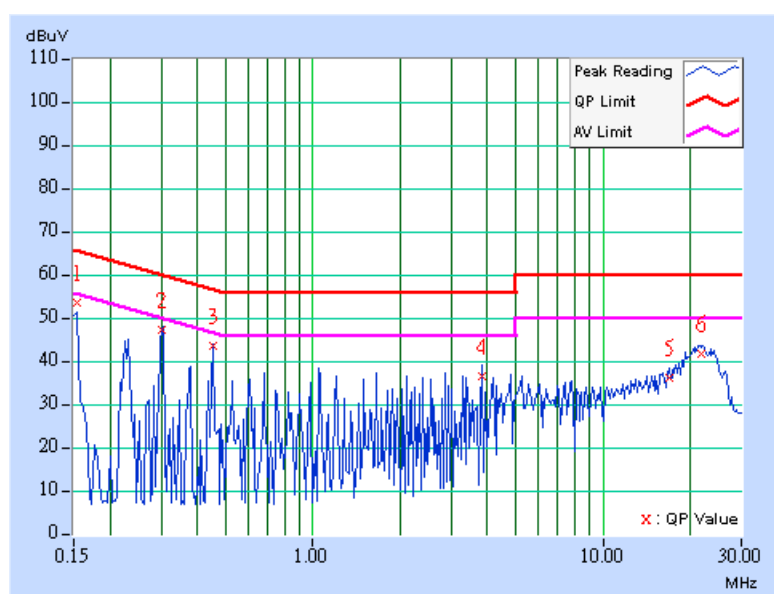



<b>EUT</b>	2.4GHz Wireless Broadband Router	<b>MEASUREMENT DETAIL</b>	
<b>MODEL</b>	WLG-2207	<b>PHASE</b>	Line 2
<b>CHANNEL</b>	Channel 11	<b>6dB BANDWIDTH</b>	9 kHz
<b>MODULATION TYPE</b>	BPSK	<b>ENVIRONMENTAL CONDITIONS</b>	30deg.C, 60%RH, 991hPa
<b>TRANSFER RATE</b>	6Mbps	<b>INPUT POWER (SYSTEM)</b>	120Vac, 60 Hz
<b>TESTED BY</b>	Hardaway Lee		

No	Freq. [MHz]	Corr. Factor (dB)	Reading Value		Emission Level		Limit		Margin	
			[dB (uV)]		[dB (uV)]		[dB (uV)]		(dB)	
			Q.P.	AV.	Q.P.	AV.	Q.P.	AV.	Q.P.	AV.
1	0.150	0.05	53.55	-	53.60	-	66.00	56.00	-12.40	-
2	0.228	0.05	48.91	-	48.96	-	62.52	52.52	-13.56	-
3	0.380	0.05	40.77	-	40.82	-	58.27	48.27	-17.45	-
4	0.677	0.10	35.17	-	35.27	-	56.00	46.00	-20.73	-
5	11.207	0.41	34.63	-	35.04	-	60.00	50.00	-24.96	-
6	22.188	0.61	38.82	-	39.43	-	60.00	50.00	-20.57	-

\*(The test data is in accordance with ADT Report No.: 921011R03A.)

- REMARKS:**
1. Q.P. and AV. are abbreviations of quasi-peak and average individually.
  2. "-": The Quasi-peak reading value also meets average limit and measurement with the average detector is unnecessary.
  3. The emission levels of other frequencies were very low against the limit.
  4. Margin value = Emission level - Limit value
  5. Correction factor = Insertion loss + Cable loss
  6. Emission Level = Correction Factor + Reading Value.

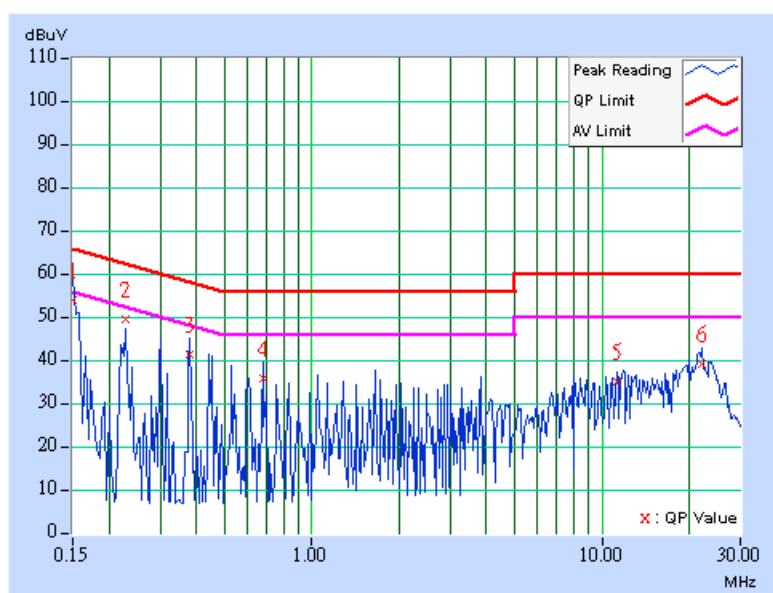



## 4.2 RADIATED EMISSION MEASUREMENT

### 4.2.1 LIMITS OF RADIATED EMISSION MEASUREMENT

Emissions radiated outside of the specified bands, shall be according to the general radiated limits in 15.209 as following:

FREQUENCIES (MHz)	FIELD STRENGTH (microvolts/meter)	MEASUREMENT DISTANCE (meters)
0.009 ~ 0.490	2400/F(kHz)	300
0.490 ~ 1.705	24000/F(kHz)	30
1.705 ~ 30.0	30	30
30 ~ 88	100	3
88 ~ 216	150	3
216 ~ 960	200	3
Above 960	500	3

**NOTE:**

1. The lower limit shall apply at the transition frequencies.
2. Emission level (dBuV/m) = 20 log Emission level (uV/m).
3. As shown in 15.35(b), for frequencies above 1000MHz, the field strength limits are based on average detector, however, the peak field strength of any emission shall not exceed the maximum permitted average limits, specified above by more than 20dB under any condition of modulation.



## 4.2.2 TEST INSTRUMENTS

DESCRIPTION & MANUFACTURER	MODEL NO.	SERIAL NO.	CALIBRATED UNTIL
* HP Spectrum Analyzer	8590L	3520A00667	Aug. 28, 2004
* CHASE Preamplifier	CPA9231A/4	3215	Nov. 06, 2003
* HP Preamplifier	8449B	3008A01201	Dec. 01, 2003
HP Preamplifier	8449B	3008A01292	Aug. 11, 2004
* ROHDE & SCHWARZ TEST RECEIVER	ESVS10	846285/012	Aug. 28, 2004
ROHDE & SCHWARZ TEST RECEIVER	ESMI	839013/007 839379/002	Feb. 13, 2004
SCHAFFNER Tunable Dipole Antenna	VHBA 9123	459	Nov. 22, 2003
SCHWARZBECK Tunable Dipole Antenna	UHA 9105	977	
* CHASE BILOG Antenna	CBL6112B	2751	Mar. 21, 2004
* SCHWARZBECK Horn Antenna	BBHA9120-D1	D130	Jun. 30, 2004
* EMCO Horn Antenna	3115	9312-4192	Mar. 23, 2004
* CHANCE Turn Table & Tower Controller	ACS-I	NA	NA
* Software	ADT_Radiated_V5.14	NA	NA
* ANRITSU RF Switches	MP59B	M51167	Aug. 16, 2004
* TIMES RF cable	LMR-600	CABLE-ST6-01	Aug. 20, 2004

- NOTE:** 1. The calibration interval of the above test instruments is 12 months. And the calibrations are traceable to NML/ROC and NIST/USA.
2. "\*" = These equipment are used for the final measurement.
3. The horn antenna and HP preamplifier (model: 8449B) are used only for the measurement of emission frequency above 1GHz if tested.
4. The test was performed in ADT Open Site No. 6.
5. The VCCI Site Registration No. is R-728.



#### 4.2.3 TEST PROCEDURES

- a. The EUT was placed on the top of a rotating table 0.8 meters above the ground at a 3 meter semi-anechoic chamber. The table was rotated 360 degrees to determine the position of the highest radiation.
- b. The EUT was set 3 meters away from the interference-receiving antenna, which was mounted on the top of a variable-height antenna tower.
- c. The antenna is a broadband antenna, and its height is varied from one meter to four meters above the ground to determine the maximum value of the field strength. Both horizontal and vertical polarizations of the antenna are set to make the measurement.
- d. For each suspected emission, the EUT was arranged to its worst case and then the antenna was tuned to heights from 1 meter to 4 meters and the rotatable table was turned from 0 degrees to 360 degrees to find the maximum reading.
- e. The test-receiver system was set to Peak Detect Function and Specified Bandwidth with Maximum Hold Mode.
- f. If the emission level of the EUT in peak mode was lower than the limit specified, then testing could be stopped and the peak values of the EUT would be reported. Otherwise the emissions would be re-tested one by one using peak, quasi-peak method or average method as specified and then reported in data sheet.

**NOTE:**

1. The resolution bandwidth and video bandwidth of test receiver/spectrum analyzer is 120kHz for Quasi-peak detection at frequency below 1GHz.
2. The resolution bandwidth and video bandwidth of test receiver/spectrum analyzer is 1 MHz for Peak detection (PK) at frequency above 1GHz.
3. The resolution bandwidth of test receiver/spectrum analyzer is 1 MHz and the video bandwidth is 300 Hz for Average detection (AV) at frequency above 1GHz.

#### 4.2.4 DEVIATION FROM TEST STANDARD

No deviation

#### 4.2.5 TEST SETUP

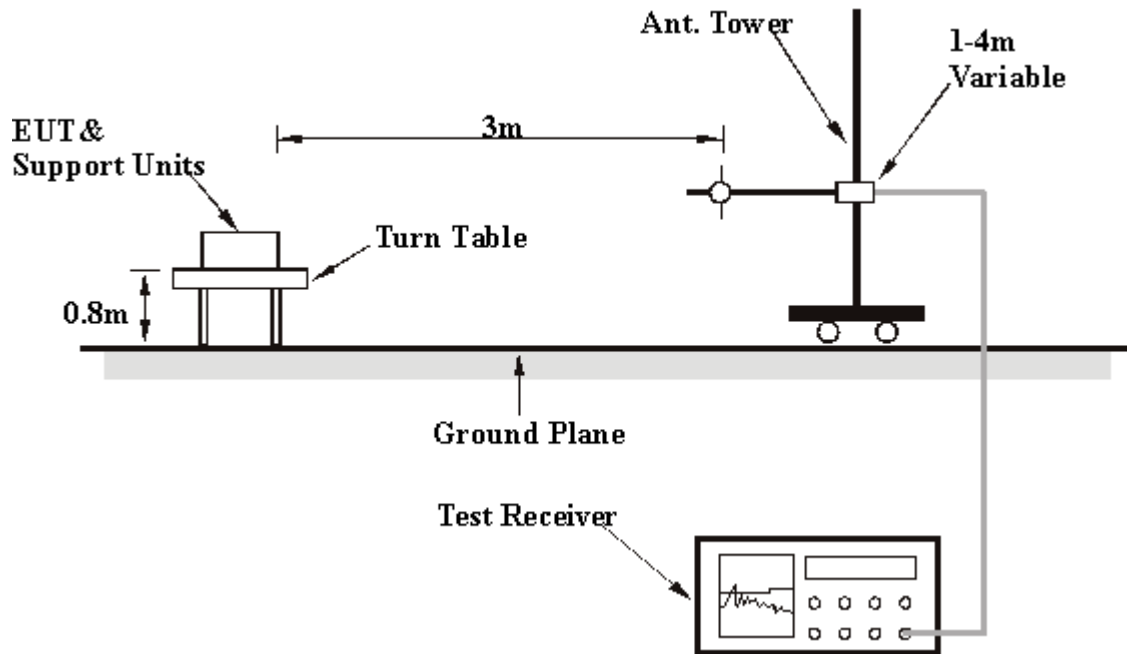

For the actual test configuration, please refer to the related item – Photographs of the Test Configuration.

#### 4.2.6 EUT OPERATING CONDITIONS

Same as 4.1.6

## 4.2.7 TEST RESULTS

**RADIATED WORST-CASE DATA: BELOW 1GHz**

<b>EUT</b>	2.4GHz Wireless Broadband Router	<b>MEASUREMENT DETAIL</b>	
<b>MODEL</b>	WLG-2207	<b>FREQUENCY RANGE</b>	Below 1000MHz
<b>CHANNEL</b>	Channel 11	<b>DETECTOR FUNCTION</b>	Quasi-Peak
<b>MODULATION TYPE</b>	BPSK	<b>ENVIRONMENTAL CONDITIONS</b>	25deg. C, 55%RH, 991hPa
<b>TRANSFER RATE</b>	6Mbps	<b>INPUT POWER (SYSTEM)</b>	120Vac, 60 Hz
<b>TESTED BY</b>	Steven Lu		

<b>ANTENNA POLARITY &amp; TEST DISTANCE: HORIZONTAL AT 3 M</b>								
No.	Freq. (MHz)	Emission Level (dBuV/m)	Limit (dBuV/m)	Margin (dB)	Antenna Height (m)	Table Angle (Degree)	Raw Value (dBuV)	Correction Factor (dB/m)
1	250.94	30.2 QP	46.00	-15.79	1.50 H	286	16.81	13.40
2	351.18	37.0 QP	46.00	-8.96	1.00 H	88	20.59	16.45
3	375.97	35.3 QP	46.00	-10.70	1.50 H	166	18.21	17.09
4	451.41	33.1 QP	46.00	-12.89	1.00 H	220	13.79	19.32
5	500.99	36.8 QP	46.00	-9.18	1.00 H	160	16.78	20.03
6	540.87	30.4 QP	46.00	-15.61	1.50 H	208	9.47	20.92
7	576.43	29.4 QP	46.00	-16.56	1.50 H	208	7.54	21.90
8	775.82	32.6 QP	46.00	-13.40	1.00 H	244	7.11	25.49
9	811.39	40.2 QP	46.00	-5.84	1.00 H	166	14.42	25.74
10	900.84	34.5 QP	46.00	-11.46	1.00 H	262	7.39	27.15

\*(The test data is in accordance with ADT Report No.: 921011R03A.)

- REMARKS:**
1. Emission level (dBuV/m) = Raw Value (dBuV) + Correction Factor (dB/m).
  2. Correction Factor (dB/m) = Antenna Factor (dB/m) + Cable Factor (dB).
  3. The other emission levels were very low against the limit.
  4. Margin value = Emission level – Limit value.





<b>EUT</b>	2.4GHz Wireless Broadband Router	<b>MEASUREMENT DETAIL</b>	
<b>MODEL</b>	WLG-2207	<b>FREQUENCY RANGE</b>	Below 1000MHz
<b>CHANNEL</b>	Channel 11	<b>DETECTOR FUNCTION</b>	Quasi-Peak
<b>MODULATION TYPE</b>	BPSK	<b>ENVIRONMENTAL CONDITIONS</b>	25deg. C, 55%RH, 991hPa
<b>TRANSFER RATE</b>	6Mbps	<b>INPUT POWER (SYSTEM)</b>	120Vac, 60 Hz
<b>TESTED BY</b>	Steven Lu		

<b>ANTENNA POLARITY &amp; TEST DISTANCE: VERTICAL AT 3 M</b>								
No.	Freq. (MHz)	Emission Level (dBuV/m)	Limit (dBuV/m)	Margin (dB)	Antenna Height (m)	Table Angle (Degree)	Raw Value (dBuV)	Correction Factor (dB/m)
1	250.94	42.7 QP	46.00	-3.27	1.00 V	256	29.33	13.40
2	351.18	29.8 QP	46.00	-16.25	1.25 V	154	13.30	16.45
3	375.97	29.1 QP	46.00	-16.93	1.25 V	280	11.98	17.09
4	451.41	33.0 QP	46.00	-12.99	1.00 V	100	13.69	19.32
5	500.99	33.4 QP	46.00	-12.56	1.25 V	196	13.41	20.03
6	540.87	33.8 QP	46.00	-12.18	1.00 V	10	12.90	20.92
7	631.40	31.5 QP	46.00	-14.46	1.00 V	274	8.53	23.01
8	720.86	37.6 QP	46.00	-8.42	1.00 V	250	13.02	24.55
9	811.39	39.2 QP	46.00	-6.83	1.00 V	184	13.43	25.74
10	900.84	35.4 QP	46.00	-10.62	1.00 V	136	8.23	27.15
11	991.38	35.6 QP	54.00	-18.36	1.00 V	220	7.74	27.89

\*(The test data is in accordance with ADT Report No.: 921011R03A.)

- REMARKS:**
1. Emission level (dBuV/m) = Raw Value (dBuV) + Correction Factor (dB/m).
  2. Correction Factor (dB/m) = Antenna Factor (dB/m) + Cable Factor (dB).
  3. The other emission levels were very low against the limit.
  4. Margin value = Emission level – Limit value.

**802.11b DSSS MODULATION**

<b>EUT</b>	2.4GHz Wireless Broadband Router	<b>MEASUREMENT DETAIL</b>	
<b>MODEL</b>	WLG-2207	<b>FREQUENCY RANGE</b>	1 ~ 25GHz
<b>CHANNEL</b>	Channel 1	<b>DETECTOR FUNCTION</b>	Peak (PK) Average (AV)
<b>MODULATION TYPE</b>	CCK	<b>ENVIRONMENTAL CONDITIONS</b>	25deg. C, 55%RH, 991hPa
<b>TRANSFER RATE</b>	11Mbps	<b>INPUT POWER (SYSTEM)</b>	120Vac, 60 Hz
<b>TESTED BY</b>	Steven Lu		

**ANTENNA POLARITY & TEST DISTANCE: HORIZONTAL AT 3 M**

No.	Freq. (MHz)	Emission Level (dBuV/m)	Limit (dBuV/m)	Margin (dB)	Antenna Height (m)	Table Angle (Degree)	Raw Value (dBuV)	Correction Factor (dB/m)
1	2320.00	54.8 PK	74.00	-19.25	1.22 H	144	23.45	31.30
1	2320.00	38.4 AV	54.00	-15.63	1.22 H	144	7.07	31.30
2	*2412.00	104.3 PK			1.22 H	144	72.74	31.56
2	*2412.00	96.6 AV			1.22 H	144	65.01	31.56
3	2688.00	56.4 PK	84.30	-27.90	1.22 H	144	23.81	32.62
3	2688.00	40.1 AV	76.60	-36.50	1.22 H	144	7.52	32.62
4	4824.00	48.5 PK	74.00	-25.54	1.14 H	203	10.03	38.43
4	4824.00	35.50 AV	54.00	-18.50	1.14 H	203	-2.93	38.43

**ANTENNA POLARITY & TEST DISTANCE: VERTICAL AT 3 M**

No.	Freq. (MHz)	Emission Level (dBuV/m)	Limit (dBuV/m)	Margin (dB)	Antenna Height (m)	Table Angle (Degree)	Raw Value (dBuV)	Correction Factor (dB/m)
1	2320.00	56.7 PK	74.00	-17.35	1.24 V	118	25.35	31.30
1	2320.00	48.0 AV	54.00	-6.00	1.24 V	118	16.70	31.30
2	*2412.00	112.9 PK			1.24 V	118	81.37	31.56
2	*2412.00	106.2 AV			1.24 V	118	74.64	31.56
3	2688.00	65.1 PK	92.90	-27.80	1.24 V	118	32.44	32.62
3	2688.00	50.2 AV	86.20	-36.00	1.24 V	118	17.55	32.62
4	4824.00	50.2 PK	74.00	-23.80	1.57 V	324	11.76	38.43
4	4824.00	36.9 AV	54.00	-17.10	1.57 V	324	-1.54	38.43
5	7236.00	54.7 PK	74.00	-19.30	1.18 V	68	12.49	42.21
5	7236.00	41.4 AV	54.00	-12.58	1.18 V	68	-0.79	42.21
6	9648.00	59.1 PK	74.00	-14.89	1.47 V	253	14.87	44.24
6	9648.00	43.7 AV	54.00	-10.28	1.47 V	253	-0.52	44.24

\*(The test data is in accordance with ADT Report No.: 921011R03A.)

- REMARKS:**
1. Emission level (dBuV/m) = Raw Value (dBuV) + Correction Factor (dB/m).
  2. Correction Factor (dB/m) = Antenna Factor (dB/m) + Cable Factor (dB).
  3. The other emission levels were very low against the limit.
  4. Margin value = Emission level – Limit value.
  5. “ \* “: Fundamental frequency.

<b>EUT</b>	2.4GHz Wireless Broadband Router	<b>MEASUREMENT DETAIL</b>	
<b>MODEL</b>	WLG-2207	<b>FREQUENCY RANGE</b>	1 ~ 25GHz
<b>CHANNEL</b>	Channel 6	<b>DETECTOR FUNCTION</b>	Peak (PK) Average (AV)
<b>MODULATION TYPE</b>	CCK	<b>ENVIRONMENTAL CONDITIONS</b>	25deg. C, 55%RH, 991hPa
<b>TRANSFER RATE</b>	11Mbps	<b>INPUT POWER (SYSTEM)</b>	120Vac, 60 Hz
<b>TESTED BY</b>	Steven Lu		

**ANTENNA POLARITY & TEST DISTANCE: HORIZONTAL AT 3 M**

No.	Freq. (MHz)	Emission Level (dBuV/m)	Limit (dBuV/m)	Margin (dB)	Antenna Height (m)	Table Angle (Degree)	Raw Value (dBuV)	Correction Factor (dB/m)
1	*2437.00	103.6 PK			1.02 H	129	71.96	31.64
1	*2437.00	95.9 AV			1.02 H	129	64.25	31.64
2	2688.00	47.2 PK	83.60	-36.40	1.02 H	129	14.56	32.62
2	2688.00	39.5 AV	75.90	-36.40	1.02 H	129	6.85	32.62
3	4874.00	48.9 PK	74.00	-25.12	1.24 H	239	10.41	38.46
3	4874.00	35.0 AV	54.00	-18.99	1.24 H	239	-3.46	38.46

**ANTENNA POLARITY & TEST DISTANCE: VERTICAL AT 3 M**

No.	Freq. (MHz)	Emission Level (dBuV/m)	Limit (dBuV/m)	Margin (dB)	Antenna Height (m)	Table Angle (Degree)	Raw Value (dBuV)	Correction Factor (dB/m)
1	*2437.00	112.5 PK			1.11 V	117	78.90	33.70
1	*2437.00	106.2 AV			1.20 V	204	74.59	31.64
2	2688.00	57.2 PK	92.50	-35.30	1.20 V	204	24.56	32.62
2	2688.00	49.8 AV	86.20	-36.40	1.20 V	204	17.14	32.62
3	4874.00	52.4 PK	74.00	-21.63	1.44 V	125	13.91	38.46
3	4874.00	37.9 AV	54.00	-16.08	1.44 V	125	-0.54	38.46
4	7311.28	56.2 PK	74.00	-17.77	1.22 V	235	13.91	42.32
4	7311.28	40.2 AV	54.00	-13.77	1.22 V	235	-2.09	42.32
5	9748.00	61.4 PK	74.00	-12.65	1.00 V	196	16.78	44.57
5	9748.00	44.4 AV	54.00	-9.64	1.00 V	196	-0.21	44.57

\*(The test data is in accordance with ADT Report No.: 921011R03A.)

- REMARKS:**
1. Emission level (dBuV/m) = Raw Value (dBuV) + Correction Factor (dB/m).
  2. Correction Factor (dB/m) = Antenna Factor (dB/m) + Cable Factor (dB).
  3. The other emission levels were very low against the limit.
  4. Margin value = Emission level – Limit value.
  5. “ \* “: Fundamental frequency.



<b>EUT</b>	2.4GHz Wireless Broadband Router	<b>MEASUREMENT DETAIL</b>	
<b>MODEL</b>	WLG-2207	<b>FREQUENCY RANGE</b>	1 ~ 25GHz
<b>CHANNEL</b>	Channel 11	<b>DETECTOR FUNCTION</b>	Peak (PK) Average (AV)
<b>MODULATION TYPE</b>	CCK	<b>ENVIRONMENTAL CONDITIONS</b>	25deg. C, 55%RH, 991hPa
<b>TRANSFER RATE</b>	11Mbps	<b>INPUT POWER (SYSTEM)</b>	120Vac, 60 Hz
<b>TESTED BY</b>	Steven Lu		

#### ANTENNA POLARITY & TEST DISTANCE: HORIZONTAL AT 3 M

No.	Freq. (MHz)	Emission Level (dBuV/m)	Limit (dBuV/m)	Margin (dB)	Antenna Height (m)	Table Angle (Degree)	Raw Value (dBuV)	Correction Factor (dB/m)
1	*2462.00	103.7 PK			1.27 H	132	71.95	31.71
1	*2462.00	96.1 AV			1.27 H	132	64.43	31.71
2	2483.50	55.0 PK	74.00	-19.02	1.27 H	132	23.21	31.77
2	2483.50	36.8 AV	54.00	-17.18	1.27 H	132	5.05	31.77
3	2688.00	55.4 PK	83.70	-28.30	1.27 H	132	22.81	32.62
3	2688.00	42.3 AV	76.10	-33.80	1.27 H	132	9.71	32.62
4	4924.00	48.7 PK	74.00	-25.30	1.24 H	24	10.20	38.49
4	4924.00	35.4 AV	54.00	-18.59	1.24 H	24	-3.09	38.49

#### ANTENNA POLARITY & TEST DISTANCE: VERTICAL AT 3 M

No.	Freq. (MHz)	Emission Level (dBuV/m)	Limit (dBuV/m)	Margin (dB)	Antenna Height (m)	Table Angle (Degree)	Raw Value (dBuV)	Correction Factor (dB/m)
1	*2462.00	112.8 PK			1.10 V	123	81.13	31.71
1	*2462.00	106.2 AV			1.10 V	123	74.46	31.71
2	2483.50	64.2 PK	74.00	-9.84	1.10 V	123	32.39	31.77
2	2483.50	46.9 AV	54.00	-7.15	1.10 V	123	15.08	31.77
3	2688.00	64.6 PK	92.80	-28.20	1.10 V	123	31.99	32.62
3	2688.00	52.3 AV	86.20	-33.90	1.10 V	123	19.69	32.62
4	4924.00	52.7 PK	74.00	-21.30	1.22 V	155	14.21	38.49
4	4924.00	37.9 AV	54.00	-16.07	1.22 V	155	-0.56	38.49
5	7386.00	56.4 PK	74.00	-17.65	1.03 V	188	13.91	42.44
5	7386.00	41.0 AV	54.00	-13.05	1.03 V	188	-1.49	42.44
6	9848.11	61.2 PK	74.00	-12.85	1.82 V	132	16.39	44.76
6	9848.11	44.5 AV	54.00	-9.47	1.82 V	132	-0.23	44.76

\*(The test data is in accordance with ADT Report No.: 921011R03A.)

- REMARKS:**
1. Emission level (dBuV/m) = Raw Value (dBuV) + Correction Factor (dB/m).
  2. Correction Factor (dB/m) = Antenna Factor (dB/m) + Cable Factor (dB).
  3. The other emission levels were very low against the limit.
  4. Margin value = Emission level – Limit value.
  5. “ \* “: Fundamental frequency.



### 802.11g OFDM MODULATION

<b>EUT</b>	2.4GHz Wireless Broadband Router	<b>MEASUREMENT DETAIL</b>	
<b>MODEL</b>	WLG-2207	<b>FREQUENCY RANGE</b>	1 ~ 25GHz
<b>CHANNEL</b>	Channel 1	<b>DETECTOR FUNCTION</b>	Peak (PK) Average (AV)
<b>MODULATION TYPE</b>	BPSK	<b>ENVIRONMENTAL CONDITIONS</b>	25deg. C, 55%RH, 991hPa
<b>TRANSFER RATE</b>	6Mbps	<b>INPUT POWER (SYSTEM)</b>	120Vac, 60 Hz
<b>TESTED BY</b>	Steven Lu		

#### ANTENNA POLARITY & TEST DISTANCE: HORIZONTAL AT 3 M

No.	Freq. (MHz)	Emission Level (dBuV/m)	Limit (dBuV/m)	Margin (dB)	Antenna Height (m)	Table Angle (Degree)	Raw Value (dBuV)	Correction Factor (dB/m)
1	2320.00	57.5 PK	74.00	-16.54	1.08 H	227	26.16	31.30
1	2320.00	38.9 AV	54.00	-15.15	1.08 H	227	7.55	31.30
2	*2412.00	99.1 PK			1.08 H	227	67.52	31.56
2	*2412.00	88.4 AV			1.08 H	227	56.88	31.56
3	2688.00	53.2 PK	79.10	-25.90	1.08 H	227	20.53	32.62
3	2688.00	40.0 AV	68.40	-28.40	1.08 H	227	7.37	32.62
4	4924.00	47.1 PK	74.00	-26.86	1.14 H	225	8.64	38.49
4	4924.00	36.1 AV	54.00	-17.92	1.14 H	225	-2.42	38.49

#### ANTENNA POLARITY & TEST DISTANCE: VERTICAL AT 3 M

No.	Freq. (MHz)	Emission Level (dBuV/m)	Limit (dBuV/m)	Margin (dB)	Antenna Height (m)	Table Angle (Degree)	Raw Value (dBuV)	Correction Factor (dB/m)
1	2320.00	64.5 PK	74.00	-9.49	1.27 V	111	33.21	31.30
1	2320.00	46.9 AV	54.00	-7.09	1.27 V	111	15.61	31.30
2	*2412.00	106.1 PK			1.27 V	111	74.57	31.56
2	*2412.00	96.5 AV			1.27 V	111	64.94	31.56
3	2688.00	60.2 PK	86.10	-25.90	1.27 V	111	27.58	32.62
3	2688.00	48.1 AV	76.50	-28.40	1.27 V	111	15.43	32.62
4	4824.00	48.5 PK	74.00	-25.54	1.27 V	182	10.03	38.43
4	4824.00	36.4 AV	54.00	-17.65	1.27 V	182	-2.08	38.43

\*(The test data is in accordance with ADT Report No.: 921011R03A.)

- REMARKS:**
1. Emission level (dBuV/m) = Raw Value (dBuV) + Correction Factor (dB/m).
  2. Correction Factor (dB/m) = Antenna Factor (dB/m) + Cable Factor (dB).
  3. The other emission levels were very low against the limit.
  4. Margin value = Emission level – Limit value.
  5. “ \* “: Fundamental frequency.



<b>EUT</b>	2.4GHz Wireless Broadband Router	<b>MEASUREMENT DETAIL</b>	
<b>MODEL</b>	WLG-2207	<b>FREQUENCY RANGE</b>	1 ~ 25GHz
<b>CHANNEL</b>	Channel 6	<b>DETECTOR FUNCTION</b>	Peak (PK) Average (AV)
<b>MODULATION TYPE</b>	BPSK	<b>ENVIRONMENTAL CONDITIONS</b>	25deg. C, 55%RH, 991hPa
<b>TRANSFER RATE</b>	6Mbps	<b>INPUT POWER (SYSTEM)</b>	120Vac, 60 Hz
<b>TESTED BY</b>	Steven Lu		

**ANTENNA POLARITY & TEST DISTANCE: HORIZONTAL AT 3 M**

No.	Freq. (MHz)	Emission Level (dBuV/m)	Limit (dBuV/m)	Margin (dB)	Antenna Height (m)	Table Angle (Degree)	Raw Value (dBuV)	Correction Factor (dB/m)
1	*2437.00	98.6 PK			1.10 H	234	66.99	31.64
1	*2437.00	87.8 AV			1.10 H	234	56.12	31.64
2	2688.00	51.7 PK	78.60	-26.90	1.10 H	234	19.09	32.62
2	2688.00	39.6 AV	67.80	-28.20	1.10 H	234	7.00	32.62
3	4874.00	46.1 PK	74.00	-27.90	1.14 H	225	7.63	38.46
3	4874.00	34.8 AV	54.00	-19.22	1.14 H	225	-3.69	38.46

**ANTENNA POLARITY & TEST DISTANCE: VERTICAL AT 3 M**

No.	Freq. (MHz)	Emission Level (dBuV/m)	Limit (dBuV/m)	Margin (dB)	Antenna Height (m)	Table Angle (Degree)	Raw Value (dBuV)	Correction Factor (dB/m)
1	*2437.00	107.3 PK			1.28 V	114	75.62	31.64
1	*2437.00	97.6 AV			1.28 V	114	65.96	31.64
2	2688.00	60.3 PK	87.30	-27.00	1.28 V	114	27.72	32.62
2	2688.00	49.5 AV	77.60	-28.10	1.28 V	114	16.84	32.62
3	4874.00	49.5 PK	74.00	-24.48	1.44 V	122	11.05	38.46
3	4874.00	37.8 AV	54.00	-16.19	1.44 V	122	-0.66	38.46

\*(The test data is in accordance with ADT Report No.: 921011R03A.)

- REMARKS:**
1. Emission level (dBuV/m) = Raw Value (dBuV) + Correction Factor (dB/m).
  2. Correction Factor (dB/m) = Antenna Factor (dB/m) + Cable Factor (dB).
  3. The other emission levels were very low against the limit.
  4. Margin value = Emission level – Limit value.
  5. “ \* “: Fundamental frequency.



<b>EUT</b>	2.4GHz Wireless Broadband Router	<b>MEASUREMENT DETAIL</b>	
<b>MODEL</b>	WLG-2207	<b>FREQUENCY RANGE</b>	1 ~ 25GHz
<b>CHANNEL</b>	Channel 11	<b>DETECTOR FUNCTION</b>	Peak (PK) Average (AV)
<b>MODULATION TYPE</b>	BPSK	<b>ENVIRONMENTAL CONDITIONS</b>	25deg. C, 55%RH, 991hPa
<b>TRANSFER RATE</b>	6Mbps	<b>INPUT POWER (SYSTEM)</b>	120Vac, 60 Hz
<b>TESTED BY</b>	Steven Lu		

<b>ANTENNA POLARITY &amp; TEST DISTANCE: HORIZONTAL AT 3 M</b>								
No.	Freq. (MHz)	Emission Level (dBuV/m)	Limit (dBuV/m)	Margin (dB)	Antenna Height (m)	Table Angle (Degree)	Raw Value (dBuV)	Correction Factor (dB/m)
1	*2462.00	100.2 PK			1.07 H	227	68.49	31.71
1	*2462.00	89.2 AV			1.07 H	227	57.47	31.71
2	2483.50	59.8 PK	74.00	-14.18	1.07 H	227	28.05	31.77
2	2483.50	38.9 AV	54.00	-15.09	1.07 H	227	7.14	31.77
3	2688.00	54.5 PK	80.20	-25.70	1.07 H	227	21.89	32.62
3	2688.00	42.7 AV	79.20	-36.50	1.07 H	227	10.03	32.62
4	4924.00	47.9 PK	74.00	-26.08	1.24 H	220	9.42	38.49
4	4924.00	36.1 AV	54.00	-17.92	1.24 H	220	-2.42	38.49

<b>ANTENNA POLARITY &amp; TEST DISTANCE: VERTICAL AT 3 M</b>								
No.	Freq. (MHz)	Emission Level (dBuV/m)	Limit (dBuV/m)	Margin (dB)	Antenna Height (m)	Table Angle (Degree)	Raw Value (dBuV)	Correction Factor (dB/m)
1	*2462.00	107.2 PK			1.24 V	115	75.52	31.71
1	*2462.00	97.1 AV			1.24 V	115	65.34	31.71
2	2483.50	66.9 PK	74.00	-7.15	1.24 V	115	35.08	31.77
2	2483.50	46.8 AV	54.00	-7.22	1.24 V	115	15.01	31.77
3	2688.00	61.4 PK	87.20	-25.80	1.24 V	115	28.82	32.62
3	2688.00	50.5 AV	77.10	-26.60	1.24 V	115	17.88	32.62
4	4924.00	49.1 PK	74.00	-24.91	1.14 V	220	10.59	38.49
4	4924.00	37.13 AV	54.00	-16.87	1.14 V	220	-1.37	38.49

\*(The test data is in accordance with ADT Report No.: 921011R03A.)

- REMARKS:**
1. Emission level (dBuV/m) = Raw Value (dBuV) + Correction Factor (dB/m).
  2. Correction Factor (dB/m) = Antenna Factor (dB/m) + Cable Factor (dB).
  3. The other emission levels were very low against the limit.
  4. Margin value = Emission level – Limit value.
  5. “ \* “: Fundamental frequency.



### 4.3 6dB BANDWIDTH MEASUREMENT

#### 4.3.1 LIMITS OF 6dB BANDWIDTH MEASUREMENT

The minimum of 6dB Bandwidth Measurement is 0.5 MHz.

#### 4.3.2 TEST INSTRUMENTS

Description & Manufacturer	Model No.	Serial No.	Calibrated Until
R&S SPECTRUM ANALYZER	FSEK30	100049	Aug. 12, 2004

**NOTE:** The calibration interval of the above test instruments is 12 months and the calibrations are traceable to NML/ROC and NIST/USA.



#### 4.3.3 TEST PROCEDURE

The transmitter output was connected to the spectrum analyzer through an attenuator. The bandwidth of the fundamental frequency was measured by spectrum analyzer with 100kHz RBW and 100kHz VBW. The 6dB bandwidth is defined as the total spectrum the power of which is higher than peak power minus 6dB.

#### 4.3.4 DEVIATION FROM TEST STANDARD

No deviation

#### 4.3.5 TEST SETUP



#### 4.3.6 EUT OPERATING CONDITIONS

The software provided by client to enable the EUT under transmission condition continuously at lowest, middle and highest channel frequencies individually.



## 4.3.7 TEST RESULTS

**802.11b DSSS MODULATION**

<b>EUT</b>	2.4GHz Wireless Broadband Router	<b>MODEL</b>	WLG-2207
<b>MODULATION TYPE</b>	CCK	<b>TRANSFER RATE</b>	11Mbps
<b>INPUT POWER (SYSTEM)</b>	120Vac, 60 Hz	<b>ENVIRONMENTAL CONDITIONS</b>	25deg. C, 60%RH, 991hPa
<b>TESTED BY</b>	Jamison Chan		

<b>CHANNEL</b>	<b>CHANNEL FREQUENCY (MHz)</b>	<b>6dB BANDWIDTH (MHz)</b>	<b>MINIMUM LIMIT (MHz)</b>	<b>PASS/FAIL</b>
1	2412	12.60	0.5	PASS
6	2437	11.96	0.5	PASS
11	2462	11.96	0.5	PASS

\*(The test data is in accordance with ADT Report No.: 921011R03A.)



CH1

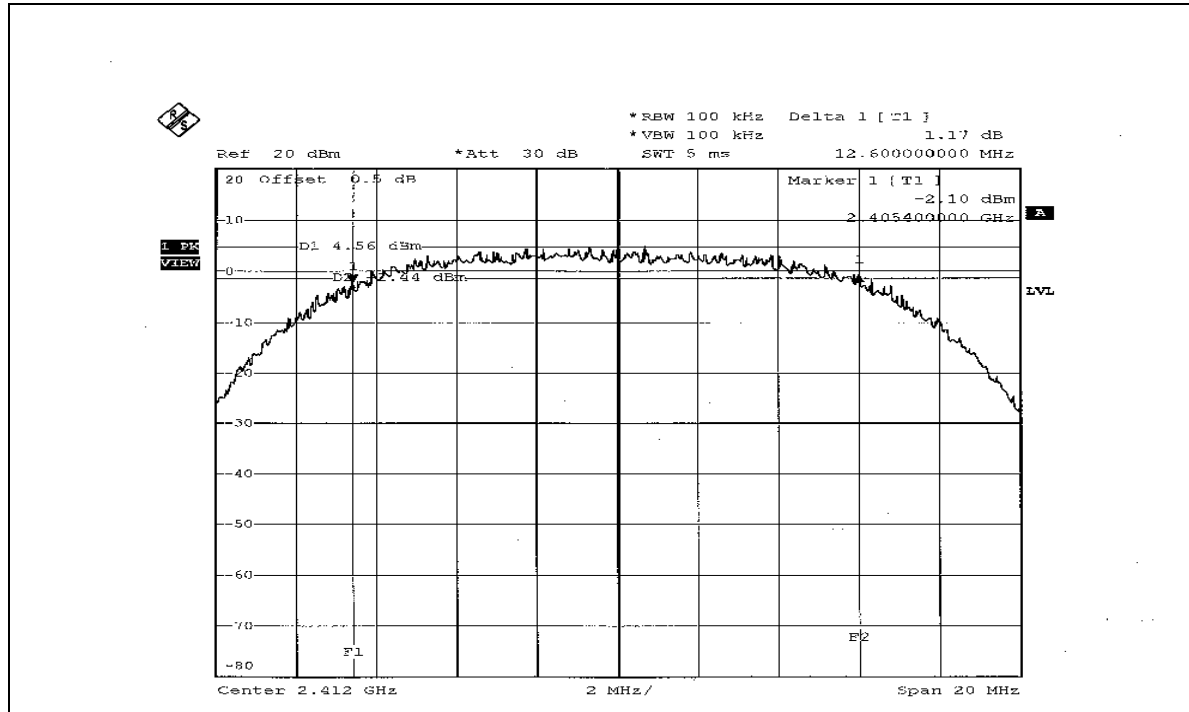

CH6

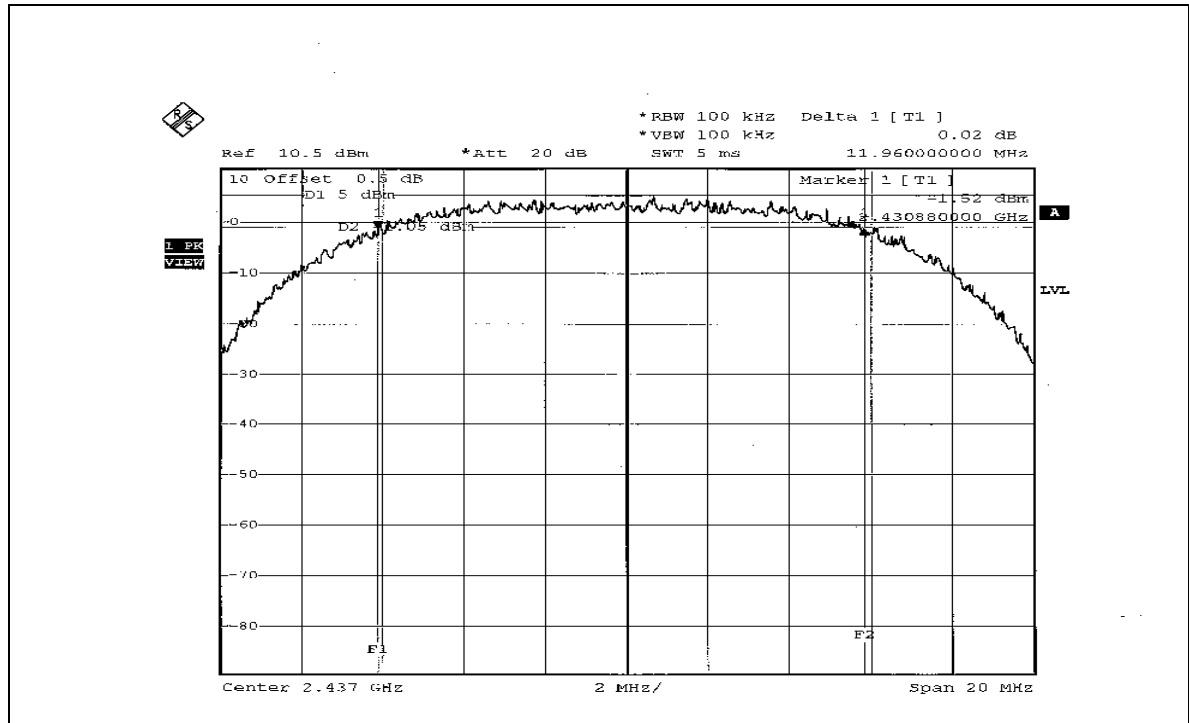



CH11

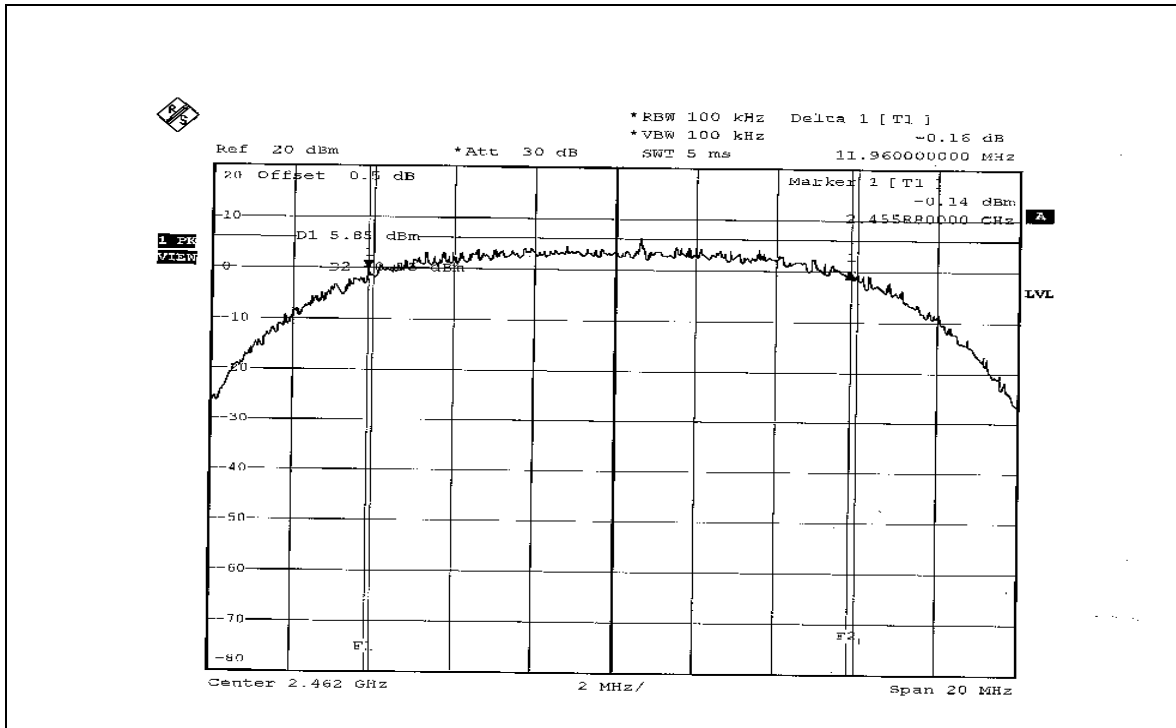

**802.11g OFDM MODULATION**

<b>EUT</b>	2.4GHz Wireless Broadband Router	<b>MODEL</b>	WLG-2207
<b>MODULATION TYPE</b>	BPSK	<b>TRANSFER RATE</b>	6Mbps
<b>INPUT POWER (SYSTEM)</b>	120Vac, 60 Hz	<b>ENVIRONMENTAL CONDITIONS</b>	25deg. C, 60%RH, 991hPa
<b>TESTED BY</b>	Jamison Chan		

<b>CHANNEL</b>	<b>CHANNEL FREQUENCY (MHz)</b>	<b>6dB BANDWIDTH (MHz)</b>	<b>MINIMUM LIMIT (MHz)</b>	<b>PASS/FAIL</b>
1	2412	16.44	0.5	PASS
6	2437	16.48	0.5	PASS
11	2462	16.40	0.5	PASS

\*(The test data is in accordance with ADT Report No.: 921011R03A.)



CH1

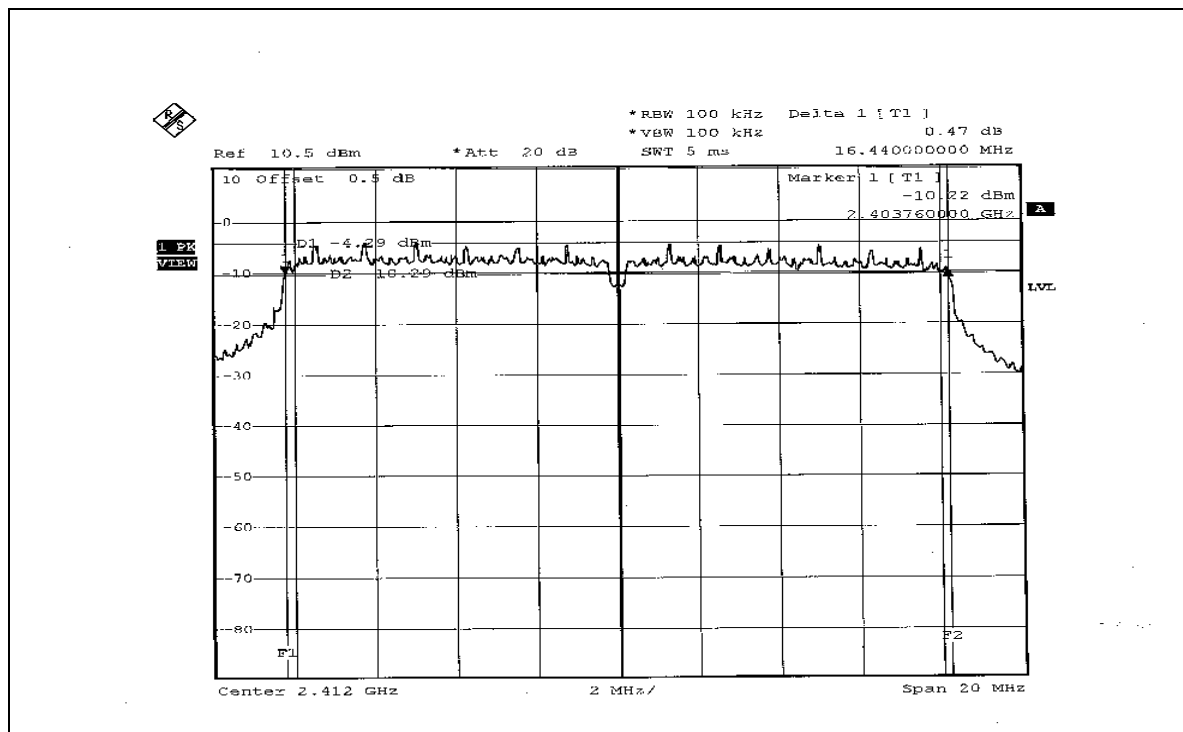

CH6

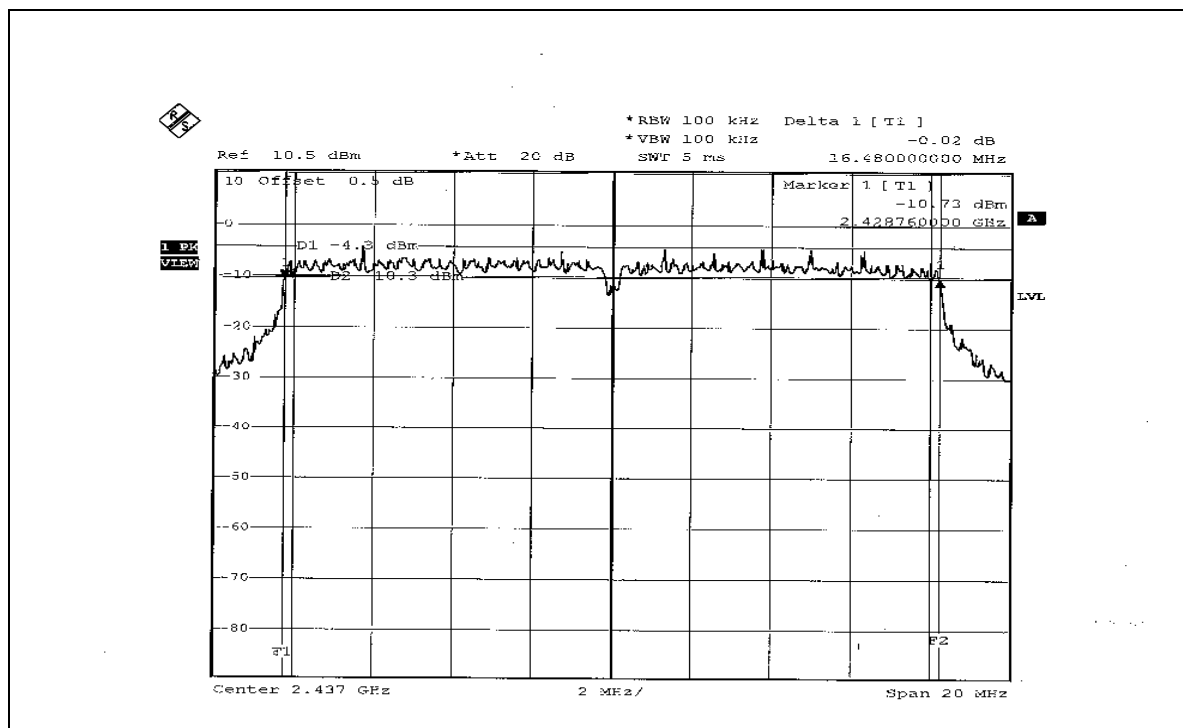



CH11

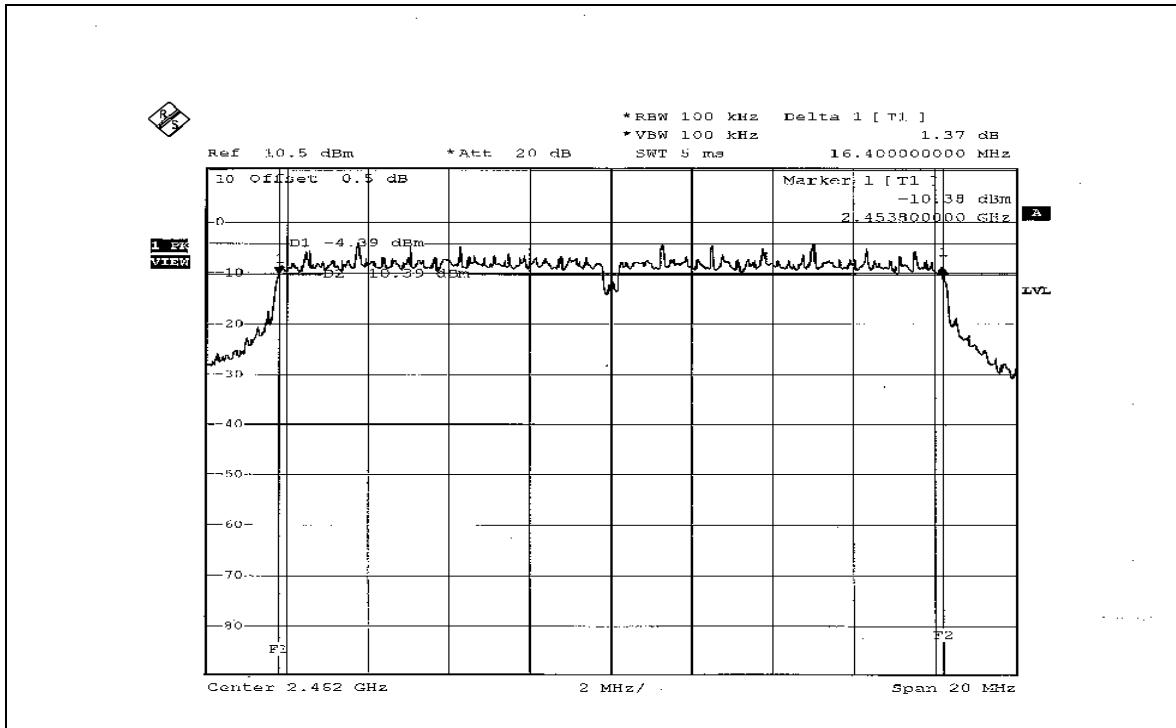



#### 4.4 MAXIMUM PEAK OUTPUT POWER

##### 4.4.1 LIMITS OF MAXIMUM PEAK OUTPUT POWER MEASUREMENT

The Maximum Peak Output Power Measurement is 30dBm.

##### 4.4.2 INSTRUMENTS

Description & Manufacturer	Model No.	Serial No.	Calibrated Until
R&S SPECTRUM ANALYZER	FSEK30	100049	Aug. 12, 2004
R&S SIGNAL GENERATOR	SMP04	100011	May 28, 2004
TEKTRONIX OSCILLOSCOPE	TDS 220	B048470	Mar. 05, 2004
NARDA DETECTOR	4503A	FSCM99899	NA

**NOTE:** The calibration interval of the above test instruments is 12 months and the calibrations are traceable to NML/ROC and NIST/USA..





#### 4.4.3 TEST PROCEDURES

1. A detector was used on the output port of the EUT. An oscilloscope was used to read the response of the detector.
2. Replaced the EUT by the signal generator. The center frequency of the S.G was adjusted to the center frequency of the measured channel.
3. Adjusted the power to have the same reading on oscilloscope. Record the power level.

#### 4.4.4 DEVIATION FROM TEST STANDARD

No deviation

#### 4.4.5 TEST SETUP



#### 4.4.6 EUT OPERATING CONDITIONS

Same as Item 4.3.6

## 4.4.7 TEST RESULTS

## 802.11b DSSS MODULATION

<b>EUT</b>	2.4GHz Wireless Broadband Router	<b>MODEL</b>	WLG-2207
<b>MODULATION TYPE</b>	CCK	<b>TRANSFER RATE</b>	11Mbps
<b>INPUT POWER (SYSTEM)</b>	120Vac, 60 Hz	<b>ENVIRONMENTAL CONDITIONS</b>	25deg. C, 60%RH, 991hPa
<b>TESTED BY</b>	Jamison Chan		

CHANNEL	CHANNEL FREQUENCY (MHz)	PEAK POWER OUTPUT (mW)	PEAK POWER OUTPUT (dBm)	PEAK POWER LIMIT (dBm)	PASS/FAIL
1	2412	51.761	17.14	30	PASS
6	2437	50.119	17.00	30	PASS
11	2462	51.050	17.08	30	PASS

\*(The test data is in accordance with ADT Report No.: 921011R03A.)

## 802.11g OFDM MODULATION

<b>EUT</b>	2.4GHz Wireless Broadband Router	<b>MODEL</b>	WLG-2207
<b>MODULATION TYPE</b>	BPSK	<b>TRANSFER RATE</b>	6Mbps
<b>INPUT POWER (SYSTEM)</b>	120Vac, 60 Hz	<b>ENVIRONMENTAL CONDITIONS</b>	25deg. C, 60%RH, 991hPa
<b>TESTED BY</b>	Jamison Chan		

CHANNEL	CHANNEL FREQUENCY (MHz)	PEAK POWER OUTPUT (mW)	PEAK POWER OUTPUT (dBm)	PEAK POWER LIMIT (dBm)	PASS/FAIL
1	2412	51.523	17.12	30	PASS
6	2437	50.582	17.04	30	PASS
11	2462	50.350	17.02	30	PASS

\*(The test data is in accordance with ADT Report No.: 921011R03A.)



## 4.5 POWER SPECTRAL DENSITY MEASUREMENT

### 4.5.1 LIMITS OF POWER SPECTRAL DENSITY MEASUREMENT

The Maximum of Power Spectral Density Measurement is 8dBm.

### 4.5.2 TEST INSTRUMENTS

Description & Manufacturer	Model No.	Serial No.	Calibrated Until
R&S SPECTRUM ANALYZER	FSEK30	100049	Aug. 12, 2004

**NOTE:** The calibration interval of the above test instruments is 12 months and the calibrations are traceable to NML/ROC and NIST/USA.

#### 4.5.3 TEST PROCEDURE

The transmitter output was connected to the spectrum analyzer through an attenuator, the bandwidth of the fundamental frequency was measured with the spectrum analyzer using 3kHz RBW and 30kHz VBW, set sweep time = span/3kHz. The power spectral density was measured and recorded.

The sweep time is allowed to be longer than span/3kHz for a full response of the mixer in the spectrum analyzer.

#### 4.5.4 DEVIATION FROM TEST STANDARD

No deviation

#### 4.5.5 TEST SETUP

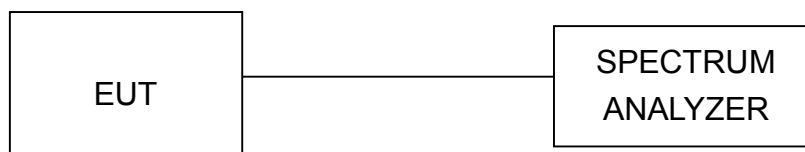

#### 4.5.6 EUT OPERATING CONDITION

Same as Item 4.3.6



## 4.5.7 TEST RESULTS

### 802.11b DSSS MODULATION

<b>EUT</b>	2.4GHz Wireless Broadband Router	<b>MODEL</b>	WLG-2207
<b>MODULATION TYPE</b>	CCK	<b>TRANSFER RATE</b>	11Mbps
<b>INPUT POWER (SYSTEM)</b>	120Vac, 60 Hz	<b>ENVIRONMENTAL CONDITIONS</b>	25deg. C, 60%RH, 991hPa
<b>TESTED BY</b>	Jamison Chan		

CHANNEL	CHANNEL FREQUENCY (MHz )	RF POWER LEVEL IN 3kHz BW (dBm)	MAXIMUM LIMIT (dBm)	PASS/FAIL
1	2412	-5.65	8	PASS
6	2437	-7.01	8	PASS
11	2462	-4.63	8	PASS

\*(The test data is in accordance with ADT Report No.: 921011R03A.)



CH1

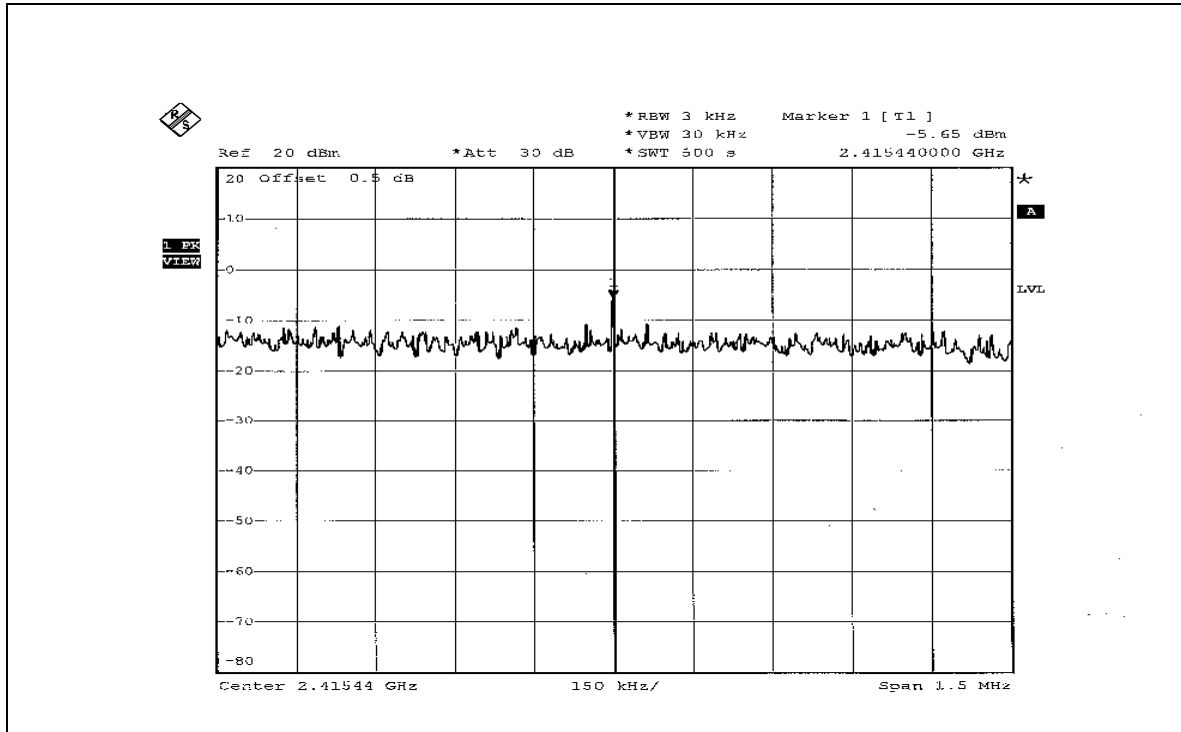

CH6

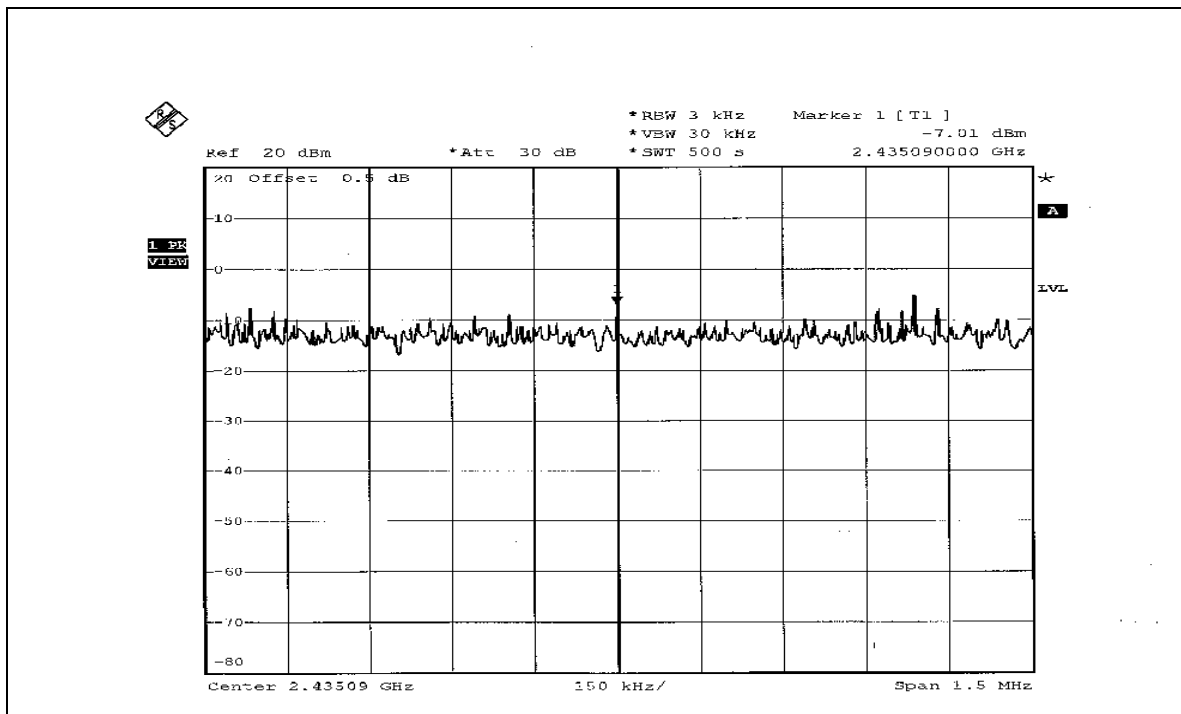



CH11

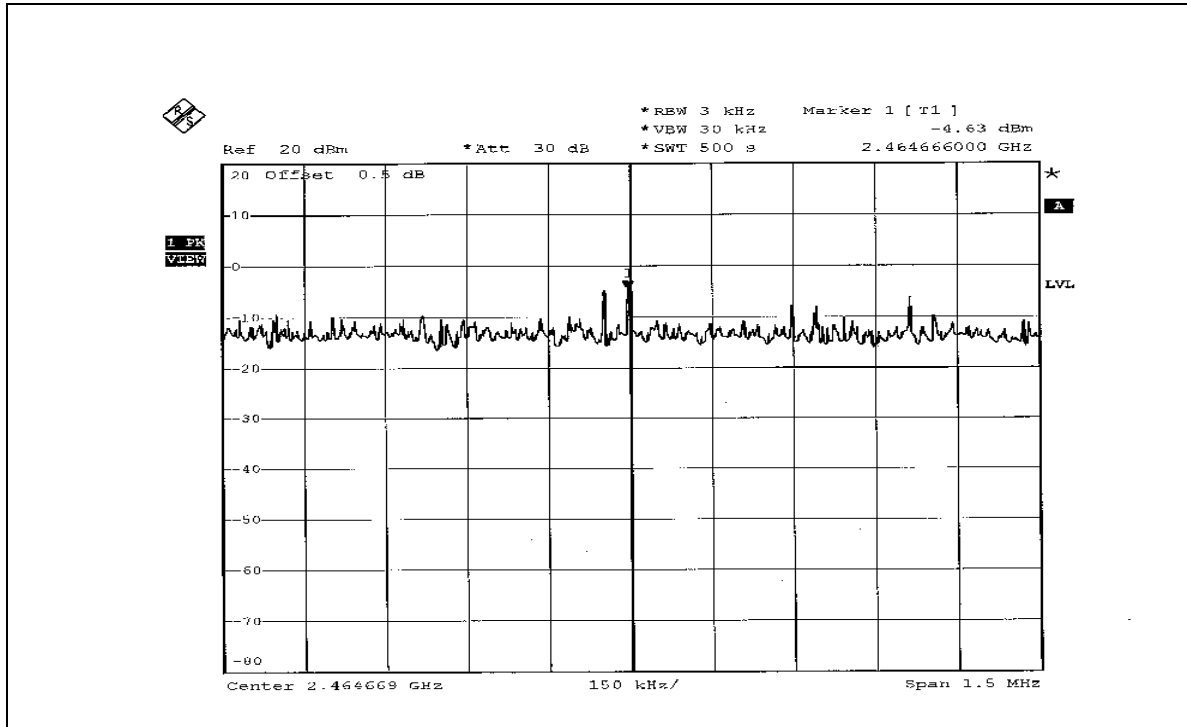



### 802.11g OFDM MODULATION

<b>EUT</b>	2.4GHz Wireless Broadband Router	<b>MODEL</b>	WLG-2207
<b>MODULATION TYPE</b>	BPSK	<b>TRANSFER RATE</b>	6Mbps
<b>INPUT POWER (SYSTEM)</b>	120Vac, 60 Hz	<b>ENVIRONMENTAL CONDITIONS</b>	25deg. C, 60%RH, 991hPa
<b>TESTED BY</b>	Jamison Chan		

CHANNEL	CHANNEL FREQUENCY (MHz )	RF POWER LEVEL IN 3kHz BW (dBm)	MAXIMUM LIMIT (dBm)	PASS/FAIL
1	2412	-18.43	8	PASS
6	2437	-17.28	8	PASS
11	2462	-18.76	8	PASS

\*(The test data is in accordance with ADT Report No.: 921011R03A.)





CH1

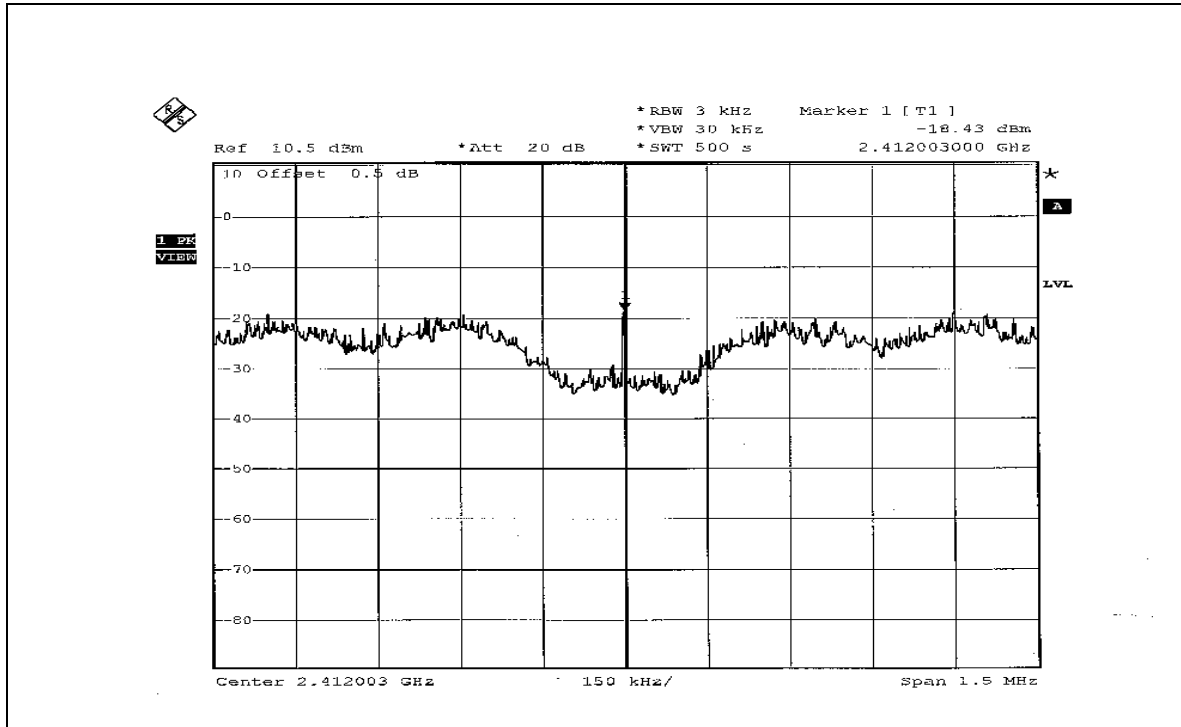

CH6

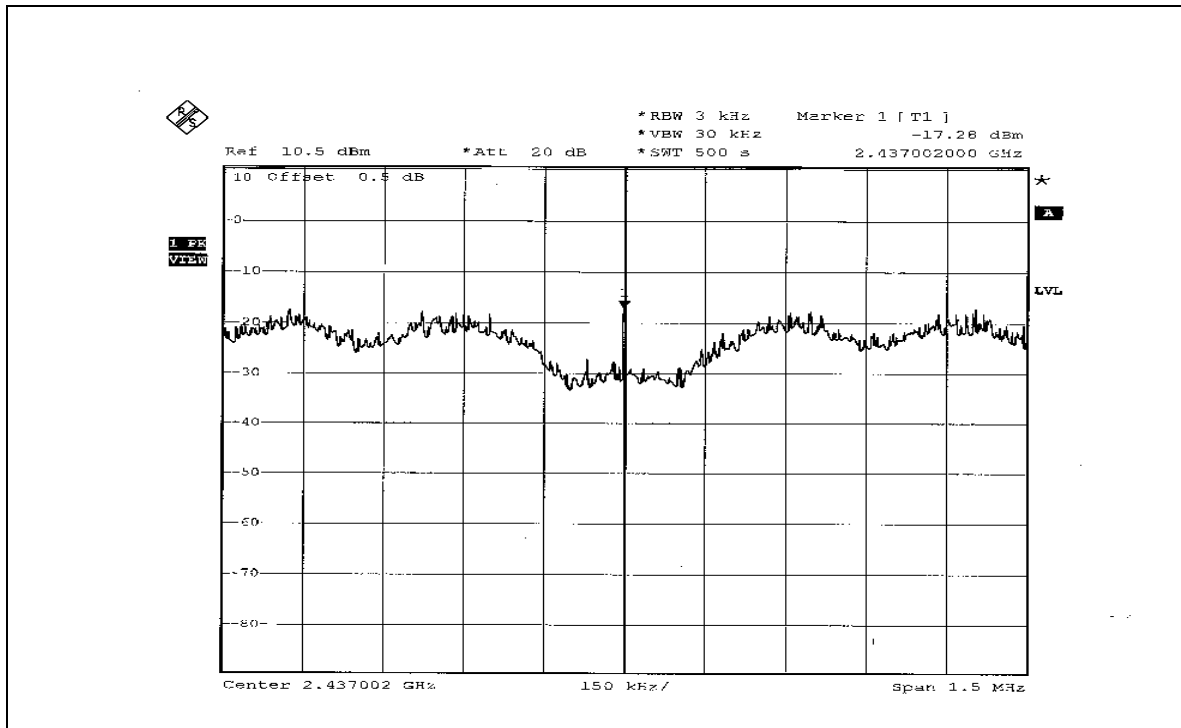



CH11

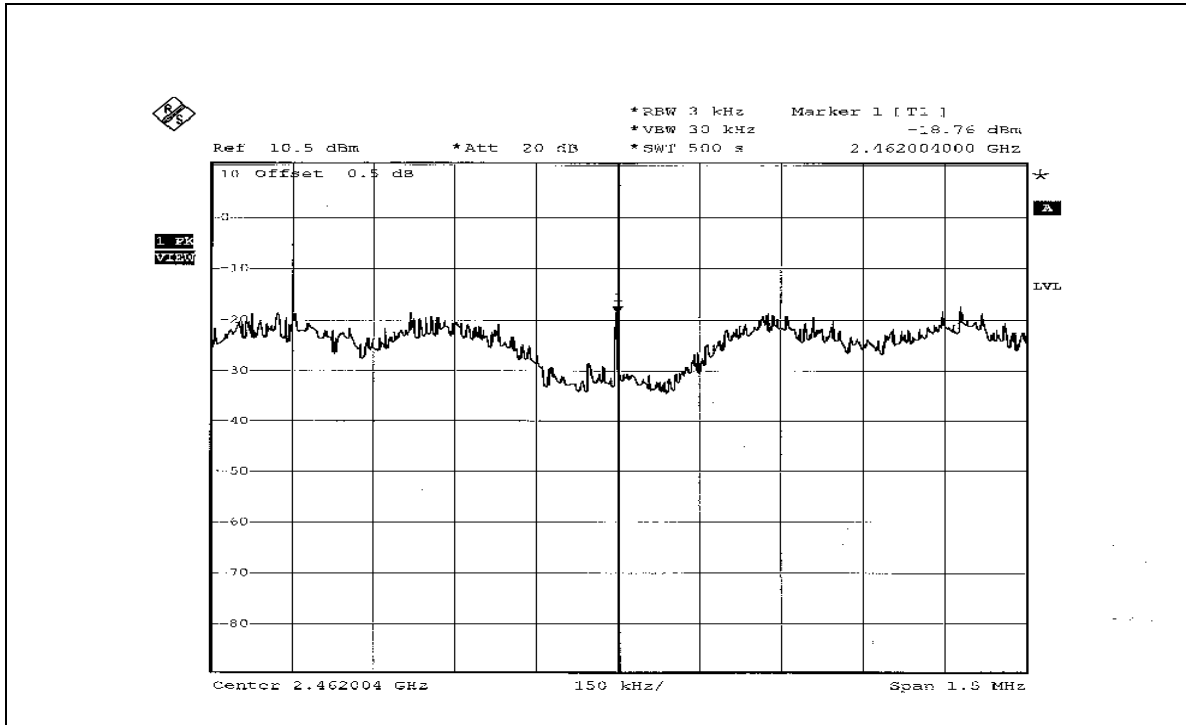



## 4.6 BAND EDGES MEASUREMENT

### 4.6.1 LIMITS OF BAND EDGES MEASUREMENT

Below  $-20\text{dB}$  of the highest emission level of operating band (in 100kHz Resolution Bandwidth).

### 4.6.2 TEST INSTRUMENTS

Description & Manufacturer	Model No.	Serial No.	Calibrated Until
R&S SPECTRUM ANALYZER	FSEK30	100049	Aug. 12, 2004

**NOTE:** The calibration interval of the above test instruments is 12 months and the calibrations are traceable to NML/ROC and NIST/USA.

### 4.6.3 TEST PROCEDURE

The transmitter output was connected to the spectrum analyzer via a low lose cable. Set both RBW and VBW of spectrum analyzer to 100 kHz and 100 kHz with suitable frequency span including 100 MHz bandwidth from band edge. The band edges was measured and recorded.

The spectrum plots (Peak RBW=VBW=100kHz; Average RBW=1MHz, VBW=300Hz) are attached on the following pages.

### 4.6.4 DEVIATION FROM TEST STANDARD

No deviation

### 4.6.5 EUT OPERATING CONDITION

Same as Item 4.3.6



#### 4.6.6 TEST RESULTS

The spectrum plots are attached on the following 12 images. D1 line indicates the highest level, and D2 line indicates the 20dB offset below D1. It shows compliance with the requirement in part 15.247(d).

#### 802.11b DSSS MODULATION

**NOTE 1:** The band edge emission plot on page 53 show 41.70dBc delta between carrier maximum power and local maximum emission in restrict band (2.3998GHz). The emission of carrier strength list in the test result of channel 1 at the item 4.2.7 is 112.90dBuV/m (Peak), so the maximum field strength in restrict band is  $112.90 - 41.70 = 71.20$ dBuV/m, which is under 74dBuV/m limit.

The band edge emission plot on page 53 show 57.87dBc delta between carrier maximum power and local maximum emission in restrict band (2.3900GHz). The emission of carrier strength list in the test result of channel 1 at the item 4.2.7 is 106.20dBuV/m (Average), so the maximum field strength in restrict band is  $106.20 - 57.87 = 48.33$ dBuV/m, which is under 54dBuV/m limit.

**NOTE 2:** The band edge emission plot on the page 54 show 50.87dBc delta between carrier maximum power and local maximum emission in restrict band (2.4849GHz). The emission of carrier strength list in the test result of channel 11 at the item 4.2.7 is 112.80dBuV/m (Peak), so the maximum field strength in restrict band is  $112.80 - 50.87 = 61.93$ dBuV/m, which is under 74dBuV/m limit.

The band edge emission plot on the page 55 show 58.93dBc delta between carrier maximum power and local maximum emission in restrict band (2.4835GHz). The emission of carrier strength list in the test result of channel 11 at the item 4.2.7 is 106.20dBuV/m (Average), so the maximum field strength in restrict band is  $106.20 - 58.93 = 47.27$ dBuV/m, which is under 54dBuV/m limit.

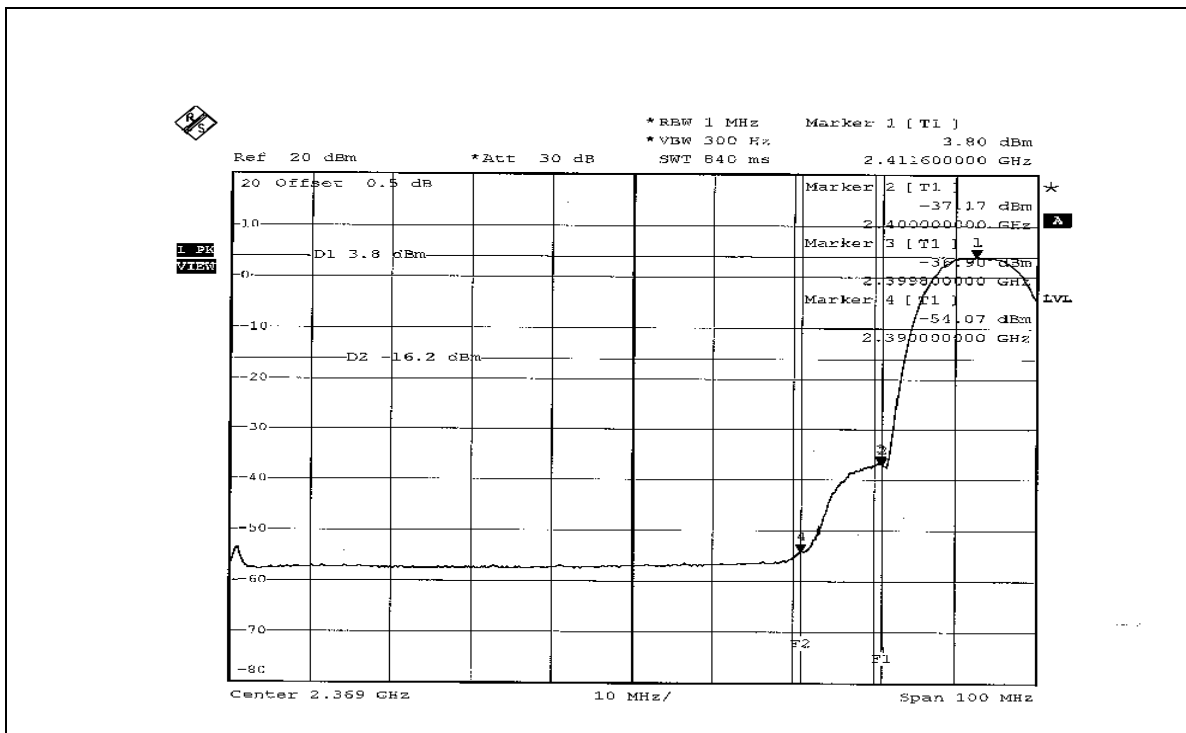
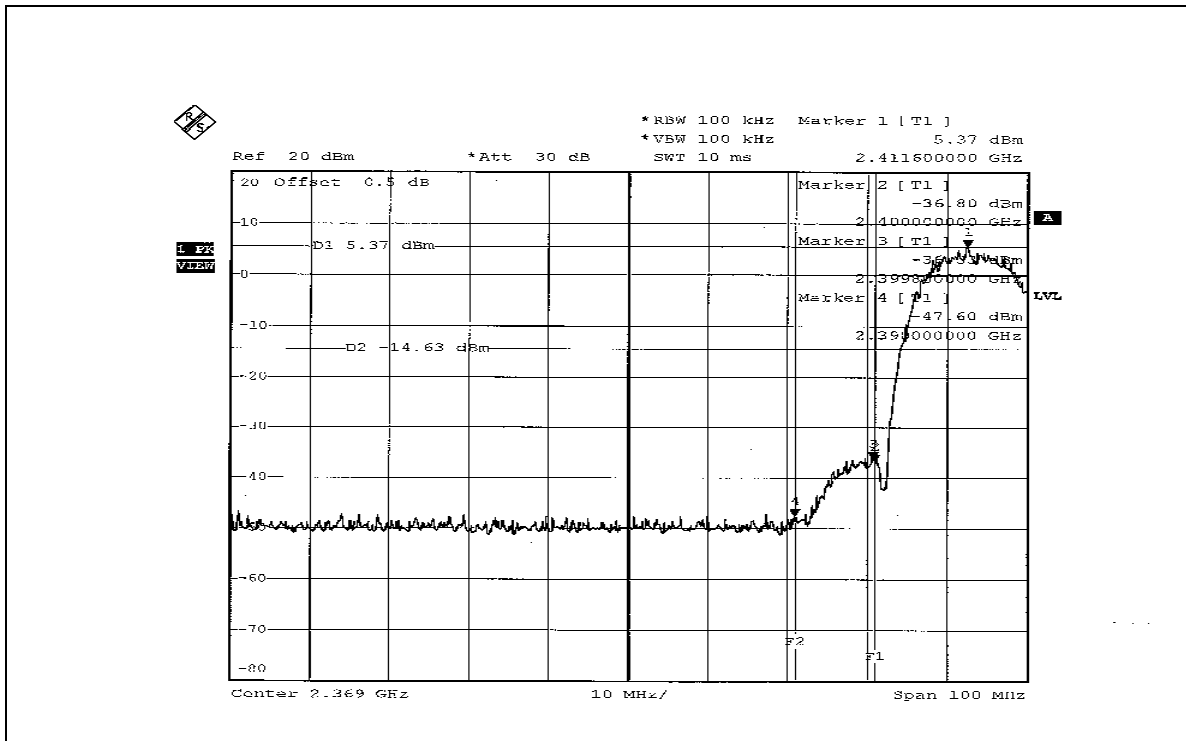

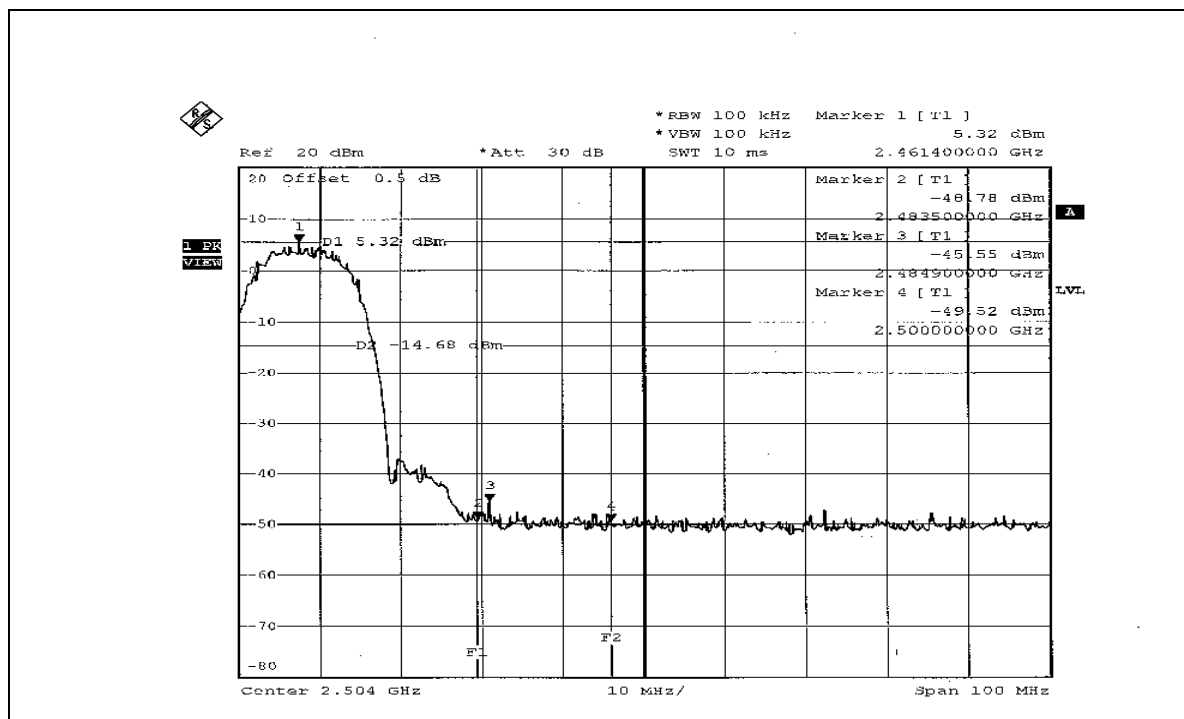
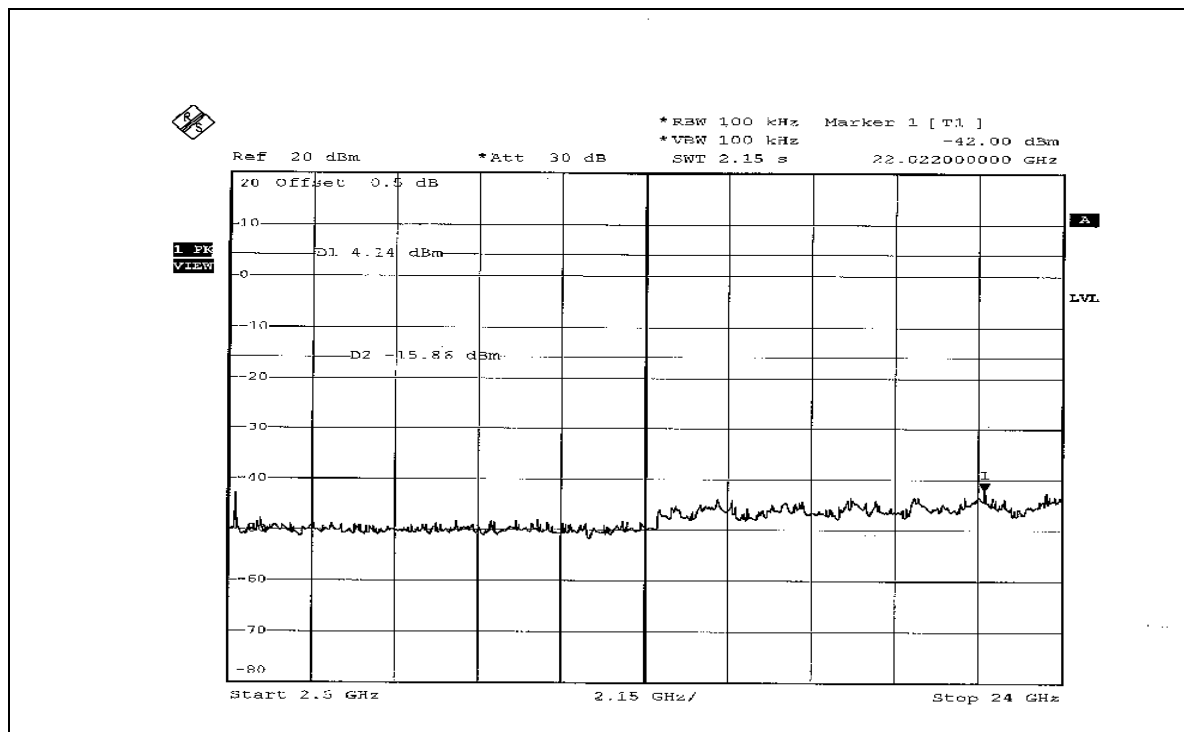

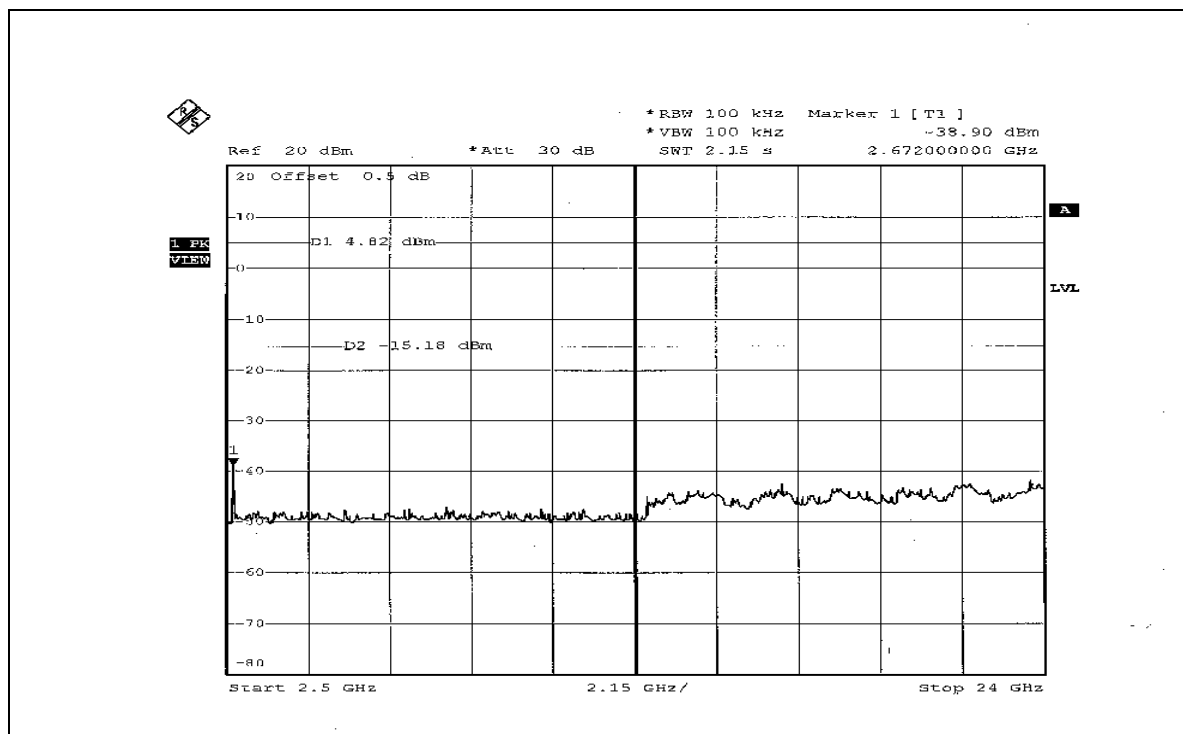
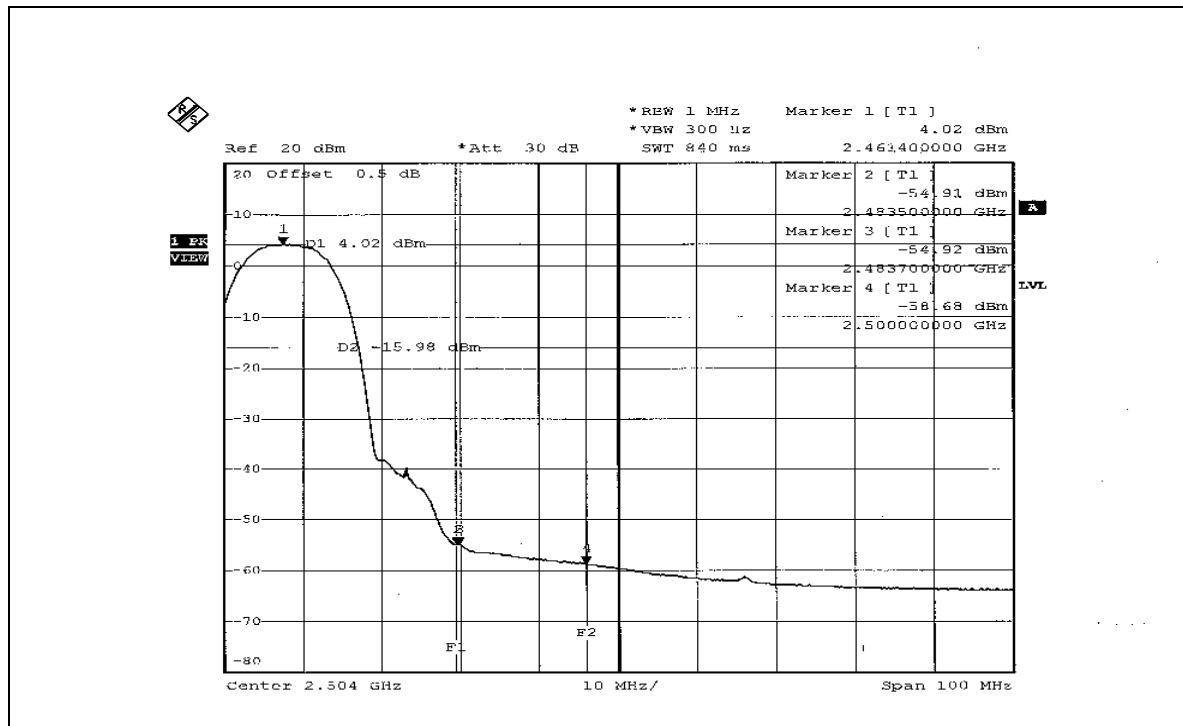



## 802.11g OFDM MODULATION

**NOTE 1:** The band edge emission plot on page 57 show 50.10dBc delta between carrier maximum power and local maximum emission in restrict band (2.3900GHz). The emission of carrier strength list in the test result of channel 1 at the item 4.2.7 is 106.10dBuV/m (Peak), so the maximum field strength in restrict band is  $106.10 - 50.10 = 56.00$ dBuV/m, which is under 74dBuV/m limit.

The band edge emission plot on page 57 show 49.38dBc delta between carrier maximum power and local maximum emission in restrict band (2.3900GHz). The emission of carrier strength list in the test result of channel 1 at the item 4.2.7 is 96.50dBuV/m (Average), so the maximum field strength in restrict band is  $96.50 - 49.38 = 47.12$ dBuV/m, which is under 54dBuV/m limit.

**NOTE 2:** The band edge emission plot on the page 58 show 48.86dBc delta between carrier maximum power and local maximum emission in restrict band (2.4837GHz). The emission of carrier strength list in the test result of channel 11 at the item 4.2.7 is 107.20dBuV/m (Peak), so the maximum field strength in restrict band is  $107.20 - 48.86 = 58.34$ dBuV/m, which is under 74dBuV/m limit.

The band edge emission plot on the page 59 show 51.21dBc delta between carrier maximum power and local maximum emission in restrict band (2.4835GHz). The emission of carrier strength list in the test result of channel 11 at the item 4.2.7 is 97.10dBuV/m (Average), so the maximum field strength in restrict band is  $97.10 - 51.21 = 45.89$ dBuV/m, which is under 54dBuV/m limit.



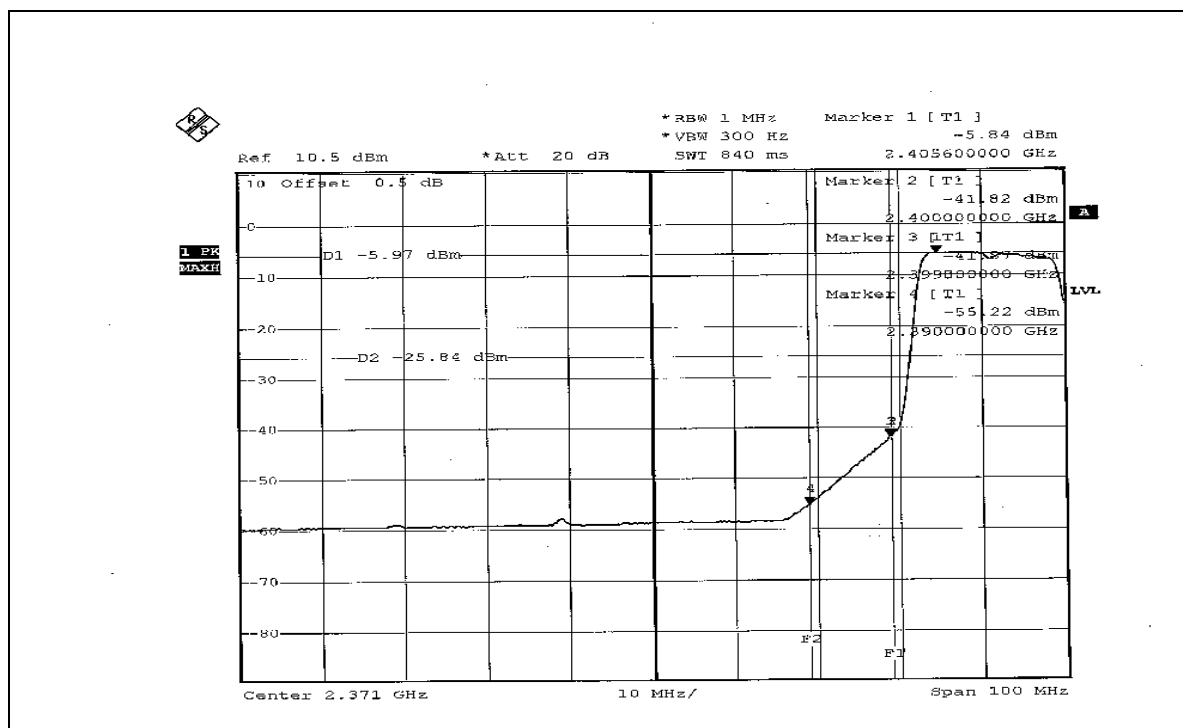
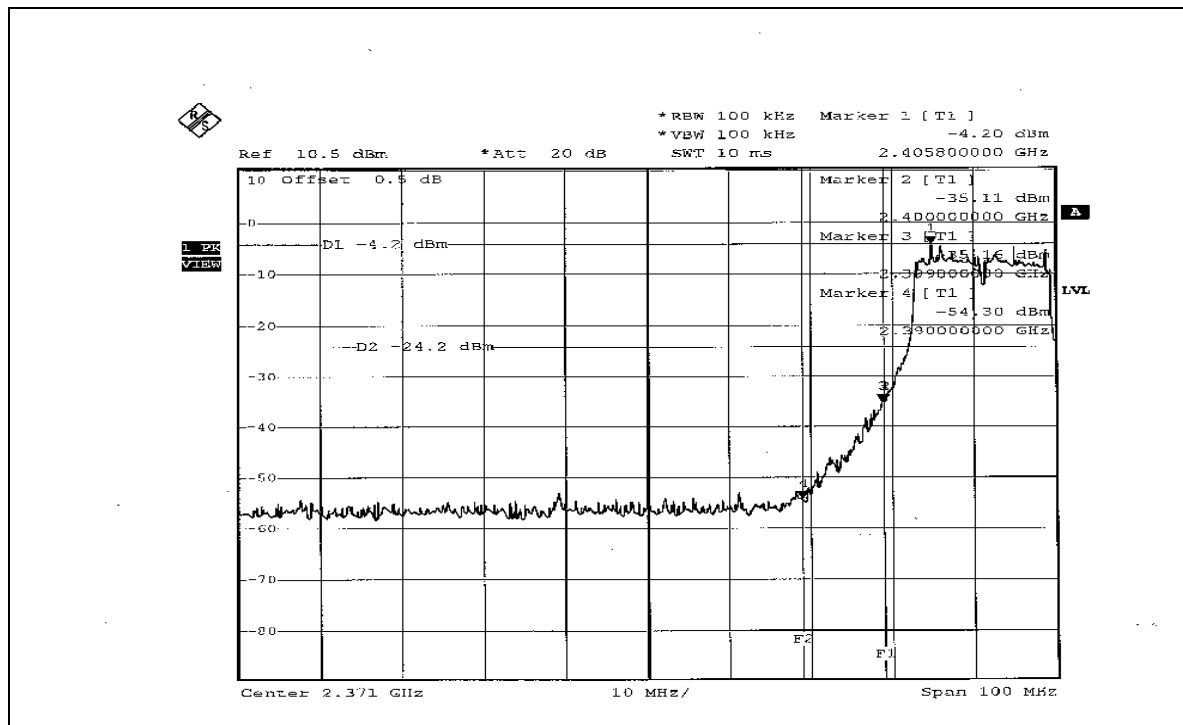

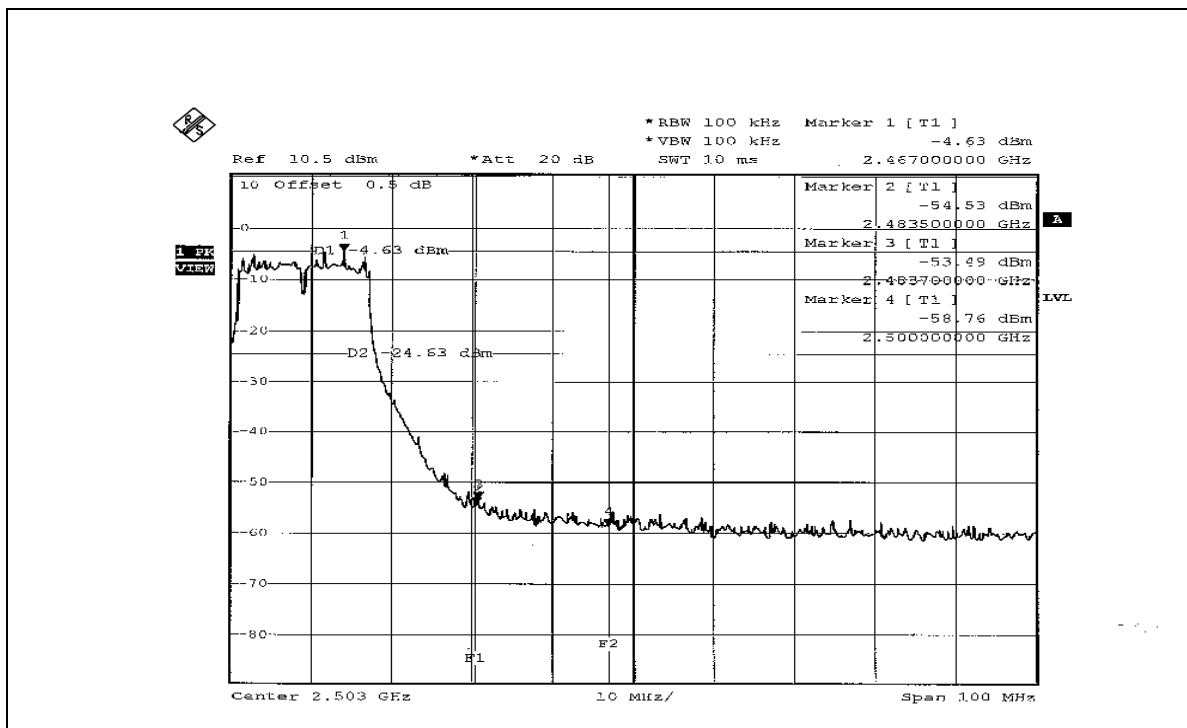
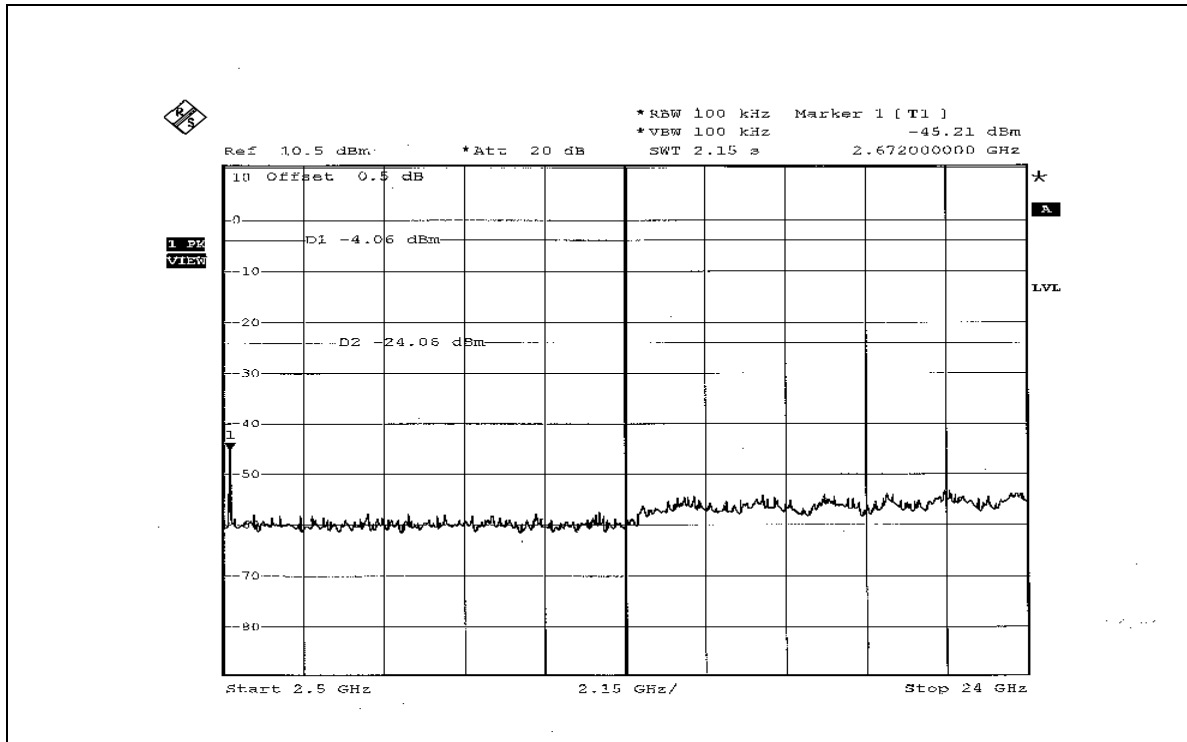

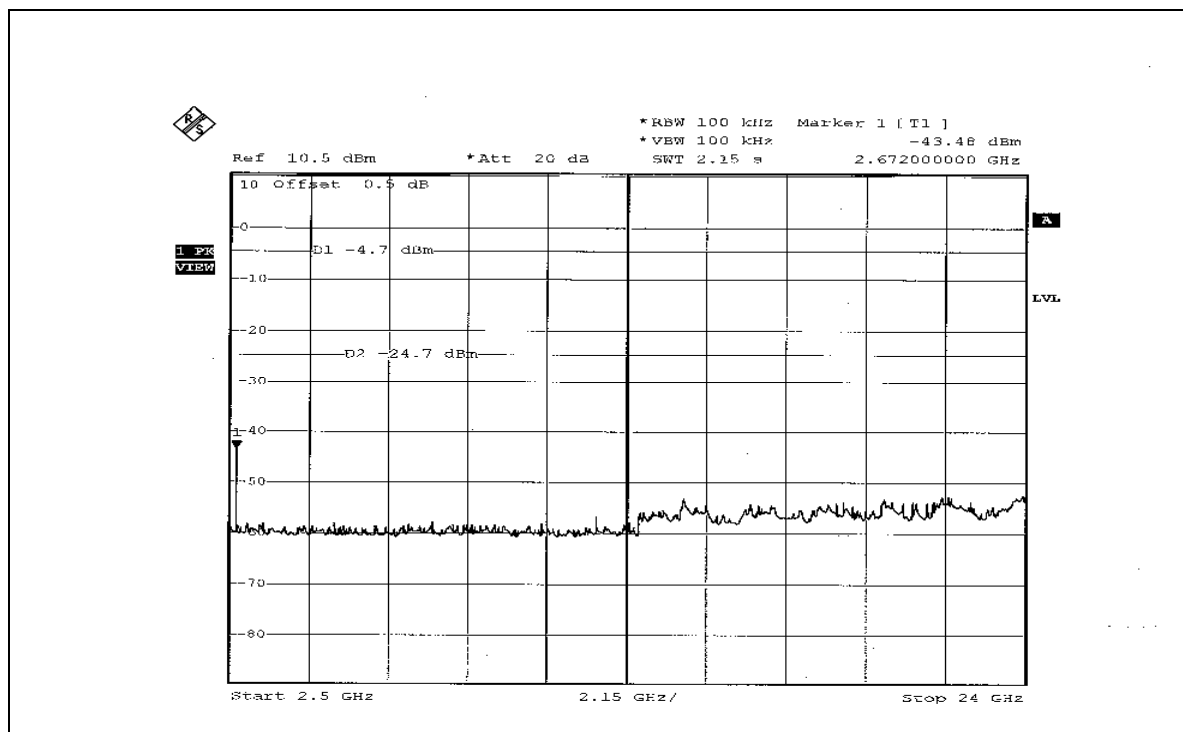
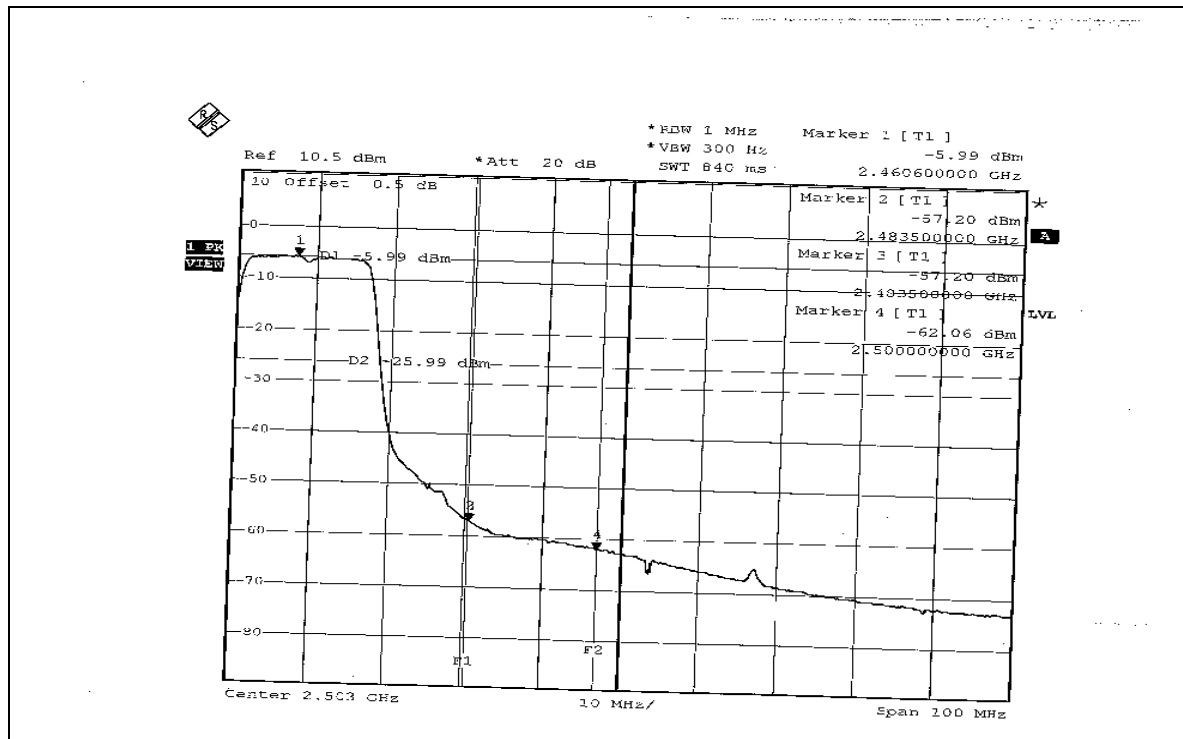



## **4.7 ANTENNA REQUIREMENT**

### **4.7.1 STANDARD APPLICABLE**

For intentional device, according to FCC 47 CFR Section 15.203, an intentional radiator shall be designed to ensure that no antenna other than that furnished by the responsible party shall be used with the device. And according to FCC 47 CFR Section 15.247 (b), if transmitting antennas of directional gain greater than 6dBi are used, the power shall be reduced by the amount in dB that the directional gain of the antenna exceeds 6dBi.

### **4.7.2 ANTENNA CONNECTED CONSTRUCTION**

The antenna used in this product is Dipole antenna with Reversed SMA antenna connector. The maximum Gain of the antenna is 2.0dBi.

## 5. PHOTOGRAPHS OF THE TEST CONFIGURATION

### CONDUCTED EMISSION TEST



### RADIATED EMISSION TEST





## 6. INFORMATION ON THE TESTING LABORATORIES

We, ADT Corp., were founded in 1988 to provide our best service in EMC, Radio, Telecom and Safety consultation. Our laboratories are accredited and approved by the following approval agencies according to ISO/IEC 17025.

<b>USA</b>	FCC, NVLAP, UL, A2LA
<b>Germany</b>	TUV Rheinland
<b>Japan</b>	VCCI
<b>Norway</b>	NEMKO
<b>Canada</b>	INDUSTRY CANADA , CSA
<b>R.O.C.</b>	CNLA, BSMI, DGT
<b>Netherlands</b>	Telefication
<b>Singapore</b>	PSB , GOST-ASIA(MOU)
<b>Russia</b>	CERTIS(MOU)

Copies of accreditation certificates of our laboratories obtained from approval agencies can be downloaded from our web site:

[www.adt.com.tw/index.5/phtml](http://www.adt.com.tw/index.5/phtml). If you have any comments, please feel free to contact us at the following:

**Linko EMC/RF Lab:**  
Tel: 886-2-26052180  
Fax: 886-2-26052943

**Hsin Chu EMC/RF Lab:**  
Tel: 886-3-5935343  
Fax: 886-3-5935342

**Hwa Ya EMC/RF/Safety Telecom Lab:**  
Tel: 886-3-3183232  
Fax: 886-3-3185050

**Linko RF Lab.**  
Tel: 886-3-3270910  
Fax: 886-3-3270892

**Web Site:** [www.adt.com.tw](http://www.adt.com.tw)

The address and road map of all our labs can be found in our web site also